

Oracle® Database

Security Guide



23ai
F46690-20
February 2025

The Oracle logo, consisting of a solid red square with the word "ORACLE" in white, uppercase, sans-serif font centered within it.

ORACLE®

Contributors: Suraj Adhikari, Tammy Bednar, Ji-Won Byun, Yuechen Chen, Nishant Chaudhary, Rajnish Chitkara, Chi Ching Chui, Angeline Dhanarani, Naveen Gopal, Rishabh Gupta, Yong Hu, Dana Joly, Srinidhi Kayoor, Peter Knaggs, Imran M. Khan, Sanjay Kulhari, Anup A. Kumar, Scott McKinley, Misaki Miyashita, Hari Mohankumar, Gopal Mulagund, Abhishek Munnolimath, Marudha Sudharshan R, Kumar Rajamani, Vipin Samar, Saravana Soundararajan, Ankit Srivastava, Siu Tam, Luna Tan, Ruchi Tayal, Kamal Tbeileh, Rohit Thatte, Can Tuzla, Anand Verma, Alan Williams, Peter Wahl, Jinglei Xie, Deepak Yadav, Quan Yang

This software and related documentation are provided under a license agreement containing restrictions on use and disclosure and are protected by intellectual property laws. Except as expressly permitted in your license agreement or allowed by law, you may not use, copy, reproduce, translate, broadcast, modify, license, transmit, distribute, exhibit, perform, publish, or display any part, in any form, or by any means. Reverse engineering, disassembly, or decompilation of this software, unless required by law for interoperability, is prohibited.

The information contained herein is subject to change without notice and is not warranted to be error-free. If you find any errors, please report them to us in writing.

If this is software, software documentation, data (as defined in the Federal Acquisition Regulation), or related documentation that is delivered to the U.S. Government or anyone licensing it on behalf of the U.S. Government, then the following notice is applicable:

U.S. GOVERNMENT END USERS: Oracle programs (including any operating system, integrated software, any programs embedded, installed, or activated on delivered hardware, and modifications of such programs) and Oracle computer documentation or other Oracle data delivered to or accessed by U.S. Government end users are "commercial computer software," "commercial computer software documentation," or "limited rights data" pursuant to the applicable Federal Acquisition Regulation and agency-specific supplemental regulations. As such, the use, reproduction, duplication, release, display, disclosure, modification, preparation of derivative works, and/or adaptation of i) Oracle programs (including any operating system, integrated software, any programs embedded, installed, or activated on delivered hardware, and modifications of such programs), ii) Oracle computer documentation and/or iii) other Oracle data, is subject to the rights and limitations specified in the license contained in the applicable contract. The terms governing the U.S. Government's use of Oracle cloud services are defined by the applicable contract for such services. No other rights are granted to the U.S. Government.

This software or hardware is developed for general use in a variety of information management applications. It is not developed or intended for use in any inherently dangerous applications, including applications that may create a risk of personal injury. If you use this software or hardware in dangerous applications, then you shall be responsible to take all appropriate fail-safe, backup, redundancy, and other measures to ensure its safe use. Oracle Corporation and its affiliates disclaim any liability for any damages caused by use of this software or hardware in dangerous applications.

Oracle®, Java, MySQL, and NetSuite are registered trademarks of Oracle and/or its affiliates. Other names may be trademarks of their respective owners.

Intel and Intel Inside are trademarks or registered trademarks of Intel Corporation. All SPARC trademarks are used under license and are trademarks or registered trademarks of SPARC International, Inc. AMD, Epyc, and the AMD logo are trademarks or registered trademarks of Advanced Micro Devices. UNIX is a registered trademark of The Open Group.

This software or hardware and documentation may provide access to or information about content, products, and services from third parties. Oracle Corporation and its affiliates are not responsible for and expressly disclaim all warranties of any kind with respect to third-party content, products, and services unless otherwise set forth in an applicable agreement between you and Oracle. Oracle Corporation and its affiliates will not be responsible for any loss, costs, or damages incurred due to your access to or use of third-party content, products, or services, except as set forth in an applicable agreement between you and Oracle.

Contents

Preface

Audience	I
Documentation Accessibility	I
Diversity and Inclusion	li
Related Documents	li
Conventions	lii

Changes in This Release for Oracle Database Security Guide

Changes in Oracle Database Security 23ai	liii
Updates to Oracle Database Security 23ai	lxiv

1 Introduction to Oracle Database Security

1.1 About Oracle Database Security	1-1
1.2 Additional Oracle Database Security Products	1-3

Part I Managing User Authentication and Authorization

2 Managing Security for Oracle Database Users

2.1 About User Security	2-1
2.2 Creating User Accounts	2-2
2.2.1 About Common Users and Local Users	2-2
2.2.1.1 About Common Users	2-3
2.2.1.2 How Plugging in PDBs Affects CDB Common Users	2-4
2.2.1.3 About Local Users	2-5
2.2.2 Who Can Create User Accounts?	2-6
2.2.3 Creating a New User Account That Has Minimum Database Privileges	2-6
2.2.4 Restrictions on Creating the User Name for a New Account	2-7
2.2.4.1 Uniqueness of User Names	2-8
2.2.4.2 User Names in a Multitenant Environment	2-8
2.2.4.3 Case Sensitivity for User Names	2-8

2.2.5	Assignment of User Passwords	2-9
2.2.6	Default Tablespace for the User	2-9
2.2.6.1	About Assigning a Default Tablespace for a User	2-9
2.2.6.2	DEFAULT TABLESPACE Clause for Assigning a Default Tablespace	2-10
2.2.7	Tablespace Quotas for a User	2-10
2.2.7.1	About Assigning a Tablespace Quota for a User	2-11
2.2.7.2	CREATE USER Statement for Assigning a Tablespace Quota	2-11
2.2.7.3	Restriction of the Quota Limits for User Objects in a Tablespace	2-11
2.2.7.4	Grants to Users for the UNLIMITED TABLESPACE System Privilege	2-12
2.2.8	Temporary Tablespaces for the User	2-12
2.2.8.1	About Assigning a Temporary Tablespace for a User	2-12
2.2.8.2	TEMPORARY TABLESPACE Clause for Assigning a Temporary Tablespace	2-13
2.2.9	Profiles for the User	2-13
2.2.10	Creation of a Common User or a Local User	2-14
2.2.10.1	About Creating Common User Accounts	2-14
2.2.10.2	CREATE USER Statement for Creating a Common User Account	2-15
2.2.10.3	About Creating Local User Accounts	2-16
2.2.10.4	CREATE USER Statement for Creating a Local User Account	2-17
2.2.11	Creating a Default Role for the User	2-17
2.3	Altering User Accounts	2-18
2.3.1	About Altering User Accounts	2-18
2.3.2	Methods of Altering Common or Local User Accounts	2-18
2.3.3	Changing Non-SYS User Passwords	2-19
2.3.3.1	About Changing Non-SYS User Passwords	2-19
2.3.3.2	Using the PASSWORD Command or ALTER USER Statement to Change a Password	2-20
2.3.4	Changing the SYS User Password	2-20
2.3.4.1	About Changing the SYS User Password	2-21
2.3.4.2	ORAPWD Utility for Changing the SYS User Password	2-22
2.4	Configuring User Resource Limits	2-22
2.4.1	About User Resource Limits	2-23
2.4.2	Types of System Resources and Limits	2-23
2.4.2.1	Limits to the User Session Level	2-24
2.4.2.2	Limits to Database Call Levels	2-24
2.4.2.3	Limits to CPU Time	2-24
2.4.2.4	Limits to Logical Reads	2-24
2.4.2.5	Limits to Other Resources	2-25
2.4.3	Values for Resource Limits of Profiles	2-25
2.4.4	Managing Resources with Profiles	2-26
2.4.4.1	About Profiles	2-26
2.4.4.2	ORA_CIS_PROFILE User Profile	2-27

2.4.4.3	ORA_STIG_PROFILE User Profile	2-27
2.4.4.4	Creating a Profile	2-28
2.4.4.5	Creating a CDB Profile or an Application Profile	2-29
2.4.4.6	Assigning a Profile to a User	2-29
2.4.4.7	Dropping Profiles	2-29
2.4.5	Common Mandatory Profiles in the CDB Root	2-30
2.4.5.1	About Common Mandatory Profiles in the CDB Root	2-30
2.4.5.2	Creating a Common Mandatory Profile in the CDB Root	2-31
2.4.5.3	Example: Function to Enforce Minimum Password Length	2-32
2.5	Dropping User Accounts	2-36
2.5.1	About Dropping User Accounts	2-37
2.5.2	Terminating a User Session	2-37
2.5.3	About Dropping a User After the User Is No Longer Connected to the Database	2-37
2.5.4	Dropping a User Whose Schema Contains Objects	2-38
2.6	Predefined Schema User Accounts Provided by Oracle Database	2-38
2.6.1	About the Predefined Schema User Accounts	2-38
2.6.2	Predefined Administrative Accounts	2-39
2.6.3	Predefined Non-Administrative User Accounts	2-42
2.6.4	Predefined Sample Schema User Accounts	2-42
2.7	Database User and Profile Data Dictionary Views	2-43
2.7.1	Data Dictionary Views That List Information About Users and Profiles	2-43
2.7.2	Query to Find All Users and Associated Information	2-44
2.7.3	Query to List All Tablespace Quotas	2-45
2.7.4	Query to List All Profiles and Assigned Limits	2-45
2.7.5	Query to View Memory Use for Each User Session	2-46

3 Configuring Authentication

3.1	About Authentication	3-1
3.2	Configuring Password Protection	3-2
3.2.1	What Are the Oracle Database Built-in Password Protections?	3-3
3.2.2	Minimum Requirements for Passwords	3-4
3.2.3	Creating a Password by Using the IDENTIFIED BY Clause	3-4
3.2.4	Using a Password Management Policy	3-4
3.2.4.1	About Managing Passwords	3-5
3.2.4.2	Finding User Accounts That Have Default Passwords	3-6
3.2.4.3	Password Settings in the Default Profile	3-7
3.2.4.4	Using the ALTER PROFILE Statement to Modify Profile Limits	3-8
3.2.4.5	Disabling and Enabling the Default Password Security Settings	3-9
3.2.4.6	Automatically Locking Inactive Database User Accounts	3-9
3.2.4.7	Automatically Locking User Accounts After a Specified Number of Failed Log-in Attempts	3-10

3.2.4.8	Example: Locking an Account with the CREATE PROFILE Statement	3-11
3.2.4.9	Explicitly Locking a User Account with the CREATE USER or ALTER USER Statement	3-11
3.2.4.10	Controlling the User Ability to Reuse Previous Passwords	3-11
3.2.4.11	About Controlling Password Aging and Expiration	3-12
3.2.4.12	Setting a Password Lifetime	3-13
3.2.4.13	Checking the Status of a User Account	3-13
3.2.4.14	Password Change Life Cycle	3-13
3.2.4.15	PASSWORD_LIFE_TIME Profile Parameter Low Value	3-15
3.2.5	Managing Gradual Database Password Rollover for Applications	3-16
3.2.5.1	About Managing Gradual Database Password Rollover for Applications	3-17
3.2.5.2	Password Change Life Cycle During a Gradual Database Password Rollover	3-18
3.2.5.3	Enabling the Gradual Database Password Rollover	3-19
3.2.5.4	Changing a Password to Begin the Gradual Database Password Rollover Period	3-20
3.2.5.5	Changing a Password During the Gradual Database Password Rollover Period	3-21
3.2.5.6	Ending the Password Rollover Period	3-22
3.2.5.7	Database Behavior During the Gradual Password Rollover Period	3-22
3.2.5.8	Database Server Behavior After the Password Rollover Period Ends	3-23
3.2.5.9	Guideline for Handling Compromised Passwords	3-23
3.2.5.10	How Gradual Database Password Rollover Works During Oracle Data Pump Exports	3-24
3.2.5.11	Using Gradual Database Password Rollover in an Oracle Data Guard Environment	3-24
3.2.5.12	Finding Users Who Still Use Their Old Passwords	3-24
3.2.6	Managing the Complexity of Passwords	3-25
3.2.6.1	About Password Complexity Verification	3-26
3.2.6.2	How Oracle Database Checks the Complexity of Passwords	3-26
3.2.6.3	Who Can Use the Password Complexity Functions?	3-26
3.2.6.4	ora12c_verify_function Password Requirements	3-26
3.2.6.5	ora12c_strong_verify_function Function Password Requirements	3-27
3.2.6.6	ora12c_stig_verify_function Password Requirements	3-27
3.2.6.7	About Customizing Password Complexity Verification	3-28
3.2.6.8	Enabling Password Complexity Verification	3-28
3.2.7	Managing Password Case Sensitivity	3-29
3.2.7.1	Management of Case Sensitivity for Secure Role Passwords	3-29
3.2.7.2	Management of Password Versions of Users	3-30
3.2.7.3	Finding and Resetting User Passwords That Use the 10G Password Version	3-30
3.2.7.4	How Case Sensitivity Affects Password Files	3-32
3.2.7.5	How Case Sensitivity Affects Passwords Used in Database Link Connections	3-33

3.2.8	Ensuring Against Password Security Threats by Using the 12C Password Version	3-33
3.2.8.1	About the 12C Version of the Password Hash	3-34
3.2.8.2	Oracle Database 12C Password Version Configuration Guidelines	3-35
3.2.8.3	Configuring Oracle Database to Use the 12C Password Version Exclusively	3-37
3.2.8.4	How Server and Client Logon Versions Affect Database Links	3-38
3.2.8.5	Configuring Oracle Database Clients to Use the 12C Password Version Exclusively	3-40
3.2.9	Managing the Secure External Password Store for Password Credentials	3-41
3.2.9.1	About the Secure External Password Store	3-41
3.2.9.2	How Does the Secure External Password Store Work?	3-42
3.2.9.3	About Configuring Clients to Use the Secure External Password Store	3-43
3.2.9.4	Configuring a Client to Use the Secure External Password Store	3-43
3.2.9.5	Example: Sample sqlnet.ora File with Wallet Parameters Set	3-45
3.2.9.6	Managing External Password Store Credentials	3-45
3.2.9.7	Creating SQL*Loader Object Store Credentials	3-47
3.2.10	Managing Passwords for Administrative Users	3-48
3.2.10.1	About Managing Passwords for Administrative Users	3-49
3.2.10.2	Setting the LOCK and EXPIRED Status of Administrative Users	3-49
3.2.10.3	Password Profile Settings for Administrative Users	3-49
3.2.10.4	Last Successful Login Time for Administrative Users	3-49
3.2.10.5	Management of the Password File of Administrative Users	3-49
3.2.10.6	Migration of the Password File of Administrative Users	3-50
3.2.10.7	How the Multitenant Option Affects Password Files for Administrative Users	3-51
3.2.10.8	Password Complexity Verification Functions for Administrative Users	3-51
3.3	Authentication of Database Administrators	3-51
3.3.1	About Authentication of Database Administrators	3-52
3.3.2	Strong Authentication, Centralized Management for Administrators	3-52
3.3.2.1	About Strong Authentication for Database Administrators	3-52
3.3.2.2	Configuring Directory Authentication for Administrative Users	3-53
3.3.2.3	Configuring Kerberos Authentication for Administrative Users	3-54
3.3.3	Authentication of Database Administrators by Using the Operating System	3-55
3.3.4	Authentication of Database Administrators by Using Their Passwords	3-55
3.3.5	Risks of Using Password Files for Database Administrator Authentication	3-56
3.4	Database Authentication of Users	3-57
3.4.1	About Database Authentication of Users	3-57
3.4.2	Advantages of Database Authentication	3-59
3.4.3	Creating Users Who Are Authenticated by the Database	3-59
3.5	Schema-Only Accounts	3-60
3.5.1	About Schema-Only Accounts	3-60
3.5.2	Creating a Schema-Only Account	3-61

3.5.3	Altering a Schema-Only Account	3-61
3.6	Configuring Operating System Users for a PDB	3-61
3.6.1	About Configuring Operating System Users for a PDB	3-62
3.6.2	PDB_OS_CREDENTIAL Initialization Parameter	3-62
3.6.3	Configuring an Operating System User for a PDB	3-62
3.6.4	Setting the Default Credential in a PDB	3-63
3.7	External (Non-Database) User Authentication and Access to the Database	3-64
3.7.1	External Authentication with Local Database Authorization	3-64
3.7.1.1	About External Authentication with Local Database Authorization	3-64
3.7.1.2	Operating System Authentication	3-65
3.7.1.3	Kerberos Authentication	3-66
3.7.1.4	Public Key Infrastructure Certificate Authentication	3-66
3.7.1.5	RADIUS Authentication	3-67
3.7.2	External Authentication with External Authorization	3-67
3.7.2.1	About External Authentication with External Authorization	3-68
3.7.2.2	Centrally Managed Users with Microsoft Active Directory	3-68
3.7.2.3	Microsoft Entra ID Integration	3-69
3.7.2.4	Oracle Cloud Infrastructure Identity and Access Management Integration	3-69
3.7.2.5	Oracle Enterprise User Security	3-69
3.8	Multitier Authentication and Authorization	3-69
3.9	Administration and Security in Clients, Application Servers, and Database Servers	3-70
3.10	Preserving User Identity in Multitiered Environments	3-71
3.10.1	Middle Tier Server Use for Proxy Authentication	3-72
3.10.1.1	About Proxy Authentication	3-73
3.10.1.2	Advantages of Proxy Authentication	3-73
3.10.1.3	Who Can Create Proxy User Accounts?	3-74
3.10.1.4	Guidelines for Creating Proxy User Accounts	3-74
3.10.1.5	Creating Proxy User Accounts and Authorizing Users to Connect Through Them	3-75
3.10.1.6	Proxy User Accounts and the Authorization of Users to Connect Through Them	3-76
3.10.1.7	Using Proxy Authentication with the Secure External Password Store	3-76
3.10.1.8	How the Identity of the Real User Is Passed with Proxy Authentication	3-77
3.10.1.9	Limits to the Privileges of the Middle Tier	3-78
3.10.1.10	Authorizing a Middle Tier to Proxy and Authenticate a User	3-79
3.10.1.11	Authorizing a Middle Tier to Proxy a User Authenticated by Other Means	3-79
3.10.1.12	Reauthenticating a User Through the Middle Tier to the Database	3-80
3.10.1.13	Using Password-Based Proxy Authentication	3-80
3.10.1.14	Using Proxy Authentication with Enterprise Users	3-81
3.10.2	Using Client Identifiers to Identify Application Users Unknown to the Database	3-82
3.10.2.1	About Client Identifiers	3-82
3.10.2.2	How Client Identifiers Work in Middle Tier Systems	3-82

3.10.2.3	Use of the CLIENT_IDENTIFIER Attribute to Preserve User Identity	3-83
3.10.2.4	Use of the CLIENT_IDENTIFIER Independent of Global Application Context	3-83
3.10.2.5	Setting the CLIENT_IDENTIFIER Independent of Global Application Context	3-84
3.10.2.6	Use of the DBMS_SESSION PL/SQL Package to Set and Clear the Client Identifier	3-85
3.10.2.7	Enabling the CLIENTID_OVERWRITE Event System-Wide	3-85
3.10.2.8	Enabling the CLIENTID_OVERWRITE Event for the Current Session	3-86
3.10.2.9	Disabling the CLIENTID_OVERWRITE Event	3-86
3.11	User Authentication Data Dictionary Views	3-86

4 Configuring Privilege and Role Authorization

4.1	About Privileges and Roles	4-2
4.2	Privilege and Role Grants in a CDB	4-3
4.2.1	About Privilege and Role Grants in a CDB	4-4
4.2.2	Principles of Privilege and Role Grants in a CDB	4-4
4.2.3	Privileges and Roles Granted Locally in a CDB	4-5
4.2.4	What Makes a Privilege or Role Grant Local	4-5
4.2.5	Roles and Privileges Granted Locally	4-6
4.2.6	Roles and Privileges Granted Commonly in a CDB	4-6
4.2.7	What Makes a Grant Common	4-7
4.2.8	Roles and Privileges Granted Commonly	4-7
4.2.9	Grants to PUBLIC in a CDB	4-8
4.2.10	Grants of Privileges and Roles: Scenario	4-8
4.3	Who Should Be Granted Privileges?	4-11
4.4	How the Oracle Multitenant Option Affects Privileges	4-12
4.5	Managing Administrative Privileges	4-12
4.5.1	About Administrative Privileges	4-13
4.5.2	Grants of Administrative Privileges to Users	4-13
4.5.3	SYSDBA and SYSOPER Privileges for Standard Database Operations	4-13
4.5.4	Forcing oracle Users to Enter a Password When Logging in as SYSDBA	4-14
4.5.5	SYSBACKUP Administrative Privilege for Backup and Recovery Operations	4-14
4.5.6	SYSDBG Administrative Privilege for Oracle Data Guard Operations	4-16
4.5.7	SYSKM Administrative Privilege for Transparent Data Encryption	4-17
4.5.8	SYSRAC Administrative Privilege for Oracle Real Application Clusters	4-17
4.6	Managing System Privileges	4-18
4.6.1	About System Privileges	4-19
4.6.2	Who Can Grant or Revoke System Privileges?	4-19
4.6.3	Why Is It Important to Restrict System Privileges?	4-20
4.6.3.1	About the Importance of Restricting System Privileges	4-20
4.6.3.2	User Access to Objects in the SYS Schema	4-20

4.6.4	Grants and Revokes of System Privileges	4-21
4.6.5	About ANY Privileges and the PUBLIC Role	4-21
4.7	Managing Schema Privileges	4-22
4.7.1	About Managing Schema Privileges	4-22
4.7.2	Privileges That Are Excluded from Schema Privilege Grants	4-23
4.7.3	Granting a Schema Privilege	4-25
4.7.4	Revoking a Schema Privilege	4-26
4.8	Administering Schema Security Policies	4-26
4.8.1	About Administering Schema System Security Policies	4-26
4.8.2	Granting an Administrator Schema Security Policy	4-27
4.8.3	Revoking an Administrator Security Policy	4-27
4.9	Managing Privileges to Enable Diagnostics	4-28
4.10	Managing Commonly and Locally Granted Privileges	4-29
4.10.1	About Commonly and Locally Granted Privileges	4-29
4.10.2	How Commonly Granted System Privileges Work	4-30
4.10.3	How Commonly Granted Object Privileges Work	4-30
4.10.4	Granting or Revoking Privileges to Access a PDB	4-31
4.10.5	Example: Granting a Privilege to a Common User	4-31
4.10.6	Enabling Common Users to View CONTAINER_DATA Object Information	4-31
4.10.6.1	Viewing Data About the Root, CDB, and PDBs While Connected to the Root	4-32
4.10.6.2	Enabling Common Users to Query Data in Specific PDBs	4-33
4.11	Managing User Roles	4-33
4.11.1	About User Roles	4-34
4.11.1.1	What Are User Roles?	4-35
4.11.1.2	The Functionality of Roles	4-35
4.11.1.3	Properties of Roles and Why They Are Advantageous	4-36
4.11.1.4	Typical Uses of Roles	4-36
4.11.1.5	Common Uses of Application Roles	4-38
4.11.1.6	Common Uses of User Roles	4-38
4.11.1.7	How Roles Affect the Scope of a User's Privileges	4-38
4.11.1.8	How Roles Work in PL/SQL Blocks	4-38
4.11.1.9	How Roles Aid or Restrict DDL Usage	4-39
4.11.1.10	How Operating Systems Can Aid Roles	4-40
4.11.1.11	How Roles Work in a Distributed Environment	4-40
4.11.2	Predefined Roles in an Oracle Database Installation	4-40
4.11.3	Creating a Role	4-48
4.11.3.1	About the Creation of Roles	4-48
4.11.3.2	Creating a Role That Is Authenticated With a Password	4-49
4.11.3.3	Creating a Role That Has No Password Authentication	4-50
4.11.3.4	Creating a Role That Is External or Global	4-50
4.11.3.5	Altering a Role	4-51

4.11.4	Specifying the Type of Role Authorization	4-51
4.11.4.1	Authorizing a Role by Using the Database	4-51
4.11.4.2	Authorizing a Role by Using an Application	4-52
4.11.4.3	Authorizing a Role by Using an External Source	4-52
4.11.4.4	Authorizing a Role by Using the Operating System	4-53
4.11.4.5	Authorizing a Role by Using a Network Client	4-53
4.11.4.6	Authorizing a Global Role by an Enterprise Directory Service	4-53
4.11.5	Granting and Revoking Roles	4-54
4.11.5.1	About Granting and Revoking Roles	4-54
4.11.5.2	Who Can Grant or Revoke Roles?	4-55
4.11.5.3	Granting and Revoking Roles to and from Program Units	4-55
4.11.6	Dropping Roles	4-55
4.11.7	Restricting SQL*Plus Users from Using Database Roles	4-56
4.11.7.1	Potential Security Problems of Using Ad Hoc Tools	4-56
4.11.7.2	How the PRODUCT_USER_PROFILE System Table Can Limit Roles	4-57
4.11.7.3	How Stored Procedures Can Encapsulate Business Logic	4-57
4.11.8	Role Privileges and Secure Application Roles	4-57
4.12	Managing Common Roles and Local Roles	4-58
4.12.1	About Common Roles and Local Roles	4-59
4.12.2	Common Roles in a CDB	4-59
4.12.3	How Common Roles Work	4-60
4.12.4	How the PUBLIC Role Works in a Multitenant Environment	4-60
4.12.5	Privileges Required to Create, Modify, or Drop a Common Role	4-60
4.12.6	Rules for Creating Common Roles	4-60
4.12.7	Creating a Common Role	4-61
4.12.8	Rules for Creating Local Roles	4-61
4.12.9	Local Roles in a CDB	4-62
4.12.10	Creating a Local Role	4-62
4.12.11	Role Grants and Revokes for Common Users and Local Users	4-62
4.13	Restricting Operations on PDBs Using PDB Lockdown Profiles	4-63
4.13.1	About PDB Lockdown Profiles	4-64
4.13.2	How PDB Lockdown Profiles Work	4-64
4.13.3	PDB_OS_CREDENTIAL Initialization Parameter	4-66
4.13.4	Features That Benefit from PDB Lockdown Profiles	4-66
4.13.5	PDB Lockdown Profile Inheritance	4-67
4.13.6	Default PDB Lockdown Profiles	4-67
4.13.7	Creating a PDB Lockdown Profile	4-68
4.13.8	Enabling or Disabling a PDB Lockdown Profile	4-69
4.13.9	Dropping a PDB Lockdown Profile	4-71
4.14	Managing Object Privileges	4-72
4.14.1	About Object Privileges	4-72
4.14.2	Who Can Grant Object Privileges?	4-73

4.14.3	Grants and Revokes of Object Privileges	4-73
4.14.3.1	About Granting and Revoking Object Privileges	4-73
4.14.3.2	How the ALL Clause Grants or Revokes All Available Object Privileges	4-74
4.14.4	READ and SELECT Object Privileges	4-74
4.14.4.1	About Managing READ and SELECT Object Privileges	4-74
4.14.4.2	Enabling Users to Use the READ Object Privilege to Query Any Table in the Database	4-75
4.14.4.3	Restrictions on the READ and READ ANY TABLE Privileges	4-75
4.14.5	Object Privilege Use with Synonyms	4-75
4.14.6	Sharing Application Common Objects	4-76
4.14.6.1	Metadata-Linked Application Common Objects	4-77
4.14.6.2	Data-Linked Application Common Objects	4-77
4.14.6.3	Extended Data-Linked Application Common Objects	4-78
4.15	Managing Dictionary Protection for Oracle-Maintained Schemas	4-79
4.15.1	About Managing Dictionary Protection for Oracle-Maintained Schemas	4-79
4.15.2	Enabling Dictionary Protection in an Oracle-Maintained Schema	4-80
4.15.3	Disabling Dictionary Protection in an Oracle-Maintained Schema	4-80
4.16	Table Privileges	4-81
4.16.1	How Table Privileges Affect Data Manipulation Language Operations	4-81
4.16.2	How Table Privileges Affect Data Definition Language Operations	4-81
4.17	View Privileges	4-82
4.17.1	Privileges Required to Create Views	4-82
4.17.2	Privileges to Query Views in Other Schemas	4-83
4.17.3	The Use of Views to Increase Table Security	4-83
4.18	Procedure Privileges	4-84
4.18.1	The Use of the EXECUTE Privilege for Procedure Privileges	4-84
4.18.2	Procedure Execution and Security Domains	4-84
4.18.3	System Privileges Required to Create or Replace a Procedure	4-84
4.18.4	System Privileges Required to Compile a Procedure	4-85
4.18.5	How Procedure Privileges Affect Packages and Package Objects	4-85
4.18.5.1	About the Effect of Procedure Privileges on Packages and Package Objects	4-85
4.18.5.2	Example: Procedure Privileges Used in One Package	4-86
4.18.5.3	Example: Procedure Privileges and Package Objects	4-86
4.19	Type Privileges	4-87
4.19.1	System Privileges for Named Types	4-88
4.19.2	Object Privileges for Named Types	4-88
4.19.3	Method Execution Model for Named Types	4-88
4.19.4	Privileges Required to Create Types and Tables Using Types	4-89
4.19.5	Example: Privileges for Creating Types and Tables Using Types	4-89
4.19.6	Privileges on Type Access and Object Access	4-90
4.19.7	Type Dependencies	4-91

4.20	Grants of User Privileges and Roles	4-92
4.20.1	Granting System Privileges and Roles to Users and Roles	4-92
4.20.1.1	Privileges for Grants of System Privileges and Roles to Users and Roles	4-92
4.20.1.2	Example: Granting a System Privilege and a Role to a User	4-93
4.20.1.3	Example: Granting the EXECUTE Privilege on a Directory Object	4-93
4.20.1.4	Use of the ADMIN Option to Enable Grantee Users to Grant the Privilege	4-93
4.20.1.5	Creating a New User with the GRANT Statement	4-93
4.20.2	Granting Object Privileges to Users and Roles	4-94
4.20.2.1	About Granting Object Privileges to Users and Roles	4-94
4.20.2.2	How the WITH GRANT OPTION Clause Works	4-95
4.20.2.3	Grants of Object Privileges on Behalf of the Object Owner	4-95
4.20.2.4	Grants of Privileges on Columns	4-97
4.20.2.5	Row-Level Access Control	4-97
4.21	Revokes of Privileges and Roles from a User	4-97
4.21.1	Revokes of System Privileges and Roles	4-98
4.21.2	Revokes of Object Privileges	4-98
4.21.2.1	About Revokes of Object Privileges	4-98
4.21.2.2	Revokes of Multiple Object Privileges	4-99
4.21.2.3	Revokes of Object Privileges on Behalf of the Object Owner	4-99
4.21.2.4	Revokes of Column-Selective Object Privileges	4-100
4.21.2.5	Revokes of the REFERENCES Object Privilege	4-100
4.21.3	Cascading Effects of Revoking Privileges	4-101
4.21.3.1	Cascading Effects When Revoking System Privileges	4-101
4.21.3.2	Cascading Effects When Revoking Object Privileges	4-101
4.22	Grants and Revokes of Privileges to and from the PUBLIC Role	4-102
4.23	Grants of Roles Using the Operating System or Network	4-102
4.23.1	About Granting Roles Using the Operating System or Network	4-103
4.23.2	Operating System Role Identification	4-104
4.23.3	Operating System Role Management	4-105
4.23.4	Role Grants and Revokes When OS_ROLES Is Set to TRUE	4-105
4.23.5	Role Enablements and Disablements When OS_ROLES Is Set to TRUE	4-105
4.23.6	Network Connections with Operating System Role Management	4-105
4.24	How Grants and Revokes Work with SET ROLE and Default Role Settings	4-106
4.24.1	When Grants and Revokes Take Effect	4-106
4.24.2	How the SET ROLE Statement Affects Grants and Revokes	4-106
4.24.3	Specifying the Default Role for a User	4-107
4.24.4	The Maximum Number of Roles That a User Can Have Enabled	4-107
4.25	Configuring Read-Only Users	4-108
4.26	User Privilege and Role Data Dictionary Views	4-109
4.26.1	Data Dictionary Views to Find Information about Privilege and Role Grants	4-110
4.26.2	Query to List All System Privilege Grants	4-112
4.26.3	Query to List Schema Privilege Grants	4-112

4.26.4	Query to List All Role Grants	4-112
4.26.5	Query to List Object Privileges Granted to a User	4-113
4.26.6	Query to List the Current Privilege Domain of Your Session	4-113
4.26.7	Query to List Roles of the Database	4-114
4.26.8	Query to List Information About the Privilege Domains of Roles	4-114

5 Performing Privilege Analysis to Identify Privilege Use

5.1	What Is Privilege Analysis?	5-1
5.1.1	About Privilege Analysis	5-2
5.1.2	Benefits and Use Cases of Privilege Analysis	5-2
5.1.2.1	Least Privileges Best Practice	5-2
5.1.2.2	Development of Secure Applications	5-3
5.1.3	Who Can Perform Privilege Analysis?	5-3
5.1.4	Types of Privilege Analysis	5-3
5.1.5	How Does a Multitenant Environment Affect Privilege Analysis?	5-4
5.1.6	How Privilege Analysis Works with Pre-Compiled Database Objects	5-4
5.2	Creating and Managing Privilege Analysis Policies	5-5
5.2.1	About Creating and Managing Privilege Analysis Policies	5-5
5.2.2	General Steps for Managing Privilege Analysis	5-6
5.2.3	Creating a Privilege Analysis Policy	5-6
5.2.4	Examples of Creating Privilege Analysis Policies	5-8
5.2.4.1	Example: Privilege Analysis of Database-Wide Privileges	5-8
5.2.4.2	Example: Privilege Analysis of Privilege Usage of Two Roles	5-8
5.2.4.3	Example: Privilege Analysis of Privileges During SQL*Plus Use	5-9
5.2.4.4	Example: Privilege Analysis of PSMITH Privileges During SQL*Plus Access	5-9
5.2.5	Enabling a Privilege Analysis Policy	5-9
5.2.6	Disabling a Privilege Analysis Policy	5-10
5.2.7	Generating a Privilege Analysis Report	5-10
5.2.7.1	About Generating a Privilege Analysis Report	5-11
5.2.7.2	General Process for Managing Multiple Named Capture Runs	5-11
5.2.7.3	Generating a Privilege Analysis Report Using DBMS_PRIVILEGE_CAPTURE	5-12
5.2.7.4	Generating a Privilege Analysis Report Using Cloud Control	5-13
5.2.7.5	Accessing Privilege Analysis Reports Using Cloud Control	5-13
5.2.8	Dropping a Privilege Analysis Policy	5-14
5.3	Creating Roles and Managing Privileges Using Cloud Control	5-14
5.3.1	Creating a Role from a Privilege Analysis Report in Cloud Control	5-15
5.3.2	Revoking and Regranting Roles and Privileges Using Cloud Control	5-15
5.3.3	Generating a Revoke or Regrant Script Using Cloud Control	5-16
5.3.3.1	About Generating Revoke and Regrant Scripts	5-16
5.3.3.2	Generating a Revoke Script	5-16

5.3.3.3	Generating a Regrant Script	5-17
5.4	Tutorial: Using Capture Runs to Analyze ANY Privilege Use	5-18
5.4.1	Step 1: Create User Accounts	5-18
5.4.2	Step 2: Create and Enable a Privilege Analysis Policy	5-19
5.4.3	Step 3: Use the READ ANY TABLE System Privilege	5-20
5.4.4	Step 4: Disable the Privilege Analysis Policy	5-20
5.4.5	Step 5: Generate and View a Privilege Analysis Report	5-20
5.4.6	Step 6: Create a Second Capture Run	5-21
5.4.7	Step 7: Remove the Components for This Tutorial	5-22
5.5	Tutorial: Analyzing Privilege Use by a User Who Has the DBA Role	5-22
5.5.1	Step 1: Create User Accounts	5-23
5.5.2	Step 2: Create and Enable a Privilege Analysis Policy	5-24
5.5.3	Step 3: Perform the Database Tuning Operations	5-24
5.5.4	Step 4: Disable the Privilege Analysis Policy	5-25
5.5.5	Step 5: Generate and View Privilege Analysis Reports	5-25
5.5.6	Step 6: Remove the Components for This Tutorial	5-27
5.6	Tutorial: Capturing Schema Privilege Use	5-27
5.6.1	Step 1: Create User Accounts	5-27
5.6.2	Step 2: Create and Enable a Privilege Analysis Policy	5-28
5.6.3	Step 3: Use the READ ANY TABLE System Privilege	5-29
5.6.4	Step 4: Disable the Privilege Analysis Policy	5-29
5.6.5	Step 5: Generate and View Privilege Analysis Reports	5-29
5.6.6	Step 6: Remove the Components for This Tutorial	5-30
5.7	Privilege Analysis Policy and Report Data Dictionary Views	5-30

6 Configuring Centrally Managed Users with Microsoft Active Directory

6.1	Introduction to Centrally Managed Users with Microsoft Active Directory	6-1
6.1.1	About the Oracle Database-Microsoft Active Directory Integration	6-2
6.1.2	How Centrally Managed Users with Microsoft Active Directory Works	6-3
6.1.3	Centrally Managed User-Microsoft Active Directory Architecture	6-3
6.1.4	Supported Authentication Methods	6-4
6.1.5	Users Supported by Centrally Managed Users with Microsoft Active Directory	6-4
6.1.6	How the Oracle Multitenant Option Affects Centrally Managed Users	6-5
6.1.7	Centrally Managed Users with Database Links	6-5
6.2	Configuring the Oracle Database-Microsoft Active Directory Integration	6-6
6.2.1	About Configuring the Oracle Database-Microsoft Active Directory Connection	6-6
6.2.2	Connecting to Microsoft Active Directory	6-6
6.2.2.1	Step 1: Create an Oracle Service Directory User Account on Microsoft Active Directory and Grant Permissions	6-7
6.2.2.2	Step 2: For Password Authentication, Install the Password Filter and Extend the Microsoft Active Directory Schema	6-8
6.2.2.3	Step 3: If Necessary, Install the Oracle Database Software	6-10

6.2.2.4	Step 4: Create the dsi.ora or ldap.ora File	6-10
6.2.2.5	Step 5: Request an Active Directory Certificate for a Secure Connection	6-16
6.2.2.6	Step 6: Create the Wallet for a Secure Connection	6-17
6.2.2.7	Step 7: Configure the Microsoft Active Directory Connection	6-19
6.2.2.8	Step 8: Verify the Oracle Wallet	6-22
6.2.2.9	Step 9: Test the Integration	6-23
6.3	Configuring Authentication for Centrally Managed Users	6-24
6.3.1	Configuring Password Authentication for Centrally Managed Users	6-24
6.3.1.1	About Configuring Password Authentication for Centrally Managed Users	6-24
6.3.1.2	Configuring Password Authentication for a Centrally Managed User	6-25
6.3.1.3	Logging in to an Oracle Database Using Password Authentication	6-27
6.3.2	Configuring Proxy Authentication for Centrally Managed Users	6-27
6.3.2.1	About Configuring Proxy Authentication for Centrally Managed Users	6-28
6.3.2.2	Configuring Proxy Authentication for the Centrally Managed User	6-28
6.3.2.3	Validating the Centrally Managed User Proxy Authentication	6-29
6.3.3	Configuring Kerberos Authentication for Centrally Managed Users	6-29
6.3.4	Configuring Authentication Using PKI Certificates for Centrally Managed Users	6-30
6.4	Configuring Authorization for Centrally Managed Users	6-30
6.4.1	About Configuring Authorization for Centrally Managed Users	6-31
6.4.2	Mapping a Directory Group to a Shared Database Global User	6-32
6.4.3	Mapping a Directory Group to a Global Role	6-32
6.4.4	Exclusively Mapping a Directory User to a Database Global User	6-33
6.4.5	Altering or Migrating a User Mapping Definition	6-33
6.4.6	Configuring Administrative Users	6-34
6.4.6.1	Configuring Database Administrative Users with Shared Access Accounts	6-34
6.4.6.2	Configuring Database Administrative Users Using Exclusive Mapping	6-34
6.4.7	Verifying the Centrally Managed User Logon Information	6-35
6.5	Integration of Oracle Database with Microsoft Active Directory Account Policies	6-38
6.6	Configuring Centrally Managed Users with Oracle Autonomous Database	6-38
6.7	Troubleshooting Centrally Managed Users	6-38
6.7.1	ORA-01017 Connection Errors	6-39
6.7.2	ORA-28274 Connection Errors	6-39
6.7.3	ORA-28276 Connection Errors	6-40
6.7.4	ORA-28300 Connection Errors	6-41
6.7.5	Using Trace Files to Diagnose CMU Connection Errors	6-41

7 Authenticating and Authorizing IAM Users for Oracle DBaaS Databases

7.1	Introduction to Authenticating and Authorizing IAM Users for Oracle DBaaS	7-1
7.1.1	About Authenticating and Authorizing IAM Users for Oracle DBaaS	7-2
7.1.2	Architecture of the IAM Integration with Oracle DBaaS	7-4
7.1.3	IAM Users and Groups to Map with Oracle DBaaS	7-8

7.2	Configuring Oracle DBaaS for IAM	7-8
7.2.1	Enabling External Authentication for Oracle DBaaS	7-8
7.2.2	Configuring Authorization for IAM Users and Oracle Cloud Infrastructure Applications	7-9
7.2.2.1	About Configuring Authorization for IAM Users and Oracle Cloud Infrastructure Applications	7-10
7.2.2.2	Mapping an IAM Group to a Shared Oracle Database Global User	7-11
7.2.2.3	Mapping an IAM Group to an Oracle Database Global Role	7-12
7.2.2.4	Exclusively Mapping an IAM User to an Oracle Database Global User	7-12
7.2.2.5	Altering or Migrating an IAM User Mapping Definition	7-13
7.2.2.6	Mapping Instance and Resource Principals	7-13
7.2.2.7	Verifying the IAM User Logon Information	7-14
7.2.3	Configuring IAM Proxy Authentication	7-17
7.2.3.1	About Configuring IAM Proxy Authentication	7-17
7.2.3.2	Configuring Proxy Authentication for the IAM User	7-18
7.2.3.3	Validating the IAM User Proxy Authentication	7-18
7.3	Configuring IAM for Oracle DBaaS	7-19
7.3.1	Creating an IAM Policy to Authorize Users Authenticating with Tokens	7-19
7.3.2	Creating an IAM Database Password	7-20
7.4	Accessing the Database Using an Instance Principal or a Resource Principal	7-20
7.5	Configuring the Database Client Connection	7-21
7.5.1	About Connecting to an Autonomous Database Instance Using IAM	7-22
7.5.2	Supported Client Drivers for IAM Connections	7-22
7.5.3	Using Centralized Oracle Cloud Infrastructure Services for Net Naming and Secrets	7-22
7.5.4	Client Connections That Use an IAM Database Password Verifier	7-23
7.5.5	Client Connections That Use a Token Requested by an IAM User Name and Database Password	7-23
7.5.5.1	About Client Connections That Use a Token Requested by an IAM User Name and Database Password	7-23
7.5.5.2	Parameters to Set for Client Connections That Use a Token Requested by an IAM User Name and Database Password	7-24
7.5.5.3	Configuring the Database Client to Retrieve a Token Using an IAM User Name and Database Password	7-26
7.5.5.4	Configuring a Secure External Password Store Wallet to Retrieve an IAM Token	7-27
7.5.6	Client Connections That Use a Token Requested by a Client Application or Tool	7-27
7.5.7	TLS Connections without Client Wallets	7-28
7.5.8	Enabling Clients to Directly Retrieve IAM Tokens	7-28
7.5.9	Common Database Client Configurations	7-29
7.5.9.1	Configuring a Client Connection for SQL*Plus That Uses an IAM Database Password	7-29
7.5.9.2	Configuring a Client Connection for SQL*Plus That Uses an IAM Token	7-30
7.5.10	Using OCI Object Store for Network Service Configuration Information	7-32

7.6	Accessing a Database Cross-Tenancy Using an IAM Integration	7-32
7.6.1	About Cross-Tenancy Access for IAM Users to DBaaS Instances	7-32
7.6.2	Configuring Policies	7-33
7.6.2.1	Configuring the Source User Tenancy	7-34
7.6.2.2	Configuring the Target Database Resource Tenancy	7-34
7.6.2.3	Policy Examples for Cross-Tenancy Access	7-35
7.6.3	Mapping Database Schemas and Roles to Users and Groups in Another Tenancy	7-36
7.6.4	Configuring Database Clients for Cross-Tenancy Access	7-37
7.6.5	Requesting Cross-Tenancy Tokens Using the OCI Command-Line Interface	7-37
7.7	Database Links in an Oracle DBaaS-to-IAM Integration	7-37
7.8	Troubleshooting IAM Connections	7-38
7.8.1	Areas to Check on the Client-Side for ORA-01017 Errors	7-38
7.8.2	Database Client Trace Files	7-40
7.8.3	Check in the Oracle Cloud Infrastructure IAM and the Oracle Database for ORA-01017 Errors	7-41
7.8.4	ORA-01017 Errors Caused by Improperly Configured IAM Users	7-42
7.8.5	ORA-12599 and ORA-03114 Errors Caused When Trying to Access a Database Using a Token	7-43
7.8.6	Actions IAM Administrators Can Take to Address ORA-01017 Errors	7-43

8 Authenticating and Authorizing Microsoft Azure Users for Oracle Databases

8.1	Introduction to Oracle Database Integration with Microsoft Entra ID	8-1
8.1.1	About Integrating Oracle Database with Microsoft Entra ID	8-2
8.1.2	Architecture of Oracle Database Integration with Microsoft Entra ID	8-4
8.1.3	Azure Users Mapping to an Oracle Database Schema and Roles	8-5
8.1.4	Use Cases for Connecting to an Oracle Database Using Entra ID	8-6
8.1.5	General Process of Authenticating Microsoft Entra ID Identities with Oracle Database	8-7
8.2	Configuring the Oracle Database for Microsoft Entra ID Integration	8-8
8.2.1	Oracle Database Requirements for the Microsoft Entra ID Integration	8-8
8.2.2	Registering the Oracle Database Instance with a Microsoft Entra ID Tenancy	8-9
8.2.3	Enabling Microsoft Entra ID v2 Access Tokens	8-13
8.2.4	Managing App Roles in Microsoft Entra ID	8-13
8.2.4.1	Creating a Microsoft Entra ID App Role	8-14
8.2.4.2	Assigning Users and Groups to the Microsoft Entra ID App Role	8-15
8.2.4.3	Assigning an Application to an App Role	8-15
8.2.5	Enabling Entra ID External Authentication for Oracle Database	8-16
8.2.6	Disabling Entra ID External Authentication for Oracle Database	8-17
8.3	Mapping Oracle Database Schemas and Roles	8-18
8.3.1	Exclusively Mapping an Oracle Database Schema to a Microsoft Azure User	8-18

8.3.2	Mapping a Shared Oracle Schema to an App Role	8-18
8.3.3	Mapping an Oracle Database Global Role to an App Role	8-19
8.4	Configuring Entra ID Client Connections to the Oracle Database	8-19
8.4.1	About Configuring Client Connections to Entra ID	8-20
8.4.2	Operational Flow for SQL*Plus Client Connection to Oracle Database Using Microsoft Entra ID OAuth2 Token	8-21
8.4.3	Supported Client Drivers for Entra ID Connections	8-24
8.4.4	Registering a Client with Entra ID Application Registration	8-24
8.4.4.1	Confidential and Public Client Registration	8-25
8.4.4.2	Registering a Database Client App with Entra ID	8-25
8.4.5	Configuration of Clients to Work with Microsoft Entra ID Tokens	8-27
8.4.5.1	Configuring Clients to Work with Microsoft Entra ID Tokens	8-27
8.4.5.2	Enabling Clients to Directly Retrieve Entra ID Tokens	8-28
8.4.5.3	Client Credential Flow	8-30
8.4.5.4	Enabling Clients to Retrieve Entra ID Tokens from a File Location	8-33
8.4.5.5	Using Azure App Configuration Store for Network Service Configuration Information	8-33
8.4.6	Examples of Retrieving Entra ID OAuth2 Tokens Outside an Oracle Database Client	8-34
8.4.6.1	About Examples of Retrieving Microsoft Entra ID OAuth2 Tokens Outside of an Oracle Database Client	8-34
8.4.6.2	Example: Requesting a Token Using a Python Script for the Interactive (Authorization) Flow	8-34
8.4.6.3	Example: Requesting a Token Using Azure CLI for the Interactive (Authorization) Flow	8-35
8.4.6.4	Requesting a Token Using the Azure CLI for the Client Credential Flow	8-36
8.4.7	Creating a Network Proxy for the Database to Connect with the Internet	8-36
8.4.7.1	About Creating a Network Proxy for the Database to Connect with the Internet	8-36
8.4.7.2	Testing the Accessibility of the Entra ID Endpoint	8-37
8.4.7.3	Creating the Network Proxy for the Default Oracle Database Environment	8-39
8.4.7.4	Creating the Network Proxy for an Oracle Real Application Clusters Environment	8-39
8.4.7.5	Creating the Network Proxy in the Windows Registry Editor	8-40
8.4.8	Using Centralized Entra ID Services for Net Naming and Secrets	8-41
8.5	Configuring Microsoft Entra ID Proxy Authentication	8-41
8.5.1	About Configuring Microsoft Entra ID Proxy Authentication	8-41
8.5.2	Configuring Proxy Authentication for the Azure User	8-42
8.5.3	Validating the Azure User Proxy Authentication	8-42
8.6	Configuring Microsoft Power BI Single-Sign On	8-42
8.6.1	About Configuring Microsoft Power BI Single-Sign On	8-43
8.6.2	Configuring the Oracle Database	8-44
8.6.3	Authorizing the User	8-45
8.6.4	Connecting Power BI to Oracle Database using Microsoft Entra ID	8-45

8.7	Troubleshooting Microsoft Entra ID Connections	8-45
8.7.1	Trace Files for Troubleshooting Oracle Database Client Connections with Entra ID	8-46
8.7.1.1	About Trace Files Used for Troubleshooting Connections	8-46
8.7.1.2	Setting Client Tracing for Token Authentication	8-47
8.7.2	ORA-12599 and ORA-03114 Errors Caused When Trying to Access a Database Using a Token	8-47
8.7.3	Checking the Entra ID Access Token Version	8-48

9 Managing Security for Definer's Rights and Invoker's Rights

9.1	About Definer's Rights and Invoker's Rights	9-1
9.2	How Procedure Privileges Affect Definer's Rights	9-2
9.3	How Procedure Privileges Affect Invoker's Rights	9-3
9.4	When You Should Create Invoker's Rights Procedures	9-4
9.5	Controlling Invoker's Rights Privileges for Procedure Calls and View Access	9-4
9.5.1	How the Privileges of a Schema Affect the Use of Invoker's Rights Procedures	9-5
9.5.2	How the INHERIT [ANY] PRIVILEGES Privileges Control Privilege Access	9-6
9.5.3	Grants of the INHERIT PRIVILEGES Privilege to Other Users	9-6
9.5.4	Example: Granting INHERIT PRIVILEGES on an Invoking User	9-7
9.5.5	Example: Revoking INHERIT PRIVILEGES	9-7
9.5.6	Grants of the INHERIT ANY PRIVILEGES Privilege to Other Users	9-7
9.5.7	Example: Granting INHERIT ANY PRIVILEGES to a Trusted Procedure Owner	9-7
9.5.8	Managing INHERIT PRIVILEGES and INHERIT ANY PRIVILEGES	9-8
9.6	Definer's Rights and Invoker's Rights in Views	9-8
9.6.1	About Controlling Definer's Rights and Invoker's Rights in Views	9-9
9.6.2	Using the BEQUEATH Clause in the CREATE VIEW Statement	9-9
9.6.3	Finding the User Name or User ID of the Invoking User	9-10
9.6.4	Finding BEQUEATH DEFINER and BEQUEATH_CURRENT_USER Views	9-10
9.7	Using Code Based Access Control for Definer's Rights and Invoker's Rights	9-11
9.7.1	About Using Code Based Access Control for Applications	9-11
9.7.2	Who Can Grant Code Based Access Control Roles to a Program Unit?	9-12
9.7.3	How Code Based Access Control Works with Invoker's Rights Program Units	9-12
9.7.4	How Code Based Access Control Works with Definer's Rights Program Units	9-14
9.7.5	Grants of Database Roles to Users for Their CBAC Grants	9-15
9.7.6	Grants and Revokes of Database Roles to a Program Unit	9-16
9.7.7	Tutorial: Controlling Access to Sensitive Data Using Code Based Access Control	9-17
9.7.7.1	About This Tutorial	9-17
9.7.7.2	Step 1: Create the User and Grant HR the CREATE ROLE Privilege	9-18
9.7.7.3	Step 2: Create the print_employees Invoker's Rights Procedure	9-18
9.7.7.4	Step 3: Create the hr_clerk Role and Grant Privileges for It	9-19
9.7.7.5	Step 4: Test the Code Based Access Control HR.print_employees Procedure	9-19

9.7.7.6	Step 5: Create the view_emp_role Role and Grant Privileges for It	9-20
9.7.7.7	Step 6: Test the HR.print_employees Procedure Again	9-20
9.7.7.8	Step 7: Remove the Components of This Tutorial	9-21
9.8	Controlling Definer's Rights Privileges for Database Links	9-21
9.8.1	About Controlling Definer's Rights Privileges for Database Links	9-22
9.8.2	Grants of the INHERIT REMOTE PRIVILEGES Privilege to Other Users	9-23
9.8.3	Example: Granting INHERIT REMOTE PRIVILEGES on a Connected User	9-23
9.8.4	Grants of the INHERIT ANY REMOTE PRIVILEGES Privilege to Other Users	9-24
9.8.5	Revokes of the INHERIT [ANY] REMOTE PRIVILEGES Privilege	9-24
9.8.6	Example: Revoking the INHERIT REMOTE PRIVILEGES Privilege	9-25
9.8.7	Example: Revoking the INHERIT REMOTE PRIVILEGES Privilege from PUBLIC	9-25
9.8.8	Tutorial: Using a Database Link in a Definer's Rights Procedure	9-25
9.8.8.1	About This Tutorial	9-26
9.8.8.2	Step 1: Create User Accounts	9-26
9.8.8.3	Step 2: As User dbuser2, Create a Table to Store User IDs	9-26
9.8.8.4	Step 3: As User dbuser1, Create a Database Link and Definer's Rights Procedure	9-27
9.8.8.5	Step 4: Test the Definer's Rights Procedure	9-27
9.8.8.6	Step 5: Remove the Components of This Tutorial	9-28

10 Managing Fine-Grained Access in PL/SQL Packages and Types

10.1	About Managing Fine-Grained Access in PL/SQL Packages and Types	10-2
10.2	About Fine-Grained Access Control to External Network Services	10-2
10.3	About Access Control to Oracle Wallets	10-3
10.4	Upgraded Applications That Depend on Packages That Use External Network Services	10-3
10.5	Configuring Access Control for External Network Services	10-4
10.5.1	Syntax for Configuring Access Control for External Network Services	10-4
10.5.2	Enabling the Listener to Recognize Access Control for External Network Services	10-6
10.5.3	Example: Configuring Access Control for External Network Services	10-6
10.5.4	Revoking Access Control Privileges for External Network Services	10-7
10.5.5	Example: Revoking External Network Services Privileges	10-7
10.6	Configuring Access Control to an Oracle Wallet	10-7
10.6.1	About Configuring Access Control to an Oracle Wallet	10-8
10.6.2	Step 1: Configure the Operating System Certificate Store as the Default Wallet Path	10-8
10.6.3	Step 2: Configure Access Control Privileges for the Oracle Wallet	10-8
10.6.4	Step 3: Make the HTTP Request with the Passwords and Client Certificates	10-10
10.6.4.1	Making the HTTPS Request with the Passwords and Client Certificates	10-10
10.6.4.2	Using a Request Context to Hold the Wallet When Sharing the Session with Other Applications	10-11

10.6.4.3	Use of Only a Client Certificate to Authenticate	10-12
10.6.4.4	Use of a Password to Authenticate	10-12
10.6.5	Revoking Access Control Privileges for Oracle Wallets	10-13
10.6.6	Troubleshooting ORA-29024 Errors	10-13
10.7	Examples of Configuring Access Control for External Network Services	10-14
10.7.1	Example: Configuring Access Control for a Single Role and Network Connection	10-14
10.7.2	Example: Configuring Access Control for a User and Role	10-15
10.7.3	Example: Using the DBA_HOST_ACES View to Show Granted Privileges	10-15
10.7.4	Example: Configuring ACL Access Using Passwords in a Non-Shared Wallet	10-16
10.7.5	Example: Configuring ACL Access for a Wallet in a Shared Database Session	10-17
10.8	Specifying a Group of Network Host Computers	10-18
10.9	Precedence Order for a Host Computer in Multiple Access Control List Assignments	10-18
10.10	Precedence Order for a Host in Access Control List Assignments with Port Ranges	10-19
10.11	Checking Privilege Assignments That Affect User Access to Network Hosts	10-19
10.11.1	About Privilege Assignments that Affect User Access to Network Hosts	10-20
10.11.2	How to Check User Network Connection and Domain Privileges	10-20
10.11.3	Example: Administrator Checking User Network Access Control Permissions	10-21
10.11.4	How Users Can Check Their Network Connection and Domain Privileges	10-21
10.11.5	Example: User Checking Network Access Control Permissions	10-22
10.12	Configuring Network Access for Java Debug Wire Protocol Operations	10-22
10.13	Data Dictionary Views for Access Control Lists Configured for User Access	10-23

11 Managing Security for a Multitenant Environment in Enterprise Manager

11.1	About Managing Security for a Multitenant Environment in Enterprise Manager	11-1
11.2	Logging into a Multitenant Environment in Enterprise Manager	11-1
11.2.1	Logging into a CDB or a PDB	11-1
11.2.2	Switching to a Different PDB or to the Root	11-2
11.3	Managing Common and Local Users in Enterprise Manager	11-3
11.3.1	Creating a Common User Account in Enterprise Manager	11-3
11.3.2	Editing a Common User Account in Enterprise Manager	11-4
11.3.3	Dropping a Common User Account in Enterprise Manager	11-5
11.3.4	Creating a Local User Account in Enterprise Manager	11-5
11.3.5	Editing a Local User Account in Enterprise Manager	11-6
11.3.6	Dropping a Local User Account in Enterprise Manager	11-6
11.4	Managing Common and Local Roles and Privileges in Enterprise Manager	11-7
11.4.1	Creating a Common Role in Enterprise Manager	11-7
11.4.2	Editing a Common Role in Enterprise Manager	11-8
11.4.3	Dropping a Common Role in Enterprise Manager	11-9
11.4.4	Revoking Common Privilege Grants in Enterprise Manager	11-9
11.4.5	Creating a Local Role in Enterprise Manager	11-9

11.4.6	Editing a Local Role in Enterprise Manager	11-10
11.4.7	Dropping a Local Role in Enterprise Manager	11-10
11.4.8	Revoking Local Privilege Grants in Enterprise Manager	11-11

Part II Application Development Security

12 Managing Security for Application Developers

12.1	About Application Security Policies	12-2
12.2	Considerations for Using Application-Based Security	12-2
12.2.1	Are Application Users Also Database Users?	12-2
12.2.2	Is Security Better Enforced in the Application or in the Database?	12-3
12.3	Use of the DB_DEVELOPER_ROLE Role for Application Developers	12-4
12.4	Securing Passwords in Application Design	12-7
12.4.1	General Guidelines for Securing Passwords in Applications	12-7
12.4.1.1	Platform-Specific Security Threats	12-7
12.4.1.2	Guidelines for Designing Applications to Handle Password Input	12-8
12.4.1.3	Guidelines for Configuring Password Formats and Behavior	12-9
12.4.1.4	Guidelines for Handling Passwords in SQL Scripts	12-10
12.4.2	Use of an External Password Store to Secure Passwords	12-11
12.4.3	Securing Passwords Using the ORAPWD Utility	12-11
12.4.4	Example: Java Code for Reading Passwords	12-11
12.5	Securing External Procedures	12-16
12.5.1	About Securing External Procedures	12-16
12.5.2	General Process for Configuring extproc for a Credential Authentication	12-16
12.5.3	extproc Process Authentication and Impersonation Expected Behaviors	12-17
12.5.4	Configuring Authentication for External Procedures	12-18
12.5.5	External Procedures for Legacy Applications	12-19
12.6	Securing LOBs with LOB Locator Signatures	12-20
12.6.1	About Securing LOBs with LOB Locator Signatures	12-20
12.6.2	Managing the Encryption of a LOB Locator Signature Key	12-20
12.7	Managing Application Privileges	12-21
12.8	Advantages of Using Roles to Manage Application Privileges	12-22
12.9	Creating Secure Application Roles to Control Access to Applications	12-22
12.9.1	Step 1: Create the Secure Application Role	12-22
12.9.2	Step 2: Create a PL/SQL Package to Define the Access Policy for the Application	12-23
12.9.2.1	About Creating a PL/SQL Package to Define the Access Policy for an Application	12-23
12.9.2.2	Creating a PL/SQL Package or Procedure to Define the Access Policy for an Application	12-24
12.9.2.3	Testing the Secure Application Role	12-25

12.10	Association of Privileges with User Database Roles	12-25
12.10.1	Why Users Should Only Have the Privileges of the Current Database Role	12-25
12.10.2	Use of the SET ROLE Statement to Automatically Enable or Disable Roles	12-26
12.11	Protecting Database Objects by Using Schemas	12-26
12.11.1	Protecting Database Objects in a Unique Schema	12-26
12.11.2	Protection of Database Objects in a Shared Schema	12-27
12.12	Object Privileges in an Application	12-27
12.12.1	What Application Developers Must Know About Object Privileges	12-28
12.12.2	SQL Statements Permitted by Object Privileges	12-28
12.13	Parameters for Enhanced Security of Database Communication	12-29
12.13.1	Bad Packets Received on the Database from Protocol Errors	12-30
12.13.2	Controlling Server Execution After Receiving a Bad Packet	12-30
12.13.3	Configuration of the Maximum Number of Authentication Attempts	12-31
12.13.4	Configuring the Display of the Database Version Banner	12-32
12.13.5	Configuring Banners for Unauthorized Access and Auditing User Actions	12-32

Part III Controlling Access to Data

13 Using Application Contexts to Retrieve User Information

13.1	About Application Contexts	13-1
13.1.1	What Is an Application Context?	13-2
13.1.2	Components of the Application Context	13-2
13.1.3	Where Are the Application Context Values Stored?	13-2
13.1.4	Benefits of Using Application Contexts	13-3
13.1.5	How Editions Affects Application Context Values	13-3
13.1.6	Application Contexts in a Multitenant Environment	13-3
13.2	Types of Application Contexts	13-4
13.3	Using Database Session-Based Application Contexts	13-5
13.3.1	About Database Session-Based Application Contexts	13-6
13.3.2	Components of a Database Session-Based Application Context	13-7
13.3.3	Creating Database Session-Based Application Contexts	13-8
13.3.3.1	About Creating Database Session-Based Application Contexts	13-8
13.3.3.2	Creating a Database Session-Based Application Context	13-8
13.3.3.3	Database Session-Based Application Contexts for Multiple Applications	13-9
13.3.4	Creating a Package to Set a Database Session-Based Application Context	13-9
13.3.4.1	About the Package That Manages the Database Session-Based Application Context	13-10
13.3.4.2	Using the SYS_CONTEXT Function to Retrieve Session Information	13-11
13.3.4.3	Checking the SYS_CONTEXT Settings	13-12
13.3.4.4	Dynamic SQL with SYS_CONTEXT	13-12
13.3.4.5	SYS_CONTEXT in a Parallel Query	13-12

13.3.4.6	SYS_CONTEXT with Database Links	13-13
13.3.4.7	DBMS_SESSION.SET_CONTEXT for Setting Session Information	13-13
13.3.4.8	Example: Simple Procedure to Create an Application Context Value	13-14
13.3.5	Logon Triggers to Run a Database Session Application Context Package	13-15
13.3.6	Example: Creating a Simple Logon Trigger	13-15
13.3.7	Example: Creating a Logon Trigger for a Production Environment	13-16
13.3.8	Example: Creating a Logon Trigger for a Development Environment	13-16
13.3.9	Tutorial: Creating and Using a Database Session-Based Application Context	13-17
13.3.9.1	Step 1: Create User Accounts and Ensure the User SCOTT Is Active	13-17
13.3.9.2	Step 2: Create the Database Session-Based Application Context	13-18
13.3.9.3	Step 3: Create a Package to Retrieve Session Data and Set the Application Context	13-18
13.3.9.4	Step 4: Create a Logon Trigger for the Package	13-19
13.3.9.5	Step 5: Test the Application Context	13-20
13.3.9.6	Step 6: Remove the Components of This Tutorial	13-20
13.3.10	Initializing Database Session-Based Application Contexts Externally	13-21
13.3.10.1	About Initializing Database Session-Based Application Contexts Externally	13-21
13.3.10.2	Default Values from Users	13-21
13.3.10.3	Values from Other External Resources	13-22
13.3.10.4	Example: Creating an Externalized Database Session-based Application Context	13-22
13.3.10.5	Initialization of Application Context Values from a Middle-Tier Server	13-22
13.3.11	Initializing Database Session-Based Application Contexts Globally	13-23
13.3.11.1	About Initializing Database Session-Based Application Contexts Globally	13-23
13.3.11.2	Database Session-Based Application Contexts with LDAP	13-24
13.3.11.3	How Globally Initialized Database Session-Based Application Contexts Work	13-25
13.3.11.4	Initializing a Database Session-Based Application Context Globally	13-26
13.3.12	Externalized Database Session-Based Application Contexts	13-27
13.4	Global Application Contexts	13-28
13.4.1	About Global Application Contexts	13-28
13.4.2	Uses for Global Application Contexts	13-29
13.4.3	Components of a Global Application Context	13-29
13.4.4	Global Application Contexts in an Oracle Real Application Clusters Environment	13-30
13.4.5	Creating Global Application Contexts	13-30
13.4.5.1	Ownership of the Global Application Context	13-30
13.4.5.2	Creating a Global Application Context	13-30
13.4.6	PL/SQL Package to Manage a Global Application Context	13-31
13.4.6.1	About the Package That Manages the Global Application Context	13-31
13.4.6.2	How Editions Affects the Results of a Global Application Context PL/SQL Package	13-32

13.4.6.3	DBMS_SESSION.SET_CONTEXT username and client_id Parameters	13-32
13.4.6.4	Sharing Global Application Context Values for All Database Users	13-33
13.4.6.5	Example: Package to Manage Global Application Values for All Database Users	13-34
13.4.6.6	Global Contexts for Database Users Who Move Between Applications	13-35
13.4.6.7	Global Application Context for Nondatabase Users	13-36
13.4.6.8	Example: Package to Manage Global Application Context Values for Nondatabase Users	13-37
13.4.6.9	Clearing Session Data When the Session Closes	13-39
13.4.7	Embedding Calls in Middle-Tier Applications to Manage the Client Session ID	13-40
13.4.7.1	About Managing Client Session IDs Using a Middle-Tier Application	13-40
13.4.7.2	Step 1: Retrieve the Client Session ID Using a Middle-Tier Application	13-40
13.4.7.3	Step 2: Set the Client Session ID Using a Middle-Tier Application	13-41
13.4.7.4	Step 3: Clear the Session Data Using a Middle-Tier Application	13-43
13.4.8	Tutorial: Creating a Global Application Context That Uses a Client Session ID	13-43
13.4.8.1	About This Tutorial	13-44
13.4.8.2	Step 1: Create User Accounts	13-44
13.4.8.3	Step 2: Create the Global Application Context	13-44
13.4.8.4	Step 3: Create a Package for the Global Application Context	13-45
13.4.8.5	Step 4: Test the Newly Created Global Application Context	13-46
13.4.8.6	Step 5: Modify the Session ID and Test the Global Application Context Again	13-47
13.4.8.7	Step 6: Remove the Components of This Tutorial	13-48
13.4.9	Global Application Context Processes	13-48
13.4.9.1	Simple Global Application Context Process	13-48
13.4.9.2	Global Application Context Process for Lightweight Users	13-49
13.5	Using Client Session-Based Application Contexts	13-51
13.5.1	About Client Session-Based Application Contexts	13-52
13.5.2	Setting a Value in the CLIENTCONTEXT Namespace	13-52
13.5.3	Retrieving the CLIENTCONTEXT Namespace	13-53
13.5.4	Example: Retrieving a Client Session ID Value for Client Session-Based Contexts	13-53
13.5.5	Clearing a Setting in the CLIENTCONTEXT Namespace	13-54
13.5.6	Clearing All Settings in the CLIENTCONTEXT Namespace	13-54
13.6	Application Context Data Dictionary Views	13-54

14 Using Oracle Virtual Private Database to Control Data Access

14.1	About Oracle Virtual Private Database	14-1
14.1.1	What Is Oracle Virtual Private Database?	14-2
14.1.2	Benefits of Using Oracle Virtual Private Database Policies	14-3
14.1.2.1	Security Policies Based on Database Objects Rather Than Applications	14-3
14.1.2.2	Control Over How Oracle Database Evaluates Policy Functions	14-3

14.1.3	Who Can Create Oracle Virtual Private Database Policies?	14-4
14.1.4	Privileges to Run Oracle Virtual Private Database Policy Functions	14-4
14.1.5	Oracle Virtual Private Database Use with an Application Context	14-4
14.1.6	Oracle Virtual Private Database in a Multitenant Environment	14-5
14.2	Components of an Oracle Virtual Private Database Policy	14-6
14.2.1	Function to Generate the Dynamic WHERE Clause	14-6
14.2.2	Policies to Attach the Function to the Objects You Want to Protect	14-8
14.3	Configuration of Oracle Virtual Private Database Policies	14-8
14.3.1	About Oracle Virtual Private Database Policies	14-9
14.3.2	Attaching a Policy to a Database Table, View, or Synonym	14-10
14.3.3	Example: Attaching a Simple Oracle Virtual Private Database Policy to a Table	14-11
14.3.4	Enforcing Policies on Specific SQL Statement Types	14-11
14.3.5	Example: Specifying SQL Statement Types with DBMS_RLS.ADD_POLICY	14-12
14.3.6	Control of the Display of Column Data with Policies	14-12
14.3.6.1	Policies for Column-Level Oracle Virtual Private Database	14-12
14.3.6.2	Example: Creating a Column-Level Oracle Virtual Private Database Policy	14-13
14.3.6.3	Display of Only the Column Rows Relevant to the Query	14-13
14.3.6.4	Column Masking to Display Sensitive Columns as NULL Values	14-14
14.3.6.5	Example: Adding Column Masking to an Oracle Virtual Private Database Policy	14-15
14.3.7	Oracle Virtual Private Database Policy Groups	14-16
14.3.7.1	About Oracle Virtual Private Database Policy Groups	14-16
14.3.7.2	Creation of a New Oracle Virtual Private Database Policy Group	14-17
14.3.7.3	Default Policy Group with the SYS_DEFAULT Policy Group	14-17
14.3.7.4	Multiple Policies for Each Table, View, or Synonym	14-18
14.3.7.5	Validation of the Application Used to Connect to the Database	14-18
14.3.8	Optimizing Performance by Using Oracle Virtual Private Database Policy Types	14-19
14.3.8.1	About Oracle Virtual Private Database Policy Types	14-20
14.3.8.2	Dynamic Policy Type to Automatically Rerun Policy Functions	14-20
14.3.8.3	Example: Creating a DYNAMIC Policy with DBMS_RLS.ADD_POLICY	14-21
14.3.8.4	Static Policy to Prevent Policy Functions from Rerunning for Each Query	14-21
14.3.8.5	Example: Creating a Static Policy with DBMS_RLS.ADD_POLICY	14-22
14.3.8.6	Example: Shared Static Policy to Share a Policy with Multiple Objects	14-22
14.3.8.7	When to Use Static and Shared Static Policies	14-23
14.3.8.8	Context-Sensitive Policy for Application Context Attributes That Change	14-23
14.3.8.9	Example: Creating a Context-Sensitive Policy with DBMS_RLS.ADD_POLICY	14-24
14.3.8.10	Example: Refreshing Cached Statements for a VPD Context-Sensitive Policy	14-24
14.3.8.11	Example: Altering an Existing Context-Sensitive Policy	14-25
14.3.8.12	Example: Using a Shared Context Sensitive Policy to Share a Policy with Multiple Objects	14-25

14.3.8.13	When to Use Context-Sensitive and Shared Context-Sensitive Policies	14-26
14.3.8.14	Summary of the Five Oracle Virtual Private Database Policy Types	14-26
14.4	Tutorials: Creating Oracle Virtual Private Database Policies	14-27
14.4.1	Tutorial: Creating a Simple Oracle Virtual Private Database Policy	14-27
14.4.1.1	About This Tutorial	14-28
14.4.1.2	Step 1: Ensure That the OE User Account Is Active	14-28
14.4.1.3	Step 2: Create a Policy Function	14-28
14.4.1.4	Step 3: Create the Oracle Virtual Private Database Policy	14-29
14.4.1.5	Step 4: Test the Policy	14-30
14.4.1.6	Step 5: Remove the Components of This Tutorial	14-30
14.4.2	Tutorial: Implementing a Session-Based Application Context Policy	14-31
14.4.2.1	About This Tutorial	14-31
14.4.2.2	Step 1: Create User Accounts and Sample Tables	14-31
14.4.2.3	Step 2: Create a Database Session-Based Application Context	14-33
14.4.2.4	Step 3: Create a PL/SQL Package to Set the Application Context	14-33
14.4.2.5	Step 4: Create a Logon Trigger to Run the Application Context PL/SQL Package	14-34
14.4.2.6	Step 5: Test the Logon Trigger	14-35
14.4.2.7	Step 6: Create a PL/SQL Policy Function to Limit User Access to Their Orders	14-35
14.4.2.8	Step 7: Create the New Security Policy	14-35
14.4.2.9	Step 8: Test the New Policy	14-36
14.4.2.10	Step 9: Remove the Components of This Tutorial	14-37
14.4.3	Tutorial: Implementing an Oracle Virtual Private Database Policy Group	14-37
14.4.3.1	About This Tutorial	14-38
14.4.3.2	Step 1: Create User Accounts and Other Components for This Tutorial	14-38
14.4.3.3	Step 2: Create the Two Policy Groups	14-39
14.4.3.4	Step 3: Create PL/SQL Functions to Control the Policy Groups	14-40
14.4.3.5	Step 4: Create the Driving Application Context	14-41
14.4.3.6	Step 5: Add the PL/SQL Functions to the Policy Groups	14-42
14.4.3.7	Step 6: Test the Policy Groups	14-42
14.4.3.8	Step 7: Remove the Components of This Tutorial	14-43
14.5	How Oracle Virtual Private Database Works with Other Oracle Features	14-44
14.5.1	Oracle Virtual Private Database Policies with Editions	14-44
14.5.2	SELECT FOR UPDATE Statement in User Queries on VPD-Protected Tables	14-45
14.5.3	Oracle Virtual Private Database Policies and Outer or ANSI Joins	14-45
14.5.4	Oracle Virtual Private Database Security Policies and Applications	14-45
14.5.5	Automatic Reparsing for Fine-Grained Access Control Policies Functions	14-46
14.5.6	Oracle Virtual Private Database Policies and Flashback Queries	14-46
14.5.7	Oracle Virtual Private Database and Oracle Label Security	14-46
14.5.7.1	Using Oracle Virtual Private Database to Enforce Oracle Label Security Policies	14-47
14.5.7.2	Oracle Virtual Private Database and Oracle Label Security Exceptions	14-47

14.5.8	Export of Data Using the EXPDP Utility access_method Parameter	14-48
14.5.9	Oracle Virtual Private Database Policies and Oracle Flashback Time Travel	14-49
14.5.10	User Models and Oracle Virtual Private Database	14-52
14.5.11	Oracle Virtual Private Database and JSON	14-53
14.6	Oracle Virtual Private Database Data Dictionary Views	14-53

15 Using Transparent Sensitive Data Protection

15.1	About Transparent Sensitive Data Protection	15-2
15.2	General Steps for Using Transparent Sensitive Data Protection	15-2
15.3	Benefits of Transparent Sensitive Data Protection Policies	15-3
15.4	Privileges Required for Using Transparent Sensitive Data Protection	15-4
15.5	How a Multitenant Environment Affects Transparent Sensitive Data Protection	15-4
15.6	Creating Transparent Sensitive Data Protection Policies	15-5
15.6.1	Step 1: Create a Sensitive Type	15-6
15.6.2	Step 2: Identify the Sensitive Columns to Protect	15-6
15.6.3	Step 3: Import the Sensitive Columns List from ADM into Your Database	15-7
15.6.4	Step 4: Create the Transparent Sensitive Data Protection Policy	15-7
15.6.4.1	About Creating the Transparent Sensitive Data Protection Policy	15-8
15.6.4.2	Creating the Transparent Sensitive Data Protection Policy	15-8
15.6.4.3	Setting the Oracle Data Redaction or Virtual Private Database Feature Options	15-9
15.6.4.4	Setting Conditions for the Transparent Sensitive Data Protection Policy	15-10
15.6.4.5	Specifying the DBMS_TSDP_PROTECT.ADD_POLICY Procedure	15-10
15.6.5	Step 5: Associate the Policy with a Sensitive Type	15-11
15.6.6	Step 6: Enable the Transparent Sensitive Data Protection Policy	15-12
15.6.6.1	Enabling Protection for the Current Database in a Protected Source	15-12
15.6.6.2	Enabling Protection for a Specific Table Column	15-12
15.6.6.3	Enabling Protection for a Specific Column Type	15-13
15.6.7	Step 7: Optionally, Export the Policy to Other Databases	15-13
15.7	Altering Transparent Sensitive Data Protection Policies	15-13
15.8	Disabling Transparent Sensitive Data Protection Policies	15-14
15.9	Dropping Transparent Sensitive Data Protection Policies	15-15
15.10	Using the Predefined REDACT_AUDIT Policy for Redaction	15-16
15.10.1	About the REDACT_AUDIT Policy	15-17
15.10.2	Variables Associated with Sensitive Columns	15-17
15.10.2.1	About Variables Associated with Sensitive Columns	15-17
15.10.2.2	Bind Variables and Sensitive Columns in the Expressions of Conditions	15-18
15.10.2.3	A Bind Variable and a Sensitive Column Appearing in the Same SELECT Item	15-19
15.10.2.4	Bind Variables in Expressions Assigned to Sensitive Columns in INSERT or UPDATE Operations	15-19
15.10.3	How Bind Variables on Sensitive Columns Behave with Views	15-20

15.10.4	Disabling the REDACT_AUDIT Policy	15-20
15.10.5	Enabling the REDACT_AUDIT Policy	15-20
15.11	Transparent Sensitive Data Protection Policies with Data Redaction	15-21
15.12	Using Transparent Sensitive Data Protection Policies with Oracle VPD Policies	15-21
15.12.1	About Using TSDP Policies with Oracle Virtual Private Database Policies	15-22
15.12.2	DBMS_RLS.ADD_POLICY Parameters That Are Used for TSDP Policies	15-22
15.12.3	Tutorial: Creating a TSDP Policy That Uses Virtual Private Database Protection	15-24
15.12.3.1	Step 1: Create the hr_appuser User Account	15-24
15.12.3.2	Step 2: Identify the Sensitive Columns	15-25
15.12.3.3	Step 3: Create an Oracle Virtual Private Database Function	15-25
15.12.3.4	Step 4: Create and Enable a Transparent Sensitive Data Protection Policy	15-25
15.12.3.5	Step 5: Test the Transparent Sensitive Data Protection Policy	15-26
15.12.3.6	Step 6: Remove the Components of This Tutorial	15-27
15.13	Using Transparent Sensitive Data Protection Policies with Unified Auditing	15-28
15.13.1	About Using TSDP Policies with Unified Audit Policies	15-28
15.13.2	Unified Audit Policy Settings That Are Used with TSDP Policies	15-29
15.14	Using Transparent Sensitive Data Protection Policies with Fine-Grained Auditing	15-30
15.14.1	About Using TSDP Policies with Fine-Grained Auditing	15-30
15.14.2	Fine-Grained Auditing Parameters That Are Used with TSDP Policies	15-31
15.15	Using Transparent Sensitive Data Protection Policies with TDE Column Encryption	15-32
15.15.1	About Using TSDP Policies with TDE Column Encryption	15-33
15.15.2	TDE Column Encryption ENCRYPT Clause Settings Used with TSDP Policies	15-34
15.16	Transparent Sensitive Data Protection Data Dictionary Views	15-35

16 Encryption of Sensitive Credential Data in the Data Dictionary

16.1	About Encrypting Sensitive Credential Data in the Data Dictionary	16-1
16.2	How the Multitenant Option Affects the Encryption of Sensitive Data	16-2
16.3	Encrypting Sensitive Credential Data in System Tables	16-2
16.4	Rekeying Sensitive Credential Data in the SYS.LINK\$ System Table	16-3
16.5	Deleting Sensitive Credential Data in System Tables	16-4
16.6	Restoring the Functioning of Database Links After a Lost Keystore	16-5
16.7	Data Dictionary Views for Encrypted Data Dictionary Credentials	16-6

17 Securing and Isolating Resources Using DbNest

17.1	About DbNest	17-1
17.2	How DbNest Works	17-1
17.2.1	Purpose of DbNest	17-2
17.2.2	Linux Namespaces	17-2
17.2.3	DbNest Properties	17-3

17.2.4	DbNest Architecture	17-4
17.2.5	User Interface for DbNest	17-5
17.2.5.1	DbNest Initialization Parameters	17-5
17.2.5.2	DbNest Configuration File	17-5
17.2.6	How Oracle Database Manages a Nest	17-7
17.3	Enabling DbNest	17-7
17.4	Configuring File System Isolation for a Database Nest	17-8

18 On-Demand Encryption of Data

18.1	About On-Demand Encryption of Data	18-1
18.2	Security Problems That Encryption Does Not Solve	18-2
18.2.1	Principle 1: Encryption Does Not Solve Access Control Problems	18-2
18.2.2	Principle 2: Encryption Does Not Protect Against a Malicious Administrator	18-3
18.2.3	Principle 3: Encrypting Everything Does Not Make Data Secure	18-4
18.3	Data Encryption Challenges	18-4
18.3.1	Encrypted Indexed Data	18-4
18.3.2	Generated Encryption Keys	18-5
18.3.3	Transmitted Encryption Keys	18-5
18.3.4	Storing Encryption Keys	18-6
18.3.4.1	About Storing Encryption Keys	18-6
18.3.4.2	Storage of Encryption Keys in the Database	18-6
18.3.4.3	Storage of Encryption Keys in the Operating System	18-7
18.3.4.4	Users Managing Their Own Encryption Keys	18-8
18.3.4.5	Manual Encryption with Transparent Database Encryption and Tablespace Encryption	18-8
18.3.5	Importance of Changing Encryption Keys	18-8
18.3.6	Encryption of Binary Large Objects	18-8
18.4	Data Encryption Storage with the DBMS_CRYPT0 Package	18-9
18.5	Asymmetric Key Operations with the DBMS_CRYPT0 Package	18-15
18.6	Examples of Using the Data Encryption API	18-15
18.6.1	Example: Data Encryption Procedure	18-16
18.6.2	Example: AES 256-Bit Data Encryption and Decryption Procedures	18-17
18.6.3	Example: Encryption and Decryption Procedures for BLOB Data	18-17
18.6.4	Example: Encrypting or Decrypting a Number String	18-21

Part IV Securing Data on the Network

19 Securing Data for Oracle Database Connections

20 Configuring Oracle Database Native Network Encryption and Data Integrity

20.1	About Oracle Database Native Network Encryption and Data Integrity	20-1
20.1.1	How Oracle Database Native Network Encryption and Integrity Works	20-2
20.1.2	Advanced Encryption Standard	20-2
20.1.3	Choosing Between Native Network Encryption and Transport Layer Security	20-2
20.2	Oracle Database Native Network Encryption Data Integrity	20-3
20.3	Data Encryption and Integrity sqlnet.ora Parameters	20-3
20.3.1	About the Data Encryption and Integrity Parameters	20-4
20.3.2	Sample sqlnet.ora File	20-5
20.4	Data Integrity Algorithms Support	20-6
20.5	Diffie-Hellman Based Key Negotiation	20-7
20.6	Configuration of Data Encryption and Integrity	20-7
20.6.1	About Activating Encryption and Integrity	20-8
20.6.2	About Negotiating Encryption and Integrity	20-8
20.6.2.1	About the Values for Negotiating Encryption and Integrity	20-9
20.6.2.2	REJECTED Configuration Parameter	20-10
20.6.2.3	ACCEPTED Configuration Parameter	20-10
20.6.2.4	REQUESTED Configuration Parameter	20-10
20.6.2.5	REQUIRED Configuration Parameter	20-11
20.6.3	Configuring Encryption and Integrity Parameters Using Oracle Net Manager	20-11
20.6.3.1	Configuring Encryption on the Client and the Server	20-11
20.6.3.2	Configuring Integrity on the Client and the Server	20-13
20.6.3.3	Enabling Both Oracle Native Encryption and SSL Authentication for Different Users Concurrently	20-14
20.7	Troubleshooting the Native Network Encryption Configuration	20-16
20.7.1	Checking if Native Network Encryption Is Enabled in the Current Session	20-16
20.7.2	ORA-12650 and ORA-12660 Errors in the Native Network Encryption Configuration	20-17

21 Configuring Transport Layer Security Encryption

21.1	Transport Layer Security (TLS) and the Oracle Database	21-1
21.1.1	Self-signed Certificate vs Public Certificate Authority (CA) Signed Certificate	21-2
21.1.2	One-way TLS vs Mutual TLS	21-2
21.1.3	TLS With or Without a Client Wallet	21-3
21.1.4	Certificate DN Matching	21-3
21.2	Configuring TLS for the Oracle Database and Client	21-4
21.2.1	About Configuring TLS for the Oracle Database	21-4
21.2.2	Configuring TLS Using a Public Certificate Authority Root of Trust for the Database Server Certificate	21-6
21.2.3	Configuring TLS with a Self-Signed Root Certificate	21-10

21.2.4	Configuring TLS Connection With a Client Wallet	21-16
21.2.5	Enabling Distinguished Name (DN) Matching	21-18
21.3	Advanced and Optional Configurations	21-20
21.3.1	Optional Parameters for Transport Layer Security	21-21
21.3.2	Mutual Transport Layer Security (mTLS)	21-23
21.3.2.1	Server Certificate DN Matching	21-27
21.3.3	Oracle Wallet Location	21-28
21.3.3.1	Configuring Wallet Location for the Client	21-28
21.3.3.2	Configuring Wallet Location for the Listener	21-29
21.3.3.3	Configuring PDB Wallet Location for server	21-29
21.3.3.4	Oracle Wallet Search Order	21-30
21.3.4	Enable Weak DN Matching	21-32
21.3.5	Private Key/Certificate Selection	21-33
21.3.5.1	Setting the SSL_CERTIFICATE_ALIAS Parameter	21-33
21.3.5.2	Setting the SSL_CERTIFICATE_THUMBPRINT Parameter	21-34
21.3.5.3	Setting the SSL_EXTENDED_KEY_USAGE Parameter	21-35
21.3.6	Transport Layer Security Encryption Combined with Authentication Methods	21-35
21.3.7	Specifying TLS Protocol and TLS Cipher Suites	21-37
21.3.7.1	Configuring TLS Protocol Versions	21-37
21.3.7.2	Configuring TLS Cipher Suites	21-38
21.3.7.3	Allowing Certificates from Earlier Algorithms	21-41
21.3.8	Certificate Validation with Certificate Revocation Lists	21-41
21.3.8.1	About Certificate Validation with Certificate Revocation Lists	21-42
21.3.8.2	What CRLs Should You Use?	21-42
21.3.8.3	How CRL Checking Works	21-42
21.3.8.4	Configuring Certificate Validation with Certificate Revocation Lists	21-44
21.3.8.5	Certificate Revocation List Management	21-45
21.3.8.6	Troubleshooting CRL Certificate Validation	21-50
21.3.8.7	Oracle Net Tracing File Error Messages Associated with Certificate Validation	21-50
21.4	TLS and Other Oracle Products	21-52
21.4.1	Transport Layer Security Connections in an Oracle Real Application Clusters Environment	21-52
21.4.1.1	Step 1: Configure TCPS Protocol Endpoints	21-53
21.4.1.2	Step 2: Ensure That the LOCAL_LISTENER Parameter Is Correctly Set on Each Node	21-54
21.4.1.3	Step 3: Create Transport Layer Security Wallets and Certificates	21-55
21.4.1.4	Step 4: Create a Wallet in Each Node of the Oracle RAC Cluster	21-57
21.4.1.5	Step 5: Define Wallet Locations in the listener.ora and sqlnet.ora Files	21-58
21.4.1.6	Step 6: Restart the Database Instances and Listeners	21-58
21.4.1.7	Step 7: Test the Cluster Node Configuration	21-59
21.4.1.8	Step 8: Test the Remote Client Configuration	21-59
21.5	Troubleshooting the Transport Layer Security Configuration	21-60

Part V Managing Strong Authentication

22 Introduction to Strong Authentication

22.1	What Is Strong Authentication?	22-1
22.2	Centralized Authentication and Single Sign-On	22-2
22.3	How Centralized Network Authentication Works	22-2
22.4	Supported Strong Authentication Methods	22-3
22.4.1	About Kerberos	22-4
22.4.2	About Remote Authentication Dial-In User Service (RADIUS)	22-4
22.4.3	About Transport Layer Security	22-5
22.5	Oracle Database Native Network Encryption/Strong Authentication Architecture	22-6
22.6	System Requirements for Strong Authentication	22-7
22.7	Oracle Database Native Network Encryption and Strong Authentication Restrictions	22-8

23 Strong Authentication Administration Tools

23.1	About the Configuration and Administration Tools	23-1
23.2	Native Network Encryption and Strong Authentication Configuration Tools	23-1
23.2.1	About Oracle Net Manager	23-1
23.2.2	Kerberos Adapter Command-Line Utilities	23-2
23.3	orapki Utility for Public Key Infrastructure Credentials Management	23-3
23.4	Duties of Strong Authentication Administrators	23-3

24 Configuring Kerberos Authentication

24.1	Introduction to Kerberos on Oracle Database	24-1
24.1.1	Kerberos Components in a Typical Oracle Database Configuration	24-2
24.1.2	Tickets Used in the Kerberos Configuration	24-2
24.1.2.1	Kerberos Client Ticket Granting Ticket	24-2
24.1.2.2	Kerberos Client Service Ticket	24-4
24.1.3	Kerberos Server Key Distribution Center	24-4
24.1.4	How Oracle Database Works with Kerberos	24-5
24.1.5	Oracle Database Parameters Used in a Kerberos Configuration	24-5
24.1.6	How Authentication Works in an Oracle Database Kerberos Configuration	24-6
24.2	Enabling Kerberos Authentication	24-8
24.2.1	Step 1: Install Kerberos	24-9
24.2.2	Step 2: Configure a Service Principal for an Oracle Database Server	24-10
24.2.3	Step 3: Extract a Service Key Table from Kerberos	24-11
24.2.4	Step 4: Install an Oracle Database Server and an Oracle Client	24-11

24.2.5	Step 5: Configure Oracle Net Services and Oracle Database	24-12
24.2.6	Step 6: Configure Kerberos Authentication	24-12
24.2.6.1	Step 6A: Configure Kerberos on the Client and on the Database Server	24-12
24.2.6.2	Step 6B: Set the Initialization Parameters	24-13
24.2.6.3	Step 6C: Set sqlnet.ora Parameters (Optional)	24-14
24.2.6.4	Step 6D: Configure Kerberos to Use TCP or UDP (Optional)	24-15
24.2.7	Step 7: Create a Kerberos User	24-16
24.2.8	Step 8: Create an Externally Authenticated Oracle User	24-16
24.2.9	Step 9: Get an Initial Ticket for the Kerberos/Oracle User	24-17
24.3	Utilities for the Kerberos Authentication Adapter	24-17
24.3.1	okinit Utility Options for Obtaining the Initial Ticket	24-18
24.3.2	oklist Utility Options for Displaying Credentials	24-19
24.3.3	okdstry Utility Options for Removing Credentials from the Cache File	24-20
24.3.4	okcreate Utility Options for Automatic Keytab Creation	24-21
24.4	Connecting to an Oracle Database Server Authenticated by Kerberos	24-21
24.5	Configuring Interoperability with Microsoft Windows Server Domain Controller KDC	24-22
24.5.1	About Configuring Interoperability with a Microsoft Windows Server Domain Controller KDC	24-22
24.5.2	Step 1: Configure Oracle Kerberos Client for Microsoft Windows Server Domain Controller	24-22
24.5.2.1	Step 1A: Create the Client Kerberos Configuration Files	24-23
24.5.2.2	Step 1B: Specify the Oracle Configuration Parameters in the sqlnet.ora File	24-23
24.5.2.3	Step 1C: Optionally, Specify Additional Kerberos Principals Using tnsnames.ora	24-24
24.5.2.4	Step 1D: Specify the Listening Port Number	24-24
24.5.3	Step 2: Configure a Microsoft Windows Server Domain Controller KDC for the Oracle Client	24-25
24.5.3.1	Step 2A: Create the User Account	24-25
24.5.3.2	Step 2B: Create the Oracle Database Principal User Account and Keytab	24-25
24.5.4	Step 3: Configure Oracle Database for a Microsoft Windows Server Domain Controller KDC	24-26
24.5.4.1	Step 3A: Set Configuration Parameters in the sqlnet.ora File	24-26
24.5.4.2	Step 3B: Create an Externally Authenticated Oracle User	24-27
24.5.5	Step 4: Obtain an Initial Ticket for the Kerberos/Oracle User	24-27
24.6	Configuring Kerberos Authentication Fallback Behavior	24-28
24.7	Troubleshooting the Oracle Kerberos Authentication Configuration	24-28
24.7.1	Common Kerberos Configuration Problems	24-28
24.7.2	ORA-12631 Errors in the Kerberos Configuration	24-29
24.7.3	ORA-28575 Errors in the Kerberos Configuration	24-29
24.7.4	ORA-01017 Errors in the Kerberos Configuration	24-30
24.7.5	Enabling Tracing for Kerberos okinit Operations	24-31

25 Configuring PKI Certificate Authentication

25.1	How Oracle Database Uses Transport Layer Security for Authentication	25-1
25.2	Enabling Oracle Internet Directory to Use Transport Layer Security Authentication	25-2
25.3	Configuring User Authentication with Transport Layer Security	25-3
25.4	Configuring Transport Layer Security for Client Authentication and Encryption with X.509 Certificates	25-5
25.4.1	About Configuring TLS for Client Authentication and Encryption with X.509 Certificates	25-5
25.4.2	Configuring the Server for Authentication and Encryption with X.509 Certificates	25-5
25.4.2.1	Step 1: Create and Configure the Server Wallet for the X.509 Certificate	25-6
25.4.2.2	Step 2: Shut Down the Oracle Listener on the Server	25-7
25.4.2.3	Step 3: Configure the sqlnet.ora File on the Server	25-8
25.4.2.4	Step 4: For Logical Volume Management, Configure the Server listener.ora File	25-8
25.4.2.5	Step 5: For Grid Infrastructure, Configure the Server Listener Process	25-9
25.4.2.6	Step 6: Set Initialization Parameters on the Server	25-10
25.4.2.7	Step 7: Create an External Database User on the Server	25-10
25.4.2.8	Step 8: Restart and Check the Listener Process on the Server	25-10
25.4.3	Configuring the Client for Authentication and Encryption with X.509 Certificates	25-11
25.4.3.1	Step 1: Configure the sqlnet.ora File on the Client	25-11
25.4.3.2	Step 2: Configure the tnsnames.ora File on the Client	25-12
25.4.3.3	Step 3: Configure Microsoft Certificate Store on the Client	25-12
25.5	Configuring Email over Transport Layer Security with an Oracle Wallet	25-16
25.6	Troubleshooting Transport Layer Security Errors	25-22
25.6.1	Step 1: Check the TLS Connection with the tnsping Utility	25-22
25.6.2	Step 2: Check the SSL_VERSION Parameter	25-23
25.6.3	Step 3: Check the Wallet File Permissions	25-23
25.6.4	Step 4: Check the Wallet Settings in the sqlnet.ora and listener.ora Files	25-24
25.6.5	Step 5: Enable Tracing for the SQL*Net and Listener Connections	25-25

26 Configuring RADIUS Authentication

26.1	About Configuring RADIUS Authentication	26-1
26.2	RADIUS Components	26-3
26.3	RADIUS Authentication Modes	26-3
26.3.1	Synchronous Authentication Mode	26-3
26.3.1.1	Sequence for Synchronous Authentication Mode	26-4
26.3.1.2	Example: Synchronous Authentication with Tokens	26-4
26.3.2	Challenge-Response (Asynchronous) Authentication Mode	26-5
26.3.2.1	Sequence for Challenge-Response (Asynchronous) Authentication Mode	26-5
26.3.2.2	Example: Asynchronous Authentication with Tokens	26-7

26.4	RADIUS Parameters	26-7
26.4.1	RADIUS Parameters for Clients and Servers	26-7
26.4.2	Minimum RADIUS Parameters	26-8
26.4.3	Initialization File Parameter for RADIUS	26-8
26.5	Enabling RADIUS Authentication, Authorization, and Accounting	26-9
26.5.1	Step 1: Configure RADIUS Authentication	26-9
26.5.1.1	Step 1A: Configure RADIUS on the Oracle Client	26-9
26.5.1.2	Step 1B: Configure RADIUS on the Oracle Database Server	26-10
26.5.1.3	Step 1C: Configure Additional RADIUS Features	26-13
26.5.2	Step 2: Create a User and Grant Access	26-15
26.5.3	Step 3: Configure External RADIUS Authorization (Optional)	26-16
26.5.3.1	Step 3A: Configure the Oracle Server (RADIUS Client)	26-16
26.5.3.2	Step 3B: Configure the Oracle Client Where Users Log In	26-16
26.5.3.3	Step 3C: Configure the RADIUS Server	26-16
26.5.4	Step 4: Configure RADIUS Accounting	26-17
26.5.4.1	Step 4A: Set RADIUS Accounting on the Oracle Database Server	26-18
26.5.4.2	Step 4B: Configure the RADIUS Accounting Server	26-18
26.5.5	Step 5: Add the RADIUS Client Name to the RADIUS Server Database	26-18
26.5.6	Step 6: Configure the Authentication Server for Use with RADIUS	26-19
26.5.7	Step 7: Configure the RADIUS Server for Use with the Authentication Server	26-19
26.5.8	Step 8: Configure Mapping Roles	26-19
26.6	Using RADIUS to Log in to a Database	26-20
26.7	Integrating Authentication Devices Using RADIUS	26-20
26.7.1	About the RADIUS Challenge-Response User Interface	26-20
26.7.2	Customizing the RADIUS Challenge-Response User Interface	26-21
26.7.3	Example: Using the OracleRadiusInterface Interface	26-21

27 Customizing the Use of Strong Authentication

27.1	Connecting to a Database Using Strong Authentication	27-1
27.2	Disabling Strong Authentication and Native Network Encryption	27-2
27.3	Configuring Multiple Authentication Methods	27-4
27.4	Configuring Oracle Database for External Authentication	27-5
27.4.1	Setting the SQLNET.AUTHENTICATION_SERVICES Parameter in sqlnet.ora	27-5
27.4.2	Setting OS_AUTHENT_PREFIX to a Null Value	27-6

Part VI Monitoring Database Activity with Auditing

28 Introduction to Auditing

28.1	What Is Auditing?	28-1
28.2	Why Is Auditing Used?	28-3

28.3	Best Practices for Auditing	28-4
28.4	Unified Auditing and Its Benefits	28-5
28.5	Who Can Perform Auditing?	28-6
28.6	Handling the Desupport of Traditional Auditing	28-8
28.7	Unified Auditing in a Multitenant Environment	28-9
28.8	Auditing in a Distributed Database	28-10

29 Provisioning Audit Policies

29.1	Getting Started with Auditing	29-1
29.2	About Audit Policies	29-2
29.3	Activities That Are Mandatorily Audited	29-3
29.4	Auditing Activities with the Predefined Unified Audit Policies	29-4
29.4.1	About Auditing Activities with the Predefined Unified Audit Policies	29-5
29.4.2	Secure Options Predefined Unified Audit Policy	29-6
29.4.3	Oracle Database Parameter Changes Predefined Unified Audit Policy	29-7
29.4.4	User Account and Privilege Management Predefined Unified Audit Policy	29-7
29.4.5	Center for Internet Security Recommendations Predefined Unified Audit Policy	29-8
29.4.6	Security Technical Implementation Guide Predefined Unified Audit Policies	29-9
29.4.6.1	STIG Recommendations Predefined Unified Audit Policy	29-9
29.4.6.2	All Top Level Actions Predefined Unified Audit Policy	29-10
29.4.6.3	Logon and Logout Predefined Unified Audit Policy	29-10
29.4.7	ORA_DICTIONARY Sensitive Column Queries Predefined Unified Audit Policy	29-11
29.4.8	Oracle Database Real Application Security Predefined Audit Policies	29-11
29.4.8.1	System Administrator Operations Predefined Unified Audit Policy	29-12
29.4.8.2	Session Operations Predefined Unified Audit Policy	29-12
29.4.9	Oracle Database Vault Predefined Unified Audit Policy for DVSYS and LBACSYS Schemas	29-13
29.4.10	Oracle Database Vault Predefined Unified Audit Policy for Default Realms and Command Rules	29-13
29.4.11	Oracle Label Security Predefined Unified Audit Policy for LBACSYS Objects	29-14
29.5	Steps to Provision Unified Audit Policies	29-14
29.5.1	Auditing Most Commonly Used Security-Relevant Activities	29-15
29.5.2	Auditing SQL Statements, Privileges, and Other Activities of Interest	29-15
29.5.3	Value-Based Fine-Grained Audit Activities	29-16
29.6	Common Audit Configurations Across All PDBs	29-16
29.7	General Audit Data Dictionary Views	29-17

30 Creating Custom Unified Audit Policies

30.1	About Custom Unified Audit Policies	30-1
30.2	Best Practices for Creating Custom Unified Audit Policies	30-2
30.3	Syntax for Creating a Custom Unified Audit Policy	30-2

30.4	Auditing Standard Oracle Database Components	30-4
30.4.1	Auditing Roles	30-5
30.4.1.1	About Role Auditing	30-5
30.4.1.2	Configuring Role Unified Audit Policies	30-5
30.4.1.3	Example: Auditing the Predefined Common DBA Role	30-6
30.4.2	Auditing System Privileges	30-6
30.4.2.1	About System Privilege Auditing	30-6
30.4.2.2	System Privileges That Can Be Audited	30-7
30.4.2.3	System Privileges That Cannot Be Audited	30-7
30.4.2.4	Configuring a Unified Audit Policy to Capture System Privilege Use	30-8
30.4.2.5	Example: Auditing a User Who Has ANY Privileges	30-8
30.4.2.6	Example: Using a Condition to Audit a System Privilege	30-8
30.4.2.7	How System Privilege Unified Audit Policies Appear in the Audit Trail	30-8
30.4.3	Auditing Administrative Users	30-9
30.4.3.1	Administrative User Accounts That Can Be Audited	30-9
30.4.3.2	Configuring a Unified Audit Policy to Capture Administrator Activities	30-10
30.4.3.3	Example: Auditing the SYS User	30-10
30.4.4	Auditing Object Actions	30-10
30.4.4.1	About Auditing Object Actions	30-11
30.4.4.2	Object Actions That Can Be Audited	30-11
30.4.4.3	Guidelines for Column Level Auditing and Virtual Columns	30-12
30.4.4.4	Configuring an Object Action Unified Audit Policy	30-13
30.4.4.5	Example: Auditing Actions on SYS Objects	30-13
30.4.4.6	Example: Auditing Multiple Actions on One Object	30-13
30.4.4.7	Example: Auditing GRANT and REVOKE Operations on an Object	30-13
30.4.4.8	Example: Auditing Both Actions and Privileges on an Object	30-14
30.4.4.9	Example: Auditing an Action on a Table Column	30-14
30.4.4.10	Example: Auditing All Actions on a Table	30-14
30.4.4.11	Example: Auditing All Actions in the Database	30-15
30.4.4.12	How Object Action Unified Audit Policies Appear in the Audit Trail	30-15
30.4.4.13	Auditing Functions, Procedures, Packages, and Triggers	30-16
30.4.4.14	Auditing of Oracle Virtual Private Database Predicates	30-16
30.4.4.15	Audit Policies for Oracle Virtual Private Database Policy Functions	30-18
30.4.4.16	Unified Auditing with Editioned Objects	30-18
30.4.5	Auditing the READ ANY TABLE and SELECT ANY TABLE Privileges	30-18
30.4.5.1	About Auditing the READ ANY TABLE and SELECT ANY TABLE Privileges	30-19
30.4.5.2	Creating a Unified Audit Policy to Capture READ Object Privilege Operations	30-19
30.4.5.3	How the Unified Audit Trail Captures READ ANY TABLE and SELECT ANY TABLE	30-19
30.4.6	Auditing Only Top-Level Statements	30-21
30.4.6.1	About Auditing Only Top-Level SQL Statements	30-22

30.4.6.2	Configuring a Unified Audit Policy to Capture Only Top-Level Statements	30-22
30.4.6.3	Example: Auditing Top-Level Statements	30-22
30.4.6.4	Example: Comparison of Top-Level SQL Statement Audits	30-23
30.4.6.5	How the Unified Audit Trail Captures Top-Level SQL Statements	30-28
30.5	Unified Auditing with Configurable Conditions	30-28
30.5.1	About Conditions in Unified Audit Policies	30-29
30.5.2	Configuring a Unified Audit Policy with a Condition	30-29
30.5.3	Example: Auditing Access to SQL*Plus	30-30
30.5.4	Example: Auditing Actions Not in Specific Hosts	30-31
30.5.5	Example: Auditing Both a System-Wide and a Schema-Specific Action	30-31
30.5.6	Example: Auditing a Condition Per Statement Occurrence	30-31
30.5.7	Example: Unified Audit Session ID of a Current Administrative User Session	30-32
30.5.8	Example: Unified Audit Session ID of a Current Non-Administrative User Session	30-32
30.5.9	How Audit Records from Conditions Appear in the Audit Trail	30-32
30.6	Auditing for Multitier or Multitenant Configurations	30-33
30.6.1	Auditing in a Multitier Deployment	30-33
30.6.2	Auditing in a Multitenant Deployment	30-35
30.6.2.1	About Local, CDB Common, and Application Common Audit Policies	30-36
30.6.2.2	Common Audit Configurations Across All PDBs	30-37
30.6.2.3	Unified Audit Policies in an Application Root	30-38
30.6.2.4	Configuring a Local Unified Audit Policy or Common Unified Audit Policy	30-38
30.6.2.5	Example: Local Unified Audit Policy	30-40
30.6.2.6	Example: CDB Common Unified Audit Policy	30-41
30.6.2.7	Example: Application Common Unified Audit Policy	30-41
30.6.2.8	How Local or Common Audit Policies or Settings Appear in the Audit Trail	30-42
30.7	Extending Unified Auditing to Capture Custom Attributes	30-42
30.7.1	About Auditing Application Context Values	30-43
30.7.2	Configuring Application Context Audit Settings	30-43
30.7.3	Disabling Application Context Audit Settings	30-44
30.7.4	Example: Auditing Application Context Values in a Default Database	30-44
30.7.5	Example: Auditing Application Context Values from Oracle Label Security	30-44
30.7.6	How Audited Application Contexts Appear in the Audit Trail	30-45
30.8	Auditing Components of Other Oracle Products and Features	30-45
30.8.1	Auditing Oracle SQL Firewall	30-46
30.8.1.1	About Auditing Oracle SQL Firewall	30-46
30.8.1.2	Example: Auditing Oracle SQL Firewall Violations	30-46
30.8.1.3	How Oracle SQL Firewall Events Appear in the Audit Trail	30-46
30.8.2	Auditing Oracle Database Vault Events	30-47
30.8.2.1	About Auditing Oracle Database Vault Events	30-48
30.8.2.2	Who Is Audited in Oracle Database Vault?	30-48
30.8.2.3	About Oracle Database Vault Unified Audit Trail Events	30-49

30.8.2.4	Oracle Database Vault Realm Audit Events	30-49
30.8.2.5	Oracle Database Vault Rule Set and Rule Audit Events	30-50
30.8.2.6	Oracle Database Vault Command Rule Audit Events	30-51
30.8.2.7	Oracle Database Vault Factor Audit Events	30-51
30.8.2.8	Oracle Database Vault Secure Application Role Audit Events	30-52
30.8.2.9	Oracle Database Vault Oracle Label Security Audit Events	30-53
30.8.2.10	Oracle Database Vault Oracle Data Pump Audit Events	30-53
30.8.2.11	Oracle Database Vault Enable and Disable Audit Events	30-54
30.8.2.12	Configuring a Unified Audit Policy for Oracle Database Vault	30-54
30.8.2.13	Example: Auditing an Oracle Database Vault Realm	30-55
30.8.2.14	Example: Auditing an Oracle Database Vault Rule Set	30-55
30.8.2.15	Example: Auditing Two Oracle Database Vault Events	30-55
30.8.2.16	Example: Auditing Oracle Database Vault Factors	30-55
30.8.2.17	How Oracle Database Vault Audited Events Appear in the Audit Trail	30-56
30.8.3	Auditing Oracle Database Real Application Security Events	30-56
30.8.3.1	About Auditing Oracle Database Real Application Security Events	30-57
30.8.3.2	Oracle Database Real Application Security Auditable Events	30-57
30.8.3.3	Oracle Database Real Application Security User, Privilege, and Role Audit Events	30-58
30.8.3.4	Oracle Database Real Application Security Security Class and ACL Audit Events	30-59
30.8.3.5	Oracle Database Real Application Security Session Audit Events	30-60
30.8.3.6	Oracle Database Real Application Security ALL Events	30-62
30.8.3.7	Configuring a Unified Audit Policy for Oracle Database Real Application Security	30-62
30.8.3.8	Example: Auditing Real Application Security User Account Modifications	30-62
30.8.3.9	Example: Using a Condition in a Real Application Security Unified Audit Policy	30-62
30.8.3.10	How Oracle Database Real Application Security Events Appear in the Audit Trail	30-63
30.8.4	Auditing Oracle Recovery Manager Events	30-63
30.8.4.1	About Auditing Oracle Recovery Manager Events	30-63
30.8.4.2	Oracle Recovery Manager Unified Audit Trail Events	30-64
30.8.4.3	How Oracle Recovery Manager Audited Events Appear in the Audit Trail	30-64
30.8.5	Auditing Oracle Label Security Events	30-65
30.8.5.1	About Auditing Oracle Label Security Events	30-65
30.8.5.2	Oracle Label Security Unified Audit Trail Events	30-66
30.8.5.3	Oracle Label Security Auditable User Session Labels	30-68
30.8.5.4	Configuring a Unified Audit Policy for Oracle Label Security	30-68
30.8.5.5	Example: Auditing Oracle Label Security Session Label Attributes	30-69
30.8.5.6	Example: Excluding a User from an Oracle Label Security Policy	30-69
30.8.5.7	Example: Auditing Oracle Label Security Policy Actions	30-69
30.8.5.8	Example: Querying for Audited OLS Session Labels	30-69

30.8.5.9	How Oracle Label Security Audit Events Appear in the Audit Trail	30-70
30.8.6	Auditing Oracle Data Pump Events	30-70
30.8.6.1	About Auditing Oracle Data Pump Events	30-71
30.8.6.2	Oracle Data Pump Unified Audit Trail Events	30-71
30.8.6.3	Configuring a Unified Audit Policy for Oracle Data Pump	30-71
30.8.6.4	Example: Auditing Oracle Data Pump Import Operations	30-71
30.8.6.5	Example: Auditing All Oracle Data Pump Operations	30-72
30.8.6.6	How Oracle Data Pump Audit Events Appear in the Audit Trail	30-72
30.8.7	Auditing Oracle SQL*Loader Direct Load Path Events	30-73
30.8.7.1	About Auditing in Oracle SQL*Loader Direct Path Load Events	30-73
30.8.7.2	Oracle SQL*Loader Direct Load Path Unified Audit Trail Events	30-73
30.8.7.3	Configuring a Unified Audit Trail Policy for Oracle SQL*Loader Direct Path Events	30-74
30.8.7.4	Example: Auditing Oracle SQL*Loader Direct Path Load Operations	30-74
30.8.7.5	How SQL*Loader Direct Path Load Audited Events Appear in the Audit Trail	30-74
30.8.8	Auditing Oracle XML DB HTTP and FTP Protocols	30-74
30.8.8.1	About Auditing Oracle XML DB HTTP and FTP Protocols	30-75
30.8.8.2	Configuring a Unified Audit Policy to Capture Oracle XML DB HTTP and FTP Protocols	30-75
30.8.8.3	Example: Auditing Failed Oracle XML DB HTTP Messages	30-75
30.8.8.4	Example: Auditing All Oracle XML DB FTP Messages	30-76
30.8.8.5	Example: Auditing Oracle XML DB HTTP Messages That Have 401 AUTH Errors	30-76
30.8.8.6	How the Unified Audit Trail Captures Oracle XML DB HTTP and FTP Protocol Messages	30-76
30.8.9	Auditing Oracle Machine Learning for SQL Events	30-77
30.8.9.1	About Auditing Oracle Machine Learning for SQL Events	30-77
30.8.9.2	Oracle Machine Learning for SQL Unified Audit Trail Events	30-77
30.8.9.3	Configuring a Unified Audit Policy for Oracle Machine Learning for SQL	30-78
30.8.9.4	Example: Auditing Multiple Oracle Machine Learning for SQL Operations by a User	30-78
30.8.9.5	Example: Auditing All Failed Oracle Machine Learning for SQL Operations by a User	30-78
30.8.9.6	How Oracle Machine Learning for SQL Events Appear in the Audit Trail	30-79
30.9	Managing Unified Audit Policies	30-80
30.9.1	Altering Unified Audit Policies	30-80
30.9.1.1	About Altering Unified Audit Policies	30-80
30.9.1.2	Altering a Unified Audit Policy	30-81
30.9.1.3	Example: Altering a Condition in a Unified Audit Policy	30-82
30.9.1.4	Example: Altering an Oracle Label Security Component in a Unified Audit Policy	30-82
30.9.1.5	Example: Altering Roles in a Unified Audit Policy	30-82
30.9.1.6	Example: Dropping a Condition from a Unified Audit Policy	30-83

30.9.1.7	Example: Altering an Existing Unified Audit Policy Top-Level Statement Audits	30-83
30.9.2	Enabling and Applying Unified Audit Policies to Users and Roles	30-83
30.9.2.1	About Enabling Unified Audit Policies	30-83
30.9.2.2	Enabling a Unified Audit Policy	30-85
30.9.2.3	Example: Enabling a Unified Audit Policy	30-85
30.9.3	Disabling Unified Audit Policies	30-86
30.9.3.1	About Disabling Unified Audit Policies	30-86
30.9.3.2	Disabling a Unified Audit Policy	30-86
30.9.3.3	Example: Disabling a Unified Audit Policy	30-87
30.9.4	Dropping Unified Audit Policies	30-87
30.9.4.1	About Dropping Unified Audit Policies	30-87
30.9.4.2	Dropping a Unified Audit Policy	30-88
30.9.4.3	Example: Disabling and Dropping a Unified Audit Policy	30-88
30.10	Tutorial: Auditing Nondatabase Users	30-88
30.10.1	Step 1: Create the User Accounts and Ensure the User OE Is Active	30-88
30.10.2	Step 2: Create the Unified Audit Policy	30-89
30.10.3	Step 3: Test the Policy	30-90
30.10.4	Step 4: Remove the Components of This Tutorial	30-91
30.11	Unified Audit Policy Data Dictionary Views	30-91

31 Value-Based Auditing with Fine-Grained Audit Policies

31.1	Overview of Fine-Grained Auditing	31-1
31.1.1	About Fine-Grained Auditing	31-2
31.1.2	Where Are Fine-Grained Audit Records Stored?	31-3
31.1.3	Who Can Perform Fine-Grained Auditing?	31-3
31.1.4	Fine-Grained Auditing on Tables or Views That Have Oracle VPD Policies	31-4
31.1.5	Fine-Grained Auditing in a Multitenant Environment	31-4
31.1.6	Fine-Grained Audit Policies with Editions	31-5
31.2	Creating Fine-Grained Audit Policies	31-6
31.2.1	About Creating a Fine-Grained Audit Policy	31-6
31.2.2	Syntax for Creating a Fine-Grained Audit Policy	31-7
31.2.3	Example: Using DBMS_FGA.ADD_POLICY to Create a Fine-Grained Audit Policy	31-9
31.2.4	Audits of Specific Columns and Rows	31-10
31.3	Managing Fine-Grained Audit Policies	31-10
31.3.1	Enabling a Fine-Grained Audit Policy	31-10
31.3.2	Disabling a Fine-Grained Audit Policy	31-11
31.3.3	Dropping a Fine-Grained Audit Policy	31-11
31.4	Tutorial: Adding an Email Alert to a Fine-Grained Audit Policy	31-12
31.4.1	About This Tutorial	31-12
31.4.2	Step 1: Install and Configure the UTL_MAIL PL/SQL Package	31-13

31.4.3	Step 2: Create User Accounts	31-14
31.4.4	Step 3: Configure an Access Control List File for Network Services	31-15
31.4.5	Step 4: Create the Email Security Alert PL/SQL Procedure	31-16
31.4.6	Step 5: Create and Test the Fine-Grained Audit Policy Settings	31-16
31.4.7	Step 6: Test the Alert	31-17
31.4.8	Step 7: Remove the Components of This Tutorial	31-18
31.5	Fine-Grained Audit Policy Data Dictionary Views	31-18

32 Administering the Audit Trail

32.1	Managing the Unified Audit Trail	32-1
32.1.1	How and Where Unified Audit Records Are Created	32-2
32.1.2	Sizing Recommendations for Unified Auditing	32-3
32.1.3	How Audit Trail Records Are Written to the AUDSYS Schema	32-3
32.1.4	Writing the Unified Audit Trail Records to SYSLOG or the Windows Event Viewer	32-4
32.1.4.1	About Writing the Unified Audit Trail Records to SYSLOG or the Windows Event Viewer	32-4
32.1.4.2	Enabling SYSLOG and Windows Event Viewer Captures for the Unified Audit Trail	32-5
32.1.5	How Unified Audit Records are Written to the Operating System	32-7
32.1.6	Moving Operating System Audit Records into the Unified Audit Trail	32-7
32.1.7	Improving the Performance of Queries and Purge Operations	32-8
32.1.8	Using Oracle Data Pump to Export and Import Unified Audit Trail Records	32-9
32.1.9	How Do Cursors Affect Auditing?	32-10
32.2	Archiving the Audit Trail	32-10
32.2.1	Archiving the Traditional Operating System Audit Trail	32-10
32.2.2	Archiving the Unified and Traditional Database Audit Trails	32-11
32.3	Purging Audit Trail Records	32-11
32.3.1	About Purging Audit Trail Records	32-12
32.3.2	Selecting an Audit Trail Purge Method	32-13
32.3.2.1	Purging the Audit Trail on a Regularly Scheduled Basis	32-13
32.3.2.2	Purging the Audit Trail on Demand	32-13
32.3.3	Scheduling an Automatic Purge Job for the Audit Trail	32-13
32.3.3.1	About Scheduling an Automatic Purge Job	32-14
32.3.3.2	Step 1: Ensure Online and Archive redo Log Sizes Are Tuned Appropriately	32-14
32.3.3.3	Step 2: Optionally, Set an Archive Timestamp for Audit Records	32-15
32.3.3.4	Step 3: Create and Schedule the Purge Job	32-17
32.3.4	Manually Purging the Audit Trail	32-18
32.3.4.1	About Manually Purging the Audit Trail	32-18
32.3.4.2	Using DBMS_AUDIT_MGMT.CLEAN_AUDIT_TRAIL to Manually Purge the Audit Trail	32-19

32.3.5	Other Audit Trail Purge Operations	32-21
32.3.5.1	Enabling or Disabling an Audit Trail Purge Job	32-21
32.3.5.2	Setting the Default Audit Trail Purge Job Interval for a Specified Purge Job	32-22
32.3.5.3	Deleting an Audit Trail Purge Job	32-22
32.3.5.4	Clearing the Archive Timestamp Setting	32-23
32.3.6	Example: Directly Calling a Unified Audit Trail Purge Operation	32-24
32.4	Audit Trail Management Data Dictionary Views	32-24

Part VII Appendixes

A Keeping Your Oracle Database Secure

A.1	About the Oracle Database Security Guidelines	A-2
A.2	Downloading Security Patches and Contacting Oracle Regarding Vulnerabilities	A-2
A.2.1	Downloading Security Patches and Workaround Solutions	A-2
A.2.2	Contacting Oracle Security Regarding Vulnerabilities in Oracle Database	A-2
A.3	Guidelines for Securing User Accounts and Privileges	A-3
A.4	Guidelines for Securing Passwords	A-7
A.5	Securing Authentication for Oracle Database Microsoft Windows Installations	A-10
A.6	Guidelines for Securing Roles	A-10
A.7	Guidelines for Securing Data	A-11
A.8	Guidelines for Securing the ORACLE_LOADER Access Driver	A-12
A.9	Guidelines for Securing a Database Installation and Configuration	A-13
A.10	Guideline for Securing Multitenant PDBs from the Root in a Linux Environment	A-14
A.11	Guidelines for Securing the Network	A-14
A.11.1	Client Connection Security	A-15
A.11.2	Network Connection Security	A-15
A.11.3	Transport Layer Security Connection Security	A-19
A.12	Guideline for Securing External Procedures	A-20
A.13	Guidelines for Auditing	A-20
A.13.1	Manageability of Audited Information	A-21
A.13.2	Audits of Typical Database Activity	A-21
A.13.3	Audits of Suspicious Database Activity	A-22
A.13.4	Audits of Sensitive Data	A-23
A.13.5	Recommended Audit Settings	A-23
A.13.6	Best Practices for Querying the UNIFIED_AUDIT_TRAIL Data Dictionary View	A-24
A.14	Addressing the CONNECT Role Change	A-25
A.14.1	Why Was the CONNECT Role Changed?	A-25
A.14.2	How the CONNECT Role Change Affects Applications	A-25
A.14.2.1	How the CONNECT Role Change Affects Database Upgrades	A-26
A.14.2.2	How the CONNECT Role Change Affects Account Provisioning	A-26

A.14.2.3	How the CONNECT Role Change Affects Applications Using New Databases	A-26
A.14.3	How the CONNECT Role Change Affects Users	A-26
A.14.3.1	How the CONNECT Role Change Affects General Users	A-27
A.14.3.2	How the CONNECT Role Change Affects Application Developers	A-27
A.14.3.3	How the CONNECT Role Change Affects Client Server Applications	A-27
A.14.4	Approaches to Addressing the CONNECT Role Change	A-27
A.14.4.1	Creating a New Database Role	A-28
A.14.4.2	Restoring the CONNECT Privilege	A-29
A.14.4.3	Data Dictionary View to Show CONNECT Grantees	A-29
A.14.4.4	Least Privilege Analysis Studies	A-30

B Managing Oracle Database Wallets and Certificates

B.1	Introduction to Oracle Database Wallets and Certificates	B-1
B.1.1	About Oracle Database Wallets	B-2
B.1.2	About Oracle Database Certificates	B-4
B.1.3	About Certificate Authority (CA)	B-5
B.1.4	Tools Used to Manage Oracle Database Wallets and Certificates	B-6
B.1.5	General Process of Managing Oracle Database Wallets and Certificates	B-6
B.1.6	Oracle Database Wallet Search Order	B-7
B.2	Managing Oracle Database Wallets and Certificates with the orapki Utility	B-8
B.2.1	About Managing Oracle Database Wallets and Certificates with the orapki Utility	B-8
B.2.2	orapki Utility Syntax	B-9
B.3	Managing Oracle Database Wallets	B-9
B.3.1	Creating a PKCS#12 Wallet	B-10
B.3.2	Importing a PKCS#12 Wallet	B-10
B.3.3	Creating an Auto-Login-Only Wallet	B-11
B.3.4	Creating a Local Auto-Login Wallet	B-11
B.3.5	Creating an Auto-Login Wallet That Is Associated with a PKCS#12 Wallet	B-11
B.3.6	Viewing a Wallet	B-12
B.3.7	Modifying the Password for a Wallet	B-12
B.3.8	Converting an Oracle Wallet to Use the AES256 Algorithm	B-13
B.3.9	Deleting a Wallet	B-13
B.4	Managing Oracle Database Certificates	B-14
B.4.1	Certificate Store Location for System Wallets	B-15
B.4.2	Adding a Certificate Request to an Oracle Wallet	B-15
B.4.3	Creating Signed Certificates	B-16
B.4.4	Creating a Signed Certificate Using a Self-Signed Root	B-17
B.4.5	Adding a Trusted Certificate to an Oracle Wallet	B-19
B.4.6	Adding a Root Certificate to an Oracle Wallet	B-19
B.4.7	Adding Root Certificate Authority That Requires an Intermediate Certificate Using Microsoft Internet Explorer	B-20

B.4.8	Adding a User Certificate to an Oracle Wallet	B-20
B.4.9	Verifying Credentials on the Hardware Device That Uses a PKCS#11 Wallet	B-20
B.4.10	Adding PKCS#11 Information to an Oracle Wallet	B-21
B.4.11	Viewing a Certificate	B-21
B.4.12	Controlling MD5 and SHA-1 Certificate Use	B-21
B.4.13	Certificate Import and Export Operations	B-22
B.4.13.1	Importing a User-Supplied or Trusted Certificate into an Oracle Wallet	B-22
B.4.13.2	Exporting Certificates and Certificate Requests from an Oracle Wallet	B-22
B.4.14	Management of Certificate Revocation Lists (CRLs) with orapki Utility	B-23
B.5	Examples of Creating Wallets and Certificates Using orapki	B-23
B.5.1	Example: Wallet with a Self-Signed Certificate and Export of the Certificate	B-24
B.5.2	Example: Creating a Wallet and a User Certificate	B-24
B.6	orapki Utility Commands Summary	B-25
B.6.1	orapki cert create	B-27
B.6.2	orapki cert display	B-28
B.6.3	orapki crl delete	B-28
B.6.4	orapki crl display	B-29
B.6.5	orapki crl hash	B-30
B.6.6	orapki crl list	B-30
B.6.7	orapki crl upload	B-31
B.6.8	orapki secretstore create_credential	B-31
B.6.9	orapki secretstore create_entry	B-32
B.6.10	orapki secretstore create_user_credential	B-33
B.6.11	orapki secretstore delete_credential	B-33
B.6.12	orapki secretstore delete_entry	B-34
B.6.13	orapki secretstore delete_user_credential	B-34
B.6.14	orapki secretstore list_credentials	B-35
B.6.15	orapki secretstore list_entries	B-35
B.6.16	orapki secretstore list_entries_unsorted	B-36
B.6.17	orapki secretstore modify_credential	B-36
B.6.18	orapki secretstore modify_entry	B-37
B.6.19	orapki secretstore modify_user_credential	B-37
B.6.20	orapki secretstore view_entry	B-38
B.6.21	orapki wallet add	B-38
B.6.22	orapki wallet change_pwd	B-41
B.6.23	orapki wallet convert	B-41
B.6.24	orapki wallet create	B-42
B.6.25	orapki wallet delete	B-42
B.6.26	orapki wallet display	B-43
B.6.27	orapki wallet export	B-43
B.6.28	orapki wallet export_private_key	B-44
B.6.29	orapki wallet import_pkcs12	B-45

B.6.30	orapki wallet import_private_key	B-45
B.6.31	orapki wallet jks_to_pkcs12	B-46
B.6.32	orapki wallet pkcs12_to_jks	B-46
B.6.33	orapki wallet remove	B-47
B.7	mkstore Utility Commands Summary	B-47
B.7.1	mkstore create	B-48
B.7.2	mkstore createALO	B-49
B.7.3	mkstore createCredential	B-49
B.7.4	mkstore createEntry	B-50
B.7.5	mkstore createUserCredential	B-50
B.7.6	mkstore delete	B-51
B.7.7	mkstore deleteCredential	B-51
B.7.8	mkstore deleteEntry	B-52
B.7.9	mkstore deleteSSO	B-52
B.7.10	mkstore deleteUserCredential	B-53
B.7.11	mkstore list	B-53
B.7.12	mkstore listCredential	B-54
B.7.13	mkstore modifyCredential	B-54
B.7.14	mkstore modifyEntry	B-55
B.7.15	mkstore modifyUserCredential	B-55
B.7.16	mkstore viewEntry	B-56

C Oracle Database FIPS 140-2 Settings

C.1	About the Oracle Database FIPS 140-2 Settings	C-1
C.2	Configuration of FIPS 140-2 Using the Consolidated FIPS_140 Parameter	C-2
C.2.1	About Configuration of FIPS 140-2 Using the FIPS_140 Parameter	C-3
C.2.2	Configuring the FIPS_140 Parameter	C-3
C.2.3	Running orapki in FIPS Mode	C-3
C.2.4	Configuring Standalone Java FIPS for Running Java Client Applications in FIPS Mode	C-4
C.2.5	Enabling FIPS by Running the enable_fips.py Python Script	C-4
C.2.6	FIPS-Supported Algorithms for Transparent Data Encryption	C-4
C.2.7	FIPS-Supported Cipher Suites for DBMS_CRYPTO	C-5
C.2.8	FIPS-Supported Cipher Suites for Transport Layer Security	C-6
C.2.9	FIPS-Supported Algorithms for Network Native Encryption	C-7
C.3	Legacy FIPS 140-2 Configurations	C-7
C.3.1	About Legacy FIPS 140-2 Configurations	C-8
C.3.2	Configuring FIPS 140-2 for Transparent Data Encryption and DBMS_CRYPTO	C-8
C.3.3	Configuring FIPS 140-2 for Transport Layer Security	C-9
C.3.4	Configuring FIPS 140-2 for Native Network Encryption	C-9
C.4	Postinstallation Checks for FIPS 140-2	C-10

C.5	Verifying FIPS 140-2 Connections	C-10
C.5.1	Verifying FIPS 140-2 Connections When Using the FIPS_140 Parameter	C-10
C.5.2	Verifying FIPS 140-2 Connections for Transport Layer Security	C-11
C.5.3	Verifying FIPS 140-2 Connections for Network Native Encryption	C-11
C.5.4	Verifying FIPS 140-2 Connections for Transparent Data Encryption and DBMS_CRYPTO	C-11
C.6	Managing Deprecated Weaker Algorithm Keys	C-12

D Considerations for Transitioning from Traditional to Unified Auditing

Glossary

Index

Preface

Welcome to *Oracle Database Security Guide*. This guide describes how you can configure security for Oracle Database by using the default database features.

- [Audience](#)
- [Documentation Accessibility](#)
- [Diversity and Inclusion](#)
- [Related Documents](#)
- [Conventions](#)

Audience

Oracle Database Security Guide is intended for database administrators (DBAs), security administrators, application developers, and others tasked with performing the following operations securely and efficiently.

It covers these areas:

- Designing and implementing security policies to protect the data of an organization, users, and applications from accidental, inappropriate, or unauthorized actions
- Creating and enforcing policies and practices of auditing and accountability for inappropriate or unauthorized actions
- Creating, maintaining, and terminating user accounts, passwords, roles, and privileges
- Developing applications that provide desired services securely in a variety of computational models, leveraging database and directory services to maximize both efficiency and ease of use

To use this document, you need a basic understanding of how and why a database is used, and basic familiarity with SQL.

Documentation Accessibility

For information about Oracle's commitment to accessibility, visit the Oracle Accessibility Program website at <http://www.oracle.com/pls/topic/lookup?ctx=acc&id=docacc>.

Access to Oracle Support

Oracle customer access to and use of Oracle support services will be pursuant to the terms and conditions specified in their Oracle order for the applicable services.

Diversity and Inclusion

Oracle is fully committed to diversity and inclusion. Oracle respects and values having a diverse workforce that increases thought leadership and innovation. As part of our initiative to build a more inclusive culture that positively impacts our employees, customers, and partners, we are working to remove insensitive terms from our products and documentation. We are also mindful of the necessity to maintain compatibility with our customers' existing technologies and the need to ensure continuity of service as Oracle's offerings and industry standards evolve. Because of these technical constraints, our effort to remove insensitive terms is ongoing and will take time and external cooperation.

Related Documents

For more security-related information, see these Oracle resources:

- [Oracle Database Data Redaction Guide](#)
- [Oracle Database Transparent Data Encryption Guide](#)
- [Oracle Database Vault Administrator's Guide](#)
- [Oracle Label Security Administrator's Guide](#)
- [Oracle Key Vault documentation library](#)
- [Audit Vault and Database Firewall documentation library](#)
- [Oracle Data Masking and Subsetting documentation library](#)
- [Oracle Data Safe documentation library](#)
- [Oracle Database Security Assessment Tool](#)
- [Oracle Database PL/SQL Packages and Types Reference](#)
- [Oracle Database Reference](#)
- [Oracle Database SQL Language Reference](#)
- [Oracle Database Net Services Reference](#)
- [Oracle Database Administrator's Guide](#)
- [Oracle Database Concepts](#)
- [Oracle Multitenant Administrator's Guide](#)

Many of the examples in this guide use the sample schemas of the seed PDB, which you can create when you install Oracle Database. See *Oracle Database Sample Schemas* for information about how these schemas were created and how you can use them yourself.

Oracle Technical Services

To download the product data sheet, frequently asked questions, links to the latest product documentation, product download, and other collateral, visit Oracle Technical Resources (formerly Oracle Technology Network). You must register online before using Oracle Technical Services. Registration is free and can be done at

<https://www.oracle.com/technical-resources/>

My Oracle Support

You can find information about security patches, certifications, and the support knowledge base by visiting My Oracle Support (formerly Oracle*MetaLink*) at

<https://support.oracle.com>

Conventions

The following text conventions are used in this document:

Convention	Meaning
boldface	Boldface type indicates graphical user interface elements associated with an action, or terms defined in text or the glossary.
<i>italic</i>	Italic type indicates book titles, emphasis, or placeholder variables for which you supply particular values.
monospace	Monospace type indicates commands within a paragraph, URLs, code in examples, text that appears on the screen, or text that you enter.

Changes in This Release for Oracle Database Security Guide

This preface contains:

- [Changes in Oracle Database Security 23ai](#)
- [Updates to Oracle Database Security 23ai](#)

Changes in Oracle Database Security 23ai

Oracle Database Security Guide for Oracle Database 23ai has new security features.

- [Transport Layer Security 1.3 Protocol Now Supported in Oracle Database](#)
Starting with Oracle Database 23ai, Oracle Database supports Transport Layer Security (TLS) version 1.3, which uses newer and more secure cipher suites that improve confidentiality of data in transit.
- [Simplified Transport Layer Security Configuration](#)
Starting with Oracle Database 23ai, the Transport Layer Security (TLS) configuration between the database client and server has been simplified yet made more secure.
- [Schema Privileges to Simplify Access Control](#)
Starting with Oracle Database 23ai, Oracle Database supports schema privileges in addition to the existing object, system, and administrative privileges.
- [Oracle SQL Firewall is Now Built into Oracle Database](#)
Starting with Oracle Database 23ai, Oracle SQL Firewall inspects all incoming SQL statements and ensures that only explicitly authorized SQL is run.
- [Increased Maximum Password Length](#)
Starting with Oracle Database 23ai, Oracle Database supports passwords up to 1024 bytes in length.
- [Read-Only Users and Sessions](#)
Starting with Oracle Database 23ai, you can control whether a user or session is enabled for read-write operations, irrespective of the privileges of the user that is connected to the database.
- [New Database Role for Application Developers](#)
Starting with Oracle Database 23ai, a new role specifically for application developers, `DB_DEVELOPER_ROLE`, is introduced for stronger security using the least privilege principle.
- [Oracle Data Dictionary Protection Extended to Non-SYS Oracle Schemas with Separation of Duties Protection](#)
Starting with Oracle Database 23ai, Oracle Database schemas now can have data dictionary protection with additional separation of duties protection for the `SYSBACKUP`, `SYSKM`, `SYSRAC`, and `SYSDBG` schemas.
- [Strict DN Matching with Both Listener and Server Certificates](#)
Starting with Oracle Database release 23ai, the behavior of the `SSL_SERVER_DN_MATCH` parameter has changed.

- [Ability to Configure Transport Layer Security Connections without Client Wallets](#)
Starting with Oracle Database 23ai, for Linux, non-Linux, and Microsoft Windows platforms, an Oracle Database client is no longer required to provide a wallet to hold well-known CA root certificates if they are available in the local system.
- [Updated Kerberos Library and Other Improvements](#)
Starting with Oracle Database 23ai, Oracle Database supports MIT Kerberos library version 1.21.2, and provides cross-domain support for accessing resources in other domains.
- [Improved and More Secure Local Auto-Login Wallets](#)
Starting with Oracle Database 23ai, newly created local auto-login wallets (or pre-release 23ai wallets that have been updated for release 23ai) are more secure.
- [New sqlnet.ora Parameter to Prevent the Use of Deprecated Ciphers](#)
Starting with Oracle Database 23ai, you can block the use of deprecated ciphers by setting the `SSL_ENABLE_WEAK_CIPHERS sqlnet.ora` parameter to `FALSE`.
- [Enhancements to RADIUS Configuration](#)
Starting with Oracle Database 23ai, Oracle Database supports the Requests for Comments (RFC) 6613 and 6614 guidelines, and updates to RADIUS security with the latest standards.
- [Enhancements to the DBMS_CRYPTO PL/SQL Package](#)
Starting with Oracle Database 23ai, the `DBMS_CRYPTO` PL/SQL package has APIs to support several customer needs, such as elliptic-curve Diffie–Hellman (ECDH) operations, updated signature and verification algorithms, and other enhancements.
- [Authenticating and Authorizing IAM Users to Oracle Autonomous Database on Dedicated Exadata Infrastructure](#)
Starting with Oracle Database 23ai, users can authenticate and authorize IAM users to Oracle Autonomous Database on Dedicated Exadata Infrastructure.
- [Ability of Azure Users to Log in to Oracle Database with Their Azure AD OAuth2 Access Token](#)
Available initially for the Oracle Autonomous Database in June 2022, Microsoft Azure Active Directory (Azure AD) users can now log in to Oracle Databases on-premises and in the cloud.
- [Ability to Audit Object Actions at the Column Level for Tables and Views](#)
Starting with Oracle Database 23ai, you can create unified audit policies to audit individual columns in tables and views.
- [Consolidation of the FIPS_140 Parameter](#)
Starting with Oracle Database 23ai, you can use the `FIPS_140` parameter to configure FIPS in a uniform way with multiple Oracle Database environments and features.
- [Desupport of Case Insensitive Passwords](#)
Starting with Oracle Database 23ai, case-insensitive passwords are no longer supported.
- [Desupport of Traditional Auditing](#)
Starting with Oracle Database 23ai, traditional auditing is desupported.

Transport Layer Security 1.3 Protocol Now Supported in Oracle Database

Starting with Oracle Database 23ai, Oracle Database supports Transport Layer Security (TLS) version 1.3, which uses newer and more secure cipher suites that improve confidentiality of data in transit.

Because TLS 1.3 handles initial session setup more efficiently than earlier TLS versions, users moving to TLS 1.3 will see improvements in TLS performance. TLS 1.3 also implements

newer, more secure cipher suites that improve confidentiality of data in transit. Oracle recommends that you move immediately from the desupport TLS protocol versions (1.0 and 1.1) to version 1.3. Version 1.2 is still supported.

Related Topics

- [Configuring Transport Layer Security Encryption](#)
Use Transport Layer Security (TLS), a secure and standard protocol, to encrypt your database client and server connections.
- [Migrating to and Configuring Transport Layer Security Version 1.3](#)
Version 1.3 of Transport Layer Security (TLS) provides stronger security and faster TLS handshakes, when compared to previous versions of TLS.

Simplified Transport Layer Security Configuration

Starting with Oracle Database 23ai, the Transport Layer Security (TLS) configuration between the database client and server has been simplified yet made more secure.

The changes are as follows:

- Update to the default for the client `WALLET_LOCATION` parameter so that if it is not set, then the value of the `TNS_ADMIN` parameter is used instead.
- Update to the `SSL_VERSION` parameter so that it can accept a comma-separated list of strings such as `(TLSv1.3, TLSv1.2)`.
- Introduction of the `ALLOWED_WEAK_CERT_ALGORITHMS` parameter for users whose environments still require the use of the earlier certificate signature algorithms. This parameter replaces the `ALLOW_MD5_CERTS` and `ALLOW_SHA1_CERTS` parameters. If `ALLOWED_WEAK_CERT_ALGORITHMS` is set, then Oracle Database ignores `ALLOW_MD5_CERTS` and `ALLOW_SHA1_CERTS`. However, if `ALLOWED_WEAK_CERT_ALGORITHMS` is not set, then Oracle Database checks and uses the `ALLOW_MD5_CERTS` and `ALLOW_SHA1_CERTS` settings. By default, SHA1 certificate are allowed and MD5 certificates are disallowed.
- Deprecation of the following parameters:
 - `ADD_SSLV3_TO_DEFAULT`
 - `ALLOW_MD5_CERTS`
 - `ALLOW_SHA1_CERTS`
- Modifications to how wallets are loaded
 - Server-side wallets: The `WALLET_LOCATION` parameter for server-side wallets is deprecated. Instead, use the `WALLET_ROOT` initialization parameter in the `init.ora` file.
 - Client-side wallets: The `WALLET_LOCATION` parameter can still be used for client-side wallets.
- Improved performance for the processing of wallets
- For users to enable TLS between the database client and the server, the only required and minimum configuration is putting a pair of wallets in client side `TNS_ADMIN` directory, and server side `WALLET_ROOT` directory.

Related Topics

- [Oracle Database Net Services Reference](#)

Schema Privileges to Simplify Access Control

Starting with Oracle Database 23ai, Oracle Database supports schema privileges in addition to the existing object, system, and administrative privileges.

The following new system privileges are required if you plan to manage the security policies for row level security, fine-grained auditing, or Oracle Data Redaction. They can be granted to enable the security policy across all non-SYS schemas in the database or to restrict the security policy to one schema.

- ADMINISTER ROW LEVEL SECURITY POLICY, for when the DBMS_RLS package is used for row level security policies
- ADMINISTER FINE GRAINED AUDIT POLICY, for when the DBMS_FGA package is used for fine-grained audit policies
- ADMINISTER REDACT POLICY, for when the DBMS_REDACT package is used for data redaction policies

As part of this new feature, the following views are introduced:

- DBA_SCHEMA_PRIVS
- ROLE_SCHEMA_PRIVS
- USER_SCHEMA_PRIVS
- SESSION_SCHEMA_PRIVS
- V\$ENABLEDSCHEMAPRIVS

In previous releases, object privileges provided fine-grained control over access to individual objects, such as the HR.EMPLOYEES table. System privileges were designed for administrators to grant similar access to all objects in the database of a certain type (for example, the SELECT ANY TABLE system privilege). For applications that only need to provide enough privileges (least privilege principle) for users to application objects, every privilege for every object had to be granted and tracked. Hence, new objects in the same schema required new object privileges. With the new schema privileges, you can grant a privilege for the entire schema, thereby simplifying application authorizations and improving security. For example:

```
GRANT SELECT ANY TABLE ON SCHEMA HR TO SCOTT;
```

Related Topics

- [Managing Schema Privileges](#)
Schema privileges enable certain system privileges to be granted on a schema.
- [Administering Schema Security Policies](#)
To manage schema security policies for row level security, fine-grained auditing, and Oracle Data Redaction, users must be granted the appropriate system privilege.

Oracle SQL Firewall is Now Built into Oracle Database

Starting with Oracle Database 23ai, Oracle SQL Firewall inspects all incoming SQL statements and ensures that only explicitly authorized SQL is run.

You can use SQL Firewall to control which SQL statements are allowed to be processed by the database. You can restrict connection paths associated with database connections and SQL statements. Unauthorized SQL can be logged and blocked.

Because SQL Firewall is built into the Oracle database, it cannot be bypassed. All SQL statements are inspected, whether local or network, or encrypted or clear text. It examines top-level SQL, stored procedures and the related database objects.

SQL Firewall provides real-time protection against common database attacks by restricting database access to only authorized SQL statements or connections. It mitigates risks from SQL injection attacks, anomalous access, and credential theft or abuse.

SQL Firewall uses session context data such as IP address, operating system user name, and operating system program name to restrict how a database account can connect to the database. This helps mitigate the risk of stolen or misused application service account credentials. A typical use case for SQL Firewall is for application workloads.

You can use SQL Firewall in both the root and a pluggable database (PDB).

Related Topics

-

Increased Maximum Password Length

Starting with Oracle Database 23ai, Oracle Database supports passwords up to 1024 bytes in length.

In previous releases, the Oracle Database password length and the secure role password length could be up to 30 bytes. The increased maximum password length to 1024 bytes provides the following benefits:

- It accommodates passwords that are used by Oracle Identity Cloud Service (IDCS) and Identity Access Management (IAM). The increase to 1024 bytes enables uniform password rules for all Cloud deployments.
- The 30-byte limitation was too restrictive when password multi-byte characters used more than 1 byte in an NLS configuration.

Related Topics

- [Minimum Requirements for Passwords](#)
Oracle provides a set of minimum requirements for passwords.

Read-Only Users and Sessions

Starting with Oracle Database 23ai, you can control whether a user or session is enabled for read-write operations, irrespective of the privileges of the user that is connected to the database.

The `READ_ONLY` session applies to any type of user for any type of container. The `READ_ONLY` user only applies to local users.

Providing the capability to disable and re-enable the read-write capabilities of any user or session without revoking and re-granting privileges provides you with more flexibility to temporarily control the privileges of users or sessions for testing, administration, or application development purposes. It also gives you a simple way to control the read-write behavior within different parts of an application that are used by the same user or session.

Related Topics

- [Configuring Read-Only Users](#)
You can override the privileges and roles that have been granted to a user by making the user a read-only user.

- *Oracle Multitenant Administrator's Guide*

New Database Role for Application Developers

Starting with Oracle Database 23ai, a new role specifically for application developers, `DB_DEVELOPER_ROLE`, is introduced for stronger security using the least privilege principle.

Oracle Database has many distinct privileges that can be granted to schema users or roles, as well as numerous stored or built-in PL/SQL packages that can be executed. Developers who design, develop, and deploy an application need a subset of these. Because an application developer or owner may not know or understand all the privileges that are needed by application developers, this could potentially result in database administrators granting all-encompassing privileges to developers. Providing developers with more privileges than necessary could pose a potential security risk. An alternative to granting all-encompassing privileges is to selectively grant privileges on demand as the application developer identifies the privileges they require that are not currently granted.

The benefit of the `DB_DEVELOPER_ROLE` role is that it quickly and easily provides the application developer with only the privileges that they need to design, implement, and deploy applications on Oracle databases.

Related Topics

- [Use of the `DB_DEVELOPER_ROLE` Role for Application Developers](#)
The `DB_DEVELOPER_ROLE` role provides most of the system privileges, object privileges, predefined roles, PL/SQL package privileges, and tracing privileges that an application developer needs.

Oracle Data Dictionary Protection Extended to Non-SYS Oracle Schemas with Separation of Duties Protection

Starting with Oracle Database 23ai, Oracle Database schemas now can have data dictionary protection with additional separation of duties protection for the `SYSBACKUP`, `SYSKM`, `SYSRAC`, and `SYSDG` schemas.

Dictionary protection has been applied to Oracle schemas such as `AUDSYS` and `LBACSYS`. For the full list of dictionary protected Oracle schemas, run the following query:

```
SELECT USERNAME, DICTIONARY_PROTECTED FROM DBA_USERS WHERE
DICTIONARY_PROTECTED='YES';
```

The dictionary protection includes the underlying schemas for the `SYSDBA`, `SYSBACKUP`, `SYSKM`, `SYSRAC`, and `SYSDG` administrative privileges. These have additional separation of duties protections. Direct and proxy logins are blocked and password changes are restricted to the user only.

Oracle schemas provide critical functionality for Oracle Database features. By enabling these schemas to have dictionary protection, you can prevent inadvertent and malicious changes within these schemas that could endanger Oracle Database functionality.

Related Topics

- [Managing Dictionary Protection for Oracle-Maintained Schemas](#)
Oracle-maintained schemas such as `AUDSYS` have dictionary protection to prevent users from using system privileges on these schemas.

Strict DN Matching with Both Listener and Server Certificates

Starting with Oracle Database release 23ai, the behavior of the `SSL_SERVER_DN_MATCH` parameter has changed.

Previously, Oracle Database performed the DN check only with the database server certificate, and both the `HOSTNAME` and the `SERVICE_NAME` setting in the connect string could be used for a partial DN match.

With Oracle Database 23ai, Oracle Database checks both the listener and server certificates. In addition, the `SERVICE_NAME` setting in the connect string is not used to check during a partial DN match. The `HOSTNAME` setting can still be used for partial DN matching with the certificate DN and subject alternative name (SAN), on both the listener and server certificates.

When set to `TRUE`, the `SSL_ALLOW_WEAK_DN_MATCH` parameter reverts `SSL_SERVER_DN_MATCH` to the behavior earlier than release 23ai and enables DN matching to only check the database server certificate (but not the listener) and enable the service name to be used for partial DN matching.

DN matching with both the listener and server certificates provides better security to ensure that the client is connecting to the correct database server. The service name setting is also removed from `SSL_SERVER_DN_MATCH` for better security and partial DN matching can still be performed with the `HOSTNAME` connect string parameter with the certificate DN and subject alternative name (SAN) matching.

The `SSL_ALLOW_WEAK_DN_MATCH`, though new to this release, is marked as deprecated because it is a temporary mechanism to enable interoperability with releases prior to 23ai.

Related Topics

- [Enable Weak DN Matching](#)
The `SSL_ALLOW_WEAK_DN_MATCH` parameter control reverts the DN matching behavior to prior database versions.
- [Enabling Distinguished Name \(DN\) Matching](#)
DN matching allows a connection to the Oracle Database server when the server certificate name or DN matches what the client expects.

Ability to Configure Transport Layer Security Connections without Client Wallets

Starting with Oracle Database 23ai, for Linux, non-Linux, and Microsoft Windows platforms, an Oracle Database client is no longer required to provide a wallet to hold well-known CA root certificates if they are available in the local system.

The Oracle Database wallet search order determines the location (Windows (Microsoft Certificate Store) or Linux) of these certificates in the local system.

Transport Layer Security (TLS) requires either one-way authentication or two-way authentication. In one-way TLS authentication, which is commonly used for HTTPS connections, you will no longer need to install and configure a client wallet to hold the server's CA certificate as long as it is already available in the local system. If the server's CA certificate is not installed in the local systems, then client wallet is still required.

This enhancement greatly simplifies the Oracle Database client installation and the use of TLS protocol to encrypt Oracle Database client-server communications.

Related Topics

- [Configuring TLS Using a Public Certificate Authority Root of Trust for the Database Server Certificate](#)
Before you can configure TLS without using client wallets, you must first create the server wallet and ensure that the database and listener are properly configured.
- [Oracle Database Wallet Search Order](#)
The search order that Oracle Database uses to find wallets depends on the feature for which the wallet was created, such as Transparent Data Encryption (TDE).

Updated Kerberos Library and Other Improvements

Starting with Oracle Database 23ai, Oracle Database supports MIT Kerberos library version 1.21.2, and provides cross-domain support for accessing resources in other domains.

This Kerberos enhancement improves security and allows Kerberos to be used in more Oracle Database environments.

Related Topics

- [Configuring Kerberos Authentication](#)
Kerberos is a trusted third-party authentication system that relies on shared secrets and presumes that the third party is secure.

Improved and More Secure Local Auto-Login Wallets

Starting with Oracle Database 23ai, newly created local auto-login wallets (or pre-release 23ai wallets that have been updated for release 23ai) are more secure.

A local auto-login wallet is now more tightly bound to the host where it was created or modified. The local auto-login process is also more secure, does not require additional deployment requirements, and does not require root access.

Local auto-login wallets are more secure now and support both bare metal and virtual environments.

This enhancement also applies to Transparent Data Encryption (TDE) local auto-login keystores.

Related Topics

- [About Managing Oracle Database Wallets and Certificates with the orapki Utility](#)
The `orapki` command-line utility enables you to create and manage wallets and certificates from the command line.

New sqlnet.ora Parameter to Prevent the Use of Deprecated Ciphers

Starting with Oracle Database 23ai, you can block the use of deprecated ciphers by setting the `SSL_ENABLE_WEAK_CIPHERS sqlnet.ora` parameter to `FALSE`.

You can prevent the use of deprecated ciphers, which are less secure than the latest ciphers, in an Oracle database if you do not have a dependency on them. This simplifies the passing of compliance audits and improves the overall security of your database.

Related Topics

- [Enabling Weak Cipher Suites](#)
You can enable deprecated cipher suites by setting the `SSL_ENABLE_WEAK_CIPHERS` parameter. For the connections to be successful with the weak cipher suites, all three components (client, listener, and server) need to have the weak cipher suites enabled.
- [Specifying TLS Protocol and TLS Cipher Suites](#)
Oracle Database 23ai supports TLS protocol versions 1.2 and 1.3 and their associated cipher suites for Transport Layer Security (TLS).

Enhancements to RADIUS Configuration

Starting with Oracle Database 23ai, Oracle Database supports the Requests for Comments (RFC) 6613 and 6614 guidelines, and updates to RADIUS security with the latest standards.

This enhancement introduces the following new RADIUS-related `sqlnet.ora` parameters:

- `SQLNET.RADIUS_ALTERNATE_TLS_HOST`
- `SQLNET.RADIUS_ALTERNATE_TLS_PORT`
- `SQLNET.RADIUS_AUTHENTICATION_TLS_HOST`
- `SQLNET.RADIUS_AUTHENTICATION_TLS_PORT`
- `SQLNET.RADIUS_TRANSPORT_PROTOCOL`

The following existing RADIUS `sqlnet.ora` parameters have been updated:

- `SQLNET.RADIUS_ALTERNATE_PORT`
- `SQLNET.RADIUS_AUTHENTICATION_PORT`
- `SQLNET.RADIUS_SECRET`

The older RADIUS standards are blocked by default in Oracle Database 23ai. If you need to enable pre-release 23ai clients to connect using the older protocol, then set one or both of the following parameters, new to release 23ai, in the `sqlnet.ora` file.

- `SQLNET.RADIUS_ALLOW_WEAK_CLIENTS` enables pre-release 23ai database clients to connect RADIUS users using the older standard.
- `SQLNET.RADIUS_ALLOW_WEAK_PROTOCOL` enables the pre-release 23ai database server to connect to the RADIUS server using the older standard.

This enhancement is beneficial in that Oracle Database RADIUS API implements TCP over Transport Layer Security (TLS) and provides other security improvements, such as support for AES256 and SHA512.

Related Topics

- [About Configuring RADIUS Authentication](#)
Oracle Database supports the RADIUS standard for user authentication.
- [Enabling RADIUS Authentication, Authorization, and Accounting](#)
You can enable RADIUS authentication, authorization, and accounting from the command line.
- *Oracle Database Upgrade Guide*
- *Oracle Database Upgrade Guide*

Enhancements to the DBMS_CRYPTO PL/SQL Package

Starting with Oracle Database 23ai, the `DBMS_CRYPTO` PL/SQL package has APIs to support several customer needs, such as elliptic-curve Diffie–Hellman (ECDH) operations, updated signature and verification algorithms, and other enhancements.

These enhancements are as follows:

- New APIs for elliptic-curve Diffie–Hellman (ECDH) operations
 - `ECDH_GENKEYPAIR`: This function generates an EC public/private key pair
 - `ECDHDERIVE_SHAREDSECRET`: This function derives shared secret using private key of local application and public key from the remote application.
- New `PKENCRYPT/PKDECRYPT` algorithm: `PKENCRYPT_RSA_PKCS1_OAEP_SHA2`
- New chain modes `GCM`, `CCM`, and `XTS`
- New `DBMS_CRYPTO` block cipher suites `AES_CCM_NONE` and `AES_GCM_NONE`
- New signature and verification algorithms:
 - `SIGN_SHA224_ECDSA`
 - `SIGN_SHA256_ECDSA`
 - `SIGN_SHA384_ECDSA`
 - `SIGN_SHA512_ECDSA`
 - `SIGN_ECDSA`

Related Topics

- [On-Demand Encryption of Data](#)
You can use the `DBMS_CRYPTO` PL/SQL package to perform on-demand encryption of data.
- *Oracle Database PL/SQL Packages and Types Reference*

Authenticating and Authorizing IAM Users to Oracle Autonomous Database on Dedicated Exadata Infrastructure

Starting with Oracle Database 23ai, users can authenticate and authorize IAM users to Oracle Autonomous Database on Dedicated Exadata Infrastructure.

Additional enhancements are as follows:

- Applications can now connect to an Autonomous Database instance by using end-user, instance, and resource principals.
- IAM users can now proxy to an Autonomous Database by using a database user schema.
- Database links are supported for IAM connections.

Related Topics

- [Authenticating and Authorizing IAM Users for Oracle DBaaS Databases](#)
Identity and Access Management (IAM) users can be configured to connect to an Oracle Database as a service (Oracle DBaaS) instance.

Ability of Azure Users to Log in to Oracle Database with Their Azure AD OAuth2 Access Token

Available initially for the Oracle Autonomous Database in June 2022, Microsoft Azure Active Directory (Azure AD) users can now log in to Oracle Databases on-premises and in the cloud.

You can use Azure AD OAuth2 tokens to access the database. Azure AD users can access the database directly using their Azure AD token, and applications can use their service tokens to access the database.

Related Topics

- [Authenticating and Authorizing Microsoft Azure Users for Oracle Databases](#)
An Oracle database can be configured for Microsoft Azure users of Microsoft Entra ID (previously called Microsoft Azure AD) to connect using single sign-on authentication.

Ability to Audit Object Actions at the Column Level for Tables and Views

Starting with Oracle Database 23ai, you can create unified audit policies to audit individual columns in tables and views.

The `ACTIONS` clause of the `CREATE AUDIT POLICY` and `ALTER AUDIT POLICY` procedures allows you to specify the list of columns whose access is to be audited. For example, to audit `UPDATE` statements on the `SALARY` column of a table, you would specify `ACTIONS UPDATE(SALARY)`.

The feature enables you to configure more granular and focused audit policies, and ensures that auditing is selective enough to reduce the creation of unnecessary audit records, and effective enough to let you meet your compliance requirements.

Related Topics

- [Example: Auditing an Action on a Table Column](#)
The `CREATE AUDIT POLICY` statement can audit actions on table or view columns.
- [Object Actions That Can Be Audited](#)
Auditing object actions can be broad or focused (for example, auditing all user actions or only a select list of user actions).

Consolidation of the FIPS_140 Parameter

Starting with Oracle Database 23ai, you can use the `FIPS_140` parameter to configure FIPS in a uniform way with multiple Oracle Database environments and features.

These environments and features are as follows:

- Transparent Data Encryption (TDE)
- `DBMS_CRYPTO` PL/SQL package
- Transport Layer Security (TLS)
- Network native encryption

You can still use the legacy FIPS 140-2 configurations for these environments, but Oracle recommends that you use the consolidated `FIPS_140` parameter instead.

Related Topics

- [Configuration of FIPS 140-2 Using the Consolidated FIPS_140 Parameter](#)
The consolidated `FIPS_140` parameter can be set for several different Oracle Database environments.

Desupport of Case Insensitive Passwords

Starting with Oracle Database 23ai, case-insensitive passwords are no longer supported.

Users whose passwords are case-insensitive will be unable to log in to the database after upgrading to Oracle Database 23ai. Before upgrading, an administrator must use the following query to find the users whose passwords are case-insensitive and notify these users to change their passwords:

```
SELECT USERNAME FROM DBA_USERS
WHERE (PASSWORD_VERSIONS = '10G '
OR PASSWORD_VERSIONS = '10G HTTP ')
AND USERNAME <> 'ANONYMOUS';
```

Changing the password enables the use of later, more secure password versions. If you have already upgraded to release 23ai and still have users whose passwords are case insensitive, then these users will not be able to log in. An administrator will need to change the password for these users. The password of any user that has only the `10G` password version remains case insensitive until it is changed, and it becomes case sensitive after it is changed.

Related Topics

- [Finding and Resetting User Passwords That Use the 10G Password Version](#)
For better security, find and reset passwords for user accounts that use the `10G` password version so that they use later, more secure password versions.

Desupport of Traditional Auditing

Starting with Oracle Database 23ai, traditional auditing is desupported.

Unified auditing is the way forward to perform Oracle Database auditing. Unified auditing offers more flexibility to perform selective and effective auditing, which helps you focus on activities that really matter to your enterprise. Unified auditing has one single and secure unified trail, conditional policy for audit selectivity, and default predefined policies for simplicity. To improve security and compliance, Oracle strongly recommends that you use unified auditing.

Related Topics

- [Handling the Desupport of Traditional Auditing](#)
Traditional auditing is desupported, starting in Oracle Database 23ai. Oracle recommends that you use unified auditing instead.

Updates to Oracle Database Security 23ai

Oracle Database Security Guide for Oracle Database 23ai has updates.

- [New Procedure for Oracle SQL Firewall DBMS_SQL_FIREWALL PL/SQL Package](#)
The Oracle SQL Firewall package `DBMS_SQL_FIREWALL` now has an additional procedure, `DBMS_SQL_FIREWALL.APPEND_ALLOW_LIST_SINGLE_SQL`.

- [DBMS_CRYPTO Support for SM2, SM3, SM4, and SHA-3 Cryptographic Algorithms](#)
The `DBMS_CRYPTO` PL/SQL package now supports the use of SM2, SM3, SM4, and SHA-3 cryptographic algorithms.
- [orapki Enhancements](#)
The `orapki` command line utility has been enhanced to include `mkstore` features and new command parameters to specify wallet certificates and keys.
- [Microsoft Entra ID \(Azure AD\) Integration Enhancements](#)
Oracle Cloud Infrastructure (OCI) and Oracle Database Instant Client now can directly retrieve Microsoft Entra ID (Azure AD) OAuth2 tokens. In addition, the Oracle Database server on AIX, Solaris, and HPUX platforms support the Entra ID integration.

New Procedure for Oracle SQL Firewall DBMS_SQL_FIREWALL PL/SQL Package

The Oracle SQL Firewall package `DBMS_SQL_FIREWALL` now has an additional procedure, `DBMS_SQL_FIREWALL.APPEND_ALLOW_LIST_SINGLE_SQL`.

This procedure enables you to individually append specific SQL records from a capture log or a violation log to an existing allow-list. While `DBMS_SQL_FIREWALL.APPEND_ALLOW_LIST` provides the flexibility to append the entire violation or capture log to the allow-list, in most common scenarios you might also need the flexibility to add just one of them instead of the entire list. In previous releases, if you wanted to append specific SQL commands to an allow-list, you had to use `DBMS_SQL_FIREWALL.APPEND_ALLOW_LIST` to append the entire violation or capture log to the allow-list, and then use `DBMS_SQL_FIREWALL.DELETE_ALLOWED_LIST` to manually delete the unwanted entries. This enhancement gives more flexibility to adjust the allow-list with specific records that you want to include.

Related Topics

- [Oracle Database PL/SQL Packages and Types Reference](#)

DBMS_CRYPTO Support for SM2, SM3, SM4, and SHA-3 Cryptographic Algorithms

The `DBMS_CRYPTO` PL/SQL package now supports the use of SM2, SM3, SM4, and SHA-3 cryptographic algorithms.

- SM2 is an asymmetric cryptographic algorithm. It is deployed for digital signatures, key exchange, and encryption.
- SM3 is a 256-bit hash algorithm. It is used for digital signatures, message authentication codes, and pseudorandom number generators.
- SM4 is a block symmetric encryption algorithm.
- SHA-3 (Secure Hash Algorithm 3) is a new cryptographic hash algorithm that supports fixed length hash, variable length hash, sign, verify, Hash-based Message Authentication Code (HMAC), and KECCAK Message Authentication Code (KMAC) functionalities.

The following `DBMS_CRYPTO` functions have been enhanced to support to the new algorithm constants:

- `DBMS_CRYPTO.ENCRYPT`
- `DBMS_CRYPTO.DECRYPT`

- `DBMS_CRYPTO.HASH`
- `DBMS_CRYPTO.MAC`
- `DBMS_CRYPTO.PKENCRYPT`
- `DBMS_CRYPTO.PKDECRYPT`
- `DBMS_CRYPTO.SIGN`
- `DBMS_CRYPTO.VERIFY`

The following `DBMS_CRYPTO` functions have been added to support new algorithm constants for some SHA-3 features:

- `DBMS_CRYPTO.HASH_LEN` (similar to the existing `DBMS_CRYPTO.HASH` function but it includes an extra input length)
- `DBMS_CRYPTO.KMACXOF` (similar to the existing `DBMS_CRYPTO.MAC` function but it includes an extra input length and custom string)

This new hash type can be used with `DBMS_CRYPTO.ENCRYPT` and `DBMS_CRYPTO.DECRYPT`:

- `ENCRYPT_SM4`

These new hash types can be used with `DBMS_CRYPTO.HASH`:

- `HASH_SHA3_224`
- `HASH_SHA3_256`
- `HASH_SHA3_384`
- `HASH_SHA3_512`
- `HASH_SM3`

These new MAC types can be used with the `DBMS_CRYPTO.MAC` function:

- `HMAC_SHA3_224`
- `HMAC_SHA3_256`
- `HMAC_SHA3_384`
- `HMAC_SHA3_512`

These new encryption types can be used with `DBMS_CRYPTO.PKENCRYPT` and `DBMS_CRYPTO.PKDECRYPT`:

- `PKENCRYPT_SM2`
- `KEY_TYPE_SM2`

These new algorithms can be used with `DBMS_CRYPTO.SIGN` and `DBMS_CRYPTO.VERIFY`:

- `SIGN_SHA3_224_RSA`
- `SIGN_SHA3_256_RSA`
- `SIGN_SHA3_384_RSA`
- `SIGN_SHA3_512_RSA`
- `SIGN_SHA3_224_ECDSA`
- `SIGN_SHA3_256_ECDSA`
- `SIGN_SHA3_384_ECDSA`

- `SIGN_SHA3_512_ECDSA`
- `SIGN_SM3_SM2`

SHA-3 provides variable-length hash functions, allowing for hash values of any desired length.

These new variable length hash types can be used with the new `DBMS_CRYPTO.HASH_LEN` function:

- `HASH_SHAKE128`
- `HASH_SHAKE256`

These new variable length MAC types can be used with the new `DBMS_CRYPTO.KMACXOF` function:

- `KMACXOF_128`
- `KMACXOF_256`

Related Topics

- *Oracle Database PL/SQL Packages and Types Reference*

orapki Enhancements

The `orapki` command line utility has been enhanced to include `mkstore` features and new command parameters to specify wallet certificates and keys.

- **mkstore features included in orapki:** `mkstore` features have been incorporated into the `orapki` command line utility to simplify the management of Oracle Database wallets, certificates, and secrets. The new commands in `orapki` support the following capabilities of `mkstore`:

- The ability to create, modify and delete secret store credentials and entries
- The ability to list specific secret store credentials and entries

These capabilities are supported with the `orapki secretstore` command.

The `mkstore` utility has been deprecated. Oracle recommends that you use `orapki` instead.

- **New command parameters to specify wallet certificates and keys:** The `orapki` command-line utility now enables you to store alias names in an Oracle wallet and also display and reference certificate thumbprint signatures in an Oracle wallet. These enhancements enable users to do the following:
 - Use thumbprint or alias to select the certificate in a connect string for TLS connections.
 - Use thumbprint or alias to select the certificate in the Microsoft Certificate Store (MCS) for TLS connections.
 - Store certificates with their serial numbers to simplify specifying certificates or removing certificates.

This enhancement affects the `orapki wallet add`, `orapki wallet display`, and `orapki wallet remove` commands. The benefit of this feature is the simplification of managing wallets and selecting certificates through the new thumbprint, alias, and serial number parameters.

Related Topics

- [orapki Utility Commands Summary](#)
The `orapki` commands perform a variety of wallet, certificate revocation lists (CRL), and certificate management tasks.

Microsoft Entra ID (Azure AD) Integration Enhancements

Oracle Cloud Infrastructure (OCI) and Oracle Database Instant Client now can directly retrieve Microsoft Entra ID (Azure AD) OAuth2 tokens. In addition, the Oracle Database server on AIX, Solaris, and HPUX platforms support the Entra ID integration.

Microsoft has renamed Azure AD to Entra ID. This terminology will be used in Oracle Database 23ai and later releases.

- **OCI and Instant Client now can directly retrieve Entra ID OAuth2 tokens.** Oracle Call Interface (OCI) and Oracle Database Instant Client can retrieve a Microsoft Entra ID OAuth2 token directly from Entra ID instead of relying on a separate script or process to retrieve the token first. This design improves the interactive flow between the database server and the client when users connect to the database (for example, with SQL*Plus). This enhancement simplifies the configuration that an end-user must perform in order to retrieve tokens. In previous releases, the end-user had to run a script to get the token from Entra ID before starting SQL*Plus or any other OCI utilities. Now, the token retrieval is part of OCI. This enhancement is similar to recent enhancements with the JDBC-thin and ODP.NET core and managed clients.
- **The Entra ID integration is now supported with the Oracle Database server running on the AIX, Solaris, and HPUX platforms.** Entra ID integration is now available for the Oracle Database server on all supported operating system platforms. In addition to the newly supported AIX, Solaris, and HPUX platforms, Linux and Windows are still supported. The Entra ID integration feature for the Oracle Database is supported on Windows and Linux only with the full (thick) client and the instant client.

Related Topics

- [About Configuring Client Connections to Entra ID](#)
There are three different ways for an Oracle Database client to use an Entra ID OAuth2 token to send to the database for access.
- [About Integrating Oracle Database with Microsoft Entra ID](#)
Oracle Database and Microsoft Entra ID can be configured to allow users and applications to connect to the database using their Entra ID credentials.

1

Introduction to Oracle Database Security

Oracle Database provides a rich set of default security features to manage user accounts, authentication, privileges, application security, encryption, network traffic, and auditing.

It is important to secure data to help protect sensitive information from access and interception by unauthorized parties. Without the appropriate security measures in place, data can be vulnerable to many types of attack vectors, such as man-in-the-middle attacks, packet sniffing, or data tampering. Leadership across various lines of business such as, technology, information security, and legal and compliance tend to be concerned about data breaches for three reasons:

1. Since data and data-driven information elements are critical assets in a digital economy, safeguarding this asset set is paramount to staying competitive.
 2. The bad press associated with data breaches does more intangible damage than direct financial damages in the form of fines, penalties, and retribution costs. Linger impacts include missed new revenue opportunities, pipeline conversion rate drops, failed cost avoidance measures, and so on.
 3. They need to comply with the requirements of national and state laws, industry regulations, contractual agreements, and organizational policies.
- [About Oracle Database Security](#)
Use Oracle Database's security features to reduce risk and protect data from theft, destruction, or misuse.
 - [Additional Oracle Database Security Products](#)
In addition to the security resources that are available in a default database installation, Oracle Database provides several other database security products.

1.1 About Oracle Database Security

Use Oracle Database's security features to reduce risk and protect data from theft, destruction, or misuse.

A few popular areas to focus security efforts on include:

- **User accounts.** When a schema is created, it comes with a local database user account that has privileges in that schema. When you create user accounts, you can secure them in a variety of ways. You can also create password profiles and resource limits to better secure password policies for your site. Oracle Database provides a set of predefined schemas that provide database functionality and other predefined schemas with administrative privileges.

For more information see [Managing Security for Oracle Database Users](#).

- **Authentication methods.** Oracle Database provides several ways to configure authentication for users and database administrators. For example, you can authenticate users on the database level, from the operating system, and on the network, and for multitier, global users, and application servers. If you use Microsoft Active Directory, you can authenticate and authorize Microsoft Active Directory users with the database directly.

You can configure your databases to use strong authentication with Oracle authentication adapters that support various third-party authentication services with digital certificates. Oracle Database provides the following strong authentication support:

- Centralized authentication and single sign-on.
- Kerberos
- Remote Authentication Dial-in User Service (RADIUS)
- Certificate-based authentication

For more information see [Configuring Authentication](#) and [Configuring Centrally Managed Users with Microsoft Active Directory](#).

- **Privileges and roles.** You can use privileges and roles to restrict user access to data in the following ways:
 - Creating and granting privileges and roles to users or other roles.
For more information see [Configuring Privilege and Role Authorization](#).
 - Performing privilege analysis to find information about how privileges are used in your site
For more information see [Performing Privilege Analysis to Identify Privilege Use](#).
 - Configure definer's rights and invoker's rights for your applications
For more information see [Managing Security for Definer's Rights and Invoker's Rights](#).
 - Manage fine-grained access in PL/SQL packages and types
For more information see [Managing Fine-Grained Access in PL/SQL Packages and Types](#).
 - Use Enterprise Manager to manage security
For more information see [Managing Security for a Multitenant Environment in Enterprise Manager](#).
- **Application security.** The first step to creating a database application is to ensure that it you have properly incorporated application security into your application security policies.
For more information see [Managing Security for Application Developers](#).
- **User session information using application context.** An application context is a name-value pair that holds the session information. You can retrieve session information about a user, such as the user name or terminal, and restrict database and application access for that user based on this information.
For more information see [Using Application Contexts to Retrieve User Information](#).
- **Classify and protect data in different categories.** You can create Transparent Sensitive Data Protection policies to find all table columns in a database that hold sensitive data (such as credit card or Social Security numbers), classify this data, and then create a policy that protects this data as a whole for a given class.
For more information see [Using Transparent Sensitive Data Protection](#) .
- **Network data encryption.** You can use Transport Layer Security (TLS) and native network encryption to encrypt data as it travels on the network to prevent unauthorized access to that data. You can configure native Oracle Net Services data encryption for both servers and clients.
For more information see [Configuring Oracle Database Native Network Encryption and Data Integrity](#) and [Configuring Transport Layer Security Encryption](#).
- **Thin JDBC client network configuration.** You can configure thin Java Database Connectivity (JDBC) clients to securely connect to Oracle databases.

- **Auditing database activities.** Auditing provides the most accurate record of any database activity, not just from connections that take place over the wire but also through direct local logins, recursive SQL, dynamic SQLs, and stored procedures. Database auditing involves creating and enabling unified audit policies to track activities such as user actions, schema changes, logon events. Unified auditing further enables you to audit selectively by adding various conditions including application context values and simple built-in functions. This helps you to reduce the volume of your audit data, and at the same time helping you detect malicious activities in a timely manner.

For more information see [Monitoring Database Activity with Auditing](#).

1.2 Additional Oracle Database Security Products

In addition to the security resources that are available in a default database installation, Oracle Database provides several other database security products.

These products are as follows:

- **Oracle Advanced Security** enables you to protect sensitive data by using Transparent Data Encryption and Oracle Data Redaction.
- **Oracle Label Security** applies classification labels to data, allowing you to filter user access to data at the row level.
- **Oracle Database Vault** provides fine-grained access control to your sensitive data, including protecting data from privileged users. For example, you can restrict database administrators from having access to employee information such as salaries.
- **Oracle Data Safe** enables you to analyze the sensitivity and risks of data in your Oracle databases, and based on these findings, create policies that mask sensitive data, create and monitor security controls, assess user security, and monitor user activity.
- **Oracle Enterprise User Security** enables you to manage user security at the enterprise level. Enterprise User Security (EUS) is deprecated with Oracle Database 23ai.

Oracle recommends that you migrate to using Centrally Managed Users (CMU). This feature enables you to directly connect with Microsoft Active Directory without an intervening directory service for enterprise user authentication and authorization to the database. If your Oracle Database is in the cloud, you can also choose to move to one of the newer integrations with a cloud identity provider.

- **Oracle Enterprise Manager Data Masking and Subsetting Pack** can irreversibly replace the original sensitive data with fictitious data so that production data can be shared safely with IT developers or offshore business partners.
- **Oracle Audit Vault and Database Firewall** collects database audit data from sources such as Oracle Database audit trail tables, database operating system audit files, and database redo logs. Using Oracle Audit Vault and Database Firewall, you can create alerts on suspicious activities, and create reports on the history of privileged user changes, schema modifications, and even data-level access.
- **Oracle Key Vault** enables you to accelerate security and encryption deployments by centrally managing encryption keys, Oracle wallets, Java keystores, and credential files. It is optimized for Oracle wallets, Java keystores, and Oracle Advanced Security Transparent Data Encryption (TDE) master keys. Oracle Key Vault supports the OASIS KMIP standard. The full-stack, security-hardened software appliance uses Oracle Linux and Oracle Database technology for security, availability, and scalability, and can be deployed on your choice of compatible hardware.

In addition to these products, you can find the latest information about Oracle Database security, such as new products and important information about security patches and alerts, by visiting the Security Technology Center on Oracle Technology Network at

<http://www.oracle.com/technetwork/topics/security/whatsnew/index.html>

Part I

Managing User Authentication and Authorization

Part I describes how to manage user authentication and authorization.

- [Managing Security for Oracle Database Users](#)
You can manage the security for Oracle Database users in many ways, such as enforcing restrictions on the way that passwords are created.
- [Configuring Authentication](#)
Authentication means to verify the identity of users or other entities that connect to the database.
- [Configuring Privilege and Role Authorization](#)
Privilege and role authorization controls the permissions that users have to perform day-to-day tasks.
- [Performing Privilege Analysis to Identify Privilege Use](#)
Privilege analysis dynamically analyzes the privileges and roles that users use and do not use.
- [Configuring Centrally Managed Users with Microsoft Active Directory](#)
Oracle Database can authenticate and authorize Microsoft Active Directory users with the database directly without intermediate directories or Oracle Enterprise User Security.
- [Authenticating and Authorizing IAM Users for Oracle DBaaS Databases](#)
Identity and Access Management (IAM) users can be configured to connect to an Oracle Database as a service (Oracle DBaaS) instance.
- [Authenticating and Authorizing Microsoft Azure Users for Oracle Databases](#)
An Oracle database can be configured for Microsoft Azure users of Microsoft Entra ID (previously called Microsoft Azure AD) to connect using single sign-on authentication.
- [Managing Security for Definer's Rights and Invoker's Rights](#)
Invoker's rights and definer's rights have several security advantages when used to control access to privileges during user-defined procedure executions.
- [Managing Fine-Grained Access in PL/SQL Packages and Types](#)
Oracle Database provides PL/SQL packages and types for fine-grained access to control access to external network services and wallets.
- [Managing Security for a Multitenant Environment in Enterprise Manager](#)
You can manage common and local users and roles by using Oracle Enterprise Manager.

2

Managing Security for Oracle Database Users

You can manage the security for Oracle Database users in many ways, such as enforcing restrictions on the way that passwords are created.

- [About User Security](#)
You can secure users accounts through strong passwords and by specifying special limits for the users.
- [Creating User Accounts](#)
A user account can have restrictions such as profiles, a default role, and tablespace restrictions.
- [Altering User Accounts](#)
The `ALTER USER` statement modifies user accounts, such their default tablespace or profile, or changing a user's password.
- [Configuring User Resource Limits](#)
A resource limit defines the amount of system resources that are available for a user.
- [Dropping User Accounts](#)
You can drop user accounts if the user is not in a session, and if the user has objects in the user's schema.
- [Predefined Schema User Accounts Provided by Oracle Database](#)
The Oracle Database installation process creates predefined administrative, non-administrative, and sample schema user accounts in the database.
- [Database User and Profile Data Dictionary Views](#)
Oracle Database provides a set of data dictionary views that provide information about the settings that you used to create users and profiles.

2.1 About User Security

You can secure users accounts through strong passwords and by specifying special limits for the users.

Each Oracle database (CDB and PDB) has a list of valid database users. To access CDB or PDB, a user must run a database application, and connect to the database instance using a valid user name defined in the database.

When you create user accounts, you can specify limits to the user account. You can also set limits on the amount of various system resources available to each user as part of the security domain of that user. Oracle Database provides a set of database views that you can query to find information such as resource and session information.

Profiles are also available. Profiles provide a way to configure the resources for the database user. A profile is collection of attributes that apply to a user. It enables a single point of reference for any of multiple users that share those exact attributes.

Oracle Database provides a set of predefined administrative, non-administrative, and sample schema accounts. The Oracle Database installation guides provide a listing of these accounts. To find the status of these accounts, query the `USERNAME` and `ACCOUNT_STATUS` columns of the `DBA_USERS` data dictionary view.

Related Topics

- [Configuring Privilege and Role Authorization](#)
Privilege and role authorization controls the permissions that users have to perform day-to-day tasks.

2.2 Creating User Accounts

A user account can have restrictions such as profiles, a default role, and tablespace restrictions.

- [About Common Users and Local Users](#)
CDB common users and application common have access to their respective containers, and local users are specific to a PDB.
- [Who Can Create User Accounts?](#)
Users who has been granted the `CREATE USER` system privilege can create user accounts, including user accounts to be used as proxy users.
- [Creating a New User Account That Has Minimum Database Privileges](#)
When you create a new user account, you should enable this user to access the database.
- [Restrictions on Creating the User Name for a New Account](#)
When you specify a name for a user account, be aware of restrictions such as naming conventions and whether the name is unique.
- [Assignment of User Passwords](#)
The `IDENTIFIED BY` clause of the `CREATE USER` statement assigns the user a password.
- [Default Tablespace for the User](#)
A default tablespace stores objects that users create.
- [Tablespace Quotas for a User](#)
The tablespace quota defines how much space to provide for a user's tablespace.
- [Temporary Tablespaces for the User](#)
A temporary tablespace contains transient data that persists only for the duration of a user session.
- [Profiles for the User](#)
A profile is a set of limits, defined by attributes, on database resources and password access to the database.
- [Creation of a Common User or a Local User](#)
The `CREATE USER` SQL statement can be used to create both common (CDB and application) users and local users.
- [Creating a Default Role for the User](#)
A default role is automatically enabled for a user when the user creates a session.

2.2.1 About Common Users and Local Users

CDB common users and application common have access to their respective containers, and local users are specific to a PDB.

- [About Common Users](#)
Oracle provides two types of common users: CDB common users and application common users.

- [How Plugging in PDBs Affects CDB Common Users](#)
Plugging a unplugged PDB into a CDB as a PDB affects both Oracle-supplied administrative and user-created accounts and privileges.
- [About Local Users](#)
A local user is a database user that exists only in a single PDB.

2.2.1.1 About Common Users

Oracle provides two types of common users: CDB common users and application common users.

A CDB common user is a database user whose single identity and password are known in the CDB root and in every existing and future pluggable database (PDB), including any application roots. All Oracle-supplied administrative user accounts, such as `SYS` and `SYSTEM`, are CDB common users and can navigate across the system container. CDB common users can have different privileges in different PDBs. For example, the user `SYSTEM` can switch between PDBs and use the privileges that are granted to `SYSTEM` in the current PDB. However, if one of the PDBs is Oracle Database Vault-enabled, then the Database Vault restrictions, such as `SYSTEM` not being allowed to create user accounts, apply to `SYSTEM` when this user is connected to that PDB. Oracle does not recommend that you change the privileges of the Oracle-supplied CDB common users.

A CDB common user can perform all tasks that an application common user can perform, provided that appropriate privileges have been granted to that user.

An application common user is a user account that is created in an application root, and is common only within this application container. In other words, the application common user does not have access to the entire CDB environment like CDB common users. An application common user is responsible for activities such as creating (which includes plugging), opening, closing, unplugging, and dropping application PDBs. This user can create application common objects in the application root. You can create an application common user only when you are connected to an application root. The ability for users to access the application common objects is subject to the same privileges as local and CDB common objects. For example, a local user in a PDB that is associated with an application root has access to only the objects in that PDB for which the user has privileges. In the application root itself, you can commonly grant a privilege on a CDB common object that will apply across the application container.

Both of these types of common users are responsible for managing the common objects in their respective roots. If the CDB common user or the application common user has the appropriate privileges, then this user can perform operations in PDBs as well, such as granting privileges to local users. These users can also locally grant common users different privileges in each container.

Both CDB and application common users can perform the following activities:

- Granting privileges to common users or common roles. That is, a CDB common user can grant a privilege to a common user or role, and the scope within which this privilege applies is determined by the container (CDB root, application root, or PDB) in which the statement is issued and whether the privilege is granted commonly (in the CDB root or the application root). A CDB common user connected to an application root can commonly grant a privilege on a CDB common object, and that privilege will apply across the application container.

The following diagram illustrates the access hierarchy with CDB common users, application common users, and local users:

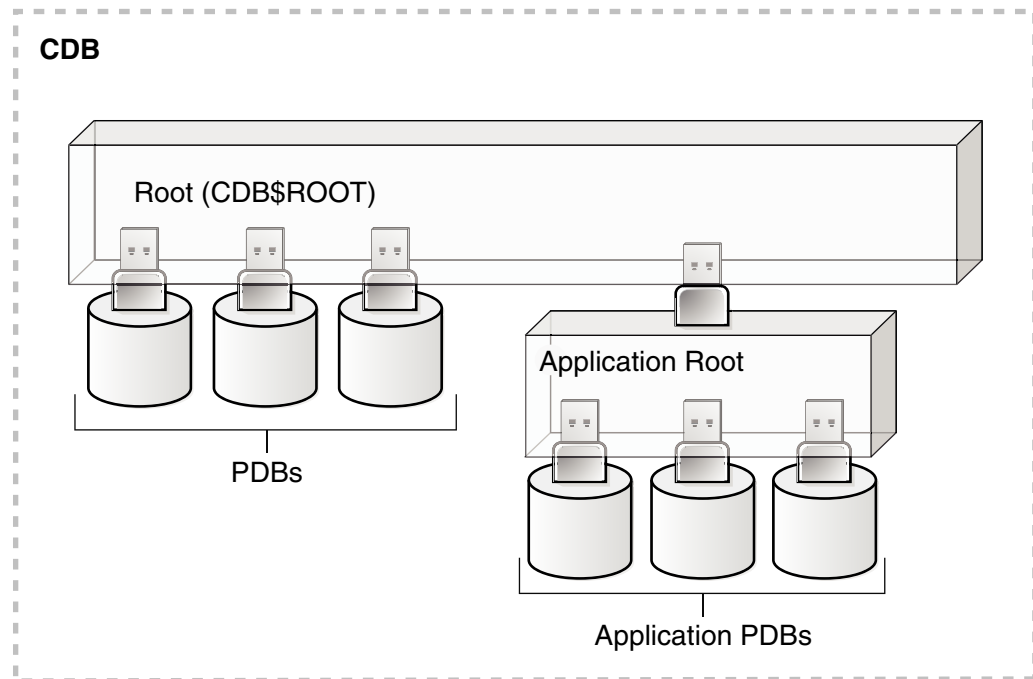

CDB common users are defined in the CDB root and may be able to access all PDBs within the CDB, including application roots and their application PDBs. Application common users are defined in the application root and have access to the PDBs that belong to the application container. Local users in either the CDB PDBs or the application PDBs have access only to the PDBs in which the local user resides.

- The state of a PDB can be altered by a suitably privileged user who can issue the `ALTER PLUGGABLE DATABASE` statement from the CDB root, from an application root (if a PDB is an application PDB that belongs to the application container), or from a PDB itself.

One difference between CDB common users and application common users is that only a CDB common user can run an `ALTER DATABASE` statement that specifies the recovery clauses that apply to the entire CDB.

Related Topics

- [About Creating Common User Accounts](#)
Be aware of common user account restrictions such as where they can be created, naming conventions, and objects stored in their schemas.
- [About Commonly and Locally Granted Privileges](#)
Both common users and local users can grant privileges to one another.
- *Oracle Database Concepts*

2.2.1.2 How Plugging in PDBs Affects CDB Common Users

Plugging a unplugged PDB into a CDB as a PDB affects both Oracle-supplied administrative and user-created accounts and privileges.

This affects the passwords of these CDB common user accounts, and privileges of all accounts in the newly plugged-in database.

The following actions take place:

- The Oracle-supplied administrative accounts are merged with the existing common user accounts.

- User-created accounts are merged with the existing user-created common user accounts.
- The passwords of the existing CDB common user accounts take precedence over the passwords for the accounts from the non-CDB.
- If you had modified the privileges of a user account in its original unplugged PDB, then these privileges are saved, but they only apply to the PDB that was created when the PDB was plugged into the CDB, as locally granted privileges. For example, suppose you had granted the user `SYSTEM` a role called `hr_mgr` in the non-CDB `db1`. After the `db1` database has been added to a CDB, then `SYSTEM` can only use the `hr_mgr` role in the `db1` PDB, and not in any other PDBs.

The following two scenarios are possible when you plug a PDB (for example, `pdb_1`) from one CDB (`cdb_1`) to a another CDB (`cdb_2`):

- `cdb_1` has the common user `c##cdb1_user`. `cdb_2` does not have this user.
`c##cdb1_user` remains in `PDB_1` but this account is locked. To resurrect this account, you must close `pdb_1`, recreate common user `c##cdb1_user` in the root of `cdb_2`, and then re-open `pdb_1`.
- `cdb_1` and `cdb_2` both have common user `c##common_user`.
Both `c##common_user` accounts are merged. `c##common_user` retains its password in `cdb_2`. Any privileges assigned to it in `cdb_2` but not in `cdb_1` are retained locally in `pdb_1`.

2.2.1.3 About Local Users

A local user is a database user that exists only in a single PDB.

Local users can have administrative privileges, but these privileges apply only in the PDB in which the local user account was created. A local user account has the following characteristics, which distinguishes it from common user accounts:

- Local user accounts cannot create common user accounts or commonly grant them privileges. A common user with the appropriate privileges can create and modify common or local user accounts and grant and revoke privileges, commonly or locally. A local user can create and modify local user accounts or locally grant privileges to common or local users in a given PDB.
- You can grant local user accounts common roles. However, the privileges associated with the common role only apply to the local user's PDB.
- The local user account must be unique only within its PDB.
- With the appropriate privileges, a local user can access objects in a common user's schema. For example, a local user can access a table within the schema of a common user if the common user has granted the local user privileges to access it.
- You can editions-enable a local user account but not a common user account.

Related Topics

- [About Creating Local User Accounts](#)
Be aware of local user account restrictions such as where they can be created, naming conventions, and objects stored in their schemas.
- *Oracle Database Concepts*

2.2.2 Who Can Create User Accounts?

Users who has been granted the `CREATE USER` system privilege can create user accounts, including user accounts to be used as proxy users.

Because the `CREATE USER` system privilege is a powerful privilege, a database administrator or security administrator is usually the only user who has this system privilege.

If you want to create users who themselves have the privilege to create users, then include the `WITH ADMIN OPTION` clause in the `GRANT` statement. For example:

```
GRANT CREATE USER TO lbrown WITH ADMIN OPTION;
```

As with all user accounts to whom you grant privileges, grant these privileges to trusted users only.

Before you can create common user accounts, you must have the commonly granted `CREATE USER` system privilege. To create local user accounts, you must have a commonly granted `CREATE USER` privilege or a locally granted `CREATE USER` privilege in the PDB in which the local user account will be created.

Note:

As a security administrator, you should create your own roles and assign only those privileges that are needed. For example, many users formerly granted the `CONNECT` privilege did not need the additional privileges `CONNECT` used to provide. Instead, only `CREATE SESSION` was actually needed. By default, the `SET CONTAINER` privilege is granted to `CONNECT` role.

Creating organization-specific roles gives an organization detailed control of the privileges it assigns, and protects it in case Oracle Database changes the roles that it defines in future releases.

Related Topics

- [Configuring Privilege and Role Authorization](#)
Privilege and role authorization controls the permissions that users have to perform day-to-day tasks.

2.2.3 Creating a New User Account That Has Minimum Database Privileges

When you create a new user account, you should enable this user to access the database.

1. Use the `CREATE USER` statement to create a new user account.

For example:

```
CREATE USER jward
  IDENTIFIED BY password
  DEFAULT TABLESPACE example
  QUOTA 10M ON example
  TEMPORARY TABLESPACE temp
  QUOTA 5M ON system
  PASSWORD EXPIRE;
```

Ensure that the password that you create is secure. This example creates a local user account and specifies the user password, default tablespace, temporary tablespace where temporary segments are created, tablespace quotas, and profile.

2. At minimum, grant the user the `CREATE SESSION` privilege so that the user can access the database instance.

```
GRANT CREATE SESSION TO jward;
```

A newly created user cannot connect to the database until they have the `CREATE SESSION` privilege. If the user must access Oracle Enterprise Manager, then you should also grant the user the `SELECT ANY DICTIONARY` privilege.

Related Topics

- [Guidelines for Securing Passwords](#)
Oracle provides guidelines for securing passwords in a variety of situations.
- [Restrictions on Creating the User Name for a New Account](#)
When you specify a name for a user account, be aware of restrictions such as naming conventions and whether the name is unique.
- [Assignment of User Passwords](#)
The `IDENTIFIED BY` clause of the `CREATE USER` statement assigns the user a password.
- [Default Tablespace for the User](#)
A default tablespace stores objects that users create.
- [Tablespace Quotas for a User](#)
The tablespace quota defines how much space to provide for a user's tablespace.
- [Temporary Tablespaces for the User](#)
A temporary tablespace contains transient data that persists only for the duration of a user session.
- [Profiles for the User](#)
A profile is a set of limits, defined by attributes, on database resources and password access to the database.
- [Creation of a Common User or a Local User](#)
The `CREATE USER` SQL statement can be used to create both common (CDB and application) users and local users.

2.2.4 Restrictions on Creating the User Name for a New Account

When you specify a name for a user account, be aware of restrictions such as naming conventions and whether the name is unique.

- [Uniqueness of User Names](#)
Each user has an associated schema; within a schema, each schema object must have a unique name.
- [User Names in a Multitenant Environment](#)
Within each PDB, a user name must be unique with respect to other user names and roles in that PDB.
- [Case Sensitivity for User Names](#)
How you create a user name controls the case sensitivity in which the user name is stored in the database.

2.2.4.1 Uniqueness of User Names

Each user has an associated schema; within a schema, each schema object must have a unique name.

Oracle Database will prevent you from creating a user name if it is already exists. You can check existing names by querying the `USERNAME` column of the `DBA_USERS` data dictionary view.

2.2.4.2 User Names in a Multitenant Environment

Within each PDB, a user name must be unique with respect to other user names and roles in that PDB.

Note the following restrictions:

- For common user names, names for user-created common users must begin with a common user prefix. By default, for CDB common users, this prefix is `C##`. For application common users, this prefix is an empty string. This means that there are no restrictions on the name that can be assigned to an application common user other than that it cannot start with the prefix reserved for CDB common users. For example, you could name a CDB common user `c##hr_admin` and an application common user `hr_admin`.

The `COMMON_USER_PREFIX` parameter in `CDB$ROOT` defines the common user prefix. You can change this setting, but do so only with great care.

- For local user names, the name cannot start with `C##` (or `c##`).
- A user and a role cannot have the same name.

2.2.4.3 Case Sensitivity for User Names

How you create a user name controls the case sensitivity in which the user name is stored in the database.

For example:

```
CREATE USER jward
  IDENTIFIED BY password
  DEFAULT TABLESPACE data_ts
  QUOTA 100M ON test_ts
  QUOTA 500K ON data_ts
  TEMPORARY TABLESPACE temp_ts
  PROFILE clerk
  CONTAINER = CURRENT;
```

User `jward` is stored in the database in upper-case letters. For example:

```
SELECT USERNAME FROM ALL_USERS;

USERNAME
-----
JWARD
...
```

However, if you enclose the user name in double quotation marks, then the name is stored using the case sensitivity that you used for the name. For example:

```
CREATE USER "jward" IDENTIFIED BY password;
```

So, when you query the `ALL_USERS` data dictionary view, you will find that the user account is stored using the case that you used to create it.

```
SELECT USERNAME FROM ALL_USERS;

USERNAME
-----
jward
...
```

User `JWARD` and user `jward` are both stored in the database as separate user accounts. Later on, if you must modify or drop the user that you had created using double quotation marks, then you must enclose the user name in double quotation marks.

For example:

```
DROP USER "jward";
```

2.2.5 Assignment of User Passwords

The `IDENTIFIED BY` clause of the `CREATE USER` statement assigns the user a password.

Ensure that you create a secure password.

```
CREATE USER jward
  IDENTIFIED BY password
  DEFAULT TABLESPACE data_ts
  QUOTA 100M ON test_ts
  QUOTA 500K ON data_ts
  TEMPORARY TABLESPACE temp_ts
  PROFILE clerk
  CONTAINER = CURRENT;
```

Related Topics

- [Guidelines for Securing Passwords](#)
Oracle provides guidelines for securing passwords in a variety of situations.

2.2.6 Default Tablespace for the User

A default tablespace stores objects that users create.

- [About Assigning a Default Tablespace for a User](#)
Each user should have a default tablespace.
- [DEFAULT TABLESPACE Clause for Assigning a Default Tablespace](#)
The `DEFAULT TABLESPACE` clause in the `CREATE USER` statement assigns a default tablespace to the user.

2.2.6.1 About Assigning a Default Tablespace for a User

Each user should have a default tablespace.

When a schema object is created in the user's schema and the DDL statement does not specify a tablespace to contain the object, the Oracle Database stores the object in the user's default tablespace.

Tablespaces enable you to separate user data from system data, such as the data that is stored in the `SYSTEM` tablespace. You use the `CREATE USER` or `ALTER USER` statement to assign a default tablespace to a user. The default setting for the default tablespaces of all users is the

`SYSTEM` tablespace. If a user does not create objects, and has no privileges to do so, then this default setting is fine. However, if a user is likely to create any type of object, then you should specifically assign the user a default tablespace, such as the `USERS` tablespace. Using a tablespace other than `SYSTEM` reduces contention between data dictionary objects and user objects for the same data files. In general, do not store user data in the `SYSTEM` tablespace.

You can use the `CREATE TABLESPACE` SQL statement to create a permanent default tablespace other than `SYSTEM` at the time of database creation, to be used as the database default for permanent objects. By separating the user data from the system data, you reduce the likelihood of problems with the `SYSTEM` tablespace, which can in some circumstances cause the entire database to become nonfunctional. This default permanent tablespace is not used by system users, that is, `SYS`, `SYSTEM`, and `OUTLN`, whose default permanent tablespace is `SYSTEM`. A tablespace designated as the default permanent tablespace cannot be dropped. To accomplish this goal, you must first designate another tablespace as the default permanent tablespace. You can use the `ALTER TABLESPACE` SQL statement to alter the default permanent tablespace to another tablespace. Be aware that this will affect all users or objects created after the `ALTER DDL` statement is run.

You can also set a user default tablespace during user creation, and change it later with the `ALTER USER` statement. Changing the user default tablespace affects only objects created after the setting is changed.

When you specify the default tablespace for a user, also specify a quota on that tablespace.

2.2.6.2 DEFAULT TABLESPACE Clause for Assigning a Default Tablespace

The `DEFAULT TABLESPACE` clause in the `CREATE USER` statement assigns a default tablespace to the user.

In the following `CREATE USER` statement, the default tablespace for local user `jward` is `data_ts`:

```
CREATE USER jward
  IDENTIFIED BY password
  DEFAULT TABLESPACE data_ts
  QUOTA 100M ON test_ts
  QUOTA 500K ON data_ts
  TEMPORARY TABLESPACE temp_ts
  PROFILE clerk
  CONTAINER = CURRENT;
```

Related Topics

- [Tablespace Quotas for a User](#)
The tablespace quota defines how much space to provide for a user's tablespace.

2.2.7 Tablespace Quotas for a User

The tablespace quota defines how much space to provide for a user's tablespace.

- [About Assigning a Tablespace Quota for a User](#)
You can assign each user a tablespace quota for any tablespace, except a temporary tablespace.
- [CREATE USER Statement for Assigning a Tablespace Quota](#)
The `QUOTA` clause of the `CREATE USER` statement assigns the quotas for a tablespace.
- [Restriction of the Quota Limits for User Objects in a Tablespace](#)
You can restrict the quota limits for user objects in a tablespace so that the current quota is zero.

- [Grants to Users for the UNLIMITED TABLESPACE System Privilege](#)
To permit a user to use an unlimited amount of any tablespace in the database, grant the user the `UNLIMITED TABLESPACE` system privilege.

2.2.7.1 About Assigning a Tablespace Quota for a User

You can assign each user a tablespace quota for any tablespace, except a temporary tablespace.

Assigning a quota accomplishes the following:

- Users with privileges to create certain types of objects can create those objects in the specified tablespace.
- Oracle Database limits the amount of space that can be allocated for storage of a user's objects within the specified tablespace to the amount of the quota.

By default, a user has no quota on any tablespace in the database. If the user has the privilege to create a schema object, then you must assign a quota to allow the user to create objects. At a minimum, assign users a quota for the default tablespace, and additional quotas for other tablespaces in which they can create objects. The maximum amount of space that you can assign for a tablespace is 2 TB. If you need more space, then specify `UNLIMITED` for the `QUOTA` clause.

You can assign a user either individual quotas for a specific amount of disk space in each tablespace or an unlimited amount of disk space in all tablespaces. Specific quotas prevent a user's objects from using too much space in the database.

You can assign quotas to a user tablespace when you create the user, or add or change quotas later. (You can find existing user quotas by querying the `USER_TS_QUOTAS` view.) If a new quota is less than the old one, then the following conditions remain true:

- If a user has already exceeded a new tablespace quota, then the objects of a user in the tablespace cannot be allocated more space until the combined space of these objects is less than the new quota.
- If a user has not exceeded a new tablespace quota, or if the space used by the objects of the user in the tablespace falls under a new tablespace quota, then the user's objects can be allocated space up to the new quota.

2.2.7.2 CREATE USER Statement for Assigning a Tablespace Quota

The `QUOTA` clause of the `CREATE USER` statement assigns the quotas for a tablespace.

The following `CREATE USER` statement assigns quotas for the `test_ts` and `data_ts` tablespaces:

```
CREATE USER jward
  IDENTIFIED BY password
  DEFAULT TABLESPACE data_ts
  QUOTA 500K ON data_ts
  QUOTA 100M ON test_ts
  TEMPORARY TABLESPACE temp_ts
  PROFILE clerk
  CONTAINER = CURRENT;
```

2.2.7.3 Restriction of the Quota Limits for User Objects in a Tablespace

You can restrict the quota limits for user objects in a tablespace so that the current quota is zero.

To restrict the quote limits, use the `ALTER USER SQL` statement.

After a quota of zero is assigned, the objects of the user in the tablespace remain, and the user can still create new objects, but the existing objects will not be allocated any new space. For example, you could not insert data into one of this user's existing tables. The operation will fail with an `ORA-1536 space quota exceeded for tablespace %s` error.

2.2.7.4 Grants to Users for the UNLIMITED TABLESPACE System Privilege

To permit a user to use an unlimited amount of any tablespace in the database, grant the user the `UNLIMITED TABLESPACE` system privilege.

The `UNLIMITED TABLESPACE` privilege overrides all explicit tablespace quotas for the user. If you later revoke the privilege, then you must explicitly grant quotas to individual tablespaces. You can grant this privilege only to users, not to roles.

Before granting the `UNLIMITED TABLESPACE` system privilege, consider the consequences of doing so.

Advantage:

- You can grant a user unlimited access to all tablespaces of a database with one statement.

Disadvantages:

- The privilege overrides all explicit tablespace quotas for the user.
- You cannot selectively revoke tablespace access from a user with the `UNLIMITED TABLESPACE` privilege. You can grant selective or restricted access only after revoking the privilege.

2.2.8 Temporary Tablespaces for the User

A temporary tablespace contains transient data that persists only for the duration of a user session.

- [About Assigning a Temporary Tablespace for a User](#)
You should assign each user a temporary tablespace.
- [TEMPORARY TABLESPACE Clause for Assigning a Temporary Tablespace](#)
The `TEMPORARY TABLESPACE` clause in the `CREATE USER` statement assigns a user a temporary tablespace.

2.2.8.1 About Assigning a Temporary Tablespace for a User

You should assign each user a temporary tablespace.

When a user runs a SQL statement that requires a temporary segment, Oracle Database stores the segment in the temporary tablespace of the user. These temporary segments are created by the system when performing sort or join operations. Temporary segments are owned by `SYS`, which has resource privileges in all tablespaces.

To create a temporary tablespace, you can use the `CREATE TEMPORARY TABLESPACE SQL` statement.

If you do not explicitly assign the user a temporary tablespace, then Oracle Database assigns the user the default temporary tablespace that was specified at database creation, or by an `ALTER DATABASE` statement at a later time. If there is no default temporary tablespace explicitly assigned, then the default is the `SYSTEM` tablespace or another permanent default established

by the system administrator. Assigning a tablespace to be used specifically as a temporary tablespace eliminates file contention among temporary segments and other types of segments.

 **Note:**

If your `SYSTEM` tablespace is locally managed, then users must be assigned a specific default (locally managed) temporary tablespace. They may not be allowed to default to using the `SYSTEM` tablespace because temporary objects cannot be placed in locally managed permanent tablespaces.

You can set the temporary tablespace for a user at user creation, and change it later using the `ALTER USER` statement. You can also establish tablespace groups instead of assigning individual temporary tablespaces.

Related Topics

- *Oracle Database Administrator's Guide*

2.2.8.2 TEMPORARY TABLESPACE Clause for Assigning a Temporary Tablespace

The `TEMPORARY TABLESPACE` clause in the `CREATE USER` statement assigns a user a temporary tablespace.

In the following example, the temporary tablespace of `jward` is `temp_ts`, a tablespace created explicitly to contain only temporary segments.

```
CREATE USER jward
  IDENTIFIED BY password
  DEFAULT TABLESPACE data_ts
  QUOTA 100M ON test_ts
  QUOTA 500K ON data_ts
  TEMPORARY TABLESPACE temp_ts
  PROFILE clerk
  CONTAINER = CURRENT;
```

2.2.9 Profiles for the User

A profile is a set of limits, defined by attributes, on database resources and password access to the database.

The profile can be applied to multiple users, enabling them to share these attributes.

You can specify a profile when you create a user. The `PROFILE` clause of the `CREATE USER` statement assigns a user a profile. If you do not specify a profile, then Oracle Database assigns the user a default profile.

For example:

```
CREATE USER jward
  IDENTIFIED BY password
  DEFAULT TABLESPACE data_ts
  QUOTA 100M ON test_ts
  QUOTA 500K ON data_ts
  TEMPORARY TABLESPACE temp_ts
  PROFILE clerk
  CONTAINER = CURRENT;
```

Different profiles can be assigned to a common user in the root and in a PDB. When the common user logs in to the PDB, a profile whose setting applies to the session depends on whether the settings are password-related or resource-related.

- Password-related profile settings are fetched from the profile that is assigned to the common user in the root. For example, suppose you assign a common profile `c##prof` (in which `FAILED_LOGIN_ATTEMPTS` is set to 1) to common user `c##admin` in the root. In a PDB that user is assigned a local profile `local_prof` (in which `FAILED_LOGIN_ATTEMPTS` is set to 6.) Common user `c##admin` is allowed only one failed login attempt when they try to log in to the PDB where `loc_prof` is assigned to them.
- Resource-related profile settings specified in the profile assigned to a user in a PDB get used without consulting resource-related settings in a profile assigned to the common user in the root. For example, if the profile `local_prof` that is assigned to user `c##admin` in a PDB has `SESSIONS_PER_USER` set to 2, then `c##admin` is only allowed only 2 concurrent sessions when they log in to the PDB `loc_prof` is assigned to them, regardless of value of this setting in a profile assigned to them in the root.

Related Topics

- [Managing Resources with Profiles](#)
A profile is a named set of resource limits and password parameters that restrict database usage and instance resources for a user.

2.2.10 Creation of a Common User or a Local User

The `CREATE USER` SQL statement can be used to create both common (CDB and application) users and local users.

- [About Creating Common User Accounts](#)
Be aware of common user account restrictions such as where they can be created, naming conventions, and objects stored in their schemas.
- [CREATE USER Statement for Creating a Common User Account](#)
The `CREATE USER` statement `CONTAINER=ALL` clause can be used to create a common user account.
- [About Creating Local User Accounts](#)
Be aware of local user account restrictions such as where they can be created, naming conventions, and objects stored in their schemas.
- [CREATE USER Statement for Creating a Local User Account](#)
The `CREATE USER` statement `CONTAINER` clause can be used to create a local user account.

2.2.10.1 About Creating Common User Accounts

Be aware of common user account restrictions such as where they can be created, naming conventions, and objects stored in their schemas.

To create a common user account, follow these rules:

- To create a CDB common user, you must be connected to the CDB root and have the commonly granted `CREATE USER` system privilege.
- To create an application common user, you must be connected to the application root and have the commonly granted `CREATE USER` system privilege.
- You can run the `CREATE USER ... CONTAINER = ALL` statement to create an application common user in the application root. Afterward, you must synchronize the application so

that this user can be visible in the application PDB. For example, for an application named `saas_sales_app`:

```
ALTER PLUGGABLE DATABASE APPLICATION saas_sales_app SYNC;
```

- The name that you give the common user who connects to the CDB root must begin with the prefix that is defined in the `COMMON_USER_PREFIX` parameter in the CDB root, which by default is `C##`. (You can modify this parameter, but only do so with great caution.) It must contain only ASCII or EBCDIC characters. This naming requirement does not apply to the names of existing Oracle-supplied user accounts, such as `SYS` or `SYSTEM`. To find the names of existing user accounts, query the `ALL_USERS`, `CDB_USERS`, `DBA_USERS`, and `USER_USERS` data dictionary views.
- The name that you give the common user who connects to the application root must follow the naming conventions for standard user accounts. By default, the `COMMON_USER_PREFIX` parameter in the application root is set to an empty string. In other words, you can create a user named `hr_admin` in the application root but not a user named `c##hr_admin`.
- To explicitly designate a user account as a CDB or an application common user, in the `CREATE USER` statement, specify the `CONTAINER=ALL` clause. If you are logged into the CDB or application root, and if you omit the `CONTAINER` clause from your `CREATE USER` statement, then the `CONTAINER=ALL` clause is implied.
- Do not create objects in the schemas of common users for a CDB. Instead, you can create application common objects. These are objects whose metadata, and in case of data links or extended data links, data, is shared between all application PDBs that belong to the application container. You must create the application common object in the root of an application container.
- If you specify the `DEFAULT TABLESPACE`, `TEMPORARY TABLESPACE`, `QUOTA...ON`, and `PROFILE` clauses in the `CREATE USER` statement for a CDB or an application common user account, then you must ensure that these objects—tablespaces, tablespace groups, and profiles—exist in all containers of the CDB for a CDB common user, or in the application root and all PDBs of an application container for an application common user.

2.2.10.2 CREATE USER Statement for Creating a Common User Account

The `CREATE USER` statement `CONTAINER=ALL` clause can be used to create a common user account.

You must be in the CDB root to create a CDB common user account and the application root to create an application common user account.

The following example shows how to create a CDB common user account from the CDB root by using the `CONTAINER` clause, and then granting the user the `SET CONTAINER` and `CREATE SESSION` privileges. Common users must have the `SET CONTAINER` system privilege to navigate between containers. When you create the account, there is a single common password for this common user across all containers.

```
CONNECT SYSTEM
Enter password: password
Connected.

CREATE USER c##hr_admin
IDENTIFIED BY password
DEFAULT TABLESPACE data_ts
QUOTA 100M ON test_ts
QUOTA 500K ON data_ts
TEMPORARY TABLESPACE temp_ts
CONTAINER = ALL;
```



```
GRANT SET CONTAINER, CREATE SESSION TO c##hr_admin  
CONTAINER = ALL;
```

The next example shows how to create an application common user in the application root (`app_root`) by using the `CONTAINER` clause, and then granting the user the `SET CONTAINER`, and `CREATE SESSION` system privileges. Finally, to synchronize this user so that it is visible in the application PDBs, the `ALTER PLUGGABLE DATABASE APPLICATION APP$CON SYNC` statement is run.

```
CONNECT SYSTEM@app_root  
Enter password: password  
Connected.
```

```
CREATE USER app_admin  
IDENTIFIED BY password  
DEFAULT TABLESPACE data_ts  
QUOTA 100M ON temp_ts  
QUOTA 500K ON data_ts  
TEMPORARY TABLESPACE temp_ts  
CONTAINER = ALL;
```

```
GRANT SET CONTAINER, CREATE SESSION TO app_admin CONTAINER = ALL;
```

```
CONNECT SYSTEM@app_hr_pdb  
Enter password: password  
Connected.
```

```
ALTER PLUGGABLE DATABASE APPLICATION APP$CON SYNC;
```

Related Topics

- [Guidelines for Securing Passwords](#)
Oracle provides guidelines for securing passwords in a variety of situations.
- [About Common Users](#)
Oracle provides two types of common users: CDB common users and application common users.
- [Creating a Common User Account in Enterprise Manager](#)
A common user is a user that exists in the root and can access PDBs in the CDB.

2.2.10.3 About Creating Local User Accounts

Be aware of local user account restrictions such as where they can be created, naming conventions, and objects stored in their schemas.

To create a local user account, follow these rules:

- To create a local user account, you must be connected to the PDB in which you want to create the account, and have the `CREATE USER` privilege.
- The name that you give the local user must not start with a prefix that is reserved for common users, which by default is `C##` for CDB common users.
- You can include `CONTAINER=CURRENT` in the `CREATE USER` statement to specify the user as a local user. If you are connected to a PDB and omit this clause, then the `CONTAINER=CURRENT` clause is implied.
- You cannot have common users and local users with the same name. However, you can use the same name for local users in different PDBs. To find the names of existing user

accounts, query the `ALL_USERS`, `CDB_USERS`, `DBA_USERS`, and `USER_USERS` data dictionary views.

- Both common and local users connected to a PDB can create local user accounts, as long as they have the appropriate privileges.

2.2.10.4 CREATE USER Statement for Creating a Local User Account

The `CREATE USER` statement `CONTAINER` clause can be used to create a local user account.

You must create the local user account in the PDB where you want this account to reside.

The following example shows how to create a local user account using the `CONTAINER` clause.

```
CONNECT SYSTEM@pdb_name
Enter password: password
Connected.

CREATE USER kmurray
  IDENTIFIED BY password
  DEFAULT TABLESPACE data_ts
  QUOTA 100M ON test_ts
  QUOTA 500K ON data_ts
  TEMPORARY TABLESPACE temp_ts
  PROFILE hr_profile
  CONTAINER = CURRENT;
```

Related Topics

- [Guidelines for Securing Passwords](#)
Oracle provides guidelines for securing passwords in a variety of situations.
- [About Local Users](#)
A local user is a database user that exists only in a single PDB.
- [Creating a Common User Account in Enterprise Manager](#)
A common user is a user that exists in the root and can access PDBs in the CDB.

2.2.11 Creating a Default Role for the User

A default role is automatically enabled for a user when the user creates a session.

You can assign a user zero or more default roles. You cannot set default roles for a user in the `CREATE USER` statement. When you first create a user, the default role setting for the user is `ALL`, which causes all roles subsequently granted to the user to be default roles.

- Use the `ALTER USER` statement to change the default roles for the user.

For example:

```
GRANT USER rdale clerk_mgr;

ALTER USER rdale DEFAULT ROLE clerk_mgr;
```

Before a role can be made the default role for a user, that user must have been already granted the role.

Related Topics

- [Managing User Roles](#)
A user role is a named collection of privileges that you can create and assign to other users.

2.3 Altering User Accounts

The `ALTER USER` statement modifies user accounts, such their default tablespace or profile, or changing a user's password.

- [About Altering User Accounts](#)
Changing user security settings affects the future user sessions, not the current session.
- [Methods of Altering Common or Local User Accounts](#)
You can use the `ALTER USER` statement or the `PASSWORD` command to alter both common and local user accounts.
- [Changing Non-SYS User Passwords](#)
Users can change their own passwords but to change other users' passwords, they must have the correct privileges.
- [Changing the SYS User Password](#)
To change the `SYS` user password, you can use the `ALTER USER` statement, the `PASSWORD` command, or the `ORAPWD` command line utility.

2.3.1 About Altering User Accounts

Changing user security settings affects the future user sessions, not the current session.

In most cases, you can alter user security settings with the `ALTER USER SQL` statement. Users can change their own passwords. However, to change any other option of a user security domain, you must have the `ALTER USER` system privilege. Security administrators are typically the only users that have this system privilege, as it allows a modification of *any* user security domain. This privilege includes the ability to set tablespace quotas for a user on any tablespace in the database, even if the user performing the modification does not have a quota for a specified tablespace.

You must have the commonly granted `ALTER USER` system privilege to alter common user accounts. To alter local user accounts, you must have a commonly granted `ALTER USER` privilege or a locally granted `ALTER USER` privilege in the PDB in which the local user account resides.

2.3.2 Methods of Altering Common or Local User Accounts

You can use the `ALTER USER` statement or the `PASSWORD` command to alter both common and local user accounts.

You cannot change an existing common user account to be a local user account, or a local user account to be made into a common user account. In this case, you must create a new account, as either a common user account or a local user account.

The following example shows how to use the `ALTER USER` statement to restrict user `c##hr_admin`'s ability to view `V$SESSION` rows to those that pertain to sessions that are connected to `CDB$ROOT`, and to the `emp_db` and `hr_db` PDBs.

```
CONNECT SYSTEM
Enter password: password
Connected.

ALTER USER c##hr_admin
  DEFAULT TABLESPACE data_ts
  TEMPORARY TABLESPACE temp_ts
```

```
QUOTA 100M ON data_ts
QUOTA 0 ON test_ts
SET CONTAINER_DATA = (emp_db, hr_db) FOR V$SESSION
CONTAINER = CURRENT;
```

The `ALTER USER` statement here changes the security settings for the user `c##hr_admin` as follows:

- `DEFAULT TABLESPACE` and `TEMPORARY TABLESPACE` are set explicitly to `data_ts` and `temp_ts`, respectively.
- `QUOTA 100M` gives the `data_ts` tablespace 100 MB.
- `QUOTA 0` revokes the quota on the `temp_ts` tablespace.
- `SET CONTAINER_DATA` enables user `c##hr_admin` to have access to data related to the `emp_db` and `hr_db` PDBs as well as the root when they query the `V$SESSION` view from the root.

To change passwords, you can use `ALTER USER`, but Oracle recommends that you use the `PASSWORD` command to change passwords, for both non-SYS and SYS user accounts.

Related Topics

- [Oracle Database SQL Language Reference](#)
- [About Changing Non-SYS User Passwords](#)
Users can use either the `PASSWORD` command or `ALTER USER` statement to change a password.
- [About Changing the SYS User Password](#)
The method of changing the `SYS` password that you choose will depend on how your database is configured (for example, how the `REMOTE_LOGIN_PASSWORDFILE` initialization parameter is set).

2.3.3 Changing Non-SYS User Passwords

Users can change their own passwords but to change other users' passwords, they must have the correct privileges.

- [About Changing Non-SYS User Passwords](#)
Users can use either the `PASSWORD` command or `ALTER USER` statement to change a password.
- [Using the PASSWORD Command or ALTER USER Statement to Change a Password](#)
Most users can change their own passwords with the SQL*Plus `PASSWORD` command or the `ALTER USER SQL` statement.

2.3.3.1 About Changing Non-SYS User Passwords

Users can use either the `PASSWORD` command or `ALTER USER` statement to change a password.

No special privileges (other than those to connect to the database and create a session) are required for a user to change their own password. Encourage users to change their passwords frequently. You can find existing users for the current database instance by querying the `ALL_USERS` view.

For better security, use the `PASSWORD` command to change the account's password. The `ALTER USER` statement displays the new password on the screen, where it can be seen by any overly curious coworkers. The `PASSWORD` command does not display the new password, so it is only

known to you, not to your co-workers. The `PASSWORD` command also encrypts the password on the network. `ALTER USER` will send the password in clear text, so you should not use it unless the network connection between the client and database is encrypted or the session is a local session not routed over the network.

Users must have the `PASSWORD` and `ALTER USER` privilege to switch between methods of authentication. Usually, only an administrator has this privilege.

Related Topics

- [Minimum Requirements for Passwords](#)
Oracle provides a set of minimum requirements for passwords.
- [Guidelines for Securing Passwords](#)
Oracle provides guidelines for securing passwords in a variety of situations.
- [Configuring Authentication](#)
Authentication means to verify the identity of users or other entities that connect to the database.

2.3.3.2 Using the `PASSWORD` Command or `ALTER USER` Statement to Change a Password

Most users can change their own passwords with the SQL*Plus `PASSWORD` command or the `ALTER USER SQL` statement.

A CDB common user must change their password in the CDB root, and an application common user must change their password in the application root. As with all passwords, ensure that the new password is secure.

- Use one of the following methods to change a user's password:
 - To use the SQL*Plus `PASSWORD` command to change a password, supply the user's name, and when prompted, enter the new password.

For example:

```
PASSWORD andy
Changing password for andy
New password: password
Retype new password: password
```
 - To use the `ALTER USER SQL` statement change a password, include the `IDENTIFIED BY` clause.

For example:

```
ALTER USER andy IDENTIFIED BY password;
```

Related Topics

- [Guidelines for Securing Passwords](#)
Oracle provides guidelines for securing passwords in a variety of situations.

2.3.4 Changing the `SYS` User Password

To change the `SYS` user password, you can use the `ALTER USER` statement, the `PASSWORD` command, or the `ORAPWD` command line utility.

- [About Changing the SYS User Password](#)
The method of changing the `SYS` password that you choose will depend on how your database is configured (for example, how the `REMOTE_LOGIN_PASSWORDFILE` initialization parameter is set).
- [ORAPWD Utility for Changing the SYS User Password](#)
The `ORAPWD` utility enables you to change the `SYS` user password.

2.3.4.1 About Changing the SYS User Password

The method of changing the `SYS` password that you choose will depend on how your database is configured (for example, how the `REMOTE_LOGIN_PASSWORDFILE` initialization parameter is set).

You can use the `PASSWORD` command, the `ALTER USER` statement, or the `ORAPWD` utility to change `SYS` password.

As with non-`SYS` user accounts, there are good reasons for using `PASSWORD` to change the `SYS` user account. `PASSWORD` does not show the new password on the screen, and `PASSWORD` also encrypts the password over the network. `ALTER USER` will send the password in clear text, so you should not use it unless the network connection between the client and database is encrypted or the session is a local session not routed over the network. Hence, you should use `PASSWORD` for remote connections.

The `ALTER USER` statement has the following advantages over using `ORAPWD`:

- It enables you to change the `SYS` user password from within the Oracle database instance.
- In an Oracle Data Guard environment, it propagates the `SYS` password change to Oracle Data Guard instances.

Be aware that Oracle Real Application Clusters (Oracle RAC) databases using a shared password file will have `REMOTE_LOGIN_PASSWORDFILE = SHARED`, which prevents `ALTER USER` from updating `SYS` password. If the password file is not shared and the password is changed, then you must copy the password file to all the nodes in the Oracle RAC cluster.

If the `REMOTE_LOGIN_PASSWORDFILE` initialization parameter is set and you want to use `ALTER USER` to change the `SYS` password, then note the following:

- Ensure that the `REMOTE_LOGIN_PASSWORDFILE` initialization parameter is set to `EXCLUSIVE`. Otherwise, the `SYS` user password change (or any administrative user password change) attempt will fail.
- If `REMOTE_LOGIN_PASSWORDFILE` is null or set to `NONE`, then the password change attempt fails with an `ORA-01994` error.
- If `REMOTE_LOGIN_PASSWORDFILE` is set to `SHARED`, then using the `ALTER USER` statement to change the password fails with an `ORA-28046` error.

If you want to use `ORAPWD` to change the `SYS` password, then note the following:

- Before you can change the password of the `SYS` user account, a password file must exist for this account.
- If the instance initialization parameter `REMOTE_LOGIN_PASSWORDFILE` is set to `SHARED` or is null, then you must use `ORAPWD` to change the `SYS` password.

The following applies to both the `ALTER USER` and `ORAPWD` methods of changing the `SYS` user password:

- New accounts are created with the SHA-2 (SHA-512) verifier. SYS user verifiers are generated based on the `sqlnet.ora` parameter `ALLOWED_LOGON_VERSION_SERVER`. You can identify these accounts by querying the `PASSWORD_VERSIONS` column of the `DBA_USERS` data dictionary view. (These verifiers are listed as 12C in the `PASSWORD_VERSIONS` column of the `DBA_USERS` view output.)
- In an Oracle Real Application Clusters (Oracle RAC) environment, store the password in the ASM disk group so that it can be shared by multiple Oracle RAC instances.

Related Topics

- [Ensuring Against Password Security Threats by Using the 12C Password Version](#)
The 12C password version enables users to create complex passwords that meet compliance standards.
- *Oracle Database Administrator's Guide*

2.3.4.2 ORAPWD Utility for Changing the SYS User Password

The `ORAPWD` utility enables you to change the `SYS` user password.

You can use the `ORAPWD` utility with the `INPUT_FILE` parameter to change the `SYS` user password. To migrate the password files to a specific format, include the `FORMAT` option. By default, the format is 12.2 if you do not specify the `FORMAT` option.

To set a new password for the `SYS` user using the `ORAPWD` utility, set the `SYS` option to `Y` (yes), use the `INPUT_FILE` parameter to specify the current password file name, and use the `FILE` parameter to create the password file to which the original password file is migrated. For example:

```
ORAPWD INPUT_FILE='orapworcl' FILE='orapwd' SYS=Y
Enter password for SYS: new_password
```

Replace `new_password` with a password that is secure. If you do not want to migrate the password file to a different format, then you can specify the same format as the `input_file`. For example, assuming that the input file `orapworcl` format is 12 and you want to change the `SYS` user password:

```
ORAPWD INPUT_FILE='orapworcl' FILE='orapwd' FORMAT=12 SYS=Y
Enter password for SYS: new_password
```

Related Topics

- *Oracle Database Administrator's Guide*
- [Guidelines for Securing Passwords](#)
Oracle provides guidelines for securing passwords in a variety of situations.

2.4 Configuring User Resource Limits

A resource limit defines the amount of system resources that are available for a user.

- [About User Resource Limits](#)
You can set limits on the amount of system resources available to each user as part of the security domain of that user.
- [Types of System Resources and Limits](#)
You can limit several types of system resources, including CPU time and logical reads, at the session level, call level, or both.

- [Values for Resource Limits of Profiles](#)
Before you create profiles and set resource limits, you should determine appropriate values for each resource limit.
- [Managing Resources with Profiles](#)
A profile is a named set of resource limits and password parameters that restrict database usage and instance resources for a user.
- [Common Mandatory Profiles in the CDB Root](#)
You can enforce a minimum password length throughout the CDB and its PDBs without restricting access to database user profiles.

2.4.1 About User Resource Limits

You can set limits on the amount of system resources available to each user as part of the security domain of that user.

By doing so, you can prevent the uncontrolled consumption of valuable system resources such as CPU time.

This resource limit feature is very useful in large, multiuser systems, where system resources are very expensive. Excessive consumption of these resources by one or more users can detrimentally affect the other users of the database. In single-user or small-scale multiuser database systems, the system resource feature is not as important, because user consumption of system resources is less likely to have a detrimental impact.

You manage user resource limits by using Database Resource Manager. You can set password management preferences using profiles, either set individually or using a default profile for many users. Each Oracle database can have an unlimited number of profiles. Oracle Database allows the security administrator to enable or disable the enforcement of profile resource limits universally.

Setting resource limits causes a slight performance degradation when users create sessions, because Oracle Database loads all resource limit data for each user upon each connection to the database.

Related Topics

- *Oracle Database Administrator's Guide*

2.4.2 Types of System Resources and Limits

You can limit several types of system resources, including CPU time and logical reads, at the session level, call level, or both.

- [Limits to the User Session Level](#)
When a user connects to a CDB or PDB, a session is created. Sessions use CPU time and memory, on which you can set limits.
- [Limits to Database Call Levels](#)
Each time a user runs a SQL statement, Oracle Database performs several steps to process the statement.
- [Limits to CPU Time](#)
When SQL statements and other calls are made to an Oracle CDB or PDB, CPU time is necessary to process the call.
- [Limits to Logical Reads](#)
Input/output (I/O) is one of the most expensive operations in a database system.

- [Limits to Other Resources](#)
You can control limits for user concurrent sessions and idle time.

2.4.2.1 Limits to the User Session Level

When a user connects to a CDB or PDB, a session is created. Sessions use CPU time and memory, on which you can set limits.

You can set several resource limits at the session level. If a user exceeds a session-level resource limit, then Oracle Database terminates (rolls back) the current statement and returns a message indicating that the session limit has been reached. At this point, all previous statements in the current transaction are intact, and the only operations the user can perform are `COMMIT`, `ROLLBACK`, or disconnect (in this case, the current transaction is committed). All other operations produce an error. Even after the transaction is committed or rolled back, the user cannot accomplish any more work during the current session.

2.4.2.2 Limits to Database Call Levels

Each time a user runs a SQL statement, Oracle Database performs several steps to process the statement.

During the SQL statement processing, several calls are made to the database as a part of the different execution phases. To prevent any one call from using the system excessively, Oracle Database lets you set several resource limits at the call level.

If a user exceeds a call-level resource limit, then Oracle Database halts the processing of the statement, rolls back the statement, and returns an error. However, all previous statements of the current transaction remain intact, and the user session remains connected.

2.4.2.3 Limits to CPU Time

When SQL statements and other calls are made to an Oracle CDB or PDB, CPU time is necessary to process the call.

Average calls require a small amount of CPU time. However, a SQL statement involving a large amount of data or a runaway query can potentially use a large amount of CPU time, reducing CPU time available for other processing.

To prevent uncontrolled use of CPU time, you can set fixed or dynamic limits on the CPU time for each call and the total amount of CPU time used for Oracle Database calls during a session. The limits are set and measured in CPU one-hundredth seconds (0.01 seconds) used by a call or a session.

2.4.2.4 Limits to Logical Reads

Input/output (I/O) is one of the most expensive operations in a database system.

SQL statements that are I/O-intensive can monopolize memory and disk use and cause other database operations to compete for these resources.

To prevent single sources of excessive I/O, you can limit the logical data block reads for each call and for each session. Logical data block reads include data block reads from both memory and disk. The limits are set and measured in number of block reads performed by a call or during a session.

2.4.2.5 Limits to Other Resources

You can control limits for user concurrent sessions and idle time.

Limits to other resources are as follows:

- **You can limit the number of concurrent sessions for each user.** Each user can create only up to a predefined number of concurrent sessions.
- **You can limit the idle time for a session.** If the time between calls in a session reaches the idle time limit, then the current transaction is rolled back, the session is terminated, and the resources of the session are returned to the system. The next call receives an error that indicates that the user is no longer connected to the instance. This limit is set as a number of elapsed minutes.

 **Note:**

Shortly after a session is terminated because it has exceeded an idle time limit, the process monitor (PMON) background process cleans up after the terminated session. Until PMON completes this process, the terminated session is still counted in any session or user resource limit.

- **You can limit the elapsed connect time for each session.** If the duration of a session exceeds the elapsed time limit, then the current transaction is rolled back, the session is dropped, and the resources of the session are returned to the system. This limit is set as a number of elapsed minutes.

 **Note:**

Oracle Database does not constantly monitor the elapsed idle time or elapsed connection time. Doing so reduces system performance. Instead, it checks every few minutes. Therefore, a session can exceed this limit slightly (for example, by 5 minutes) before Oracle Database enforces the limit and terminates the session.

- **You can limit the amount of private System Global Area (SGA) space (used for private SQL areas) for a session.** This limit is only important in systems that use the shared server configuration. Otherwise, private SQL areas are located in the Program Global Area (PGA). This limit is set as a number of bytes of memory in the SGA of an instance. Use the characters **K** or **M** to specify kilobytes or megabytes.

2.4.3 Values for Resource Limits of Profiles

Before you create profiles and set resource limits, you should determine appropriate values for each resource limit.

You can base the resource limit values on the type of operations a typical user performs. For example, if one class of user does not usually perform a high number of logical data block reads, then use the `ALTER RESOURCE COST SQL` statement to set the `LOGICAL_READS_PER_SESSION` setting conservatively.

Usually, the best way to determine the appropriate resource limit values for a given user profile is to gather historical information about each type of resource usage. For example, the

database or security administrator can use the `AUDIT SESSION` clause to gather information about the limits `CONNECT_TIME`, `LOGICAL_READS_PER_SESSION`.

In an Oracle Data Guard environment, an active standby database is opened in read-only mode. This allows user connections on it in the same way as on a primary database. Hence, all the password resource-related limits of a given user profile will work independently between them, except for the ones that imply or require a user password change in the standby database; this task cannot be performed in a database that is opened in read-only mode.

You can gather statistics for other limits using the Monitor feature of Oracle Enterprise Manager (or SQL*Plus), specifically the Statistics monitor.

2.4.4 Managing Resources with Profiles

A profile is a named set of resource limits and password parameters that restrict database usage and instance resources for a user.

- [About Profiles](#)
A profile is a collection of attributes that apply to a user.
- [ORA_CIS_PROFILE User Profile](#)
The `ORA_CIS_PROFILE` user profile is designed for Center for Internet Security (CIS) compliance.
- [ORA_STIG_PROFILE User Profile](#)
The `ORA_STIG_PROFILE` user profile complies with the Security Technical Implementation Guide's requirements.
- [Creating a Profile](#)
A profile can encompass limits for a specific category, such as limits on passwords or limits on resources.
- [Creating a CDB Profile or an Application Profile](#)
The `CREATE PROFILE` or `ALTER PROFILE` statement `CONTAINER=ALL` clause can create a profile in a CDB or application root.
- [Assigning a Profile to a User](#)
After you create a profile, you can assign it to users.
- [Dropping Profiles](#)
You can drop a profile, even if it is currently assigned to a user.

2.4.4.1 About Profiles

A profile is a collection of attributes that apply to a user.

The **profile** is used to enable a single point of reference for multiple users who share these attributes.

You should assign a profile to each user. Each user can have only one profile, and creating a new one supersedes an earlier assignment.

You can create and manage user profiles only if resource limits are a requirement of your database security policy. To use profiles, first categorize the related types of users in a database. Just as roles are used to manage the privileges of related users, profiles are used to manage the resource limits of related users. Determine how many profiles are needed to encompass all categories of users in a database and then determine appropriate resource limits for each profile.

User profiles in Oracle Internet Directory contain attributes pertinent to directory usage and authentication for each user. Similarly, profiles in Oracle Label Security contain attributes useful in label security user administration and operations management. Profile attributes can include restrictions on system resources. You can use Database Resource Manager to set these types of resource limits. Profiles are useful for the administration and operations performed in the container databases (CDBs) and application containers, as well as their associated pluggable databases (PDBs). For both CDB and application containers, if you define a common profile, then the profile applies to the entire container and not outside this container. If you create a local profile, then it applies to that PDB only.

Profile resource limits are enforced only when you enable resource limitation for the associated database. Enabling this limitation can occur either before starting the database (using the `RESOURCE_LIMIT` initialization parameter) or while it is open (using the `ALTER SYSTEM` statement).

Though password parameters reside in profiles, they are unaffected by `RESOURCE_LIMIT` or `ALTER SYSTEM` and password management is always enabled. In Oracle Database, Database Resource Manager primarily handles resource allocations and restrictions.

Any authorized database user can create, assign to users, alter, and drop a profile at any time (using the `CREATE USER` or `ALTER USER` statement). Profiles can be assigned only to users and not to roles or other profiles. Profile assignments do not affect current sessions; instead, they take effect only in subsequent sessions.

To find information about current profiles, query the `DBA_PROFILES` view.

 **See Also:**

Oracle Database Administrator's Guide for detailed information about managing resources

2.4.4.2 ORA_CIS_PROFILE User Profile

The `ORA_CIS_PROFILE` user profile is designed for Center for Internet Security (CIS) compliance.

The `ORA_CIS_PROFILE` user profile addresses CIS requirements such as the need for a password complexity function, maximum failed login attempts, reuse time, and other requirements. The definition for this profile is as follows:

```
CREATE PROFILE ORA_CIS_PROFILE
  sessions_per_user 10
  failed_login_attempts 5
  password_life_time 90
  password_reuse_time 365
  password_reuse_max 20
  password_lock_time 1
  password_grace_time 5
  inactive_account_time 120
  password_verify_function ora12c_verify_function
```

2.4.4.3 ORA_STIG_PROFILE User Profile

The `ORA_STIG_PROFILE` user profile complies with the Security Technical Implementation Guide's requirements.

The `ORA_STIG_PROFILE` user profile addresses STIG requirements such as the need for a password complexity function, maximum failed login attempts, reuse time, and other requirements. The definition for this profile is as follows:

```
CREATE PROFILE ORA_STIG_PROFILE
  password_life_time          35
  password_grace_time         0
  password_reuse_time         175
  password_reuse_max          5
  failed_login_attempts       3
  password_lock_time          unlimited
  inactive_account_time       35
  idle_time                   15
  password_verify_function    ora12c_stig_verify_function;
```

2.4.4.4 Creating a Profile

A profile can encompass limits for a specific category, such as limits on passwords or limits on resources.

To create a profile, you must have the `CREATE PROFILE` system privilege. To find all existing profiles, you can query the `DBA_PROFILES` view.

- Use the `CREATE PROFILE` statement to create a profile.

For example, to create a profile that defines password limits:

```
CREATE PROFILE password_prof LIMIT
  FAILED_LOGIN_ATTEMPTS 6
  PASSWORD_LIFE_TIME 60
  PASSWORD_REUSE_TIME 60
  PASSWORD_REUSE_MAX 5
  PASSWORD_LOCK_TIME 1/24
  PASSWORD_GRACE_TIME 10
  PASSWORD_VERIFY_FUNCTION DEFAULT;
```

This profile can be created locally in a PDB. If you are creating a common profile, then you must provide the profile name with the `c##` prefix (for example, `c##password_prof`).

The following example shows how to create a resource limits profile.

```
CREATE PROFILE app_user LIMIT
  SESSIONS_PER_USER          UNLIMITED
  CPU_PER_SESSION            UNLIMITED
  CPU_PER_CALL                3500
  CONNECT_TIME                50
  LOGICAL_READS_PER_SESSION  DEFAULT
  LOGICAL_READS_PER_CALL     1200
  PRIVATE_SGA                 20K
  COMPOSITE_LIMIT             7500000;
```

Related Topics

- *Oracle Database SQL Language Reference*

2.4.4.5 Creating a CDB Profile or an Application Profile

The `CREATE PROFILE` or `ALTER PROFILE` statement `CONTAINER=ALL` clause can create a profile in a CDB or application root.

You cannot create local profiles in the CDB root or the application root. The profile that you create will be applied to all PDBs that are associated with the CDB root or the application root.

- To create a profile in a CDB root or an application root, optionally include the `CONTAINER=ALL` clause in the `CREATE PROFILE` or `ALTER PROFILE` statement.

The `CONTAINER=ALL` clause is optional because it is the default when the statement is processed.

For example:

```
CREATE PROFILE password_prof LIMIT
  FAILED_LOGIN_ATTEMPTS 6
  PASSWORD_LIFE_TIME 60
  PASSWORD_REUSE_TIME 60
  PASSWORD_REUSE_MAX 5
  PASSWORD_LOCK_TIME 1/24
  PASSWORD_GRACE_TIME 10
  PASSWORD_VERIFY_FUNCTION DEFAULT
  CONTAINER=ALL;
```

2.4.4.6 Assigning a Profile to a User

After you create a profile, you can assign it to users.

You can assign a profile to a user who has already been assigned a profile, but the most recently assigned profile takes precedence. When you assign a profile to an external user or a global user, the password parameters do not take effect for that user.

To find the profiles that are currently assigned to users, you can query the `DBA_USERS` view.

- Use the `ALTER USER` statement to assign the profile to a user.

For example:

```
ALTER USER psmith PROFILE app_user;
```

2.4.4.7 Dropping Profiles

You can drop a profile, even if it is currently assigned to a user.

When you drop a profile, the drop does not affect currently active sessions. Only sessions that were created after a profile is dropped use the modified profile assignments. To drop a profile, you must have the `DROP PROFILE` system privilege. You cannot drop the default profile.

- Use the SQL statement `DROP PROFILE` to drop a profile. To drop a profile that is currently assigned to a user, use the `CASCADE` option.

For example:

```
DROP PROFILE clerk CASCADE;
```

Any user currently assigned to a profile that is dropped is automatically assigned to the `DEFAULT` profile. The `DEFAULT` profile cannot be dropped.

Related Topics

- [Oracle Database SQL Language Reference](#)

2.4.5 Common Mandatory Profiles in the CDB Root

You can enforce a minimum password length throughout the CDB and its PDBs without restricting access to database user profiles.

- [About Common Mandatory Profiles in the CDB Root](#)
The mandatory user profile imposes mandatory profile limits across the entire CDB or for individual PDBs.
- [Creating a Common Mandatory Profile in the CDB Root](#)
To create and manage the mandatory profile, you use the `CREATE MANDATORY PROFILE` and `ALTER SYSTEM` statements.
- [Example: Function to Enforce Minimum Password Length](#)
You can use the `MANDATORY_VERIFY_FUNCTION` parameter to create complex functions that perform tasks such as checking the minimum password length of user passwords.

2.4.5.1 About Common Mandatory Profiles in the CDB Root

The mandatory user profile imposes mandatory profile limits across the entire CDB or for individual PDBs.

The limits that you define in this mandatory user profile can be enforced in addition to the already existing limits in the profile for which the user is currently associated. Hence, you can use mandatory profiles to enforce the password complexity rules for all the user accounts in the database, regardless of the profile limits that are enforced in individual PDBs. For example, if a user profile limit states that the user must have at least 8 characters in the password but the mandatory profile states the user must have 10, then the 10-character limit will take precedence. User profile restrictions that are not in the mandatory profile still take effect. Only password length is enforced in a mandatory profile.

The password complexity verification function of the mandatory profile runs before the password complexity function that is associated with the user account profile (assuming this profile has a password complexity function). The mandatory profile limits apply for all local and common users in the entire CDB, so they can be used to enforce a CDB-wide password policy that is always active.

Because the mandatory profile is a common profile that is created in the CDB root, PDB administrators cannot alter or drop this profile in an attempt to circumvent the mandatory profile's user restrictions. Only common users who have been commonly granted the `ALTER PROFILE` system privilege can alter or drop the mandatory profile, and only from the CDB root. Only a common user who has been commonly granted the `ALTER SYSTEM` privilege or has the `SYSDBA` administrative privilege can modify the `MANDATORY_USER_PROFILE` in the `init.ora` file.

Unlike other user profiles, you cannot assign the mandatory profile to a user. Any attempt to do so will result in an `ORA-02384: cannot assign profile_name profile to a user error`.

You can create multiple mandatory profiles in the CDB root, which you then can use to configure different mandatory limits at the PDB level.

If you want to apply the mandatory user profile for all PDBs in the CDB, then you must do so in the CDB root using the `ALTER SYSTEM` statement. If you want to apply the mandatory user profile for individual PDBs, then you must configure it in the `init.ora` file that is associated with the PDB. The mandatory profile that you set in `init.ora` takes precedence over the

mandatory profile that you set with the `ALTER SYSTEM` statement in the CDB root. This functionality enables you to have the following use case: suppose you have a CDB with 20 PDBs, two of which must have a different mandatory profile set from the remaining 18. To accomplish this, do the following:

1. Create two mandatory profiles, one for the two PDBs and a second mandatory profile for the remaining 18.
2. For the two PDBs, edit the `init.ora` file to point to the mandatory profile that you want these PDBs to use.
3. For the remaining PDBS, run the `ALTER SYSTEM` statement in the CDB root to point to the mandatory profile that these PDBs need to use

2.4.5.2 Creating a Common Mandatory Profile in the CDB Root

To create and manage the mandatory profile, you use the `CREATE MANDATORY PROFILE` and `ALTER SYSTEM` statements.

1. Connect to the CDB root as a common user who has the `CREATE PROFILE` and `ALTER SYSTEM` system privileges.

For example:

```
CONNECT c##sec_admin
Enter password: password
```

2. Create the mandatory profile.

For example, to create a mandatory profile called `c##cdb_profile` that will use the `cdb_mandatory_function` password verification function:

```
CREATE MANDATORY PROFILE c##cdb_profile
LIMIT PASSWORD_VERIFY_FUNCTION cdb_mandatory_function
CONTAINER = ALL;
```

In this specification:

- `LIMIT` restricts the profile so that it only uses a specific password verification function (`cdb_mandatory_function`).
- `PASSWORD_VERIFY_FUNCTION` specifies the user-created password complexity function `cdb_mandatory_function`. `PASSWORD_VERIFY_FUNCTION` is the only allowed parameter for `CREATE MANDATORY PROFILE`.
- `CONTAINER = ALL` applies the profile to the entire CDB. If you want to set a different profile (for example, a stricter one) on a PDB in this CDB, then you can still apply a mandatory profile on that PDB to override the one that was set for the entire CDB. In an Oracle Autonomous Data Warehouse (ADW) environment, note that the lockdown profile will be used so that a local administrator cannot set or change the PDB-specific mandatory profile.

You can create multiple mandatory profiles if you want (for example, one for the entire CDB and others for individual PDBs).

3. Apply the mandatory profile to either the entire CDB environment or to individual pluggable databases (PDBs) within the CDB.

To find the current `MANDATORY_USER_PROFILE` parameter setting, you can use the `SHOW PARAMETER` command.

- For all PDBs in the CDB, from the root, run the ALTER SYSTEM statement. For example:

```
ALTER SYSTEM SET MANDATORY_USER_PROFILE=c##cdb_profile;
```

- For individual PDBs, set the MANDATORY_USER_PROFILE parameter in the init.ora file. For example, assuming that you created a PDB-specific mandatory profile called c##pdb_profile:

```
MANDATORY_USER_PROFILE = c##pdb_profile
```

2.4.5.3 Example: Function to Enforce Minimum Password Length

You can use the MANDATORY_VERIFY_FUNCTION parameter to create complex functions that perform tasks such as checking the minimum password length of user passwords.

This example shows how to create a common password function and how it works with the CDB root and a PDB.

1. Connect to the CDB as an administrative user.

```
CONNECT sec_admin@cdb_name;  
Enter password: password
```

2. Create a CDB common mandatory profile.

```
CREATE MANDATORY PROFILE c##mand LIMIT PASSWORD_VERIFY_FUNCTION NULL;
```

```
Profile created.
```

3. Check the profile that you just created.

```
SELECT RESOURCE_NAME, LIMIT, PROFILE FROM DBA_PROFILES WHERE PROFILE =  
'C##MAND';
```

RESOURCE_NAME	LIMIT	PROFILE
COMPOSITE_LIMIT		C##MAND
SESSIONS_PER_USER		C##MAND
CPU_PER_SESSION		C##MAND
CPU_PER_CALL		C##MAND
LOGICAL_READS_PER_SESSION		C##MAND
LOGICAL_READS_PER_CALL		C##MAND
IDLE_TIME		C##MAND
CONNECT_TIME		C##MAND
PRIVATE_SGA		C##MAND
FAILED_LOGIN_ATTEMPTS		C##MAND
PASSWORD_LIFE_TIME		C##MAND
PASSWORD_REUSE_TIME		C##MAND
PASSWORD_REUSE_MAX		C##MAND
PASSWORD_VERIFY_FUNCTION	NULL	C##MAND
PASSWORD_LOCK_TIME		C##MAND
PASSWORD_GRACE_TIME	0	C##MAND
INACTIVE_ACCOUNT_TIME		C##MAND
PASSWORD_ROLLOVER_TIME		C##MAND

18 rows selected.

4. Create the `my_mandatory_verify_function` function, which will enforce the minimum password length.

```
CREATE OR REPLACE FUNCTION my_mandatory_verify_function
  ( username      varchar2,
    password      varchar2,
    old_password  varchar2)
  return boolean IS
BEGIN
  -- mandatory verify function will always be evaluated regardless of the
  -- password verify function that is associated to a particular profile/
  user
  -- requires the minimum password length to be 8 characters
  if not ora_complexity_check(password, chars => 8) then
    return(false);
  end if;
  return(true);
END;
/
```

Function created.

5. Attach the `mandatory_verify_function` function to the `c##mand` profile.

```
ALTER PROFILE c##mand LIMIT PASSWORD_VERIFY_FUNCTION
my_mandatory_verify_function;
```

Profile altered.

6. Set the `MANDATORY_USER_PROFILE` parameter in the `CDB$ROOT` so that all the PDBs inherit the same mandatory profile and limits.

```
ALTER SYSTEM SET MANDATORY_USER_PROFILE=c##mand;
```

System altered.

7. Check the `MANDATORY_USER_PROFILE` parameter setting for the CDB.

```
SHOW PARAMETER MANDATORY_USER_PROFILE
```

NAME	TYPE	VALUE
-----	-----	
mandatory_user_profile	string	C##MAND

8. Switch to a PDB.

You can find the names of PDBs by executing the `SELECT PDB_NAME FROM DBA_PDBS` query. For example, to switch to PDB `hrpdb`:

```
ALTER SESSION SET CONTAINER=hrpdb;
```

Session altered.

9. Check the `MANDATORY_USER_PROFILE` parameter setting for the PDB.

```
SHOW PARAMETER MANDATORY_USER_PROFILE
```

NAME	TYPE	VALUE
mandatory_user_profile	string	C##MAND

10. Check the `c##mand` profile as it is set for the PDB.

```
SELECT RESOURCE_NAME, LIMIT, PROFILE FROM DBA_PROFILES WHERE PROFILE = 'C##MAND';
```

RESOURCE_NAME	LIMIT	PROFILE
COMPOSITE_LIMIT		C##MAND
SESSIONS_PER_USER		C##MAND
CPU_PER_SESSION		C##MAND
CPU_PER_CALL		C##MAND
LOGICAL_READS_PER_SESSION		C##MAND
LOGICAL_READS_PER_CALL		C##MAND
IDLE_TIME		C##MAND
CONNECT_TIME		C##MAND
PRIVATE_SGA		C##MAND
FAILED_LOGIN_ATTEMPTS		C##MAND
PASSWORD_LIFE_TIME		C##MAND
PASSWORD_REUSE_TIME		C##MAND
PASSWORD_REUSE_MAX		C##MAND
PASSWORD_VERIFY_FUNCTION	NULL	C##MAND
PASSWORD_LOCK_TIME		C##MAND
PASSWORD_GRACE_TIME	0	C##MAND
INACTIVE_ACCOUNT_TIME		C##MAND
PASSWORD_ROLLOVER_TIME		C##MAND

18 rows selected.

11. Return to the CDB root.

```
ALTER SESSION SET CONTAINER=CDB$ROOT;
```

Session altered.

12. Test the `my_mandatory_verify_function` function and `c##mand` profile by attempting to create a user whose password is less than 8 characters.

```
CREATE USER c##jack IDENTIFIED BY lame;
```

The following error is returned:

```
ERROR at line 1:
ORA-28219: password verification failed for mandatory profile
ORA-20000: password length less than 8 characters
```

- 13. Now try creating the common user's password correctly:**

```
CREATE USER c##jack IDENTIFIED BY correct_password;

User created.
```

- 14. Try altering c##jack's password to be of an incorrect length:**

```
ALTER USER c##jack IDENTIFIED BY lame;
```

The following error is returned:

```
ERROR at line 1:
ORA-28219: password verification failed for mandatory profile
ORA-20000: password length less than 8 characters
```

If user c##jack tries to change their password to be less than 8 characters, then the same errors are returned.

- 15. Connect back to PDB.**

```
ALTER SESSION SET CONTAINER=hrpdb;

Session altered.
```

- 16. Try creating a local user using less than 8 characters for the password.**

```
CREATE USER jessica IDENTIFIED BY lame;

ERROR at line 1:
ORA-28219: password verification failed for mandatory profile
ORA-20000: password length less than 8 characters
```

- 17. Create user jessica with the correct password requirement.**

```
CREATE USER jessica IDENTIFIED BY correct_password;

User created.
```

- 18. Create a custom password verify function for the PDB.**

This verify function requires that the password be at least 6 characters long with at least 2 digits.

```
CREATE OR REPLACE FUNCTION custom_verify_function
( username    varchar2,
  password    varchar2,
  old_password varchar2)
return boolean IS
```

```
BEGIN
  -- requires the password to be at least 6 characters long and minimum
  -- 2 digits be present
  if not ora_complexity_check(password, chars => 6, digit=>2) then
    return(false);
  end if;
  return(true);
END;
/
```

Function created.

19. Create a local profile and then associate it with the `custom_verify_function` function.

```
CREATE PROFILE lprofile LIMIT password_verify_function
custom_verify_function;
```

Profile created.

20. Assign profile `lprofile` to the local user `jessica`.

```
ALTER USER jessica PROFILE lprofile;
```

User altered.

21. Try changing user `jessica`'s password to one that uses 6 characters.

```
ALTER USER jessica IDENTIFIED BY six_66;
```

```
ERROR at line 1:
ORA-28219: password verification failed for mandatory profile
ORA-20000: password length less than 8 characters
```

Even though user `jessica`'s password meets the requirements of the `custom_verify_function` function, the common function `my_mandatory_verify_function` overrides the local function `custom_verify_function`.

2.5 Dropping User Accounts

You can drop user accounts if the user is not in a session, and if the user has objects in the user's schema.

- [About Dropping User Accounts](#)
Before you drop a user account, you must ensure that you have the appropriate privileges for doing so.
- [Terminating a User Session](#)
A user who is connected to a database cannot be dropped.
- [About Dropping a User After the User Is No Longer Connected to the Database](#)
After a user is disconnected from the database, you can use the `DROP USER` statement to drop the user.
- [Dropping a User Whose Schema Contains Objects](#)
Before you drop a user whose schema contains objects, carefully investigate the implications of dropping these schema objects.

2.5.1 About Dropping User Accounts

Before you drop a user account, you must ensure that you have the appropriate privileges for doing so.

To drop a user account in any environment, you must have the `DROP USER` system privilege. To drop common user accounts, you must have the commonly granted `DROP USER` system privilege. To drop local user accounts, you must have a commonly granted `DROP USER` privilege or a locally granted `DROP USER` privilege in the PDB in which the local user account resides.

When you drop a user account, Oracle Database removes the user account and associated schema from the data dictionary. It also immediately drops all schema objects contained in the user schema, if any.

Note:

- If a user schema and associated objects must remain but the user must be denied access to the database, then revoke the `CREATE SESSION` privilege from the user.
- Do not attempt to drop the `SYS` or `SYSTEM` user. Doing so corrupts your database.

2.5.2 Terminating a User Session

A user who is connected to a database cannot be dropped.

You must first terminate the user session (or the user can exit the session) before you can drop the user.

1. Query the `V$SESSION` dynamic view to find the session ID of the user whose session you want to terminate.

For example:

```
SELECT SID, SERIAL#, USERNAME FROM V$SESSION;
```

SID	SERIAL#	USERNAME
127	55234	ANDY
...		

2. Use the `ALTER SYSTEM SQL` statement to stop the session for the user, based on the `SID` and `SERIAL#` settings of the `V$SESSION` view.

For example:

```
ALTER SYSTEM KILL SESSION '127, 55234';
```

2.5.3 About Dropping a User After the User Is No Longer Connected to the Database

After a user is disconnected from the database, you can use the `DROP USER` statement to drop the user.

To drop a user and all the user schema objects (if any), you must have the `DROP USER` system privilege. Because the `DROP USER` system privilege is powerful, a security administrator is typically the only type of user that has this privilege.

If the schema of the user contains any dependent schema objects, then use the `CASCADE` option to drop the user and all associated objects and foreign keys that depend on the tables of the user successfully. If you do not specify `CASCADE` and the user schema contains dependent objects, then an error message is returned and the user is not dropped.

2.5.4 Dropping a User Whose Schema Contains Objects

Before you drop a user whose schema contains objects, carefully investigate the implications of dropping these schema objects.

1. Query the `DBA_OBJECTS` data dictionary view to find the objects that are owned by the user.

For example:

```
SELECT OWNER, OBJECT_NAME FROM DBA_OBJECTS WHERE OWNER LIKE 'ANDY';
```

Enter the user name in capital letters. Pay attention to any unknown cascading effects. For example, if you intend to drop a user who owns a table, then check whether any views or procedures depend on that particular table.

2. Use the `DROP USER` SQL statement with the `CASCADE` clause to drop the user and all associated objects and foreign keys that depend on the tables that the user owns.

For example:

```
DROP USER andy CASCADE;
```

2.6 Predefined Schema User Accounts Provided by Oracle Database

The Oracle Database installation process creates predefined administrative, non-administrative, and sample schema user accounts in the database.

- [About the Predefined Schema User Accounts](#)
The predefined schema accounts are either created automatically when you run standard Oracle scripts or they are accounts that represent a fictional company.
- [Predefined Administrative Accounts](#)
A default Oracle Database installation provides predefined administrative accounts to manage commonly used features, such as auditing.
- [Predefined Non-Administrative User Accounts](#)
A default Oracle Database installation provides non-administrative user accounts to manage features such as Oracle Spatial.
- [Predefined Sample Schema User Accounts](#)
Oracle Database provides a set of sample schemas that you can download and install.

2.6.1 About the Predefined Schema User Accounts

The predefined schema accounts are either created automatically when you run standard Oracle scripts or they are accounts that represent a fictional company.

The predefined schema accounts are in two categories:

- The predefined administrative and non-administrative schema accounts are created automatically when you run standard scripts such as the various `cat.*.sql` scripts. You can find these accounts by querying the `USERNAME` and `ORACLE_MAINTAINED` columns of the `ALL_USERS` data dictionary view. If the output for `ORACLE_MAINTAINED` is `Y`, then you must not modify the user account except by running the script that was used to create it.
- The `HR` sample schema user account is installed by default. A set of additional schema user accounts (`OE`, `PM`, `IX`, and `SH`, along with `HR`) is available on GitHub. These schema accounts represent different divisions of a fictional company that manufactures various products. You can find the status of these accounts by querying the `DBA_USERS` data dictionary view. Because the `ORACLE_MAINTAINED` column output for these accounts is `N`, you can modify these accounts without re-running the scripts that were used to create them.

By default, most of these accounts are authenticated as schema only accounts, except for the sample schema accounts, which are locked and expired during the database installation process. When using these accounts, you can configure them to be authenticated in other ways (such as with password authentication), but Oracle recommends that for better security, to keep these accounts as schema only accounts.

Related Topics

- [Oracle Database Sample Schemas](#)
- [Schema-Only Accounts](#)
You can create schema-only accounts, that is, the schema user has no password.

2.6.2 Predefined Administrative Accounts

A default Oracle Database installation provides predefined administrative accounts to manage commonly used features, such as auditing.

These are accounts that have special privileges required to administer areas of the database, such as the `CREATE ANY TABLE` or `ALTER SESSION` privilege, or `EXECUTE` privileges on packages owned by the `SYS` schema. The default tablespace for administrative accounts is either `SYSTEM` or `SYSAUX`. Predefined administrative accounts reside in the CDB root.

To protect these accounts from unauthorized access, the installation process expires and locks most of these accounts, except where noted in the following table. As the database administrator, you are responsible for unlocking and resetting these accounts.

[Table 2-1](#) lists the predefined administrative user accounts, which Oracle Database automatically creates when you run standard scripts (such as the various `cat*.sql` scripts). You can find a complete list of user accounts that are created and maintained by Oracle by querying the `USERNAME` and `ORACLE_MAINTAINED` columns of the `ALL_USERS` data dictionary view. If the output for `ORACLE_MAINTAINED` is `Y`, then you must not modify the user account except by running the script that was used to create it.

To find the status of an account, such as whether it is open, locked, or expired, query the `ACCOUNT_STATUS` column of the `DBA_USERS` data dictionary view. If the account is schema only, then the status is `NONE`.

Table 2-1 Predefined Oracle Database Administrative User Accounts

User Account	Description
ANONYMOUS	An account that allows HTTP access to Oracle XML DB. It is used in place of the APEX_PUBLIC_USER account when the Embedded PL/SQL Gateway (EPG) is installed in the database. EPG is a Web server that can be used with Oracle Database. It provides the necessary infrastructure to create dynamic applications.
APPQOSSYS	Used for storing and managing all data and metadata required by Oracle Quality of Service Management.
AUDSYS	The internal account used by the unified audit feature to store unified audit trail records.
CTXSYS	The account used to administer Oracle Text. Oracle Text enables you to build text query applications and document classification applications. It provides indexing, word and theme searching, and viewing capabilities for text.
DBSNMP	The account used by the Management Agent component of Oracle Enterprise Manager to monitor and manage the database.
DGPDB_INT	An internal account that is used by the Oracle Data Guard for the pluggable databases feature (DGPDB) when it is configured using the Data Guard Broker. This account is locked by default and is only unlocked when DGPDB is used.
DBSEFWUSER	The account used to run the DBMS_SFW_ACL_ADMIN package. See <i>Oracle Database PL/SQL Packages and Types Reference</i> .
DVF	The account owned by Oracle Database Vault that contains public functions to retrieve Database Vault factor values.
DVSYSA	Oracle Database Vault account that is associated with the DV_OWNER (for administrative configurations) and DV_ACCTMGR (for account management) roles.
GGSYS	The internal account used by Oracle GoldenGate. It should not be unlocked or used for a database login.
GSMADMIN_INTERNAL	The internal account that owns the Global Data Services schema. It should not be unlocked or used for a database login.
GSMCATUSER	The account used by Global Service Manager to connect to the Global Data Services catalog.
GSMROOTUSER	An account that is used to log into CDB\$ROOT for CDBs in a sharding configuration. This user is not used in GDS configurations. Any connections to CDB\$ROOT in a CDB are with GSMROOTUSER.
GSMUSER	The account used by Global Service Manager to connect to the database.
LBACSYS	The account used to administer Oracle Label Security (OLS). It is created only when you install the Label Security custom option.
MDSYS	The Oracle Spatial and Oracle Multimedia Locator administrator account.
OJVMYSYS	The account that is used with the Java Naming and Directory Interface (JNDI) support with Oracle JVM support. This account owns database tables that store the following details about JVM objects: namespace metadata, bound names, attributes, permissions, and stored object representations. See <i>Oracle Database Java Developer's Guide</i> .
OLAPSYS	The account that owns the OLAP Catalog (CWMLite). This account has been deprecated, but is retained for backward compatibility.
ORDDATA	This account contains the Oracle Multimedia DICOM data model.

Table 2-1 (Cont.) Predefined Oracle Database Administrative User Accounts

User Account	Description
ORDPLUGINS	The Oracle Multimedia user. Plug-ins supplied by Oracle and third-party, format plug-ins are installed in this schema. Oracle Multimedia enables Oracle Database to store, manage, and retrieve images, audio, video, DICOM format medical images and other objects, or other heterogeneous media data integrated with other enterprise information.
ORDSYS	The Oracle Multimedia administrator account.
OUTLN	The account that supports plan stability. Plan stability enables you to maintain the same execution plans for the same SQL statements. OUTLN acts as a role to centrally manage metadata associated with stored outlines.
REMOTE_SCHEDULER_AGENT	The account to disable remote jobs on a database. This account is created during the remote scheduler agent configuration. You can disable the capability of a database to run remote jobs by dropping this user. <i>See Oracle Database Administrator's Guide.</i>
SI_INFORMTN_SCHEMA	The account that stores the information views for the SQL/MM Still Image Standard. Note: The SI_INFORMTN_SCHEMA account is deprecated in Oracle Database 12c release 2 (12.2).
SYS	An account used to perform database administration tasks.
SYS\$UMF	The account used to administer Remote Management Framework, including the remote Automatic Workload Repository (AWR). <i>See Oracle Database Performance Tuning Guide.</i>
SYSBACKUP	The account used to perform Oracle Recovery Manager recovery and backup operations.
SYSDG	The account used to perform Oracle Data Guard operations.
SYSKM	The account used to manage Transparent Data Encryption.
SYSRAC	The account used to manage Oracle Real Application Clusters.
SYSTEM	A default generic database administrator account for Oracle databases. For production systems, Oracle recommends creating individual database administrator accounts and not using the generic SYSTEM account for database administration operations.
WMSYS	The account used to store the metadata information for Oracle Workspace Manager.
XDB	The account used for storing Oracle XML DB data and metadata. For better security, never unlock the XDB user account. Oracle XML DB provides high-performance XML storage and retrieval for Oracle Database data.



Note:

If you create an Oracle Automatic Storage Management (Oracle ASM) instance, then the ASMSNMP account is created. Oracle Enterprise Manager uses this account to monitor ASM instances to retrieve data from ASM-related data dictionary views. The ASMSNMP account status is set to OPEN upon creation, and it is granted the SYSDBA administrative privilege.

2.6.3 Predefined Non-Administrative User Accounts

A default Oracle Database installation provides non-administrative user accounts to manage features such as Oracle Spatial.

[Table 2-2](#) lists the predefined non-administrative user accounts that Oracle Database automatically creates when you run standard scripts (such as the various `cat*.sql` scripts). You can find a complete list of user accounts that are created and maintained by Oracle by querying the `USERNAME` and `ORACLE_MAINTAINED` columns of the `ALL_USERS` data dictionary view. If the output for `ORACLE_MAINTAINED` is `Y`, then you must not modify the user account except by running the script that was used to create it.

Non-administrative user accounts only have the minimum privileges needed to perform their jobs. Their default tablespace is `USERS`. Predefined non-administrative accounts reside in the CDB root.

To protect these accounts from unauthorized access, the installation process locks and expires these accounts immediately after installation, except where noted in the following table. As the database administrator, you are responsible for unlocking and resetting these accounts.

To find the status of an account, such as whether it is open, locked, or expired, query the `ACCOUNT_STATUS` column of the `DBA_USERS` data dictionary view. If the account is schema only, then the status is `NONE`.

Table 2-2 Predefined Oracle Database Non-Administrative User Accounts

User Account	Description
DIP	The Oracle Directory Integration and Provisioning (DIP) account that is installed with Oracle Label Security. This profile is created automatically as part of the installation process for Oracle Internet Directory-enabled Oracle Label Security.
MDDATA	The schema used by Oracle Spatial for storing Geocoder and router data. Oracle Spatial provides a SQL schema and functions that enable you to store, retrieve, update, and query collections of spatial features in an Oracle database.
ORACLE_OCM	The account used with Oracle Configuration Manager. This feature enables you to associate the configuration information for the current Oracle Database instance with My Oracle Support. Then when you log a service request, it is associated with the database instance configuration information.
XS\$NULL	An internal account that represents the absence of database user in a session and the actual session user is an application user supported by Oracle Real Application Security. <code>XS\$NULL</code> has no privileges and does not own any database object. No one can authenticate as <code>XS\$NULL</code> , nor can authentication credentials ever be assigned to <code>XS\$NULL</code> .

2.6.4 Predefined Sample Schema User Accounts

Oracle Database provides a set of sample schemas that you can download and install.

The sample schema user accounts are all non-administrative accounts, and their tablespace is `USERS`. They reside in `PDBs`, not the CDB root.

You can download and install the sample schemas by following the instructions in *Oracle Database Sample Schemas*. After you install them, they are ready to use.

The sample schemas represent different divisions of a fictional company that manufactures various products. You can find the status of these accounts by querying the `DBA_USERS` data

dictionary view. Because the `ORACLE_MAINTAINED` column output for these accounts is `N`, you can modify these accounts without re-running the scripts that were used to create them. To find the status of an account, such as whether it is open, locked, or expired, query the `ACCOUNT_STATUS` column of the `DBA_USERS` data dictionary view. If the account is schema only, then the status is `NONE`.

2.7 Database User and Profile Data Dictionary Views

Oracle Database provides a set of data dictionary views that provide information about the settings that you used to create users and profiles.

- [Data Dictionary Views That List Information About Users and Profiles](#)
Oracle Database provides a set of data dictionary views that contain information about database users and profiles.
- [Query to Find All Users and Associated Information](#)
The `DBA_USERS` data dictionary view shows all users and their associated information as defined in the database.
- [Query to List All Tablespace Quotas](#)
The `DBA_TS_QUOTAS` data dictionary view lists all tablespace quotas assigned to each user.
- [Query to List All Profiles and Assigned Limits](#)
The `DBA_PROFILE` view lists all profiles in the database and associated settings for each limit in each profile.
- [Query to View Memory Use for Each User Session](#)
The `V$SESSION` dynamic view lists the memory use for each user session.

2.7.1 Data Dictionary Views That List Information About Users and Profiles

Oracle Database provides a set of data dictionary views that contain information about database users and profiles.

[Table 2-3](#) lists these data dictionary views.

Table 2-3 Data Dictionary Views That Display Information about Users and Profiles

View	Description
<code>ALL_OBJECTS</code>	Describes all objects accessible to the current user
<code>ALL_USERS</code>	Lists users visible to the current user, but does not describe them
<code>DBA_PROFILES</code>	Displays all profiles and their limits
<code>DBA_TS_QUOTAS</code>	Describes tablespace quotas for users
<code>DBA_OBJECTS</code>	Describes all objects in the database
<code>DBA_USERS</code>	Describes all users of the database
<code>DBA_USERS_WITH_DEFPWD</code>	Lists all user accounts that have default passwords
<code>PROXY_USERS</code>	Describes users who can assume the identity of other users
<code>RESOURCE_COST</code>	Lists the cost for each resource in terms of CPUs for each session, reads for each session, connection times, and SGA
<code>USER_PASSWORD_LIMITS</code>	Describes the password profile parameters that are assigned to the user
<code>USER_RESOURCE_LIMITS</code>	Displays the resource limits for the current user

Table 2-3 (Cont.) Data Dictionary Views That Display Information about Users and Profiles

View	Description
USER_TS_QUOTAS	Describes tablespace quotas for users
USER_OBJECTS	Describes all objects owned by the current user
USER_USERS	Describes only the current user
V\$SESSION	Lists session information for the current database session
V\$SESSTAT	Displays user session statistics
V\$STATNAME	Displays decoded statistic names for the statistics shown in the V\$SESSTAT view

The following sections present examples of using these views. These examples assume that the following statements have been run. The users are all local users.

```
CREATE PROFILE clerk LIMIT
  SESSIONS_PER_USER 1
  IDLE_TIME 30
  CONNECT_TIME 600;
```

```
CREATE USER jfee
  IDENTIFIED BY password
  DEFAULT TABLESPACE example
  TEMPORARY TABLESPACE temp
  QUOTA 500K ON example
  PROFILE clerk
  CONTAINER = CURRENT;
```

```
CREATE USER dcranney
  IDENTIFIED BY password
  DEFAULT TABLESPACE example
  TEMPORARY TABLESPACE temp
  QUOTA unlimited ON example
  CONTAINER = CURRENT;
```

```
CREATE USER userscott
  IDENTIFIED BY password
  CONTAINER = CURRENT;
```

Related Topics

- [Oracle Database Reference](#)

2.7.2 Query to Find All Users and Associated Information

The `DBA_USERS` data dictionary view shows all users and their associated information as defined in the database.

For example:

```
col username format a11
col profile format a10
col account_status format a19
col authentication_type format a29

SELECT USERNAME, PROFILE, ACCOUNT_STATUS, AUTHENTICATION_TYPE FROM DBA_USERS;
```

USERNAME	PROFILE	ACCOUNT_STATUS	AUTHENTICATION_TYPE
SYS	DEFAULT	OPEN	PASSWORD
SYSTEM	DEFAULT	OPEN	PASSWORD
USERSCOTT	DEFAULT	OPEN	PASSWORD
JFEE	CLERK	OPEN	GLOBAL
DCRANNEY	DEFAULT	OPEN	EXTERNAL

Related Topics

- [Oracle Database Reference](#)

2.7.3 Query to List All Tablespace Quotas

The `DBA_TS_QUOTAS` data dictionary view lists all tablespace quotas assigned to each user.

For example:

```
SELECT * FROM DBA_TS_QUOTAS;
```

TABLESPACE	USERNAME	BYTES	MAX_BYTES	BLOCKS	MAX_BLOCKS
EXAMPLE	JFEE	0	512000	0	250
EXAMPLE	DCRANNEY	0	-1	0	-1

When specific quotas are assigned, the exact number is indicated in the `MAX_BYTES` column. This number is always a multiple of the database block size, so if you specify a tablespace quota that is not a multiple of the database block size, then it is rounded up accordingly. Unlimited quotas are indicated by `-1`.

Related Topics

- [Oracle Database Reference](#)

2.7.4 Query to List All Profiles and Assigned Limits

The `DBA_PROFILE` view lists all profiles in the database and associated settings for each limit in each profile.

For example:

```
SELECT * FROM DBA_PROFILES
ORDER BY PROFILE;
```

PROFILE	RESOURCE_NAME	RESOURCE_TYPE	LIMIT
CLERK	COMPOSITE_LIMIT	KERNEL	DEFAULT
CLERK	FAILED_LOGIN_ATTEMPTS	PASSWORD	DEFAULT
CLERK	PASSWORD_LIFE_TIME	PASSWORD	DEFAULT
CLERK	PASSWORD_REUSE_TIME	PASSWORD	DEFAULT
CLERK	PASSWORD_REUSE_MAX	PASSWORD	DEFAULT
CLERK	PASSWORD_VERIFY_FUNCTION	PASSWORD	DEFAULT
CLERK	PASSWORD_LOCK_TIME	PASSWORD	DEFAULT
CLERK	PASSWORD_GRACE_TIME	PASSWORD	DEFAULT
CLERK	PRIVATE_SGA	KERNEL	DEFAULT
CLERK	CONNECT_TIME	KERNEL	600
CLERK	IDLE_TIME	KERNEL	30
CLERK	LOGICAL_READS_PER_CALL	KERNEL	DEFAULT
CLERK	LOGICAL_READS_PER_SESSION	KERNEL	DEFAULT
CLERK	CPU_PER_CALL	KERNEL	DEFAULT

CLERK	CPU_PER_SESSION	KERNEL	DEFAULT
CLERK	SESSIONS_PER_USER	KERNEL	1
DEFAULT	COMPOSITE_LIMIT	KERNEL	UNLIMITED
DEFAULT	PRIVATE_SGA	KERNEL	UNLIMITED
DEFAULT	SESSIONS_PER_USER	KERNEL	UNLIMITED
DEFAULT	CPU_PER_CALL	KERNEL	UNLIMITED
DEFAULT	LOGICAL_READS_PER_CALL	KERNEL	UNLIMITED
DEFAULT	CONNECT_TIME	KERNEL	UNLIMITED
DEFAULT	IDLE_TIME	KERNEL	UNLIMITED
DEFAULT	LOGICAL_READS_PER_SESSION	KERNEL	UNLIMITED
DEFAULT	CPU_PER_SESSION	KERNEL	UNLIMITED
DEFAULT	FAILED_LOGIN_ATTEMPTS	PASSWORD	10
DEFAULT	PASSWORD_LIFE_TIME	PASSWORD	180
DEFAULT	PASSWORD_REUSE_MAX	PASSWORD	UNLIMITED
DEFAULT	PASSWORD_LOCK_TIME	PASSWORD	1
DEFAULT	PASSWORD_GRACE_TIME	PASSWORD	7
DEFAULT	PASSWORD_VERIFY_FUNCTION	PASSWORD	UNLIMITED
DEFAULT	PASSWORD_REUSE_TIME	PASSWORD	UNLIMITED
DEFAULT	INACTIVE_ACCOUNT_TIME	KERNEL	UNLIMITED
DEFAULT	PASSWORD_ROLLOVER_TIME	PASSWORD	0

34 rows selected.

To find the default profile values, you can run the following query:

```
SELECT * FROM DBA_PROFILES WHERE PROFILE = 'DEFAULT';
```

PROFILE	RESOURCE_NAME	RESOURCE_TYPE	LIMIT
DEFAULT	COMPOSITE_LIMIT	KERNEL	UNLIMITED
DEFAULT	SESSIONS_PER_USER	KERNEL	UNLIMITED
DEFAULT	CPU_PER_SESSION	KERNEL	UNLIMITED
DEFAULT	CPU_PER_CALL	KERNEL	UNLIMITED
DEFAULT	LOGICAL_READS_PER_SESSION	KERNEL	UNLIMITED
DEFAULT	LOGICAL_READS_PER_CALL	KERNEL	UNLIMITED
DEFAULT	IDLE_TIME	KERNEL	UNLIMITED
DEFAULT	CONNECT_TIME	KERNEL	UNLIMITED
DEFAULT	PRIVATE_SGA	KERNEL	UNLIMITED
DEFAULT	FAILED_LOGIN_ATTEMPTS	PASSWORD	10
DEFAULT	PASSWORD_LIFE_TIME	PASSWORD	180
DEFAULT	PASSWORD_REUSE_TIME	PASSWORD	UNLIMITED
DEFAULT	PASSWORD_REUSE_MAX	PASSWORD	UNLIMITED
DEFAULT	PASSWORD_VERIFY_FUNCTION	PASSWORD	NULL
DEFAULT	PASSWORD_LOCK_TIME	PASSWORD	1
DEFAULT	PASSWORD_GRACE_TIME	PASSWORD	7

16 rows selected.

Related Topics

- [Oracle Database Reference](#)

2.7.5 Query to View Memory Use for Each User Session

The V\$SESSION dynamic view lists the memory use for each user session.

The following query lists all current sessions, showing the Oracle Database user and current User Global Area (UGA) memory use for each session:

```
SELECT USERNAME, VALUE || 'bytes' "Current UGA memory"
FROM V$SESSION sess, V$SESSTAT stat, V$STATNAME name
WHERE sess.SID = stat.SID
```

```
AND stat.STATISTIC# = name.STATISTIC#  
AND name.NAME = 'session uga memory';
```

USERNAME	Current UGA memory
-----	-----
	18636bytes
	17464bytes
	19180bytes
	18364bytes
	39384bytes
	35292bytes
	17696bytes
	15868bytes
USERSCOTT	42244bytes
SYS	98196bytes
SYSTEM	30648bytes

11 rows selected.

To see the maximum UGA memory allocated to each session since the instance started, replace 'session uga memory' in the preceding query with 'session uga memory max'.

Related Topics

- [V_SESSION](#)

3

Configuring Authentication

Authentication means to verify the identity of users or other entities that connect to the database.

- [About Authentication](#)
Authentication means verifying the identity of a user, device, or other entity who wants to use data, resources, or applications.
- [Configuring Password Protection](#)
You can secure user passwords in a variety of ways, such as controlling the password creation requirements or using password management policies.
- [Authentication of Database Administrators](#)
You can authenticate database administrators by using strong authentication, from the operating system, or from the database using passwords.
- [Database Authentication of Users](#)
Database authentication of users entails using information within the database itself to perform the authentication.
- [Schema-Only Accounts](#)
You can create schema-only accounts, that is, the schema user has no password.
- [Configuring Operating System Users for a PDB](#)
The `DBMS_CREDENTIAL.CREATE_CREDENTIAL` procedure configures user accounts to be operating system users for a pluggable database (PDB).
- [External \(Non-Database\) User Authentication and Access to the Database](#)
External authentication centralizes user security for database access improving security and reducing database administrative workload. You can perform external authentication with either local database authorization or external authorization.
- [Multitier Authentication and Authorization](#)
Oracle Database secures middle-tier applications by limiting privileges, preserving client identities through all tiers, and auditing actions by clients.
- [Administration and Security in Clients, Application Servers, and Database Servers](#)
In a multitier environment, an application server provides data for clients and serves as an interface to one or more database servers.
- [Preserving User Identity in Multitiered Environments](#)
You can use middle tier servers for proxy authentication and client identifiers to identify application users who are not known to the database.
- [User Authentication Data Dictionary Views](#)
Oracle Database provides data dictionary views that list information about user authentication, such as roles that users have or profiles they use.

3.1 About Authentication

Authentication means verifying the identity of a user, device, or other entity who wants to use data, resources, or applications.

Validating this identity establishes a trust relationship for further interactions. Authentication also enables accountability by making it possible to link access and actions to specific identities. After authentication, authorization processes can allow or limit the levels of access and action permitted to that entity.

You can authenticate both database and non-database users for an Oracle database. For simplicity, the same authentication method is generally used for all users in the same database, but the Oracle Database allows a single database instance to use any or some combination of methods. Oracle Database requires special authentication procedures for database administrators because they perform privileged database operations.

Authentication and authorization access can be grouped into three types.

- Local database authentication and local database authorization
- External authentication with local database authorization
- External authentication and external authorization

Local database authentication and authorization is provided with the database and is simple to use. However, centralized external authentication is much more secure and reduces the database administrator workload by offloading user credential management to an external identity service.

Related Topics

- [Configuring Privilege and Role Authorization](#)
Privilege and role authorization controls the permissions that users have to perform day-to-day tasks.

3.2 Configuring Password Protection

You can secure user passwords in a variety of ways, such as controlling the password creation requirements or using password management policies.

- [What Are the Oracle Database Built-in Password Protections?](#)
Oracle Database provides a set of built-in password protections designed to protect your users' passwords.
- [Minimum Requirements for Passwords](#)
Oracle provides a set of minimum requirements for passwords.
- [Creating a Password by Using the IDENTIFIED BY Clause](#)
SQL statements that accept the `IDENTIFIED BY` clause also enable you to create passwords.
- [Using a Password Management Policy](#)
A password management policy can create and enforce a set of restrictions that can better secure user passwords.
- [Managing Gradual Database Password Rollover for Applications](#)
A gradual database password rollover enables the database password of an application to be updated while avoiding application downtime while the new password is propagated to application clients, by allowing the older password to remain valid for a specified period.
- [Managing the Complexity of Passwords](#)
Oracle Database provides a set of functions that you can use to manage the complexity of passwords.
- [Managing Password Case Sensitivity](#)
You can manage the password case sensitivity for passwords from user accounts from previous releases.

- [Ensuring Against Password Security Threats by Using the 12C Password Version](#)
The 12C password version enables users to create complex passwords that meet compliance standards.
- [Managing the Secure External Password Store for Password Credentials](#)
The secure external password store (SEPS) is a client-side wallet that is used to store password credentials.
- [Managing Passwords for Administrative Users](#)
The passwords of administrative users have special protections, such as password files and password complexity functions.

3.2.1 What Are the Oracle Database Built-in Password Protections?

Oracle Database provides a set of built-in password protections designed to protect your users' passwords.

These password protections are as follows:

- **Password encryption.** Oracle Database automatically and transparently encrypts passwords during network (client-to-server and server-to-server) connections, using Advanced Encryption Standard (AES) before sending them across the network. However, a password that is specified within a SQL statement (such as `CREATE USER user_name IDENTIFIED BY password;`) is still transmitted across the network in clear text in the network trace files. For this reason, you should have native network encryption enabled or configure Transport Layer Security (TLS) encryption.
- **Password complexity checking.** In a default installation, Oracle Database provides the `ora12c_verify_function` and `ora12c_strong_verify_function` password verification functions to ensure that new or changed passwords are sufficiently complex to prevent intruders who try to break into the system by guessing passwords. You must manually enable password complexity checking. You can further customize the complexity of your users' passwords.
- **Preventing passwords from being broken.** If a user tries to log in to Oracle Database multiple times using an incorrect password, Oracle Database delays each login by one second. This protection applies for attempts made from different IP addresses or multiple client connections. This feature significantly decreases the number of passwords that an intruder would be able to try within a fixed time period when attempting to log in. The failed login delay slows down each failed login attempt, increasing the overall time that is required to perform a password-guessing attack, because such attacks usually require a very large number of failed login attempts.

For non-administrative logins, Oracle Database protects against concurrent password guessing attacks by setting an exclusive lock for the failed login delay. This prevents an intruder from attempting to sidestep the failed login delay when the intruder tries the next concurrent guess in a different database session as soon as the first guess fails and is delayed.

By holding an exclusive lock on the account that is being attacked, Oracle Database mitigates concurrent password guessing attacks, but this can simultaneously leave the account vulnerable to denial-of-service (DoS) attacks. To remedy this problem, you should create a password profile where the `FAILED_LOGIN_ATTEMPTS` parameter is set to `UNLIMITED`, and then apply this password profile to the user account. The value `UNLIMITED` for the `FAILED_LOGIN_ATTEMPTS` parameter setting disables failed login delays and does not limit the number of failed login attempts. For these types of accounts, Oracle recommends that you use a long random password.

The concurrent password-guessing attack protection does not apply to administrative user connections, because these kinds of connections must remain available at all times and be immune to denial-of-service attacks. Hence, Oracle recommends that you choose long passwords for any administrative privileged account.

- **Enforced case sensitivity for passwords.** Passwords are case sensitive. For example, the password `hPP5620qr` fails if it is entered as `hpp5620QR` or `hPp5620Qr`. Case sensitivity affects password files and database links.
- **Passwords hashed using the 12C password version.** To verify the user's password and enforce case sensitivity in password creation, Oracle Database uses the 12C password version, which is based on a de-optimized algorithm that involves Password-Based Key Derivation Function (PBKDF2) and the SHA-512 cryptographic hash functions.

Related Topics

- [Guidelines for Securing Passwords](#)
Oracle provides guidelines for securing passwords in a variety of situations.

3.2.2 Minimum Requirements for Passwords

Oracle provides a set of minimum requirements for passwords.

Passwords must be at least 12 bytes long. (The maximum is 1024 bytes.) There are a variety of ways that you can secure passwords, ranging from requiring passwords to be of a sensible length to creating custom password complexity verification scripts that enforce the password complexity policy requirements that apply at your site.

Related Topics

- [Guidelines for Securing Passwords](#)
Oracle provides guidelines for securing passwords in a variety of situations.

3.2.3 Creating a Password by Using the IDENTIFIED BY Clause

SQL statements that accept the `IDENTIFIED BY` clause also enable you to create passwords.

- To create passwords for users, use the `CREATE USER`, `ALTER USER`, `GRANT CREATE SESSION`, or `CREATE DATABASE LINK` SQL statement.

The following SQL statements create passwords with the `IDENTIFIED BY` clause.

```
CREATE USER psmith IDENTIFIED BY password;  
GRANT CREATE SESSION TO psmith IDENTIFIED BY password;  
ALTER USER psmith IDENTIFIED BY password;  
CREATE DATABASE LINK AUTHENTICATED BY psmith IDENTIFIED BY password;
```

Related Topics

- [About Password Complexity Verification](#)
Complexity verification checks that each password is complex enough to protect against intruders who try to guess user passwords.

3.2.4 Using a Password Management Policy

A password management policy can create and enforce a set of restrictions that can better secure user passwords.

- [About Managing Passwords](#)
Database security systems that depend on passwords require that passwords be kept secret at all times.
- [Finding User Accounts That Have Default Passwords](#)
The `DBA_USERS_WITH_DEFPWD` data dictionary view can find user accounts that use default passwords.
- [Password Settings in the Default Profile](#)
A profile is a collection of parameters that sets limits on database resources.
- [Using the ALTER PROFILE Statement to Modify Profile Limits](#)
You can modify profile limits such as failed login attempts, password lock times, password reuse, and several other settings.
- [Disabling and Enabling the Default Password Security Settings](#)
Oracle provides scripts that you can use to disable and enable the default password security settings.
- [Automatically Locking Inactive Database User Accounts](#)
The `INACTIVE_ACCOUNT_TIME` profile parameter locks a user account that has not logged in to the database instance in a specified number of days.
- [Automatically Locking User Accounts After a Specified Number of Failed Log-in Attempts](#)
Oracle Database can lock a user's account after a specified number of consecutive failed log-in attempts.
- [Example: Locking an Account with the CREATE PROFILE Statement](#)
The `CREATE PROFILE` statement can lock user accounts if a user's attempt to log in violates the `CREATE PROFILE` settings.
- [Explicitly Locking a User Account with the CREATE USER or ALTER USER Statement](#)
When you explicitly lock a user account, the account cannot be unlocked automatically. Only a security administrator can unlock the account.
- [Controlling the User Ability to Reuse Previous Passwords](#)
You can ensure that users do not reuse previous passwords for an amount of time or for a number of password changes.
- [About Controlling Password Aging and Expiration](#)
You can specify a password lifetime, after which the password expires.
- [Setting a Password Lifetime](#)
When you set a lifetime for a password, the user must create a new password when this lifetime ends.
- [Checking the Status of a User Account](#)
You can check the status of any account, whether it is open, in grace, or expired.
- [Password Change Life Cycle](#)
After a password is created, it follows a life cycle and grace period in four phases.
- [PASSWORD_LIFE_TIME Profile Parameter Low Value](#)
Be careful if you set the `PASSWORD_LIFE_TIME` parameter of `CREATE PROFILE` or `ALTER PROFILE` to a low value (for example, 1 day).

3.2.4.1 About Managing Passwords

Database security systems that depend on passwords require that passwords be kept secret at all times.

Because passwords are vulnerable to theft and misuse, Oracle Database uses a password management policy. Database administrators and security officers control this policy through user profiles, enabling greater control of database security.

You can use the `CREATE PROFILE` statement to create a user profile. The profile is assigned to a user with the `CREATE USER` or `ALTER USER` statement.

3.2.4.2 Finding User Accounts That Have Default Passwords

The `DBA_USERS_WITH_DEFPWD` data dictionary view can find user accounts that use default passwords.

When you create a database, most of the default accounts are locked with the passwords expired. If you have upgraded from an earlier release of Oracle Database, then you may have user accounts that have default passwords. These are default accounts that are created when you create a database, such as the `HR`, `OE`, and `SCOTT` accounts.

For greater security, you should change the passwords for these accounts. Using a default password that is commonly known can make your database vulnerable to attacks by intruders.

1. Log in to the CDB root or to a PDB by using SQL*Plus with the `SYSDBA` administrative privilege.

For example, to log in to a PDB:

```
sqlplus sys@pdb_name as sysdba
Enter password: password
```

To find the available PDBs in a CDB, log in to the CDB root container and then query the `PDB_NAME` column of the `DBA_PDBS` data dictionary view. To check the current container, run the `show con_name` command.

2. Query the `DBA_USERS_WITH_DEFPWD` data dictionary view.

For example, to find both the names of accounts that have default passwords and the status of the account:

```
SELECT d.username, u.account_status
FROM DBA_USERS_WITH_DEFPWD d, DBA_USERS u
WHERE d.username = u.username
ORDER BY 2,1;
```

```
USERNAME  ACCOUNT_STATUS
-----  -
SCOTT      EXPIRED & LOCKED
```

3. Change the passwords for any accounts that the `DBA_USERS_WITH_DEFPWD` view lists.

Oracle recommends that you do **not** assign these accounts passwords that they may have had in previous releases of Oracle Database.

For example:

```
ALTER USER SCOTT ACCOUNT UNLOCK IDENTIFIED BY password;
```

Replace `password` with a password that is secure.

Related Topics

- [Guidelines for Securing Passwords](#)
Oracle provides guidelines for securing passwords in a variety of situations.

3.2.4.3 Password Settings in the Default Profile

A profile is a collection of parameters that sets limits on database resources.

If you assign the profile to a user, then that user cannot exceed these limits. You can use profiles to configure database settings such as sessions per user, logging and tracing features, and so on. Profiles can also control user passwords. To find information about the current password settings in the profile, you can query the `DBA_PROFILES` data dictionary view.

[Table 3-1](#) lists the password-specific parameter settings in the default profile.

Table 3-1 Password-Specific Settings in the Default Profile

Parameter	Default Setting	Description
<code>INACTIVE_ACCOUNT_TIME</code>	365	Locks the account of a database user who has not logged in to the database instance in a specified number of days.
<code>FAILED_LOGIN_ATTEMPTS</code>	10	Sets the maximum times a user try to log in and to fail before locking the account. Notes: <ul style="list-style-type: none"> When you set this parameter, take into consideration users who may log in using the <code>CONNECT THROUGH</code> privilege. You can set limits on the number of times an unauthorized user (possibly an intruder) attempts to log in to Oracle Call Interface (OCI) applications by using the <code>SEC_MAX_FAILED_LOGIN_ATTEMPTS</code> initialization parameter.
<code>PASSWORD_GRACE_TIME</code>	7	Sets the number of days that a user has to change their password before it expires.
<code>PASSWORD_LIFE_TIME</code>	180	Sets the number of days the user can use their current password.
<code>PASSWORD_LOCK_TIME</code>	1	Sets the number of days an account will be locked after the specified number of consecutive failed login attempts. After the time passes, then the account becomes unlocked. This user's profile parameter is useful to help prevent brute force attacks on user passwords but not to increase the maintenance burden on administrators. Even after the value set by <code>PASSWORD_LOCK_TIME</code> shows that the password has expired, the <code>DBA_USERS</code> data dictionary view will show that the account is locked. However, after the user connects, the information in <code>DBA_USERS</code> is updated with the correct <code>OPEN</code> status.
<code>PASSWORD_REUSE_MAX</code>	UNLIMITED	Sets the number of password changes required before the current password can be reused.
<code>PASSWORD_REUSE_TIME</code>	UNLIMITED	Sets the number of days before which a password cannot be reused.
<code>PASSWORD_ROLLOVER_TIME</code>	0	Enables the gradual database password rollover time.

Related Topics

- [Managing Resources with Profiles](#)
A profile is a named set of resource limits and password parameters that restrict database usage and instance resources for a user.
- [Automatically Locking Inactive Database User Accounts](#)
The `INACTIVE_ACCOUNT_TIME` profile parameter locks a user account that has not logged in to the database instance in a specified number of days.
- [Configuration of the Maximum Number of Authentication Attempts](#)
The `SEC_MAX_FAILED_LOGIN_ATTEMPTS` initialization parameter sets the number of authentication attempts before the database will drop a failed connection.
- [Automatically Locking User Accounts After a Specified Number of Failed Log-in Attempts](#)
Oracle Database can lock a user's account after a specified number of consecutive failed log-in attempts.
- [About Controlling Password Aging and Expiration](#)
You can specify a password lifetime, after which the password expires.
- [Controlling the User Ability to Reuse Previous Passwords](#)
You can ensure that users do not reuse previous passwords for an amount of time or for a number of password changes.
- [Managing Resources with Profiles](#)
A profile is a named set of resource limits and password parameters that restrict database usage and instance resources for a user.
- [Managing Resources with Profiles](#)
A profile is a named set of resource limits and password parameters that restrict database usage and instance resources for a user.

3.2.4.4 Using the ALTER PROFILE Statement to Modify Profile Limits

You can modify profile limits such as failed login attempts, password lock times, password reuse, and several other settings.

For greater security, use the default settings in the password profile, based on your needs.

- Use the `ALTER PROFILE` statement to modify a user's profile limits.

For example:

```
ALTER PROFILE prof LIMIT
  FAILED_LOGIN_ATTEMPTS 9
  PASSWORD_LOCK_TIME 10
  INACTIVE_ACCOUNT_TIME 21;
```

Related Topics

- [Password Settings in the Default Profile](#)
A profile is a collection of parameters that sets limits on database resources.

3.2.4.5 Disabling and Enabling the Default Password Security Settings

Oracle provides scripts that you can use to disable and enable the default password security settings.

If your applications use the default password security settings from Oracle Database 10g release 2 (10.2), then you can revert to these settings until you modify the applications to use the default password security settings from Oracle Database 11g or later.

1. Modify your applications to conform to the password security settings from Oracle Database 11g or later.
2. Update your database to use the security configuration that suits your business needs, using one of the following methods:
 - Manually update the database security configuration.
 - Run the `secconf.sql` script to apply the default password settings from Oracle Database 11g or later. You can customize this script to have different security settings if you like, but remember that the settings listed in the original script are Oracle-recommended settings.

If you created your database manually, then you should run the `secconf.sql` script to apply the Oracle default password settings to the database. Databases that have been created with Database Configuration Assistant (DBCA) will have these settings, but manually created databases do not.

The `secconf.sql` script is in the `$ORACLE_HOME/rdbms/admin` directory. The `secconf.sql` script affects both password and audit settings. It has no effect on other security settings.

3.2.4.6 Automatically Locking Inactive Database User Accounts

The `INACTIVE_ACCOUNT_TIME` profile parameter locks a user account that has not logged in to the database instance in a specified number of days.

Users are considered active users if they log in periodically. The `INACTIVE_ACCOUNT_TIME` timing is based on the number of days after the last time a user successfully logs in.

- To lock user accounts automatically after a specified number of days, set the `INACTIVE_ACCOUNT_TIME` profile parameter in the `CREATE PROFILE` or `ALTER PROFILE` statement.

For example:

```
CREATE PROFILE prof LIMIT
...
INACTIVE_ACCOUNT_TIME 20;
```

Note the following:

- The default value for `INACTIVE_ACCOUNT_TIME` is `UNLIMITED`.
- You must specify a whole number for the number of days. The minimum setting is 15 and the maximum is 24855.
- To set the user's account to have an unlimited inactivity time, set the `INACTIVE_ACCOUNT_TIME` to `UNLIMITED`.
- To set the user's account to use the time specified by the default profile, set `INACTIVE_ACCOUNT_TIME` to `DEFAULT`.

- You can set this parameter for all database authenticated users, including administrative users, but not for external or global authenticated users.
- In a read-only database, the last successful login is not considered in the `INACTIVE_ACCOUNT_TIME` timing. It is not possible to lock a user account in a read-only database (except by performing consecutive failed logins equal in number to the account's `FAILED_LOGIN_ATTEMPTS` password profile setting).
- For a newly created user account, the timing begins at account creation time. When this user logs out and then logs again, the timing starts when the user successfully logs in.
- For common users, the `INACTIVE_ACCOUNT_TIME` setting applies to the last time a common user logs in to the root. A common user is considered active if this user logs in to any of the PDBs or the root.
- For a proxy user account login, the `INACTIVE_ACCOUNT_TIME` begins the timing when the proxy user logs in successfully.

For example, to create a profile that locks an account after 60 days of being inactive:

```
CREATE PROFILE time_limit LIMIT
  INACTIVE_ACCOUNT_TIME 60;
```

3.2.4.7 Automatically Locking User Accounts After a Specified Number of Failed Log-in Attempts

Oracle Database can lock a user's account after a specified number of consecutive failed log-in attempts.

- To lock user accounts automatically after a specified time interval or to require database administrator intervention to be unlocked, set the `PASSWORD_LOCK_TIME` profile parameter in the `CREATE PROFILE` or `ALTER PROFILE` statement.

For example, to set the time interval to 10 days:

```
CREATE PROFILE prof LIMIT
  ...
  PASSWORD_LOCK_TIME 10;
```

Note the following:

- You can lock accounts manually, so that they must be unlocked explicitly by a database administrator.
- You can specify the permissible number of failed login attempts by using the `CREATE PROFILE` statement. You can also specify the amount of time an account remains locked.
- Each time the user unsuccessfully logs in, Oracle Database increases the delay exponentially with each login failure.
- If you do not specify a time interval for unlocking the account, then `PASSWORD_LOCK_TIME` assumes the value specified in a default profile. (The recommended value is 1 day.) If you specify `PASSWORD_LOCK_TIME` as `UNLIMITED`, then you must explicitly unlock the account by using an `ALTER USER` statement. For example, assuming that `PASSWORD_LOCK_TIME UNLIMITED` is specified for `johndoe`, then you use the following statement to unlock the `johndoe` account:

```
ALTER USER johndoe ACCOUNT UNLOCK;
```

- After a user successfully logs into an account, Oracle Database resets the unsuccessful login attempt count for the user. If it is non-zero, then the count is set to zero.
- A locked CDB common user account will be locked across all PDBs in the CDB. A locked application common user account will be locked across all PDBs that are associated with the application root.

3.2.4.8 Example: Locking an Account with the CREATE PROFILE Statement

The `CREATE PROFILE` statement can lock user accounts if a user's attempt to log in violates the `CREATE PROFILE` settings.

Example 3-1 sets the maximum number of failed login attempts for the user `johndoe` to 10 (the default), and the amount of time the account locked to 30 days. The account will unlock automatically after 30 days.

Example 3-1 Locking an Account with the CREATE PROFILE Statement

```
CREATE PROFILE prof LIMIT
  FAILED_LOGIN_ATTEMPTS 10
  PASSWORD_LOCK_TIME 30

ALTER USER johndoe PROFILE prof;
```

3.2.4.9 Explicitly Locking a User Account with the CREATE USER or ALTER USER Statement

When you explicitly lock a user account, the account cannot be unlocked automatically. Only a security administrator can unlock the account.

After you have locked a CDB common user account in the CDB root, this user cannot log in to any PDB that is associated with this root, nor can this account be unlocked in a PDB. In addition, you can lock a CDB common account locally in a PDB, which will prevent the CDB common user from logging in to that PDB. Similarly, an application common user account that is locked in the application root cannot log in to any PDB associated with the application root, nor can the application common user be unlocked in an application PDB. You can explicitly lock an application common user locally in an application PDB.

- To explicitly lock a user account, use the `CREATE USER` or `ALTER USER` statement.

For example, the following statement locks the user account, `susan`:

```
ALTER USER susan ACCOUNT LOCK;
```

3.2.4.10 Controlling the User Ability to Reuse Previous Passwords

You can ensure that users do not reuse previous passwords for an amount of time or for a number of password changes.

For better security, Oracle recommends that you restrict the ability of users to use previous passwords.

- To configure the ability of users to reuse earlier passwords, set the `PASSWORD_REUSE_TIME` and `PASSWORD_REUSE_MAX` parameters in the `CREATE PROFILE` or `ALTER PROFILE` statement.

For example, restrict the number of days (or a fraction of a day) between the earlier use of a password and its next use to 30 days and the number of password changes required before a password can be reused to 10:

```
CREATE PROFILE prof LIMIT
...
PASSWORD_REUSE_TIME 30
PASSWORD_REUSE_MAX 10;
```

Note the following:

- If you do not specify a parameter, then the user can reuse passwords at any time, which is not a good security practice.
- If neither parameter is `UNLIMITED`, then password reuse is allowed, but only after meeting both conditions. The user must have changed the password the specified number of times, and the specified number of days must have passed since the previous password was last used. For example, suppose that the profile of user A had `PASSWORD_REUSE_MAX` set to 10 and `PASSWORD_REUSE_TIME` set to 30. User A cannot reuse a password until they have reset the password 10 times, and until 30 days had passed since the password was last used.
- If either parameter is specified as `UNLIMITED`, then the user can never reuse a password.
- If you set both parameters to `UNLIMITED`, then Oracle Database ignores both, and the user can reuse any password at any time.
- If you specify `DEFAULT` for either parameter, then Oracle Database uses the value defined in the `DEFAULT` profile, which sets all parameters to `UNLIMITED`. Oracle Database thus uses `UNLIMITED` for any parameter specified as `DEFAULT`, unless you change the setting for that parameter in the `DEFAULT` profile.

3.2.4.11 About Controlling Password Aging and Expiration

You can specify a password lifetime, after which the password expires.

This means that the next time the user logs in with the current, correct password, this user is prompted to change the password. By default, there are no complexity or password history checks, so users can still reuse any previous or weak passwords. You can control these factors by setting the `PASSWORD_REUSE_TIME`, `PASSWORD_REUSE_MAX`, and `PASSWORD_VERIFY_FUNCTION` parameters.

In addition, you can set a grace period, during which each attempt to log in to the database account receives a warning message to change the password. If the user does not change it by the end of that period, then Oracle Database expires the account.

As a database administrator, you can manually set the password state to be expired, which sets the account status to `EXPIRED`. The user must then follow the prompts to change the password before the logon can proceed.

For example, in SQL*Plus, suppose user `SCOTT` tries to log in with the correct credentials, but this user's password has expired. User `SCOTT` will then see the `ORA-28001: The password has expired` error and be prompted to change his password, as follows:

```
Changing password for scott
New password: new_password
Retype new password: new_password
Password changed.
```

Related Topics

- [Controlling the User Ability to Reuse Previous Passwords](#)
You can ensure that users do not reuse previous passwords for an amount of time or for a number of password changes.
- [About Password Complexity Verification](#)
Complexity verification checks that each password is complex enough to protect against intruders who try to guess user passwords.

3.2.4.12 Setting a Password Lifetime

When you set a lifetime for a password, the user must create a new password when this lifetime ends.

- To specify a lifetime for passwords, set the `PASSWORD_LIFE_TIME` parameter in the `CREATE PROFILE` or `ALTER PROFILE` statement.

For example, to set the password life time to 180 days:

```
CREATE PROFILE prof LIMIT
...
PASSWORD_LIFE_TIME 180;
```

Related Topics

- [Password Change Life Cycle](#)
After a password is created, it follows a life cycle and grace period in four phases.

3.2.4.13 Checking the Status of a User Account

You can check the status of any account, whether it is open, in grace, or expired.

- To check the status of a user account, query the `ACCOUNT_STATUS` column of the `DBA_USERS` data dictionary view.

For example:

```
SELECT ACCOUNT_STATUS FROM DBA_USERS WHERE USERNAME = 'username';
```

3.2.4.14 Password Change Life Cycle

After a password is created, it follows a life cycle and grace period in four phases.

The following diagram shows the life cycle of the password lifetime and grace period.

Figure 3-1 Password Change Life Cycle

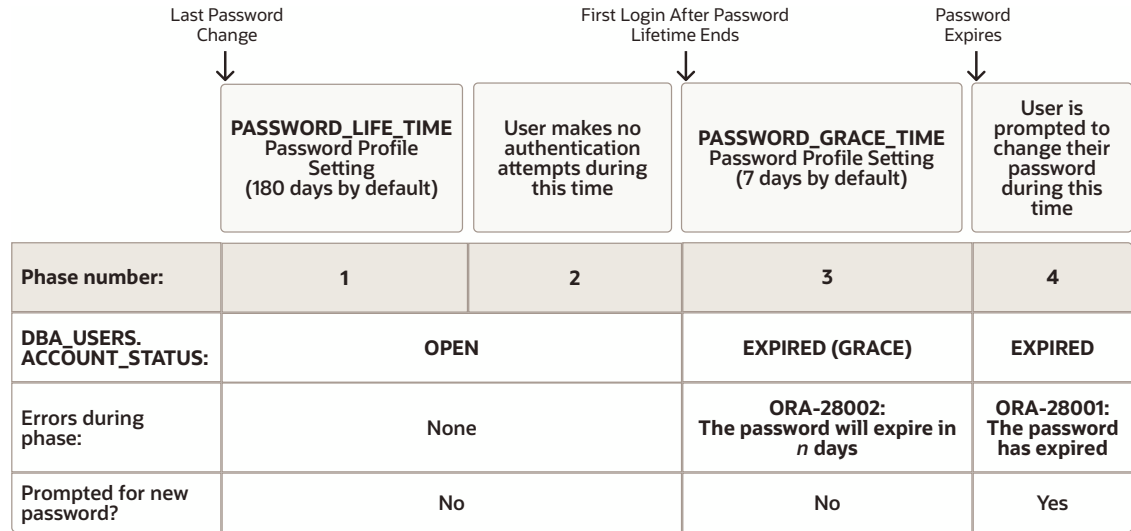

In this figure:

- **Phase 1:** After the user account is created, or the password of an existing account is changed, the password lifetime period begins.
- **Phase 2:** This phase represents the period of time *after* the password lifetime ends but *before* the user logs in again with the correct password. The correct credentials are needed for Oracle Database to update the account status. Otherwise, the account status will remain unchanged. Oracle Database does not have any background process to update the account status. All changes to the account status are driven by the Oracle Database server process on behalf of authenticated users.
- **Phase 3:** When the user finally does log in, the grace period begins. Oracle Database then updates the `DBA_USERS.EXPIRY_DATE` column to a new value using the current time plus the value of the `PASSWORD_GRACE_TIME` setting from the account's password profile. At this point, the user receives an ORA-28002 warning message about the password expiring in the near future (for example, ORA-28002 The password will expire within 7 days if `PASSWORD_GRACE_TIME` is set to 7 days), but the user can still log in without changing the password. The `DBA_USERS.EXPIRY_DATE` column shows the time in the future when the user will be prompted to change their password.
- **Phase 4:** After the grace period (Phase 3) ends, the ORA-28001: The password has expired error appears, and the user is prompted to change the password after entering the current, correct password before the authentication can proceed. If the user has an Oracle Active Data Guard configuration, where there is a primary and a stand-by database, and the authentication attempt is made on the standby database (which is a read-only database), then the ORA-28032: Your password has expired and the database is set to read-only error appears. The user should log into the primary database and change the password there.

During any of these four phases, you can query the `DBA_USERS` data dictionary view to find the user's account status in the `DBA_USERS.ACCOUNT_STATUS` column.

In the following example, the profile assigned to `johndoe` includes the specification of a grace period: `PASSWORD_GRACE_TIME = 3` (the recommended value). The first time `johndoe` tries to log in to the database after 90 days (this can be *any* day after the 90th day, that is, the 91st day, 100th day, or another day), they receive a warning message that their password will expire in 3

days. If 3 days pass, and if they do not change their password, then the password expires. After this, johndoe receives a prompt to change the password on any attempt to log in.

```
CREATE PROFILE prof LIMIT
  FAILED_LOGIN_ATTEMPTS 4
  PASSWORD_LIFE_TIME 90
  PASSWORD_GRACE_TIME 3;

ALTER USER johndoe PROFILE prof;
```

A database administrator or a user who has the `ALTER USER` system privilege can explicitly expire a password by using the `CREATE USER` and `ALTER USER` statements. The following statement creates a user with an expired password. This setting forces the user to change the password before the user can log in to the database.

```
CREATE USER jbrown
  IDENTIFIED BY password
  ...
  PASSWORD EXPIRE;
```

There is no "password unexpire" clause for the `CREATE USER` statement, but an account can be "unexpired" by changing the password on the account.

3.2.4.15 PASSWORD_LIFE_TIME Profile Parameter Low Value

Be careful if you set the `PASSWORD_LIFE_TIME` parameter of `CREATE PROFILE` or `ALTER PROFILE` to a low value (for example, 1 day).

The `PASSWORD_LIFE_TIME` limit of a profile is measured from the last time that an account's password is changed, or the account creation time if the password has never been changed. These dates are recorded in the `PTIME` (password change time) and `CTIME` (account creation time) columns of the `SYS.USER$` system table. The `PASSWORD_LIFE_TIME` limit is not measured starting from the timestamp of the last change to the `PASSWORD_LIFE_TIME` profile parameter, as may be initially thought. Therefore, any accounts affected by the changed profile whose last password change time was more than `PASSWORD_LIFE_TIME` days ago immediately expire and enter their grace period on their next connection, issuing the `ORA-28002: The password will expire within n days warning`.

As a database administrator, you can find an account's last password change time as follows:

```
ALTER SESSION SET NLS_DATE_FORMAT='DD-MON-YYYY HH24:MI:SS';
SELECT PTIME FROM SYS.USER$ WHERE NAME = 'user_name'; -- Password change time
```

To find when the account was created and the password expiration date, issue the following query:

```
SELECT CREATED, EXPIRY_DATE FROM DBA_USERS WHERE USERNAME = 'user_name';
```

If the user who is assigned this profile is currently logged in when you set the `PASSWORD_LIFE_TIME` parameter and remains logged in, then Oracle Database does not change the user's account status from `OPEN` to `EXPIRED (GRACE)` when the currently listed expiration date passes. The timing begins only when the user logs into the database. You can check the user's last login time as follows:

```
SELECT LAST_LOGIN FROM DBA_USERS WHERE USERNAME = 'user_name';
```

When making changes to a password profile, a database administrator must be aware that if some of the users who are subject to this profile are currently logged in to the Oracle database while their password profile is being updated by the administrator, then those users could

potentially remain logged in to the system even beyond the expiration date of their password. You can find the currently logged in users by querying the `USERNAME` column of the `V$SESSION` view.

This is because the expiration date of a user's password is based on the timestamp of the last password change on their account plus the value of the `PASSWORD_LIFE_TIME` password profile parameter set by the administrator. It is *not* based on the timestamp of the last change to the password profile itself.

Note the following:

- If the user is not logged in when you set `PASSWORD_LIFE_TIME` to a low value, then the user's account status does not change until the user logs in.
- You can set the `PASSWORD_LIFE_TIME` parameter to `UNLIMITED`, but this only affects accounts that have not entered their grace period. After the grace period expires, the user must change the password.

3.2.5 Managing Gradual Database Password Rollover for Applications

A gradual database password rollover enables the database password of an application to be updated while avoiding application downtime while the new password is propagated to application clients, by allowing the older password to remain valid for a specified period.

- [About Managing Gradual Database Password Rollover for Applications](#)
You can configure a gradual database password rollover process to begin for database application clients when the database administrator changes the database password for the application.
- [Password Change Life Cycle During a Gradual Database Password Rollover](#)
After a password is created or changed, it follows a life cycle and grace period in four phases.
- [Enabling the Gradual Database Password Rollover](#)
To enable the gradual database password rollover, you must configure the `PASSWORD_ROLLOVER_TIME` user profile parameter.
- [Changing a Password to Begin the Gradual Database Password Rollover Period](#)
After you have set a non-zero `PASSWORD_ROLLOVER_TIME` value, change the user's password and update the password with all the applications.
- [Changing a Password During the Gradual Database Password Rollover Period](#)
After the rollover period has begun, you can still change the password.
- [Ending the Password Rollover Period](#)
There are multiple ways in which you can end the password rollover period.
- [Database Behavior During the Gradual Password Rollover Period](#)
Users can perform their standard password changes and logins during the password rollover period.
- [Database Server Behavior After the Password Rollover Period Ends](#)
Oracle Database performs clean-up operations after the gradual database password rollover period ends.
- [Guideline for Handling Compromised Passwords](#)
If a database account password is suspected of being compromised, then you should change the password immediately.

- [How Gradual Database Password Rollover Works During Oracle Data Pump Exports](#)
When a user is exported while they are in the password rollover period, only the verifier corresponding to their new password is exported.
- [Using Gradual Database Password Rollover in an Oracle Data Guard Environment](#)
In an Oracle Data Guard environment, you must set the `ADG_ACCOUNT_INFO_TRACKING` environment variable to `GLOBAL` to use gradual database password rollover.
- [Finding Users Who Still Use Their Old Passwords](#)
You can perform a query that makes use of the `AUTHENTICATION_TYPE` field for a `LOGIN` audit record to find users who still use their old passwords.

3.2.5.1 About Managing Gradual Database Password Rollover for Applications

You can configure a gradual database password rollover process to begin for database application clients when the database administrator changes the database password for the application.

When the database or application administrator changes the password for the application in the database, the applications must be updated with the new database password. Setting the `PASSWORD_ROLLOVER_TIME` parameter in the user's profile enables a password change to take place without having to risk downtime or application outages that could occur as a result of an application attempting to use an outdated password. The password rollover takes place seamlessly from the server and works with all existing supported client versions.

The gradual database password rollover feature is designed for database accounts (service accounts) for applications. The application could be a single server (database client) or scaled out to multiple servers with multiple database clients. It is not designed for administrative users; hence, administrative users are restricted from using this feature, no matter which profile they are associated with. You cannot grant administrative privileges to users who have a password rollover-enabled profile.

You can configure the gradual database password rollover for native password-authenticated user connections. If you convert a password database account to a `NO AUTHENTICATION` account, then Oracle Database deletes the password and verifiers that are associated with this account. When a password-authenticated user account is converted to a `GLOBAL`, an `EXTERNAL` or a `NO AUTHENTICATION` account, then the user implicitly exits the password rollover period. Gradual password rollover supports the 11g password version and later.

You also can configure the gradual database password rollover for environments that use connected user database links. In this case, when you configure the gradual database password rollover, ensure that you also put the target account into rollover on the target of the connected user database link, and then roll over the target accounts on these links as well. To put the target account into rollover, you would use this syntax:

```
ALTER USER username IDENTIFIED BY same_new_rollover_password;
```

You cannot configure the gradual database password rollover for the following kinds of connections:

- Direct logins for Oracle Real Application Security users
- Kerberos-, certificate-, or RADIUS-based externally authenticated connections
- Centrally managed user (CMU) connections
- Administrative connections that use external password files
- The Oracle Data Guard connection between the primary and the standby

3.2.5.2 Password Change Life Cycle During a Gradual Database Password Rollover

After a password is created or changed, it follows a life cycle and grace period in four phases. The following diagram shows the life cycle of the password lifetime and grace period.

Figure 3-2 Password Change Life Cycle During a Gradual Database Password Rollover

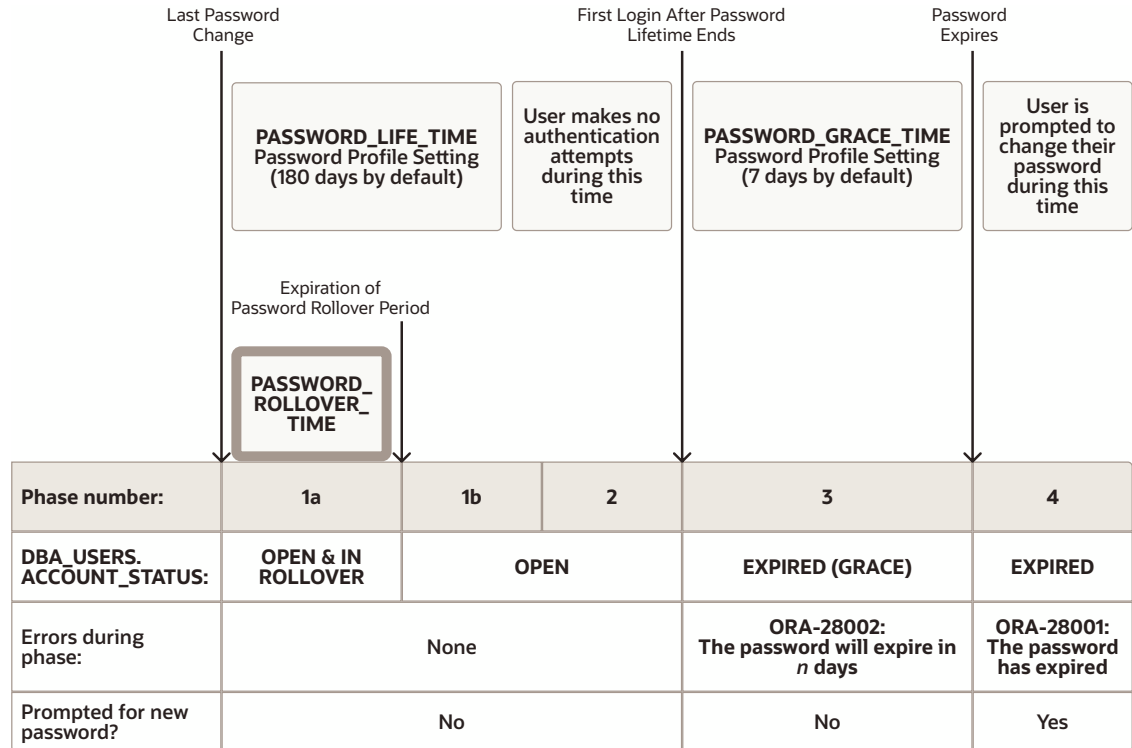

In this figure:

- Phase 1:** The password lifetime begins after the user account is created or when the password has been changed. When the password of an existing account is changed, and the user's profile has a non-zero `PASSWORD_ROLLOVER_TIME` value, then the password lifetime is composed of two phases, 1a and 1b:
 - Phase 1a** begins with the password change. During Phase 1a, the user can log in using either the old password or the new password. The duration of phase 1a is normally `PASSWORD_ROLLOVER_TIME`, but if the administrator was able to update the password in all client applications sooner than this, they can decide to end the password rollover period sooner by issuing the following command, which makes the new password the only one that is accepted.

```
ALTER USER username EXPIRE PASSWORD ROLLOVER PERIOD;
```
 - Phase 1b** corresponds to the time remaining after the password rollover period expires until the end of `PASSWORD_LIFE_TIME`. During Phase 1b, the user can log in using only the new password.
- Phase 2:** This phase represents the period of time *after* the password lifetime ends but *before* the user logs in again with the correct password. The correct credentials are needed for Oracle Database to update the account status. Otherwise, the account status

will remain unchanged. Oracle Database does not have any background process to update the account status. All changes to the account status are driven by the Oracle Database server process on behalf of authenticated users.

- **Phase 3:** When the user finally does log in, the grace period begins. Oracle Database then updates the `DBA_USERS.EXPIRY_DATE` column to a new value using the current time plus the value of the `PASSWORD_GRACE_TIME` setting from the account's password profile. At this point, the user receives an `ORA-28002` warning message about the password expiring in the near future (for example, `ORA-28002 The password will expire within 7 days if PASSWORD_GRACE_TIME is set to 7 days`), but the user can still log in without changing the password. The `DBA_USERS.EXPIRY_DATE` column shows the time in the future when the user will be prompted to change their password.
- **Phase 4:** After the grace period (Phase 3) ends, the `ORA-28001: The password has expired` error appears, and the user is prompted to change the password after entering the current, correct password before the authentication can proceed. If the user has an Oracle Active Data Guard configuration, where there is a primary and a stand-by database, and the authentication attempt is made on the standby database (which is a read-only database), then the `ORA-28032: Your password has expired and the database is set to read-only` error appears. The user should log into the primary database and change the password there.

During any of these four phases, you can query the `DBA_USERS` data dictionary view to find the user's account status in the `DBA_USERS.ACCOUNT_STATUS` column.

In the following example, the profile assigned to `johndoe` includes the specification of a grace period: `PASSWORD_GRACE_TIME = 3` (the recommended value). The first time `johndoe` tries to log in to the database after 90 days (this can be *any* day after the 90th day, that is, the 91st day, 100th day, or another day), he receives a warning message that his password will expire in 3 days. If 3 days pass, and if he does not change his password, then the password expires. After this, he receives a prompt to change his password on any attempt to log in.

```
CREATE PROFILE prof LIMIT
  FAILED_LOGIN_ATTEMPTS 4
  PASSWORD_LIFE_TIME 90
  PASSWORD_GRACE_TIME 3;

ALTER USER johndoe PROFILE prof;
```

A database administrator or a user who has the `ALTER USER` system privilege can explicitly expire a password by using the `CREATE USER` and `ALTER USER` statements. The following statement creates a user with an expired password. This setting forces the user to change the password before the user can log in to the database.

```
CREATE USER jbrown
  IDENTIFIED BY password
  ...
  PASSWORD EXPIRE;
```

There is no "password unexpire" clause for the `CREATE USER` statement, but an account can be "unexpired" by changing the password on the account.

3.2.5.3 Enabling the Gradual Database Password Rollover

To enable the gradual database password rollover, you must configure the `PASSWORD_ROLLOVER_TIME` user profile parameter.

- To configure the gradual database password rollover, set the `PASSWORD_ROLLOVER_TIME` parameter in the `CREATE PROFILE` or `ALTER PROFILE` statement.

For example, to set the gradual password rollover time period to 1 day:

```
CREATE PROFILE prof LIMIT
...
PASSWORD_ROLLOVER_TIME 1;
```

Note the following:

- You specify the rollover time period in days, but you can specify hours if you want. For example, enter 1/24 to specify 1 hour, or 6/24 (or 1/4) to specify 6 hours.
- The minimum value for an active rollover time is 1 hour. The maximum value is 60 days or the lower value of the `PASSWORD_LIFE_TIME` or `PASSWORD_GRACE_TIME` parameter. If `PASSWORD_GRACE_TIME` is set to 0 (zero), then it will be ignored with respect to any limits with `PASSWORD_ROLLOVER_TIME`. The following table describes these limits:

Table 3-2 Password Rollover Time Limits

Profile Name	PASSWORD_LIFE_TIME	PASSWORD_GRACE_TIME	PASSWORD_ROLLOVER_TIME
Default	180	7	* Minimum: 1/24 (1 hour) * Maximum: 7 (days)
ORA_STIG_PROFILE	60	5	* Minimum: 1/24 (1 hour) * Maximum: 5 (days)
User Custom Profile	365	90	* Minimum: 1/24 (1 hour) * Maximum: 60 (days)

- The default setting for `PASSWORD_ROLLOVER_TIME` is 0 or NULL, which disables it.
- To find database accounts that are currently in the password rollover process, query the `ACCOUNT_STATUS` column of the `DBA_USERS` data dictionary view. The status will be IN ROLLOVER.
- The password rollover period begins the moment the the password is changed for the database account.

3.2.5.4 Changing a Password to Begin the Gradual Database Password Rollover Period

After you have set a non-zero `PASSWORD_ROLLOVER_TIME` value, change the user's password and update the password with all the applications.

Use the `ALTER USER` statement to provision a new rollover password for the application. After the user's new password is provisioned in the database, you can update the password on the application servers. You must complete the password updates before the `PASSWORD_ROLLOVER_TIME` period ends.

You can check the user's password rollover status by querying the `ACCOUNT_STATUS` column of the `DBA_USERS` data dictionary view. A user account that is within the rollover period will have a status of `IN ROLLOVER`.

- Use the `CREATE USER` and `ALTER USER` statements to configure the user, the associated profile, and the password rollover period. `CREATE USER` allows the administrator to create a new application service account that is associated with a profile with password rollover. `ALTER USER` is more likely where an existing user is associated with a new or modified profile. To alter the profile, use the `ALTER PROFILE` statement.

The following example `CREATE USER` creates a new user `u1` with password `p1` and a profile `prof1`, with `PASSWORD_ROLLOVER_TIME` configured. The `ALTER USER` statement changes the user's password to begin password rollover period. To check the user status, query the `DBA_USERS` data dictionary view.

1. Create the profile `prof1`.

```
CREATE PROFILE prof1
LIMIT
PASSWORD_ROLLOVER_TIME 1;
```

2. Create the user `u1` and associate this user with the `prof1` profile.

```
CREATE USER u1 IDENTIFIED BY p1 PROFILE prof1;
```

3. Alter the user's password.

```
ALTER USER u1 IDENTIFIED BY p2;
```

4. Query the `DBA_USER` data dictionary view to check the user's rollover status.

```
SELECT USERNAME, ACCOUNT_STATUS FROM DBA_USERS WHERE USERNAME = 'U1';

USERNAME ACCOUNT_STATUS
-----
U1          OPEN & IN ROLLOVER
```

3.2.5.5 Changing a Password During the Gradual Database Password Rollover Period

After the rollover period has begun, you can still change the password.

For example, suppose you inadvertently mistype the password. The following procedure enables you to correct the password even though the rollover process has already begun.

- To change a password after the rollover process has begun, use the `ALTER USER` statement, with or without the `REPLACE` clause.

For example, suppose user `u1` has the original password `p1`, `p2` is the new password that started the rollover process, and you want to switch to using another password `p3` instead of password `p2`. Any of the following statements work:

```
ALTER USER u1 IDENTIFIED BY p3;

ALTER USER u1 IDENTIFIED BY p3 REPLACE p1;
```

```
ALTER USER u1 IDENTIFIED BY p3 REPLACE p2;
```

After you have changed the password to p3, the user can log in using either p1 or p3. An attempt to log in using p2 returns an `ORA-1017 Invalid Username/Password` error, and is recorded as a failed login attempt. Similarly, after a subsequent password change from p3 to p4 during the rollover period, the user can log in using either p1 or p4. Attempts to log in using either p2 or p3 will return an `ORA-1017 Invalid Username/Password` error, and are recorded as failed login attempts.

The rollover start time is fixed the first time a user changes their password. The start time is not affected by further password changes during the password rollover period. This design limits the length of time the old password can be used to the `PASSWORD_ROLLOVER_TIME` period after the password is changed outside of the password rollover period.

3.2.5.6 Ending the Password Rollover Period

There are multiple ways in which you can end the password rollover period.

For example, suppose p1 is the original password for user u1, and p2 is the new password that has been updated to all clients.

- Use one of the following methods to end the password rollover period:
 - Let the password rollover period expire on its own. For example, if the password rollover period is 1 day, wait for 1 day and the password rollover period will expire automatically.
 - As either the user or an administrator, run the following statement to manually end the password rollover period:

```
ALTER USER u1 EXPIRE PASSWORD ROLLOVER PERIOD;
```

- As an administrator, expire the password by executing the `ALTER USER username PASSWORD EXPIRE` statement. The next time the user logs in, they will be required to change their password.

Beginning with the first connection attempt after the password rollover period expires, Oracle Database drops the earlier password p1. Any attempt to login using the old password p1 returns an `ORA-1017 Invalid Username/Password` error, and is recorded as a failed login attempt. In effect, connections after the rollover period are authenticated with only the new password, and connections that are attempted with the old password are recorded as failed login attempts. The failed login attempts could lock an account after a sufficient number of consecutive logon attempts with the old password.

Connection attempts to read-only database servers after `PASSWORD_ROLLOVER_TIME` expires will require new password (p2). The password change to p2 will be made effective for all database clients.

3.2.5.7 Database Behavior During the Gradual Password Rollover Period

Users can perform their standard password changes and logins during the password rollover period.

The following database behavior is implemented during the rollover period:

- The user can log in to the database using either the new or the old password. This effectively increases the lifetime of the old password by the time set with `PASSWORD_ROLLOVER_TIME`.

- Passwords can be changed by using the following methods:
 - An administrator or the user changes their own password by using the `ALTER USER` statement.
 - The user changes their own password by using the `SQL*Plus password` command.
 - The user's password is programmatically changed when the Oracle Call Interface (Oracle OCI) `OCIPasswordChange` function is run.
- Oracle Database does not send any special messages to the database clients that indicate that the user account is in the password rollover period. This design avoids any errors from applications that may not be equipped to handle error and warning messages when a user logs in.
- Too many failed login attempts move the user account into a timed lock state, depending on the value of profile limit `PASSWORD_LOCK_TIME`. After the timed lock period expires, the state of the password rollover period determines what happens when the user attempts to log in.
- User administrators can perform other password lifecycle related actions as usual, such as `ACCOUNT LOCK`, `ACCOUNT UNLOCK`, `EXPIRE PASSWORD` operations.
- The password limits that have been set by the `PASSWORD_REUSE_TIME` and `PASSWORD_REUSE_MAX` in the user profile continue to be honored during the rollover period. Any password changes during the rollover period are validated against password change history and added into the password change history.
- Expiring a user account does not affect the password rollover status. As with locked accounts, Oracle Database maintains the verifiers in their current state. The user can log in using either old or new password (`p1` or `p2`). However, after the user successfully changes their password (to `p3`), the user is allowed to log in only using the newest password (`p3`). Both the old passwords are treated as expired.
- Oracle Data Pump exports the password hashes (also known as verifiers) for the latest password for user accounts in the password rollover period. For example, if a user `u1` has an old password `p1` and new password `p2`, then Oracle Data Pump exports password hashes for password `p2` only.

3.2.5.8 Database Server Behavior After the Password Rollover Period Ends

Oracle Database performs clean-up operations after the gradual database password rollover period ends.

After the password rollover period expires, only the new password is allowed and the old password stops working. Attempting to use the old password returns an `ORA-1017 Invalid Username/Password` error, and is recorded as a failed login attempt. Connections after the password rollover period will only use the new password, and attempts to use the previous passwords will fail for both read-only and read-write databases. Failed login attempts could lock the user account depending on how many consecutive login attempts have been made to use the old password, based on the `FAILED_LOGIN_ATTEMPTS` limit in the password profile.

3.2.5.9 Guideline for Handling Compromised Passwords

If a database account password is suspected of being compromised, then you should change the password immediately.

You can perform this change without going through a password rollover period by using the `ALTER USER` statement in one execution to both change and expire the old password, instead of executing two commands sequentially. This option is preferred over changing the

`PASSWORD_ROLLOVER_TIME` in the associated user profile, because other accounts will then be affected.

Use the following syntax to change and expire the old password:

```
ALTER USER user_name IDENTIFIED BY new_password EXPIRE PASSWORD ROLLOVER
PERIOD;
```

3.2.5.10 How Gradual Database Password Rollover Works During Oracle Data Pump Exports

When a user is exported while they are in the password rollover period, only the verifier corresponding to their new password is exported.

The verifier that corresponds to their old password is not included in the Oracle Data Pump dump file. After the user is imported, only the new password can be used to authenticate.

3.2.5.11 Using Gradual Database Password Rollover in an Oracle Data Guard Environment

In an Oracle Data Guard environment, you must set the `ADG_ACCOUNT_INFO_TRACKING` environment variable to `GLOBAL` to use gradual database password rollover.

```
ADG_ACCOUNT_INFO_TRACKING=GLOBAL
```

Otherwise, any initial logons that are performed on the Oracle Data Guard standby by a user who authenticated using the new password after the `PASSWORD_ROLLOVER_TIME` expiration will result in an `ORA-16000: database or pluggable database open for read-only access error`.

3.2.5.12 Finding Users Who Still Use Their Old Passwords

You can perform a query that makes use of the `AUTHENTICATION_TYPE` field for a `LOGIN` audit record to find users who still use their old passwords.

The unified audit trail can identify which users are still connecting to the database using an old password. The `AUTHENTICATION_TYPE` field for a `LOGON` audit record can show if the old verifier was used. This information enables you to find applications that have not been updated with gradual database password rollover to use the new password. The `LOGON` audit record indicates which application server must be updated.

1. Connect to the database as a user who has the `AUDIT_VIEWER` or `AUDIT_MGMT` role.
2. Run the following query:

```
SELECT DBUSERNAME, AUTHENTICATION_TYPE, OS_USERNAME, USERHOST,
EVENT_TIMESTAMP
FROM UNIFIED_AUDIT_TRAIL
WHERE ACTION_NAME='LOGON' AND EVENT_TIMESTAMP > SYSDATE-1
AND REGEXP_LIKE(AUTHENTICATION_TYPE, '\(VERIFIER=..*?\-OLD\)');
```

If there are users who are still using their old password, then output similar to the following appears:

```

DBUSERNAME
AUTHENTICATION_TYPE

          OS_USERNAME      USERHOST      EVENT_TIMESTAMP
-----
APP_USER      (TYPE=(DATABASE)); (CLIENT_ADDRESS=((PROTOCOL=tcp)
(HOST=192.0.2.225) (PORT=24938))); (LOGON_INFO=( (VERIFIER=12C-OLD)
(CLIENT_CAPABILITIES=05L_NP,07L_MR,08L_LI)));      oracle
db211        14-JAN-21 08.56.34.724172000 PM
APP_USER      (TYPE=(DATABASE)); (CLIENT_ADDRESS=((PROTOCOL=tcp)
(HOST=192.0.2.225) (PORT=24983))); (LOGON_INFO=( (VERIFIER=12C-OLD)
(CLIENT_CAPABILITIES=05L_NP,07L_MR,08L_LI)));      oracle
db211        14-JAN-21 09.01.18.938008000 PM
APP_USER      (TYPE=(DATABASE)); (CLIENT_ADDRESS=((PROTOCOL=tcp)
(HOST=192.0.2.226) (PORT=48727))); (LOGON_INFO=( (VERIFIER=12C-OLD)
(CLIENT_CAPABILITIES=05L_NP,07L_MR,08L_LI)));      oracle
db212        14-JAN-21 10.10.48.042817000 PM
APP_USER      (TYPE=(DATABASE)); (CLIENT_ADDRESS=((PROTOCOL=tcp)
(HOST=192.0.2.226) (PORT=48745))); (LOGON_INFO=( (VERIFIER=12C-OLD)
(CLIENT_CAPABILITIES=05L_NP,07L_MR,08L_LI)));      oracle
db212        14-JAN-21 10.12.53.609965000 PM
APP_USER      (TYPE=(DATABASE)); (CLIENT_ADDRESS=((PROTOCOL=tcp)
(HOST=192.0.2.226) (PORT=48751))); (LOGON_INFO=( (VERIFIER=12C-OLD)
(CLIENT_CAPABILITIES=05L_NP,07L_MR,08L_LI)));      oracle
db212        14-JAN-21 10.13.41.112194000 PM

```

3.2.6 Managing the Complexity of Passwords

Oracle Database provides a set of functions that you can use to manage the complexity of passwords.

- [About Password Complexity Verification](#)
Complexity verification checks that each password is complex enough to protect against intruders who try to guess user passwords.
- [How Oracle Database Checks the Complexity of Passwords](#)
Oracle Database provides four password verification functions to check password complexity.
- [Who Can Use the Password Complexity Functions?](#)
The password complexity functions enable you to customize how users access your data.
- [ora12c_verify_function Password Requirements](#)
The `ora12c_verify_function` function fulfills the *Department of Defense Database Security Technical Implementation Guide* requirements.
- [ora12c_strong_verify_function Function Password Requirements](#)
The `ora12c_strong_verify_function` function is a stringent password verify function.
- [ora12c_stig_verify_function Password Requirements](#)
The `ora12c_stig_verify_function` function fulfills the Department of Defense Security Technical Implementation Guide (STIG) requirements.

- [About Customizing Password Complexity Verification](#)
Oracle Database enables you to customize password complexity for your site.
- [Enabling Password Complexity Verification](#)
The `catpvf.sql` script can be customized to enable password complexity verification.

3.2.6.1 About Password Complexity Verification

Complexity verification checks that each password is complex enough to protect against intruders who try to guess user passwords.

Using a complexity verification function forces users to create strong, secure passwords for database user accounts. You must ensure that the passwords for your users are complex enough to provide reasonable protection against intruders who try to break into the system by guessing passwords.

Be aware that if you associate a password verification function with a user's profile, then dropping the password verification function will prevent the user from changing their password and cause an `ORA-7443: function for password verification not found error`.

3.2.6.2 How Oracle Database Checks the Complexity of Passwords

Oracle Database provides four password verification functions to check password complexity.

These functions are in the `catpvf.sql` PL/SQL script (located in `$ORACLE_HOME/rdbms/admin`). When these functions are enabled, they can check whether users are correctly creating or modifying their passwords. When enabled, password complexity checking is not enforced for user `SYS`; it only applies to non-`SYS` users. For better security of passwords, Oracle recommends that you associate the password verification function with the default profile.

Related Topics

- [About Customizing Password Complexity Verification](#)
Oracle Database enables you to customize password complexity for your site.

3.2.6.3 Who Can Use the Password Complexity Functions?

The password complexity functions enable you to customize how users access your data.

Before you can use the password complexity verification functions in the `CREATE PROFILE` or `ALTER PROFILE` statement, you must be granted the `EXECUTE` privilege on them.

The password verification functions are located in the `SYS` schema.

3.2.6.4 ora12c_verify_function Password Requirements

The `ora12c_verify_function` function fulfills the *Department of Defense Database Security Technical Implementation Guide* requirements.

This function checks for the following requirements when users create or modify passwords:

- The password contains no fewer than 8 characters and includes at least one numeric and one alphabetic character.
- The password is not the same as the user name or the user name reversed.
- The password is not the same as the database name.
- The password does not contain the word `oracle` (such as `oracle123`).

- The password differs from the previous password by at least 3 characters.
- The password contains at least 1 special character.

The following internal check is also applied:

- The password does not contain the double-quotation character ("). However, it can be surrounded by double-quotation marks.

3.2.6.5 ora12c_strong_verify_function Function Password Requirements

The `ora12c_strong_verify_function` function is a stringent password verify function.

This function checks for the following requirements when users create or modify passwords:

- The password contains no fewer than 9 characters.
- The password contains at least 2 upper case letters.
- The password contains at least 2 lower case letters.
- The password contains at least 2 numeric characters.
- The password contains at least 2 special characters. These special characters are as follows:

`` ~ ! @ # $ % ^ & * () _ - + = { } [] \ / < > , . ; ? ' : | (space)`

- The password differs from the previous password by at least 4 characters.

The following internal check is also applied:

- The password does not contain the double-quotation character ("). It can be surrounded by double-quotation marks, however.

3.2.6.6 ora12c_stig_verify_function Password Requirements

The `ora12c_stig_verify_function` function fulfills the Department of Defense Security Technical Implementation Guide (STIG) requirements.

This function checks for the following requirements when users create or modify passwords:

- The password has at least 15 characters.
- The password has at least 1 lower case character and at least 1 upper case character.
- The password has at least 1 digit.
- The password has at least 1 special character.
- The password differs from the previous password by at least 8 characters.

The following internal check is also applied:

- The password does not contain the double-quotation character ("). However, it can be surrounded by double-quotation marks.

The `ora12c_stig_verify_function` function is the default handler for the `ORA_STIG_PROFILE` profile, which is available in a newly-created or upgraded Oracle database.

Related Topics

- [Security Technical Implementation Guide Predefined Unified Audit Policies](#)
You can use predefined unified audit policies to implement Security Technical Implementation Guide (STIG) audit requirements.

3.2.6.7 About Customizing Password Complexity Verification

Oracle Database enables you to customize password complexity for your site.

You can create your own password complexity verification function in the `SYS` schema, similar to the functions that are defined in `admin/catpvf.sql`. In fact, Oracle recommends that you do so to further secure your site's passwords.

Note the following:

- Do not include Data Definition Language (DDL) statements in the custom password complexity verification function. DDLs are not allowed during the execution of password complexity verification functions.
- Do not modify the `admin/catpvf.sql` script or the Oracle-supplied password complexity functions. You can create your own functions based on the contents of these files.
- If you make no modifications to the `utlpwdmg.sql` script, then it uses the `ora12c_verify_function` function as the default function.

Related Topics

- [Guidelines for Securing Passwords](#)
Oracle provides guidelines for securing passwords in a variety of situations.

3.2.6.8 Enabling Password Complexity Verification

The `catpvf.sql` script can be customized to enable password complexity verification.

To enable password complexity verification, you must make a copy of the `catpvf.sql` script and then modify it to use the password verification function that you want. After you have modified `catpvf.sql`, run the script to enable it.

1. Log in to SQL*Plus with administrative privileges.

For example:

```
CONNECT SYSTEM
Enter password: password
```

2. Run your modified version of the `catpvf.sql` script to create the password complexity functions in the `SYS` schema.

```
@$ORACLE_HOME/rdbms/admin/<your_modified_script.sql>
```

3. Grant any users who must use this function the `EXECUTE` privilege on it.

For example:

```
GRANT pmsith EXECUTE ON ora12c_strong_verify_function;
```

4. In the default profile or the user profile, set the `PASSWORD_VERIFY_FUNCTION` setting to either the sample password complexity function in the `catpvf.sql` script, or to your customized function. Use one of the following methods:

- Log in to SQL*Plus with administrator privileges and use the `CREATE PROFILE` or `ALTER PROFILE` statement to enable the function. Ensure that you have the `EXECUTE` privilege on the function.

For example, to update the default profile to use the `ora12c_strong_verify_function` function:

```
ALTER PROFILE default LIMIT
PASSWORD_VERIFY_FUNCTION ora12c_strong_verify_function;
```

- In Oracle Enterprise Manager Cloud Control, from the **Administration** menu, select **Security**, and then **Profiles**. Select the **Password** tab. Under **Complexity**, from the **Complexity function** list, select the name of the complexity function that you want. Click **Apply**.

After you have enabled password complexity verification, it takes effect immediately. If you must disable it, then run the following statement:

```
ALTER PROFILE DEFAULT LIMIT PASSWORD_VERIFY_FUNCTION NULL;
```

Note:

The `ALTER USER` statement has a `REPLACE` clause. With this clause, users can change their own unexpired passwords by supplying the previous password to authenticate themselves.

If the password has expired, then the user cannot log in to SQL to issue the `ALTER USER` command. Instead, the `OCIPasswordChange()` function must be used, which also requires the previous password.

A database administrator with `ALTER ANY USER` privilege can change any user password (force a new password) without supplying the old one.

3.2.7 Managing Password Case Sensitivity

You can manage the password case sensitivity for passwords from user accounts from previous releases.

- [Management of Case Sensitivity for Secure Role Passwords](#)
Oracle Database ensures that the passwords for secure roles are case sensitive.
- [Management of Password Versions of Users](#)
By default, Oracle Database uses Exclusive Mode, which does not permit case-insensitive passwords, to manage password versions.
- [Finding and Resetting User Passwords That Use the 10G Password Version](#)
For better security, find and reset passwords for user accounts that use the 10G password version so that they use later, more secure password versions.
- [How Case Sensitivity Affects Password Files](#)
The password file version and whether the password file contains accounts from previous releases affects the case sensitivity of administrative authentication.
- [How Case Sensitivity Affects Passwords Used in Database Link Connections](#)
When you create a database link connection, you must define a user name and password for the connection.

3.2.7.1 Management of Case Sensitivity for Secure Role Passwords

Oracle Database ensures that the passwords for secure roles are case sensitive.

If before upgrading to the current release, you created secure roles by using the `IDENTIFIED BY` clause of the `CREATE ROLE` statement, and if upon upgrading to Oracle Database 12c release 12.2, you set the `SQLNET.ALLOWED_LOGON_VERSION_SERVER` parameter to one of the

Exclusive Modes 12 or 12a, then you must change the password for these secure roles in order for them to remain usable. Because Exclusive Mode is now the default, secure roles that were created in earlier releases (such as Oracle Database 10g, in which the 10G password version was the default) will need to have their passwords changed. These passwords will automatically be case sensitive.

You can query the `PASSWORD_REQUIRED` and `AUTHENTICATION_TYPE` columns of the `DBA_ROLES` data dictionary view to find any secure roles that must have their password changed after upgrading to the current release, in order to become usable again.

3.2.7.2 Management of Password Versions of Users

By default, Oracle Database uses Exclusive Mode, which does not permit case-insensitive passwords, to manage password versions.

In a default installation, the `SQLNET.ALLOWED_LOGON_VERSION_SERVER` parameter is set to 12 to enable Exclusive Mode. Exclusive Mode requires that the password-based authentication protocol use one of the case-sensitive password versions (11G or 12C) for the account that is being authenticated. Exclusive Mode excludes the use of the 10G password version that was used in earlier releases. After you upgrade to Oracle Database 12c release 2 (12.2) or later, accounts that use the 10G password version become inaccessible. (As of Oracle Database 23ai, the 10G password version is no longer supported.) This occurs because the server runs in Exclusive Mode by default, and Exclusive Mode cannot use the old 10G password version to authenticate the client. The server is left with no password version with which to authenticate the client.

The user accounts from Release 10g use the 10G password version. Therefore, you should find the user accounts that use the 10G password version, and then reset the passwords for these accounts. This generates the appropriate password version based on the setting of the `SQLNET.ALLOWED_LOGON_VERSION_SERVER` parameter, as follows:

- `SQLNET.ALLOWED_LOGON_VERSION_SERVER=8` generates password versions 11G and 12C.
- `SQLNET.ALLOWED_LOGON_VERSION_SERVER=12` generates both 11G and 12C password versions, and removes the 10G password version.
- `SQLNET.ALLOWED_LOGON_VERSION_SERVER=12a` generates only the 12C password version.

After the user accounts from an Oracle Database release 10g (or earlier) have been imported into the current database release, if a user had only the 10G password version, then a database administrator must alter the user's password. This sets the user's password version to be 11G and 12C, so that the password automatically becomes case sensitive.

3.2.7.3 Finding and Resetting User Passwords That Use the 10G Password Version

For better security, find and reset passwords for user accounts that use the 10G password version so that they use later, more secure password versions.

Starting in Oracle Database 23ai, the 10G password version is no longer supported.

Finding All Password Versions of Current Users

You can query the `DBA_USERS` data dictionary view to find a list of all the password versions configured for user accounts.

For example:

```
SELECT USERNAME, PASSWORD_VERSIONS FROM DBA_USERS;
```

USERNAME	PASSWORD_VERSIONS
JONES	10G 11G 12C
ADAMS	10G 11G
CLARK	10G 11G
PRESTON	11G
BLAKE	10G

The `PASSWORD_VERSIONS` column shows the list of password versions that exist for the account. `10G` refers to the desupported case-insensitive Oracle password version, `11G` refers to the SHA-1-based password version, and `12C` refers to the SHA-2-based SHA-512 password version.

Note:

Starting with Oracle Database 23ai, the SHA-1 verifier introduced with Oracle Database 11g is deprecated.

The salted multi-round SHA-512 password hash (also known as "verifier") introduced with Oracle Database 12c provides enhanced security for your password. If 11g verifiers (11G) are still being used in your database, then Oracle recommends resetting them so they can be upgraded to the 12c (12C) de-optimized PBKDF2-based verifier.

- User `jones`: The password for this user was reset in Oracle Database 12c Release 12.1 when the `SQLNET.ALLOWED_LOGON_VERSION_SERVER` parameter setting was 8. This enabled all three password versions to be created.
- Users `adams` and `clark`: The passwords for these accounts were originally created in Oracle Database 10g and then reset in Oracle Database 11g. The Oracle Database 11g software was using the default `SQLNET.ALLOWED_LOGON_VERSION` setting of 8 at that time. Because case insensitivity is enabled by default, their passwords are now case sensitive, as is the password for `preston`.
- User `preston`: This account was imported from an Oracle Database 11g database that was running in Exclusive Mode (`SQLNET.ALLOWED_LOGON_VERSION = 12`).
- User `blake`: This account still uses the Oracle Database 10g password version. At this stage, user `blake` is prevented from logging in.

Resetting User Passwords That Use Only the 10G Password Version

You should remove the `10G` password version from the accounts of all users and then ensure that users are using the `11G` or later verifiers. If you have already upgraded to release 23ai or later, a user who has only the `10G` password version cannot log in to the database, because the `10G` password version is no longer supported. An administrator will need to manually reset this user's password.

1. Ensure that all clients have the `O5L_NP` capability by making ensuring that they have the `CPUOct2012` patch.

See *Oracle Database Net Services Reference* for more information about O5L_NP.

2. Query the `DBA_USERS` data dictionary view to find user accounts that have **only** the 10G verifier.

```
SELECT USERNAME FROM DBA_USERS
WHERE ( PASSWORD_VERSIONS = '10G '
OR PASSWORD_VERSIONS = '10G HTTP ' )
AND USERNAME <> 'ANONYMOUS';
```

3. After logging in as an account administrator, change the passwords for these accounts so that both the 11G and 12C verifiers can be provisioned for these accounts. (Because the 10G verifier is desupported, users having only this verifier cannot perform this password-change operation themselves, and an administrative user must reset their password.)
4. Send the new password to the users using a secure, out-of-band form of communication, and then ask the user to change the password on their own.

3.2.7.4 How Case Sensitivity Affects Password Files

The password file version and whether the password file contains accounts from previous releases affects the case sensitivity of administrative authentication.

Any password file account from a previous release that has only the 10G verifier can only perform case-insensitive administrative authentication. The 10G verifier is no longer supported as of Oracle Database 23ai.

After a password file has been created (using the `orapwd` utility), the Oracle database updates it when an administrative privilege is granted to or revoked from the user, or when the password of a user who has an administrative privilege is updated.

The password file is external to the database, allowing the Oracle database to authenticate administrative connections (using the `AS administrative_privilege_name` clause, for example, `AS SYSKM`) even when the database is in the `CLOSED` state.

When an administrative connection is attempted, the Oracle database searches for the user in the password file to verify their password and to ensure that the user has been granted the requested administrative privilege. The Oracle database can use the password file to authenticate an administrative connection even when the database is in the `CLOSED` state.

The version of the password file and the type of verifier that it contains for the administrative user affects whether the authentication of that administrative user can be done in a case-sensitive fashion.

However, password files from earlier Oracle Database releases will by default retain their original case-insensitive verifiers. Oracle recommends that you force case sensitivity in these older password files by migrating the password file from one format to another and changing the password of any account that has only a 10G verifier, using the following syntax:

```
orapwd FILE=new_pwd_file_name INPUT_FILE=old_pwd_file_name [FORMAT=12.2]
```

The `FORMAT` and `FORCE` options are not mandatory and can be omitted. If you omit `FORMAT`, then it defaults to 12.2. If the `FILE` and `INPUT_FILE` options are set to the same file, then the `FORCE` option would be required.

For example:

```
orapwd FILE='/u01/oracle/dbs/old_pwd_file_name' INPUT_FILE='/u01/oracle/dbs/
new_pwd_file_name' FORMAT=12.2 FORCE=y
Enter password for SYS: password
```

Assuming that the user accounts in the password file have the newer verifiers (11G and 12C), this command creates a case-sensitive password file called `new_pwd_file_name` that will authenticate administrative connections in a case-sensitive fashion. If any user account in the password file uses only the older 10G verifier, then the password of this account must be changed to enable case-sensitive authentication of administrative connections to that account. Afterward, if you connect using this password, it succeeds—as long as you enter it using the exact case in which it was created. If you enter the same password but with a different case, then the authentication attempt that uses the password fails.

If you imported user accounts from a previous release and these accounts were created with `SYSDBA` or `SYSOPER` administrative privilege, then they will be included in the password file. The passwords for these accounts are case insensitive. The next time these users change their passwords, the passwords become case sensitive. For greater security, have these users change their passwords. You can use the `ALTER USER PASSWORD EXPIRE` statement to expire a user's password. Afterward, ask the user log in again, so that the user will be prompted to change their password.

Related Topics

- *Oracle Database Administrator's Guide*

3.2.7.5 How Case Sensitivity Affects Passwords Used in Database Link Connections

When you create a database link connection, you must define a user name and password for the connection.

When you create the database link connection, the password is case sensitive. How a user enters their password for the database link depends on the release to which the database link was created:

- Users can connect from a pre-Oracle Database 12c database to an Oracle Database 12c or later database. Because case sensitivity is enabled, then the user must enter the password using the case that was used when the account was created.
- If the user connects from an Oracle Database 12c or later database to a pre-Oracle Database 12c database, and if the `SEC_CASE_SENSITIVE_LOGON` parameter in the pre-Release 12c database had been set to `FALSE`, then the password for this database link can be specified using any case.

You can find the user accounts for existing database links by querying the `V$DBLINK` view. For example:

```
SELECT DB_LINK, OWNER_ID FROM V$DBLINK;
```

Related Topics

- *Oracle Database Reference*

3.2.8 Ensuring Against Password Security Threats by Using the 12C Password Version

The 12C password version enables users to create complex passwords that meet compliance standards.

- [About the 12C Version of the Password Hash](#)
The 12C password hash protects against password-based security threats by including support for mixed case passwords.

- [Oracle Database 12C Password Version Configuration Guidelines](#)
By default, Oracle Database generates two versions of the password hash: 11G and 12C.
- [Configuring Oracle Database to Use the 12C Password Version Exclusively](#)
You should set the `SQLNET.ALLOWED_LOGON_VERSION_SERVER` parameter to 12a so that only the 12C password hash version is used.
- [How Server and Client Logon Versions Affect Database Links](#)
The `SQLNET.ALLOWED_LOGON_VERSION_SERVER` and `SQLNET.ALLOWED_LOGON_VERSION_CLIENT` parameters can accommodate connections between databases and clients of different releases.
- [Configuring Oracle Database Clients to Use the 12C Password Version Exclusively](#)
An intruder may try to provision a fake server to downgrade authentication and trick the client into using a weaker password hash version.

3.2.8.1 About the 12C Version of the Password Hash

The 12C password hash protects against password-based security threats by including support for mixed case passwords.

The cryptographic hash function used for generating the 12C version of the password hash is based on a de-optimized algorithm involving Password-Based Key Derivation Function 2 (PBKDF2) and the SHA-512 cryptographic hash functions. The PBKDF2 algorithm introduces computational asymmetry in the challenge that faces an intruder who is trying to recover the original password when in possession of the 12C version of the password hash. The 12C password generation performs a SHA-512 hash of the PBKDF2 output as its last step. This two-step approach used in the 12C password version generation allows server CPU resources to be conserved when the client has the O7L_MR capability. This is because during authentication, the server only needs to perform a single SHA-512 hash of a value transmitted by the O7L_MR capable client, to validate it against the 12C version of the password hash.

In addition, the 12C password version adds a salt to the password when it is hashed, which provides additional protection. (Salt is a random string that is added to the data before it is encrypted, making it more difficult for attackers to steal the data by matching patterns of ciphertext to known ciphertext samples.) The 12C password version enables your users to create far more complex passwords. The 12C password version's use of salt, its use of PBKDF2 de-optimization, and its support for mixed-case passwords makes it more expensive for an intruder to perform dictionary or brute force attacks on the 12C password version in an attempt to recover the user's password. Oracle recommends that you use the 12C version of the password hash.

The password hash values are considered to be extremely sensitive, because they are used as a "shared secret" between the server and person who is logging in. If an intruder learns this secret, then the protection of the authentication is immediately and severely compromised. Remember that administrative users who have account management privileges, administrative users who have the `SYSDBA` administrative privilege, or even users who have the `EXP_FULL_DATABASE` role can immediately access the password hash values. Therefore, this type of administrative user must be trustworthy if the integrity of the database password-based authentication is to be preserved. If you cannot trust these administrators, then it is better to deploy a directory server (such as Centrally Managed Users (CMU)) so that the password hash values remain within the directory server and are never accessible to anyone except the CMU administrator.

Related Topics

- [Oracle Database Net Services Reference](#)

3.2.8.2 Oracle Database 12C Password Version Configuration Guidelines

By default, Oracle Database generates two versions of the password hash: 11G and 12C.

The version of the password hash that Oracle Database uses to authenticate a given client depends on the client's ability, and the settings for the `SQLNET.ALLOWED_LOGON_VERSION_CLIENT` and `SQLNET.ALLOWED_LOGON_VERSION_SERVER` parameters. See the column "Ability Required of the Client" in the "SQLNET.ALLOWED_LOGON_VERSION_SERVER Settings" table in the `SQLNET.ALLOWED_LOGON_VERSION_SERVER` parameter description in *Oracle Database Net Services Reference* for detailed information about how the client authentication works with password versions.

The 10G password version, which was generated in Oracle Database 10g (and is no longer supported as of Oracle Database 23ai), is not case sensitive. Both the 11G and 12C password versions are case sensitive.

In Oracle Database 12g release 2 (12.2), the `sqlnet.ora` parameter `SQLNET.ALLOWED_LOGON_VERSION_SERVER` defaults to 12, which is Exclusive Mode and prevents the use of the 10G password version, and the `SQLNET.ALLOWED_LOGON_VERSION_CLIENT` parameter defaults to 11. For new accounts, when the client is Oracle Database 12c, then Oracle Database uses the 12C password version exclusively with clients that are running the Oracle Database 12c release software. For accounts that were created before Oracle Database release 12c, logins will succeed as long as the client has the O5L_NP ability, because an 11G password version normally exists for accounts created in earlier releases such as Oracle Database release 11g. For a very old account (for example, from Oracle Database release 10g), the user's password must be reset, in order to update the password version for the account. To configure this server to generate only the 12C password version whenever a new account is created or an existing account password is changed, then set the `SQLNET.ALLOWED_LOGON_VERSION_SERVER` parameter to 12a. However, if you want your applications to be compatible with older clients, then ensure that `SQLNET.ALLOWED_LOGON_VERSION_SERVER` is set to 12, which is the default.

How you set the `SQLNET.ALLOWED_LOGON_VERSION_SERVER` parameter depends on the balance of security and interoperability with older clients that your system requires. You can control the levels of security as follows:

- **Greatest level of compatibility:** To configure the server to generate both versions of the password hash (the 12C password version, the 11G password version), whenever a new account is created or an existing account password is changed, set the `SQLNET.ALLOWED_LOGON_VERSION_SERVER` parameter to the value 11 or lower. (Be aware that earlier releases used the value 8 as the default.)
- **Recommended level of security:** To configure the server to generate both the 12C password version and the 11G password version (but *not* the 10G password version), whenever a new account is created or an existing account password is changed, set the `SQLNET.ALLOWED_LOGON_VERSION_SERVER` parameter to the value 12.
- **Highest level of security:** To configure the server to generate *only* the 12C password version whenever a new account is created or an existing account password is changed, set the `SQLNET.ALLOWED_LOGON_VERSION_SERVER` parameter to the value 12a.

During authentication, the following scenarios are possible, based on the kinds of password versions that exist for the account, and on the version of the client software being used:

- **Accounts with only the 10G version of the password hash:** If you want to force the server to generate the newer versions of the password hash for older accounts, an administrator must reset the password for any account that has only the 10G password

version (and none of the more secure password versions, 11G or 12C). You must generate these password versions because the database depends on using these password versions to provide stronger security. You can find these users as follows.

```
SELECT USERNAME FROM DBA_USERS
WHERE ( PASSWORD_VERSIONS = '10G '
OR PASSWORD_VERSIONS = '10G HTTP ' )
AND USERNAME <> 'ANONYMOUS';
```

And then rotate the password for each account as follows:

```
ALTER USER user_name IDENTIFIED BY new_password;
```

After you have reset the password for each account, the version of the client determines the password version that is used. Because the 10G verifier is desupported, users having only this verifier cannot perform this password-change operation themselves, and an administrative user must reset their password and send the new password to the users using a secure, out-of-band form of communication, and then ask the user to change the password on their own. The administrative user can also choose to expire the password after resetting it, using the `PASSWORD EXPIRE` clause, in which case the user will be prompted to change their password when they log in. The setting of the `SQLNET.ALLOWED_LOGON_VERSION_SERVER` parameter determines the password versions that are generated. If the client has the O7L_MR ability (Oracle Database release 12c), then the 12C password version is used to authenticate. If the client has the O5L_NP ability but not the O7L_MR ability (such as Oracle Database release 11g clients), then the 11G password version is used to authenticate. You should upgrade all clients to Oracle Database release 12c so that the 12C password version can be used exclusively to authenticate. (By default, Oracle Database release 11.2.0.3 and later clients have the O5L_NP ability, which enables the 11G password version to be used exclusively. If you have an earlier Oracle Database client, then you must install the CPUOct2012 patch.)

When an account password is expired and the `ALLOWED_LOGON_VERSION_SERVER` parameter is set to 12 or 12a, then the 10G password version is removed and only one or both of the new password versions are created, depending on how the parameter is set, as follows:

- If `ALLOWED_LOGON_VERSION_SERVER` is set to 12 (the default), then both the 11G and 12C versions of the password hash are generated.
- If `ALLOWED_LOGON_VERSION_SERVER` is set to 12a, then only the 12C version of the password hash is generated.

For more details, see the "Generated Password Version" column in the table in the "Usage Notes" section for the `SQLNET.ALLOWED_LOGON_VERSION_SERVER` parameter in *Oracle Database Net Services Reference*.

- **Accounts with both 10G and 11G versions of the password hash:** For users who are using a Release 10g or later client, the user logins will succeed because the 11G version of the password hash is used. However, to use the latest version, expire these passwords, as described in the previous bulleted item for accounts.
- **Accounts with only the 11G version of the password hash:** The authentication uses the 11G version of the password hash. To use the latest version, expire the passwords, as described in the first bulleted item.

The Oracle Database 12c default configuration for `SQLNET.ALLOWED_LOGON_VERSION_SERVER` is 12, which means that it is compatible with Oracle Database 12c release 2 (12.2) authentication protocols and later products that use OCI-based drivers, including SQL*Plus, ODBC, Oracle .NET, Oracle Forms, and various third-party Oracle Database adapters. It is also compatible with JDBC type-4 (thin) versions that have had the CPUOct2012 bundle patch applied or starting with Oracle Database 11g, and Oracle Database Client interface (OCI)-

based drivers starting in Oracle Database 10g release 10.2. Be aware that earlier releases of the OCI client drivers cannot authenticate to an Oracle database using password-based authentication.

3.2.8.3 Configuring Oracle Database to Use the 12C Password Version Exclusively

You should set the `SQLNET.ALLOWED_LOGON_VERSION_SERVER` parameter to 12a so that only the 12C password hash version is used.

The 12C password version is the most restrictive and secure of the password hash versions, and for this reason, Oracle recommends that you use only this password version. By default, `SQLNET.ALLOWED_LOGON_VERSION_SERVER` is set to 12, which enables both the 11G and 12C password versions to be used. (Both the `SQLNET.ALLOWED_LOGON_VERSION_SERVER` values 12 and 12a are considered Exclusive Mode, which prevents the use of the earlier 10G password version, which is no longer supported as of Oracle Database 23ai.) If you have upgraded from a previous release, or if `SQLNET.ALLOWED_LOGON_VERSION_SERVER` is set to 12 or another setting that was used in previous releases, then you should reconfigure this parameter, because intruders will attempt to downgrade the authentication to use weaker password versions. [Table 3-3](#) shows the effect of the `SQLNET.ALLOWED_LOGON_VERSION_SERVER` setting on password version generation.

Be aware that you can use the 12C password version exclusively only if you use Oracle Database 12c release 12.1.0.2 or later clients. Before you change the `SQLNET.ALLOWED_LOGON_VERSION_SERVER` parameter to 12a, check the versions of the database clients that are connected to the server.

1. Log in to SQL*Plus as an administrative user who has the `ALTER USER` system privilege.
2. Perform the following SQL query to find the password versions of your users.

```
SELECT USERNAME, PASSWORD_VERSIONS FROM DBA_USERS;
```

3. Expire the account of each user who does not have the 12C password version.

For example, assuming user `blake` is still using a 10G password version:

```
ALTER USER blake PASSWORD EXPIRE;
```

The next time that these users log in, they will be forced to change their passwords, which enables the server to generate the password versions required for Exclusive Mode.

4. Remind users to log in within a reasonable period of time (such as 30 days).

When they log in, they will be prompted to change their password, ensuring that the password versions required for authentication in Exclusive Mode are generated by the server. (For more information about how Exclusive Mode works, see the usage notes for the `SQLNET.ALLOWED_LOGON_VERSION_SERVER` parameter in *Oracle Database Net Services Reference*.)

5. Manually change the passwords for accounts that are used in test scripts or batch jobs so that they exactly match the passwords used by these test scripts or batch jobs, including the password's case.
6. Enable the Exclusive Mode configuration as follows:
 - a. Create a back up copy of the `sqlnet.ora` parameter file.

By default, this file is located in the `$ORACLE_HOME/network/admin` directory on UNIX operating systems and the `%ORACLE_HOME%\network\admin` directory on Microsoft Windows operating systems.

The settings in the `sqlnet.ora` file apply to all PDBs.

- b. Set the `SQLNET.ALLOWED_LOGON_VERSION_SERVER` parameter, using [Table 3-3](#) for guidance.
- c. Save the `sqlnet.ora` file.

[Table 3-3](#) shows the effect of the `SQLNET.ALLOWED_LOGON_VERSION_SERVER` setting on password version generation.

Table 3-3 Effect of `SQLNET.ALLOWED_LOGON_VERSION_SERVER` on Password Version Generation

<code>SQLNET.ALLOWED_LOGON_VERSION_SERVER</code> Setting	8	11	12	12a
Server runs in Exclusive Mode?	No	No	Yes	Yes
Generate the 10G password version?	No	No	No	No
Generate the 11G password version?	Yes	Yes	Yes	No
Generate the 12C password version?	Yes	Yes	Yes	Yes

If you only use Oracle Database 12c release 12.1.0.2 or later clients, then set `SQLNET.ALLOWED_LOGON_VERSION_SERVER` to 12a.

The higher the setting, the more restrictive the use of password versions, as follows:

- A setting of 12a, the most restrictive and secure setting, only permits the 12C password version.
- A setting of 12 permits both the 11G and 12C password versions to be used for authentication.
- A setting of 8 permits the following password versions: 11G and 12C.

For detailed information about the `SQLNET.ALLOWED_LOGON_VERSION_SERVER` parameter, see *Oracle Database Net Services Reference*.



Note:

If your system hosts a fixed database link to a target database that runs an earlier release, then you can set the `SQLNET.ALLOWED_LOGON_VERSION_CLIENT` parameter, as described in [How Server and Client Logon Versions Affect Database Links](#).

3.2.8.4 How Server and Client Logon Versions Affect Database Links

The `SQLNET.ALLOWED_LOGON_VERSION_SERVER` and `SQLNET.ALLOWED_LOGON_VERSION_CLIENT` parameters can accommodate connections between databases and clients of different releases.

The following diagram illustrates how connections between databases and clients of different releases work. The `SQLNET.ALLOWED_LOGON_VERSION_CLIENT` parameter affects the "client allowed logon version" aspect of a server that hosts the database link **H**. This setting enables **H** to connect through database links to older servers, such as those running Oracle 9i (**T**), yet still refuse connections from older unpatched clients (**U**). When this happens, the Oracle Net Services protocol negotiation fails, which raises an `ORA-28040: No matching authentication protocol error` message in this client, which is attempting to authenticate using the Oracle 9i software. The Oracle Net Services protocol negotiation for Oracle Database 10g release 10.2

client **E** succeeds because this release incorporates the critical patch update CPUOct2012. The Oracle Net Services protocol negotiation for Release 11.2.0.3 client **C** succeeds because it uses a secure password version. (Many of the versions in this diagram are no longer supported. This diagram is for illustrative purposes only.)

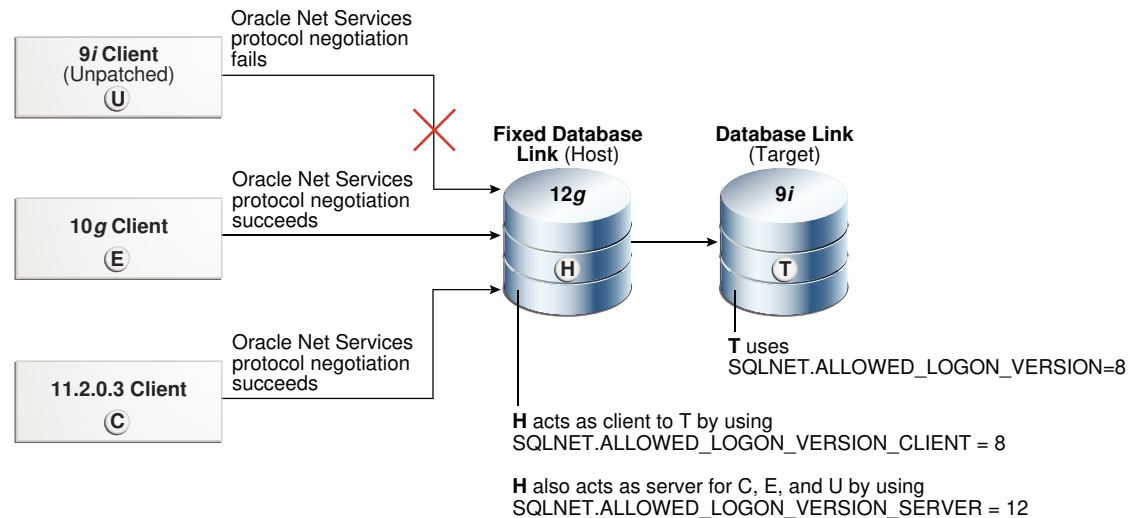

This scenario uses the following settings for the system that hosts the database link **H**:

```
SQLNET.ALLOWED_LOGON_VERSION_CLIENT=8
SQLNET.ALLOWED_LOGON_VERSION_SERVER=12
```

Note that the remote Oracle Database **T** has the following setting:

```
SQLNET.ALLOWED_LOGON_VERSION=8
```

If the release of the remote Oracle Database **T** does not meet or exceed the value defined by the `SQLNET.ALLOWED_LOGON_VERSION_CLIENT` parameter set for the host **H**, then queries over the fixed database link would fail during authentication of the database link user, resulting in an `ORA-28040: No matching authentication protocol error` when an end-user attempts to access a table over the database link.

 **Note:**

If you are using an older Oracle Database client (such as Oracle Database 11g release 11.1.0.7), then Oracle strongly recommends that you upgrade to use the critical patch update CPUOct2012.

 **See Also:**

- *Oracle Database Net Services Reference* for more information about the `SQLNET.ALLOWED_LOGON_VERSION_CLIENT` parameter
- <http://www.oracle.com/technetwork/topics/security/cpuoct2012-1515893.html> for more information about CPUOct2012

3.2.8.5 Configuring Oracle Database Clients to Use the 12C Password Version Exclusively

An intruder may try to provision a fake server to downgrade authentication and trick the client into using a weaker password hash version.

- To prevent the use of the 10G password version, or both the 10G (no longer supported as of Oracle Database 23ai) and 11G password versions, after you configure the server, configure the clients to run in Exclusive Mode, as follows:
 - To use the client Exclusive Mode setting to permit both the 11G and 12C password versions:

```
SQLNET.ALLOWED_LOGON_VERSION_CLIENT = 12
```
 - To use the more restrictive client Exclusive Mode setting to permit only the 12C password version (this setting permits the client to connect only to Oracle Database 12c release 1 (12.1.0.2) and later servers):

```
SQLNET.ALLOWED_LOGON_VERSION_CLIENT = 12a
```

If the server and the client are both installed on the same computer, then ensure that the `TNS_ADMIN` environment variable for each points to the correct directory for its respective Oracle Net Services configuration files. If the variable is the same for both, then the server could use the client's `SQLNET.ALLOWED_LOGON_VERSION_CLIENT` setting instead.

If you are using older Oracle Database clients (such as Oracle Database 11g release 11.1.0.7), then you should apply CPU Oct2012 or later to these clients. This patch provides the `O5L_NP` ability. Unless you apply this patch, users will be unable to log in.

 **See Also:**

- *Oracle Database Net Services Reference* for more information about the `SQLNET.ALLOWED_LOGON_VERSION_CLIENT` parameter
- The following Oracle Technology Network site for more information about CPUOct2012:
<http://www.oracle.com/technetwork/topics/security/cpuoct2012-1515893.html>

3.2.9 Managing the Secure External Password Store for Password Credentials

The secure external password store (SEPS) is a client-side wallet that is used to store password credentials.

- [About the Secure External Password Store](#)
You can store password credentials database connections by using a client-side Oracle wallet.
- [How Does the Secure External Password Store Work?](#)
Users (and applications, batch jobs, and scripts) connect to databases by using a standard `CONNECT` statement that specifies a database connection string.
- [About Configuring Clients to Use the Secure External Password Store](#)
If your client is configured to use external authentication, such as Windows native authentication or SSL, then Oracle Database uses that authentication method.
- [Configuring a Client to Use the Secure External Password Store](#)
You can configure a client to use the secure external password store feature by using the `mkstore` command-line utility.
- [Example: Sample `sqlnet.ora` File with Wallet Parameters Set](#)
You can set special parameters in the `sqlnet.ora` file to control how wallets are managed.
- [Managing External Password Store Credentials](#)
The `mkstore` command-line utility manages credentials from an external password store. (Starting in Oracle Database 23ai, `mkstore` is deprecated in favor of `orapki`.)
- [Creating SQL*Loader Object Store Credentials](#)
Before SQL*Loader can read data from files from object stores, you must create credentials that can be used to access the object store.

3.2.9.1 About the Secure External Password Store

You can store password credentials database connections by using a client-side Oracle wallet.

An Oracle wallet is a secure software container that stores authentication and signing credentials. This wallet usage can simplify large-scale deployments that rely on password credentials for connecting to databases. When this feature is configured, application code, scripts no longer need embedded user names and passwords. This reduces risk because the passwords are no longer exposed, and password management policies are more easily enforced without changing application code whenever user names or passwords change.

 **Note:**

The external password store of the wallet is separate from the area where public key infrastructure (PKI) credentials are stored. Use the command-line utility `mkstore` (deprecated) to manage these credentials.

Related Topics

- [Using Proxy Authentication with the Secure External Password Store](#)
Use a secure external password store if you are concerned about the password used in proxy authentication being obtained by a malicious user.

3.2.9.2 How Does the Secure External Password Store Work?

Users (and applications, batch jobs, and scripts) connect to databases by using a standard `CONNECT` statement that specifies a database connection string.

This string can include a user name and password, and an Oracle Net service name identifying the database on an Oracle Database network. If the password is omitted, the connection prompts the user for the password.

For example, the service name could be the URL that identifies that database, or a TNS alias you entered in the `tnsnames.ora` file in the database. Another possibility is a `host:port:sid` string.

The following examples are standard `CONNECT` statements that could be used for a client that is not configured to use the external password store:

```
CONNECT salesapp@sales_db.us.example.com
Enter password: password
```

```
CONNECT salesapp@orasales
Enter password: password
```

```
CONNECT salesapp@ourhost37:1527:DB17
Enter password: password
```

In these examples, `salesapp` is the user name, with the unique connection string for the database shown as specified in three different ways. You could use its URL `sales_db.us.example.com`, or its TNS alias `orasales` from the `tnsnames.ora` file, or its `host:port:sid` string.

However, when clients are configured to use the secure external password store, applications can connect to a database with the following `CONNECT` statement syntax, without specifying database login credentials:

```
CONNECT /@db_connect_string
```

```
CONNECT /@db_connect_string AS SYSDBA
```

```
CONNECT /@db_connect_string AS SYSOPER
```

In this specification, `db_connect_string` is a valid connection string to access the intended database, such as the service name, URL, or alias as shown in the earlier examples. Each user account must have its own unique connection string; you cannot create one connection string for multiple users.

In this case, the database credentials, user name and password, are securely stored in an Oracle wallet created for this purpose. The autologin feature of this wallet is turned on, so the system does not need a password to open the wallet. From the wallet, it gets the credentials to access the database for the user they represent.

Related Topics

- [Oracle Database Enterprise User Security Administrator's Guide](#)

3.2.9.3 About Configuring Clients to Use the Secure External Password Store

If your client is configured to use external authentication, such as Windows native authentication or SSL, then Oracle Database uses that authentication method.

The same credentials used for this type of authentication are typically also used to log in to the database. For clients not using such authentication methods or wanting to override them for database authentication, in the `sqlnet.ora` file you can either set the `SEPS_WALLET_LOCATION` parameter to the location of the wallet file or specify the location of the wallet file with the `WALLET_LOCATION` parameter and set the `SQLNET.WALLET_OVERRIDE` parameter to `TRUE`. The default value for `SQLNET.WALLET_OVERRIDE` is `FALSE`, allowing standard use of authentication credentials as before.

3.2.9.4 Configuring a Client to Use the Secure External Password Store

You can configure a client to use the secure external password store feature by using the `mkstore` command-line utility.

Starting in Oracle Database release 23ai, `mkstore` is deprecated. If possible, use `orapki` instead.

1. Create a wallet on the client by using the following syntax at the command line:

```
mkstore -wrl wallet_location -create
```

For example:

```
mkstore -wrl c:\oracle\product\20.1.0\db_1\wallets -create
Enter password: password
```

wallet_location is the path to the directory where you want to create and store the wallet. This command creates an Oracle wallet with the autologin feature enabled at the location you specify. The autologin feature enables the client to access the wallet contents without supplying a password. If the connection is configured to use the TCPS protocol and the TLS certificate is stored in the wallet, then the database credential should be stored in the same wallet.

The `mkstore` utility `-create` option uses password complexity verification. See [About Password Complexity Verification](#) for more information.

2. Create database connection credentials in the wallet by using the following syntax at the command line:

```
mkstore -wrl wallet_location -createCredential db_connect_string username
Enter password: password
```

For example:

```
mkstore -wrl c:\oracle\product\20.1.0\db_1\wallets -createCredential orcl system
Enter password: password
```

In this specification:

- *wallet_location* is the path to the directory where you created the wallet earlier in this procedure.
- *db_connect_string* is the TNS alias you use to specify the database in the `tnsnames.ora` file or any service name you use to identify the database on an Oracle network. By default, `tnsnames.ora` is located in the `$ORACLE_HOME/network/admin` directory on UNIX systems and in `ORACLE_HOME\network\admin` on Windows.

- `username` is the database login credential. When prompted, enter the password for this user.

Repeat this step for each database you want accessible using the `CONNECT /@db_connect_string` syntax. The `db_connect_string` used in the `CONNECT /@db_connect_string` statement must be identical to the `db_connect_string` specified in the `-createCredential` command.

3. Set the directory location of the wallet you created in Step 1 by setting the

-
- `WALLET_LOCATION` and `SQLNET.WALLET_OVERRIDE` parameters
 - `SEPS_WALLET_LOCATION` parameter

WALLET_LOCATION and SQLNET.WALLET_OVERRIDE parameters

- a. In the client `sqlnet.ora` file, enter the `WALLET_LOCATION` parameter and set it to the directory location of the wallet you created in Step 1. For example, if you created the wallet in `$ORACLE_HOME/network/admin` and your Oracle home is set to `/private/ora_db`, then you need to enter the following into your client `sqlnet.ora` file:

```
WALLET_LOCATION =
  (SOURCE =
    (METHOD = FILE)
    (METHOD_DATA =
      (DIRECTORY = /private/ora_db/network/admin)
    )
  )
```

- b. In the client `sqlnet.ora` file, enter the `SQLNET.WALLET_OVERRIDE` parameter and set it to `TRUE` as follows:

```
SQLNET.WALLET_OVERRIDE = TRUE
```

This setting causes all `CONNECT /@db_connect_string` statements to use the information in the wallet at the specified location to authenticate to databases.

When external authentication is in use, an authenticated user with such a wallet can use the `CONNECT /@db_connect_string` syntax to access the previously specified databases without providing a user name and password. However, if a user fails that external authentication, then these connect statements also fail.

SEPS_WALLET_LOCATION parameter

In the client `sqlnet.ora` file, enter the `SEPS_WALLET_LOCATION` parameter and set it to the directory location of the wallet you created in Step 1.

For example, if you created the wallet in `$ORACLE_HOME/network/admin` and your Oracle home is set to `/private/ora_db`, then you need to enter the following into your client `sqlnet.ora` file:

```
SEPS_WALLET_LOCATION = /private/ora_db/network/admin
```

This setting causes all `CONNECT /@db_connect_string` statements to use the information in the wallet at the specified location to authenticate to databases.

When external authentication is in use, an authenticated user with such a wallet can use the `CONNECT /@db_connect_string` syntax to access the previously specified databases without providing a user name and password. However, if a user fails that external authentication, then these connect statements also fail.

 **Note:**

If the `SEPS_WALLET_LOCATION` parameter is set, the `SQLNET.WALLET_OVERRIDE` parameter is ignored.

Related Topics

- [About Password Complexity Verification](#)
Complexity verification checks that each password is complex enough to protect against intruders who try to guess user passwords.

3.2.9.5 Example: Sample sqlnet.ora File with Wallet Parameters Set

You can set special parameters in the `sqlnet.ora` file to control how wallets are managed.

[Example 3-2](#) shows a sample `sqlnet.ora` file with the `WALLET_LOCATION` and the `SQLNET.WALLET_OVERRIDE` parameters.

[Example 3-3](#) shows a sample `sqlnet.ora` file with the `SEPS_WALLET_LOCATION` parameter.

Example 3-2 Sample sqlnet.ora File with the WALLET_LOCATION and SQLNET.WALLET_OVERRIDE Parameters Set

```
WALLET_LOCATION =
  (SOURCE =
    (METHOD = FILE)
    (METHOD_DATA =
      (DIRECTORY = /private/ora_db/network/admin)
    )
  )
SQLNET.WALLET_OVERRIDE = TRUE
SSL_CLIENT_AUTHENTICATION = FALSE
SSL_VERSION = TLSv1.3
```

Example 3-3 Sample sqlnet.ora File with thesePS_WALLET_LOCATION Parameter Set

```
SEPS_WALLET_LOCATION = /private/ora_db/network/admin
SSL_CLIENT_AUTHENTICATION = FALSE
SSL_VERSION = TLSv1.3
```

3.2.9.6 Managing External Password Store Credentials

The `mkstore` command-line utility manages credentials from an external password store. (Starting in Oracle Database 23ai, `mkstore` is deprecated in favor of `orapki`.)

- [Listing External Password Store Contents](#)
You can view the contents, including specific credentials, of a client wallet external password store.
- [Adding Credentials to an External Password Store](#)
You can store multiple credentials in one client wallet.
- [Modifying Credentials in an External Password Store](#)
You can modify the database login credentials that are stored in the wallet if the database connection strings change.
- [Deleting Credentials from an External Password Store](#)
You can delete login credentials for a database from a wallet if the database no longer exists or to disable connections to a specific database.

3.2.9.6.1 Listing External Password Store Contents

You can view the contents, including specific credentials, of a client wallet external password store.

Listing the external password store contents provides information you can use to decide whether to add or delete credentials from the store.

- To list the contents of the external password store, enter the following command at the command line:

```
mkstore -wrl wallet_location -listCredential
```

For example:

```
mkstore -wrl c:\oracle\product\20.1.0\db_1\wallets -listCredential
```

wallet_location specifies the path to the directory where the wallet, whose external password store contents you want to view, is located. This command lists all of the credential database service names (aliases) and the corresponding user name (schema) for that database. Passwords are not listed.

3.2.9.6.2 Adding Credentials to an External Password Store

You can store multiple credentials in one client wallet.

For example, if a client batch job connects to *hr_database* and a script connects to *sales_database*, then you can store the login credentials in the same client wallet. You cannot, however, store multiple credentials (for logging in to multiple schemas) for the same database in the same wallet. If you have multiple login credentials for the same database, then they must be stored in separate wallets.

- To add database login credentials to an existing client wallet, enter the following command at the command line:

```
mkstore -wrl wallet_location -createCredential db_alias username
```

For example:

```
mkstore -wrl c:\oracle\product\20.1.0\db_1\wallets -createCredential orcl system  
Enter password: password
```

In this specification:

- *wallet_location* is the path to the directory where the client wallet to which you want to add credentials is stored.

- *db_alias* can be the TNS alias you use to specify the database in the `tnsnames.ora` file or any service name you use to identify the database on an Oracle network.
- *username* is the database login credential for the schema to which your application connects. When prompted, enter the password for this user.

3.2.9.6.3 Modifying Credentials in an External Password Store

You can modify the database login credentials that are stored in the wallet if the database connection strings change.

- To modify database login credentials in a wallet, enter the following command at the command line:

```
mkstore -wrl wallet_location -modifyCredential db_alias username
```

For example:

```
mkstore -wrl c:\oracle\product\20.1.0\db_1\wallets -modifyCredential sales_db  
Enter password: password
```

In this specification:

- *wallet_location* is the path to the directory where the wallet is located.
- *db_alias* is a new or different alias you want to use to identify the database. It can be a TNS alias you use to specify the database in the `tnsnames.ora` file or any service name you use to identify the database on an Oracle network.
- *username* is the new or different database login credential. When prompted, enter the password for this user.

3.2.9.6.4 Deleting Credentials from an External Password Store

You can delete login credentials for a database from a wallet if the database no longer exists or to disable connections to a specific database.

- To delete database login credentials from a wallet, enter the following command at the command line:

```
mkstore -wrl wallet_location -deleteCredential db_alias
```

For example:

```
mkstore -wrl c:\oracle\product\20.1.0\db_1\wallets -deleteCredential orcl
```

In this specification:

- *wallet_location* is the path to the directory where the wallet is located.
- *db_alias* is the TNS alias you use to specify the database in the `tnsnames.ora` file, or any service name you use to identify the database on an Oracle Database network.

3.2.9.7 Creating SQL*Loader Object Store Credentials

Before SQL*Loader can read data from files from object stores, you must create credentials that can be used to access the object store.

To create the credentials, you use the `mkstore` and `orapki` utilities.

1. Log in to the client database that uses the SQL*Loader object store.
2. Run the `mkstore` command to create the user name.

For example, assuming that the wallet location is in the `$ORACLE_HOME/wallet` directory:

```
mkstore -wrl $ORACLE_HOME/wallet -createEntry  
oracle.sqlldr.credential.obm_psmith.username PSMITH
```

3. Run the `mkstore` command to create the user password.

For example:

```
mkstore -wrl $ORACLE_HOME/wallet -createEntry  
oracle.sqlldr.credential.obm_psmith.password psmith_password
```

4. If necessary, run the `orapki` command to create a certificate for the object store in the wallet.

For example, assuming that you want to create the certificate in `$ORACLE_HOME/wallet`:

```
orapki cert create -wallet $ORACLE_HOME/wallet -request certificate_request_location  
-cert certificate_location -validity 5
```

5. Run the `orapki` command to add the certificate for the object store to the wallet.

For example, assuming that you want to add the certificate to `$ORACLE_HOME/wallet/ewallet.p12`:

```
orapki wallet add -wallet $ORACLE_HOME/wallet/ewallet.p12 -trusted_cert -cert  
trusted_certificate_file_name -pwd wallet_password
```

After you have created this credential the certificate for the object store, then users can begin to load data using `SQL*Loader`.

3.2.10 Managing Passwords for Administrative Users

The passwords of administrative users have special protections, such as password files and password complexity functions.

- [About Managing Passwords for Administrative Users](#)
The passwords of administrative users are stored outside of the database so that the users can be authenticated even when the database is not open.
- [Setting the LOCK and EXPIRED Status of Administrative Users](#)
Administrative users whose accounts have been locked cannot connect to the database.
- [Password Profile Settings for Administrative Users](#)
There are several user profile password settings that are enforced for administrative users.
- [Last Successful Login Time for Administrative Users](#)
The last successful login time of administrative user connections that use password file-based authentication is captured.
- [Management of the Password File of Administrative Users](#)
Setting the `ORAPWD` utility `FORMAT` parameter to `12.2` enables you to manage the password profile parameters for administrative users.
- [Migration of the Password File of Administrative Users](#)
The `ORAPWD` utility `input_file` parameter can be used to migrate from earlier password file formats to the `12` or `12.2` format.
- [How the Multitenant Option Affects Password Files for Administrative Users](#)
The password information for the local and common administrative users is stored in different locations.
- [Password Complexity Verification Functions for Administrative Users](#)
For better security, use password complexity verification functions for the passwords of administrative users.

3.2.10.1 About Managing Passwords for Administrative Users

The passwords of administrative users are stored outside of the database so that the users can be authenticated even when the database is not open.

There is no special protection with the password file. The verifiers must be stored outside of the database so that authentication can be performed even when the database is not open. In previous releases, password complexity functions were available for non-administrative users only. Starting with Oracle Database release 12c (12.2), password complexity functions can be used for both non-administrative users and administrative users.

3.2.10.2 Setting the LOCK and EXPIRED Status of Administrative Users

Administrative users whose accounts have been locked cannot connect to the database.

- To unlock locked or expired administrative accounts, use the `ALTER USER` statement.

For example:

```
ALTER USER hr_admin ACCOUNT UNLOCK;
```

If the administrative user's password has expired, then the next time the user attempts to log in, the user will be prompted to create a new password.

3.2.10.3 Password Profile Settings for Administrative Users

There are several user profile password settings that are enforced for administrative users.

These password profile parameters are as follows:

- `FAILED_LOGIN_ATTEMPT`
- `INACTIVE_ACCOUNT_TIME`
- `PASSWORD_LOCK_TIME`
- `PASSWORD_LIFE_TIME`
- `PASSWORD_GRACE_TIME`

Related Topics

- [Managing Resources with Profiles](#)
A profile is a named set of resource limits and password parameters that restrict database usage and instance resources for a user.

3.2.10.4 Last Successful Login Time for Administrative Users

The last successful login time of administrative user connections that use password file-based authentication is captured.

To find this login time, query the `LAST_LOGIN` column of the `V$PWFILE_USERS` dynamic performance view.

3.2.10.5 Management of the Password File of Administrative Users

Setting the `ORAPWD` utility `FORMAT` parameter to `12.2` enables you to manage the password profile parameters for administrative users.

The password file is particularly important for administrative users because it stores the administrative user's credentials in an external file, not in the database itself. This enables the administrative user to log in to a database that is not open and perform tasks such as querying the data dictionary views. To create the password file, you must use the `ORAPWD` utility.

The `FORMAT` parameter setting of 12.2, which is the default setting, enables the password file to accommodate the password profile information for the administrative user.

For example:

```
orapwd file=orapworcl input_file=orapwold format=12.2  
...
```

Setting `FORMAT` to 12.2 enforces the following rules:

- The password contains no fewer than 8 characters and includes at least one numeric and one alphabetic character.
- The password does not contain the user name or the user name reversed.
- The password does not contain the word `oracle` (such as `oracle123`).
- The password contains at least 1 special character.

`FORMAT=12.2` also applies the following internal checks:

- The password does not exceed 1024 bytes.
- The password does not contain the double-quotation character (`"`). However, it can be surrounded by double-quotation marks.

The following user profile password settings are enforced for administrative users:

- `FAILED_LOGIN_ATTEMPT`
- `INACTIVE_ACCOUNT_TIME`
- `PASSWORD_GRACE_TIME`
- `PASSWORD_LIFE_TIME`
- `PASSWORD_LOCK_TIME`

You can find the administrative users who have been included in the password file and their administrative privileges by querying the `V$PWFILE_USERS` dynamic view.

3.2.10.6 Migration of the Password File of Administrative Users

The `ORAPWD` utility `input_file` parameter can be used to migrate from earlier password file formats to the 12 or 12.2 format.

You can migrate from earlier password file formats to the 12 or 12.2 format by using either the `ORAPWD` utility `file` or `input_file` parameters. To do so, set the `FILE` parameter to a name for the new password file and the `input_file` parameter to the name of the earlier password file.

For example:

```
orapwd file=orapworcl input_file=orapwold format=12.2
```

Related Topics

- *Oracle Database Administrator's Guide*

3.2.10.7 How the Multitenant Option Affects Password Files for Administrative Users

The password information for the local and common administrative users is stored in different locations.

- **For CDB common administrative users:** The password information (hashes of the password) for the CDB common administrative users to whom administrative privileges were granted in the CDB root is stored in the password file.
- **For all users in a CDB to whom administrative privileges were granted outside the CDB root:** To view information about the password hash information of these users, query the `$PFILE_USERS` dynamic view.

3.2.10.8 Password Complexity Verification Functions for Administrative Users

For better security, use password complexity verification functions for the passwords of administrative users.

Note the following:

- **Profiles:** You can specify a password complexity verification function for the `SYS` user by using the `PASSWORD_VERIFY_FUNCTION` clause of the `CREATE PROFILE` or `ALTER PROFILE` statement. Oracle recommends that you use password verification functions to better protect the passwords of administrative users.
- **ORAPWD password files:** If you created a password file using the `ORAPWD` utility, then Oracle Database enforces password complexity checking for the `SYS` user and for administrative users who have logged in using the `SYSDBA`, `SYSBACKUP`, `SYSDBG`, and `SYSKM` administrative privileges.

The password checks for the following requirements:

- The password contains no fewer than 8 characters and includes at least one numeric character, one alphabetic character, and one special character.
- The password is not the same as the user name or the user name reversed.
- The password does not contain the word `oracle` (such as `oracle123`).
- The password differs from the previous password by at least three characters.

The following internal checks are also applied:

- The password does not exceed 1024 bytes.
- The password does not contain the double-quotation character (`"`). However, it can be surrounded by double-quotation marks.

Related Topics

- [Managing the Complexity of Passwords](#)
Oracle Database provides a set of functions that you can use to manage the complexity of passwords.

3.3 Authentication of Database Administrators

You can authenticate database administrators by using strong authentication, from the operating system, or from the database using passwords.

- [About Authentication of Database Administrators](#)
Database administrators perform special administrative operations, such as shutting down or starting databases.
- [Strong Authentication, Centralized Management for Administrators](#)
Strong authentication methods for centrally managed databases include directory authentication, Kerberos authentication, and SSL authentication.
- [Authentication of Database Administrators by Using the Operating System](#)
For both Windows and UNIX systems, you use DBA-privileged groups to authenticate for the operating system.
- [Authentication of Database Administrators by Using Their Passwords](#)
Password files are used to authenticate database administrators.
- [Risks of Using Password Files for Database Administrator Authentication](#)
Be aware that using password files may pose security risks.

3.3.1 About Authentication of Database Administrators

Database administrators perform special administrative operations, such as shutting down or starting databases.

Oracle Database provides methods to secure the authentication of database administrators who have the `SYSDBA`, `SYSOPER`, `SYSBACKUP`, `SYSDG`, or `SYSKM` administrative privilege.

3.3.2 Strong Authentication, Centralized Management for Administrators

Strong authentication methods for centrally managed databases include directory authentication, Kerberos authentication, and SSL authentication.

- [About Strong Authentication for Database Administrators](#)
Strong authentication lets you centrally control `SYSDBA` and `SYSOPER` access to multiple databases.
- [Configuring Directory Authentication for Administrative Users](#)
Oracle Internet Directory configures directory authentication for administrative users.
- [Configuring Kerberos Authentication for Administrative Users](#)
Oracle Internet Directory can be used to configure Kerberos authentication for administrative users.

3.3.2.1 About Strong Authentication for Database Administrators

Strong authentication lets you centrally control `SYSDBA` and `SYSOPER` access to multiple databases.

Consider using this type of authentication for database administration for the following situations:

- You have concerns about password file vulnerability.
- Your site has very strict security requirements.
- You want to separate the identity management from your database. By using a directory server such as Oracle Internet Directory (OID), for example, you can maintain, secure, and administer that server separately.

To enable the Oracle Internet Directory server to authorize `SYSDBA` and `SYSOPER` connections, use one of the following methods described in this section, depending on your environment.

Related Topics

- [Configuring User Authentication with Transport Layer Security](#)
Both the client and server side can authenticate administrative users with Transport Layer Security (TLS).

3.3.2.2 Configuring Directory Authentication for Administrative Users

Oracle Internet Directory configures directory authentication for administrative users.

1. Configure the administrative user by using the same procedures you would use to configure a typical user.
2. In Oracle Internet Directory, grant the `SYSDBA` or `SYSOPER` administrative privilege to the user for the database that this user will administer.

Grant `SYSDBA` or `SYSOPER` only to trusted users.

3. Set the `LDAP_DIRECTORY_SYSAUTH` initialization parameter to `YES`:

```
ALTER SYSTEM SET LDAP_DIRECTORY_SYSAUTH = YES;
```

When set to `YES`, the `LDAP_DIRECTORY_SYSAUTH` parameter enables `SYSDBA` and `SYSOPER` users to authenticate to the database by using a strong authentication method.

4. Set the `LDAP_DIRECTORY_ACCESS` parameter to either `PASSWORD` or `SSL`. For example:

```
ALTER SYSTEM SET LDAP_DIRECTORY_ACCESS = PASSWORD;
```

Ensure that the `LDAP_DIRECTORY_ACCESS` initialization parameter is not set to `NONE`. Setting this parameter to `PASSWORD` or `SSL` ensures that users can be authenticated using the `SYSDBA` or `SYSOPER` administrative privileges through Oracle Internet Directory.

In an Oracle Real Application Clusters (Oracle RAC) environment, ensure that all instances have the same `LDAP_DIRECTORY_ACCESS` setting, either through the `ALTER SYSTEM` statement or through the `init.ora` file.

In an Oracle Data Guard or Active Data Guard environment, ensure that the standby database has the same `LDAP_DIRECTORY_ACCESS` setting as the primary database. In this environment, the `ALTER SYSTEM` statement propagates its settings from the primary database to the standby database. If you choose to update the `init.ora` file, remember that the `init.ora` parameters are used by both the primary database and the standby database, so you do not need to manually propagate this setting from one database to the other.

Afterward, this user can log in by including the net service name in the `CONNECT` statement in SQL*Plus. For example, to log on as `SYSDBA` if the net service name is `orcl`:

```
CONNECT someuser@orcl AS SYSDBA  
Enter password: password
```

If the database is configured to use a password file for remote authentication, Oracle Database checks the password file first.

Related Topics

- [Guidelines for Securing User Accounts and Privileges](#)
Oracle provides guidelines to secure user accounts and privileges.
- *Oracle Database Reference*
- *Oracle Database Reference*

3.3.2.3 Configuring Kerberos Authentication for Administrative Users

Oracle Internet Directory can be used to configure Kerberos authentication for administrative users.

1. Configure the administrative user by using the same procedures you would use to configure a typical user.
2. Configure Oracle Internet Directory for Kerberos authentication.

Oracle Database Enterprise User Security includes this functionality.

 **Note:**

Enterprise User Security (EUS) is deprecated with Oracle Database 23ai. Oracle recommends that you migrate to using Centrally Managed Users (CMU). This feature enables you to directly connect with Microsoft Active Directory without an intervening directory service for enterprise user authentication and authorization to the database. If your Oracle Database is in the cloud, you can also choose to move to one of the newer integrations with a cloud identity provider.

3. In Oracle Internet Directory, grant the `SYSDBA` or `SYSOPER` administrative privilege to the user for the database that this user will administer.

Grant `SYSDBA` or `SYSOPER` only to trusted users.

4. Set the `LDAP_DIRECTORY_SYSAUTH` initialization parameter to `YES`:

```
ALTER SYSTEM SET LDAP_DIRECTORY_SYSAUTH = YES;
```

When set to `YES`, the `LDAP_DIRECTORY_SYSAUTH` parameter enables `SYSDBA` and `SYSOPER` users to authenticate to the database by using strong authentication methods.

5. Set the `LDAP_DIRECTORY_ACCESS` parameter to either `PASSWORD` or `SSL`. For example:

```
ALTER SYSTEM SET LDAP_DIRECTORY_ACCESS = SSL;
```

Ensure that the `LDAP_DIRECTORY_ACCESS` initialization parameter is not set to `NONE`. Setting this parameter to `PASSWORD` or `SSL` ensures that users can be authenticated using `SYSDBA` or `SYSOPER` through Oracle Internet Directory.

In an Oracle Real Application Clusters (Oracle RAC) environment, ensure that all instances have the same `LDAP_DIRECTORY_ACCESS` setting, either through the `ALTER SYSTEM` statement or through the `init.ora` file.

In an Oracle Data Guard or Active Data Guard environment, ensure that the standby database has the same `LDAP_DIRECTORY_ACCESS` setting as the primary database. In this environment, the `ALTER SYSTEM` statement propagates its settings from the primary database to the standby database. If you choose to update the `init.ora` file, remember that the `init.ora` parameters are used by both the primary database and the standby database, so you do not need to manually propagate this setting from one database to the other.

Afterward, this user can log in by including the net service name in the `CONNECT` statement in SQL*Plus. For example, to log on as `SYSDBA` if the net service name is `orcl`:

```
CONNECT /@orcl AS SYSDBA
```

Related Topics

- [Configuring Kerberos Authentication](#)
Kerberos is a trusted third-party authentication system that relies on shared secrets and presumes that the third party is secure.
- Using *Oracle Database Enterprise User Security Administrator's Guide*

3.3.3 Authentication of Database Administrators by Using the Operating System

For both Windows and UNIX systems, you use DBA-privileged groups to authenticate for the operating system.

Operating system authentication for a database administrator typically involves establishing a group on the operating system, granting DBA privileges to that group, and then adding the names of persons who should have those privileges to that group. (On UNIX systems, the group is the **dba** group.)

You can use operating system authentication for a database administrator only for the CDB root. You cannot use it for PDBs, the application root, or application PDBs.

On Microsoft Windows systems:

- Users who connect with the SYSDBA administrative privilege can take advantage of the Windows native authentication. If these users work with Oracle Database using their domain accounts, then you must explicitly grant them local administrative privileges and ORA_DBA membership.
- Oracle recommends that you run Oracle Database services using a low privileged Microsoft Windows user account rather than a Microsoft Windows built-in account.

See Also:

Your Oracle Database operating system-specific documentation for information about configuring operating system authentication of database administrators

3.3.4 Authentication of Database Administrators by Using Their Passwords

Password files are used to authenticate database administrators.

That is, Oracle Database users who have been granted the SYSDBA, SYSOPER, SYSASM, SYSBACKUP, SYSDG, and SYSKM administrative privileges are first authenticated using database-specific password files.

These privileges enable the following activities:

- The SYSOPER system privilege lets database administrators perform STARTUP, SHUTDOWN, ALTER DATABASE OPEN/MOUNT, ALTER DATABASE BACKUP, ARCHIVE LOG, and RECOVER operations. SYSOPER also includes the RESTRICTED SESSION privilege.
- The SYSDBA administrative privilege has all system privileges with ADMIN OPTION, including the SYSOPER administrative privilege, and permits CREATE DATABASE and time-based recovery.

- A password file containing users who have the `SYSDBA`, `SYSOPER`, `SYSASM`, `SYSBACKUP`, `SYSDG`, and `SYSKM` administrative privileges can be shared between different databases. In addition, this type of password file authentication can be used in a Transport Layer Security (TLS) or Kerberos configuration, and for common administrative users. You can have a shared password file that contains users in addition to the `SYS` user. To share a password file among different databases, set the `REMOTE_LOGIN_PASSWORDFILE` parameter in the `init.ora` file to `SHARED`.

If you set the `REMOTE_LOGIN_PASSWORDFILE` initialization parameter to `EXCLUSIVE` or `SHARED` from `NONE`, then ensure that the password file is synchronized with the dictionary passwords.

- For Automatic Storage Management (ASM) environments, you can create shared ASM password files. Remember that you must have the `SYSASM` system privilege to create an ASM password file.
- The `SYSDG` administrative privilege must be included in a password file for sharding administrators to perform tasks that involve file transfer and Oracle Recovery Manager (RMAN) activities.
- Password file-based authentication is enabled by default. This means that the database is ready to use a password file for authenticating users that have `SYSDBA`, `SYSOPER`, `SYSASM`, `SYSBACKUP`, `SYSDG`, and `SYSKM` administrative privileges. Password file-based authentication is activated as soon as you create a password file by using the `ORAPWD` utility.

Anyone who has `EXECUTE` privileges and write privileges to the `$ORACLE_HOME/dbs` directory can run the `ORAPWD` utility.

- Password limits such as `FAILED_LOGIN_ATTEMPTS` and `PASSWORD_LIFE_TIME` are enforced for administrative logins, if the password file is created in the Oracle Database 12c release 2 (12.2) format.

 **Note:**

- To find a list of users who are included in the password file, you can query the `V$PWFFILE_USERS` data dictionary view.
- Connections requested `AS SYSDBA` or `AS SYSOPER` must use these phrases. Without them, the connection fails.

3.3.5 Risks of Using Password Files for Database Administrator Authentication

Be aware that using password files may pose security risks.

For this reason, consider using the strong authentication methods.

Examples of password security risks are as follows:

- An intruder could steal or attack the password file.
- Many users do not change the default password.
- The password could be easily guessed.
- The password is vulnerable if it can be found in a dictionary.

- Passwords that are too short, chosen perhaps for ease of typing, are vulnerable if an intruder obtains the cryptographic hash of the password.

Related Topics

- [Strong Authentication, Centralized Management for Administrators](#)
Strong authentication methods for centrally managed databases include directory authentication, Kerberos authentication, and SSL authentication.

3.4 Database Authentication of Users

Database authentication of users entails using information within the database itself to perform the authentication.

- [About Database Authentication of Users](#)
Oracle Database can authenticate users attempting to connect to a database by using information stored in that database itself.
- [Advantages of Database Authentication](#)
There are three advantages of using the database to authenticate users.
- [Creating Users Who Are Authenticated by the Database](#)
When you create a user who is authenticated by the database, you assign this user a password.

3.4.1 About Database Authentication of Users

Oracle Database can authenticate users attempting to connect to a database by using information stored in that database itself.

To configure Oracle Database to use database authentication, you must create each user with an associated password. If you want the user's password to use National Language Support (NLS), then you must configure the database to run with an NLS character set. Otherwise, the user would not be able to log in properly. Both user names and passwords can use the NLS character format, and follow the same syntax rules as identifiers in the database. Remember that double quotation mark characters can only be used as the delimiters of an identifier, so Oracle Database passwords cannot contain double quotation mark characters. The user must provide this user name and password when attempting to establish a connection.

Oracle Database generates a one-way hash of the user's password and stores it for use when verifying the provided login password. In order to support older clients, Oracle Database can be configured to generate the one-way hash of the user's password using a variety of different hashing algorithms. The resulting password hashes are known as password versions, which have the short names 10G (no longer supported as of Oracle Database 23ai), 11G, and 12C. The short names 10G, 11G, and 12C serve as abbreviations for the details of the one-way password hashing algorithms, which are described in more detail in the documentation for the `PASSWORD_VERSIONS` column of the `DBA_USERS` view. To find the list of password versions for any given user, query the `PASSWORD_VERSIONS` column of the `DBA_USERS` view.

 **Note:**

Starting with Oracle Database 23ai, the SHA-1 verifier introduced with Oracle Database 11g is deprecated.

The salted multi-round SHA-512 password hash (also known as "verifier") introduced with Oracle Database 12c provides enhanced security for your password. If 11g verifiers (11G) are still being used in your database, then Oracle recommends resetting them so they can be upgraded to the 12c (12C) de-optimized PBKDF2-based verifier.

By default, there are currently two versions of the one-way hashing algorithm in use in Oracle Database: the salted SHA-1 hashing algorithm, and the salted PBKDF2 SHA-2 SHA-512 hashing algorithm. The salted SHA-1 hashing algorithm generates the hash that is used for the 11G password version. The salted PBKDF2 SHA-2 SHA-512 hashing algorithm generates the hash that is used for the 12C password version. This hash generation takes place for the same password; that is, both algorithms run for the same password. Oracle Database records these password versions in the `DBA_USERS` data dictionary view. When you query this view, you will see two password versions. For example:

```
SELECT USERNAME, PASSWORD_VERSIONS FROM DBA_USERS;
```

```
USERNAME  PASSWORD_VERSIONS
-----  -
ADAMS     11G, 12C
SYS       11G, 12C
...
```

To specify the authentication protocol to allow during authentication of a client or of a database server acting as a client, you can explicitly set the following parameters in the server's `sqlnet.ora` file:

- The `SQLNET.ALLOWED_LOGON_VERSION_SERVER` parameter sets the minimum authentication protocol that is permitted when connecting to Oracle Database instances.
- The `SQLNET.ALLOWED_LOGON_VERSION_CLIENT` parameter configures the authentication protocol that is used when the server is "acting as a client" (for example, when the server is authenticating a database link). Setting `SQLNET.ALLOWED_LOGON_VERSION_CLIENT` in the server `sqlnet.ora` file enables its client configuration to be changed independently of its server configuration, that is, without affecting the authentication protocol used when the server is "acting as a server" (which is configured using `SQLNET.ALLOWED_LOGON_VERSION_SERVER`).

Each connection attempt is tested, and if the client or server does not meet the client ability requirements specified by its partner, authentication fails with an `ORA-28040 No matching authentication protocol error` in the "Ability Required of the Client" in the "SQLNET.ALLOWED_LOGON_VERSION_SERVER Settings" table under the description of the `SQLNET.ALLOWED_LOGON_VERSION_SERVER` parameter in *Oracle Database Net Services Reference*. The parameter can take the values 12a, 12, 11, 10, 9, or 8. The default value is 12, which is Exclusive Mode. These values represent the version of the authentication protocol. Oracle recommends the value 12. However, be aware that if you set `SQLNET.ALLOWED_LOGON_VERSION_SERVER` and `SQLNET.ALLOWED_LOGON_VERSION_CLIENT` to 11, then pre-Oracle Database Release 11.1 client applications including JDBC thin clients cannot authenticate to the Oracle database using password-based authentication.

To enhance security when using database authentication, Oracle recommends that you use password management, including account locking, password aging and expiration, password history, and password complexity verification.

If you are not using external authentication and only using local database password authentication, then set `AUTHENTICATION_SERVICES=(none)` in the client `sqlnet.ora` file. This setting improves performance because the client will bypass the external authentication checks and go directly to database password authentication.

Related Topics

- [Oracle Database Net Services Reference](#)
- [Oracle Database Net Services Reference](#)
- [Oracle Database Net Services Reference](#)
- [About Password Complexity Verification](#)
Complexity verification checks that each password is complex enough to protect against intruders who try to guess user passwords.
- [Using a Password Management Policy](#)
A password management policy can create and enforce a set of restrictions that can better secure user passwords.
- [Management of Password Versions of Users](#)
By default, Oracle Database uses Exclusive Mode, which does not permit case-insensitive passwords, to manage password versions.

3.4.2 Advantages of Database Authentication

There are three advantages of using the database to authenticate users.

These advantages are as follows:

- User accounts and all authentication are controlled by the database. There is no reliance on anything outside of the database.

If you are using Oracle Automatic Storage Management (Oracle ASM), then the password file can reside in Oracle ASM. In this case, administrative authentication (for example, logging on using `AS SYSDBA`) would rely on Oracle ASM if the database was configured with its password file in Oracle ASM.
- Oracle Database provides strong password management features to enhance security when using database authentication.
- It is easier to administer when there are small user communities.

3.4.3 Creating Users Who Are Authenticated by the Database

When you create a user who is authenticated by the database, you assign this user a password.

- To create a user who is authenticated by the database, include the `IDENTIFIED BY` clause when you create the user.

For example, the following SQL statement creates a user who is identified and authenticated by Oracle Database. User `sebastian` must specify the assigned password whenever they connect to Oracle Database.

```
CREATE USER sebastian IDENTIFIED BY password;
```

Related Topics

- [Creating User Accounts](#)
A user account can have restrictions such as profiles, a default role, and tablespace restrictions.

3.5 Schema-Only Accounts

You can create schema-only accounts, that is, the schema user has no password.

- [About Schema-Only Accounts](#)
A schema-only account cannot log in to the database but can proxy in a single session proxy.
- [Creating a Schema-Only Account](#)
The `CREATE USER` SQL statement creates schema-only accounts.
- [Altering a Schema-Only Account](#)
The `ALTER USER` SQL statement can be used to modify schema-only accounts.

3.5.1 About Schema-Only Accounts

A schema-only account cannot log in to the database but can proxy in a single session proxy.

This type of account, designed for some Oracle-provided schemas along with some user-created schemas, can be created without the specification of a password or an authentication type. It cannot be authenticated unless an authentication method is assigned by using the `ALTER USER` statement. A schema-only account does not contain an entry in the `DBA_USERS_WITH_DEFPWD` data dictionary view.

By default, most of the predefined schema user accounts that are available with Oracle Database, such as the sample schema user accounts (for example, `HR`), are schema-only accounts. You can assign these accounts passwords if you want to, but for better security, Oracle recommends that you set them back to being schema-only afterwards. To check if a schema user account is schema only, query the `AUTHENTICATION_TYPE` column of the `DBA_USERS` data dictionary view. `NONE` indicates that the account is schema only.

Note the following rules about using schema only accounts:

- Schema only accounts can be used for both administrator and non-administrator accounts.
- Schema only accounts must be created on the database instance only, not in Oracle Automatic Storage Management (ASM) environments.
- You can grant system privileges (such as `CREATE ANY TABLE`) and administrator roles (such as `DBA`) to schema only accounts. Schema only accounts can create objects such as tables or procedures, assuming they have had to correct privileges granted to them.
- You can configure schema only accounts to be used as client users in a proxy authentication in a single session proxy. This is because in a single session proxy, only the credentials of the proxy user are verified, not the credentials of the client user. Therefore, a schema only account can be a client user. However, you cannot configure schema only accounts for a two-proxy scenario, because the client credentials must be verified. Hence, the authentication for a schema only account will fail.
- Schema only accounts cannot connect through database links, either with connected user links, fixed user links, or current user links.

Related Topics

- [Predefined Sample Schema User Accounts](#)
Oracle Database provides a set of sample schemas that you can download and install.

3.5.2 Creating a Schema-Only Account

The `CREATE USER` SQL statement creates schema-only accounts.

You can run the `CREATE USER` statement with the `NO AUTHENTICATION` clause only on a database instance. You cannot run it on an Oracle Automatic Storage Management (ASM) instance.

- Use the `CREATE USER` statement with the `NO AUTHENTICATION` clause.

For example:

```
CREATE USER psmith NO AUTHENTICATION;
```

3.5.3 Altering a Schema-Only Account

The `ALTER USER` SQL statement can be used to modify schema-only accounts.

1. Check if the schema user has administrative privileges.

You can query the `V$PWFILE_USERS` to find if the schema user has administrative privileges.

2. If the schema user has administrative privileges, then use the `REVOKE` statement to revoke these privileges.
3. Use the `ALTER USER` SQL statement with the `NO AUTHENTICATION` clause to modify the schema account to have no authentication.

For example:

```
ALTER USER psmith NO AUTHENTICATION;
```

You can use `ALTER USER` to enable authentication for a schema-only account.

3.6 Configuring Operating System Users for a PDB

The `DBMS_CREDENTIAL.CREATE_CREDENTIAL` procedure configures user accounts to be operating system users for a pluggable database (PDB).

- [About Configuring Operating System Users for a PDB](#)
Instead of the `oracle` operating system user, a specific user account can be the operating system user for a pluggable database (PDB).
- [PDB_OS_CREDENTIAL Initialization Parameter](#)
When the database accesses an external procedure with the `extproc` agent, the `PDB_OS_CREDENTIAL` initialization parameter determines the identity of the operating system user employed when interacting with the operating system from a PDB.
- [Configuring an Operating System User for a PDB](#)
The `DBMS_CREDENTIAL.CREATE_CREDENTIAL` procedure can set an operating system user for a pluggable database (PDB).
- [Setting the Default Credential in a PDB](#)
You can set the database property `DEFAULT_CREDENTIAL` for a specified PDB.

3.6.1 About Configuring Operating System Users for a PDB

Instead of the `oracle` operating system user, a specific user account can be the operating system user for a pluggable database (PDB).

If you do not set a specific user to be the operating system user for the PDB, then by default the PDB uses the `oracle` operating system user. For the root, you can use the `oracle` operating system user when you must interact with the operating system.

For better security, Oracle recommends that you set a unique operating system user for each PDB. Doing so helps to ensure that operating system interactions are performed as a less powerful user than the `oracle` operating system user, and helps to protect data that belongs to one PDB from being accessed by users who are connected to other PDBs.

3.6.2 PDB_OS_CREDENTIAL Initialization Parameter

When the database accesses an external procedure with the `extproc` agent, the `PDB_OS_CREDENTIAL` initialization parameter determines the identity of the operating system user employed when interacting with the operating system from a PDB.

Using an operating system user described by a credential whose name is specified as a value of the `PDB_OS_CREDENTIAL` initialization parameter can ensure that operating system interactions are performed as a less powerful user. In this way, the feature protects data belonging to one PDB from being accessed by users connected to another PDB. A credential is an object that is created using the `CREATE_CREDENTIAL` procedure in the `DBMS_CREDENTIAL` package.

The Oracle operating system user is usually a highly privileged user. Using this account for operating system interactions is not recommended. Also, using the same OS user for operating system interactions from different PDBs might compromise data belonging to a given PDB.

3.6.3 Configuring an Operating System User for a PDB

The `DBMS_CREDENTIAL.CREATE_CREDENTIAL` procedure can set an operating system user for a pluggable database (PDB).

1. Log in to the CDB root as a user who has the `EXECUTE` privilege for the `DBMS_CREDENTIAL` PL/SQL package and the `ALTER SYSTEM` system privilege.

For example:

```
sqlplus c##sec_admin
Enter password: password
```

2. Run the `DBMS_CREDENTIAL.CREATE_CREDENTIAL` procedure to create an Oracle credential for the operating system user.

For example, to set the credential for a user named `os_admin`:

```
BEGIN
  DBMS_CREDENTIAL.CREATE_CREDENTIAL (
    credential_name => 'PDB1_OS_USER',
    username        => 'os_admin',
    password        => 'password');
```

```
END;  
/
```

3. Connect to the PDB for which the operating system user will be used.

For example:

```
CONNECT cc##sec_admin@pdb_name  
Enter password: password
```

To find the available PDBs in a CDB, log in to the CDB root container and then query the `PDB_NAME` column of the `DBA_PDBS` data dictionary view. To check the current container, run the `show con_name` command.

4. Set the `PDB_OS_CREDENTIAL` initialization parameter for the user whose credential was set in Step 2.

For example:

```
ALTER SYSTEM SET PDB_OS_CREDENTIAL = PDB1_OS_USER SCOPE = SPFILE;
```

The `PDB_OS_CREDENTIAL` parameter is a static parameter, so you must set it using the `SCOPE = SPFILE` clause.

5. Restart the CDB.

```
SHUTDOWN IMMEDIATE  
STARTUP
```

Related Topics

- [Minimum Requirements for Passwords](#)
Oracle provides a set of minimum requirements for passwords.

3.6.4 Setting the Default Credential in a PDB

You can set the database property `DEFAULT_CREDENTIAL` for a specified PDB.

A default credential is useful when importing files from an object store into a PDB. If you do not specify a credential name when using `impdp`, then Oracle Data Pump and the object store module can use the `DEFAULT_CREDENTIAL` object to retrieve the user name and password. When running `impdp` without specifying a credential, you must prefix the dump file name with `DEFAULT_CREDENTIAL:.`

1. Log in to a PDB with administrator privileges.
2. Use the `ALTER DATABASE` statement to set the default credential.

For example, to set the credential to `SYSTEM.HR_CRED`:

```
ALTER DATABASE PROPERTY SET DEFAULT_CREDENTIAL = 'SYSTEM.HR_CRED';
```

The following example assumes that a default credential exists. This command imports data from an object store, prefacing the URL with the string `DEFAULT_CREDENTIAL:`

```
impdp hr@pdb1 table_exists_action=replace \  
dumpfile=DEFAULT_CREDENTIAL:https://example.com/ostore/obucket/myt.dmp
```

3.7 External (Non-Database) User Authentication and Access to the Database

External authentication centralizes user security for database access improving security and reducing database administrative workload. You can perform external authentication with either local database authorization or external authorization.

- [External Authentication with Local Database Authorization](#)
Local database authorization can be configured using the operating system, Kerberos authentication, public key infrastructure (PKI) certification authentication, and RADIUS authentication.
- [External Authentication with External Authorization](#)
External authorization can be configured centrally managed users, Microsoft Entra ID, Oracle Cloud Infrastructure Identity and Access Management, and Oracle Enterprise User Security.

3.7.1 External Authentication with Local Database Authorization

Local database authorization can be configured using the operating system, Kerberos authentication, public key infrastructure (PKI) certification authentication, and RADIUS authentication.

- [About External Authentication with Local Database Authorization](#)
This external authentication model creates a one-to-one mapping of the external user to the database schema (user).
- [Operating System Authentication](#)
Users can be authenticated to the Oracle Database CDB root through operating system authentication.
- [Kerberos Authentication](#)
Kerberos is a trusted third-party authentication system that relies on shared secrets.
- [Public Key Infrastructure Certificate Authentication](#)
Authentication systems based on public key infrastructure (PKI) issue digital certificates to user clients.
- [RADIUS Authentication](#)
Remote Authentication Dial-In User Service (RADIUS) is a standard lightweight protocol used for user authentication, authorization, and accounting.

3.7.1.1 About External Authentication with Local Database Authorization

This external authentication model creates a one-to-one mapping of the external user to the database schema (user).

External users are mapped one-to-one to a database schema (user). A database schema is commonly referred to as a database user and a database account. These three terms can be used interchangeably. The external user authorization is through the existence of the mapping to the database schema and the associated direct grant of privileges and roles to the mapped schema.

Security is vastly improved over local database user management since credentials are managed in a single place, frequently as part of a single-sign on technology. Only one credential needs to be memorized by the user and password resets are most likely managed

automatically instead of by DBAs for each database. Removing user access is as simple as expiring the external user account instead of tracking down every database user account.

Oracle Database supports the following technologies for this model:

- Operating system authentication
- Kerberos authentication
- Public key infrastructure (PKI) certificate authentication
- RADIUS authentication

3.7.1.2 Operating System Authentication

Users can be authenticated to the Oracle Database CDB root through operating system authentication.

Using the operating system to authenticate users has both advantages and disadvantages. This is only applicable to the CDB root. This is not supported with PDB or application containers.

This functionality has the following benefits:

- Once authenticated by the operating system, users can connect to Oracle Database more conveniently, without specifying a user name or password. For example, an operating system-authenticated user can invoke SQL*Plus and omit the user name and password by entering the following command at the command line:

```
SQLPLUS /
```

Within SQL*Plus, you enter:

```
CONNECT /
```

- With control over user authentication centralized in the operating system, the Oracle Database does not need to store or manage the cryptographic hashes (also called verifiers) of the user passwords, although it still maintains user names in the database.
- The audit trail captures the operating system user name and the database user name, where the database user name is the value of the `OS_AUTHENT_PREFIX` instance initialization parameter prefixed to the operating system user name. For example, if both `COMMON_USER_PREFIX` and `OS_AUTHENT_PREFIX` is set to `OPS$` and the operating system user name is `psmith`, then the database common user name will be `OPS$PSMITH`. This is only applicable to the CDB root and the `COMMON_USER_PREFIX` and `OS_AUTHENT_PREFIX` must be set to the same value for this to work.
- You can authenticate both operating system and local database users in the same system. For example:
 - **Authenticate users by the operating system.** You create the user account using the `IDENTIFIED EXTERNALLY` clause of the `CREATE USER` statement, and then you set the `OS_AUTHENT_PREFIX` initialization parameter to specify a prefix that Oracle Database uses to authenticate users attempting to connect to the server. This prefix must match the `COMMON_USER_PREFIX`.
 - **Authenticate non-operating system users.** These are users who are assigned passwords and authenticated by the database.

However, you should be aware of the following drawbacks to using the operating system to authenticate users:

- A user must have an operating system account on the computer that must be accessed. Not all users have operating system accounts, particularly non-administrative users.
- If a user has logged in using this method and steps away from the terminal, another user could easily log in because this user does not need any passwords or credentials. This could pose a serious security problem. For this reason, this is mostly only done for local terminal access to the database for maintenance purposes.
- When an operating system is used to authenticate database users, managing distributed database environments and database links requires special care. Operating system-authenticated database links can pose a security weakness. For this reason, Oracle recommends that you do not use them.
- Operating system authentication can be used by a database administrator only for the CDB root. It cannot be used for PDBs, the application root, or application PDBs.

 **See Also:**

- *Oracle Database Administrator's Guide* for more information about authentication, operating systems, distributed database concepts, and distributed data management
- Operating system-specific documentation by Oracle Database for more information about authenticating by using your operating system

3.7.1.3 Kerberos Authentication

Kerberos is a trusted third-party authentication system that relies on shared secrets.

Kerberos presumes that the third party is secure, and provides single sign-on capabilities, centralized password storage, database link authentication, and enhanced PC security. It does this through a Microsoft Active Directory Kerberos service or an MIT Kerberos compatible service.

Related Topics

- [Configuring Kerberos Authentication](#)
Kerberos is a trusted third-party authentication system that relies on shared secrets and presumes that the third party is secure.

3.7.1.4 Public Key Infrastructure Certificate Authentication

Authentication systems based on public key infrastructure (PKI) issue digital certificates to user clients.

These clients can use these certificates to authenticate directly to servers in the enterprise without directly involving an authentication. Oracle Database provides a PKI for using public keys and certificates, consisting of the following components:

- **Authentication and secure session key management using TLS.**
- **Trusted certificates.** These are used to identify third-party entities that are trusted as signers of user certificates when an identity is being validated. When the user certificate is being validated, the signer is checked by using trust points or a trusted certificate chain of certificate authorities stored in the validating system. If there are several levels of trusted

certificates in this chain, then a trusted certificate at a lower level is simply trusted without needing to have all its higher-level certificates reverified.

- **Wallets and local system certificate store.** An Oracle wallet or local certificate store is a data structure that contains the private key of a user, a user certificate, and the set of trust points of a user (trusted certificate authorities).

You can use the `orapki` and `mkstore` (deprecated) utilities to manage Oracle wallets by performing the following operations:

- Generating a public-private key pair and creates a certificate request for submission to a certificate authority, and creates wallets
 - Installing a certificate for the entity
 - Managing X.509 version 3 certificates on Oracle Database clients and servers
 - Configuring trusted certificates for the entity
 - Opening a wallet to enable access to PKI-based services
- **X.509 version 3 certificates obtained from (and signed by) a trusted entity, a certificate authority.** Because the certificate authority is trusted, these certificates verify that the requesting entity's information is correct and that the public key on the certificate belongs to the identified entity. The certificate is loaded into an Oracle wallet to enable future authentication.

Related Topics

- [Configuring PKI Certificate Authentication](#)
You can configure Oracle Database to use PKI certificates for end-user authentication.

3.7.1.5 RADIUS Authentication

Remote Authentication Dial-In User Service (RADIUS) is a standard lightweight protocol used for user authentication, authorization, and accounting.

Oracle Database provides a RADIUS API to securely connect with RADIUS services

Related Topics

- [Configuring RADIUS Authentication](#)
RADIUS is a client/server security protocol widely used to enable remote authentication and access.

3.7.2 External Authentication with External Authorization

External authorization can be configured centrally managed users, Microsoft Entra ID, Oracle Cloud Infrastructure Identity and Access Management, and Oracle Enterprise User Security.

- [About External Authentication with External Authorization](#)
This model allows the identity service administrators to fully manage an organization's joiners, movers, and leavers within the identity service.
- [Centrally Managed Users with Microsoft Active Directory](#)
You can configure Oracle Database to directly connect with Microsoft Active Directory for authentication and authorization using centrally managed users (CMU).
- [Microsoft Entra ID Integration](#)
Microsoft Azure users can connect to the database directly using Microsoft Entra ID OAuth2 access tokens.

- [Oracle Cloud Infrastructure Identity and Access Management Integration](#)
Oracle Cloud Infrastructure (OCI) Identity and Access Management (IAM) users can connect to an Oracle DBaaS database.
- [Oracle Enterprise User Security](#)
Oracle Identity Directory (OID) users can access the Oracle Database through password, Kerberos, and PKI certificate authentication.

3.7.2.1 About External Authentication with External Authorization

This model allows the identity service administrators to fully manage an organization's joiners, movers, and leavers within the identity service.

External users are authenticated externally as with the previous model, but the external user can be mapped exclusively to a schema or more commonly in this model, many external users are mapped to the same schema (shared schema). The shared schema is mapped to an identity group or some other grouping mechanism unique to the identity service. The external user can also be optionally mapped to a database global role through membership in an identity group or grouping mechanism).

A common deployment model using this model is to map all users to a single shared schema with low or no privileges and grant the differentiated privileges through global roles. Using this mechanism, a joiner is authorized to the database by the identity service administrator by adding them to one or more identity groups. Someone moving in the organization can have their database authorization changed by moving them from one group to another. When a user leaves the company or doesn't require database access anymore, they will be removed from all identity groups mapped to databases.

This is another step up in security since the identity team manages the database authorizations, leaving the database administrators free to manage the database instead of individual users.

Oracle Database supports the following technologies for this model:

- Centrally managed users (CMU) with Active Directory
- Microsoft Entra ID (MSEI) integration
- Oracle Cloud Infrastructure (OCI) Identity and Access Management (IAM) integration
- Oracle - Enterprise User Security (EUS) (deprecated)

3.7.2.2 Centrally Managed Users with Microsoft Active Directory

You can configure Oracle Database to directly connect with Microsoft Active Directory for authentication and authorization using centrally managed users (CMU).

Password, Kerberos and PKI certificate-based authentication are supported with CMU-AD. You can map users exclusively to a database schema or to a shared schema through membership in a group mapped to a global shared schema. Additional roles for the user can optionally be available through additional group memberships mapped to database global roles.

Related Topics

- [Configuring Centrally Managed Users with Microsoft Active Directory](#)
Oracle Database can authenticate and authorize Microsoft Active Directory users with the database directly without intermediate directories or Oracle Enterprise User Security.

3.7.2.3 Microsoft Entra ID Integration

Microsoft Azure users can connect to the database directly using Microsoft Entra ID OAuth2 access tokens.

Users authenticate to Microsoft Entra ID along with any associated multi-factor authentication configured by the Entra ID administrator. Microsoft Azure users and groups are assigned to the registered database app roles in Entra ID. These app roles are mapped to database schemas and global roles.

Related Topics

- [Authenticating and Authorizing Microsoft Azure Users for Oracle Databases](#)
An Oracle database can be configured for Microsoft Azure users of Microsoft Entra ID (previously called Microsoft Azure AD) to connect using single sign-on authentication.

3.7.2.4 Oracle Cloud Infrastructure Identity and Access Management Integration

Oracle Cloud Infrastructure (OCI) Identity and Access Management (IAM) users can connect to an Oracle DBaaS database.

Users authenticate to OCI IAM along with any associated multi-factor authentication configured by the IAM administrator. IAM user and groups are mapped to database schemas and global roles for authorization.

Related Topics

- [Authenticating and Authorizing IAM Users for Oracle DBaaS Databases](#)
Identity and Access Management (IAM) users can be configured to connect to an Oracle Database as a service (Oracle DBaaS) instance.

3.7.2.5 Oracle Enterprise User Security

Oracle Identity Directory (OID) users can access the Oracle Database through password, Kerberos, and PKI certificate authentication.



Note:

Oracle Enterprise User Security is deprecated starting with Oracle Database 23ai.

Shared schema mapping is done through directory subtrees and Enterprise Roles grant additional roles and privileges to the OID user.

Related Topics

- *Oracle Database Enterprise User Security Administrator's Guide*

3.8 Multitier Authentication and Authorization

Oracle Database secures middle-tier applications by limiting privileges, preserving client identities through all tiers, and auditing actions by clients.

In applications that use a very busy middle tier, such as a transaction processing monitor, the identity of the clients connecting to the middle tier must be preserved. One advantage of using a middle tier is **connection pooling**, which allows multiple users to access a data server

without each of them needing a separate connection. In such environments, you need to be able to set up and break down connections very quickly.

For these environments, you can use the Oracle Call Interface to create **lightweight sessions**, which enable database password authentication for each user. This method preserves the identity of the real user through the middle tier without the overhead of a separate database connection for each user.

You can create lightweight sessions with or without passwords. However, if a middle tier is outside of or on a firewall, then security is better when each lightweight session has its own password. For an internal application server, lightweight sessions without passwords might be appropriate.

3.9 Administration and Security in Clients, Application Servers, and Database Servers

In a multitier environment, an application server provides data for clients and serves as an interface to one or more database servers.

The application server can validate the credentials of a client, such as a Web browser, and the database server can audit operations performed by the application server. These auditable operations include actions performed by the application server on behalf of clients, such as requests that information be displayed on the client. A request to connect to the database server is an example of an application server operation not related to a specific client.

Authentication in a multitier environment is based on trust regions. Client authentication is the domain of the application server. The application server itself is authenticated by the database server. The following operations take place:

- The end user provides proof of authenticity to the application server, typically, by using a password or an X.509 certificate.
- The application server authenticates the end user and then authenticates itself to the database server.
- The database server authenticates the application server, verifies that the end user exists, and verifies that the application server has the privilege to connect for the end user.

Application servers can also enable roles for an end user on whose behalf they connect. The application server can obtain these roles from a directory, which serves as an authorization repository. The application server can only request that these roles be enabled. The database verifies the following requirements:

- That the client has these roles by checking its internal role repository
- That the application server has the privilege to connect on behalf of the user and thus to use these roles as the user could

The following diagram shows an example of multitier authentication.

Figure 3-3 Multitier Authentication

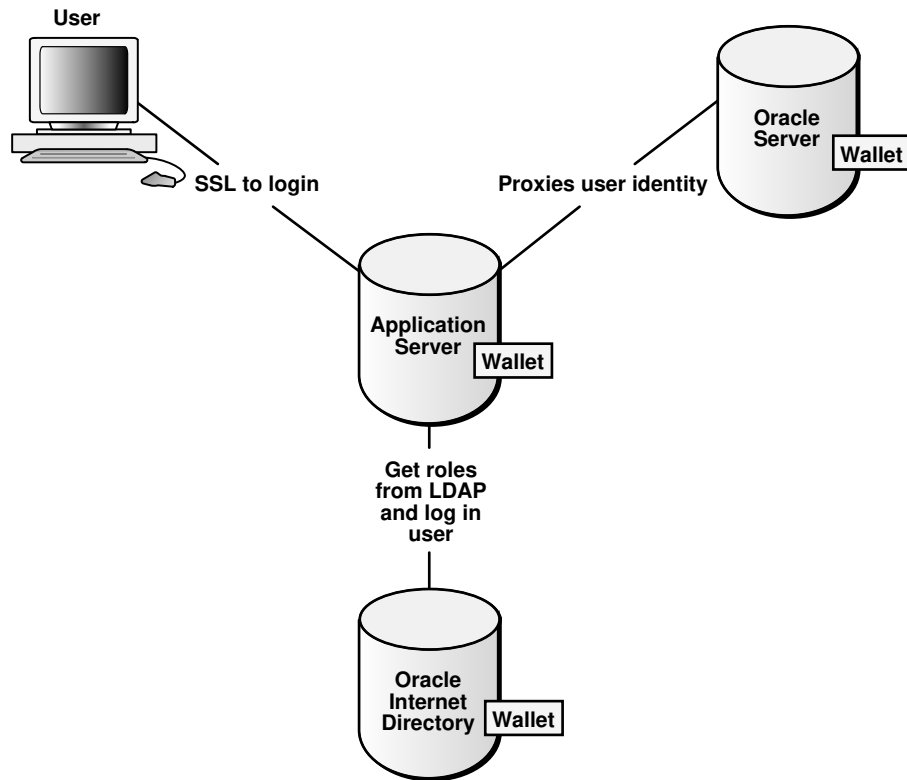

The following actions take place:

1. The user logs on using a password or Transport Layer Security. The authentication information is passed through Oracle Application Server.
2. Oracle Internet Directory authenticates the user, gets the roles associated with that user from the wallet, and then passes this information back to Oracle Application Server.
3. Oracle Application Server checks the identity of the user in Oracle Database, which contains a wallet that stores this information, and then sets the role for that user.

Security for middle-tier applications must address the following key issues:

- **Accountability.** The database server must be able to distinguish between the actions of the application and the actions an application takes on behalf of a client. It must be possible to audit both kinds of actions.
- **Least privilege.** Users and middle tiers should be given the fewest privileges necessary to perform their actions, to reduce the danger of inadvertent or malicious unauthorized activities.

3.10 Preserving User Identity in Multitiered Environments

You can use middle tier servers for proxy authentication and client identifiers to identify application users who are not known to the database.

- **Middle Tier Server Use for Proxy Authentication**
Oracle Call Interface (OCI), JDBC/OCI, or JDBC Thin Driver supports the middle tier for proxy authentication for database users or enterprise users.

- [Using Client Identifiers to Identify Application Users Unknown to the Database](#)
Client identifiers preserve user identity in middle tier systems; they also can be used independently of the global application context.

3.10.1 Middle Tier Server Use for Proxy Authentication

Oracle Call Interface (OCI), JDBC/OCI, or JDBC Thin Driver supports the middle tier for proxy authentication for database users or enterprise users.

- [About Proxy Authentication](#)
Oracle Database provides proxy authentication in Oracle Call Interface (OCI), JDBC/OCI, or JDBC Thin Driver for database users or enterprise users.
- [Advantages of Proxy Authentication](#)
In multitier environments, proxy authentication preserves client identities and privileges through all tiers in middle-tier applications and by auditing client actions.
- [Who Can Create Proxy User Accounts?](#)
To create proxy user accounts, users must have special privileges.
- [Guidelines for Creating Proxy User Accounts](#)
Oracle provides special guidelines for when you create proxy user accounts.
- [Creating Proxy User Accounts and Authorizing Users to Connect Through Them](#)
The `CREATE USER` and `ALTER USER` statements can be used to create a proxy user and authorize users to connect through it.
- [Proxy User Accounts and the Authorization of Users to Connect Through Them](#)
The `CREATE USER` statement enables you to create the several types of user accounts, all of which can be used as proxy accounts.
- [Using Proxy Authentication with the Secure External Password Store](#)
Use a secure external password store if you are concerned about the password used in proxy authentication being obtained by a malicious user.
- [How the Identity of the Real User Is Passed with Proxy Authentication](#)
You can use Oracle Call Interface, JDBC/OCI, or Thin drivers for enterprise users or database users.
- [Limits to the Privileges of the Middle Tier](#)
Least privilege is the principle that users should have the fewest privileges necessary to perform their duties and no more.
- [Authorizing a Middle Tier to Proxy and Authenticate a User](#)
You can authorize a middle-tier server to connect as a user.
- [Authorizing a Middle Tier to Proxy a User Authenticated by Other Means](#)
You can authorize a middle tier to proxy a user that has been authenticated by other means.
- [Reauthenticating a User Through the Middle Tier to the Database](#)
You can specify that authentication is required by using the `AUTHENTICATION REQUIRED` proxy clause with the `ALTER USER SQL` statement.
- [Using Password-Based Proxy Authentication](#)
When you use password-based proxy authentication, Oracle Database passes the password of the client to the middle-tier server.
- [Using Proxy Authentication with Enterprise Users](#)
How the middle-tier responds for proxy authentication depends on how the user is authenticated, either as an enterprise user or a password-authenticated user.

3.10.1.1 About Proxy Authentication

Oracle Database provides proxy authentication in Oracle Call Interface (OCI), JDBC/OCI, or JDBC Thin Driver for database users or enterprise users.

Enterprise users are those who are managed in Oracle Internet Directory and who access a shared schema in the database.

You can design a middle-tier server to authenticate clients in a secure fashion by using the following three forms of proxy authentication:

- The middle-tier server authenticates itself with the database server and a client, in this case an application user or another application, authenticates itself with the middle-tier server. Client identities can be maintained all the way through to the database.
- The client, in this case a database user, is not authenticated by the middle-tier server. The client's identity and database password are passed through the middle-tier server to the database server for authentication.
- The client, in this case a global user, is authenticated by the middle-tier server, and passes one of the following through the middle tier for retrieving the client's user name.
 - Distinguished name (DN)
 - Certificate

In all cases, an administrator must authorize the middle-tier server to act on behalf of the client.

Related Topics

- [Auditing in a Multitier Deployment](#)
You can create a unified audit policy to audit the activities of a client in a multitier environment.
- *Oracle Database JDBC Developer's Guide*

3.10.1.2 Advantages of Proxy Authentication

In multitier environments, proxy authentication preserves client identities and privileges through all tiers in middle-tier applications and by auditing client actions.

For example, this feature allows the identity of a user using a Web application (which acts as a proxy) to be passed through the application to the database server.

Three-tier systems provide the following benefits to organizations:

- Organizations can separate application logic from data storage, partitioning the former in application servers and the latter in databases.
- Application servers and Web servers enable users to access data stored in databases.
- Users like using a familiar, easy-to-use browser interface.
- Organizations can also lower their cost of computing by replacing many *thick clients* with numerous *thin clients* and an application server.

In addition, Oracle Database proxy authentication provides the following security benefits:

- A limited trust model, by controlling the users on whose behalf middle tiers can connect and the roles that the middle tiers can assume for the user
- Scalability, by supporting user sessions through OCI, JDBC/OCI, or JDBC Thin driver and eliminating the overhead of reauthenticating clients

- Accountability, by preserving the identity of the real user through to the database, and enabling auditing of actions taken on behalf of the real user
- Flexibility, by supporting environments in which users are known to the database, and in which users are merely application users of which the database has no awareness

 **Note:**

Oracle Database supports this proxy authentication functionality in three tiers only. It does not support it across multiple middle tiers.

3.10.1.3 Who Can Create Proxy User Accounts?

To create proxy user accounts, users must have special privileges.

These privileges are as follows:

- The `CREATE USER` system privilege to create a database user account that will be used as a proxy user account
- The `DV_ACCTMGR` role if Oracle Database Vault is enabled, to create the proxy user account
- The ability to grant the `CREATE SESSION` system privilege to the proxy user account
- The `ALTER USER` system privilege to enable existing user accounts to connect to the database through the proxy account

 **Note:**

In an Oracle Database Vault environment, when operations control is enabled, common users cannot proxy as local users in a PDB.

3.10.1.4 Guidelines for Creating Proxy User Accounts

Oracle provides special guidelines for when you create proxy user accounts.

- For better security and to adhere to the principle of least privilege, only grant the proxy user account the `CREATE SESSION` privilege. Do not grant this user any other privileges. The proxy user account is designed to only enable another user to connect using the proxy account. Any privileges that must be exercised during the connection should belong to the connecting user, not to the proxy account.
- As with all passwords, ensure that the password you create for the proxy user is strong and not easily guessed. Remember that multiple users will be connecting as the proxy user, so it is especially important that this password be strong.
- Consider using the Oracle strong authentication network connection features, to prevent network eavesdropping.
- For further fine-tuning of the amount of control that the connecting user has, consider restricting the roles used by the connecting user when they are connected through the proxy account. The `ALTER USER` statement `WITH ROLE` clause enables you to configure the user to connect using specified roles, any role except a specified role, or with no roles at all. Be aware that the proxy user can only activate those roles that are included in the `WITH`

ROLE clause. The proxy user session will have all the privileges that were directly granted to the client (that is, current) user.

- A proxy user in a proxy session can enable a password-protected role or secure application role only if the role has been allowed to be enabled with the `WITH ROLE` or `WITH ROLE ALL` clause. (If this clause is not specified, then `WITH ROLE ALL` is the default.) If `WITH ROLE` does not specify the secure roles, then those roles cannot be enabled, even with the correct password.

Related Topics

- [Guidelines for Securing Passwords](#)
Oracle provides guidelines for securing passwords in a variety of situations.

3.10.1.5 Creating Proxy User Accounts and Authorizing Users to Connect Through Them

The `CREATE USER` and `ALTER USER` statements can be used to create a proxy user and authorize users to connect through it.

A proxy user in a proxy session can enable a password-protected role or secure application role only if the role has been allowed to be enabled with the `WITH ROLE` or `WITH ROLE ALL` clause. (If this clause is not specified, then `WITH ROLE ALL` is the default.) If `WITH ROLE` does not specify the secure roles, then those roles cannot be enabled, even with the correct password.

1. Use the `CREATE USER` statement to create the proxy user account.

For example:

```
CREATE USER appuser IDENTIFIED BY password;
```

2. Use the `GRANT CONNECT THROUGH` clause of the `ALTER USER` statement to enable an existing user to connect through the proxy user account.

For example:

```
ALTER USER preston GRANT CONNECT THROUGH appuser;
```

Be aware that the user name and proxy combination must not exceed 250 characters.

Suppose user `preston` has a large number of roles, but you only want this user to use one role (for example, the `appuser_role`) when this user is connected to the database through the `appuser` proxy account. You can use the following `ALTER USER` statement:

```
ALTER USER preston GRANT CONNECT THROUGH appuser WITH ROLE appuser_role;
```

Any other roles that user `preston` has will not be available to her as long as this user is connecting as the `appuser` proxy.

After you complete these steps, user `preston` can connect using the `appuser` proxy user as follows:

```
CONNECT appuser[preston]
Enter password: appuser_password
```

Related Topics

- *Oracle Database SQL Language Reference*
- *Oracle Database SQL Language Reference*

3.10.1.6 Proxy User Accounts and the Authorization of Users to Connect Through Them

The `CREATE USER` statement enables you to create the several types of user accounts, all of which can be used as proxy accounts.

These accounts are as follows:

- Database user accounts, which are authenticated by passwords
- External user accounts, which are authenticated by external sources, such as Secure Socket Layer (SSL) or Kerberos
- Global user accounts, which are authenticated by an enterprise directory service (Oracle Internet Directory).

Note the following:

- **The proxy user can only perform activities that the user `preston` has privileges to perform.** Remember that the proxy user itself, `appuser`, only has the minimum privileges (`CREATE SESSION`).
- **Using roles with middle-tier clients.** You can also specify roles that the middle tier is permitted to activate when connecting as the client. Operations performed on behalf of a client by a middle-tier server can be audited.
- **Finding proxy users.** To find the users who are currently authorized to connect through a middle tier, query the `PROXY_USERS` data dictionary view, for example:

```
SELECT * FROM PROXY_USERS;
```

- **Removing proxy connections.** Use the `REVOKE CONNECT THROUGH` clause of `ALTER USER` to disallow a proxy connection. For example, to revoke user `preston` from connecting through the proxy user `appuser`, enter the following statement:

```
ALTER USER preston REVOKE CONNECT THROUGH appuser;
```

- **Password expiration and proxy connections.** Middle-tier use of password expiration does not apply to accounts that are authenticated through a proxy. Instead, lock the account rather than expire the password.

Related Topics

- [Auditing in a Multitier Deployment](#)
You can create a unified audit policy to audit the activities of a client in a multitier environment.
- *Oracle Database Enterprise User Security Administrator's Guide*

3.10.1.7 Using Proxy Authentication with the Secure External Password Store

Use a secure external password store if you are concerned about the password used in proxy authentication being obtained by a malicious user.

To accomplish this, you use the secure external password store with the proxy authentication to store the password credentials in a wallet.

Connecting to Oracle Database using proxy authentication and the secure external password store is ideal for situations such as running batch files. When a proxy user connects to the database and authenticates using a secure external password, the password is not exposed in the event that a malicious user tries to obtain the password.

To use proxy authentication with the secure external password store:

1. Configure the proxy authentication account.
2. Configure the secure external password store.

Afterward, the user can connect using the proxy but without having to specify a password. For example:

```
sqlplus [preston]/@db_alias
```

When you use the secure external password store, the user logging in does not need to supply the user name and password. Only the `SERVICE_NAME` value (that is, `db_alias`) from the `tnsnames.ora` file must be specified. This `SERVICE_NAME` value maps to a PDB.

Related Topics

- [Proxy User Accounts and the Authorization of Users to Connect Through Them](#)
The `CREATE USER` statement enables you to create the several types of user accounts, all of which can be used as proxy accounts.
- [About Configuring Clients to Use the Secure External Password Store](#)
If your client is configured to use external authentication, such as Windows native authentication or SSL, then Oracle Database uses that authentication method.

3.10.1.8 How the Identity of the Real User Is Passed with Proxy Authentication

You can use Oracle Call Interface, JDBC/OCI, or Thin drivers for enterprise users or database users.

These tools enable a middle tier to set up several user sessions within a single database connection, each of which uniquely identifies a connected user (connection pooling)

These sessions reduce the network overhead of creating separate network connections from the middle tier to the database.

If you want to authenticate from clients through a middle tier to the database, then the full authentication sequence from the client to the middle tier to the database occurs as follows:

1. The client authenticates to the middle tier, using whatever form of authentication the middle tier will accept. For example, the client could authenticate to the middle tier by using a user name and password or an X.509 certificate by means of SSL.
2. The middle tier authenticates itself to the database by using whatever form of authentication the database accepts. This could be a password or an authentication mechanism supported by Oracle Database, such as a Kerberos ticket or an X.509 certificate (SSL).
3. The middle tier then creates one or more sessions for users using OCI, JDBC/OCI, or Thin driver.
 - If the user is a database user, then the session must, as a minimum, include the database user name. If the database requires it, then the session can include a password (which the database verifies against the password store in the database). The session can also include a list of database roles for the user.
 - If the user is an enterprise user, then the session may provide different information depending on how the user is authenticated.

Example 1: If the user authenticates to the middle tier using SSL, then the middle tier can provide the DN from the X.509 certificate of the user, or the certificate itself in the session. The database uses the DN to look up the user in Oracle Internet Directory.

Example 2: If the user is a password-authenticated enterprise user, then the middle tier must provide, as a minimum, a globally unique name for the user. The database uses this name to look up the user in Oracle Internet Directory. If the session also provides a password for the user, then the database will verify the password against Oracle Internet Directory. User roles are automatically retrieved from Oracle Internet Directory after the session is established.

- The middle tier may optionally provide a list of database roles for the client. These roles are enabled if the proxy is authorized to use the roles on behalf of the client.
4. The database verifies that the middle tier has the privilege to create sessions on behalf of the user.

The `OCISessionBegin` call fails if the application server cannot perform a proxy authentication on behalf of the client by the administrator, or if the application server is not allowed to activate the specified roles.

3.10.1.9 Limits to the Privileges of the Middle Tier

Least privilege is the principle that users should have the fewest privileges necessary to perform their duties and no more.

As applied to middle tier applications, this means that the middle tier should not have more privileges than it needs.

Oracle Database enables you to limit the middle tier such that it can connect only on behalf of certain database users, using only specific database roles. You can limit the privilege of the middle tier to connect on behalf of an enterprise user, stored in an LDAP directory, by granting to the middle tier the privilege to connect as the mapped database user. For instance, if the enterprise user is mapped to the `APPUSER` schema, then you must at least grant to the middle tier the ability to connect on behalf of `APPUSER`. Otherwise, attempts to create a session for the enterprise user will fail.

However, you cannot limit the ability of the middle tier to connect on behalf of enterprise users. For example, suppose that user Sarah wants to connect to the database through a middle tier, `appsrv` (which is also a database user). Sarah has multiple roles, but it is desirable to restrict the middle tier to use only the `clerk` role on their behalf.

An administrator can grant permission for `appsrv` to initiate connections on behalf of Sarah using the `clerk` role only by using the following SQL statement:

```
ALTER USER sarah GRANT CONNECT THROUGH appsrv WITH ROLE clerk;
```

By default, the middle tier cannot create connections for any client. The permission must be granted for each user.

To enable `appsrv` to use all of the roles granted to the client Sarah, you can use the following statement:

```
ALTER USER sarah GRANT CONNECT THROUGH appsrv;
```

Each time a middle tier initiates an OCI, JDBC/OCI, or Thin driver session for another database user, the database verifies that the middle tier is authorized to connect for that user by using the role specified.

 **Note:**

Instead of using default roles, create your own roles and assign only necessary privileges to them. Creating your own roles enables you to control the privileges granted by them and protects you if Oracle Database changes or removes default roles. For example, the `CONNECT` role now has only the `CREATE SESSION` privilege, the one most directly needed when connecting to a database. However, `CONNECT` formerly provided several additional privileges, often not needed or appropriate for most users. Extra privileges can endanger the security of your database and applications. These have now been removed from `CONNECT`.

A proxy user in a proxy session can enable a password-protected role or secure application role only if the role has been allowed to be enabled with the `WITH ROLE` or `WITH ROLE ALL` clause. (If this clause is not specified, then `WITH ROLE ALL` is the default.) If `WITH ROLE` does not specify the secure roles, then those roles cannot be enabled, even with the correct password.

Related Topics

- [Configuring Privilege and Role Authorization](#)
Privilege and role authorization controls the permissions that users have to perform day-to-day tasks.

3.10.1.10 Authorizing a Middle Tier to Proxy and Authenticate a User

You can authorize a middle-tier server to connect as a user.

A proxy user in a proxy session can enable a password-protected role or secure application role only if the role has been allowed to be enabled with the `WITH ROLE` or `WITH ROLE ALL` clause. (If this clause is not specified, then `WITH ROLE ALL` is the default.) If `WITH ROLE` does not specify the secure roles, then those roles cannot be enabled, even with the correct password.

- To authorize a middle-tier server to connect as a user, use the `ALTER USER` statement.

The following statement authorizes the middle-tier server `appserve` to connect as user `bill`. It uses the `WITH ROLE` clause to specify that `appserve` activate all roles associated with `bill`, except `payroll`.

```
ALTER USER bill
  GRANT CONNECT THROUGH appserve
  WITH ROLE ALL EXCEPT payroll;
```

To revoke the middle-tier server (`appserve`) authorization to connect as user `bill`, you can use the `REVOKE CONNECT THROUGH` clause. For example:

```
ALTER USER bill REVOKE CONNECT THROUGH appserve;
```

3.10.1.11 Authorizing a Middle Tier to Proxy a User Authenticated by Other Means

You can authorize a middle tier to proxy a user that has been authenticated by other means.

Currently, `PASSWORD` is the only means supported.

- Use the `AUTHENTICATION REQUIRED` clause of the `ALTER USER ... GRANT CONNECT THROUGH` statement to authorize a user to be proxied, but not authenticated, by a middle tier.

For example:

```
ALTER USER mary
  GRANT CONNECT THROUGH midtier
  AUTHENTICATION REQUIRED;
```

In the preceding statement, middle-tier server `midtier` is authorized to connect as user `mary`, and `midtier` must also pass the user password to the database server for authorization.

3.10.1.12 Reauthenticating a User Through the Middle Tier to the Database

You can specify that authentication is required by using the `AUTHENTICATION REQUIRED` proxy clause with the `ALTER USER SQL` statement.

In this case, the middle tier must provide user authentication credentials.

For example, suppose that user Sarah wants to connect to the database through a middle tier, `appsrv`.

- To require that `appsrv` provides authentication credentials for the user Sarah, use the following syntax:

```
ALTER USER sarah GRANT CONNECT THROUGH appsrv AUTHENTICATION REQUIRED;
```

The `AUTHENTICATION REQUIRED` clause ensures that authentication credentials for the user must be presented when the user is authenticated through the specified proxy.



Note:

For backward compatibility, if you use the `AUTHENTICATED USING PASSWORD` proxy clause, then Oracle Database transforms it to `AUTHENTICATION REQUIRED`.

3.10.1.13 Using Password-Based Proxy Authentication

When you use password-based proxy authentication, Oracle Database passes the password of the client to the middle-tier server.

The middle-tier server then passes the password as an attribute to the data server for verification.

The main advantage to this type of authentication is that the client computer does not have to have Oracle software installed on it to perform database operations.

- To pass the password of the client, configure the the middle-tier server to call the `OCIAttrSet()` function as follows, passing `OCI_ATTR_PASSWORD` as the type of the attribute being set.

```
OCIAttrSet(
  session_handle, /* Pointer to a handle whose attribute gets modified. */
  OCI_HTYPE_SESSION, /* Handle type: OCI user session handle. */
  password_ptr, /* Pointer to the value of the password attribute. */
  0, /* The size of the password attribute value is already
      known by the OCI library. */
  OCI_ATTR_PASSWORD, /* The attribute type. */
  error_handle); /* An error handle used to retrieve diagnostic
      information in the event of an error. */
```

3.10.1.14 Using Proxy Authentication with Enterprise Users

How the middle-tier responds for proxy authentication depends on how the user is authenticated, either as an enterprise user or a password-authenticated user.

If the middle tier connects to the database as a client who is an enterprise user, then either the distinguished name, or the X.509 certificate containing the distinguished name is passed over instead of the database user name. If the user is a password-authenticated enterprise user, then the middle tier must provide, as a minimum, a globally unique name for the user. The database uses this name to look up the user in Oracle Internet Directory.

- To configure proxy authentication with enterprise users, configure the application server and the middle tier to use the appropriate Oracle Call Interface settings:

- To pass over the distinguished name of the client, configure the application server to call the Oracle Call Interface method `OCIAttrSet()` with

`OCI_ATTR_DISTINGUISHED_NAME` as the attribute type, as follows:

```
OCIAttrSet(session_handle,
           OCI_HTYPE_SESSION,
           distinguished_name,
           0,
           OCI_ATTR_DISTINGUISHED_NAME,
           error_handle);
```

- To pass over the entire certificate, configure the middle tier to call `OCIAttrSet()` with `OCI_ATTR_CERTIFICATE` as the attribute type, as follows:

```
OCIAttrSet(session_handle,
           OCI_HTYPE_SESSION,
           certificate,
           certificate_length,
           OCI_ATTR_CERTIFICATE,
           error_handle);
```

If the type is not specified, then the database uses its default certificate type of X.509.

Note:

- `OCI_ATTR_CERTIFICATE` is Distinguished Encoding Rules (DER) encoded.
- Certificate based proxy authentication using `OCI_ATTR_CERTIFICATE` will not be supported in future Oracle Database releases. Use the `OCI_ATTR_DISTINGUISHED_NAME` or `OCI_ATTR_USERNAME` attribute instead

If you are using proxy authentication for password-authenticated enterprise users, then use the same OCI attributes as for database users authenticated by password (`OCI_ATTR_USERNAME`). Oracle Database first checks the user name against the database. If it finds no user, then the database checks the user name in the directory. This user name must be globally unique.

3.10.2 Using Client Identifiers to Identify Application Users Unknown to the Database

Client identifiers preserve user identity in middle tier systems; they also can be used independently of the global application context.

- [About Client Identifiers](#)
Oracle Database provides the `CLIENT_IDENTIFIER` attribute of the built-in `USERENV` application context namespace for application users.
- [How Client Identifiers Work in Middle Tier Systems](#)
Many applications use session pooling to set up several sessions to be reused by multiple application users.
- [Use of the `CLIENT_IDENTIFIER` Attribute to Preserve User Identity](#)
The `CLIENT_IDENTIFIER` predefined attribute of the built-in application context namespace, `USERENV`, captures the application user name for use with a global application context.
- [Use of the `CLIENT_IDENTIFIER` Independent of Global Application Context](#)
Using the `CLIENT_IDENTIFIER` attribute is especially useful for those applications in which the users are unknown to the database.
- [Setting the `CLIENT_IDENTIFIER` Independent of Global Application Context](#)
You can set the `CLIENT_IDENTIFIER` setting with Oracle Call Interface to be independent of the global application context.
- [Use of the `DBMS_SESSION` PL/SQL Package to Set and Clear the Client Identifier](#)
The `DBMS_SESSION` PL/SQL package manages client identifiers on both the middle tier and the database itself.
- [Enabling the `CLIENTID_OVERWRITE` Event System-Wide](#)
The `ALTER SYSTEM` statement can enable the `CLIENTID_OVERWRITE` event system-wide.
- [Enabling the `CLIENTID_OVERWRITE` Event for the Current Session](#)
The `ALTER SESSION` statement can enable the `CLIENTID_OVERWRITE` event for the current session only.
- [Disabling the `CLIENTID_OVERWRITE` Event](#)
The `ALTER SYSTEM` statement can disable the `CLIENTID_OVERWRITE` event.

3.10.2.1 About Client Identifiers

Oracle Database provides the `CLIENT_IDENTIFIER` attribute of the built-in `USERENV` application context namespace for application users.

These application users are known to an application but unknown to the database. The `CLIENT_IDENTIFIER` attribute can capture any value that the application uses for identification or access control, and passes it to the database. The `CLIENT_IDENTIFIER` attribute is supported in OCI, JDBC/OCI, or Thin driver.

3.10.2.2 How Client Identifiers Work in Middle Tier Systems

Many applications use session pooling to set up several sessions to be reused by multiple application users.

Users authenticate themselves to a middle-tier application, which uses a single identity to log in to the database and maintains all the user connections. In this model, application users are users who are authenticated to the middle tier of an application, but who are not known to the

database. You can use a `CLIENT_IDENTIFIER` attribute, which acts like an application user proxy for these types of applications.

In this model, the middle tier passes a client identifier to the database upon the session establishment. The client identifier could actually be anything that represents a client connecting to the middle tier, for example, a cookie or an IP address. The client identifier, representing the application user, is available in user session information and can also be accessed with an application context (by using the `USERENV` naming context). In this way, applications can set up and reuse sessions, while still being able to keep track of the *application user* in the session. Applications can reset the client identifier and thus reuse the session for a different user, enabling high performance.

3.10.2.3 Use of the `CLIENT_IDENTIFIER` Attribute to Preserve User Identity

The `CLIENT_IDENTIFIER` predefined attribute of the built-in application context namespace, `USERENV`, captures the application user name for use with a global application context.

You also can use the `CLIENT_IDENTIFIER` attribute independently.

When you use the `CLIENT_IDENTIFIER` attribute independently from a global application context, you can set `CLIENT_IDENTIFIER` with the `DBMS_SESSION` interface. The ability to pass a `CLIENT_IDENTIFIER` to the database is supported in Oracle Call Interface (OCI), JDBC/OCI, or Thin driver.

When you use the `CLIENT_IDENTIFIER` attribute with global application context, it provides flexibility and high performance for building applications. For example, suppose a Web-based application that provides information to business partners has three types of users: gold partner, silver partner, and bronze partner, representing different levels of information available. Instead of each user having their own session set up with individual application contexts, the application could set up global application contexts for gold partners, silver partners, and bronze partners. Then, use the `CLIENT_IDENTIFIER` to point the session at the correct context to retrieve the appropriate type of data. The application need only initialize the three global contexts once and use the `CLIENT_IDENTIFIER` to access the correct application context to limit data access. This provides performance benefits through session reuse and through accessing global application contexts set up once, instead of having to initialize application contexts for each session individually.

Related Topics

- [Global Application Contexts](#)
You can use a global application context to access application values across database sessions, including an Oracle Real Application Clusters environment.
- [Tutorial: Creating a Global Application Context That Uses a Client Session ID](#)
This tutorial demonstrates how you can create a global application context that uses a client session ID.

3.10.2.4 Use of the `CLIENT_IDENTIFIER` Independent of Global Application Context

Using the `CLIENT_IDENTIFIER` attribute is especially useful for those applications in which the users are unknown to the database.

In these situations, the application typically connects as a single database user and all actions are taken as that user.

Because all user sessions are created as the same user, this security model makes it difficult to achieve data separation for each user. These applications can use the `CLIENT_IDENTIFIER` attribute to preserve the real application user identity through to the database.

With this approach, sessions can be reused by multiple users by changing the value of the `CLIENT_IDENTIFIER` attribute, which captures the name of the real application user. This avoids the overhead of setting up a separate session and separate attributes for each user, and enables reuse of sessions by the application. When the `CLIENT_IDENTIFIER` attribute value changes, the change is added to the next OCI, JDBC/OCI, or Thin driver call for additional performance benefits.

For example, the user Daniel connects to a Web Expense application. Daniel is not a database user; this user is a typical Web Expense application user. The application accesses the built-in application context namespace and sets `DANIEL` as the `CLIENT_IDENTIFIER` attribute value. Daniel completes the Web Expense form and exits the application. Then, Ajit connects to the Web Expense application. Instead of setting up a new session for Ajit, the application reuses the session that currently exists for Daniel, by changing the `CLIENT_IDENTIFIER` to `AJIT`. This avoids the overhead of setting up a new connection to the database and the overhead of setting up a global application context. The `CLIENT_IDENTIFIER` attribute can be set to any value on which the application bases access control. It does not have to be the application user name.

3.10.2.5 Setting the `CLIENT_IDENTIFIER` Independent of Global Application Context

You can set the `CLIENT_IDENTIFIER` setting with Oracle Call Interface to be independent of the global application context.

- To set the `CLIENT_IDENTIFIER` attribute with OCI, use the `OCI_ATTR_CLIENT_IDENTIFIER` attribute in the call to `OCIAttrSet()`. Then, on the next request to the server, the information is propagated and stored in the server sessions.

For example:

```
OCIAttrSet (session,
OCI_HTYPE_SESSION,
(dvoid *) "appuser1",
(ub4) strlen("appuser1"),
OCI_ATTR_CLIENT_IDENTIFIER,
*error_handle);
```

For applications that use JDBC, be aware that JDBC does not set the client identifier. To set the client identifier in a connection pooling environment, use Dynamic Monitoring Service (DMS) metrics. If DMS is not available, then use the `connection.setClientInfo` method. For example:

```
connection.setClientInfo("E2E_CONTEXT.CLIENT_IDENTIFIER", "appuser");
```

See Also:

- *Oracle Call Interface Developer's Guide* about how the `OCI_ATTR_CLIENT_IDENTIFIER` user session handle attribute is used in middle-tier applications
- *Oracle Database JDBC Developer's Guide* for more information about configuring client connections using JDBC and DMS metrics
- *Oracle Database JDBC Developer's Guide* for more information about the `setClientInfo` method

3.10.2.6 Use of the DBMS_SESSION PL/SQL Package to Set and Clear the Client Identifier

The `DBMS_SESSION` PL/SQL package manages client identifiers on both the middle tier and the database itself.

To use the `DBMS_SESSION` package to set and clear the `CLIENT_IDENTIFIER` value on the middle tier, you must use the `SET_IDENTIFIER` and `CLEAR_IDENTIFIER` procedures.

The middle tier uses `SET_IDENTIFIER` to associate the database session with a particular user or group. Then, the `CLIENT_IDENTIFIER` is an attribute of the session and can be viewed in session information.

If you plan to use the `DBMS_SESSION.SET_IDENTIFIER` procedure, then be aware of the following:

- The maximum number of bytes for the `client_id` parameter of `DBMS_SESSION.SET_IDENTIFIER` is 64 bytes. If it exceeds 64, then the additional bytes are truncated.
- The `DBMS_APPLICATION_INFO.SET_CLIENT_INFO` procedure can overwrite the value of the client identifier. Typically, these values should be the same, so if `SET_CLIENT_INFO` is set, then its value can be automatically propagated to the value set by `SET_IDENTIFIER` if the `CLIENTID_OVERWRITE` event is set to `ON`. You can check the status of the `CLIENTID_OVERWRITE` event by running the `SHOW PARAMETER` command for the `EVENT` parameter.

For example, assuming that `CLIENTID_OVERWRITE` is enabled:

```
SHOW PARAMETER EVENT
```

NAME	TYPE	VALUE
event	string	clientid_overwrite

3.10.2.7 Enabling the CLIENTID_OVERWRITE Event System-Wide

The `ALTER SYSTEM` statement can enable the `CLIENTID_OVERWRITE` event system-wide.

1. Enter the following `ALTER SYSTEM` statement:

```
ALTER SYSTEM SET EVENTS 'CLIENTID_OVERWRITE';
```

Or, enter the following line in your `init.ora` file:

```
event="clientid_overwrite"
```

2. Connect to the CDB with the `SYSDBA` administrative privilege.

```
CONNECT / AS SYSDBA
```

3. Do one of the following:

- To restart the entire CDB:

```
SHUTDOWN IMMEDIATE
STARTUP
```

- To restart a specific PDB:

```
ALTER PLUGGABLE DATABASE pdb_name CLOSE IMMEDIATE;  
ALTER PLUGGABLE DATABASE pdb_name OPEN;
```

To find the available PDBs, query the `DBA_PDBS` data dictionary view. To check the current PDB, run the `show con_name` command.

See Also:

- [Global Application Contexts](#) for information about using client identifiers in a global application context
- *Oracle Database PL/SQL Packages and Types Reference* for more information about the `DBMS_SESSION` package

3.10.2.8 Enabling the CLIENTID_OVERWRITE Event for the Current Session

The `ALTER SESSION` statement can enable the `CLIENTID_OVERWRITE` event for the current session only.

1. Use the `ALTER SESSION` statement to set the `CLIENTID_OVERWRITE` value for the session only.

For example:

```
ALTER SESSION SET EVENTS 'CLIENTID_OVERWRITE OFF';
```

2. If you set the client identifier by using the `DBMS_APPLICATION_INFO.SET_CLIENT_INFO` procedure, then run `DBMS_SESSION.SET_IDENTIFIER` so that the client identifier settings are the same.

For example:

```
DBMS_SESSION.SET_IDENTIFIER(session_id_p);
```

3.10.2.9 Disabling the CLIENTID_OVERWRITE Event

The `ALTER SYSTEM` statement can disable the `CLIENTID_OVERWRITE` event.

1. Enter the following `ALTER SYSTEM` statement:

```
ALTER SYSTEM SET EVENTS 'CLIENTID_OVERWRITE OFF';
```

2. Restart the database.

For example:

```
SHUTDOWN IMMEDIATE  
STARTUP
```

3.11 User Authentication Data Dictionary Views

Oracle Database provides data dictionary views that list information about user authentication, such as roles that users have or profiles they use.

Table 3-4 Data Dictionary Views That Describe User Authentication

View	Description
DBA_PROFILES	Displays information about profiles, including their settings and limits
DBA_ROLES	Displays the kind of authentication used for a database role to log in to the database, such as <code>NONE</code> or <code>GLOBAL</code> (query the <code>AUTHENTICATION_TYPE</code> column)
DBA_USERS	Among other user information, displays the following: <ul style="list-style-type: none">• The kind of authentication the user used to log in to the database, such as <code>PASSWORD</code> or <code>EXTERNAL</code> (<code>AUTHENTICATION_TYPE</code> column)• The list of versions of password versions (also known as hashes) that exist for the user account (<code>PASSWORD_VERSIONS</code> column)
DBA_USERS_WITH_DEFPWD	Displays whether the user account password is a default password
PROXY_USERS	Displays users who are currently authorized to connect through a middle tier
V\$DBLINK	Displays user accounts for existing database links (<code>DB_LINK</code> , <code>OWNER_ID</code> columns); applies to the current pluggable database (PDB)
V\$PWFIL	Lists the names and granted administrative privileges of the administrative users who are included in the password file; also lists the password versions of these users
V\$SESSION	Querying the <code>USERNAME</code> column displays concurrently logged in users to the current PDB

Related Topics

- [Oracle Database Reference](#)

4

Configuring Privilege and Role Authorization

Privilege and role authorization controls the permissions that users have to perform day-to-day tasks.

- [About Privileges and Roles](#)
Authorization permits users to access, process, or alter data; it also creates limitations on user access or actions.
- [Privilege and Role Grants in a CDB](#)
The scope of a privilege and role grant in a CDB depends on where the role is being used.
- [Who Should Be Granted Privileges?](#)
You grant privileges to users so they can accomplish tasks required for their jobs.
- [How the Oracle Multitenant Option Affects Privileges](#)
All users, including common users, can exercise their privileges only within the current container.
- [Managing Administrative Privileges](#)
Administrative privileges can be used for both general and specific database operations.
- [Managing System Privileges](#)
To perform actions on schema objects, you must be granted the appropriate system privileges.
- [Managing Schema Privileges](#)
Schema privileges enable certain system privileges to be granted on a schema.
- [Administering Schema Security Policies](#)
To manage schema security policies for row level security, fine-grained auditing, and Oracle Data Redaction, users must be granted the appropriate system privilege.
- [Managing Privileges to Enable Diagnostics](#)
Only users who have the `SYSDBA` administrative privilege or the `ENABLE_DIAGNOSTICS` system privilege can enable diagnostics.
- [Managing Commonly and Locally Granted Privileges](#)
Privileges can be granted commonly for an entire CDB or application container, or granted locally to a specific PDB.
- [Managing User Roles](#)
A user role is a named collection of privileges that you can create and assign to other users.
- [Managing Common Roles and Local Roles](#)
A common role is a role that is created in the root; a local role is created in a PDB.
- [Restricting Operations on PDBs Using PDB Lockdown Profiles](#)
You can use PDB lockdown profiles to restrict sets of user operations in pluggable databases (PDBs).
- [Managing Object Privileges](#)
Object privileges enable you to perform actions on schema objects, such as tables or indexes.

- [Managing Dictionary Protection for Oracle-Maintained Schemas](#)
Oracle-maintained schemas such as `AUDSYS` have dictionary protection to prevent users from using system privileges on these schemas.
- [Table Privileges](#)
Object privileges for tables enable table security at the DML or DDL level of operation.
- [View Privileges](#)
You can apply DML object privileges to views, similar to tables.
- [Procedure Privileges](#)
The `EXECUTE` privilege enables users to run procedures and functions, either standalone or in packages.
- [Type Privileges](#)
You can control system and object privileges for types, methods, and objects.
- [Grants of User Privileges and Roles](#)
The `GRANT` statement provides privileges for a user to perform specific actions, such as executing a procedure.
- [Revokes of Privileges and Roles from a User](#)
When you revoke system or object privileges, be aware of the cascading effects of revoking a privilege.
- [Grants and Revokes of Privileges to and from the PUBLIC Role](#)
You can grant and revoke privileges and roles from the role `PUBLIC`.
- [Grants of Roles Using the Operating System or Network](#)
Using the operating system or network to manage roles can help centralize the role management in a large enterprise.
- [How Grants and Revokes Work with SET ROLE and Default Role Settings](#)
Privilege grants and the `SET ROLE` statement affect when and how grants and revokes take place.
- [Configuring Read-Only Users](#)
You can override the privileges and roles that have been granted to a user by making the user a read-only user.
- [User Privilege and Role Data Dictionary Views](#)
You can use special queries to find information about various types of privilege and role grants.

4.1 About Privileges and Roles

Authorization permits users to access, process, or alter data; it also creates limitations on user access or actions.

The limitations placed on (or removed from) users can apply to objects such as schemas, entire tables, or table rows.

A user **privilege** is the right to run a particular type of SQL statement, or the right to access an object that belongs to another user, run a PL/SQL package, and so on. The types of privileges are defined by Oracle Database.

Roles are created by users (usually administrators) to group together privileges or other roles. They are a way to facilitate the granting of multiple privileges or roles to users. In addition to granting roles to users and other roles, you can assign roles to programs by using code based access control (CBAC).

Privileges can fall into the following general categories:

- **Administrative privileges.** Administrative privileges are designed for commonly performed administrative tasks, such as performing backup and recovery operations. Oracle Database provides administrative privileges tailored to specific administrative tasks, such as the `SYSKM` administrative privilege for performing Transparent Data Encryption tasks.
- **System privileges.** System privileges enable users to perform actions on schema objects. Examples of a system privilege are the ability to create and update tables or tablespaces.
- **Roles.** A **role** groups several privileges and roles, so that they can be granted to and revoked from users simultaneously. You must enable the role for a user before the user can use it. You can embed roles by using the `SET ROLE PL/SQL` statement. See *Oracle Database SQL Language Reference*.
- **Object privileges.** Each type of object has privileges associated with it. Objects are schema objects, such as tables or indexes. Categories of object privileges are as follows:
 - **Table privileges.** These privileges enable security at the DML (data manipulation language) or DDL (data definition language) level. DML operations are `DELETE`, `INSERT`, `SELECT`, and `UPDATE` operations on tables. DDL operations are `ALTER`, `INDEX`, and `REFERENCES` operations on tables and views.
 - **View privileges.** You can apply DML object privileges to views, similar to tables.
 - **Procedure privileges.** Procedures, including standalone procedures and functions, can be granted the `EXECUTE` privilege.
 - **Type privileges.** You can grant system privileges to named types (object types, `VARRAYS`, and nested tables).
- **Read-only user and session privileges.** You can configure whether a user or session is enabled for read-write or read-only operations.

Related Topics

- [Managing Administrative Privileges](#)
Administrative privileges can be used for both general and specific database operations.
- [Managing System Privileges](#)
To perform actions on schema objects, you must be granted the appropriate system privileges.
- [Managing Commonly and Locally Granted Privileges](#)
Privileges can be granted commonly for an entire CDB or application container, or granted locally to a specific PDB.
- [Configuring Read-Only Users](#)
You can override the privileges and roles that have been granted to a user by making the user a read-only user.
- [Using Code Based Access Control for Definer's Rights and Invoker's Rights](#)
Code based access control, used to attach database roles to PL/SQL functions, procedures, or packages, works well with invoker's rights and definer's procedures.

4.2 Privilege and Role Grants in a CDB

The scope of a privilege and role grant in a CDB depends on where the role is being used.

- [About Privilege and Role Grants in a CDB](#)
User accounts in a CDB can grant and be granted roles and privileges. Roles and privileges in a CDB, however, are either locally or commonly granted.

- [Principles of Privilege and Role Grants in a CDB](#)
In a CDB, every act of granting, whether local or common, occurs within a container. The container may be the CDB root, an application root, or a PDB.
- [Privileges and Roles Granted Locally in a CDB](#)
Roles and privileges may be granted locally to users and roles *regardless* of whether the grantees, grantors, or roles being granted are local or common.
- [What Makes a Privilege or Role Grant Local](#)
To grant a role or privilege locally, use the `GRANT` statement with the `CONTAINER=CURRENT` clause, which is the default.
- [Roles and Privileges Granted Locally](#)
A user or role may be locally granted a privilege (`CONTAINER=CURRENT`).
- [Roles and Privileges Granted Commonly in a CDB](#)
Privileges and common roles may be granted commonly.
- [What Makes a Grant Common](#)
The `CONTAINER=ALL` clause specifies that the privilege or role is being granted commonly.
- [Roles and Privileges Granted Commonly](#)
A common user account or role may be granted a privilege commonly (`CONTAINER=ALL`).
- [Grants to PUBLIC in a CDB](#)
In a CDB, `PUBLIC` is a common role. In a PDB, privileges granted locally to `PUBLIC` enable all local and common user account to exercise these privileges in this PDB only.
- [Grants of Privileges and Roles: Scenario](#)
In this scenario, `SYSTEM` creates common user `c##dba` and tries to give this user privileges to query a table in the `hr` schema in `hrpdb`.

4.2.1 About Privilege and Role Grants in a CDB

User accounts in a CDB can grant and be granted roles and privileges. Roles and privileges in a CDB, however, are either locally or commonly granted.

A privilege or role granted locally is exercisable only in the PDB in which it was granted. A privilege or role granted commonly is exercisable in every existing and future PDB in the container—either the CDB or an application container—in which it was granted.

Users and roles may be common or local. However, a privilege is *in itself* neither common nor local. If a user grants a privilege locally using the `CONTAINER=CURRENT` clause, then the grantee has a privilege exercisable only in the current container. If a user connects to either the CDB root or an application root, and if this user grants a privilege commonly using the `CONTAINER=ALL` clause, then the grantee has this privilege in any existing or future PDB within the current container.

4.2.2 Principles of Privilege and Role Grants in a CDB

In a CDB, every act of granting, whether local or common, occurs within a container. The container may be the CDB root, an application root, or a PDB.

If the current container is the CDB root, then granting commonly means granting to all containers in the CDB. If the current container is an application root, however, then granting commonly means granting to all PDBs in the current application container.

The basic principles of granting are as follows:

- Both common and local phenomena may grant and be granted locally.

- Only common phenomena may grant or be granted commonly.

Local users, roles, and privileges are restricted to a particular PDB. Thus, local users may not grant roles and privileges commonly, and local roles and privileges may not be granted commonly.

The following sections describe the implications of the preceding principles.

4.2.3 Privileges and Roles Granted Locally in a CDB

Roles and privileges may be granted locally to users and roles *regardless* of whether the grantees, grantors, or roles being granted are local or common.

The following table explains the valid possibilities for locally granted roles and privileges.

Table 4-1 Local Grants

Phenomenon	May Grant Locally	May Be Granted Locally	May Receive a Role or Privilege Granted Locally
Common User	Yes	N/A	Yes
Local User	Yes	N/A	Yes
Common Role	N/A	Yes (but privileges in this role are available to the grantee only in the container in which the role was granted, regardless of whether the privileges were granted to the role locally or commonly)	Yes
Local Role	N/A	Yes (but privileges in this role are available to the grantee only in the container in which the role was granted and created)	Yes
Privilege	N/A	Yes	N/A

4.2.4 What Makes a Privilege or Role Grant Local

To grant a role or privilege locally, use the `GRANT` statement with the `CONTAINER=CURRENT` clause, which is the default.

Specifically, a role or privilege is granted locally only when the following criteria are met:

- The grantor has the necessary privileges to grant the specified role or privileges.
For system privileges and roles, the grantor must have the `ADMIN OPTION` for the role or privilege being granted. For object privileges, the grantor must have the `GRANT OPTION` for the privilege being granted.

- The grant applies to only one container.

By default, the `GRANT` statement includes the `CONTAINER=CURRENT` clause, which indicates that the privilege or role is granted locally.

Example 4-1 Granting a Privilege Locally

In this example, both `SYSTEM` and `c##hr_admin` are common users. The example connects to `hrpdb` as `SYSTEM` (which has administrator privileges), and then locally grants read privileges on the `employees` table to `c##hr_admin`. This grant applies *only* to `c##hr_admin` within `hrpdb`, not within any other PDBs.

```
CONNECT SYSTEM@hrpdb
Enter password: password
Connected.
```

```
GRANT READ ON employees TO c##hr_admin CONTAINER=CURRENT;
```

4.2.5 Roles and Privileges Granted Locally

A user or role may be locally granted a privilege (`CONTAINER=CURRENT`).

For example, a `READ ANY TABLE` privilege granted locally to a local or common user in `hrpdb` applies only to this user in this PDB.

A user or role may be locally granted a role (`CONTAINER=CURRENT`). A common role may receive a privilege granted locally. For example, the common role `c##dba` may be granted the `READ ANY TABLE` privilege locally in `hrpdb`. If the `c##cdb` common role has local privileges, then these privileges apply *only* in the container in which the role is granted. In this example, a common user who has the `c##cdb` role does not, because of a privilege granted locally to this role in `hrpdb`, have the right to exercise this privilege in any PDB other than `hrpdb`.

4.2.6 Roles and Privileges Granted Commonly in a CDB

Privileges and common roles may be granted commonly.

User accounts or roles may be granted roles and privileges commonly only if the grantees and grantors are both *common*. If a role is being granted commonly, then the role itself must be common. The following table explains the possibilities for common grants.

Table 4-2 Common Grants

Phenomenon	May Grant Commonly	May Be Granted Commonly	May Receive Roles and Privileges Granted Commonly
Common User Account	Yes	N/A	Yes
Local User Account	No	N/A	No
Common Role	N/A	Yes ¹	Yes
Local Role	N/A	No	No
Privilege	N/A	Yes	N/A

¹ Privileges that were granted commonly to a common role are available to the grantee across all containers. In addition, any privilege granted locally to a common role is available to the grantee only in the container in which that privilege was granted to the common role.

4.2.7 What Makes a Grant Common

The `CONTAINER=ALL` clause specifies that the privilege or role is being granted commonly.

A role or privilege is granted commonly when the following criteria are met:

- The grantor is a common user.
The user that performs the grant is either common to the CDB itself, or common to a specific application container.
- The grantee is a common user or common role.
The recipient of the grant is either common to the CDB itself, or common to a specific application container.
- The grantor has the necessary privileges to grant the specified role or privileges.
For system privileges and roles, the grantor must have the `ADMIN OPTION` for the role or privilege being granted. For object privileges, the grantor must have the `GRANT OPTION` for the privilege being granted.
- The grant applies to all PDBs within the container (either CDB or application container) in which the grant occurred.
The `GRANT` statement includes a `CONTAINER=ALL` clause specifying that the privilege or role is granted commonly.
- If a role is being granted, then it must be common, and if an object privilege is being granted, then the object on which the privilege is granted must be common.

Example 4-2 Granting a Privilege Commonly

In this example, both `SYSTEM` and `c##hr_admin` are common users. `SYSTEM` connects to the CDB root, and then grants the `CREATE ANY TABLE` privilege commonly to `c##hr_admin`. In this case, `c##hr_admin` can now create a table in any PDB in the CDB.

```
CONNECT SYSTEM@root
Enter password: password
Connected.
```

```
GRANT CREATE ANY TABLE TO c##hr_admin CONTAINER=ALL;
```

4.2.8 Roles and Privileges Granted Commonly

A common user account or role may be granted a privilege commonly (`CONTAINER=ALL`).

Within the context of either the CDB root or an application root, the privilege is granted to this common user account or role in all existing and future PDBs within the current container. For example, if `SYSTEM` connects to the CDB root and grants a `SELECT ANY TABLE` privilege commonly to CDB common user account `c##dba`, then the `c##dba` user has this privilege in all PDBs in the CDB. A role or privilege granted commonly cannot be revoked locally.

A user or role may receive a common role granted commonly. A common role may receive a privilege granted locally. Thus, a common user can be granted a common role, and this role may contain locally granted privileges.

For example, the common role `c##admin` may be granted the `SELECT ANY TABLE` privilege that is local to `hrpdb`. Locally granted privileges in a common role apply *only* in the container in

which the privilege was granted. Thus, the common user with the `c##admin` role does not have the right to exercise an `hrpdb`-contained privilege in `salespdb` or any PDB other than `hrpdb`.

4.2.9 Grants to PUBLIC in a CDB

In a CDB, `PUBLIC` is a common role. In a PDB, privileges granted locally to `PUBLIC` enable all local and common user account to exercise these privileges in this PDB only.

Every privilege and role granted to Oracle-supplied users and roles is granted commonly except for system privileges granted to `PUBLIC`, which are granted locally. This exception exists because you may want to revoke some grants included by default in Oracle Database, such as `EXECUTE` on the `SYS.UTL_FILE` package.

Assume that local user account `hr` exists in `hrpdb`. This user locally grants the `SELECT` privilege on `hr.employees` to `PUBLIC`. Common and local users in `hrpdb` may exercise the privilege granted to `PUBLIC`. User accounts in `salespdb` or any other PDB do not have the privilege to query `hr.employees` in `hrpdb`.

Privileges granted commonly to `PUBLIC` enable all local users to exercise the granted privilege in their respective PDBs and enable all common users to exercise this privilege in the PDBs to which they have access. Oracle recommends that users do not commonly grant privileges and roles to `PUBLIC`.

4.2.10 Grants of Privileges and Roles: Scenario

In this scenario, `SYSTEM` creates common user `c##dba` and tries to give this user privileges to query a table in the `hr` schema in `hrpdb`.

The scenario shows how the `CONTAINER` clause affects grants of roles and privileges. The first column shows operations in `CDB$ROOT`. The second column shows operations in `hrpdb`.

Table 4-3 Granting Roles and Privileges in a CDB

t	Operations in CDB\$ROOT	Operations in hrpdb	Explanation
t1	SQL> CONNECT SYSTEM@root Enter password: ***** Connected.	n/a	Common user <code>SYSTEM</code> connects to the root container.
t2	SQL> CREATE USER c##dba IDENTIFIED BY password CONTAINER=ALL;	n/a	<code>SYSTEM</code> creates common user <code>c##dba</code> . The clause <code>CONTAINER=ALL</code> makes the user a common user.

Table 4-3 (Cont.) Granting Roles and Privileges in a CDB

t	Operations in CDB\$ROOT	Operations in hrpdb	Explanation
t3	SQL> GRANT CREATE SESSION TO c##dba;	n/a	SYSTEM grants the CREATE SESSION system privilege to c##dba. Because the clause CONTAINER=ALL is absent, this privilege is granted locally and thus applies <i>only</i> to the root, which is the current container.
t4	SQL> CREATE ROLE c##admin CONTAINER=ALL;	n/a	SYSTEM creates a common role named c##admin. The clause CONTAINER=ALL makes the role a common role.
t5	SQL> GRANT SELECT ANY TABLE TO c##admin; Grant succeeded.	n/a	SYSTEM grants the SELECT ANY TABLE privilege to the c##admin role. The absence of the CONTAINER=ALL clause makes the privilege local to the root. Thus, this common role contains a privilege that is exercisable only in the root.
t6	SQL> GRANT c##admin TO c##dba; SQL> EXIT;	n/a	SYSTEM grants the c##admin role to c##dba. Because the CONTAINER=ALL clause is absent, the role applies <i>only</i> to the current container, even though it is a common role. If c##dba connects to a PDB, then c##dba does not have this role.
t7	n/a	SQL> CONNECT c##dba@hrpdb Enter password: ***** ERROR: ORA-01045: user c##dba lacks CREATE SESSION privilege; logon denied	c##dba fails to connect to hrpdb because the grant at t3 was local to the root.
t8	n/a	SQL> CONNECT SYSTEM@hrpdb Enter password: ***** Connected.	SYSTEM connects to hrpdb.

Table 4-3 (Cont.) Granting Roles and Privileges in a CDB

t	Operations in CDB\$ROOT	Operations in hrpdb	Explanation
t9	n/a	<pre>SQL> GRANT CONNECT, RESOURCE TO c##dba; Grant succeeded. SQL> EXIT</pre>	<p>SYSTEM grants the CONNECT and RESOURCE roles to common user c##dba. Because the clause CONTAINER=ALL is absent, the grant is local to hrpdb.</p>
t10	n/a	<pre>SQL> CONNECT c##dba@hrpdb Enter password: ***** Connected.</pre>	<p>Common user c##dba connects to hrpdb.</p>
t11	n/a	<pre>SQL> SELECT COUNT(*) FROM hr.employees; select * from hr.employees * ERROR at line 1: ORA-00942: table or view does not exist</pre>	<p>The query of hr.employees still returns an error because c##dba does not have select privileges on tables in hrpdb. The SELECT ANY TABLE privilege granted locally at t5 is restricted to the root and thus does not apply to hrpdb.</p>
t12	<pre>SQL> CONNECT SYSTEM@root Enter password: ***** Connected.</pre>	n/a	<p>Common user SYSTEM connects to the root container.</p>
t13	<pre>SQL> GRANT SELECT ANY TABLE TO c##admin CONTAINER=ALL; Grant succeeded.</pre>	n/a	<p>SYSTEM grants the SELECT ANY TABLE privilege to the c##admin role. The presence of CONTAINER=ALL means the privilege is being granted commonly.</p>
t14	n/a	<pre>SQL> SELECT COUNT(*) FROM hr.employees; select * from hr.employees * ERROR at line 1: ORA-00942: table or view does not exist</pre>	<p>A query of hr.employees still returns an error. The reason is that at t6 the c##admin common role was granted to c##dba in the root only.</p>

Table 4-3 (Cont.) Granting Roles and Privileges in a CDB

t	Operations in CDB\$ROOT	Operations in hrpdb	Explanation
t15	<pre>SQL> GRANT c##admin TO c##dba CONTAINER=ALL; Grant succeeded.</pre>	n/a	<p>SYSTEM grants the common role named c##admin to c##dba, specifying CONTAINER=ALL. Now user c##dba has the role in <i>all</i> containers, not just the root.</p>
t17	n/a	<pre>SQL> SELECT COUNT(*) FROM hr.employees; COUNT(*) ----- 107</pre>	The query succeeds.

4.3 Who Should Be Granted Privileges?

You grant privileges to users so they can accomplish tasks required for their jobs.

You should grant a privilege only to a user who requires that privilege to accomplish the necessary work. Excessive granting of unnecessary privileges can compromise security. For example, you never should grant `SYSDBA` or `SYSOPER` administrative privilege to users who do not perform administrative tasks.

You can grant privileges to a user in two ways:

- **You can grant privileges to users explicitly.** For example, you can explicitly grant to user `psmith` the privilege to insert records into the `employees` table.
- **You can grant privileges to a role (a named group of privileges), and then grant the role to one or more users.** For example, you can grant the privileges to select, insert, update, and delete records from the `employees` table to the role named `clerk`, which in turn you can grant to users `psmith` and `robert`.

Because roles allow for easier and better management of privileges, you should usually grant privileges to roles and not to specific users.

See Also:

- [Guidelines for Securing User Accounts and Privileges](#) for best practices to follow when granting privileges
- *Oracle Database Vault Administrator's Guide* if you are concerned about excessive privilege grants
- *Oracle Database SQL Language Reference* for the complete list of system privileges and their descriptions

4.4 How the Oracle Multitenant Option Affects Privileges

All users, including common users, can exercise their privileges only within the current container.

However, a user connected to the root can perform certain operations that affect other pluggable databases (PDBs). These operations include `ALTER PLUGGABLE DATABASE`, `CREATE USER`, `CREATE ROLE`, and `ALTER USER`. The common user must possess the commonly granted privileges that enable these operations. A common user connected to the root can see metadata pertaining to PDBs by way of the container data objects (for example, multitenant container database (CDB) views and `V$` views) in the root, provided that the common user has been granted privileges required to access these views and their `CONTAINER_DATA` attribute has been set to allow seeing data about various PDBs. The common user cannot query tables or views in a PDB.

Common users cannot exercise their privileges across other PDBs. They must first switch to the PDB that they want, and then exercise their privileges from there. To switch to a different container, the common user must have the `SET CONTAINER` privilege. The `SET CONTAINER` privilege must be granted either commonly or in the container to which the user is attempting to switch. Alternatively, the common user can start a new database session whose initial current container is the container this user wants, relying on the `CREATE SESSION` privilege in that PDB.

Be aware that commonly granted privileges may interfere with the security configured for individual PDBs. For example, suppose an application PDB database administrator wants to prevent any user in the PDB from modifying a particular application common object. A privilege (such as `UPDATE`) granted commonly to `PUBLIC` or to a common user or common role on the object would circumvent the PDB database administrator's intent.

Related Topics

- [Enabling Common Users to View `CONTAINER_DATA` Object Information](#)
Common users can view information about `CONTAINER_DATA` objects in the root or for data in specific PDBs.

4.5 Managing Administrative Privileges

Administrative privileges can be used for both general and specific database operations.

- [About Administrative Privileges](#)
For better separation of duty, Oracle Database provides administrative privileges that are tailored for commonly performed specific administrative tasks.
- [Grants of Administrative Privileges to Users](#)
As with all powerful privileges, grant administrative privileges to only trusted users.
- [`SYSDBA` and `SYSOPER` Privileges for Standard Database Operations](#)
The `SYSDBA` and `SYSOPER` administrative privileges enable you to perform standard database operations.
- [Forcing oracle Users to Enter a Password When Logging in as `SYSDBA`](#)
You can force an `oracle` user to enter a password when the user logs in to an Oracle database using the `SYSDBA` administrative privilege.
- [`SYSBACKUP` Administrative Privilege for Backup and Recovery Operations](#)
The `SYSBACKUP` administrative privilege is used to perform backup and recovery operations from either Oracle Recovery Manager (RMAN) and or through SQL*Plus.

- [SYSDG Administrative Privilege for Oracle Data Guard Operations](#)
You can log in as user `SYSDG` with the `SYSDG` administrative privilege to perform Data Guard operations.
- [SYSKM Administrative Privilege for Transparent Data Encryption](#)
The `SYSKM` administrative privilege enables the `SYSKM` user to manage Transparent Data Encryption (TDE) wallet operations.
- [SYSRAC Administrative Privilege for Oracle Real Application Clusters](#)
The `SYSRAC` administrative privilege is used by the Oracle Real Application Clusters (Oracle RAC) Clusterware agent.

4.5.1 About Administrative Privileges

For better separation of duty, Oracle Database provides administrative privileges that are tailored for commonly performed specific administrative tasks.

These tasks include operations for backup and recovery, Oracle Data Guard, and encryption key management for Transparent Data Encryption (TDE).

You can find the administrative privileges that a user has by querying the `V$PWFILE_USERS` dynamic view, which lists users in the password file.

In previous releases, you needed to have the `SYSDBA` administrative privilege to perform these tasks. To support backward compatibility, you still can use the `SYSDBA` privilege for these tasks, but Oracle recommends that you use the administrative privileges described in this section.

Users who have been granted administrative privileges can be altered to be schema-only accounts.

The use of administrative privileges is mandatorily audited.

Related Topics

- [Auditing Administrative Users](#)
You can create unified audit policies to capture the actions of administrative user accounts, such as `SYS`.

4.5.2 Grants of Administrative Privileges to Users

As with all powerful privileges, grant administrative privileges to only trusted users.

However, be aware that there is a restriction for users whose names have non-ASCII characters (for example, the umlaut in the name `HÜBER`). You can grant administrative privileges to these users, but if the Oracle database instance is down, the authentication using the granted privilege is not supported if the user name has non-ASCII characters. If the database instance is up, then the authentication is supported.

4.5.3 SYSDBA and SYSOPER Privileges for Standard Database Operations

The `SYSDBA` and `SYSOPER` administrative privileges enable you to perform standard database operations.

These database operations can include tasks such as database startups and shutdowns, creating the server parameter file (`SPFILE`), or altering the database archive log. You can grant the `SYSDBA` and `SYSOPER` administrative privileges to application common users (but not to CDB common users).

By default, the underlying schemas for `SYSDBA` and `SYSOPER` are dictionary protected. This protection prevents other users from using system privileges (including `ANY` privileges) on these schemas. In addition, you cannot create objects in these schemas.

You can find if a user has been granted an administrative privilege on a local (PDB) level, for a CDB root, or for an application root by querying the `SCOPE` column of the `V$PWFILE_USERS` dynamic view.

You can grant the `SYSDBA` or `SYSOPER` administrative privilege to users who have been created with no authentication.

4.5.4 Forcing oracle Users to Enter a Password When Logging in as SYSDBA

You can force an oracle user to enter a password when the user logs in to an Oracle database using the `SYSDBA` administrative privilege.

1. Edit the `$ORACLE_HOME/network/admin/sqlnet.ora` file.
2. Set the `SQLNET.AUTHENTICATION_SERVICES` parameter as follows:

```
sqlnet.authentication_services=none
```

If `SQLNET.AUTHENTICATION_SERVICES` is not set, then it defaults to `ALL`.

4.5.5 SYSBACKUP Administrative Privilege for Backup and Recovery Operations

The `SYSBACKUP` administrative privilege is used to perform backup and recovery operations from either Oracle Recovery Manager (RMAN) and or through SQL*Plus.

By default, the underlying schema for `SYSBACKUP` is dictionary protected. This protection prevents other users from using system privileges (including `ANY` privileges) on this schema. In addition, you cannot create objects in this schema.

To connect to the database as `SYSBACKUP` using a password, you must create a password file for it.

You cannot grant the `SYSBACKUP` administrative privilege to users who have been created with no authentication.

This privilege enables you to perform the following operations:

- `STARTUP`
- `SHUTDOWN`
- `ALTER DATABASE`
- `ALTER SYSTEM`
- `ALTER SESSION`
- `ALTER TABLESPACE`
- `CREATE CONTROLFILE`
- `CREATE ANY DIRECTORY`

- CREATE ANY TABLE
- CREATE ANY CLUSTER
- CREATE PROFILE
- CREATE RESTORE POINT (including GUARANTEED restore points)
- CREATE SESSION
- CREATE SPFILE
- DROP DATABASE
- DROP TABLESPACE
- DROP RESTORE POINT (including GUARANTEED restore points)
- FLASHBACK DATABASE
- RESUMABLE
- UNLIMITED TABLESPACE
- SELECT ANY DICTIONARY
- SELECT ANY TRANSACTION
- SELECT
 - X\$ tables (that is, the fixed tables)
 - V\$ and GV\$ views (that is, the dynamic performance views)
 - APPQOSSYS.WLM_CLASSIFIER_PLAN
 - SYSTEM.LOGSTDBY\$PARAMETERS
- DELETE/INSERT
 - SYS.APPLY\$_SOURCE_SCHEMA
 - SYSTEM.LOGSTDBY\$PARAMETERS
- EXECUTE
 - SYS.DBMS_BACKUP_RESTORE
 - SYS.DBMS_RCVMAN
 - SYS.DBMS_DATAPUMP
 - SYS.DBMS_IR
 - SYS.DBMS_PIPE
 - SYS.SYS_ERROR
 - SYS.DBMS_TTS
 - SYS.DBMS_TDB
 - SYS.DBMS_PLUGTS
 - SYS.DBMS_PLUGTSP
- SELECT_CATALOG_ROLE

In addition, the SYSBACKUP privilege enables you to connect to the database even if the database is not open.

Related Topics

- *Oracle Database Administrator's Guide*
- *Oracle Database Backup and Recovery User's Guide*

4.5.6 SYSDBG Administrative Privilege for Oracle Data Guard Operations

You can log in as user `SYSDBG` with the `SYSDBG` administrative privilege to perform Data Guard operations.

By default, the underlying schema for `SYSDBG` is dictionary protected. This protection prevents other users from using system privileges (including `ANY` privileges) on this schema. In addition, you cannot create objects in this schema.

You can use this privilege with either Data Guard Broker or the `DGMGRL` command-line interface. In order to connect to the database as `SYSDBG` using a password, you must create a password file for it.

You cannot grant the `SYSDBG` administrative privilege to users who have been created with no authentication.

The `SYSDBG` privilege enables the following operations:

- `STARTUP`
- `SHUTDOWN`
- `ALTER DATABASE`
- `ALTER SESSION`
- `ALTER SYSTEM`
- `CREATE RESTORE POINT` (including `GUARANTEED` restore points)
- `CREATE SESSION`
- `DROP RESTORE POINT` (including `GUARANTEED` restore points)
- `FLASHBACK DATABASE`
- `SELECT ANY DICTIONARY`
- `SELECT`
 - `X$` tables (that is, the fixed tables)
 - `V$` and `GV$` views (that is, the dynamic performance views)
 - `APPQOSSYS.WLM_CLASSIFIER_PLAN`
- `DELETE`
 - `APPQOSSYS.WLM_CLASSIFIER_PLAN`
- `EXECUTE`
 - `SYS.DBMS_DRS`

In addition, the `SYSDBG` privilege enables you to connect to the database even if it is not open.

Related Topics

- *Oracle Database Administrator's Guide*
- *Oracle Data Guard Concepts and Administration*

4.5.7 SYSKM Administrative Privilege for Transparent Data Encryption

The `SYSKM` administrative privilege enables the `SYSKM` user to manage Transparent Data Encryption (TDE) wallet operations.

By default, the underlying schema for `SYSKM` is dictionary protected. This protection prevents other users from using system privileges (including `ANY` privileges) on this schema. In addition, you cannot create objects in this schema.

In order to connect to the database as `SYSKM` using a password, you must create a password file for it.

You cannot grant the `SYSKM` administrative privilege to users who have been created with no authentication.

The `SYSKM` administrative privilege enables the following operations:

- `ADMINISTER KEY MANAGEMENT`
- `CREATE SESSION`
- `SELECT` (only when database is open)
 - `SYS.V$ENCRYPTED_TABLESPACES`
 - `SYS.V$ENCRYPTION_WALLET`
 - `SYS.V$WALLET`
 - `SYS.V$ENCRYPTION_KEYS`
 - `SYS.V$CLIENT_SECRETS`
 - `SYS.DBA_ENCRYPTION_KEY_USAGE`

In addition, the `SYSKM` privilege enables you to connect to the database even if it is not open.

Related Topics

- *Oracle Database Administrator's Guide*
- *Oracle Database Advanced Security Guide*

4.5.8 SYSRAC Administrative Privilege for Oracle Real Application Clusters

The `SYSRAC` administrative privilege is used by the Oracle Real Application Clusters (Oracle RAC) Clusterware agent.

By default, the underlying schema for `SYSRAC` is dictionary protected. This protection prevents other users from using system privileges (including `ANY` privileges) on this schema. In addition, you cannot create objects in this schema.

The `SYSRAC` administrative privilege provides only the minimal privileges necessary for performing day-to-day Oracle RAC operations. For example, this privilege is used for Oracle RAC utilities such as `SRVCTL`.

You cannot grant the `SYSRAC` administrative privilege to users who have been created with no authentication.

The `SYSRAC` administrative privilege enables the following operations:

- `STARTUP`

- SHUTDOWN
- ALTER DATABASE MOUNT
- ALTER DATABASE OPEN
- ALTER DATABASE OPEN READ ONLY
- ALTER DATABASE CLOSE NORMAL
- ALTER DATABASE DISMOUNT
- ALTER SESSION SET EVENTS
- ALTER SESSION SET `_NOTIFY_CRS`
- ALTER SESSION SET CONTAINER
- ALTER SYSTEM REGISTER
- ALTER SYSTEM SET `local_listener|remote_listener|listener_networks`

In addition to these privileges, the SYSRAC user will have access to the following views:

- V\$PARAMETER
- V\$DATABASE
- V\$PDBS
- CDB_SERVICE\$
- DBA_SERVICES
- V\$ACTIVE_SERVICES
- V\$SERVICES

The SYSRAC user is also granted the EXECUTE privilege for the following PL/SQL packages:

- DBMS_DRS
- DBMS_SERVICE
- DBMS_SERVICE_PRIVT
- DBMS_SESSION
- DBMS_HA_ALERTS_PRIVT
- Dequeue messaging `SYS.SYS$SERVICE_METRICS`

Related Topics

- *Oracle Database Administrator's Guide*
- *Oracle Real Application Clusters Administration and Deployment Guide*

4.6 Managing System Privileges

To perform actions on schema objects, you must be granted the appropriate system privileges.

- [About System Privileges](#)
A system privilege is the right to perform an action or to perform actions on schema objects.

- [Who Can Grant or Revoke System Privileges?](#)
Only two types of users can grant system privileges to other users or revoke those privileges from them.
- [Why Is It Important to Restrict System Privileges?](#)
System privileges are very powerful, so only grant them to trusted users. You should also secure the data dictionary and `SYS` schema objects.
- [Grants and Revokes of System Privileges](#)
You can grant or revoke system privileges to users and roles.
- [About ANY Privileges and the PUBLIC Role](#)
System privileges that use the `ANY` keyword enable you to set privileges for an entire category of objects in the database.

4.6.1 About System Privileges

A system privilege is the right to perform an action or to perform actions on schema objects.

For example, the privileges to create tablespaces and to delete the rows of any table in a database are system privileges.

There are many different kinds of system privileges. Each system privilege allows a user to perform a particular database operation or class of database operations. *Remember that system privileges are very powerful.* Only grant them when necessary to roles and trusted users of the database. To find the system privileges that have been granted to a user, you can query the `DBA_SYS_PRIVS` data dictionary view.

If you want to restrict a system privilege to a specific schema, then you can do so by granting it as a schema privilege. A schema privilege enables you to grant a specific system privilege on a schema without having to perform a grant on every object within the schema.

System privileges such as `SELECT ANY TABLE` do not work on `SYS` objects or other objects that are owned by schemas that are marked as `DICTIONARY PROTECTED`.

Related Topics

- [How Commonly Granted System Privileges Work](#)
Users can exercise system privileges only within the PDB in which they were granted.
- [Managing Schema Privileges](#)
Schema privileges enable certain system privileges to be granted on a schema.
- [Oracle Database SQL Language Reference](#)

4.6.2 Who Can Grant or Revoke System Privileges?

Only two types of users can grant system privileges to other users or revoke those privileges from them.

These users are as follows:

- Users who were granted a specific system privilege with the `ADMIN OPTION`
- Users with the system privilege `GRANT ANY PRIVILEGE`

For this reason, only grant these privileges to trusted users.

4.6.3 Why Is It Important to Restrict System Privileges?

System privileges are very powerful, so only grant them to trusted users. You should also secure the data dictionary and `SYS` schema objects.

- [About the Importance of Restricting System Privileges](#)
System privileges are very powerful, so by default the database is configured to prevent typical (non-administrative) users from exercising the `ANY` system privileges.
- [User Access to Objects in the SYS Schema](#)
Users with explicit object privileges or those who connect with administrative privileges (`SYSDBA`) can access objects in the `SYS` schema.

4.6.3.1 About the Importance of Restricting System Privileges

System privileges are very powerful, so by default the database is configured to prevent typical (non-administrative) users from exercising the `ANY` system privileges.

For example, users are prevented from exercising `ANY` system privileges such as `UPDATE ANY TABLE` on the data dictionary.

Related Topics

- [Guidelines for Securing User Accounts and Privileges](#)
Oracle provides guidelines to secure user accounts and privileges.

4.6.3.2 User Access to Objects in the SYS Schema

Users with explicit object privileges or those who connect with administrative privileges (`SYSDBA`) can access objects in the `SYS` schema.

The following table lists roles that you can grant to users who need access to objects in the `SYS` schema.

Table 4-4 Roles to Allow Access to SYS Schema Objects

Role	Description
<code>SELECT_CATALOG_ROLE</code>	Grant this role to allow users <code>SELECT</code> privileges on data dictionary views.
<code>EXECUTE_CATALOG_ROLE</code>	Grant this role to allow users <code>EXECUTE</code> privileges for packages and procedures in the data dictionary.

Additionally, you can grant the `SELECT ANY DICTIONARY` system privilege to users who require access to tables created in the `SYS` schema. This system privilege allows query access to any object in the `SYS` schema, including tables created in that schema. It must be granted individually to each user requiring the privilege. It is not included in `GRANT ALL PRIVILEGES`, but it can be granted through a role.

**Note:**

You should grant these roles and the `SELECT ANY DICTIONARY` system privilege with extreme care, because the integrity of your system can be compromised by their misuse.

4.6.4 Grants and Revokes of System Privileges

You can grant or revoke system privileges to users and roles.

If you grant system privileges to roles, then you can use the roles to exercise system privileges. For example, roles permit privileges to be made selectively available. Ensure that you follow separation of duty guidelines for securing roles.

Use either of the following methods to grant or revoke system privileges to or from users and roles:

- `GRANT` and `REVOKE` SQL statements
- Oracle Enterprise Manager Cloud Control

Related Topics

- [Guidelines for Securing Roles](#)
Oracle provides guidelines for role management.
- [User Privilege and Role Data Dictionary Views](#)
You can use special queries to find information about various types of privilege and role grants.

4.6.5 About ANY Privileges and the PUBLIC Role

System privileges that use the `ANY` keyword enable you to set privileges for an entire category of objects in the database.

For example, the `CREATE ANY PROCEDURE` system privilege permits a user to create a procedure anywhere in the database. The behavior of an object created by users with the `ANY` privilege is not restricted to the schema in which it was created. For example, if user `JSMITH` has the `CREATE ANY PROCEDURE` privilege and creates a procedure in the schema `JONES`, then the procedure will run as `JONES`. However, `JONES` may not be aware that the procedure `JSMITH` created is running as `JONES`. If `JONES` has `DBA` privileges, letting `JSMITH` run a procedure as `JONES` could pose a security violation.

The `PUBLIC` role is a special role that every database user account automatically has when the account is created. By default, it has no privileges granted to it, but it does have numerous grants, mostly to Java objects. You cannot drop the `PUBLIC` role, and a manual grant or revoke of this role has no meaning, because the user account will always assume this role. Because all database user accounts assume the `PUBLIC` role, it does not appear in the `DBA_ROLES` and `SESSION_ROLES` data dictionary views.

You can grant privileges to the `PUBLIC` role, but remember that this makes the privileges available to every user in the Oracle database. For this reason, be careful about granting privileges to the `PUBLIC` role, particularly powerful privileges such as the `ANY` privileges and system privileges. For example, if `JSMITH` has the `CREATE PUBLIC SYNONYM` system privilege, `JSMITH` could redefine an interface that they know everyone else uses, and then point to it with

the `PUBLIC SYNONYM` that `JSMITH` created. Instead of accessing the correct interface, users would access the interface of `JSMITH`, which could possibly perform illegal activities such as stealing the login credentials of users.

These types of privileges are very powerful and could pose a security risk if given to the wrong person. Be careful about granting privileges using `ANY` or `PUBLIC`. As with all privileges, you should follow the principles of "least privilege" when granting these privileges to users.

Related Topics

- [Guidelines for Securing a Database Installation and Configuration](#)
Oracle provides guidelines to secure the database installation and configuration.

4.7 Managing Schema Privileges

Schema privileges enable certain system privileges to be granted on a schema.

- [About Managing Schema Privileges](#)
When a schema privilege is granted on a schema, the grantee has the system privilege on all the objects in the schema on which the grant has been made.
- [Privileges That Are Excluded from Schema Privilege Grants](#)
Many administrative and system privileges cannot be used in schema privilege grants.
- [Granting a Schema Privilege](#)
You can use the `GRANT` statement to grant a schema privilege to a user or a role.
- [Revoking a Schema Privilege](#)
You can use the `REVOKE` statement to revoke a schema privilege from a user or a role.

4.7.1 About Managing Schema Privileges

When a schema privilege is granted on a schema, the grantee has the system privilege on all the objects in the schema on which the grant has been made.

The system privilege applies to both current and future objects in the schema. For example, suppose you grant the `CREATE ANY TABLE` system privilege to user `psmith` for use on the `HR` schema. User `psmith` is then able to create tables in the `HR` schema and not in any other schema for which `psmith` does not have permission. You can grant the schema privilege to either users or roles. Schema privilege grants can be used on a wide range of system privileges, though not all. In addition, you cannot use schema privileges on the `SYS` schema. Because this grant provides powerful privileges to the grantee, ensure that you grant the schema privilege to trusted users only.

Granting users schema privileges has the following benefits:

- Granting schema privileges instead of system privileges allows use of the principle of least privilege. Granting a system privilege could be unnecessarily permissive, because it allows the same privilege on any object in any schema in the database, whereas by granting only a schema privilege to a user or role, the user or role would be granted the least privilege necessary to accomplish their task. Hence, this approach makes the database more secure.
- This type of privilege grant makes the granting of privileges much easier. Rather than having to grant the system or object privilege individually to a user, an administrator can grant the privilege to the schema so that all objects within the schema are accessible to the user.

To grant or revoke schema privileges, you must have the `GRANT ANY SCHEMA PRIVILEGE` or the `GRANT ANY PRIVILEGE` system privilege.

The `ANY` system privileges that you can include in the schema grants cover operations such as creation, altering, executing, dropping of objects.

The *Oracle Database SQL Language Reference* provides a list of the available system privileges that you can grant as schema privileges.

To find information about schema privilege grants, query the following data dictionary views:

- `DBA_SCHEMA_PRIVS`
- `ROLE_SCHEMA_PRIVS`
- `USER_SCHEMA_PRIVS`
- `SESSION_SCHEMA_PRIVS`
- `V$ENABLEDSCHEMAPRIVS`

Related Topics

- [Privileges That Are Excluded from Schema Privilege Grants](#)
Many administrative and system privileges cannot be used in schema privilege grants.
- [Administering Schema Security Policies](#)
To manage schema security policies for row level security, fine-grained auditing, and Oracle Data Redaction, users must be granted the appropriate system privilege.
- [Data Dictionary Views to Find Information about Privilege and Role Grants](#)
Oracle Database provides data dictionary views that describe privilege and role grants.

4.7.2 Privileges That Are Excluded from Schema Privilege Grants

Many administrative and system privileges cannot be used in schema privilege grants.

The following administrative privileges are excluded from schema privilege grants:

- `SYSDBA`
- `SYSOPER`
- `SYSASM`
- `SYSBACKUP`
- `SYSDG`
- `SYSKM`

The following table lists system privileges that are excluded from schema privilege grants.

Table 4-5 System Privileges Excluded from Schema Privileges

System Privilege Type	Privilege
Advisor framework	<ul style="list-style-type: none"> • <code>ADVISOR</code> • <code>ADMINISTER SQL TUNING SET</code>
Application context	<ul style="list-style-type: none"> • <code>CREATE ANY CONTEXT</code> • <code>DROP ANY CONTEXT</code>

Table 4-5 (Cont.) System Privileges Excluded from Schema Privileges

System Privilege Type	Privilege
Application continuity	<ul style="list-style-type: none"> • KEEP DATE TIME • KEEP SYSGUID
Database change notification	<ul style="list-style-type: none"> • CHANGE NOTIFICATION
Database links	<ul style="list-style-type: none"> • CREATE DATABASE LINK • CREATE PUBLIC DATABASE LINK • DROP PUBLIC DATABASE LINK
Database triggers	<ul style="list-style-type: none"> • ADMINISTER DATABASE TRIGGER
Debugging	<ul style="list-style-type: none"> • DEBUG CONNECT SESSION
Dictionary protection	<ul style="list-style-type: none"> • SELECT ANY DICTIONARY • ANALYZE ANY DICTIONARY
Directories	<ul style="list-style-type: none"> • CREATE ANY DIRECTORY • DROP ANY DIRECTORY • READ • WRITE
Editions	<ul style="list-style-type: none"> • CREATE ANY EDITION • DROP ANY EDITION
Exports and imports	<ul style="list-style-type: none"> • EXPORT FULL DATABASE • IMPORT FULL DATABASE
Flashback	<ul style="list-style-type: none"> • FLASHBACK ARCHIVE ADMINISTER • SELECT ANY TRANSACTION
Key management	<ul style="list-style-type: none"> • ADMINISTER KEY MANAGEMENT
Logminer	<ul style="list-style-type: none"> • LOGMINING
Plan management	<ul style="list-style-type: none"> • ADMINISTER SQL MANAGEMENT OBJECT
Pluggable databases	<ul style="list-style-type: none"> • CREATE PLUGGABLE DATABASE • SET CONTAINER
Profiles	<ul style="list-style-type: none"> • CREATE PROFILE • ALTER PROFILE • DROP PROFILE
Public synonyms	<ul style="list-style-type: none"> • CREATE PUBLIC SYNONYM • DROP PUBLIC SYNONYM
Recycle bin	<ul style="list-style-type: none"> • PURGE DBA_RECYCLEBIN
Resource management	<ul style="list-style-type: none"> • ADMINISTER RESOURCE MANAGER
Resumable space allocation	<ul style="list-style-type: none"> • RESUMABLE
Roles	<ul style="list-style-type: none"> • CREATE ROLE • DROP ANY ROLE • GRANT ANY ROLE • ALTER ANY ROLE

Table 4-5 (Cont.) System Privileges Excluded from Schema Privileges

System Privilege Type	Privilege
Rollback segment	<ul style="list-style-type: none"> • CREATE ROLLBACK SEGMENT • ALTER ROLLBACK SEGMENT • DROP ROLLBACK SEGMENT
Sessions	<ul style="list-style-type: none"> • CREATE SESSION • ALTER SESSION • RESTRICT SESSION
Stored outlines	<ul style="list-style-type: none"> • CREATE ANY OUTLINE • ALTER ANY OUTLINE • DROP ANY OUTLINE
System	<ul style="list-style-type: none"> • ALTER DATABASE • ALTER SYSTEM • AUDIT SYSTEM • ALTER RESOURCE COST
Tablespaces	<ul style="list-style-type: none"> • CREATE TABLESPACE • ALTER TABLESPACE • MANAGE TABLESPACE • DROP TABLESPACE • UNLIMITED TABLESPACE
Transactions	<ul style="list-style-type: none"> • FORCE TRANSACTION • FORCE ANY TRANSACTION
Users	<ul style="list-style-type: none"> • CREATE USER • BECOME USER • ALTER USER • DROP USER

4.7.3 Granting a Schema Privilege

You can use the `GRANT` statement to grant a schema privilege to a user or a role.

1. Log in to the CDB root or to a PDB as a user who has been granted the `GRANT ANY SCHEMA PRIVILEGE` or `GRANT ANY PRIVILEGE` system privilege.
2. To find the available schema privileges that you can grant, see *Oracle Database SQL Language Reference*.
3. Grant the schema privilege to the user or role.

For example, suppose you grant the `SELECT ANY TABLE` system privilege to user `psmith` for use on the `HR` schema. User `psmith` is then able to select from existing and future tables that are created in the `HR` schema.

```
GRANT SELECT ANY TABLE ON SCHEMA HR TO psmith;
```

If you have the `GRANT ANY SCHEMA PRIVILEGE WITH ADMIN OPTION` privilege, then you can do two additional types of grants:

- Grant `GRANT ANY SCHEMA PRIVILEGE` to another user.

- Grant a schema privilege `WITH ADMIN OPTION`, so that the user can grant the schema privilege to another user.

4.7.4 Revoking a Schema Privilege

You can use the `REVOKE` statement to revoke a schema privilege from a user or a role.

1. Log in to the CDB root or to a PDB as a user who has been granted the `GRANT ANY SCHEMA PRIVILEGE` system privilege with `WITH ADMIN OPTION`.
2. To find the schema privileges that have been granted to the user or role, run a query similar to the following:

For example:

```
SELECT PRIVILEGE, SCHEMA FROM DBA_SCHEMA_PRIVS
WHERE GRANTEE = 'PSMITH';
```

Output similar to the following appears:

```
PRIVILEGE          SCHEMA
-----
SELECT ANY TABLE HR
```

3. Revoke the schema privileges from the user or role.

For example, to revoke the `SELECT ANY TABLE` schema privilege from user `psmith`:

```
REVOKE SELECT ANY TABLE ON SCHEMA HR FROM psmith;
```

4.8 Administering Schema Security Policies

To manage schema security policies for row level security, fine-grained auditing, and Oracle Data Redaction, users must be granted the appropriate system privilege.

- [About Administering Schema System Security Policies](#)
Security policies for row level security, fine-grained auditing, and Oracle Data Redaction require special schema-related system privileges.
- [Granting an Administrator Schema Security Policy](#)
You can use the `GRANT` statement to grant a schema system privilege to a user or role.
- [Revoking an Administrator Security Policy](#)
You can use the `REVOKE` statement to revoke a schema system privilege from a user or role.

4.8.1 About Administering Schema System Security Policies

Security policies for row level security, fine-grained auditing, and Oracle Data Redaction require special schema-related system privileges.

The system privileges and their corresponding PL/SQL packages that the user must be granted are as follows:

- `ADMINISTER ROW LEVEL SECURITY POLICY` system privilege, for use with the `DBMS_RLS` PL/SQL package
- `ADMINISTER FINE GRAINED AUDIT POLICY` system privilege, for use with the `DBMS_FGA` PL/SQL package
- `ADMINISTER REDACTION POLICY` system privilege, for use with the `DBMS_REDACT` PL/SQL package

You must grant the system privilege to the user in addition to the other required privileges that are needed for the security policy, such as the `EXECUTE` privilege on any PL/SQL packages. You can grant the system privilege in either of the following ways:

- If the security policy is to apply to all non-SYS schemas across the database, then use the following syntax:

```
GRANT system_privilege TO grantee;
```

- If the security policy is to be restricted to a specific schema, then use this syntax:

```
GRANT system_privilege ON SCHEMA schema TO grantee;
```

4.8.2 Granting an Administrator Schema Security Policy

You can use the `GRANT` statement to grant a schema system privilege to a user or role.

1. Log in to the CDB root or to a PDB as a user who has been granted the `GRANT ANY SCHEMA PRIVILEGE` system privilege with `WITH ADMIN OPTION`.
2. Grant the user the `EXECUTE` privilege on the PL/SQL package (and any other necessary privileges) to administer the security policy.

For example, for a user who is responsible for creating row level security policies:

```
GRANT EXECUTE ON DBMS_RLS TO preston;
```

3. Grant the user the schema system privilege.

For example, to restrict row level security policies to the `HR` schema:

```
GRANT ADMINISTER ROW LEVEL SECURITY POLICY ON SCHEMA HR TO preston;
```

To enable the user to create the policy in any non-SYS schema in the database:

```
GRANT ADMINISTER ROW LEVEL SECURITY POLICY TO preston;
```

4.8.3 Revoking an Administrator Security Policy

You can use the `REVOKE` statement to revoke a schema system privilege from a user or role.

1. Log in to the CDB root or to a PDB as a user who has been granted the `GRANT ANY SCHEMA PRIVILEGE` system privilege with `WITH ADMIN OPTION`.
2. To find the system privileges that have been granted to the user or role, run a query similar to the following:

For example:

```
SELECT PRIVILEGE FROM DBA_SYS_PRIVS_ALL WHERE GRANTEE = 'PRESTON';
```

Output similar to the following appears:

```
PRIVILEGE
-----
ADMINISTER ROW LEVEL SECURITY POLICY
```

3. Revoke the system privilege from the user or role.

For example:

```
REVOKE ADMINISTER ROW LEVEL SECURITY POLICY ON SCHEMA HR FROM preston;
```

Or:

```
REVOKE ADMINISTER ROW LEVEL SECURITY POLICY FROM preston;
```

4. Revoke any other privileges as necessary, such as the `EXECUTE` privilege on the associated PL/SQL package.

For example:

```
REVOKE EXECUTE ON DBMS_RLS FROM preston;
```

4.9 Managing Privileges to Enable Diagnostics

Only users who have the `SYSDBA` administrative privilege or the `ENABLE_DIAGNOSTICS` system privilege can enable diagnostics.

The kinds of diagnostics that you can restrict control of include the following: `debug-events` (`events++`, `error-numbers`) and `debug-actions` through `ALTER SESSION` and `ALTER SYSTEM` operations.

- To control the ability of users to perform these types of diagnostics, set the `DIAGNOSTICS_CONTROL` initialization parameter in the initialization file.

`DIAGNOSTICS_CONTROL` values are as follows:

- **ERROR:** If a user who does not have the `SYSDBA` or `ENABLE_DIAGNOSTICS` privilege attempts to enable a diagnostic, then the attempt will fail and an `ORA-01031: insufficient privileges` error appears.
- **WARNING:** A user who does not have the `SYSDBA` or `ENABLE_DIAGNOSTICS` privilege will be able to enable a diagnostic, but a warning message is written to an alert log. The warning message is similar to the following:

```
User 'USERNAME' has set the following debug-event(s) on the event-group
'session':
```

```
1357 trace name context forever, level 2
```

In this message, the `session` keyword is used if the user run an `ALTER SESSION` statement. If the user runs an `ALTER SYSTEM` statement, then the keyword is `system`.

- IGNORE: The user can perform the diagnostic task without any error messages appearing. This setting is the default.

4.10 Managing Commonly and Locally Granted Privileges

Privileges can be granted commonly for an entire CDB or application container, or granted locally to a specific PDB.

- [About Commonly and Locally Granted Privileges](#)
Both common users and local users can grant privileges to one another.
- [How Commonly Granted System Privileges Work](#)
Users can exercise system privileges only within the PDB in which they were granted.
- [How Commonly Granted Object Privileges Work](#)
Object privileges on common objects applies to the object as well as all associated links on this common object.
- [Granting or Revoking Privileges to Access a PDB](#)
You can grant and revoke privileges for PDB access.
- [Example: Granting a Privilege to a Common User](#)
You must use the GRANT statement in the root to grant privileges to a common user.
- [Enabling Common Users to View CONTAINER_DATA Object Information](#)
Common users can view information about CONTAINER_DATA objects in the root or for data in specific PDBs.

4.10.1 About Commonly and Locally Granted Privileges

Both common users and local users can grant privileges to one another.

Privileges by themselves are neither common nor local. How the privileges are applied depends on whether the privilege is granted commonly or granted locally.

For commonly granted privileges:

- A privilege that is granted commonly can be used in every existing and future container.
- Only common users can grant privileges commonly, and only if the grantee is common.
- A common user can grant privileges to another common user or to a common role.
- The grantor must be connected to the root and must specify CONTAINER=ALL in the GRANT statement.
- Both system and object privileges can be commonly granted. (Object privileges become actual only with regard to the specified object.)
- When a common user connects to or switches to a given container, this user's ability to perform various activities (such as creating a table) is controlled by privileges granted commonly as well as privileges granted locally in the given container.
- Do not grant privileges to PUBLIC commonly.

For locally granted privileges:

- A privilege granted locally can be used only in the container in which it was granted. When the privilege is granted in the root, it applies only to the root.
- Both common users and local users can grant privileges locally.
- A common user and a local user can grant privileges to other common or local roles.

- The grantor must be connected to the container and must specify `CONTAINER=CURRENT` in the `GRANT` statement.
- Any user can grant a privilege locally to any other user or role (both common and local) or to the `PUBLIC` role.

Related Topics

- *Oracle Multitenant Administrator's Guide*
- [How the PUBLIC Role Works in a Multitenant Environment](#)
All privileges that Oracle grants to the `PUBLIC` role are granted locally.

4.10.2 How Commonly Granted System Privileges Work

Users can exercise system privileges only within the PDB in which they were granted.

For example, if a system privilege is locally granted to a common user `c##hr_admin` in the PDB `hr_pdb`, user `c##hr_admin` can exercise that privilege only while connected to PDB `hr_pdb`.

System privileges can apply in the root and in all existing and future PDBs if the following requirements are met:

- The system privilege grantor is a common user and the grantee is a common user, a common role, or the `PUBLIC` role. Do not commonly grant system privileges to the `PUBLIC` role, because this in effect makes the system privilege available to all users.
- The system privilege grantor possesses the `ADMIN OPTION` for the commonly granted privilege
- The `GRANT` statement must contain the `CONTAINER=ALL` clause.

The following example shows how to commonly grant a privilege to the common user `c##hr_admin`.

```
CONNECT SYSTEM
Enter password: password
Connected.
```

```
GRANT CREATE ANY TABLE TO c##hr_admin CONTAINER=ALL;
```

4.10.3 How Commonly Granted Object Privileges Work

Object privileges on common objects applies to the object as well as all associated links on this common object.

These links include all metadata links, data links (previously called object links), or extended data links that are associated with it in the root and in all PDBs belonging to the container (including future PDBs) if certain requirements are met.

These requirements are as follows:

- The object privilege grantor is a common user and the grantee is a common user, a common role, or the `PUBLIC` role.
- The object privilege grantor possesses the commonly granted `GRANT OPTION` for the privilege
- The `GRANT` statement contains the `CONTAINER=ALL` clause.

The following example shows how to grant an object privilege to the common user `c##hr_admin` so that they can select from the `DBA_PDBS` view in the CDB root or in any of the associated PDBs that they can access.

```
CONNECT SYSTEM
Enter password: password
Connected.

GRANT SELECT ON DBA_OBJECTS TO c##hr_admin
CONTAINER=ALL;
```

Related Topics

- [Oracle Multitenant Administrator's Guide](#)
- [How the PUBLIC Role Works in a Multitenant Environment](#)
All privileges that Oracle grants to the `PUBLIC` role are granted locally.

4.10.4 Granting or Revoking Privileges to Access a PDB

You can grant and revoke privileges for PDB access.

To grant or revoke a privilege in a PDB, include the `CONTAINER` clause in the `GRANT` or `REVOKE` statement.

Setting `CONTAINER` to `ALL` applies the privilege to all existing and future containers; setting it to `CURRENT` applies the privilege to the local container only. Omitting the `CONTAINER` clause applies the privilege to the local container. If you issue the `GRANT` statement from the root and omit the `CONTAINER` clause, then the privilege is applied locally.

Related Topics

- [Oracle Database SQL Language Reference](#)

4.10.5 Example: Granting a Privilege to a Common User

You must use the `GRANT` statement in the root to grant privileges to a common user.

[Example 4-3](#) shows how to commonly grant the `CREATE TABLE` privilege to common user `c##hr_admin` so that this user can use this privilege in all existing and future containers.

Example 4-3 Granting a Privilege in a Multitenant Environment

```
CONNECT SYSTEM
Enter password: password
Connected.

GRANT CREATE TABLE TO c##hr_admin CONTAINER=ALL;
```

4.10.6 Enabling Common Users to View CONTAINER_DATA Object Information

Common users can view information about `CONTAINER_DATA` objects in the root or for data in specific PDBs.

- [Viewing Data About the Root, CDB, and PDBs While Connected to the Root](#)
You can restrict view information for the `X$` table and the `V$`, `GV$` and `CDB_*` views when common users perform queries.

- [Enabling Common Users to Query Data in Specific PDBs](#)
You can enable common users to access data pertaining to specific PDBs by adjusting the users' CONTAINER_DATA attribute.

4.10.6.1 Viewing Data About the Root, CDB, and PDBs While Connected to the Root

You can restrict view information for the X\$ table and the V\$, GV\$ and CDB_* views when common users perform queries.

The X\$ table and these views contain information about the application root and its associated application PDBs or, if you are connected to the CDB root, the entire CDB.

Restricting this information is useful when you do not want to expose sensitive information about other PDBs. To enable this functionality, Oracle Database provides these tables and views as container data objects. You can find if a specific table or view is a container data object by querying the TABLE_NAME, VIEW_NAME, and CONTAINER_DATA columns of the USER_|DBA_|ALL_VIEWS|TABLES dictionary views.

To find information about the default (user-level) and object-specific CONTAINER_DATA attributes:

1. In SQL*Plus or SQL Developer, log in to the root.
2. Query the CDB_CONTAINER_DATA data dictionary view.

For example:

```
COLUMN USERNAME FORMAT A13
COLUMN DEFAULT_ATTR FORMAT A7
COLUMN OWNER FORMAT A11
COLUMN OBJECT_NAME FORMAT A11
COLUMN ALL_CONTAINERS FORMAT A3
COLUMN CONTAINER_NAME FORMAT A10
COLUMN CON_ID FORMAT A6

SELECT USERNAME, DEFAULT_ATTR, OWNER, OBJECT_NAME,
       ALL_CONTAINERS, CONTAINER_NAME, CON_ID
FROM   CDB_CONTAINER_DATA
ORDER BY OBJECT_NAME;
```

USERNAME	DEFAULT_ATTR	OWNER	OBJECT_NAME	ALL_CONTAINERS	CONTAINER_NAME	CON_ID
C##HR_ADMIN	N	SYS	V\$SESSION	N	CDB\$ROOT	1
C##HR_ADMIN	N	SYS	V\$SESSION	N	SALESPDB	1
C##HR_ADMIN	Y			N	HRPDB	1
C##HR_ADMIN	Y			N	CDB\$ROOT	1
DBSNMP	Y			Y		1
SYSTEM	Y			Y		1

Related Topics

- [Oracle Database Reference](#)

4.10.6.2 Enabling Common Users to Query Data in Specific PDBs

You can enable common users to access data pertaining to specific PDBs by adjusting the users' `CONTAINER_DATA` attribute.

To enable common users to access data about specific PDBs:

- Issue the `ALTER USER` statement in the root.

Example 4-4 Setting the `CONTAINER_DATA` Attribute

This example shows how to issue the `ALTER USER` statement to enable the common user `c##hr_admin` to view information pertaining to the `CDB$ROOT`, `SALES_PDB`, and `HRPDB` containers in the `V$SESSION` view (assuming this user can query that view).

```
CONNECT SYSTEM
Enter password: password
Connected.

ALTER USER c##hr_admin
SET CONTAINER_DATA = (CDB$ROOT, SALESPDB, HRPDB)
FOR V$SESSION CONTAINER=CURRENT;
```

In this specification:

- `SET CONTAINER_DATA` lists containers, data pertaining to which can be accessed by the user.
- `FOR V$SESSION` specifies the `CONTAINER_DATA` dynamic view, which common user `c##hr_admin` will query.
- `CONTAINER = CURRENT` must be specified because when you are connected to the root, `CONTAINER=ALL` is the default for the `ALTER USER` statement, but modification of the `CONTAINER_DATA` attribute must be restricted to the root.

If you want to enable user `c##hr_admin` to view information that pertains to the `CDB$ROOT`, `SALES_PDB`, `HRPDB` containers in all `CONTAINER_DATA` objects that this user can access, then omit `FOR V$SESSION`. For example:

```
ALTER USER c##hr_admin
SET CONTAINER_DATA = (CDB$ROOT, SALESPDB, HRPDB)
CONTAINER=CURRENT;
```

Related Topics

- [Oracle Database SQL Language Reference](#)

4.11 Managing User Roles

A user role is a named collection of privileges that you can create and assign to other users.

- [About User Roles](#)
User roles are useful in a variety of situations, such as restricting DDL usage.
- [Predefined Roles in an Oracle Database Installation](#)
Oracle Database provides a set of predefined roles to help in database administration.

- [Creating a Role](#)
You can create a role that is authenticated with or without a password. You also can create external or global roles.
- [Specifying the Type of Role Authorization](#)
You can configure a role to be authorized through different sources, such the database or an external source.
- [Granting and Revoking Roles](#)
You can grant or revoke privileges to and from roles, and then grant these roles to users or to other roles.
- [Dropping Roles](#)
Dropping a role affects the security domains of users or roles who had been granted the role.
- [Restricting SQL*Plus Users from Using Database Roles](#)
You should restrict SQL*Plus users from using database roles, which helps to safeguard the database from intruder attacks.
- [Role Privileges and Secure Application Roles](#)
A secure application role can be enabled only by an authorized PL/SQL package or procedure.

4.11.1 About User Roles

User roles are useful in a variety of situations, such as restricting DDL usage.

- [What Are User Roles?](#)
A user **role** is a named group of related privileges that you can grant as a group to users or other roles.
- [The Functionality of Roles](#)
Roles are useful for quickly and easily granting permissions to users.
- [Properties of Roles and Why They Are Advantageous](#)
Roles have special properties that make their management very easy, such reduced privilege administration.
- [Typical Uses of Roles](#)
In general, you create a role to manage privileges.
- [Common Uses of Application Roles](#)
You can use application roles to control privileges to use applications.
- [Common Uses of User Roles](#)
You can create a user role for a group of database users with common privilege grant requirements.
- [How Roles Affect the Scope of a User's Privileges](#)
Each role and user has its own unique security domain.
- [How Roles Work in PL/SQL Blocks](#)
Role behavior in a PL/SQL block is determined by the type of block and by definer's rights or invoker's rights.
- [How Roles Aid or Restrict DDL Usage](#)
A user requires one or more privileges to successfully run a DDL statement, depending on the statement.
- [How Operating Systems Can Aid Roles](#)
In some environments, you can administer database security using the operating system.

- [How Roles Work in a Distributed Environment](#)
In a distributed database environment, all necessary roles must be set as the default role for a distributed (remote) session.

4.11.1.1 What Are User Roles?

A user **role** is a named group of related privileges that you can grant as a group to users or other roles.

Managing and controlling privileges is easier when you use **roles**.

Within a database, each role name must be unique, different from all user names and all other role names. Unlike schema objects, roles are not contained in any schema. Therefore, a user who creates a role can be dropped with no effect on the role.

Related Topics

- [Managing Common Roles and Local Roles](#)
A common role is a role that is created in the root; a local role is created in a PDB.

4.11.1.2 The Functionality of Roles

Roles are useful for quickly and easily granting permissions to users.

Although you can use Oracle Database-defined roles, you have more control and continuity if you create your own roles that contain only the privileges pertaining to your requirements. Oracle may change or remove the privileges in an Oracle Database-defined role.

Roles have the following functionality:

- A role can be granted system or object privileges.
- Any role can be granted to any database user.
- Each role granted to a user is, at a given time, either enabled or disabled. A user's security domain includes the privileges of all roles currently enabled for the user and excludes the privileges of any roles currently disabled for the user. Oracle Database allows database applications and users to enable and disable roles to provide selective availability of privileges.
- A role can be granted to other roles. However, a role cannot be granted to itself and cannot be granted circularly. For example, role `role1` cannot be granted to role `role2` if role `role2` has previously been granted to role `role1`.
- If a role is not password authenticated or a secure application role, then you can grant the role indirectly to the user. An indirectly granted role is a role granted to the user through another role that has already been granted to this user. For example, suppose you grant user `psmith` the `role1` role. Then you grant the `role2` and `role3` roles to the `role1` role. Roles `role2` and `role3` are now under `role1`. This means `psmith` has been indirectly granted the roles `role2` and `role3`, in addition to the direct grant of `role1`. Enabling the direct `role1` for `psmith` enables the indirect roles `role2` and `role3` for this user as well.
- Optionally, you can make a directly granted role a default role. You enable or disable the default role status of a directly granted role by using the `DEFAULT ROLE` clause of the `ALTER USER` statement. Ensure that the `DEFAULT ROLE` clause refers only to roles that have been directly granted to the user. To find the directly granted roles for a user, query the `DBA_ROLE_PRIVS` data dictionary view. This view does not include the user's indirectly granted roles. To find roles that are granted to other roles, query the `ROLE_ROLE_PRIVS` view.

- If the role is password authenticated or a secure application role, then you cannot grant it indirectly to the user, nor can you make it a default role. You only can grant this type of role directly to the user. Typically, you enable password authenticated or secure application roles by using the `SET ROLE` statement.

4.11.1.3 Properties of Roles and Why They Are Advantageous

Roles have special properties that make their management very easy, such reduced privilege administration.

[Table 4-6](#) describes the properties of roles that enable easier privilege management within a database.

Table 4-6 Properties of Roles and Their Description

Property	Description
Reduced privilege administration	Rather than granting the same set of privileges explicitly to several users, you can grant the privileges for a group of related users to a role, and then only the role must be granted to each member of the group.
Dynamic privilege management	If the privileges of a group must change, then only the privileges of the role need to be modified. The security domains of all users granted the group's role automatically reflect the changes made to the role.
Selective availability of privileges	You can selectively enable or disable the roles granted to a user. This allows specific control of a user's privileges in any given situation.
Application awareness	The data dictionary records which roles exist, so you can design applications to query the dictionary and automatically enable (or disable) selective roles when a user attempts to run the application by way of a given user name.
Application-specific security	You can protect role use with a password. Applications can be created specifically to enable a role when supplied the correct password. Users cannot enable the role if they do not know the password.

Database administrators often create roles for a database application. You should grant a secure application role all privileges necessary to run the application. You then can grant the secure application role to other roles or users. An application can have several different roles, each granted a different set of privileges that allow for more or less data access while using the application.

The DBA can create a role with a password to prevent unauthorized use of the privileges granted to the role. Typically, an application is designed so that when it starts, it enables the proper role. As a result, an application user does not need to know the password for an application role.

Related Topics

- [How Roles Aid or Restrict DDL Usage](#)
A user requires one or more privileges to successfully run a DDL statement, depending on the statement.

4.11.1.4 Typical Uses of Roles

In general, you create a role to manage privileges.

Reasons are as follows:

- To manage the privileges for a database application
- To manage the privileges for a user group

The following diagram describes the two uses of roles.

Figure 4-1 Common Uses for Roles

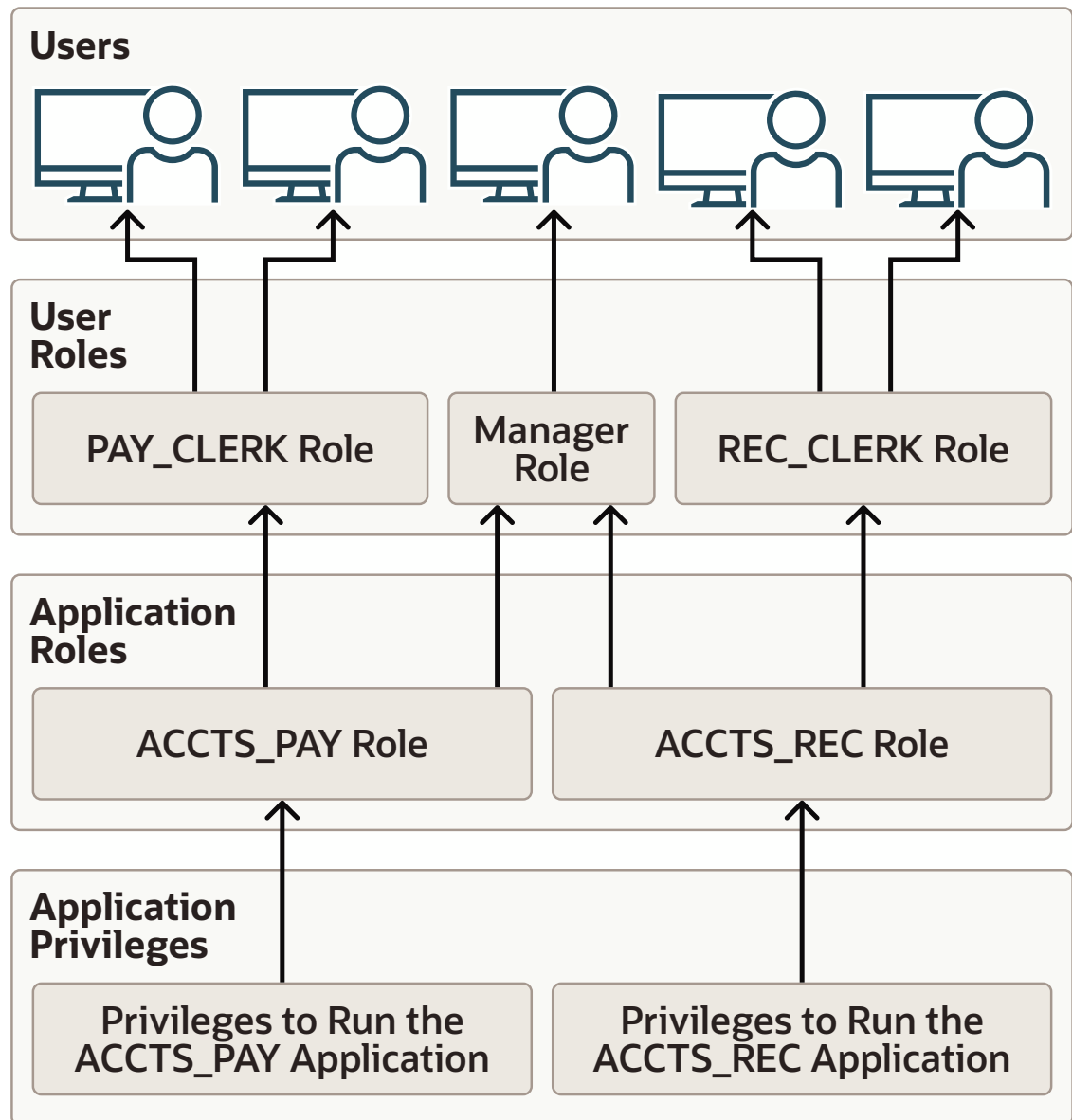

Related Topics

- [Common Uses of Application Roles](#)
You can use application roles to control privileges to use applications.
- [Common Uses of User Roles](#)
You can create a user role for a group of database users with common privilege grant requirements.

4.11.1.5 Common Uses of Application Roles

You can use application roles to control privileges to use applications.

You should grant an application role all privileges necessary to run a given database application. Then, grant the secure application role to other roles or to specific users.

An application can have several different roles, with each role assigned a different set of privileges that allow for more or less data access while using the application.

4.11.1.6 Common Uses of User Roles

You can create a user role for a group of database users with common privilege grant requirements.

You can manage user privileges by granting secure application roles and privileges to the user role and then granting the user role to appropriate users.

4.11.1.7 How Roles Affect the Scope of a User's Privileges

Each role and user has its own unique security domain.

The security domain of a role includes the privileges granted to the role plus those privileges granted to any roles that are granted to the role.

The security domain of a user includes privileges on all schema objects in the corresponding schema, the privileges granted to the user, and the privileges of roles granted to the user that are **currently enabled**. (A role can be simultaneously enabled for one user and disabled for another.) This domain also includes the privileges and roles granted to the role `PUBLIC`. The `PUBLIC` role represents all users in the database.

4.11.1.8 How Roles Work in PL/SQL Blocks

Role behavior in a PL/SQL block is determined by the type of block and by definer's rights or invoker's rights.

- [Roles Used in Named Blocks with Definer's Rights](#)
All roles are disabled in any named PL/SQL block that runs with definer's rights.
- [Roles Used in Named Blocks with Invoker's Rights and Anonymous PL/SQL Blocks](#)
Named PL/SQL blocks that run with invoker's rights and anonymous PL/SQL blocks are run based on privileges granted through enabled roles.

4.11.1.8.1 Roles Used in Named Blocks with Definer's Rights

All roles are disabled in any named PL/SQL block that runs with definer's rights.

Examples of named PL/SQL blocks are stored procedures, functions, and triggers.

Roles are not used for privilege checking and you cannot set roles within a definer's rights procedure.

The `SESSION_ROLES` data dictionary view shows all roles that are currently enabled and if a PL/SQL block runs with definer's rights. If a named PL/SQL block that runs with definer's rights queries `SESSION_ROLES`, then the query does not return any rows.

4.11.1.8.2 Roles Used in Named Blocks with Invoker's Rights and Anonymous PL/SQL Blocks

Named PL/SQL blocks that run with invoker's rights and anonymous PL/SQL blocks are run based on privileges granted through enabled roles.

Current roles are used for privilege checking within an invoker's rights PL/SQL block. You can use dynamic SQL to set a role in the session.

Related Topics

- *Oracle Database PL/SQL Language Reference* Invokers Rights and Definers Rights (AUTHID Property)

4.11.1.9 How Roles Aid or Restrict DDL Usage

A user requires one or more privileges to successfully run a DDL statement, depending on the statement.

For example, to create a table, the user must have the `CREATE TABLE` or `CREATE ANY TABLE` system privilege.

To create a view of a table that belongs to another user, the creator must have the `CREATE VIEW` or `CREATE ANY VIEW` system privilege and either the `SELECT object` privilege for the table or the `SELECT ANY TABLE` system privilege.

Oracle Database avoids the dependencies on privileges received by way of roles by restricting the use of specific privileges in certain DDL statements. The following rules describe these privilege restrictions concerning DDL statements:

- All system privileges and object privileges that permit a user to perform a DDL operation are usable when received through a role. For example:
 - **System privileges:** `CREATE TABLE`, `CREATE VIEW`, and `CREATE PROCEDURE` privileges
 - **Object privileges:** `ALTER` and `INDEX` privileges for a table

You cannot use the `REFERENCES` object privilege for a table to define the foreign key of a table if the privilege is received through a role.
- All system privileges and object privileges that allow a user to perform a DML operation that is required to issue a DDL statement are *not* usable when received through a role. The security domain does not contain roles when a `CREATE VIEW` statement is used. For example, a user who is granted the `SELECT ANY TABLE` system privilege or the `SELECT object` privilege for a table through a role cannot use either of these privileges to create a view on a table that belongs to another user. This is because views are definer's rights objects, so when creating them you cannot use any privileges (neither system privileges or object privileges) granted to you through a role. If the privilege is granted directly to you, then you can use the privilege. However, if the privilege is revoked at a later time, then the view definition becomes invalid ("contains errors") and must be recompiled before it can be used again.

The following example further clarifies the permitted and restricted uses of privileges received through roles.

Assume that a user is:

- Granted a role that has the `CREATE VIEW` system privilege
- Directly granted a role that has the `SELECT object` privilege for the `employees` table
- Directly granted the `SELECT object` privilege for the `departments` table

Given these directly and indirectly granted privileges:

- The user can issue `SELECT` statements on both the `employees` and `departments` tables.
- Although the user has both the `CREATE VIEW` and `SELECT` privilege for the `employees` table through a role, the user cannot create a view on the `employees` table, because the `SELECT object` privilege for the `employees` table was granted through a role.
- The user can create a view on the `departments` table, because the user has the `CREATE VIEW` privilege through a role and the `SELECT` privilege for the `departments` table directly.

4.11.1.10 How Operating Systems Can Aid Roles

In some environments, you can administer database security using the operating system.

The operating system can be used to grant and revoke database roles and to manage their password authentication. This capability is not available on all operating systems.

 **See Also:**

Your operating system-specific Oracle Database documentation for details about managing roles through the operating system

4.11.1.11 How Roles Work in a Distributed Environment

In a distributed database environment, all necessary roles must be set as the default role for a distributed (remote) session.

These roles cannot be enabled when the user connects to a remote database from within a local database session. For example, the user cannot run a remote procedure that attempts to enable a role at the remote site.

 **See Also:**

Oracle Database Heterogeneous Connectivity User's Guide

4.11.2 Predefined Roles in an Oracle Database Installation

Oracle Database provides a set of predefined roles to help in database administration.

These predefined role are automatically defined for Oracle databases when you run the standard scripts (such as `catalog.sql` and `catproc.sql`) that are part of database creation, and they are considered common roles. If you install other options or products, then other predefined roles may be created. You can find roles that are created and maintained by Oracle by querying the `ROLE` and `ORACLE_MAINTAINED` columns of the `DBA_ROLES` data dictionary view. If the output for `ORACLE_MAINTAINED` is `Y`, then you must not modify the role except by running the script that was used to create it.

Table 4-7 Oracle Database Predefined Roles

Predefined Role	Description
ACCHK_READ	<p>Provides privileges to use Application Continuity Protection Check (ACCHK), which includes the ability to query the following data dictionary views:</p> <ul style="list-style-type: none"> DBA_ACCHK_EVENTS DBA_ACCHK_EVENTS_SUMMARY DBA_ACCHK_STATISTICS DBA_ACCHK_STATISTICS_SUMMARY <p>Database administrators and PDB administrators grant this role to developers to read their results from ACCHK.</p>
ADM_PARALLEL_EXECUTE_TASK	Provides privileges to update table data in parallel by using the DBMS_PARALLEL_EXECUTE PL/SQL package.
AQ_ADMINISTRATOR_ROLE	Provides privileges to administer Advanced Queuing. Includes ENQUEUE ANY QUEUE, DEQUEUE ANY QUEUE, and MANAGE ANY QUEUE, SELECT privileges on Advanced Queuing tables and EXECUTE privileges on Advanced Queuing packages.
AQ_USER_ROLE	De-supported, but kept mainly for release 8.0 compatibility. Provides EXECUTE privileges on the DBMS_AQ and DBMS_AQIN packages.
AUDIT_ADMIN	Provides privileges to create unified and fine-grained audit policies, use the AUDIT and NOAUDIT SQL statements, view audit data, and manage the audit trail administration
AUDIT_VIEWER	Provides privileges to view and analyze audit data
AUTHENTICATEDUSER	Used by the XDB protocols to define any user who has logged in to the system.
AVTUNE_PKG_ROLE	Is granted by default to the DBMS_AVTUNE package so that it can do its job. The DBMS_AVTUNE package is granted the role so that it has those privileges when it executes and the user does not need to have them.
BDSQL_ADMIN	Provides privileges to use the DBMS_BDSQL PL/SQL package
BDSQL_USER	Provides privileges to use Oracle Big Data SQL
CAPTURE_ADMIN	Provides the privileges necessary to create and manage privilege analysis policies.
CDB_DBA	Provides the privileges required for administering a CDB, such as SET CONTAINER, SELECT ON PDB_PLUG_IN_VIOLATIONS, and SELECT ON CDB_LOCAL_ADMIN_PRIVS. If your site requires additional privileges, then you can create a role (either common or local) to cover these privileges, and then grant this role to the CDB_DBA role.
CONNECT	<p>Provides the CREATE SESSION system privilege.</p> <p>This role is provided for compatibility with previous releases of Oracle Database. You can determine the privileges encompassed by this role by querying the DBA_SYS_PRIVS data dictionary view.</p> <p>Note: Oracle recommends that you design your own roles for database security rather than relying on this role. This role may not be created automatically by future releases of Oracle Database.</p>
CTXAPP	Provides privileges to create Oracle Text indexes and index preferences, and to use PL/SQL packages. This role should be granted to Oracle Text users.
DATAPUMP_EXP_FULL_DATABASE	<p>Provides privileges to export data from an Oracle database using Oracle Data Pump.</p> <p>Caution: This is a very powerful role because it provides a user access to any data in any schema in the database. Use caution when granting this role to users.</p>

Table 4-7 (Cont.) Oracle Database Predefined Roles

Predefined Role	Description
DATAPUMP_IMP_FULL_DATABASE	Provides privileges to import data into an Oracle database using Oracle Data Pump. Caution: This is a very powerful role because it provides a user access to any data in any schema in the database. Use caution when granting this role to users.
DB_DEVELOPER_ROLE	Provides most of the system privileges, object privileges, predefined roles, PL/SQL package privileges, and tracing privileges that an application developer needs.
DBA	Provides a large number of system privileges, including the ANY privileges (such as the DELETE ANY TABLE and GRANT ANY PRIVILEGE privileges). This role is provided for compatibility with previous releases of Oracle Database. You can find the privileges that are encompassed by this role by querying the DBA_SYS_PRIVS data dictionary view. Note: Oracle recommends that you design your own roles for database security rather than relying on this role. This role may not be created automatically by future releases of Oracle Database.
DBJAVASCRIPT	Provided privileges for a schema to run JavaScript code, using the Nashorn engine of 12.2 Oracle JVM. Desupported.
DBMS_MDX_INTERNAL	Supports the DBMS_MDX_ODBO PL/SQL package. For internal use only.
DGPDB_ROLE	Grants privileges to the Oracle Data Guard account DGPDB_INT, which is an internal account
DV_ACCTMGR	Provides privileges to manage user accounts in an Oracle Database Vault environment
DV_ADMIN	Provides privileges to use the Oracle Database Vault PL/SQL packages
DV_AUDIT_CLEANUP	Provides privileges for purge operations in an Oracle Database Vault environment
DV_DATAPUMP_NETWORK_LINK	Provides privileges for performing Oracle Data Pump import operations in an Oracle Database Vault environment
DV_GOLDENGATE_ADMIN	Provides privileges to configure Oracle GoldenGate in an Oracle Database Vault environment
DV_GOLDENGATE_REDO_ACCESS	Provides privileges to use the Oracle GoldenGate TRANLOGOPTIONS DBLOGREADER method to access redo logs in an Oracle Database Vault environment
DV_MONITOR	Enables the Oracle Enterprise Manager Cloud Control agent to monitor Oracle Database Vault for attempted violations and configuration issues with realm or command rule definitions
DV_OWNER	Provides privileges to manage the Oracle Database Vault roles and its configuration
DV_PATCH_ADMIN	Provides privileges to perform patch operations in an Oracle Database Vault environment
DV_POLICY_OWNER	Provides privileges to manage to a limited degree Oracle Database Vault policies
DV_SECANALYST	Provides privileges to analyze Oracle Database Vault reports and monitor Oracle Database Vault
DV_STREAMS_ADMIN	Required for configuring Oracle Streams, which is deprecated, in an Oracle Database Vault environment
DV_XSTREAM_ADMIN	Required for configuring Oracle XStreams in an Oracle Database Vault environment
DBFS_ROLE	Provides access to the DBFS (the Database Filesystem) packages and objects.

Table 4-7 (Cont.) Oracle Database Predefined Roles

Predefined Role	Description
EJBCLIENT	Provides privileges to connect to EJBs from a Java stored procedure.
EXECUTE_CATALOG_ROLE	Provides EXECUTE privileges on objects in the data dictionary.
EXP_FULL_DATABASE	Provides the privileges required to perform full and incremental database exports using the Export utility (later replaced with Oracle Data Pump). It includes these privileges: SELECT ANY TABLE, BACKUP ANY TABLE, EXECUTE ANY PROCEDURE, EXECUTE ANY TYPE, ADMINISTER RESOURCE MANAGER, and INSERT, DELETE, and UPDATE on the tables SYS.INCVID, SYS.INCFIL, and SYS.INCEXP. Also includes the following roles: EXECUTE_CATALOG_ROLE and SELECT_CATALOG_ROLE. This role is provided for convenience in using the export and import utilities. Caution: This is a very powerful role because it provides a user access to any data in any schema in the database. Use caution when granting this role to users.
GATHER_SYSTEM_STATISTICS	Provides privileges to update system statistics, which are collected using the DBMS_STATS.GATHER_SYSTEM_STATISTICS procedure
GDS_CATALOG_SELECT	Provides the read privilege to the Global Data Services (GDS) and sharding catalog tables that are owned by GSMADMIN_INTERNAL. This role was created primarily for Oracle Enterprise Manager support of GDS and sharding, but users can use it to run their own reports using GDS metadata.
GLOBAL_AQ_USER_ROLE	Provides privileges to establish a connection to an LDAP server, for use with Oracle Database Advanced Queuing
GRAPH_ADMINISTRATOR	Provides privileges to perform operations on the graph server (PGX) using the Java API (as compared to running start and stop operations as an OS user)
GRAPH_DEVELOPER	Provides privileges to create, publish, modify, query, and view graphs using the Java API or SQLcl or the graph visualization application
GRAPH_USER	Provides privileges to query and view graphs using the Java API or SQLcl or the graph visualization application
GSMADMIN_ROLE	Should be granted to Global Data Services (GDS) and sharding administrators, so that they can administer a GDS or sharding configuration
GSMCATUSER_ROLE	Granted only the Oracle delivered account GSMCATUSER for internal use
GSMROOTUSER_ROLE	Granted only to Oracle delivered account GSMROOTUSER for internal use
GSMUSER_ROLE	Granted only to Oracle delivered account GSMUSER for internal use
GSM_POOLADMIN_ROLE	Valid for GDS only (not for sharding). Should be granted to GDS pool administrators so that they can administer their GDS pool
HS_ADMIN_EXECUTE_ROLE	Provides the EXECUTE privilege for users who want to use the Heterogeneous Services (HS) PL/SQL packages
HS_ADMIN_ROLE	Provides privileges to both use the Heterogeneous Services (HS) PL/SQL packages and query the HS-related data dictionary views
HS_ADMIN_SELECT_ROLE	Provides privileges to query the Heterogeneous Services data dictionary views
IMP_FULL_DATABASE	Provides the privileges required to perform full database imports using the Import utility (later replaced with Oracle Data Pump). Includes an extensive list of system privileges (use view DBA_SYS_PRIVS to view privileges) and the following roles: EXECUTE_CATALOG_ROLE and SELECT_CATALOG_ROLE. This role is provided for convenience in using the export and import utilities. Caution: This is a very powerful role because it provides a user access to any data in any schema in the database. Use caution when granting this role to users.

Table 4-7 (Cont.) Oracle Database Predefined Roles

Predefined Role	Description
JVADEBUGPRIV	Provides privileges to run the Oracle Database Java applications debugger
JVAIDPRIV	Deprecated for this release
JAVASYSPRIV	Provides major permissions to use Java2, including updating Oracle JVM-protected packages
JVAUSERPRIV	Provides limited permissions to use Java2
JAVA_ADMIN	Provides administrative permissions to update policy tables for Oracle Database Java applications
JMXSERVER	Provides privileges to start and maintain a JMX agent in a database session
LBAC_DBA	Provides permissions to use the SA_SYSDBA PL/SQL package
LOGSTDBY_ADMINISTRATOR	Provides administrative privileges to manage the SQL Apply (logical standby database) environment
OEM_ADVISOR	Provides privileges to create, drop, select (read), load (write), and delete a SQL tuning set through the DBMS_SQLTUNE PL/SQL package, and to access to the Advisor framework using the ADVISOR PL/SQL package
OEM_MONITOR	Provides privileges needed by the Management Agent component of Oracle Enterprise Manager to monitor and manage the database
OGG_APPLY	Provides privileges to manage Oracle GoldenGate Replicat
OGG_APPLY_PROCREP	Provides privileges for using Oracle GoldenGate procedural replication
OGG_CAPTURE	Provides privileges to use Oracle GoldenGate Extract
OGG_CAPTURE_SHARED	Provides privileges for managing GoldenGate Shared Capture
OLAP_DBA	Provides administrative privileges to create dimensional objects in different schemas for Oracle OLAP
OLAP_USER	Provides application developers privileges to create dimensional objects in their own schemas for Oracle OLAP
OLAP_XS_ADMIN	Provides privileges to administer security for Oracle OLAP
OPTIMIZER_PROCESSING_RATE	Provides privileges to run the GATHER_PROCESSING_RATE, SET_PROCESSING_RATE, and DELETE_PROCESSING_RATE procedures in the DBMS_STATS package. These procedures manage the processing rate of a system for automatic degree of parallelism (Auto DOP). Auto DOP uses these processing rates to determine the optimal degree of parallelism for a SQL statement.
OSAK_ADMIN_ROLE	Provides privileges for an Oracle SQL Access to Kafka (OSAK) administrator to configure, register, and manage Kafka clusters
PDB_DBA	Granted automatically to the local user that is created when you create a new PDB from the seed PDB. No privileges are provided with this role.
PGX_SERVER_GET_INFO	Provides privileges to find status information on the property graph (PGX) instance using the Admin API
PGX_SERVER_MANAGE	Provides privileges to manage the PGX instance
PGX_SESSION_ADD_PUBLISHED_GRAPH	Provides privileges to create a new graph in PGX by loading from the database using a configuration file, using the CREATE PROPERTY GRAPH statement in PGQL, creating a sub-graph from another graph, or using the GraphBuilder
PGX_SESSION_COMPILE_ALGORITHM	Provides privileges to compile algorithms using the PGX Algorithm API
PGX_SESSION_CREATE	Provides privileges to create a new PGX session using the ServerInstance.createSession API

Table 4-7 (Cont.) Oracle Database Predefined Roles

Predefined Role	Description
PGX_SESSION_GET_PUBLISHED_GRAPH	Provides privileges to query and view graphs published by another user to the public namespace
PGX_SESSION_MODIFY_MODEL	Provides privileges to create, train, and store an ML model using PgxML
PGX_SESSION_NEW_GRAPH	Provides privileges to create a new graph in PGX by loading from the database using a configuration file, using the <code>CREATE PROPERTY GRAPH</code> statement in PGQL, creating a sub-graph from another graph, or using the GraphBuilder
PGX_SESSION_READ_MODEL	Provides privileges to load and use an ML model using PgxML
PPLB_ROLE	Granted only to the Oracle Data Guard account <code>DGPDB_INT</code> for internal use. This role enables the <code>DGPDB_INT</code> account to access the pre-plugin backup tables when plugging new PDBs. Do not grant this role to any users or other roles.
PROVISIONER	Provides privileges to register and update global callbacks for Oracle Database Real Application sessions and to provision principals.
RDFCTX_ADMIN	Provides privileges for using the Semantic (Text) search feature of Resource Description Framework (RDF) graphs
RECOVERY_CATALOG_OWNER	Provides the following privileges for owner of the recovery catalog: <ul style="list-style-type: none"> • ADMINISTER DATABASE • ALTER SESSION • CREATE ANY CONTEXT • CREATE ANY SYNONYM • CREATE ANY TRIGGER • CREATE CLUSTER • CREATE DATABASE LINK • CREATE PROCEDURE • CREATE SEQUENCE • CREATE SESSION • CREATE SYNONYM • CREATE TABLE • CREATE TRIGGER • CREATE VIEW • DROP ANY SYNONYM • EXECUTE ON DBMS_RLS • QUERY REWRITE
RECOVERY_CATALOG_OWNER_VPD	Provides privileges for recovery catalog management.
RECOVERY_CATALOG_USER	Provides privileges for recovery catalog management.

Table 4-7 (Cont.) Oracle Database Predefined Roles

Predefined Role	Description
RESOURCE	<p>Provides the following resource-related system privileges:</p> <ul style="list-style-type: none"> • CREATE ANALYTIC VIEW • CREATE ATTRIBUTE DIMENSION • CREATE CLUSTER • CREATE HIERARCHY • CREATE INDEXTYPE • CREATE MATERIALIZED VIEW • CREATE OPERATOR • CREATE PROCEDURE • CREATE PROPERTY GRAPH • CREATE SEQUENCE • CREATE SYNONYM • CREATE TABLE • CREATE TRIGGER • CREATE TYPE • CREATE VIEW <p>Be aware that RESOURCE no longer provides the UNLIMITED TABLESPACE system privilege.</p> <p>This role is provided for compatibility with previous releases of Oracle Database. You can determine the privileges encompassed by this role by querying the DBA_SYS_PRIVS data dictionary view.</p> <p>Note: Oracle recommends that you design your own roles for database security rather than relying on this role. This role may not be created automatically by future releases of Oracle Database.</p>
SAGA_ADM_ROLE	Provides the ability to invoke APIs from the DBMS_SAGA_ADM package. This role is required for saga administrators for the initial setup and provides full access to the DBMS_SAGA_ADM API.
SAGA_CONNECT_ROLE	Provided to the remote database link user when the Oracle saga framework is in use.
SAGA_PARTICIPANT_ROLE	Required for saga participant services. Saga primitives can only be invoked by a user that has the SAGA_PARTICIPANT role granted to it.
SCHEDULER_ADMIN	Allows the grantee to run the procedures of the DBMS_SCHEDULER package. It includes all of the job scheduler system privileges and is included in the DBA role.
SELECT_CATALOG_ROLE	Provides SELECT privilege on objects in the data dictionary.
SHARDED_SCHEMA_OWNER	Provides privileges for sharded schema owners to perform sharding administrative tasks on their own schema
SODA_APP	Provides privileges to use the SODA APIs, in particular, to create, drop, and list document collections.
SQL_FIREWALL_ADMIN	<p>Provides the following privileges to administer SQL Firewall:</p> <ul style="list-style-type: none"> • ADMINISTER SQL FIREWALL system privilege • EXECUTE privilege on the DBMS_SQL_FIREWALL PL/SQL package • SELECT privilege for the DBA_SQL_FIREWALL_* data dictionary views
SQL_FIREWALL_VIEWER	Provides the SELECT privilege for the SQL Firewall DBA_SQL_FIREWALL_* data dictionary views

Table 4-7 (Cont.) Oracle Database Predefined Roles

Predefined Role	Description
WM_ADMIN_ROLE	Provides administrative privileges for Oracle Workspace Manager. This enables users to run any <code>DBMS_WM</code> procedures on all version enabled tables, workspaces, and savepoints regardless of their owner. It also enables the user to modify the system parameters specific to Workspace Manager.
XDBADMIN	Allows the grantee to register an XML schema globally, as opposed to registering it for use or access only by its owner. It also lets the grantee bypass access control list (ACL) checks when accessing Oracle XML DB Repository (deprecated).
XDB_SET_INVOKER	Allows the grantee to define invoker's rights handlers and to create or update the resource configuration for XML repository triggers. By default, Oracle Database grants this role to the DBA role but not to the XDBADMIN role.
XDB_WEBSERVICES	Allows the grantee to access Oracle Database Web services over HTTPS. However, it does not provide the user access to objects in the database that are public. To allow public access, you need to grant the user the <code>XDB_WEBSERVICES_WITH_PUBLIC</code> role. For a user to use these Web services, SYS must enable the Web service servlets.
XDB_WEBSERVICES_OVER_HTTP	Allows the grantee to access Oracle Database Web services over HTTP. However, it does not provide the user access to objects in the database that are public. To allow public access, you need to grant the user the <code>XDB_WEBSERVICES_WITH_PUBLIC</code> role.
XDB_WEBSERVICES_WITH_PUBLIC	Allows the grantee access to public objects through Oracle Database Web services.
XSTREAM_APPLY	Provides privileges to manage XStream In
XSTREAM_CAPTURE	Provides privileges to manage XStream Out
XS_CACHE_ADMIN	In Oracle Database Real Application Security, enables the grantee to manage the mid-tier cache. It is required for caching the security policy at the mid-tier level for the <code>checkAcl</code> (authorization) method of the <code>XSAccessController</code> class. Grant this role to the application connection user or the Real Application Security dispatcher.
XS_NAMESPACE_ADMIN	In Oracle Database Real Application Security, enables the grantee to manage and manipulate the namespace and attribute for a session. Grant this role to the Real Application Security session user.
XS_RESOURCE	In Oracle Database Real Application Security, enables the grantee to manage objects in the attached schema, through the <code>XS_ACL</code> PL/SQL package. This package creates procedures to create and manage access control lists (ACLs). It contains the <code>ADMIN SEC POLICY</code> privilege. It is similar to the Oracle Database <code>RESOURCE</code> role.
XS_SESSION_ADMIN	In Oracle Database Real Application Security, enables the grantee to manage the life cycle of a session, including the ability to create, attach, detach, and destroy the session. Grant this role to the application connection user or Real Application Security dispatcher.

 **Note:**

Each installation should create its own roles and assign only those privileges that are needed, thus retaining detailed control of the privileges in use. This process also removes any need to adjust existing roles, privileges, or procedures whenever Oracle Database changes or removes roles that Oracle Database defines. For example, the `CONNECT` role now has only one privilege: `CREATE SESSION`.

4.11.3 Creating a Role

You can create a role that is authenticated with or without a password. You also can create external or global roles.

- [About the Creation of Roles](#)
You can create a role by using the `CREATE ROLE` statement.
- [Creating a Role That Is Authenticated With a Password](#)
You can create a password authenticated role by using the `IDENTIFIED BY` clause.
- [Creating a Role That Has No Password Authentication](#)
You can create a role that does not require a password by omitting the `IDENTIFIED BY` clause.
- [Creating a Role That Is External or Global](#)
External or global roles allow services that are outside the database to associate database roles to authenticated users.
- [Altering a Role](#)
The `ALTER ROLE` statement can modify the authorization method for a role.

4.11.3.1 About the Creation of Roles

You can create a role by using the `CREATE ROLE` statement.

To create the role, you must have the `CREATE ROLE` system privilege. Typically, only security administrators have this system privilege. After you create a role, the role has no privileges associated with it. Your next step is to grant either privileges or other roles to the new role.

You must give each role that you create a unique name among existing user names and role names of the database. Roles are not contained in the schema of any user. In a database that uses a multi-byte character set, Oracle recommends that each role name contain at least one single-byte character. If a role name contains only multi-byte characters, then the encrypted role name and password combination is considerably less secure. See [Guideline 1 in Guidelines for Securing Passwords](#) for password guidelines.

You can use the `IDENTIFIED BY` clause to authorize the role with a password. This clause specifies how the user must be authorized before the role can be enabled for use by a specific user to which it has been granted. If you do not specify this clause, or if you specify `NOT IDENTIFIED`, then no authorization is required when the role is enabled. Roles can be specified to be authorized by the following:

- The database using a password
- An application using a specified package
- Externally by the operating system, network, or other external source
- Globally by an enterprise directory service

As an alternative to creating password-protected roles, Oracle recommends that you use secure application roles instead.

Note the following restrictions about the creation of roles:

- A role and a user cannot have the same name.
- The role name cannot start with the value of the `COMMON_USER_PREFIX` parameter (which defaults to `C##`) unless this role is a CDB common role.

Related Topics

- [Role Privileges and Secure Application Roles](#)
A secure application role can be enabled only by an authorized PL/SQL package or procedure.
- [Creating Secure Application Roles to Control Access to Applications](#)
A secure application role is only enabled through its associated PL/SQL package or procedure.
- [Rules for Creating Common Roles](#)
When you create a common role, you must follow special rules.

4.11.3.2 Creating a Role That Is Authenticated With a Password

You can create a password authenticated role by using the `IDENTIFIED BY` clause.

- To create a password-authenticated role, use the `CREATE ROLE` statement with the `IDENTIFIED BY` clause.

For example:

```
CREATE ROLE clerk IDENTIFIED BY password;
```

Note:

- You can enable password-protected roles in a proxy session. Both secure application roles and password-protected roles provide a secure method for enabling a role in a session. Oracle recommends using secure password roles instead of password-protected roles where the password has to be maintained and transmitted over insecure channels or if more than one person needs to know the password. Password-protected roles in a proxy session are suitable for situations where automation is used to set the role.
- If you set the `SQLNET.ALLOWED_LOGON_VERSION_SERVER` parameter is to 11 or higher, then you must recreate roles that have been created with the `IDENTIFIED BY` clause.

Related Topics

- [Role Privileges and Secure Application Roles](#)
A secure application role can be enabled only by an authorized PL/SQL package or procedure.
- [Management of Case Sensitivity for Secure Role Passwords](#)
Oracle Database ensures that the passwords for secure roles are case sensitive.

4.11.3.3 Creating a Role That Has No Password Authentication

You can create a role that does not require a password by omitting the `IDENTIFIED BY` clause.

- Use the `CREATE ROLE` statement with no clauses to create a role that has no password authentication.

For example:

```
CREATE ROLE salesclerk;
```

4.11.3.4 Creating a Role That Is External or Global

External or global roles allow services that are outside the database to associate database roles to authenticated users.

Database external roles are associated with operating system and RADIUS groups. This way, database user authorization can be managed externally from the database.

An external user must be authorized by an external service, such as an operating system or a third-party service, before the external user can enable the role.

Global roles are used by globally authenticated users, using centrally managed users or Oracle Enterprise User Security. A global user must be authorized to use the role by the enterprise directory service before the role is enabled at login time.

Oracle recommends that you migrate to using Centrally Managed Users (CMU). This feature enables you to directly connect with Microsoft Active Directory without an intervening directory service for enterprise user authentication and authorization to the database. If your Oracle Database is in the cloud, you can also choose to move to one of the newer integrations with a cloud identity provider.

- To create a role that is to be authorized externally, include the `IDENTIFIED EXTERNALLY` clause in the `CREATE ROLE` statement.

For example:

```
CREATE ROLE clerk_external IDENTIFIED EXTERNALLY;
```

- To create a role to be authorized globally, use the `CREATE ROLE` statement.

For example:

```
CREATE ROLE clerk_global IDENTIFIED GLOBALLY;
```

You can authorize roles globally to a user through a directory service mapping such as with centrally managed users.

Related Topics

- [Grants of Roles Using the Operating System or Network](#)
Using the operating system or network to manage roles can help centralize the role management in a large enterprise.
- [Configuring RADIUS Authentication](#)
RADIUS is a client/server security protocol widely used to enable remote authentication and access.
- [Mapping a Directory Group to a Global Role](#)
Database global roles mapped to directory groups give member users additional privileges and roles above what they have been granted through their login schemas.
- *Oracle Database Enterprise User Security Administrator's Guide*

4.11.3.5 Altering a Role

The `ALTER ROLE` statement can modify the authorization method for a role.

To alter the authorization method for a role, you must have the `ALTER ANY ROLE` system privilege or have been granted the role with `ADMIN` option.

Remember that you can only directly grant secure application roles or password-authenticated roles to a user. Be aware that if you create a common role in the root, you cannot change it to a local role.

- To alter a role, use the `ALTER ROLE` statement.

For example, to alter the `clerk` role to specify that the user must be authorized by an external source before enabling the role:

```
ALTER ROLE clerk IDENTIFIED EXTERNALLY;
```

4.11.4 Specifying the Type of Role Authorization

You can configure a role to be authorized through different sources, such the database or an external source.

- [Authorizing a Role by Using the Database](#)
You can protect a role authorized by the database by assigning the role a password.
- [Authorizing a Role by Using an Application](#)
An application role can be enabled only by applications that use an authorized PL/SQL package.
- [Authorizing a Role by Using an External Source](#)
Oracle Database supports the use of external roles but with certain limitations.
- [Authorizing a Role by Using the Operating System](#)
Oracle Database supports role authentication through the operating system but with certain limitations.
- [Authorizing a Role by Using a Network Client](#)
Oracle Database supports role authentication by a network client but you must be aware of security risks.
- [Authorizing a Global Role by an Enterprise Directory Service](#)
A global role enables a global user to be authorized only by an enterprise directory service.

4.11.4.1 Authorizing a Role by Using the Database

You can protect a role authorized by the database by assigning the role a password.

If you are granted a role protected by a password, then you can enable or disable the role by supplying the proper password for the role in the `SET ROLE` statement. You cannot authenticate a password-authenticated role on logon, even if the role is a member of your list of default roles. You must explicitly enable it with the `SET ROLE` statement using the required password.

1. Use the `CREATE ROLE` statement with the `IDENTIFIED BY` clause to create the password-authenticated role.

For example:

```
CREATE ROLE hr_clerk IDENTIFIED BY password;
```

When the role is enabled, the password must be supplied.

2. Use the `SET ROLE` statement to set the password-authenticated role.

The following example shows how to set a password-authenticated role by using the `SET ROLE` statement.

```
SET ROLE hr_clerk IDENTIFIED BY password;
```

Related Topics

- [Guidelines for Securing Passwords](#)
Oracle provides guidelines for securing passwords in a variety of situations.

4.11.4.2 Authorizing a Role by Using an Application

An application role can be enabled only by applications that use an authorized PL/SQL package.

Application developers do not need to secure a role by embedding passwords inside applications. Instead, they can create an application role (secure application role) and specify which PL/SQL package is authorized to enable the role.

- To create a role enabled by an authorized PL/SQL package, use the `IDENTIFIED USING package_name` clause in the `CREATE ROLE` SQL statement.

For example, to indicate that the role `admin_role` is an application role and the role can only be enabled by any module defined inside the PL/SQL package `hr.admin`:

```
CREATE ROLE admin_role IDENTIFIED USING hr.admin;
```

Related Topics

- [Role Privileges and Secure Application Roles](#)
A secure application role can be enabled only by an authorized PL/SQL package or procedure.
- [Creating Secure Application Roles to Control Access to Applications](#)
A secure application role is only enabled through its associated PL/SQL package or procedure.

4.11.4.3 Authorizing a Role by Using an External Source

Oracle Database supports the use of external roles but with certain limitations.

You can define an external role locally in the database, but you cannot grant the external role to global users, to global roles, or to any other roles in the database. You can create roles that are authorized by the operating system or network clients.

- To authorize a role by using an external source, use the `CREATE ROLE` statement with the `IDENTIFIED EXTERNALLY` clause.

For example:

```
CREATE ROLE accts_rec IDENTIFIED EXTERNALLY;
```

4.11.4.4 Authorizing a Role by Using the Operating System

Oracle Database supports role authentication through the operating system but with certain limitations.

Role authentication through the operating system is useful only when the operating system is able to dynamically link operating system privileges with applications.

When a user starts an application, the operating system grants an operating system privilege to the user. The granted operating system privilege corresponds to the role associated with the application. At this point, the application can enable the application role. When the application is terminated, the previously granted operating system privilege is revoked from the operating system account of the user.

- If a role is authorized by the operating system, then configure information for each user at the operating system level. This operation is operating system dependent.

If roles are granted by the operating system, then you do not need to have the operating system authorize them also.

Related Topics

- [Grants of Roles Using the Operating System or Network](#)
Using the operating system or network to manage roles can help centralize the role management in a large enterprise.

4.11.4.5 Authorizing a Role by Using a Network Client

Oracle Database supports role authentication by a network client but you must be aware of security risks.

If users connect to the database over Oracle Net, then by default, the operating system cannot authenticate their roles. This includes connections through a shared server configuration, as this connection requires Oracle Net. This restriction is the default because a remote user could impersonate another operating system user over a network connection. Oracle recommends that you set `REMOTE_OS_ROLES` to `FALSE`, which is the default.

- If you are not concerned with this security risk and want to use operating system role authentication for network clients, then set the initialization parameter `REMOTE_OS_ROLES` in the database initialization parameter file to `TRUE`.

The `REMOTE_OS_ROLES` initialization parameter is deprecated in Oracle Database 23ai

The change takes effect the next time you start the instance and mount the database.

4.11.4.6 Authorizing a Global Role by an Enterprise Directory Service

A global role enables a global user to be authorized only by an enterprise directory service.

You define the global role locally in the database by granting privileges and roles to it, but you cannot grant the global role itself to any user or other role in the database. When a global user attempts to connect to the database, the enterprise directory is queried to obtain any global roles associated with the user. Global roles are one component of enterprise user security. A global role only applies to one database, but you can grant it to an enterprise role defined in the enterprise directory. An enterprise role is a directory structure that contains global roles on multiple databases and can be granted to enterprise users.

 **Note:**

Enterprise User Security (EUS) is deprecated with Oracle Database 23ai. Oracle recommends that you migrate to using Centrally Managed Users (CMU). This feature enables you to directly connect with Microsoft Active Directory without an intervening directory service for enterprise user authentication and authorization to the database. If your Oracle Database is in the cloud, you can also choose to move to one of the newer integrations with a cloud identity provider.

- To create a global role to be authorized by an enterprise directory service, use the `CREATE ROLE` statement with the `IDENTIFIED GLOBALLY` clause.

For example:

```
CREATE ROLE supervisor IDENTIFIED GLOBALLY;
```

Related Topics

- *Oracle Database Enterprise User Security Administrator's Guide*

4.11.5 Granting and Revoking Roles

You can grant or revoke privileges to and from roles, and then grant these roles to users or to other roles.

- [About Granting and Revoking Roles](#)
You can grant system or object privileges to a role, and grant any role to any database user or to another role.
- [Who Can Grant or Revoke Roles?](#)
The `GRANT ANY ROLE` system privilege enables users to grant or revoke any role except global roles to or from other users or roles.
- [Granting and Revoking Roles to and from Program Units](#)
You can grant roles to function, procedure, and PL/SQL package program units.

4.11.5.1 About Granting and Revoking Roles

You can grant system or object privileges to a role, and grant any role to any database user or to another role.

However, a role cannot be granted to itself, nor can the role be granted circularly, that is, role X cannot be granted to role Y if role Y has previously been granted to role X.

To provide selective availability of privileges, Oracle Database permits applications and users to enable and disable roles. Each role granted to a user is, at any given time, either enabled or disabled. The security domain of a user includes the privileges of all roles currently enabled for the user and excludes the privileges of any roles currently disabled for the user.

A role granted to a role is called an indirectly granted role. You can explicitly enable or disable it for a user. However, whenever you enable a role that contains other roles, you implicitly enable all indirectly granted roles of the directly granted role.

You grant roles by using the `GRANT` statement, and revoke them by using the `REVOKE` statement. Privileges are granted to and revoked from roles using the same statements.

You cannot grant a secure role (that is, an `IDENTIFIED BY role`, `IDENTIFIED USING role`, or `IDENTIFIED EXTERNALLY role`) to either another secure role or to a non-secure role. You can use the `SET ROLE` statement to enable the secure role for the session.

4.11.5.2 Who Can Grant or Revoke Roles?

The `GRANT ANY ROLE` system privilege enables users to grant or revoke any role except global roles to or from other users or roles.

A global role is managed in a directory, such as Oracle Internet Directory, but its privileges are contained within a single database. By default, the `SYS` or `SYSTEM` user has the `GRANT ANY ROLE` privilege. You should grant this system privilege conservatively because it is very powerful.

Any user granted a role with the `ADMIN OPTION` can grant or revoke that role to or from other users or roles of the database. This option allows administrative powers for roles to be granted on a selective basis.

Related Topics

- *Oracle Database Enterprise User Security Administrator's Guide*

4.11.5.3 Granting and Revoking Roles to and from Program Units

You can grant roles to function, procedure, and PL/SQL package program units.

The role then becomes enabled during the execution of the program unit, but not during the compilation of the program unit. This enables you to temporarily escalate privileges in the PL/SQL code without granting the role directly to the user. It also increases security for applications and helps to enforce the principle of least privilege.

- Use the `GRANT` or `REVOKE` statement to grant or revoke a role to a program unit.

The following example shows how to grant the same role to the PL/SQL package `checkstats_pkg`:

```
GRANT clerk_admin TO package psmith.checkstats_pkg;
```

This example shows how to revoke the `clerk_admin` role from the PL/SQL package `checkstats_pkg`:

```
REVOKE clerk_admin FROM package psmith.checkstats_pkg;
```

The following example shows how to grant the role `clerk_admin` to the procedure `psmith.check_stats_proc`.

```
GRANT clerk_admin TO PROCEDURE psmith.checkstats_proc;
```

Related Topics

- [Using Code Based Access Control for Definer's Rights and Invoker's Rights](#)
Code based access control, used to attach database roles to PL/SQL functions, procedures, or packages, works well with invoker's rights and definer's procedures.

4.11.6 Dropping Roles

Dropping a role affects the security domains of users or roles who had been granted the role.

That is, the security domains of all users and roles that were granted to the dropped role are changed to reflect the absence of the dropped role privileges.

All indirectly granted roles of the dropped role are also removed from affected security domains. Dropping a role automatically removes the role from all user default role lists.

Because the existence of objects is not dependent on the privileges received through a role, tables and other objects are not dropped when a role is dropped.

To drop a role, you must have the `DROP ANY ROLE` system privilege or have been granted the role with the `ADMIN` option.

- To drop a role, use the `DROP ROLE` statement.

For example, to drop the role `CLERK`:

```
DROP ROLE clerk;
```

4.11.7 Restricting SQL*Plus Users from Using Database Roles

You should restrict SQL*Plus users from using database roles, which helps to safeguard the database from intruder attacks.

- [Potential Security Problems of Using Ad Hoc Tools](#)
Ad hoc tools can pose problems if malicious users have access to such tools.
- [How the PRODUCT_USER_PROFILE System Table Can Limit Roles](#)
The `SYSTEM` schema `PRODUCT_USER_PROFILE` table can disable SQL and SQL*Plus commands in the SQL*Plus environment for each user.
- [How Stored Procedures Can Encapsulate Business Logic](#)
Stored procedures encapsulate privileges use with business logic so that privileges are only exercised in the context of a well-formed business transaction.

4.11.7.1 Potential Security Problems of Using Ad Hoc Tools

Ad hoc tools can pose problems if malicious users have access to such tools.

Prebuilt database applications explicitly control the potential actions of a user, including the enabling and disabling of user roles while using the application. By contrast, ad hoc query tools such as SQL*Plus, permit a user to submit any SQL statement (which may or may not succeed), including enabling and disabling a granted role.

Potentially, an application user can exercise the privileges attached to that application to issue destructive SQL statements against database tables by using an ad hoc tool.

For example, consider the following scenario:

- The Vacation application has a corresponding `vacation` role.
- The `vacation` role includes the privileges to issue `SELECT`, `INSERT`, `UPDATE`, and `DELETE` statements against the `emp_tab` table.
- The Vacation application controls the use of privileges obtained through the `vacation` role.

Now, consider a user who has been granted the `vacation` role. Suppose that, instead of using the Vacation application, the user runs SQL*Plus. At this point, the user is restricted only by the privileges granted to the user explicitly or through roles, including the `vacation` role. Because SQL*Plus is an ad hoc query tool, the user is not restricted to a set of predefined actions, as with designed database applications. The user can query or modify data in the `emp_tab` table as they choose.

4.11.7.2 How the PRODUCT_USER_PROFILE System Table Can Limit Roles

The `SYSTEM` schema `PRODUCT_USER_PROFILE` table can disable SQL and SQL*Plus commands in the SQL*Plus environment for each user.

SQL*Plus, not the Oracle Database, enforces this security. You can even restrict access to the `GRANT`, `REVOKE`, and `SET ROLE` commands to control user ability to change their database privileges.

The `PRODUCT_USER_PROFILE` table enables you to list roles that you do not want users to activate with an application. You can also explicitly disable the use of various commands, such as `SET ROLE`.

For example, you could create an entry in the `PRODUCT_USER_PROFILE` table to:

- Disallow the use of the `clerk` and `manager` roles with SQL*Plus
- Disallow the use of `SET ROLE` with SQL*Plus

Suppose user Marla connects to the database using SQL*Plus. Marla has the `clerk`, `manager`, and `analyst` roles. As a result of the preceding entry in `PRODUCT_USER_PROFILE`, Marla is only able to exercise the `analyst` role with SQL*Plus. Also, when Ginny attempts to issue a `SET ROLE` statement, this user is explicitly prevented from doing so because of the entry in the `PRODUCT_USER_PROFILE` table prohibiting use of `SET ROLE`.

Be aware that the `PRODUCT_USER_PROFILE` table does not completely guarantee security, for multiple reasons. (`PRODUCT_USER_PROFILE` was desupported in Oracle Database release 19c.) In the preceding example, while `SET ROLE` is disallowed with SQL*Plus, if Marla had other privileges granted to them directly, then they could exercise these using SQL*Plus.

Related Topics

- *SQL*Plus User's Guide and Reference*

4.11.7.3 How Stored Procedures Can Encapsulate Business Logic

Stored procedures encapsulate privileges use with business logic so that privileges are only exercised in the context of a well-formed business transaction.

For example, an application developer can create a procedure to update the employee name and address in the `employees` table, which enforces that the data can only be updated in normal business hours.

In addition, rather than grant a human resources clerk the `UPDATE` privilege on the `employees` table, a security administrator may grant the privilege on the procedure only. Then, the human resources clerk can exercise the privilege only in the context of the procedures, and cannot update the `employees` table directly.

4.11.8 Role Privileges and Secure Application Roles

A secure application role can be enabled only by an authorized PL/SQL package or procedure.

The PL/SQL package itself reflects the security policies that are necessary to control access to the application.

This method of role creation restricts the enabling of this type of role to the invoking application. For example, the application can perform authentication and customized authorization, such as checking whether the user has connected through a proxy.

This type of role strengthens security because passwords are not embedded in application source code or stored in a table. This way, the actions the database performs are based on the implementation of your security policies, and these definitions are stored in one place, the database, rather than in your applications. If you need to modify the policy, you do so in one place without having to modify your applications. No matter how users connect to the database, the result is always the same, because the policy is bound to the role.

To enable the secure application role, you must run its underlying package by invoking it directly from the application when the user logs in, before the user exercises the privileges granted by the secure application role. You cannot use a logon trigger to enable a secure application role, nor can you have this type of role be a default role.

When you enable the secure application role, Oracle Database verifies that the authorized PL/SQL package is on the calling stack, that is, it verifies that the authorized PL/SQL package is issuing the command to enable the role.

You can use secure application roles to ensure the existence of a database connection. Because a secure application role is a role implemented by a package, the package can validate that users can connect to the database through a middle tier or from a specific IP address. In this way, the secure application role prevents users from accessing data outside an application. They are forced to work within the framework of the application privileges that they have been granted.

Related Topics

- [Creating Secure Application Roles to Control Access to Applications](#)
A secure application role is only enabled through its associated PL/SQL package or procedure.

4.12 Managing Common Roles and Local Roles

A common role is a role that is created in the root; a local role is created in a PDB.

- [About Common Roles and Local Roles](#)
Database roles can be specific to a PDB or used throughout the entire system container or application container.
- [Common Roles in a CDB](#)
A common role exists either in the CDB root or an application root, and applies to every PDB within the root container (either the CDB or the application container).
- [How Common Roles Work](#)
Common roles are visible in the root and in every PDB of a container within which they are defined.
- [How the PUBLIC Role Works in a Multitenant Environment](#)
All privileges that Oracle grants to the `PUBLIC` role are granted locally.
- [Privileges Required to Create, Modify, or Drop a Common Role](#)
Only common users who have the commonly granted `CREATE ROLE`, `ALTER ROLE`, and `DROP ROLE` privileges can create, alter, or drop common roles.
- [Rules for Creating Common Roles](#)
When you create a common role, you must follow special rules.
- [Creating a Common Role](#)
You can use the `CREATE ROLE` statement to create a common role.
- [Rules for Creating Local Roles](#)
To create a local role, you must follow special rules.

- [Local Roles in a CDB](#)
A **local role** exists only in a single PDB, and is thus completely independent of local roles in any other PDBs.
- [Creating a Local Role](#)
You can use the `CREATE ROLE` statement to create a role.
- [Role Grants and Revokes for Common Users and Local Users](#)
Role grants and revokes apply only to the scope of access of the common user or the local user.

4.12.1 About Common Roles and Local Roles

Database roles can be specific to a PDB or used throughout the entire system container or application container.

A common role is a role whose identity and (optional) password are created in the root of a container and will be known in the root and in all existing and future PDBs belonging to that container.

A local role exists in only one PDB and can only be used within this PDB. It does not have any commonly granted privileges.

Note the following:

- Common users can both create and grant common roles to other common and local users.
- You can grant a role (local or common) to a local user or role only locally.
- If you grant a common role locally, then the privileges of that common role apply only in the container where the role is granted.
- Local users cannot create common roles, but they can grant them to common and other local users.
- The `CONTAINER = ALL` clause is the default when you create a common role in the CDB root or an application root.
- Every Oracle-supplied role is common, for example, the predefined `DBA` role. In Oracle-supplied scripts, every privilege or role granted to Oracle-supplied users and roles is granted commonly, with one exception: system privileges are granted locally to the common role `PUBLIC`.

Related Topics

- [Predefined Roles in an Oracle Database Installation](#)
Oracle Database provides a set of predefined roles to help in database administration.

4.12.2 Common Roles in a CDB

A common role exists either in the CDB root or an application root, and applies to every PDB within the root container (either the CDB or the application container).

Common roles are useful for cross-container operations, ensuring that a common user has a role in every PDB. Every common role is one of the following types:

- Oracle-supplied
All Oracle-supplied roles, such as `DBA` and `PUBLIC`, are common to the CDB.
- User-created

Create a common role by executing `CREATE ROLE ... CONTAINER=ALL` in either the CDB root or application root, which determines the container to which the role is common. The standard naming conventions apply. Additionally, the names of CDB common roles must begin with the characters specified by the `COMMON_USER_PREFIX` initialization parameter, which are `c##` or `C##` by default.

The scope of the role is the scope of the root within which it is defined. If you define the role in `CDB$ROOT`, then its scope is the entire CDB. If you define the role within application root, then its scope is the application container.

4.12.3 How Common Roles Work

Common roles are visible in the root and in every PDB of a container within which they are defined.

A privilege can be granted commonly to a common role if:

- The grantor is a common user.
- The grantor possesses the commonly granted `ADMIN OPTION` for the privilege that is being granted.
- The `GRANT` statement contains the `CONTAINER=ALL` clause.

If the common role contains locally granted privileges, then these privileges apply only within the PDB in which they were granted to the common role. A local role cannot be granted commonly.

For example, suppose the CDB common user `c##hr_mgr` has been commonly granted the `DBA` role. This means that user `c##hr_mgr` can use the privileges associated with the `DBA` role in the root and in every PDB in the container. However, if the CDB common user `c##hr_mgr` has only been locally granted the `DBA` role for the `hr_pdb` PDB, then this user can only use the `DBA` role's privileges in the `hr_pdb` PDB.

4.12.4 How the PUBLIC Role Works in a Multitenant Environment

All privileges that Oracle grants to the `PUBLIC` role are granted locally.

This feature enables you to revoke privileges or roles that have been granted to the `PUBLIC` role individually in each PDB as needed. If you must grant any privileges to the `PUBLIC` role, then grant them locally. Never grant privileges to `PUBLIC` commonly.

Related Topics

- [About Commonly and Locally Granted Privileges](#)
Both common users and local users can grant privileges to one another.

4.12.5 Privileges Required to Create, Modify, or Drop a Common Role

Only common users who have the commonly granted `CREATE ROLE`, `ALTER ROLE`, and `DROP ROLE` privileges can create, alter, or drop common roles.

Common users can also create local roles, but these roles are available only in the PDB in which they were created.

4.12.6 Rules for Creating Common Roles

When you create a common role, you must follow special rules.

The rules are as follows:

- **Ensure that you are in the correct root.** For the creation of common roles, you must be in the correct root, either the CDB root or the application root. You cannot create common roles from a PDB. To check if you are in the correct root, run one of the following:
 - To confirm that you are in the CDB root, you can issue the `show_con_name` command. The output should be `CDB$ROOT`.
 - To confirm that you are in an application root, verify that the following query returns YES:

```
SELECT APPLICATION_ROOT FROM V$PDBS WHERE CON_ID=SYS_CONTEXT('USERENV', 'CON_ID');
```
 - **Ensure that the name that you give the common role starts with the value of the `COMMON_USER_PREFIX` parameter (which defaults to `C##`).** Note that this requirement does not apply to the names of existing Oracle-supplied roles, such as `DBA` or `RESOURCE`.
- **Optionally, set the `CONTAINER` clause to `ALL`.** As long as you are in the root, if you omit the `CONTAINER = ALL` clause, then by default the role is created as a common role for the CDB root or the application root.

4.12.7 Creating a Common Role

You can use the `CREATE ROLE` statement to create a common role.

1. Connect to the root of the CDB or the application container in which you want to create the common role.

For example:

```
CONNECT SYSTEM
Enter password: password
Connected.
```

2. Run the `CREATE ROLE` statement with the `CONTAINER` clause set to `ALL`.

For example:

```
CREATE ROLE c##sec_admin IDENTIFIED BY password CONTAINER=ALL;
```

Related Topics

- [Creating a Role](#)
You can create a role that is authenticated with or without a password. You also can create external or global roles.
- [Creating a Common Role in Enterprise Manager](#)
Common roles can be used to assign common privileges to common users.

4.12.8 Rules for Creating Local Roles

To create a local role, you must follow special rules.

These rules are as follows:

- You must be connected to the PDB in which you want to create the role, and have the `CREATE ROLE` privilege.
- The name that you give the local role must not start with the value of the `COMMON_USER_PREFIX` parameter (which defaults to `C##`).
- You can include `CONTAINER=CURRENT` in the `CREATE ROLE` statement to specify the role as a local role. If you are connected to a PDB and omit this clause, then the `CONTAINER=CURRENT` clause is implied.
- You cannot have common roles and local roles with the same name. However, you can use the same name for local roles in different PDBs. To find the names of existing roles, query the `CDB_ROLES` and `DBA_ROLES` data dictionary views.

4.12.9 Local Roles in a CDB

A **local role** exists only in a single PDB, and is thus completely independent of local roles in any other PDBs.

A local role can only contain roles and privileges that apply within the container in which the role exists. For example, if you create the local role `pdadmin` in `hrpdb`, then the scope of this role is restricted to this PDB.

PDBs in the same CDB, or in the same application container, may contain local roles with the same name. For example, the user-created role `pdadmin` may exist in both `hrpdb` and `salespdb`. However, these roles are completely independent of each other.

4.12.10 Creating a Local Role

You can use the `CREATE ROLE` statement to create a role.

1. Connect to the PDB in which you want to create the local role.

For example:

```
CONNECT sec_admin@pdb_name
Enter password: password
Connected.
```

To find the available PDBs in a CDB, log in to the CDB root container and then query the `PDB_NAME` column of the `DBA_PDBS` data dictionary view. To check the current container, run the `show con_name` command.

2. Run the `CREATE ROLE` statement with the `CONTAINER` clause set to `CURRENT`.

For example:

```
CREATE ROLE sec_admin CONTAINER=CURRENT;
```

4.12.11 Role Grants and Revokes for Common Users and Local Users

Role grants and revokes apply only to the scope of access of the common user or the local user.

Common users can grant and revoke common roles to and from other common users. A local user can grant a common role to any user in a PDB, including common users, but this grant applies only within the PDB.

The following example shows how to grant the common user `c##sec_admin` the `AUDIT_ADMIN` common role for use in all containers.

```
CONNECT SYSTEM
Enter password: password
Connected.
```

```
GRANT AUDIT_ADMIN TO c##sec_admin CONTAINER=ALL;
```

Similarly, the next example shows how local user `aud_admin` can grant the common user `c##sec_admin` the `AUDIT_ADMIN` common role for use within the `hrpdb` PDB.

```
CONNECT aud_admin@hrpdb
Enter password: password
Connected.
```

```
GRANT AUDIT_ADMIN TO c##sec_admin CONTAINER=CURRENT;
```

This example shows how a local user `aud_admin` can revoke a role from another user in a PDB. If you omit the `CONTAINER` clause, then `CURRENT` is implied.

```
CONNECT aud_admin@hrpdb
Enter password: password
Connected.
```

```
REVOKE sec_admin FROM psmith CONTAINER=CURRENT;
```

Related Topics

- [Revoking Common Privilege Grants in Enterprise Manager](#)
You can revoke common privilege grants from the root.

4.13 Restricting Operations on PDBs Using PDB Lockdown Profiles

You can use PDB lockdown profiles to restrict sets of user operations in pluggable databases (PDBs).

- [About PDB Lockdown Profiles](#)
A PDB lockdown profile is a named set of features that controls a group of operations.
- [How PDB Lockdown Profiles Work](#)
PDB lockdown profiles are designed to restrict access at different levels for features that use shared identities.
- [PDB_OS_CREDENTIAL Initialization Parameter](#)
When the database accesses an external procedure with the `extproc` agent, the `PDB_OS_CREDENTIAL` initialization parameter determines the identity of the operating system user employed when interacting with the operating system from a PDB.
- [Features That Benefit from PDB Lockdown Profiles](#)
Features that use shared identities benefit from PDB lockdown profiles.

- [PDB Lockdown Profile Inheritance](#)
PDB lockdown profiles have inheritance behaviors between the CDB root, the application root, and their associated PDBs.
- [Default PDB Lockdown Profiles](#)
Oracle Database provides a set of default PDB lockdown profiles that you can customize for your site requirements.
- [Creating a PDB Lockdown Profile](#)
To create a PDB lockdown profile, you must have the `CREATE LOCKDOWN PROFILE` system privilege.
- [Enabling or Disabling a PDB Lockdown Profile](#)
To enable or disable a PDB lockdown profile, use the `PDB_LOCKDOWN` initialization parameter
- [Dropping a PDB Lockdown Profile](#)
To drop a PDB lockdown profile, you must have the `DROP LOCKDOWN PROFILE` system privilege and be logged into the CDB or application root.

4.13.1 About PDB Lockdown Profiles

A PDB lockdown profile is a named set of features that controls a group of operations.

A PDB lockdown profile restricts the features and options available to users in a PDB. The `PDB_OS_CREDENTIAL` initialization parameter can specify a unique operating system user for a PDB to limit operating system access. Also, when the `PATH_PREFIX` and `CREATE_FILE_DEST` clauses are specified during PDB creation, they limit file system access.

In some cases, you can enable or disable operations individually. For example, a PDB lockdown profile can contain settings to disable specific clauses that come with the `ALTER SYSTEM` statement.

PDB lockdown profiles restrict user access to the functionality the features provided, similar to resource limits that are defined for users. As the name suggests, you use PDB lockdown profiles in a CDB, for an application container, or for a PDB or application PDB. You can create custom profiles to accommodate the requirements of your site. PDB profiles enable you to define custom security policies for an application. In addition, you can create a lockdown profile that is based on another profile, called a **base profile**. You can configure this profile to be dynamically updated when the base profile is modified, or configure it to be static (unchanging) when the base profile is updated. Lockdown profiles are designed for both Oracle Cloud and on-premises environments.

The general procedure for creating a PDB lockdown profile is to first create it in the CDB root or the application root using the `CREATE LOCKDOWN PROFILE` statement, and then use the `ALTER LOCKDOWN PROFILE` statement to add the restrictions.

To enable a PDB lockdown profile, you can use the `ALTER SYSTEM` statement to set the `PDB_LOCKDOWN` parameter. You can find information about existing PDB lockdown profiles by connecting to CDB or application root and querying the `DBA_LOCKDOWN_PROFILES` data dictionary view. A local user can find the contents of a PDB lockdown parameter by querying the `V$LOCKDOWN_RULES` dynamic data dictionary view.

4.13.2 How PDB Lockdown Profiles Work

PDB lockdown profiles are designed to restrict access at different levels for features that use shared identities.

A use case for might be the creation of lockdown profiles at high, medium, and low levels. The high level might greatly restrict access, whereas the low level might enable access.

When logged in to the CDB root or application root, create a lockdown profile by issuing the `CREATE LOCKDOWN PROFILE` statement, which supports the following optional clauses:

- `FROM static_base_profile` creates a new lockdown profile by using the values from an existing profile. Any subsequent changes to the existing profile will not affect the new profile.
- `INCLUDING dynamic_base_profile` creates a new lockdown profile by using the values from an existing profile, except that this new lockdown profile inherits the `DISABLE STATEMENT` rules that comprise the base profile, and any subsequent changes to the base profile.

The user issuing the statement must have the `CREATE LOCKDOWN PROFILE` system privilege in the current container. You can add and remove restrictions with the `ALTER LOCKDOWN PROFILE` statement. The user must issue the `ALTER` statement in the CDB root or application root and must have the `ALTER LOCKDOWN PROFILE` system privilege in the current container.

Specify a lockdown profile by using the `PDB_LOCKDOWN` initialization parameter. This parameter determines whether the PDB lockdown profile applies to a given PDB. You can set this parameter at the following levels:

- **PDB**
The profile applies only to the PDB in which it is set.
- **Application container**
The profile applies to all application PDBs in the application container. The value can be modified only by an application common user who has application common `SYSDBA` or common `ALTER SYSTEM` privileges or a CDB common user who has common `SYSDBA` or common `ALTER SYSTEM` privileges.
- **CDB**
The profile applies to all PDBs. A common user who has common `SYSDBA` or common `ALTER SYSTEM` privileges can override a CDB-wide setting for a specific PDB.

If the `PDB_LOCKDOWN` parameter in a PDB is set to the name of a lockdown profile different from the container for this PDB (CDB or application container), then a set of rules govern the interaction between restrictions.

Example 4-5 Creating a PDB Lockdown Profile

In this example, you connect to the CDB root as a common user with the `CREATE LOCKDOWN PROFILE` privilege. You create a profile called `medium` that disables all `ALTER SYSTEM` statements except for `ALTER SYSTEM FLUSH SHARED POOL`:

```
CREATE LOCKDOWN PROFILE medium;
ALTER LOCKDOWN PROFILE medium DISABLE STATEMENT=('ALTER SYSTEM');
ALTER LOCKDOWN PROFILE medium ENABLE STATEMENT=('ALTER SYSTEM')
CLAUSE=('FLUSH SHARED POOL');
```

You can connect as the same common user to each PDB that requires this profile, and then use `ALTER SYSTEM` to set the `PDB_LOCKDOWN` initialization parameter to `medium`. For example, you could set `PDB_LOCKDOWN` to `medium` for `hrpdb`, but not `salespdb`.

The following example creates a `medium2` profile from `medium`:

```
CREATE LOCKDOWN PROFILE medium2 FROM medium;
```

4.13.3 PDB_OS_CREDENTIAL Initialization Parameter

When the database accesses an external procedure with the `extproc` agent, the `PDB_OS_CREDENTIAL` initialization parameter determines the identity of the operating system user employed when interacting with the operating system from a PDB.

Using an operating system user described by a credential whose name is specified as a value of the `PDB_OS_CREDENTIAL` initialization parameter can ensure that operating system interactions are performed as a less powerful user. In this way, the feature protects data belonging to one PDB from being accessed by users connected to another PDB. A credential is an object that is created using the `CREATE_CREDENTIAL` procedure in the `DBMS_CREDENTIAL` package.

The Oracle operating system user is usually a highly privileged user. Using this account for operating system interactions is not recommended. Also, using the same OS user for operating system interactions from different PDBs might compromise data belonging to a given PDB.

4.13.4 Features That Benefit from PDB Lockdown Profiles

Features that use shared identities benefit from PDB lockdown profiles.

A potential for elevation of privileges exists when PDBs share an identity. For example, identity can be shared at a network level, or when PDBs access common objects or connect through database links. To increase security, a CDB administrator may want to compartmentalize access, thereby restricting the operations that a user can perform in a PDB.

When identities are shared between PDBs, elevated privileges may exist. You can use lockdown profiles to prevent this elevation of privileges. Identities can be shared in the following situations:

- At the operating system level, when the database interacts with operating system resources such as files or processes
- At the network level, when the database communicates with other systems, and network identity is important
- Inside the database, as PDBs access or create common objects or they communicate across container boundaries using features such as database links

The features that use shared identities and that benefit from PDB lockdown profiles are in several categories.

- **Network access features.** These are operations that use the network to communicate outside the PDB. For example, the PL/SQL packages `UTL_TCP`, `UTL_HTTP`, `UTL_MAIL`, `UTL_SNMP`, `UTL_INADDR`, and `DBMS_DEBUG_JDWP` perform these kinds of operations. Currently, ACLs are used to control this kind of access to share network identity.
- **Common user or object access.** These are operations in which a local user in the PDB can proxy through common user accounts or access objects in a common schema. These kinds of operations include adding or replacing objects in a common schema, granting privileges to common objects, accessing common directory objects, granting the `INHERIT PRIVILEGES` role to a common user, and manipulating a user proxy to a common user.

- **Operating System access.** For example, you can restrict access to the `UTL_FILE` or `DBMS_FILE_TRANSFER` PL/SQL packages.
- **Connections.** For example, you can restrict common users from connecting to the PDB or you can restrict a local user who has the `SYSOPER` administrative privilege from connecting to a PDB that is open in restricted mode.
- **Administrative features.** For example, you can restrict the use of `ALTER SYSTEM`, `ALTER SESSION`, and `ALTER DATABASE`.
- **Database options.** For example, you can use lockdown profiles to disable access to database options such as Oracle Partitioning or Oracle Database Advanced Queuing.

4.13.5 PDB Lockdown Profile Inheritance

PDB lockdown profiles have inheritance behaviors between the CDB root, the application root, and their associated PDBs.

- The inheritance path between PDBs and their respective roots is as follows:
 - The `PDB_LOCKDOWN` parameter setting in a CDB PDB takes precedence over the `PDB_LOCKDOWN` parameter setting in the CDB root. Similarly, the `PDB_LOCKDOWN` setting in an application PDB takes precedence over a `PDB_LOCKDOWN` setting in the application root.
 - If a CDB PDB (or an application PDB) does not have the `PDB_LOCKDOWN` parameter set, then the PDB inherits the settings of the `PDB_LOCKDOWN` parameter in the CDB root (or the application root).
 - If the application root does not have the `PDB_LOCKDOWN` parameter set, then the application root inherits the settings of the `PDB_LOCKDOWN` parameter in the CDB root.
- If the `PDB_LOCKDOWN` parameter in a CDB PDB or an application PDB is set to a CDB lockdown profile, then the PDB ignores any lockdown profiles that are set by the `PDB_LOCKDOWN` parameter in the CDB root or the application root.
- PDB lockdown parameters can inherit rules that are stipulated in an application lockdown profile, including the disable rules that come from a CDB lockdown profile that was set in its nearest ancestor (that is, an application root or the CDB root). This applies in the case of when a `PDB_LOCKDOWN` parameter in an application PDB is set to an application lockdown profile while the `PDB_LOCKDOWN` parameter in the application root or the CDB root is set to a CDB lockdown profile.
- Sometimes a conflict arises between the rules that comprise a CDB lockdown profile and an application lockdown profile. In this case, the rules in the CDB lockdown profile take precedence. For example, the setting for an `OPTION_VALUE` clause in the CDB lockdown profile takes precedence over the setting for the `OPTION_VALUE` clause in an application lockdown profile.

4.13.6 Default PDB Lockdown Profiles

Oracle Database provides a set of default PDB lockdown profiles that you can customize for your site requirements.

By default, most of these profiles are empty. They are designed to be a placeholder or template for you to configure, depending on your deployment requirements.

Detailed information about these profiles is as follows:

- `PRIVATE_DBAAS` incorporates restrictions that are suitable for private Cloud Database-as-a-Service (DBaaS) deployments. These restrictions are:
 - Must have the same database administrator for each PDB
 - Different users permitted to connect to the database
 - Different applications permitted

`PRIVATE_DBAAS` permits users to connect to the PDBs but prevents them from using Oracle Database administrative features.

- `SAAS` incorporates restrictions that are suitable for Software-as-a-Service (SaaS) deployments. These restrictions are:
 - Must have the same database administrator for each PDB
 - Different users permitted to connect to the database
 - Must use the same application

The `SAAS` lockdown profile is more restrictive than the `PRIVATE_DBAAS` profile. Users can be different, but the application code is the same; users are prevented from directly connecting and must connect only through the application; and users are not granted the ability to perform any administrative features.

- `PUBLIC_DBAAS` incorporates restrictions that are suitable for public Cloud Database-as-a-Service (DBaaS) deployments. The restrictions are as follows:
 - Different DBAs in each PDB
 - Different users
 - Different applications

The `PUBLIC_DBAAS` lockdown profile is the most restrictive of the lockdown profiles.

4.13.7 Creating a PDB Lockdown Profile

To create a PDB lockdown profile, you must have the `CREATE LOCKDOWN PROFILE` system privilege.

After you create the lockdown profile, you can add restrictions before enabling it.

1. Connect to the CDB root or the application root as a user who has the `CREATE LOCKDOWN PROFILE` system privilege.

For example, to connect to the CDB root:

```
CONNECT c##sec_admin
Enter password: password
```

2. Run the `CREATE LOCKDOWN PROFILE` statement to create the profile by using the following syntax:

```
CREATE LOCKDOWN PROFILE profile_name
[FROM static_base_profile | INCLUDING dynamic_base_profile];
```

In this specification:

- *profile_name* is the name that you assign the lockdown profile. You can find existing names by querying the `PROFILE_NAMES` column of the `DBA_LOCKDOWN_PROFILES` data dictionary view.

- FROM *static_base_profile* creates a new lockdown profile by using the values from an existing profile. Any subsequent changes to the base profile will not affect the new profile.
- INCLUDING *dynamic_base_profile* also creates a new lockdown profile by using the values from an existing base profile, except that this new lockdown profile will inherit the `DISABLE STATEMENT` rules that comprise the base profile, as well as any subsequent changes to the base profile. If rules that are explicitly added to the new profile conflict with the rules in the base profile, then the rules in the base profile take precedence. For example, an `OPTION_VALUE` clause in the base profile takes precedence over the `OPTION_VALUE` clause in the new profile.

The following two PDB lockdown profile statements demonstrate how the inheritance works:

```
CREATE LOCKDOWN PROFILE hr_prof INCLUDING PRIVATE_DBAAS;  
CREATE LOCKDOWN PROFILE hr_prof2 FROM hr_prof;
```

In the first statement, `hr_prof` inherits any changes made to the `PRIVATE_DBAAS` base profile. If a new statement is enabled for `PRIVATE_DBAAS`, then it is enabled for `hr_prof`. In the second statement, in contrast, when `hr_prof` changes, then `hr_prof2` does *not* change because it is independent of its base profile.

3. Run the `ALTER LOCKDOWN PROFILE` statement to provide restrictions for the profile.

For example:

```
ALTER LOCKDOWN PROFILE hr_prof DISABLE STATEMENT = ('ALTER SYSTEM');  
ALTER LOCKDOWN PROFILE hr_prof ENABLE STATEMENT = ('ALTER SYSTEM') clause  
= ('flush shared_pool');  
ALTER LOCKDOWN PROFILE hr_prof DISABLE FEATURE = ('XDB_PROTOCOLS');
```

In the preceding example:

- `DISABLE STATEMENT = ('ALTER SYSTEM')` disables the use of all `ALTER SYSTEM` statements for the PDB.
- `ENABLE STATEMENT = ('ALTER SYSTEM') clause = ('flush shared_pool')` enables only the use of the `FLUSH_SHARED_POOL` clause for `ALTER SYSTEM`.
- `DISABLE FEATURE = ('XDB_PROTOCOLS')` prohibits the use of the XDB protocols (FTP, HTTP, HTTPS) by this PDB

After you create a PDB lockdown profile, you are ready to enable it by using the `ALTER SYSTEM SET PDB_LOCKDOWN SQL` statement.

4.13.8 Enabling or Disabling a PDB Lockdown Profile

To enable or disable a PDB lockdown profile, use the `PDB_LOCKDOWN` initialization parameter

You can use `ALTER SYSTEM SET PDB_LOCKDOWN` to enable a lockdown profile in any of the following contexts:

- CDB (affects all PDBs)
- Application root (affects all application PDBs in the container)
- Application PDB

- PDB

 **Note:**

It is not necessary to restart the instance to enable the profile. When the `ALTER SYSTEM SET PDB_LOCKDOWN` statement completes, the profile rules take effect immediately.

When you set `PDB_LOCKDOWN` in the CDB root, every PDB and application root inherits this setting unless `PDB_LOCKDOWN` is set at the container level. To disable lockdown profiles, set `PDB_LOCKDOWN` to null. If you set this parameter to null in the CDB root, then lockdown profiles are disabled for all PDBs except those that explicitly set a profile within the PDB.

A CDB common user who has been commonly granted the `SYSDBA` administrative privilege or the `ALTER SYSTEM` system privilege can set `PDB_LOCKDOWN` only to a lockdown profile that was created in the CDB root. An application common user with the application common `SYSDBA` administrative privilege or the `ALTER SYSTEM` system privilege can set `PDB_LOCKDOWN` only to a lockdown profile created in an application root.

1. Log in to the desired container as a user who has the commonly granted `ALTER SYSTEM` or commonly granted `SYSDBA` privilege.

For example, to enable the profile for all PDBs, log in to the CDB root:

```
CONNECT c##sec_admin
Enter password: password
```

2. Run the `ALTER SYSTEM SET PDB_LOCKDOWN` statement.

For example, the following statement enables the lockdown profile named `hr_prof` for all PDBs:

```
ALTER SYSTEM SET PDB_LOCKDOWN = hr_prof;
```

The following statement resets the `PDB_LOCKDOWN` parameter:

```
ALTER SYSTEM RESET PDB_LOCKDOWN;
```

This variation of the preceding statement includes the `SCOPE` clause::

```
ALTER SYSTEM RESET PDB_LOCKDOWN SCOPE = BOTH;
```

The following statement disables all lockdown profiles in the CDB except those that are explicitly set at the PDB level:

```
ALTER SYSTEM SET PDB_LOCKDOWN = '' SCOPE = BOTH;
```

To find the names of PDB lockdown profiles, query the `PROFILE_NAME` column of the `DBA_LOCKDOWN_PROFILES` data dictionary view.

3. Optionally, review information about the profiles by querying `DBA_LOCKDOWN_PROFILES`.

For example, run the following query:

```
SET LINESIZE 150
COL PROFILE_NAME FORMAT a20
COL RULE FORMAT a20
COL CLAUSE FORMAT a25

SELECT PROFILE_NAME, RULE, CLAUSE, STATUS FROM CDB_LOCKDOWN_PROFILES;
```

Sample output appears below:

PROFILE_NAME	RULE	CLAUSE	STATUS
HR_PROF	XDB_PROTOCOLS		DISABLE
HR_PROF	ALTER SYSTEM		DISABLE
HR_PROF	ALTER SYSTEM	FLUSH SHARED_POOL	ENABLE
HR_PROF2			EMPTY
PRIVATE_DBAAS			EMPTY
PUBLIC_DBAAS			EMPTY
SAAS			EMPTY

4.13.9 Dropping a PDB Lockdown Profile

To drop a PDB lockdown profile, you must have the `DROP LOCKDOWN PROFILE` system privilege and be logged into the CDB or application root.

You can find the names of existing PDB lockdown profiles by querying the `DBA_LOCKDOWN_PROFILES` data dictionary view.

1. Connect to the CDB root or the application root as a user who has the `DROP LOCKDOWN PROFILE` system privilege.

For example, to connect to the CDB root:

```
CONNECT c##sec_admin
Enter password: password
```

2. Run the `DROP LOCKDOWN PROFILE` statement.

For example:

```
DROP LOCKDOWN PROFILE hr_prof2;
```

3. Optionally, review the current list of profiles by querying `DBA_LOCKDOWN_PROFILES`.

For example, run the following query:

```
SET LINESIZE 150
COL PROFILE_NAME FORMAT a20
COL RULE FORMAT a20
COL CLAUSE FORMAT a25

SELECT PROFILE_NAME, RULE, CLAUSE, STATUS FROM CDB_LOCKDOWN_PROFILES;
```

Sample output appears below:

PROFILE_NAME	RULE	CLAUSE	STATUS
HR_PROF	XDB_PROTOCOLS		DISABLE
HR_PROF	ALTER SYSTEM		DISABLE
HR_PROF	ALTER SYSTEM	FLUSH SHARED_POOL	ENABLE
PRIVATE_DBAAS			EMPTY
PUBLIC_DBAAS			EMPTY
SAAS			EMPTY

4.14 Managing Object Privileges

Object privileges enable you to perform actions on schema objects, such as tables or indexes.

- [About Object Privileges](#)
An object privilege grants permission to perform a particular action on a specific schema object.
- [Who Can Grant Object Privileges?](#)
A user automatically has all object privileges for schema objects contained in their schema.
- [Grants and Revokes of Object Privileges](#)
You can grant privileges to or revoke privileges from objects either directly to a user or through roles.
- [READ and SELECT Object Privileges](#)
The `READ` and `SELECT` privileges provide different layers of query privileges.
- [Object Privilege Use with Synonyms](#)
The `CREATE SYNONYM` statement create synonyms for database objects.
- [Sharing Application Common Objects](#)
Database objects can be configured so that their metadata links, data links, and extended data links can be shared in the application root.

4.14.1 About Object Privileges

An object privilege grants permission to perform a particular action on a specific schema object.

Different object privileges are available for different types of schema objects. The privilege to delete rows from the `departments` table is an example of an object privilege.

Some schema objects, such as clusters, indexes, triggers, and database links, do not have associated object privileges. Their use is controlled with system privileges. For example, to alter a cluster, a user must own the cluster or have the `ALTER ANY CLUSTER` system privilege.

Some examples of object privileges include the right to:

- Use an edition
- Update a table
- Select rows from another user's table
- Run a stored procedure of another user

If you want to restrict privilege grants to all objects within a specific schema, then you can do so by granting the user or role a schema privilege for the schema. A schema privilege enables

you to perform one grant that will apply to all objects of a specific type within the schema. For example, a grant of the `CREATE ANY TABLE` privilege for the schema enables the user to create any tables within that schema.

Related Topics

- [How Commonly Granted Object Privileges Work](#)
Object privileges on common objects applies to the object as well as all associated links on this common object.
- [Managing Schema Privileges](#)
Schema privileges enable certain system privileges to be granted on a schema.
- *Oracle Database SQL Language Reference*

4.14.2 Who Can Grant Object Privileges?

A user automatically has all object privileges for schema objects contained in their schema.

A user with the `GRANT ANY OBJECT PRIVILEGE` system privilege can grant any specified object privilege to another user with or without the `WITH GRANT OPTION` clause of the `GRANT` statement. A user with the `GRANT ANY OBJECT PRIVILEGE` privilege can also use that privilege to revoke any object privilege that was granted either by the object owner or by some other user with the `GRANT ANY OBJECT PRIVILEGE` privilege.

If the grantee does not have the `GRANT ANY OBJECT PRIVILEGE` privilege or had been granted the privilege without the `WITH GRANT OPTION` clause of the `GRANT` statement, then this user cannot grant the privilege to other users.

The `WITH GRANT OPTION` can be used only with object privilege grants to users. It cannot be used for object privilege grants to roles.

Related Topics

- *Oracle Database SQL Language Reference*

4.14.3 Grants and Revokes of Object Privileges

You can grant privileges to or revoke privileges from objects either directly to a user or through roles.

- [About Granting and Revoking Object Privileges](#)
Object privileges can be granted to and revoked from users and roles.
- [How the ALL Clause Grants or Revokes All Available Object Privileges](#)
Each type of object has different privileges associated with it, which can be controlled by the `ALL` clause.

4.14.3.1 About Granting and Revoking Object Privileges

Object privileges can be granted to and revoked from users and roles.

If you grant object privileges to roles, then you can make the privileges selectively available To grant object privileges, you can use the `GRANT` statement; to revoke object privileges, you can use the `REVOKE` statement.

4.14.3.2 How the ALL Clause Grants or Revokes All Available Object Privileges

Each type of object has different privileges associated with it, which can be controlled by the `ALL` clause.

You can specify `ALL [PRIVILEGES]` to grant or revoke all available object privileges for an object. `ALL` is not a privilege. Rather, it is a shortcut, or a way of granting or revoking all object privileges with one `GRANT` and `REVOKE` statement. If all object privileges are granted using the `ALL` shortcut, then individual privileges can still be revoked.

Similarly, you can revoke all individually granted privileges by specifying `ALL`. However, if you `REVOKE ALL`, and revoking causes integrity constraints to be deleted (because they depend on a `REFERENCES` privilege that you are revoking), then you must include the `CASCADE CONSTRAINTS` option in the `REVOKE` statement.

[Example 4-6](#) revokes all privileges on the `orders` table in the `HR` schema using `CASCADE CONSTRAINTS`.

Example 4-6 Revoking All Object Privileges Using `CASCADE CONSTRAINTS`

```
REVOKE ALL
ON ORDERS FROM HR
CASCADE CONSTRAINTS;
```

4.14.4 READ and SELECT Object Privileges

The `READ` and `SELECT` privileges provide different layers of query privileges.

- [About Managing READ and SELECT Object Privileges](#)
You can grant users either the `READ` or the `SELECT` object privilege.
- [Enabling Users to Use the READ Object Privilege to Query Any Table in the Database](#)
The `READ ANY TABLE` system privilege provides the `READ` object privilege for querying any table in the database.
- [Restrictions on the READ and READ ANY TABLE Privileges](#)
There are special restrictions on the `READ` and `READ ANY TABLE` privileges.

4.14.4.1 About Managing READ and SELECT Object Privileges

You can grant users either the `READ` or the `SELECT` object privilege.

The grant of these privileges depend on the level of access that you want to allow the user.

Follow these guidelines:

- If you want the user only to be able to query tables, views, materialized views, or synonyms, then you should grant the `READ` object privilege. For example:

```
GRANT READ ON HR.EMPLOYEES TO psmith;
```

- If you want the user to be able to perform the following actions in addition to performing the query, then you should grant the user the `SELECT` object privilege:

```
– LOCK TABLE table_name IN EXCLUSIVE MODE;
– SELECT ... FROM table_name FOR UPDATE;
```

For example:

```
GRANT SELECT ON HR.EMPLOYEES TO psmith;
```

In either case, user `psmith` would use a `SELECT` statement to perform query.

Related Topics

- [Auditing the READ ANY TABLE and SELECT ANY TABLE Privileges](#)
The `CREATE AUDIT POLICY` statement can audit the `READ ANY TABLE` and `SELECT ANY TABLE` privileges.

4.14.4.2 Enabling Users to Use the READ Object Privilege to Query Any Table in the Database

The `READ ANY TABLE` system privilege provides the `READ` object privilege for querying any table in the database.

- To enable a user to have the `READ` object privilege for any table in the database, grant the user the `READ ANY TABLE` system privilege.

For example:

```
GRANT READ ANY TABLE TO psmith;
```

As with the `READ` object privilege, the `READ ANY TABLE` system privilege does not enable users to lock tables in exclusive mode nor select tables for update operations. Conversely, the `SELECT ANY TABLE` system privilege enables users to lock the rows of a table, or lock the entire table, through a `SELECT ... FOR UPDATE` statement, in addition to querying any table.

4.14.4.3 Restrictions on the READ and READ ANY TABLE Privileges

There are special restrictions on the `READ` and `READ ANY TABLE` privileges.

These privileges are as follows:

- The `READ` object privilege has no effect on the requirements of the `SQL92_SECURITY` standard. If the `SQL92_SECURITY` initialization parameter has been set to `TRUE`, then its requirement that users must be granted the `SELECT` object privilege in addition to `UPDATE` or `DELETE` in order to run the `UPDATE` or `DELETE` statements is not relaxed to require that `READ` is sufficient instead of `SELECT`.
- If Oracle Database Vault is enabled, remember that the `SQL92_SECURITY` initialization parameter is automatically set to `TRUE`. Hence, `UPDATE` and `DELETE` statements will fail if the user has only been granted the `READ` object privilege or the `READ ANY TABLE` system privilege. In this case, you must grant the user the `SELECT` object privilege or, if the user is a trusted user, the `SELECT ANY TABLE` system privilege.

4.14.5 Object Privilege Use with Synonyms

The `CREATE SYNONYM` statement create synonyms for database objects.

You can create synonyms for the following objects: tables, views, sequences, operators, procedures, stored functions, packages, materialized views, Java class schema objects, user-defined object types, or other synonyms.

If you grant users the privilege to use the synonym, then the object privileges granted on the underlying objects apply whether the user references the base object by name or by using the synonym.

For example, suppose user `OE` creates the following synonym for the `CUSTOMERS` table:

```
CREATE SYNONYM customer_syn FOR CUSTOMERS;
```

Then `OE` grants the `READ` privilege on the `customer_syn` synonym to user `HR`.

```
GRANT READ ON customer_syn TO HR;
```

User `HR` then tries either of the following queries:

```
SELECT COUNT(*) FROM OE.customer_syn;
```

```
SELECT COUNT(*) FROM OE.CUSTOMERS;
```

Both queries will yield the same result:

```
  COUNT(*)
-----
        319
```

Be aware that when you grant the synonym to another user, the grant applies to the underlying object that the synonym represents, not to the synonym itself. For example, if user `HR` queries the `ALL_TAB_PRIVS` data dictionary view for their privileges, this user will learn the following:

```
SELECT TABLE_SCHEMA, TABLE_NAME, PRIVILEGE
FROM ALL_TAB_PRIVS
WHERE TABLE_SCHEMA = 'OE';
```

TABLE_SCHEMA	TABLE_NAME	PRIVILEGE
OE	CUSTOMER	READ
OE	OE	INHERIT PRIVILEGES

The results show that in addition to other privileges, the user has the `READ` privilege for the underlying object of the `customer_syn` synonym, which is the `OE.CUSTOMER` table.

At this point, if user `OE` then revokes the `READ` privilege on the `customer_syn` synonym from `HR`, here are the results if `HR` checks their privileges again:

TABLE_SCHEMA	TABLE_NAME	PRIVILEGE
OE	OE	INHERIT PRIVILEGES

User `HR` no longer has the `READ` privilege for the `OE.CUSTOMER` table. If `HR` tries to query the `OE.CUSTOMERS` table, then the following error appears:

```
SELECT COUNT(*) FROM OE.CUSTOMERS;

ERROR at line 1:
ORA-00942: table or view does not exist
```

4.14.6 Sharing Application Common Objects

Database objects can be configured so that their metadata links, data links, and extended data links can be shared in the application root.

- [Metadata-Linked Application Common Objects](#)
A metadata link enables database objects in an application pluggable database (PDB) to share metadata with objects in the application root.

- [Data-Linked Application Common Objects](#)
Data links manage references and privileges for common objects.
- [Extended Data-Linked Application Common Objects](#)
Extended data links can combine data from an application pluggable database (PDB) with an application root.

Related Topics

- *Oracle Database Administrator's Guide*

4.14.6.1 Metadata-Linked Application Common Objects

A metadata link enables database objects in an application pluggable database (PDB) to share metadata with objects in the application root.

Metadata links are useful for reducing disk and memory requirements because they store only one copy of an object's metadata (such as the source code for a PL/SQL package) for identically defined objects (such as Oracle-supplied PL/SQL packages). This improves the performance of upgrade operations because changes to this metadata will be made in one place, the application root.

You must configure the metadata link from the application root. You can use the `DBMS_PDB.SET_METADATA_LINKED` PL/SQL procedure to change the database object to a metadata link.

The following example shows how to use the `DBMS_PDB.SET_METADATA_LINKED` procedure to change the `update_emp_rating` procedure in the `hr_mgr` schema to a metadata-linked application common object.

Example 4-7 Changing an Object to a Metadata-Linked Application Common Object

```
BEGIN
  DBMS_PDB.SET_METADATA_LINKED (
    SCHEMA_NAME => 'hr_mgr',
    OBJECT_NAME => 'update_emp_rating',
    NAMESPACE   => 1);
END;
/
```

Any common user can own metadata links. Metadata links can only be used to share the metadata of application common objects that their creator in the application root owns.

To find if an object has a metadata link, query the `SHARING` column of the `DBA_OBJECTS` data dictionary view.

Related Topics

- *Oracle Database PL/SQL Packages and Types Reference*

4.14.6.2 Data-Linked Application Common Objects

Data links manage references and privileges for common objects.

A data link (previously called an object link) enables references to, and privilege grants on, objects in an application root from an application pluggable database (PDB) that belong to the same application container.

If an application common user who owns an application common object wants to grant access to that object to a user in a PDB, then the application common user can accomplish this by granting the privilege on a data link that points to the common object. For example, you can

create data links for objects such as tables, views, clusters, sequences, or PL/SQL packages if you want to ensure that an operation on the object (such as a query, a DML, an `EXECUTE` statement, and so on) that refers to this operation affects the same object regardless of the container in which the operation is performed.

You must configure the data link from an application root. You can use the `DBMS_PDB.SET_DATA_LINKED` PL/SQL procedure to change the data link. You should use this procedure only when you want to convert an existing object to become data linked.

The following example shows how to use the `DBMS_PDB.SET_DATA_LINKED` procedure to change the `emp_ratings` table in the `hr_mgr` schema to a data-linked application common object.

Example 4-8 Changing an Object to a Data-Linked Application Common Object

```
BEGIN
  DBMS_PDB.SET_DATA_LINKED (
    SCHEMA_NAME => 'hr_mgr',
    OBJECT_NAME => 'emp_ratings',
    NAMESPACE   => 1);
END;
/
```

Any common user can own data links.

To find if an object has an data link, query the `SHARING` column of the `DBA_OBJECTS` data dictionary view. The `NAMESPACE` column of this view provides the namespace number.

Related Topics

- *Oracle Database PL/SQL Packages and Types Reference*

4.14.6.3 Extended Data-Linked Application Common Objects

Extended data links can combine data from an application pluggable database (PDB) with an application root.

An extended data link enables a data link to combine data found in a table in the PDB with data from a corresponding table in the application root.

You can think of an extended data link as a hybrid of a metadata link and a data link. An extended data-link object in an application PDB inherits metadata from the extended data link object in the application root. The data for the object is stored in the application root and, optionally, in each application PDB. You can create extended data links for tables and views only. When you query the `DBA_OBJECTS` data dictionary view for an extended data link object, this view returns extended data link-related rows from both the application PDB and the application root.

You must configure the extended data link from an application root. You can use the `DBMS_PDB.SET_EXT_DATA_LINKED` PL/SQL procedure to change the database object to an extended data link.

The following example shows how to use the `DBMS_PDB.SET_EXT_DATA_LINKED` procedure to change the `emp_salaries` data dictionary view in the `hr_mgr` schema to an extended data-linked application common object.

Example 4-9 Changing an Object to an Extended Data-Linked Application Common Object

```
BEGIN
  DBMS_PDB.SET_EXT_DATA_LINKED (
    SCHEMA_NAME => 'hr_mgr',
```

```
OBJECT_NAME => 'emp_salaries',  
NAMESPACE   => 1);  
END;  
/
```

Any common user can own extended data links.

To find if an object has an extended data link, query the `SHARING` column of the `DBA_OBJECTS` data dictionary view.

Related Topics

- [Oracle Database PL/SQL Packages and Types Reference](#)

4.15 Managing Dictionary Protection for Oracle-Maintained Schemas

Oracle-maintained schemas such as `AUDSYS` have dictionary protection to prevent users from using system privileges on these schemas.

- [About Managing Dictionary Protection for Oracle-Maintained Schemas](#)
By default, Oracle-maintained schemas have dictionary protection, but this protection can be temporarily removed if necessary.
- [Enabling Dictionary Protection in an Oracle-Maintained Schema](#)
To enable dictionary protection for an Oracle-maintained schema, use the `ALTER USER` statement with the `ENABLE DICTIONARY PROTECTION` clause.
- [Disabling Dictionary Protection in an Oracle-Maintained Schema](#)
To disable dictionary protection from an Oracle-maintained schema, use the `ALTER USER` statement with the `DISABLE DICTIONARY PROTECTION` clause.

4.15.1 About Managing Dictionary Protection for Oracle-Maintained Schemas

By default, Oracle-maintained schemas have dictionary protection, but this protection can be temporarily removed if necessary.

When a schema is dictionary protected, other users cannot use system privileges (including `ANY` privileges) on the schema, even if they have been granted the system privilege on the schema. Only the `SELECT ANY DICTIONARY` and `ANALYZE ANY DICTIONARY` system privileges can be used on a dictionary-protected schema. Users can still use object privileges on the schema, assuming that the user has been granted the object privilege on the schema. Users who are marked as dictionary protected cannot log in to the database.

For example, suppose an administrator grants the `CREATE USER` and `ALTER USER` system privilege to a user or a tool such as Oracle Identity Manager that is responsible for adding users to the database and managing their passwords. In previous releases, that account would have the privileges that are necessary for setting passwords for accounts that have higher levels of privilege, such as `SYSDB` or `SYSKM`. A malicious user of that account could change the password for `SYSKM`, log in as `SYSKM` with the new password, and then have access to information that they normally would not be allowed to have. This feature prevents that kind of attack.

To find schemas that are dictionary protected, run the following query:

```
SELECT USERNAME, DICTIONARY_PROTECTED FROM DBA_USERS WHERE
DICTIONARY_PROTECTED='YES';
```

The `ALL_USERS` data dictionary view also has the `DICTIONARY_PROTECTED` column.

In most cases, you should allow these schemas to continue to have dictionary protection, but if you need to, you can temporarily disable dictionary protection by using the `ALTER USER` statement with the `DISABLE DICTIONARY PROTECTION` clause. You can manage dictionary protection for Oracle-maintained schemas only if you are logged in as user `SYS` with the `SYSDBA` administrative privilege.

The underlying schemas of the following administrative privileges have dictionary protection enabled. When a user is granted one of these privileges and logs in, the user is using the underlying schema.

- `SYSBACKUP`
- `SYSKM`
- `SYSDG`

4.15.2 Enabling Dictionary Protection in an Oracle-Maintained Schema

To enable dictionary protection for an Oracle-maintained schema, use the `ALTER USER` statement with the `ENABLE DICTIONARY PROTECTION` clause.

1. Log in to the CDB root or to a PDB as user `SYS` with the `SYSDBA` administrative privilege.
Only user `SYS` with `SYSDBA` can enable a user schema to have dictionary privileges.
2. To find schemas that are not dictionary protected, run a query similar to the following:

```
SELECT USERNAME, DICTIONARY_PROTECTED FROM DBA_USERS
WHERE DICTIONARY_PROTECTED = 'NO' ORDER BY USERNAME;
```

3. Run the `ALTER USER` statement with the `ENABLE DICTIONARY PROTECTION` clause.

For example:

```
ALTER USER AUDSYS ENABLE DICTIONARY PROTECTION;
```

4. Ensure that the schema now has dictionary protection.

For example:

```
SELECT DICTIONARY_PROTECTED FROM DBA_USERS WHERE USERNAME = 'AUDSYS';
```

4.15.3 Disabling Dictionary Protection in an Oracle-Maintained Schema

To disable dictionary protection from an Oracle-maintained schema, use the `ALTER USER` statement with the `DISABLE DICTIONARY PROTECTION` clause.

1. Log in to the CDB root or to a PDB as user `SYS` with the `SYSDBA` administrative privilege.
Only user `SYS` with `SYSDBA` can remove dictionary privileges from a user schema.

2. Query the `DBA_USERS` data dictionary view to find if the schema has dictionary protection.

For example:

```
SELECT DICTIONARY_PROTECTED FROM DBA_USERS  
WHERE USERNAME = 'AUDSYS';
```

If the output for `DICTIONARY_PROTECTED` is `YES`, then you can remove dictionary protection from the schema.

3. Run the `ALTER USER` statement with the `DISABLE DICTIONARY PROTECTION` clause.

For example:

```
ALTER USER AUDSYS DISABLE DICTIONARY PROTECTION;
```

4.16 Table Privileges

Object privileges for tables enable table security at the DML or DDL level of operation.

- [How Table Privileges Affect Data Manipulation Language Operations](#)
You can grant privileges to use the `DELETE`, `INSERT`, `SELECT`, and `UPDATE` DML operations on tables and views.
- [How Table Privileges Affect Data Definition Language Operations](#)
The `ALTER`, `INDEX`, and `REFERENCES` privileges allow DDL operations to be performed on a table.

4.16.1 How Table Privileges Affect Data Manipulation Language Operations

You can grant privileges to use the `DELETE`, `INSERT`, `SELECT`, and `UPDATE` DML operations on tables and views.

Grant these privileges only to users and roles that need to query or manipulate data in a table.

You can restrict `INSERT` and `UPDATE` privileges for a table to specific columns of the table. With a selective `INSERT` privilege, a privileged user can insert a row with values for the selected columns. All other columns receive `NULL` or the default value of the column. With a selective `UPDATE` privilege, a user can update only specific column values of a row. You can use selective `INSERT` and `UPDATE` privileges to restrict user access to sensitive data.

For example, if you do not want data entry users to alter the `salary` column of the `employees` table, then selective `INSERT` or `UPDATE` privileges can be granted that exclude the `salary` column. Alternatively, a view that excludes the `salary` column could satisfy this need for additional security.

4.16.2 How Table Privileges Affect Data Definition Language Operations

The `ALTER`, `INDEX`, and `REFERENCES` privileges allow DDL operations to be performed on a table.

Because these privileges allow other users to alter or create dependencies on a table, you should grant these privileges conservatively. A user attempting to perform a DDL operation on a table may need additional system or object privileges. For example, to create a trigger on a table, the user requires both the `ALTER TABLE` object privilege for the table and the `CREATE TRIGGER` system privilege.

As with the `INSERT` and `UPDATE` privileges, you can grant the `REFERENCES` privilege on specific columns of a table. The `REFERENCES` privilege enables the grantee to use the table on which the grant is made as a parent key to any foreign keys that the grantee wishes to create in their own tables. This action is controlled with a special privilege because the presence of foreign keys restricts the data manipulation and table alterations that can be done to the parent key. A column-specific `REFERENCES` privilege restricts the grantee to using the named columns (which, of course, must include at least one primary or unique key of the parent table).

4.17 View Privileges

You can apply DML object privileges to views, similar to tables.

- [Privileges Required to Create Views](#)
To create a view, you must have specific privileges.
- [Privileges to Query Views in Other Schemas](#)
A view owner must be granted `SELECT WITH GRANT OPTION` on the base table of their view before users can query the view from a schema that is different from the schema in which the view is located.
- [The Use of Views to Increase Table Security](#)
Database views can increase table security by restricting the data that users can see.

4.17.1 Privileges Required to Create Views

To create a view, you must have specific privileges.

Object privileges for a view allow various DML operations, which affect the base tables from which the view is derived.

These privileges to create a view are as follows:

- You must be granted one of the following system privileges, either explicitly or through a role:
 - The `CREATE VIEW` system privilege (to create a view in your schema)
 - The `CREATE ANY VIEW` system privilege (to create a view in the schema of another user)
- You must be explicitly granted one of the following privileges:
 - The `SELECT`, `INSERT`, `UPDATE`, or `DELETE` object privileges on all base objects underlying the view
 - The `SELECT ANY TABLE`, `INSERT ANY TABLE`, `UPDATE ANY TABLE`, or `DELETE ANY TABLE` system privileges
- In addition, before you can grant other users access to you view, you must have object privileges to the base objects with the `GRANT OPTION` clause or appropriate system privileges with the `ADMIN OPTION` clause. If you do not have these privileges, then you cannot to grant other users access to your view. If you try, an `ORA-01720: grant option does not exist for object_name` error is raised, with `object_name` referring to the view's underlying object for which you do not have the sufficient privilege.

Related Topics

- [Oracle Database SQL Language Reference](#)

4.17.2 Privileges to Query Views in Other Schemas

A view owner must be granted `SELECT WITH GRANT OPTION` on the base table of their view before users can query the view from a schema that is different from the schema in which the view is located.

4.17.3 The Use of Views to Increase Table Security

Database views can increase table security by restricting the data that users can see.

To use a view, the user must have the appropriate privileges but only for the view itself, not its underlying objects. However, if access privileges for the underlying objects of the view are removed, then the user no longer has access.

This behavior occurs because the security domain that is used when a user queries the view is that of the definer of the view. If the privileges on the underlying objects are revoked from the view's definer, then the view becomes invalid, and no one can use the view. Therefore, even if a user has been granted access to the view, the user may not be able to use the view if the definer's rights have been revoked from the view's underlying objects.

For example, suppose User A creates a view. User A has definer's rights on the underlying objects of the view. User A then grants the `SELECT` privilege on that view to User B so that User B can query the view. But if User A no longer has access to the underlying objects of that view, then User B no longer has access either.

Views add two more levels of security for tables, column-level security and value-based security, as follows:

- **A view can provide access to selected columns of base tables.** For example, you can define a view on the `employees` table to show only the `employee_id`, `last_name`, and `manager_id` columns:

```
CREATE VIEW employees_manager AS
  SELECT last_name, employee_id, manager_id FROM employees;
```

- **A view can provide value-based security for the information in a table.** A `WHERE` clause in the definition of a view displays only selected rows of base tables. Consider the following two examples:

```
CREATE VIEW lowsal AS
  SELECT * FROM employees
  WHERE salary < 10000;
```

The `lowsal` view allows access to all rows of the `employees` table that have a salary value less than 10000. Notice that all columns of the `employees` table are accessible in the `lowsal` view.

```
CREATE VIEW own_salary AS
  SELECT last_name, salary
  FROM employees
  WHERE last_name = USER;
```

In the `own_salary` view, only the rows with an `last_name` that matches the current user of the view are accessible. The `own_salary` view uses the `user` pseudo column, whose values always refer to the current user. This view combines both column-level security and value-based security.

4.18 Procedure Privileges

The `EXECUTE` privilege enables users to run procedures and functions, either standalone or in packages.

- [The Use of the EXECUTE Privilege for Procedure Privileges](#)
The `EXECUTE` privilege is a very powerful privilege that should be handled with caution.
- [Procedure Execution and Security Domains](#)
The `EXECUTE` object privilege for a procedure can be used to run a procedure or compile a program unit that references the procedure.
- [System Privileges Required to Create or Replace a Procedure](#)
You must have specific privileges to create or replace a procedure in your own schema or in another user's schema.
- [System Privileges Required to Compile a Procedure](#)
You must have specific privileges to compile both standalone procedures and procedures that are part of a package.
- [How Procedure Privileges Affect Packages and Package Objects](#)
The powerful `EXECUTE` privilege enables users to run any public procedures or functions within a package.

4.18.1 The Use of the EXECUTE Privilege for Procedure Privileges

The `EXECUTE` privilege is a very powerful privilege that should be handled with caution.

The `EXECUTE` privilege is the only **object privilege** for procedures, including standalone procedures and functions, and for those within packages.

You should grant this privilege only to users who must run a procedure or compile another procedure that calls a desired procedure. You can find the privileges that a user has been granted by querying the `DBA_SYS_PRIVS` data dictionary view.

4.18.2 Procedure Execution and Security Domains

The `EXECUTE` object privilege for a procedure can be used to run a procedure or compile a program unit that references the procedure.

Oracle Database performs a run-time privilege check when any PL/SQL unit is called. A user with the `EXECUTE ANY PROCEDURE` system privilege can run any procedure in the database. Privileges to run procedures can be granted to a user through roles.

Related Topics

- [About Definer's Rights and Invoker's Rights](#)
Definer's rights and invoker's rights are used to control access to privileges during user-defined procedure executions necessary to run a user-created procedure, or program unit.
- *Oracle Database PL/SQL Packages and Types Reference*

4.18.3 System Privileges Required to Create or Replace a Procedure

You must have specific privileges to create or replace a procedure in your own schema or in another user's schema.

To create or replace a procedure in your own schema, you must have the `CREATE PROCEDURE` system privilege. To create or replace a procedure in another user's schema, you must have the `CREATE ANY PROCEDURE` system privilege.

The user who owns the procedure also must have privileges for schema objects referenced in the procedure body. To create a procedure, you need to have been explicitly granted the necessary privileges (system or object) on all objects referenced by the procedure. You cannot obtain the required privileges through roles. This includes the `EXECUTE` privilege for any procedures that are called inside the procedure being created.

 **Note:**

Triggers require that privileges on referenced objects be granted directly to the owner of the trigger. Anonymous PL/SQL blocks can use any privilege, whether the privilege is granted explicitly or through a role.

4.18.4 System Privileges Required to Compile a Procedure

You must have specific privileges to compile both standalone procedures and procedures that are part of a package.

To compile a standalone procedure, you should run the `ALTER PROCEDURE` statement with the `COMPILE` clause. To compile a procedure that is part of a package, you should run the `ALTER PACKAGE` statement.

The following example shows how to compile a standalone procedure.

```
ALTER PROCEDURE psmith.remove_emp COMPILE;
```

If the standalone or packaged procedure is in another user's schema, you must have the `ALTER ANY PROCEDURE` privilege to recompile it. You can recompile procedures in your own schema without any privileges.

4.18.5 How Procedure Privileges Affect Packages and Package Objects

The powerful `EXECUTE` privilege enables users to run any public procedures or functions within a package.

- [About the Effect of Procedure Privileges on Packages and Package Objects](#)
The `EXECUTE` object privilege for a package applies to any procedure or function within this package.
- [Example: Procedure Privileges Used in One Package](#)
The `CREATE PACKAGE BODY` statement can create a package body that contains procedures to manage procedure privileges used in one package.
- [Example: Procedure Privileges and Package Objects](#)
The `CREATE PACKAGE BODY` statement can create a package body containing procedure definitions to manage procedure privileges and package objects.

4.18.5.1 About the Effect of Procedure Privileges on Packages and Package Objects

The `EXECUTE` object privilege for a package applies to any procedure or function within this package.

A user with the `EXECUTE` object privilege for a package can run any public procedure or function in the package, and can access or modify the value of any public package variable.

You cannot grant specific `EXECUTE` privileges for individual constructs in a package. Therefore, you may find it useful to consider two alternatives for establishing security when developing procedures, functions, and packages for a database application. The following examples describe these alternatives.

4.18.5.2 Example: Procedure Privileges Used in One Package

The `CREATE PACKAGE BODY` statement can create a package body that contains procedures to manage procedure privileges used in one package.

[Example 4-10](#) shows four procedures created in the bodies of two packages.

Example 4-10 Procedure Privileges Used in One Package

```
CREATE PACKAGE BODY hire_fire AS
  PROCEDURE hire(...) IS
    BEGIN
      INSERT INTO employees . . .
    END hire;
  PROCEDURE fire(...) IS
    BEGIN
      DELETE FROM employees . . .
    END fire;
END hire_fire;

CREATE PACKAGE BODY raise_bonus AS
  PROCEDURE give_raise(...) IS
    BEGIN
      UPDATE employees SET salary = . . .
    END give_raise;
  PROCEDURE give_bonus(...) IS
    BEGIN
      UPDATE employees SET bonus = . . .
    END give_bonus;
END raise_bonus;
```

The following `GRANT EXECUTE` statements enable the `big_bosses` and `little_bosses` roles to run the appropriate procedures:

```
GRANT EXECUTE ON hire_fire TO big_bosses;
GRANT EXECUTE ON raise_bonus TO little_bosses;
```

4.18.5.3 Example: Procedure Privileges and Package Objects

The `CREATE PACKAGE BODY` statement can create a package body containing procedure definitions to manage procedure privileges and package objects.

[Example 4-11](#) shows four procedure definitions within the body of a single package. Two additional standalone procedures and a package are created specifically to provide access to the procedures defined in the main package.

Example 4-11 Procedure Privileges and Package Objects

```
CREATE PACKAGE BODY employee_changes AS
  PROCEDURE change_salary(...) IS BEGIN ... END;
  PROCEDURE change_bonus(...) IS BEGIN ... END;
  PROCEDURE insert_employee(...) IS BEGIN ... END;
  PROCEDURE delete_employee(...) IS BEGIN ... END;
```

```
END employee_changes;

CREATE PROCEDURE hire
BEGIN
    employee_changes.insert_employee(...)
END hire;

CREATE PROCEDURE fire
BEGIN
    employee_changes.delete_employee(...)
END fire;

PACKAGE raise_bonus IS
PROCEDURE give_raise(...) AS
BEGIN
    employee_changes.change_salary(...)
END give_raise;

PROCEDURE give_bonus(...)
BEGIN
    employee_changes.change_bonus(...)
END give_bonus;
```

Using this method, the procedures that actually do the work (the procedures in the `employee_changes` package) are defined in a single package and can share declared global variables, cursors, on so on. By declaring top-level procedures, `hire` and `fire`, and an additional package, `raise_bonus`, you can grant selective `EXECUTE` privileges on procedures in the main package:

```
GRANT EXECUTE ON hire, fire TO big_bosses;
GRANT EXECUTE ON raise_bonus TO little_bosses;
```

Be aware that granting `EXECUTE` privilege for a package provides uniform access to all package objects.

4.19 Type Privileges

You can control system and object privileges for types, methods, and objects.

- [System Privileges for Named Types](#)
System privileges for named types can enable users to perform actions such as creating named types in their own schemas.
- [Object Privileges for Named Types](#)
The only object privilege that applies to named types is `EXECUTE`.
- [Method Execution Model for Named Types](#)
The method execution for named types is the same as any other stored PL/SQL procedure.
- [Privileges Required to Create Types and Tables Using Types](#)
To create a type, you must have the appropriate privileges.
- [Example: Privileges for Creating Types and Tables Using Types](#)
The `EXECUTE` privilege with the `GRANT OPTION` is required for users to grant the `EXECUTE` privilege on a type to other users.
- [Privileges on Type Access and Object Access](#)
Existing column-level and table-level privileges for DML statements apply to both column objects and row objects.

- [Type Dependencies](#)
As with stored objects, such as procedures and tables, types that are referenced by other objects are called dependencies.

4.19.1 System Privileges for Named Types

System privileges for named types can enable users to perform actions such as creating named types in their own schemas.

[Table 4-8](#) lists system privileges for named types (object types, `VARRAYS`, and nested tables).

Table 4-8 System Privileges for Named Types

Privilege	Enables you to ...
<code>CREATE TYPE</code>	Create named types in your own schemas
<code>CREATE ANY TYPE</code>	Create a named type in any schema
<code>ALTER ANY TYPE</code>	Alter a named type in any schema
<code>DROP ANY TYPE</code>	Drop a named type in any schema
<code>EXECUTE ANY TYPE</code>	Use and reference a named type in any schema

The `RESOURCE` role includes the `CREATE TYPE` system privilege. The `DBA` role includes all of these privileges.

4.19.2 Object Privileges for Named Types

The only object privilege that applies to named types is `EXECUTE`.

If the `EXECUTE` privilege exists on a named type, then a user can use the named type to:

- Define a table
- Define a column in a relational table
- Declare a variable or parameter of the named type

The `EXECUTE` privilege permits a user to invoke the methods in the type, including the type constructor. This is similar to the `EXECUTE` privilege on a stored PL/SQL procedure.

4.19.3 Method Execution Model for Named Types

The method execution for named types is the same as any other stored PL/SQL procedure.

Users must be granted the appropriate privileges for using the named types, such as the `EXECUTE` privilege. As with all privilege grants, only grant these privileges to trusted users. You can find the privileges that a user has been granted by querying the `DBA_SYS_PRIVS` data dictionary view.

Related Topics

- [Procedure Privileges](#)
The `EXECUTE` privilege enables users to run procedures and functions, either standalone or in packages.

4.19.4 Privileges Required to Create Types and Tables Using Types

To create a type, you must have the appropriate privileges.

These privileges are as follows:

- You must have the `CREATE TYPE` system privilege to create a type in your schema or the `CREATE ANY TYPE` system privilege to create a type in the schema of another user. These privileges can be acquired explicitly or through a role.
- The owner of the type must be explicitly granted the `EXECUTE` object privileges to access all other types referenced within the definition of the type, or have been granted the `EXECUTE ANY TYPE` system privilege. The owner cannot obtain the required privileges through roles.
- If the type owner intends to grant access to the type to other users, then the owner must receive the `EXECUTE` privileges to the referenced types with the `GRANT OPTION` or the `EXECUTE ANY TYPE` system privilege with the `ADMIN OPTION`. If not, then the type owner has insufficient privileges to grant access on the type to other users.

To create a table using types, you must meet the requirements for creating a table and the following additional requirements:

- The owner of the table must have been directly granted the `EXECUTE` object privilege to access all types referenced by the table, or has been granted the `EXECUTE ANY TYPE` system privilege. The owner cannot exercise the required privileges if these privileges were granted through roles.
- If the table owner intends to grant access to the table to other users, then the owner must have the `EXECUTE` privilege to the referenced types with the `GRANT OPTION` or the `EXECUTE ANY TYPE` system privilege with the `ADMIN OPTION`. If not, then the table owner has insufficient privileges to grant access on the table.

Related Topics

- [Table Privileges](#)
Object privileges for tables enable table security at the DML or DDL level of operation.

4.19.5 Example: Privileges for Creating Types and Tables Using Types

The `EXECUTE` privilege with the `GRANT OPTION` is required for users to grant the `EXECUTE` privilege on a type to other users.

Assume that three users exist with the `CONNECT` and `RESOURCE` roles:

- user1
- user2
- user3

The following DDL is run in the schema of user1:

```
CREATE TYPE type1 AS OBJECT (  
    attr1 NUMBER);  
  
CREATE TYPE type2 AS OBJECT (  
    attr2 NUMBER);  
  
GRANT EXECUTE ON type1 TO user2;  
GRANT EXECUTE ON type2 TO user2 WITH GRANT OPTION;
```

The following DDL is performed in the schema of `user2`:

```
CREATE TABLE tab1 OF user1.type1;
CREATE TYPE type3 AS OBJECT (
  attr3 user1.type2);
CREATE TABLE tab2 (
  col1 user1.type2);
```

The following statements succeed because `user2` has `EXECUTE` privilege on `user1.type2` with the `GRANT OPTION`:

```
GRANT EXECUTE ON type3 TO user3;
GRANT SELECT ON tab2 TO user3;
```

However, the following grant fails because `user2` does not have `EXECUTE` privilege on `user1.type1` with the `GRANT OPTION`:

```
GRANT SELECT ON tab1 TO user3;
```

The following statements can be successfully run by `user3`:

```
CREATE TYPE type4 AS OBJECT (
  attr4 user2.type3);
CREATE TABLE tab3 OF type4;
```



Note:

The `CONNECT` role presently retains only the `CREATE SESSION` and `SET CONTAINER` privileges.

4.19.6 Privileges on Type Access and Object Access

Existing column-level and table-level privileges for DML statements apply to both column objects and row objects.

[Table 4-9](#) lists the privileges for object tables.

Table 4-9 Privileges for Object Tables

Privilege	Enables you to...
SELECT	Access an object and its attributes from the table
UPDATE	Modify the attributes of the objects that make up the rows in the table
INSERT	Create new objects in the table
DELETE	Delete rows

Similar table privileges and column privileges apply to column objects. Retrieving instances does not in itself reveal type information. However, clients must access named type information to interpret the type instance images. When a client requests type information, Oracle Database checks for the `EXECUTE` privilege on the type.

Consider the following schema:

```
CREATE TYPE emp_type (  
    eno NUMBER, ename CHAR(31), eaddr addr_t);  
CREATE TABLE emp OF emp_t;
```

In addition, consider the following two queries:

```
SELECT VALUE(emp) FROM emp;  
SELECT eno, ename FROM emp;
```

For either query, Oracle Database checks the `SELECT` privilege of the user for the `emp` table. For the first query, the user must obtain the `emp_type` type information to interpret the data. When the query accesses the `emp_type` type, Oracle Database checks the `EXECUTE` privilege of the user.

The second query, however, does not involve named types, so Oracle Database does not check type privileges.

In addition, by using the schema from the previous section, `user3` can perform the following queries:

```
SELECT tab1.col1.attr2 FROM user2.tab1 tab1;  
SELECT attr4.attr3.attr2 FROM tab3;
```

Note that in both `SELECT` statements, `user3` does not have explicit privileges on the underlying types, but the statement succeeds because the type and table owners have the necessary privileges with the `GRANT OPTION`.

Oracle Database checks privileges on the following events, and returns an error if the client does not have the privilege for the action:

- Pinning an object in the object cache using its `REF` value causes Oracle Database to check for the `SELECT` privilege on the containing object table.
- Modifying an existing object or flushing an object from the object cache causes Oracle Database to check for the `UPDATE` privilege on the destination object table.
- Flushing a new object causes Oracle Database to check for the `INSERT` privilege on the destination object table.
- Deleting an object causes Oracle Database to check for the `DELETE` privilege on the destination table.
- Pinning an object of a named type causes Oracle Database to check `EXECUTE` privilege on the object.

Modifying the attributes of an object in a client third-generation language application causes Oracle Database to update the entire object. Therefore, the user needs the `UPDATE` privilege on the object table. Having the `UPDATE` privilege on only certain columns of the object table is not sufficient, even if the application only modifies attributes corresponding to those columns. Therefore, Oracle Database does not support column-level privileges for object tables.

4.19.7 Type Dependencies

As with stored objects, such as procedures and tables, types that are referenced by other objects are called dependencies.

There are some special issues for types on which tables depend. Because a table contains data that relies on the type definition for access, any change to the type causes all stored data to become inaccessible. Changes that can cause this are when necessary privileges required to use the type are revoked, or the type or dependent types are dropped. If these actions occur, then the table becomes invalid and cannot be accessed.

A table that is invalid because of missing privileges can automatically become valid and accessible if the required privileges are granted again. A table that is invalid because a dependent type was dropped can never be accessed again, and the only permissible action is to drop the table.

Because of the severe effects that revoking a privilege on a type or dropping a type can cause, the SQL statements `REVOKE` and `DROP TYPE`, by default, implement restricted semantics. This means that if the named type in either statement has table or type dependents, then an error is received and the statement cancels. However, if the `FORCE` clause for either statement is used, then the statement always succeeds. If there are depended-upon tables, then they are invalidated.

4.20 Grants of User Privileges and Roles

The `GRANT` statement provides privileges for a user to perform specific actions, such as executing a procedure.

- [Granting System Privileges and Roles to Users and Roles](#)
Before you grant system privileges and roles to users and roles, be aware of how privileges for these types of grants work.
- [Granting Object Privileges to Users and Roles](#)
You can grant object privileges to users and roles, and enable the grantee to grant the privilege to other users.

4.20.1 Granting System Privileges and Roles to Users and Roles

Before you grant system privileges and roles to users and roles, be aware of how privileges for these types of grants work.

- [Privileges for Grants of System Privileges and Roles to Users and Roles](#)
You can use the `GRANT SQL` statement to grant system privileges and roles to users and roles.
- [Example: Granting a System Privilege and a Role to a User](#)
You can use the `GRANT` statement to grant system privileges and roles to users.
- [Example: Granting the EXECUTE Privilege on a Directory Object](#)
You can use the `GRANT` statement to grant the `EXECUTE` privilege on a directory object.
- [Use of the ADMIN Option to Enable Grantee Users to Grant the Privilege](#)
The `WITH ADMIN OPTION` clause can be used to expand the capabilities of a privilege grant.
- [Creating a New User with the GRANT Statement](#)
You can create a new user and grant this user a privilege in one `GRANT SQL` statement.

4.20.1.1 Privileges for Grants of System Privileges and Roles to Users and Roles

You can use the `GRANT SQL` statement to grant system privileges and roles to users and roles.

The following privileges are required:

- To grant a system privilege, a user must be granted the system privilege with the `ADMIN` option or must be granted the `GRANT ANY PRIVILEGE` system privilege.
- To grant a role, a user must be granted the role with the `ADMIN` option or was granted the `GRANT ANY ROLE` system privilege.

**Note:**

Object privileges cannot be granted along with system privileges and roles in the same `GRANT` statement.

4.20.1.2 Example: Granting a System Privilege and a Role to a User

You can use the `GRANT` statement to grant system privileges and roles to users.

[Example 4-12](#) grants the system privilege `CREATE SESSION` and the `accts_pay` role to the user `jward`.

Example 4-12 Granting a System Privilege and a Role to a User

```
GRANT CREATE SESSION, accts_pay TO jward;
```

4.20.1.3 Example: Granting the EXECUTE Privilege on a Directory Object

You can use the `GRANT` statement to grant the `EXECUTE` privilege on a directory object.

[Example 4-12](#) grants the `EXECUTE` privilege on the `exec_dir` directory object to the user `jward`.

Example 4-13 Granting the EXECUTE Privilege on a Directory Object

```
GRANT EXECUTE ON DIRECTORY exec_dir TO jward;
```

4.20.1.4 Use of the ADMIN Option to Enable Grantee Users to Grant the Privilege

The `WITH ADMIN OPTION` clause can be used to expand the capabilities of a privilege grant.

These capabilities are as follows:

- The grantee can grant or revoke the system privilege or role to or from any other user or role in the database. Users cannot revoke a role from themselves.
- The grantee can grant the system privilege or role with the `ADMIN` option.
- The grantee of a role can alter or drop the role.

[Example 4-14](#) grants the `new_dba` role with the `WITH ADMIN OPTION` clause to user `michael`.

Example 4-14 Granting the ADMIN Option

```
GRANT new_dba TO michael WITH ADMIN OPTION;
```

User `michael` is able to not only use all of the privileges implicit in the `new_dba` role, but this user can also grant, revoke, and drop the `new_dba` role as deemed necessary. Because of these powerful capabilities, use caution when granting system privileges or roles with the `ADMIN` option. These privileges are usually reserved for a security administrator, and are rarely granted to other administrators or users of the system. Be aware that when a user creates a role, the role is automatically granted to the creator with the `ADMIN` option.

4.20.1.5 Creating a New User with the GRANT Statement

You can create a new user and grant this user a privilege in one `GRANT SQL` statement.

In most cases, you will want to grant the user the `CREATE SESSION` privilege.

- To create a new user with the `GRANT` statement, include the privilege and the `IDENTIFIED BY` clause.

For example, to create user `psmith` as a new user while granting `psmith` the `CREATE SESSION` system privilege:

```
GRANT CREATE SESSION TO psmith IDENTIFIED BY password;
```

If you specify a password using the `IDENTIFIED BY` clause, and the user name does not exist in the database, then a new user with that user name and password is created.

Related Topics

- [Creating User Accounts](#)
A user account can have restrictions such as profiles, a default role, and tablespace restrictions.
- [Minimum Requirements for Passwords](#)
Oracle provides a set of minimum requirements for passwords.

4.20.2 Granting Object Privileges to Users and Roles

You can grant object privileges to users and roles, and enable the grantee to grant the privilege to other users.

- [About Granting Object Privileges to Users and Roles](#)
You can use the `GRANT` statement to grant object privileges to roles and users.
- [How the WITH GRANT OPTION Clause Works](#)
The `WITH GRANT OPTION` clause with the `GRANT` statement can enable a grantee to grant object privileges to other users.
- [Grants of Object Privileges on Behalf of the Object Owner](#)
The `GRANT ANY OBJECT PRIVILEGE` system privilege enables users to grant and revoke any object privilege on behalf of the object owner.
- [Grants of Privileges on Columns](#)
You can grant `INSERT`, `UPDATE`, or `REFERENCES` privileges on individual columns in a table.
- [Row-Level Access Control](#)
You can provide access control at the row level, that is, within objects, but not with the `GRANT` statement.

4.20.2.1 About Granting Object Privileges to Users and Roles

You can use the `GRANT` statement to grant object privileges to roles and users.

To grant an object privilege, you must fulfill one of the following conditions:

- You own the object specified.
- You have been granted the `GRANT ANY OBJECT PRIVILEGE` system privilege. This privilege enables you to grant and revoke privileges on behalf of the object owner.
- The `WITH GRANT OPTION` clause was specified when you were granted the object privilege.

 **Note:**

System privileges and roles cannot be granted along with object privileges in the same `GRANT` statement.

The following example grants the `READ`, `INSERT`, and `DELETE` object privileges for all columns of the `emp` table to the users `jfee` and `tsmith`.

```
GRANT READ, INSERT, DELETE ON emp TO jfee, tsmith;
```

To grant all object privileges on the `salary` view to user `jfee`, use the `ALL` keyword as shown in the following example:

```
GRANT ALL ON salary TO jfee;
```

 **Note:**

A grantee cannot regrant access to objects unless the original grant included the `GRANT OPTION`. Thus in the example just given, `jfee` cannot use the `GRANT` statement to grant object privileges to anyone else.

4.20.2.2 How the WITH GRANT OPTION Clause Works

The `WITH GRANT OPTION` clause with the `GRANT` statement can enable a grantee to grant object privileges to other users.

The user whose schema contains an object is automatically granted all associated object privileges with the `WITH GRANT OPTION` clause. This special privilege allows the grantee several expanded privileges:

- The grantee can grant the object privilege to any user in the database, with or without the `GRANT OPTION`, and to any role in the database.
- If both of the following conditions are true, then the grantee can create views on the table, and grant the corresponding privileges on the views to any user or role in the database:
 - The grantee receives object privileges for the table with the `GRANT OPTION`.
 - The grantee has the `CREATE VIEW` or `CREATE ANY VIEW` system privilege.

 **Note:**

The `WITH GRANT OPTION` clause is not valid if you try to grant an object privilege to a role. Oracle Database prevents the propagation of object privileges through roles so that grantees of a role cannot propagate object privileges received by means of roles.

4.20.2.3 Grants of Object Privileges on Behalf of the Object Owner

The `GRANT ANY OBJECT PRIVILEGE` system privilege enables users to grant and revoke any object privilege on behalf of the object owner.

This privilege provides a convenient means for database and application administrators to grant access to objects in any schema without requiring that they connect to the schema. Login credentials do not need to be maintained for schema owners who have this privilege, which reduces the number of connections required during configuration.

This system privilege is part of the Oracle Database supplied `DBA` role and is thus granted (with the `ADMIN` option) to any user connecting `AS SYSDBA` (user `SYS`). As with other system privileges, the `GRANT ANY OBJECT PRIVILEGE` system privilege can only be granted by a user who possesses the `ADMIN` option.

The *recorded* grantor of access rights to an object is either the object owner or the person exercising the `GRANT ANY OBJECT PRIVILEGE` system privilege. If the grantor with `GRANT ANY OBJECT PRIVILEGE` does *not* have the object privilege with the `GRANT OPTION`, then the object owner is shown as the grantor. Otherwise, when that grantor has the object privilege with the `GRANT OPTION`, then that grantor is recorded as the grantor of the grant.



Note:

The audit record generated by the `GRANT` statement always shows the actual user who performed the grant.

For example, consider the following scenario. User `adams` possesses the `GRANT ANY OBJECT PRIVILEGE` system privilege. This user does not possess any other grant privileges. User `adams` issues the following statement:

```
GRANT SELECT ON HR.EMPLOYEES TO blake WITH GRANT OPTION;
```

If you examine the `DBA_TAB_PRIVS` view, then you will see that `HR` is shown as the grantor of the privilege:

```
SELECT GRANTEE, GRANTOR, PRIVILEGE, GRANTABLE
FROM DBA_TAB_PRIVS
WHERE TABLE_NAME = 'EMPLOYEES' and OWNER = 'HR';
```

GRANTEE	GRANTOR	PRIVILEGE	GRANTABLE
BLAKE	HR	SELECT	YES

Now assume that user `blake` also has the `GRANT ANY OBJECT PRIVILEGE` system. He issues the following statement:

```
GRANT SELECT ON HR.EMPLOYEES TO clark;
```

In this case, when you query the `DBA_TAB_PRIVS` view again, you see that `blake` is shown as being the grantor of the privilege:

GRANTEE	GRANTOR	PRIVILEGE	GRANTABLE
BLAKE	HR	SELECT	YES
CLARK	BLAKE	SELECT	NO

This occurs because `blake` already possesses the `SELECT` privilege on `HR.EMPLOYEES` with the `GRANT OPTION`.

Related Topics

- [Revokes of Object Privileges on Behalf of the Object Owner](#)
The `GRANT ANY OBJECT PRIVILEGE` system privilege can be used to revoke any object privilege where the object owner is the grantor.

4.20.2.4 Grants of Privileges on Columns

You can grant `INSERT`, `UPDATE`, or `REFERENCES` privileges on individual columns in a table.

 **Note:**

Before granting a column-specific `INSERT` privilege, determine if the table contains any columns on which `NOT NULL` constraints are defined. Granting selective insert capability without including the `NOT NULL` columns prevents the user from inserting any rows into the table. To avoid this situation, ensure that each `NOT NULL` column can either be inserted into or has a non-`NULL` default value. Otherwise, the grantee will not be able to insert rows into the table and will receive an error.

The following statement grants the `INSERT` privilege on the `acct_no` column of the `accounts` table to user `psmith`:

```
GRANT INSERT (acct_no) ON accounts TO psmith;
```

In the following example, object privilege for the `ename` and `job` columns of the `emp` table are granted to the users `jfee` and `tsmith`:

```
GRANT INSERT(ename, job) ON emp TO jfee, tsmith;
```

You can grant the `INSERT` and `UPDATE` privileges on individual columns of a view.

4.20.2.5 Row-Level Access Control

You can provide access control at the row level, that is, within objects, but not with the `GRANT` statement.

To perform this kind of access control, you must use either Oracle Virtual Private Database (VPD) or Oracle Label Security (OLS).

Related Topics

- [Using Oracle Virtual Private Database to Control Data Access](#)
Oracle Virtual Private Database (VPD) enables you to filter users who access data.
- *Oracle Label Security Administrator's Guide*

4.21 Revokes of Privileges and Roles from a User

When you revoke system or object privileges, be aware of the cascading effects of revoking a privilege.

- [Revokes of System Privileges and Roles](#)
The `REVOKE` SQL statement revokes system privileges and roles.

- [Revokes of Object Privileges](#)
You can revoke multiple object privileges, object privileges on behalf of an object owner, column-selective object privileges, and the `REFERENCES` object privilege.
- [Cascading Effects of Revoking Privileges](#)
There are no cascading effects for revoked object privileges related to DDL operations, but there are cascading effects for object privilege revocations.

4.21.1 Revokes of System Privileges and Roles

The `REVOKE` SQL statement revokes system privileges and roles.

Any user with the `ADMIN` option for a system privilege or role can revoke the privilege or role from any other database user or role. The revoker does not have to be the user that originally granted the privilege or role. Users with `GRANT ANY ROLE` can revoke *any* role.

Example 4-15 revokes the `CREATE TABLE` system privilege and the `accts_rec` role from user `psmith`:

Example 4-15 Revoking a System Privilege and a Role from a User

```
REVOKE CREATE TABLE, accts_rec FROM psmith;
```

Be aware that the `ADMIN` option for a system privilege or role cannot be selectively revoked. Instead, revoke the privilege or role, and then grant the privilege or role again but without the `ADMIN` option.

4.21.2 Revokes of Object Privileges

You can revoke multiple object privileges, object privileges on behalf of an object owner, column-selective object privileges, and the `REFERENCES` object privilege.

- [About Revokes of Object Privileges](#)
To revoke an object privilege, you must meet the appropriate requirements.
- [Revokes of Multiple Object Privileges](#)
The `REVOKE` statement can revoke multiple privileges on one object.
- [Revokes of Object Privileges on Behalf of the Object Owner](#)
The `GRANT ANY OBJECT PRIVILEGE` system privilege can be used to revoke any object privilege where the object owner is the grantor.
- [Revokes of Column-Selective Object Privileges](#)
`GRANT` and `REVOKE` operations for column-specific operations have different privileges and restrictions.
- [Revokes of the REFERENCES Object Privilege](#)
When you revoke the `REFERENCES` object privilege, it affects foreign key constraints.

4.21.2.1 About Revokes of Object Privileges

To revoke an object privilege, you must meet the appropriate requirements.

The requirements are either of the following conditions:

- You previously granted the object privilege to the user or role.
- You possess the `GRANT ANY OBJECT PRIVILEGE` system privilege that enables you to grant and revoke privileges on behalf of the object owner.

You can only revoke the privileges that you, the person who granted the privilege, directly authorized. You cannot revoke grants that were made by other users to whom you granted the `GRANT OPTION`. However, there is a cascading effect. If the object privileges of the user who granted the privilege are revoked, then the object privilege grants that were propagated using the `GRANT OPTION` are revoked as well.

4.21.2.2 Revokes of Multiple Object Privileges

The `REVOKE` statement can revoke multiple privileges on one object.

Assuming you are the original grantor of the privilege, the following statement revokes the `SELECT` and `INSERT` privileges on the `emp` table from users `jfee` and `psmith`:

```
REVOKE SELECT, INSERT ON emp FROM jfee, psmith;
```

The following statement revokes all object privileges for the `dept` table that you originally granted to the `human_resource` role:

```
REVOKE ALL ON dept FROM human_resources;
```



Note:

The `GRANT OPTION` for an object privilege cannot be selectively revoked. Instead, revoke the object privilege and then grant it again but without the `GRANT OPTION`. Users cannot revoke object privileges from themselves.

4.21.2.3 Revokes of Object Privileges on Behalf of the Object Owner

The `GRANT ANY OBJECT PRIVILEGE` system privilege can be used to revoke any object privilege where the object owner is the grantor.

This occurs when the object privilege is granted by the object owner, or on behalf of the owner by any user holding the `GRANT ANY OBJECT PRIVILEGE` system privilege.

In a situation where the object privilege was granted by both the owner of the object and the user executing the `REVOKE` statement (who has both the specific object privilege and the `GRANT ANY OBJECT PRIVILEGE` system privilege), Oracle Database only revokes the object privilege granted by the user issuing the `REVOKE` statement. This can be illustrated by continuing the example that is shown earlier of a grant of object privileges made on behalf of an object owner.

At this point, user `blake` granted the `SELECT` privilege on `HR.EMPLOYEES` to `clark`. Even though `blake` possesses the `GRANT ANY OBJECT PRIVILEGE` system privilege, this user also holds the specific object privilege, thus this grant is attributed to him. Assume that user `HR` also grants the `SELECT` privilege on `HR.EMPLOYEES` to user `clark`. A query of the `DBA_TAB_PRIVS` view shows that the following grants are in effect for the `HR.EMPLOYEES` table:

GRANTEE	GRANTOR	PRIVILEGE	GRANTABLE
BLAKE	HR	SELECT	YES
CLARK	BLAKE	SELECT	NO
CLARK	HR	SELECT	NO

User `blake` now issues the following `REVOKE` statement:

```
REVOKE SELECT ON HR.EMPLOYEES FROM clark;
```

Only the object privilege for user `clark` granted by user `blake` is removed. The grant by the object owner, `HR`, remains.

GRANTEE	GRANTOR	PRIVILEGE	GRANTABLE
BLAKE	HR	SELECT	YES
CLARK	HR	SELECT	NO

If `blake` issues the `REVOKE` statement again, then this time the effect is to remove the object privilege granted by `adams` (on behalf of `HR`), using the `GRANT ANY OBEJCT PRIVILEGE` system privilege.

Related Topics

- [Grants of Object Privileges on Behalf of the Object Owner](#)
 The `GRANT ANY OBJECT PRIVILEGE` system privilege enables users to grant and revoke any object privilege on behalf of the object owner.

4.21.2.4 Revokes of Column-Selective Object Privileges

`GRANT` and `REVOKE` operations for column-specific operations have different privileges and restrictions.

Although users can grant column-specific `INSERT`, `UPDATE`, and `REFERENCES` privileges for tables and views, they cannot selectively revoke column-specific privileges with a similar `REVOKE` statement. Instead, the grantor must first revoke the object privilege for all columns of a table or view, and then selectively repeat the grant of the column-specific privileges that the grantor intends to keep in effect.

For example, assume that role `human_resources` was granted the `UPDATE` privilege on the `deptno` and `dname` columns of the table `dept`. To revoke the `UPDATE` privilege on just the `deptno` column, issue the following two statements:

```
REVOKE UPDATE ON dept FROM human_resources;
GRANT UPDATE (dname) ON dept TO human_resources;
```

The `REVOKE` statement revokes the `UPDATE` privilege on all columns of the `dept` table from the role `human_resources`. The `GRANT` statement then repeats, restores, or reissues the grant of the `UPDATE` privilege on the `dname` column to the role `human_resources`.

4.21.2.5 Revokes of the REFERENCES Object Privilege

When you revoke the `REFERENCES` object privilege, it affects foreign key constraints.

If the grantee of the `REFERENCES` object privilege has used the privilege to create a foreign key constraint (that currently exists), then the grantor can revoke the privilege only by specifying the `CASCADE CONSTRAINTS` option in the `REVOKE` statement.

For example:

```
REVOKE REFERENCES ON dept FROM jward CASCADE CONSTRAINTS;
```

Any foreign key constraints currently defined that use the revoked `REFERENCES` privilege are dropped when the `CASCADE CONSTRAINTS` clause is specified.

4.21.3 Cascading Effects of Revoking Privileges

There are no cascading effects for revoked object privileges related to DDL operations, but there are cascading effects for object privilege revocations.

- [Cascading Effects When Revoking System Privileges](#)
There are no cascading effects when you revoke a system privilege that is related to DDL operations.
- [Cascading Effects When Revoking Object Privileges](#)
Revoking an object privilege can have cascading effects.

4.21.3.1 Cascading Effects When Revoking System Privileges

There are no cascading effects when you revoke a system privilege that is related to DDL operations.

This applies regardless of whether the privilege was granted with or without the `ADMIN` option.

For example, assume the following:

1. The security administrator grants the `CREATE TABLE` system privilege to user `jfee` with the `ADMIN` option.
2. User `jfee` creates a table.
3. User `jfee` grants the `CREATE TABLE` system privilege to user `tsmith`.
4. User `tsmith` creates a table.
5. The security administrator revokes the `CREATE TABLE` system privilege from user `jfee`.
6. The table created by user `jfee` continues to exist. User `tsmith` still has the table and the `CREATE TABLE` system privilege.

You can observe cascading effects when you revoke a system privilege related to a DML operation. If the `SELECT ANY TABLE` privilege is revoked from a user, then all procedures contained in the user's schema relying on this privilege can no longer be run successfully until the privilege is reauthorized.

4.21.3.2 Cascading Effects When Revoking Object Privileges

Revoking an object privilege can have cascading effects.

Note the following:

- **Object definitions that depend on a DML object privilege can be affected if the DML object privilege is revoked.** For example, assume that the body of the `test` procedure includes a SQL statement that queries data from the `emp` table. If the `SELECT` privilege on the `emp` table is revoked from the owner of the `test` procedure, then the procedure can no longer be run successfully.
- **When a REFERENCES privilege for a table is revoked from a user, any foreign key integrity constraints that are defined by the user and require the dropped REFERENCES privilege are automatically dropped.** For example, assume that user `jward` is granted the `REFERENCES` privilege for the `deptno` column of the `dept` table. This user now creates a foreign key on the `deptno` column in the `emp` table that references the `deptno` column of the `dept` table. If the `REFERENCES` privilege on the `deptno` column of the

`dept` table is revoked, then the foreign key constraint on the `deptno` column of the `emp` table is dropped in the same operation.

- **The object privilege grants propagated using the GRANT OPTION are revoked if the object privilege of a grantor is revoked.** For example, assume that `user1` is granted the `SELECT` object privilege on the `emp` table with the `GRANT OPTION`, and grants the `SELECT` privilege on `emp` to `user2`. Subsequently, the `SELECT` privilege is revoked from `user1`. This `REVOKE` statement is also cascaded to `user2`. Any objects that depend on the revoked `SELECT` privilege of `user1` and `user2` can also be affected, as described earlier.

Object definitions that require the `ALTER` and `INDEX DDL` object privileges are not affected if the `ALTER` or `INDEX` object privilege is revoked. For example, if the `INDEX` privilege is revoked from a user that created an index on a table that belongs to another user, then the index continues to exist after the privilege is revoked.

4.22 Grants and Revokes of Privileges to and from the PUBLIC Role

You can grant and revoke privileges and roles from the role `PUBLIC`.

Because `PUBLIC` is accessible to every database user, all privileges and roles granted to `PUBLIC` are accessible to every database user. By default, `PUBLIC` does not have privileges granted to it.

Security administrators and database users should grant a privilege or role to `PUBLIC` only if every database user requires the privilege or role. This recommendation reinforces the general rule that, at any given time, each database user should have only the privileges required to accomplish the current group tasks successfully.

Revoking a privilege from the `PUBLIC` role can cause significant cascading effects. If any privilege related to a DML operation is revoked from `PUBLIC` (for example, `SELECT ANY TABLE` or `UPDATE ON emp`), then all procedures in the database, including functions and packages, must be *reauthorized* before they can be used again. Therefore, be careful when you grant and revoke DML-related privileges to or from `PUBLIC`.

Related Topics

- [Guidelines for Securing Data](#)
Oracle provides guidelines for securing data on your system.
- *Oracle Database Administrator's Guide*

4.23 Grants of Roles Using the Operating System or Network

Using the operating system or network to manage roles can help centralize the role management in a large enterprise.

- [About Granting Roles Using the Operating System or Network](#)
The operating system on which Oracle Database runs can be used to grant roles to users at connect time.
- [Operating System Role Identification](#)
The `OS_ROLES` initialization parameter can be used to control how the operating system identifies roles.

- [Operating System Role Management](#)
When you use operating system-managed roles, remember that database roles are being granted to an operating system user.
- [Role Grants and Revokes When OS_ROLES Is Set to TRUE](#)
Setting the `OS_ROLES` initialization parameter to `TRUE` enables the operating system to manage role grants and revokes to users.
- [Role Enablements and Disablements When OS_ROLES Is Set to TRUE](#)
Setting the `OS_ROLES` initialization parameter to `TRUE` enables the `SET ROLE` statement to dynamically enable roles granted by the operating system.
- [Network Connections with Operating System Role Management](#)
By default, users cannot connect to the database through a shared server if the operating system manages roles.

4.23.1 About Granting Roles Using the Operating System or Network

The operating system on which Oracle Database runs can be used to grant roles to users at connect time.

This feature is an alternative to a security administrator explicitly having to granting and revoking database roles to and from users using `GRANT` and `REVOKE` statements.

Roles can be administered using the operating system and passed to Oracle Database when a user creates a session. As part of this mechanism, the default roles of a user and the roles granted to a user with the `ADMIN` option can be identified. If the operating system is used to authorize users for roles, then all roles must be created in the database and privileges assigned to the role with `GRANT` statements.

Roles can also be granted through a network service.

The advantage of using the operating system to identify the database roles of a user is that privilege management for an Oracle database can be externalized. The security facilities offered by the operating system control user privileges. This option may offer advantages of centralizing security for several system activities, such as the following situation:

- MVS Oracle administrators want RACF groups to identify database user roles.
- UNIX Oracle administrators want UNIX groups to identify database user roles.
- VMS Oracle administrators want to use rights identifiers to identify database user roles.

The main disadvantage of using the operating system to identify the database roles of a user is that privilege management can only be performed at the role level. Individual privileges cannot be granted using the operating system, but they can still be granted inside the database using `GRANT` statements.

A second disadvantage of using this feature is that, by default, users cannot connect to the database through the shared server or any other network connection if the operating system is managing roles. However, you can change this default.

You can use operating system authentication for a database administrator only for the CDB root. You cannot use it for PDBs, the application root, or application PDBs.

 **Note:**

The features described in this section are available only on some operating systems. See your operating system-specific Oracle Database documentation to determine if you can use these features.

Related Topics

- [Network Connections with Operating System Role Management](#)

By default, users cannot connect to the database through a shared server if the operating system manages roles.

4.23.2 Operating System Role Identification

The `OS_ROLES` initialization parameter can be used to control how the operating system identifies roles.

To have the database use the operating system to identify the database roles of each user when a session is created, you can set the initialization parameter `OS_ROLES` to `TRUE`.

If the instance is current running, you must restart the instance. When a user tries to create a session with the database, Oracle Database initializes the user security domain using the database roles identified by the operating system.

To identify database roles for a user, the operating system account for each Oracle Database user must have operating system identifiers (these may be called groups, rights identifiers, or other similar names) that indicate which database roles are to be available for the user. Role specification can also indicate which roles are the default roles of a user and which roles are available with the `ADMIN` option. No matter which operating system is used, the role specification at the operating system level follows the format:

```
ora_ID_ROLE[[_d][_a][_da]]
```

In this specification:

- `ID` has a definition that varies on different operating systems. For example, on VMS, `ID` is the instance identifier of the database; on VMS, it is the computer type; and on UNIX, it is the system `ID`.
`ID` is case-sensitive to match your `ORACLE_SID`. `ROLE` is not case-sensitive.
- `ROLE` is the name of the database role.
- `d` is an optional character that indicates this role is to be a default role of the database user.
- `a` is an optional character that indicates this role is to be granted to the user with the `ADMIN` option. This allows the user to grant the role to other roles only. Roles cannot be granted to users if the operating system is used to manage roles.

If either the `d` or `a` character is specified, then precede that character by an underscore (`_`).

For example, suppose an operating system account has the following roles identified in its profile:

```
ora_PAYROLL_ROLE1
ora_PAYROLL_ROLE2_a
ora_PAYROLL_ROLE3_d
ora_PAYROLL_ROLE4_da
```

When the corresponding user connects to the `payroll` instance of Oracle Database, `role3` and `role4` are defaults, while `role2` and `role4` are available with the `ADMIN` option.

4.23.3 Operating System Role Management

When you use operating system-managed roles, remember that database roles are being granted to an operating system user.

Any database user to which the operating system user is able to connect will have the authorized database roles enabled. For this reason, you should consider defining all Oracle Database users as `IDENTIFIED EXTERNALLY` if you are using `OS_ROLES = TRUE`, so that the database accounts are tied to the operating system account that was granted privileges.

4.23.4 Role Grants and Revokes When `OS_ROLES` Is Set to `TRUE`

Setting the `OS_ROLES` initialization parameter to `TRUE` enables the operating system to manage role grants and revokes to users.

Any previous granting of roles to users using `GRANT` statements do not apply. However, they are still listed in the data dictionary. Only the role grants to users made at the operating system level apply. Users can still grant privileges to roles and users.



Note:

If the operating system grants a role to a user with the `ADMIN` option, then the user can grant the role only to other roles.

4.23.5 Role Enablements and Disablements When `OS_ROLES` Is Set to `TRUE`

Setting the `OS_ROLES` initialization parameter to `TRUE` enables the `SET ROLE` statement to dynamically enable roles granted by the operating system.

This still applies, even if the role was defined to require a password or operating system authorization. However, any role not identified in the operating system account of a user cannot be specified in a `SET ROLE` statement, even if a role was granted using a `GRANT` statement when `OS_ROLES = FALSE`. (If you specify such a role, then Oracle Database ignores it.)

When `OS_ROLES` is set to `TRUE`, then the user can enable up to 148 roles. Remember that this number includes other roles that may have been granted to the role.

4.23.6 Network Connections with Operating System Role Management

By default, users cannot connect to the database through a shared server if the operating system manages roles.

This restriction is the default because a remote user could impersonate another operating system user over an unsecure connection.

If you are not concerned with this security risk and want to use operating system role management with the shared server, or any other network connection, then set the initialization

parameter `REMOTE_OS_ROLES` to `TRUE`. The change takes effect the next time you start the instance and mount the database. The default setting of this parameter is `FALSE`.

The `REMOTE_OS_ROLES` initialization parameter is deprecated in Oracle Database 23ai

4.24 How Grants and Revokes Work with SET ROLE and Default Role Settings

Privilege grants and the `SET ROLE` statement affect when and how grants and revokes take place.

- [When Grants and Revokes Take Effect](#)
Depending on the privilege that is granted or revoked, a grant or revoke takes effect at different times.
- [How the SET ROLE Statement Affects Grants and Revokes](#)
During a user session, a user or an application can use the `SET ROLE` statement multiple times to change the roles enabled for the session.
- [Specifying the Default Role for a User](#)
When a user logs on, Oracle Database enables all privileges granted explicitly to the user and all privileges in the user's default roles.
- [The Maximum Number of Roles That a User Can Have Enabled](#)
You can grant a user as many roles as you want, but no more than 148 roles can be enabled for a logged-in user at any given time.

4.24.1 When Grants and Revokes Take Effect

Depending on the privilege that is granted or revoked, a grant or revoke takes effect at different times.

The grants and revokes take effect as follows:

- All grants and revokes of system and object privileges to anything (users, roles, and `PUBLIC`) take immediate effect.
- All grants and revokes of roles to anything (users, other roles, `PUBLIC`) take effect only when a current user session issues a `SET ROLE` statement to reenables the role after the grant and revoke, or when a new user session is created after the grant or revoke.

You can see which roles are currently enabled by examining the `SESSION_ROLES` data dictionary view.

4.24.2 How the SET ROLE Statement Affects Grants and Revokes

During a user session, a user or an application can use the `SET ROLE` statement multiple times to change the roles enabled for the session.

The user must already be granted the roles that are named in the `SET ROLE` statement.

The following example enables the role `clerk`, which you have already been granted, and specifies the password.

```
SET ROLE clerk IDENTIFIED BY password;
```

Replace `password` with a password that is secure.

The following example shows how to use `SET ROLE` to disable all roles.

```
SET ROLE NONE;
```

Related Topics

- [Guidelines for Securing Passwords](#)
Oracle provides guidelines for securing passwords in a variety of situations.

4.24.3 Specifying the Default Role for a User

When a user logs on, Oracle Database enables all privileges granted explicitly to the user and all privileges in the user's default roles.

1. Ensure that the user who you want to set the default role for has been directly granted the role with a `GRANT` statement, or that the role was created by the user with the `CREATE ROLE` privilege.
2. Use the `ALTER USER` statement with the `DEFAULT ROLE` clause to specify the default roles for the user.

For example, to set the default roles `payclerk` and `pettycash` for user `jane`:

```
ALTER USER jane DEFAULT ROLE payclerk, pettycash;
```

You cannot set default roles for a user in the `CREATE USER` statement. When you first create a user, the default user role setting is `ALL`, which causes all roles subsequently granted to the user to be default roles. Use the `ALTER USER` statement to limit the default user roles.

Note:

When you create a role (other than a global role or an application role), it is granted implicitly to you, and your set of default roles is updated to include the new role. Be aware that only 148 roles can be enabled for a user session. When aggregate roles, such as the `DBA` role, are granted to a user, the roles granted to the role are included in the number of roles the user has. For example, if a role has 20 roles granted to it and you grant that role to the user, then the user now has 21 additional roles. Therefore, when you grant new roles to a user, use the `DEFAULT ROLE` clause of the `ALTER USER` statement to ensure that not too many roles are specified as that user's default roles.

Related Topics

- *Oracle Database SQL Language Reference*

4.24.4 The Maximum Number of Roles That a User Can Have Enabled

You can grant a user as many roles as you want, but no more than 148 roles can be enabled for a logged-in user at any given time.

The 148 role maximum includes roles that are granted to other roles, not just top-level roles. Therefore, not all privileges will be available to this user during the user session. As a best practice, restrict the number of roles granted to a user to the minimum roles the user needs.

Related Topics

- [Guidelines for Securing Roles](#)
Oracle provides guidelines for role management.

4.25 Configuring Read-Only Users

You can override the privileges and roles that have been granted to a user by making the user a read-only user.

This allows `SELECT` operations but will not permit `CREATE`, `INSERT`, `UPDATE`, or `DELETE`.

This feature enables an administrator to block users from using their full set of privileges for as long as the user is set to read-only. For example, a database user who has been granted full privileges to insert, update, and delete data, but then made read-only will be unable to perform `INSERT`, `UPDATE`, or `DELETE` operations until they are altered to be read-write. The read-only restriction overrides privilege grants, including schema or system grants. Read-only restrictions even override the `DBA` role. If the user tries to perform these types of operations, an `ORA-28194: Can perform read operations only` error appears.

Use cases for configuring read-only users are as follows:

- A user or application normally has access to the system as required by the application or granted by the administrator, but for maintenance or investigative reasons the administrators may want to prohibit any changes to the database. In that case, you can set a user to `READ ONLY` without having to modify the user's other privileges.
- An otherwise empowered user must have read-only access to parts of an application. In the application code, you can embed a simple `ALTER SESSION` statement to grant the user `READ ONLY` access.

Read-only users may be appropriate in cases where users normally need only read access to data, but need the ability to elevate to read-write under certain conditions. With a single SQL command, these accounts can change “modes” and gain the ability to perform data updates.

To configure the read-only restriction for a user, you use the `CREATE USER` or `ALTER USER` statement. To find the read-only status of a user, you can query the `READ_ONLY` column of the `DBA_USERS` or `ALL_USERS` data dictionary view.

Table 4-10 Read-Only User Modification and Verification Procedures

Operation	Procedure
Creating a user as read-only	<code>CREATE USER user_name READ ONLY;</code>
Modifying a user to be read-only	<code>ALTER USER user_name READ ONLY;</code>
Enabling the user to have read-write access again	<code>ALTER USER user_name READ WRITE;</code>

Table 4-10 (Cont.) Read-Only User Modification and Verification Procedures

Operation	Procedure
Finding the read-only status of a user	<pre>SELECT USERNAME, READ_ONLY from DBA_USERS WHERE USERNAME = 'user_name';</pre> <p>Output similar to the following appears. For example, if user PFITCH has read-only access:</p> <pre> USERNAME READ_ONLY ----- PFITCH YES</pre>

Related Topics

- [Oracle Multitenant Administrator's Guide](#)

4.26 User Privilege and Role Data Dictionary Views

You can use special queries to find information about various types of privilege and role grants.

- [Data Dictionary Views to Find Information about Privilege and Role Grants](#)
Oracle Database provides data dictionary views that describe privilege and role grants.
- [Query to List All System Privilege Grants](#)
The `DBA_SYS_PRIVS` data dictionary view returns all system privilege grants made to roles and users.
- [Query to List Schema Privilege Grants](#)
The `DBA_SCHEMA_PRIVS` data dictionary view, accessed by users who have the `DBA` role, lists all the schema privileges granted to users or roles in the database.
- [Query to List All Role Grants](#)
The `DBA_ROLE_PRIVS` query returns all the roles granted to users and other roles.
- [Query to List Object Privileges Granted to a User](#)
The `DBA_TAB_PRIVS` and `DBA_COL_PRIVS` data dictionary views list object privileges that have been granted to users.
- [Query to List the Current Privilege Domain of Your Session](#)
The `SESSION_ROLES` and `SESSION_PRIVS` data dictionary views list the current privilege domain of a database session.
- [Query to List Roles of the Database](#)
The `DBA_ROLES` data dictionary view lists all roles of a database and the authentication used for each role.
- [Query to List Information About the Privilege Domains of Roles](#)
The `ROLE_ROLE_PRIVS`, `ROLE_SYS_PRIVS`, and `ROLE_TAB_PRIVS` data dictionary views list information about the privilege domains of roles.

4.26.1 Data Dictionary Views to Find Information about Privilege and Role Grants

Oracle Database provides data dictionary views that describe privilege and role grants.

[Table 4-11](#) lists views that you can query to access information about grants of privileges and roles.

Table 4-11 Data Dictionary Views That Display Privilege and Role Information

View	Description
ALL_COL_PRIVS	Describes all column object grants for which the current user or PUBLIC is the object owner, grantor, or grantee
ALL_COL_PRIVS_MADE	Lists column object grants for which the current user is object owner or grantor
ALL_COL_PRIVS_RECD	Describes column object grants for which the current user or PUBLIC is the grantee
ALL_TAB_PRIVS	Lists the grants on objects where the user or PUBLIC is the grantee
ALL_TAB_PRIVS_MADE	Lists the all object grants made by the current user or made on the objects owned by the current user
ALL_TAB_PRIVS_RECD	Lists object grants for which the user or PUBLIC is the grantee
DBA_COL_PRIVS	Describes all column object grants in the database
DBA_CONTAINER_DATA	Displays default (user-level) and object-specific CONTAINER_DATA attributes. Objects that are created with the CONTAINER_DATA clause include CONTAINER_DATA attributes.
DBA_EPG_DAD_AUTHORIZATION	Describes the database access descriptors (DAD) that are authorized to use a different user's privileges
DBA_LOCKDOWN_PROFILES	Describes information that pertains to PDB lockdown profiles
DBA_OBJECTS	Lists objects that have object links or metadata links. To find these objects, query the OBJECT_NAME and SHARING columns.
DBA_SCHEMA_PRIVS	List all the schema privileges that have been granted to users or roles in the database
DBA_TAB_PRIVS	Lists all grants on all objects in the database
DBA_ROLES	Lists all roles that exist in the database, including secure application roles. Note that it does not list the PUBLIC role
DBA_ROLE_PRIVS	Lists roles directly granted to users and roles
DBA_SYS_PRIVS	Lists system privileges granted to users and roles
ROLE_ROLE_PRIVS	Lists roles granted to other roles. Information is provided only about roles to which the user has access
ROLE_SCHEMA_PRIVS	List all the schema privileges that have been granted to the enabled roles of the current user
ROLE_SYS_PRIVS	Lists system privileges granted to roles. Information is provided only about roles to which the user has access
ROLE_TAB_PRIVS	Lists object privileges granted to roles. Information is provided only about roles to which the user has access
SESSION_PRIVS	Lists the privileges that are currently enabled for the user

Table 4-11 (Cont.) Data Dictionary Views That Display Privilege and Role Information

View	Description
SESSION_SCHEMA_PRIVS	Lists all the schema privileges that have been granted to the current user and the schema privileges that have been granted to the enabled roles of the current user
SESSION_ROLES	Lists all roles that are enabled for the current user. Note that it does not list the PUBLIC role
USER_APPLICATION_ROLES	Enables the current user to see all the application roles that have been granted to the user
USER_COL_PRIVS	Describes column object grants for which the current user is the object owner, grantor, or grantee
USER_COL_PRIVS_MADE	Describes column object grants for which the current user is the object owner
USER_COL_PRIVS_RECD	Describes column object grants for which the current user is the grantee
USER_EPG_DAD_AUTHORIZATION	Describes the database access descriptors (DAD) that are authorized to use a different user's privileges
USER_ROLE_PRIVS	Lists roles directly granted to the current user
USER_SCHEMA_PRIVS	Lists all the schema privileges that have been granted to the current user
USER_TAB_PRIVS	Lists grants on all objects where the current user is the grantee
USER_SYS_PRIVS	Lists system privileges granted to the current user
USER_TAB_PRIVS_MADE	Lists grants on all objects owned by the current user
USER_TAB_PRIVS_RECD	Lists object grants for which the current user is the grantee
V\$ENABLEDSCHMAPRIVS	Lists the schema privileges that have been granted to the current user
V\$PWFILERS	Lists all users in the current PDB who have been granted administrative privileges

The following table lists views that you can query to access information about grants of privileges and roles.

This section provides some examples of using these views. For these examples, assume the following statements were issued:

```
CREATE ROLE security_admin IDENTIFIED BY password;

GRANT CREATE PROFILE, ALTER PROFILE, DROP PROFILE,
      CREATE ROLE, DROP ANY ROLE, GRANT ANY ROLE, AUDIT ANY,
      AUDIT SYSTEM, CREATE USER, BECOME USER, ALTER USER, DROP USER
      TO security_admin WITH ADMIN OPTION;

GRANT READ, DELETE ON SYS.AUD$ TO security_admin;

GRANT security_admin, CREATE SESSION TO swilliams;

GRANT security_admin TO system_administrator;

GRANT CREATE SESSION TO jward;

GRANT READ, DELETE ON emp TO jward;
```

```
GRANT INSERT (ename, job) ON emp TO swilliams, jward;
```

Related Topics

- [Oracle Database Reference](#)

4.26.2 Query to List All System Privilege Grants

The `DBA_SYS_PRIVS` data dictionary view returns all system privilege grants made to roles and users.

For example:

```
SELECT GRANTEE, PRIVILEGE, ADM FROM DBA_SYS_PRIVS;
```

GRANTEE	PRIVILEGE	ADM
SECURITY_ADMIN	ALTER PROFILE	YES
SECURITY_ADMIN	ALTER USER	YES
SECURITY_ADMIN	AUDIT ANY	YES
SECURITY_ADMIN	AUDIT SYSTEM	YES
SECURITY_ADMIN	BECOME USER	YES
SECURITY_ADMIN	CREATE PROFILE	YES
SECURITY_ADMIN	CREATE ROLE	YES
SECURITY_ADMIN	CREATE USER	YES
SECURITY_ADMIN	DROP ANY ROLE	YES
SECURITY_ADMIN	DROP PROFILE	YES
SECURITY_ADMIN	DROP USER	YES
SECURITY_ADMIN	GRANT ANY ROLE	YES
SWILLIAMS	CREATE SESSION	NO
JWARD	CREATE SESSION	NO

Related Topics

- [Oracle Database Reference](#)

4.26.3 Query to List Schema Privilege Grants

The `DBA_SCHEMA_PRIVS` data dictionary view, accessed by users who have the `DBA` role, lists all the schema privileges granted to users or roles in the database.

For example:

```
SELECT GRANTEE, PRIVILEGE, SCHEMA FROM DBA_SCHEMA_PRIVS ORDER BY GRANTEE;
```

GRANTEE	PRIVILEGE	SCHEMA
PRESTON	SELECT ANY LIBRARY	HR
RLAYTON	SELECT ANY INDEX	HR

Related Topics

- [Oracle Database Reference](#)

4.26.4 Query to List All Role Grants

The `DBA_ROLE_PRIVS` query returns all the roles granted to users and other roles.

For example:

```
SELECT * FROM DBA_ROLE_PRIVS;
```

GRANTEE	GRANTED_ROLE	ADM
-----	-----	---
SWILLIAMS	SECURITY_ADMIN	NO

Related Topics

- [Oracle Database Reference](#)

4.26.5 Query to List Object Privileges Granted to a User

The `DBA_TAB_PRIVS` and `DBA_COL_PRIVS` data dictionary views list object privileges that have been granted to users.

The `DBA_TAB_PRIVS` data dictionary view returns all object privileges (not including column-specific privileges) granted to the specified user.

For example:

```
SELECT TABLE_NAME, PRIVILEGE, GRANTABLE FROM DBA_TAB_PRIVS
       WHERE GRANTEE = 'jward';
```

TABLE_NAME	PRIVILEGE	GRANTABLE
-----	-----	-----
EMP	SELECT	NO
EMP	DELETE	NO

To list all the column-specific privileges that have been granted, you can use the following query:

```
SELECT GRANTEE, TABLE_NAME, COLUMN_NAME, PRIVILEGE
       FROM DBA_COL_PRIVS;
```

GRANTEE	TABLE_NAME	COLUMN_NAME	PRIVILEGE
-----	-----	-----	-----
SWILLIAMS	EMP	ENAME	INSERT
SWILLIAMS	EMP	JOB	INSERT
JWARD	EMP	NAME	INSERT
JWARD	EMP	JOB	INSERT

Related Topics

- [Oracle Database Reference](#)

4.26.6 Query to List the Current Privilege Domain of Your Session

The `SESSION_ROLES` and `SESSION_PRIVS` data dictionary views list the current privilege domain of a database session.

The `SESSION_ROLES` view lists all roles currently enabled for the issuer.

For example:

```
SELECT * FROM SESSION_ROLES;
```

If user `swilliams` has the `security_admin` role enabled and issues the previous query, then Oracle Database returns the following information:

```

ROLE
-----
SECURITY_ADMIN

```

The following query lists all system privileges currently available in the security domain of the issuer, both from explicit privilege grants and from enabled roles:

```
SELECT * FROM SESSION_PRIVS;
```

If user `swilliams` has the `security_admin` role enabled and issues the previous query, then Oracle Database returns the following results:

```

PRIVILEGE
-----
AUDIT SYSTEM
CREATE SESSION
CREATE USER
BECOME USER
ALTER USER
DROP USER
CREATE ROLE
DROP ANY ROLE
GRANT ANY ROLE
AUDIT ANY
CREATE PROFILE
ALTER PROFILE
DROP PROFILE

```

If the `security_admin` role is disabled for user `swilliams`, then the first query would return no rows, while the second query would only return a row for the `CREATE SESSION` privilege grant.

Related Topics

- [Oracle Database Reference](#)

4.26.7 Query to List Roles of the Database

The `DBA_ROLES` data dictionary view lists all roles of a database and the authentication used for each role.

For example:

```
SELECT * FROM DBA_ROLES;
```

```

ROLE                PASSWORD
-----            -
CONNECT             NO
RESOURCE            NO
DBA                 NO
SECURITY_ADMIN     YES

```

Related Topics

- [Oracle Database Reference](#)

4.26.8 Query to List Information About the Privilege Domains of Roles

The `ROLE_ROLE_PRIVS`, `ROLE_SYS_PRIVS`, and `ROLE_TAB_PRIVS` data dictionary views list information about the privilege domains of roles.

For example:

```
SELECT GRANTED_ROLE, ADMIN_OPTION
       FROM ROLE_ROLE_PRIVS
       WHERE ROLE = 'SYSTEM_ADMIN';
```

```
GRANTED_ROLE          ADM
-----
SECURITY_ADMIN        NO
```

The following query lists all the system privileges granted to the `security_admin` role:

```
SELECT * FROM ROLE_SYS_PRIVS WHERE ROLE = 'SECURITY_ADMIN';
```

```
ROLE                PRIVILEGE                ADM
-----
SECURITY_ADMIN      ALTER PROFILE            YES
SECURITY_ADMIN      ALTER USER               YES
SECURITY_ADMIN      AUDIT ANY                YES
SECURITY_ADMIN      AUDIT SYSTEM             YES
SECURITY_ADMIN      BECOME USER              YES
SECURITY_ADMIN      CREATE PROFILE           YES
SECURITY_ADMIN      CREATE ROLE               YES
SECURITY_ADMIN      CREATE USER              YES
SECURITY_ADMIN      DROP ANY ROLE            YES
SECURITY_ADMIN      DROP PROFILE             YES
SECURITY_ADMIN      DROP USER                YES
SECURITY_ADMIN      GRANT ANY ROLE           YES
```

The following query lists all the object privileges granted to the `security_admin` role:

```
SELECT TABLE_NAME, PRIVILEGE FROM ROLE_TAB_PRIVS
       WHERE ROLE = 'SECURITY_ADMIN';
```

```
TABLE_NAME          PRIVILEGE
-----
AUD$                 DELETE
AUD$                 SELECT
```

Related Topics

- [Oracle Database Reference](#)

5

Performing Privilege Analysis to Identify Privilege Use

Privilege analysis dynamically analyzes the privileges and roles that users use and do not use.

- [What Is Privilege Analysis?](#)
Privilege analysis increases the security of your applications and database operations by helping you to implement least privilege best practices for database roles and privileges.
- [Creating and Managing Privilege Analysis Policies](#)
You can create and manage privilege analysis policies by using tools such as SQL*Plus, SQLcl, SQL Developer, or Enterprise Manager Cloud Control.
- [Creating Roles and Managing Privileges Using Cloud Control](#)
You can create new roles using privileges found in a privilege analysis report and then grant this role to users.
- [Tutorial: Using Capture Runs to Analyze ANY Privilege Use](#)
This tutorial demonstrates how to create capture runs to analyze the use of the `READ ANY TABLE` system privilege.
- [Tutorial: Analyzing Privilege Use by a User Who Has the DBA Role](#)
This tutorial demonstrates how to analyze the privilege use of a user who has the `DBA` role and performs database tuning operations.
- [Tutorial: Capturing Schema Privilege Use](#)
This tutorial shows how to capture a user's schema privilege use for the `SELECT ANY TABLE` and `DELETE ANY TABLE` system privileges on the `HR` schema.
- [Privilege Analysis Policy and Report Data Dictionary Views](#)
Oracle Database provides a set of data dictionary views that provide information about analyzed privileges.

5.1 What Is Privilege Analysis?

Privilege analysis increases the security of your applications and database operations by helping you to implement least privilege best practices for database roles and privileges.

- [About Privilege Analysis](#)
Running inside the Oracle Database kernel, privilege analysis helps reduce the attack surface of user, tooling, and application accounts by identifying used and unused privileges to implement the least-privilege model.
- [Benefits and Use Cases of Privilege Analysis](#)
Analyzing privilege use is beneficial in finding unnecessarily granted privileges and implementing least privilege best practices.
- [Who Can Perform Privilege Analysis?](#)
To use privilege analysis, you must be granted the `CAPTURE_ADMIN` role.
- [Types of Privilege Analysis](#)
You can create different types of privilege analysis policies to achieve specific goals.

- [How Does a Multitenant Environment Affect Privilege Analysis?](#)
You can create and use privilege analysis policies in a multitenant environment.
- [How Privilege Analysis Works with Pre-Compiled Database Objects](#)
Privilege analysis can be used to capture the privileges that have been exercised on pre-compiled database objects.

5.1.1 About Privilege Analysis

Running inside the Oracle Database kernel, privilege analysis helps reduce the attack surface of user, tooling, and application accounts by identifying used and unused privileges to implement the least-privilege model.

Privilege analysis dynamically captures privileges used by database users and applications during a specified window of time. It lists the used and unused privileges in reports that can be queried from data dictionary views.

The use of privilege analysis can help to quickly and efficiently enforce least privilege guidelines. In the least-privilege model, users are only given the privileges and access they need to do their jobs. Frequently, even though users perform different tasks, users are all granted the same set of powerful privileges. Without privilege analysis, figuring out the privileges that each user must have can be hard work and in many cases, users could end up with some common set of privileges even though they have different tasks. Even in organizations that manage privileges, users tend to accumulate privileges over time and rarely lose any privileges. Separation of duty breaks a single process into separate tasks for different users. Least privileges enforces the separation so users can only do their required tasks. The enforcement of separation of duty is beneficial for internal control, and it also reduces the risk from malicious users who steal privileged credentials.

Privilege analysis captures privileges used by database users and applications at runtime and writes its findings to data dictionary views that you can query. If your applications include definer's rights and invoker's rights procedures, then privilege analysis captures the privileges that are required to compile a procedure and run it, even if the procedure was compiled before the privilege capture was created and enabled. Instead of revoking a privilege from the user, you can audit the user's use of the privilege and use an application such as Oracle Audit Vault and Database Firewall to send an alert to the appropriate administrator.

5.1.2 Benefits and Use Cases of Privilege Analysis

Analyzing privilege use is beneficial in finding unnecessarily granted privileges and implementing least privilege best practices.

- [Least Privileges Best Practice](#)
The privileges of the account that accesses a database should be limited to the privileges that are strictly required by the application or the user.
- [Development of Secure Applications](#)
During the application development phase, some administrators may grant many powerful system privileges and roles, and the `SYSDBA` administrative privilege, to application developers.

5.1.2.1 Least Privileges Best Practice

The privileges of the account that accesses a database should be limited to the privileges that are strictly required by the application or the user.

But when an application is developed, especially by a third party, more privileges than necessary may be granted to the application connection pool accounts for convenience. In addition, some developers grant system and application object privileges to the `PUBLIC` role.

For example, to select from application data and run application procedures, the system privileges `SELECT ANY TABLE` and `EXECUTE ANY PROCEDURE` are granted to an application account `appsys`. The account `appsys` now can access non-application data even if they do not intend to. In this situation, you can analyze the privilege usage by user `appsys`, and then based on the results, revoke and grant privileges as necessary.

Application accounts also frequently have additional privileges needed to install and maintain the application on the database. These are only needed during application maintenance periods, but yet are available all the time. A better process would be to add the privileges needed for application maintenance into a separate role and grant that to the application only during maintenance periods.

5.1.2.2 Development of Secure Applications

During the application development phase, some administrators may grant many powerful system privileges and roles, and the `SYSDBA` administrative privilege, to application developers.

The administrators may do this because at that stage they may not know what privileges the application developer needs or is not concerned with privileges and roles during development.

Once the application is developed and working, the privileges that the application developer needs — and does not need — become more apparent. Capturing privilege analysis while the application is run through a full regression test can capture most, if not all the privileges needed by the application for runtime use. Capturing privilege analysis when testing a maintenance update can provide the privileges needed during an update of the production system. At that time, the security administrator can begin to revoke unnecessary privileges. However, the application developer may resist this idea on the basis that the application is currently working without problems. The administrator can use privilege analysis to examine each privilege that the application uses, to ensure that when they do revoke any privileges, the application will continue to work.

For example, `app_owner` is an application database user through whom the application connects to a database. User `app_owner` must query tables in the `OE`, `SH`, and `PM` schemas. Instead of granting the `SELECT` object privilege on each of the tables in these schemas, a security administrator grants the `SELECT ANY TABLE` privilege to `app_owner`. After a while, a new schema, `HR`, is created and sensitive data are inserted into `HR.EMPLOYEES` table. Because user `app_owner` has the `SELECT ANY TABLE` privilege, `app_owner` can query this table to access its sensitive data, which is a security issue. Instead of granting system privileges (particularly the `ANY` privileges), it is far better to grant schema or object privileges for specific tables.

5.1.3 Who Can Perform Privilege Analysis?

To use privilege analysis, you must be granted the `CAPTURE_ADMIN` role.

You use the `DBMS_PRIVILEGE_CAPTURE` PL/SQL package to manage privilege capture. You query the data dictionary views provided by privilege analysis to analyze your privilege use.

5.1.4 Types of Privilege Analysis

You can create different types of privilege analysis policies to achieve specific goals.

- **Context-based privilege use capture.** You must specify a Boolean expression only with the `SYS_CONTEXT` function. The used privileges will be captured if the condition evaluates to `TRUE`. This method can be used to capture privileges and roles used by a database user by specifying the user in `SYS_CONTEXT`.
- **Role-based privilege use capture.** You must provide a list of roles. If the roles in the list are enabled in the database session, then the used privileges for the session will be captured. You can capture privilege use for the following types of roles: Oracle default roles, user-created roles, Code Based Access Control (CBAC) roles, and secure application roles.
- **Role- and context-based privilege use capture.** You must provide both a list of roles that are enabled and a `SYS_CONTEXT` Boolean expression for the condition. When any of these roles is enabled in a session and the given context condition is satisfied, then privilege analysis starts capturing the privilege use.
- **Database-wide privilege capture.** If you do not specify any type in your privilege analysis policy, then the used privileges (including schema privileges) in the database will be captured, except those for the user `SYS`. (This is also referred to as unconditional analysis, because it is turned on without any conditions.)

Note the following restrictions:

- You can enable only one privilege analysis policy at a time. The only exception is that you can enable a database-wide privilege analysis policy at the same time as a non-database-wide privilege analysis policy, such as a role or context attribute-driven analysis policy.
- You cannot analyze the privileges of the `SYS` user.
- Privilege analysis shows the grant paths to the privilege but it does not suggest which grant path to keep.
- If the role, user, or object has been dropped, then the values that reflect the privilege captures for these in the privilege analysis data dictionary views are dropped as well.

5.1.5 How Does a Multitenant Environment Affect Privilege Analysis?

You can create and use privilege analysis policies in a multitenant environment.

You can create privilege analysis policies in either the CDB root or in individual PDBs. An example use case is when a site has human infrastructure database administrators who use common user accounts. The privilege analysis policy applies only to the container in which it is created, either to the privileges used within the CDB root or the application root, or to the privileges used within a PDB. It cannot be applied globally throughout the multitenant environment. You can grant the `CAPTURE_ADMIN` role locally to a local user or a common user. You can grant the `CAPTURE_ADMIN` role commonly to common users.

5.1.6 How Privilege Analysis Works with Pre-Compiled Database Objects

Privilege analysis can be used to capture the privileges that have been exercised on pre-compiled database objects.

Examples of these objects are PL/SQL packages, procedures, functions, views, triggers, and Java classes and data.

Because these privileges may not be exercised during run time when a stored procedure is called, these privileges are collected when you generate the results for any database-wide capture, along with run-time captured privileges. A privilege is treated as an unused privilege when it is not used in either pre-compiled database objects or run-time capture, and it is saved

under the run-time capture name. If a privilege is used for pre-compiled database objects, then it is saved under the capture name `ORA$DEPENDENCY`. If a privilege is captured during run time, then it is saved under the run-time capture name. If you want to know what the used privileges are for both pre-compiled database objects and run-time usage, then you must query both the `ORA$DEPENDENCY` and run-time captures. For unused privileges, you only need to query with the run-time capture name.

To find a full list of the pre-compiled objects on which privilege analysis can be used, query the `TYPE` column of the `ALL_DEPENDENCIES` data dictionary view.

5.2 Creating and Managing Privilege Analysis Policies

You can create and manage privilege analysis policies by using tools such as SQL*Plus, SQLcl, SQL Developer, or Enterprise Manager Cloud Control.

- [About Creating and Managing Privilege Analysis Policies](#)
You can use the `DBMS_PRIVILEGE_CAPTURE` PL/SQL package or Oracle Enterprise Manager Cloud Control to analyze privileges.
- [General Steps for Managing Privilege Analysis](#)
You must follow a general set of steps to analyze privileges.
- [Creating a Privilege Analysis Policy](#)
You can use the `DBMS_PRIVILEGE_CAPTURE.CREATE_CAPTURE` procedure to create a privilege analysis policy.
- [Examples of Creating Privilege Analysis Policies](#)
You can create a variety of privilege analysis policies.
- [Enabling a Privilege Analysis Policy](#)
After you create a privilege analysis policy, you must enable it to capture privilege use.
- [Disabling a Privilege Analysis Policy](#)
You must disable the privilege analysis policy before you can generate a privilege analysis report.
- [Generating a Privilege Analysis Report](#)
You can generate a privilege analysis policy report using either Enterprise Manager Cloud Control or from SQL*Plus, using the `DBMS_PRIVILEGE_CAPTURE` PL/SQL package.
- [Dropping a Privilege Analysis Policy](#)
Before you can drop a privilege analysis policy, you must first disable it.

5.2.1 About Creating and Managing Privilege Analysis Policies

You can use the `DBMS_PRIVILEGE_CAPTURE` PL/SQL package or Oracle Enterprise Manager Cloud Control to analyze privileges.

Before you can do so, you must be granted the `CAPTURE_ADMIN` role. The `DBMS_PRIVILEGE_CAPTURE` package enables you to create, enable, disable, and drop privilege analysis policies. It also generates reports that show the privilege usage, which you can view in `DBA_*` views.

Related Topics

- [Oracle Database PL/SQL Packages and Types Reference](#)

5.2.2 General Steps for Managing Privilege Analysis

You must follow a general set of steps to analyze privileges.

1. Define the privilege analysis policy.
2. Enable the privilege analysis policy.

This step begins recording the privilege use that the policy defined. Optionally, specify a name for this capture run. Each time you enable a privilege analysis policy, you can create a different capture run for it. In this way, you can create multiple named capture runs for comparison analysis later on.

3. Optionally, enable the policy to capture dependency privileges if you want to capture the privileges that are used by definer's rights and invoker's rights program units.
4. After a sufficient period of time to gather data, disable the privilege analysis policy's recording of privilege use.

This step stops capturing the privilege use for the policy.

5. Generate privilege analysis results.

This step writes the results to the privilege analysis policy and report data dictionary views.

6. Optionally, disable and then drop the privilege analysis policy and capture run.

Dropping a privilege analysis policy deletes the data captured by the policy.

Related Topics

- [Privilege Analysis Policy and Report Data Dictionary Views](#)
Oracle Database provides a set of data dictionary views that provide information about analyzed privileges.

5.2.3 Creating a Privilege Analysis Policy

You can use the `DBMS_PRIVILEGE_CAPTURE.CREATE_CAPTURE` procedure to create a privilege analysis policy.

After you create the privilege analysis policy, you can find it listed in the `DBA_PRIV_CAPTURES` data dictionary view. When a policy is created, it resides in the `SYS` schema. However, both `SYS` and the user who created the policy can drop it. After you create the policy, you must manually enable it so that it can begin to analyze privilege use.

1. Log in to the CDB or PDB as a user who has the `CAPTURE_ADMIN` role.
To find the available PDBs in a CDB, log in to the CDB root container and then query the `PDB_NAME` column of the `DBA_PDBS` data dictionary view. To check the current container, run the `show con_name` command.
2. Use the following syntax for the `DBMS_PRIVILEGE_CAPTURE.CREATE_CAPTURE` procedure:

```
DBMS_PRIVILEGE_CAPTURE.CREATE_CAPTURE (
  name          VARCHAR2,
  description   VARCHAR2 DEFAULT NULL,
  type          NUMBER DEFAULT DBMS_PRIVILEGE_CAPTURE.G_DATABASE,
  roles         ROLE_NAME_LIST DEFAULT ROLE_NAME_LIST(),
  condition     VARCHAR2 DEFAULT NULL);
```

In this specification:

- **name:** Specifies the name of the privilege analysis policy to be created. Ensure that this name is unique and no more than 128 characters. You can include spaces in the name, but you must enclose the name in single quotation marks whenever you refer to it. To find the names of existing policies, query the `NAME` column of the `DBA_PRIV_CAPTURES` view.
- **description:** Describes the purpose of the privilege analysis policy, up to 1024 characters in mixed-case letters. Optional.
- **type:** Specifies the type of capture condition. If you omit the `type` parameter, then the default is `DBMS_PRIVILEGE_CAPTURE.G_DATABASE`. Optional.

Enter one of the following types:

- `DBMS_PRIVILEGE_CAPTURE.G_DATABASE`: Captures all privileges used in the entire database, except privileges from user `SYS`.
 - `DBMS_PRIVILEGE_CAPTURE.G_ROLE`: Captures privileges for the sessions that have the roles enabled. If you enter `DBMS_PRIVILEGE_CAPTURE.G_ROLE` for the `type` parameter, then you must also specify the `roles` parameter. For multiple roles, separate each role name with a comma.
 - `DBMS_PRIVILEGE_CAPTURE.G_CONTEXT`: Captures privileges for the sessions that have the condition specified by the `condition` parameter evaluating to `TRUE`. If you enter `DBMS_PRIVILEGE_CAPTURE.G_CONTEXT` for the `type` parameter, then you must also specify the `condition` parameter.
 - `DBMS_PRIVILEGE_CAPTURE.G_ROLE_AND_CONTEXT`: Captures privileges for the sessions that have the role enabled and the context condition evaluating to `TRUE`. If you enter `DBMS_PRIVILEGE_CAPTURE.G_ROLE_AND_CONTEXT` for the `type` parameter, then you must also specify both the `roles` and `condition` parameters.
- **roles:** Specifies the roles whose used privileges will be analyzed. That is, if a privilege from one of the given roles is used, then the privilege will be analyzed. You must specify this argument if you specify `DBMS_PRIVILEGE_CAPTURE.G_ROLE` or `DBMS_PRIVILEGE_CAPTURE.G_ROLE_AND_CONTEXT` for the `type` argument. Each role you enter must exist in the database. (You can find existing roles by querying the `DBA_ROLES` data dictionary view.) For multiple roles, use `varray` type `role_name_list` to enter the role names. You can specify up to 10 roles.

For example, to specify two roles:

```
roles => role_name_list('role1', 'role2'),
```

- **condition:** Specifies a Boolean expression up to 4000 characters. You must specify this argument if you specify `DBMS_PRIVILEGE_CAPTURE.G_CONTEXT` or `DBMS_PRIVILEGE_CAPTURE.G_ROLE_AND_CONTEXT` for the `type` argument. Only `SYS_CONTEXT` expressions with relational operators(`=`, `>`, `>=`, `<`, `<=`, `<>`, `BETWEEN`, and `IN`) are permitted in this Boolean expression.

The `condition` expression syntax is as follows:

```
predicate ::= SYS_CONTEXT(namespace, attribute) relop constant_value |
             SYS_CONTEXT(namespace, attribute)
             BETWEEN
             constant_value
             AND constant_value | SYS_CONTEXT(namespace, attribute)
             IN {constant_value (,constant_value)* }
```

```
relop ::= = | < | <= | > | >= | <>
```

```
context_expression ::= predicate | (context_expression)
```

```
AND (context_expression) | (context_expression)
OR (context_expression )
```

For example, to use a condition to specify the IP address 192.0.2.1:

```
condition => 'SYS_CONTEXT(''USERENV'', ''IP_ADDRESS'')='''192.0.2.1''';
```

After you create the privilege analysis policy, you must enable the policy to begin capturing privilege and role use.

* You can add as many constant values as you need (for example, IN {*constant_value1*}, or IN {*constant_value1*, *constant_value2*, *constant_value3*}).

Related Topics

- [Enabling a Privilege Analysis Policy](#)
After you create a privilege analysis policy, you must enable it to capture privilege use.

5.2.4 Examples of Creating Privilege Analysis Policies

You can create a variety of privilege analysis policies.

- [Example: Privilege Analysis of Database-Wide Privileges](#)
The DBMS_PRIVILEGE_CAPTURE.CREATE_CAPTURE can be used to analyze database-wide privileges.
- [Example: Privilege Analysis of Privilege Usage of Two Roles](#)
The DBMS_PRIVILEGE_CAPTURE.CREATE_CAPTURE procedure can be used to analyze the privilege usage of multiple roles.
- [Example: Privilege Analysis of Privileges During SQL*Plus Use](#)
The DBMS_PRIVILEGE_CAPTURE.CREATE_CAPTURE procedure can be used to capture privileges for analysis.
- [Example: Privilege Analysis of PSMITH Privileges During SQL*Plus Access](#)
The DBMS_PRIVILEGE_CAPTURE.CREATE_CAPTURE can be used to analyze user access when the user is running SQL*Plus.

5.2.4.1 Example: Privilege Analysis of Database-Wide Privileges

The DBMS_PRIVILEGE_CAPTURE.CREATE_CAPTURE can be used to analyze database-wide privileges.

[Example 5-1](#) shows how to use the DBMS_PRIVILEGE_CAPTURE package to create a privilege analysis policy to record all privilege use in the database.

Example 5-1 Privilege Analysis of Database-Wide Privileges

```
BEGIN
  DBMS_PRIVILEGE_CAPTURE.CREATE_CAPTURE(
    name          => 'db_wide_capture_pol',
    description   => 'Captures database-wide privileges',
    type          => DBMS_PRIVILEGE_CAPTURE.G_DATABASE);
END;
/
```

5.2.4.2 Example: Privilege Analysis of Privilege Usage of Two Roles

The DBMS_PRIVILEGE_CAPTURE.CREATE_CAPTURE procedure can be used to analyze the privilege usage of multiple roles.

[Example 5-2](#) shows how to analyze the privilege usage of two roles.

Example 5-2 Privilege Analysis of Privilege Usage of Two Roles

```
BEGIN
DBMS_PRIVILEGE_CAPTURE.CREATE_CAPTURE(
  name          => 'dba_roles_capture_pol',
  description    => 'Captures DBA and LBAC_DBA role use',
  type          => DBMS_PRIVILEGE_CAPTURE.G_ROLE,
  roles         => role_name_list('dba', 'lbac_dba'));
END;
/
```

5.2.4.3 Example: Privilege Analysis of Privileges During SQL*Plus Use

The `DBMS_PRIVILEGE_CAPTURE.CREATE_CAPTURE` procedure can be used to capture privileges for analysis.

[Example 5-3](#) shows how to analyze privileges used to run SQL*Plus.

Example 5-3 Privilege Analysis of Privileges During SQL*Plus Use

```
BEGIN
DBMS_PRIVILEGE_CAPTURE.CREATE_CAPTURE(
  name          => 'sqlplus_capture_pol',
  description    => 'Captures privilege use during SQL*Plus use',
  type          => DBMS_PRIVILEGE_CAPTURE.G_CONTEXT,
  condition     => 'SYS_CONTEXT(''USERENV'', ''MODULE'')=''sqlplus''');
END;
/
```

5.2.4.4 Example: Privilege Analysis of PSMITH Privileges During SQL*Plus Access

The `DBMS_PRIVILEGE_CAPTURE.CREATE_CAPTURE` can be used to analyze user access when the user is running SQL*Plus.

[Example 5-4](#) shows how to analyze the privileges used by session user `PSMITH` when running SQL*Plus.

Example 5-4 Privilege Analysis of PSMITH Privileges During SQL*Plus Access

```
BEGIN
DBMS_PRIVILEGE_CAPTURE.CREATE_CAPTURE(
  name          => 'psmith_sqlplus_analysis_pol',
  description    => 'Analyzes PSMITH role priv use for SQL*Plus module',
  type          => DBMS_PRIVILEGE_CAPTURE.G_CONTEXT,
  condition     => 'SYS_CONTEXT(''USERENV'', ''MODULE'')=''sqlplus''
                  AND SYS_CONTEXT(''USERENV'', ''SESSION_USER'')=''PSMITH''');
END;
/
```

5.2.5 Enabling a Privilege Analysis Policy

After you create a privilege analysis policy, you must enable it to capture privilege use.

The `DBMS_PRIVILEGE_CAPTURE.ENABLE_CAPTURE` procedure enables a privilege policy and creates a capture run name for it. The run name defines the period of time that the capture took place.

1. Log in to the CDB or PDB as a user who has the `CAPTURE_ADMIN` role.

To find the available PDBs in a CDB, log in to the CDB root container and then query the `PDB_NAME` column of the `DBA_PDBS` data dictionary view. To check the current container, run the `show con_name` command.

2. Query the `NAME` and `ENABLED` columns of the `DBA_PRIV_CAPTURES` data dictionary view to find the existing privilege analysis policies and whether they are currently enabled.
3. Run the `DBMS_PRIVILEGE_CAPTURE.ENABLE_CAPTURE` procedure to enable the policy and optionally create a name for a capture run.

For example, to enable the privilege analysis policy `logon_users_analysis`:

```
BEGIN
  DBMS_PRIVILEGE_CAPTURE.ENABLE_CAPTURE (
    name      => 'logon_users_analysis_pol',
    run_name => 'logon_users_04092016');
END;
/
```

If you do not need to specify the `run_name` parameter, then you can enable the policy by only specifying its name, as follows:

```
EXEC DBMS_PRIVILEGE_CAPTURE.ENABLE_CAPTURE ('logon_users_analysis_pol');
```

5.2.6 Disabling a Privilege Analysis Policy

You must disable the privilege analysis policy before you can generate a privilege analysis report.

After you disable the policy, then the privileges are no longer recorded. Disabling a privilege analysis policy takes effect immediately for user sessions logged on both before and after the privilege analysis policy is disabled. You can use the

`DBMS_PRIVILEGE_CAPTURE.DISABLE_CAPTURE` procedure to disable a privilege analysis policy.

1. Log in to the CDB or PDB as a user who has the `CAPTURE_ADMIN` role.

To find the available PDBs in a CDB, log in to the CDB root container and then query the `PDB_NAME` column of the `DBA_PDBS` data dictionary view. To check the current container, run the `show con_name` command.

2. Query the `NAME` and `ENABLED` columns of the `DBA_PRIV_CAPTURES` data dictionary view to find the existing privilege analysis policies and whether they are currently disabled.
3. Run the `DBMS_PRIVILEGE_CAPTURE.DISABLE_CAPTURE` procedure to enable the policy.

For example, to disable the privilege analysis policy `logon_users_analysis`:

```
EXEC DBMS_PRIVILEGE_CAPTURE.DISABLE_CAPTURE ('logon_users_analysis_pol');
```

5.2.7 Generating a Privilege Analysis Report

You can generate a privilege analysis policy report using either Enterprise Manager Cloud Control or from SQL*Plus, using the `DBMS_PRIVILEGE_CAPTURE` PL/SQL package.

- [About Generating a Privilege Analysis Report](#)
After the privilege analysis policy has been disabled, you can generate a report based on the capture run that you created for the privilege analysis policy.
- [General Process for Managing Multiple Named Capture Runs](#)
When you enable a privilege analysis policy, you can create a named capture run for the policy's findings.

- [Generating a Privilege Analysis Report Using DBMS_PRIVILEGE_CAPTURE](#)
The `DBMS_PRIVILEGE_CAPTURE.GENERATE_RESULT` procedure generates a report showing the results of a privilege capture.
- [Generating a Privilege Analysis Report Using Cloud Control](#)
You can generate a privilege analysis report using Cloud Control.
- [Accessing Privilege Analysis Reports Using Cloud Control](#)
A privilege analysis report provides information about both used and unused privileges.

5.2.7.1 About Generating a Privilege Analysis Report

After the privilege analysis policy has been disabled, you can generate a report based on the capture run that you created for the privilege analysis policy.

To view the report results in SQL*Plus, query the privilege analysis-specific data dictionary views. In Enterprise Manager Cloud Control, you can view the reports from the Privilege Analysis page **Actions** menu. If a privilege is used during the privilege analysis process and then revoked before you generate the report, then the privilege is still reported as a used privilege, but without the privilege grant path.

Related Topics

- [Privilege Analysis Policy and Report Data Dictionary Views](#)
Oracle Database provides a set of data dictionary views that provide information about analyzed privileges.

5.2.7.2 General Process for Managing Multiple Named Capture Runs

When you enable a privilege analysis policy, you can create a named capture run for the policy's findings.

The capture run defines a period of time from when the capture is enabled (begun) and when it is disabled (stopped). This way, you can create multiple runs and then compare them when you generate the privilege capture results.

The general process for managing multiple named capture runs is as follows:

1. Create the policy.
2. Enable the policy for the first run.
3. After a period time to collect user behavior data, disable this policy and its run.
4. Generate the results and then query the privilege analysis data dictionary views for information about this capture run.

If you omit the `run_name` parameter from the `DBMS_PRIVILEGE_CAPTURE.GENERATE_RESULT` procedure, then this procedure looks at all records as a whole and then analyzes them.

5. Re-enable the policy for the second run. You cannot create a new capture run if the policy has not been disabled first.
6. After you have collected the user data, disable the policy and the second run.
7. Generate the results.
8. Query the privilege analysis data dictionary views. The results from both capture runs are available in the views. If you only want to show the results of one of the capture runs, then you can regenerate the results and requery the privilege analysis views. You can also filter the results on the run name.

Once enabled, the privilege analysis policy will begin to record the privilege usage when the condition is satisfied. At any given time, only one privilege analysis policy in the database can be enabled. The only exception is that a privilege analysis policy of type `DBMS_PRIVILEGE_CAPTURE.G_DATABASE` can be enabled at the same time with a privilege analysis of a different type.

When you drop a privilege analysis policy, its associated capture runs are dropped as well and are not reflected in the privilege analysis data dictionary views.

Restarting a database does not change the status of a privilege analysis. For example, if a privilege analysis policy is enabled before a database shutdown, then the policy is still enabled after the database shutdown and restart.

Related Topics

- [Tutorial: Using Capture Runs to Analyze ANY Privilege Use](#)
This tutorial demonstrates how to create capture runs to analyze the use of the `READ ANY TABLE` system privilege.

5.2.7.3 Generating a Privilege Analysis Report Using `DBMS_PRIVILEGE_CAPTURE`

The `DBMS_PRIVILEGE_CAPTURE.GENERATE_RESULT` procedure generates a report showing the results of a privilege capture.

1. Log in to the CDB or PDB as a user who has the `CAPTURE_ADMIN` role.

To find the available PDBs in a CDB, log in to the CDB root container and then query the `PDB_NAME` column of the `DBA_PDBS` data dictionary view. To check the current container, run the `show con_name` command.

2. Query the `NAME` and `ENABLED` columns of the `DBA_PRIV_CAPTURES` data dictionary view to find the existing privilege analysis policies and whether they are currently disabled.

The privilege analysis policy must be disabled before you can generate a privilege analysis report on it.

3. Run the `DBMS_PRIVILEGE_CAPTURE.GENERATE_RESULT` procedure using the following syntax:

```
DBMS_PRIVILEGE_CAPTURE.GENERATE_RESULT(
  name          VARCHAR2,
  run_name      VARCHAR2 DEFAULT NULL,
  dependency    BOOLEAN DEFAULT NULL);
```

In this specification:

- `name`: Specifies the name of the privilege analysis policy. The `DBA_PRIV_CAPTURES` data dictionary view lists the names of existing policies.
- `run_name`: Specifies the name for the run name for the privilege capture that must be computed. If you omit this setting, then all runs for the given privilege capture are computed.
- `dependency`: Enter Y (yes) or N (no) to specify whether the PL/SQL computation privilege usage should be included in the report.

For example, to generate a report for the privilege analysis policy `logon_users_analysis`:

```
EXEC DBMS_PRIVILEGE_CAPTURE.GENERATE_RESULT ('logon_users_analysis');
```

4. Query the used privileges from `DBA_USED_*` data dictionary views with privilege grant paths.

5.2.7.4 Generating a Privilege Analysis Report Using Cloud Control

You can generate a privilege analysis report using Cloud Control.

1. Log in to Cloud Control as a user who has been granted the `CAPTURE_ADMIN` role and the `SELECT ANY DICTIONARY` privilege.
2. From the **Security** menu, select **Privilege Analysis**.
3. Under Policies, select the policy whose report you want to generate.
4. Select **Generate Report**.
5. In the Privilege Analysis: Generate Report dialog box, specify a time to generate the report.

To generate the report now, select **Immediate**. To generate the report later, select **Later**, and then specify the hour, minute, second, and the time zone for the report to generate.

6. Click **OK**.

In the Privilege Analysis page, a Confirmation message notifies you that a report has been submitted. You can refresh the page until the job is complete. To view the report, select the policy name and then click **View Reports**.

5.2.7.5 Accessing Privilege Analysis Reports Using Cloud Control

A privilege analysis report provides information about both used and unused privileges.

1. Generate the privilege analysis report.
2. In the Privilege Analysis page, select the policy on which you generated a report.
3. Select **View Reports**.

The Privilege Analysis Reports page appears.

Privilege Analysis: Reports Return

Summary Unused Used

The usage report provides a hierarchical representation of each unused and used privilege, and the grant path. From here, you can revoke and regrant privileges and roles to and from users as necessary.

Search

Policy: dba_role_pool * Grantee: DBA

Revoke Regrant

Grantee	Type	Used	Revoked	System Privileges		Object Privileges	
				Unused	Used	Unused	Used
DBA	Role			517		33488	

4. To view the report, do the following:
 - By default, the selected report will appear, but to search for a report for another policy, use the Search region to find a different report, or to select a different grantee for the currently selected policy.
 - To view unused privileges, select the **Unused** tab; to view the used privileges, select **Used**. To view a summary of both, select **Summary**.

From here, you can select roles to revoke or regrant to users as necessary. To do so, under **Grantee**, select the role and then click **Revoke** or **Regrant**.

Related Topics

- [Generating a Privilege Analysis Report Using Cloud Control](#)
You can generate a privilege analysis report using Cloud Control.

5.2.8 Dropping a Privilege Analysis Policy

Before you can drop a privilege analysis policy, you must first disable it.

Dropping a privilege analysis policy also drops all the used and unused privilege records associated with this privilege analysis. If you created capture runs for the policy, then they are dropped when you drop the policy.

1. Log in to the CDB or PDB as a user who has the `CAPTURE_ADMIN` role.

To find the available PDBs in a CDB, log in to the CDB root container and then query the `PDB_NAME` column of the `DBA_PDBS` data dictionary view. To check the current container, run the `show con_name` command.

2. Query the `NAME` and `ENABLE` columns of the `DBA_PRIV_CAPTURES` data dictionary view to find the policy and to check if it is enabled or disabled.
3. If the policy is enabled, then disable it.

For example:

```
EXEC DBMS_PRIVILEGE_CAPTURE.DISABLE_CAPTURE ('logon_users_analysis_pol');
```

4. Run the `DBMS_PRIVILEGE_CAPTURE.DROP_CAPTURE` procedure to drop the policy.

For example:

```
EXEC DBMS_PRIVILEGE_CAPTURE.DROP_CAPTURE ('logon_users_analysis_pol');
```

If you had enabled the policy with a capture run, then the capture run is dropped as well. To individually drop a capture run, you can run the `DBMS_PRIVILEGE_CAPTURE.DELETE_RUN` procedure, but the policy must exist before you can run this statement.

Related Topics

- [Disabling a Privilege Analysis Policy](#)
You must disable the privilege analysis policy before you can generate a privilege analysis report.

5.3 Creating Roles and Managing Privileges Using Cloud Control

You can create new roles using privileges found in a privilege analysis report and then grant this role to users.

- [Creating a Role from a Privilege Analysis Report in Cloud Control](#)
You can use the report summary to find the least number of privileges an application needs, and encapsulate these privileges into a role.
- [Revoking and Regranting Roles and Privileges Using Cloud Control](#)
You can use Enterprise Manager Cloud Control to revoke and regrant roles and privileges to users.
- [Generating a Revoke or Regrant Script Using Cloud Control](#)
You can generate a script that revokes or regrants privileges from and to users, based on the results of privilege analysis reports.

5.3.1 Creating a Role from a Privilege Analysis Report in Cloud Control

You can use the report summary to find the least number of privileges an application needs, and encapsulate these privileges into a role.

1. Log in to Cloud Control as a user who has been granted the `CAPTURE_ADMIN` role and the `SELECT ANY DICTIONARY` privilege.
Oracle Database 2 Day DBA explains how to log in.
2. On the Privilege Analysis page, select the policy name, and then from **Actions** menu, click **Create Role**.
3. On the Create Role page, provide the following details, and then click **OK**:
 - Select the policy from which you would like to create a new role.
 - Enter a unique name for the new role that you want to create.
 - Select the **Used** or **Unused** check box, depending on what your role must encapsulate. The role can have used or unused system and object privileges and roles.
 - Select the corresponding radio buttons for **Directly Granted System Privileges**, **Directly Granted Object Privileges**, and **Directly Granted Roles**.

For example, if you select the **Used** check box, and select:

- **All** system privileges, then all the used system privileges captured are included in the new role that you are creating.
- **None** for role, then no role that is captured in the policy will be used in the new role.
- **Customize** object privileges, then a list of available used objects privileges captured are displayed, you need to select the privileges from the list to assign to the role.

5.3.2 Revoking and Regranting Roles and Privileges Using Cloud Control

You can use Enterprise Manager Cloud Control to revoke and regrant roles and privileges to users.

1. If Oracle Database Vault is enabled, then ensure that you are authorized as an owner of the Oracle System Privilege and Role Management realm.
In SQL*Plus, a user who has been granted the `DV_OWNER` role can check the authorization by querying the `DBA_DV_REALM_AUTH` data dictionary view. To grant the user authorization, use the `DBMS_MACADM.ADD_AUTH_TO_REALM` procedure.
2. Generate the privilege analysis report.
3. In the Privilege Analysis page, select the policy on which you generated a report.
4. Select **View Reports**.
5. In the Privilege Analysis: Reports page, select the **Summary** tab.
6. Under Search, ensure that the **Policy** and **Grantee** menu options are set.
7. Under the Grantee area, expand the grantee options.

For example, for a role privilege analysis report for a role called `HR_ADMIN` role, you would expand the `HR_ADMIN` role to show the privileges that are associated with it.

8. Select each privilege to revoke and then click **Revoke**, or select **Regrant** to regrant the privilege to the role.

Related Topics

- [Generating a Privilege Analysis Report Using Cloud Control](#)
You can generate a privilege analysis report using Cloud Control.

5.3.3 Generating a Revoke or Regrant Script Using Cloud Control

You can generate a script that revokes or regrants privileges from and to users, based on the results of privilege analysis reports.

- [About Generating Revoke and Regrant Scripts](#)
You can perform a bulk revoke of unused system and object privileges and roles by using scripts that you can download after you have generated the privilege analysis.
- [Generating a Revoke Script](#)
You can use Enterprise Manager Cloud Control to generate a script that revokes privileges from users.
- [Generating a Regrant Script](#)
You can use Enterprise Manager Cloud Control to generate a script that regrants privileges that have been revoked from users.

5.3.3.1 About Generating Revoke and Regrant Scripts

You can perform a bulk revoke of unused system and object privileges and roles by using scripts that you can download after you have generated the privilege analysis.

Later on, if you want to regrant these privileges back to the user, you can generate a regrant script. In order to generate the regrant script, you must have a corresponding revoke script.

Run the revoke scripts in a development or test environment. Be aware that you cannot revoke privileges and roles from Oracle-supplied accounts and roles.

5.3.3.2 Generating a Revoke Script

You can use Enterprise Manager Cloud Control to generate a script that revokes privileges from users.

1. If Oracle Database Vault is enabled, then ensure that you are authorized as an owner of the Oracle System Privilege and Role Management realm.

In SQL*Plus, a user who has been granted the `DV_OWNER` role can check the authorization by querying the `DBA_DV_REALM_AUTH` data dictionary view. To grant the user authorization, use the `DBMS_MACADM.ADD_AUTH_TO_REALM` procedure.
2. In Enterprise Manager, access the target Database home page as a user who has been granted the `CAPTURE_ADMIN` role and the `SELECT ANY DICTIONARY` privilege.
3. From the **Security** menu, select **Privilege Analysis**.
4. Ensure that the privilege analysis reports that you want have been generated.
5. In the Privilege Analysis page, from the **Actions** menu, select **Revoke Scripts**.
6. On the Revoke Scripts page, click **Generate**.

The generate revoke script details wizard is displayed.

7. In the Script Details page, do the following: select a policy name from the **Policy Name** menu against which the revoke script needs to be prepared.
8. In the **Script Name** field, enter a unique name and for **Description**, a description for the script.

For example, if you want to revoke all the unused privileges, select the **All** option for all the unused privileges and roles, and click **Next**.

Based on your selection, and the available privileges, all the unused system privileges, object privileges, and roles that are going to be revoked are displayed on the respective pages.
9. For **Grantee (user/role)**, select **All** or **Customize**.
10. Select **All**, **None**, or **Customize** for the **Unused System Privileges**, **Unused Object Privileges**, and **Unused Roles** settings.
11. Click **Next**.

The next pages that appear depend on your selections of **All**, **None**, or **Customize**. If you selected all, the page displays a listing of the privileges. If you selected **None**, the page is bypassed. If you selected **Customize**, then you can individually select the privileges to revoke. The last page that appears is the Review page.
12. Click **Save**.

The Revoke Scripts page appears.
13. In the Revoke Scripts page, select the newly created SQL script, and then click **Download Revoke Script** to download this script, which contains `REVOKE` SQL statements for each privilege or role.

To view the script, click the **View Revoke Script** button.
14. To return to the Privilege Analysis page, click **Return**.

Related Topics

- [Generating a Privilege Analysis Report Using Cloud Control](#)
You can generate a privilege analysis report using Cloud Control.

5.3.3.3 Generating a Regrant Script

You can use Enterprise Manager Cloud Control to generate a script that regrants privileges that have been revoked from users.

1. If Oracle Database Vault is enabled, then ensure that you are authorized as an owner of the Oracle System Privilege and Role Management realm.

In SQL*Plus, a user who has been granted the `DV_OWNER` role can check the authorization by querying the `DBA_DV_REALM_AUTH` data dictionary view. To grant the user authorization, use the `DBMS_MACADM.ADD_AUTH_TO_REALM` procedure.
2. In Enterprise Manager, access the target Database home page as a user who has been granted the `CAPTURE_ADMIN` role and the `SELECT ANY DICTIONARY` privilege.
3. From the **Security** menu, select **Privilege Analysis**.
4. Ensure that the privilege analysis reports you want have been generated.
5. In the Privilege Analysis page, select the policy on which the revoke script was based.
6. From the **Actions** menu, select **Revoke Scripts**.

7. In the Revoke Scripts page, select the policy name that you had created earlier, and then click **Download Regrant Script** to download this script.

You can view the scripts that are associated with the policy by selecting the **View Revoke Script** and **View Regrant Script** buttons.

Related Topics

- [Generating a Privilege Analysis Report Using Cloud Control](#)
You can generate a privilege analysis report using Cloud Control.

5.4 Tutorial: Using Capture Runs to Analyze ANY Privilege Use

This tutorial demonstrates how to create capture runs to analyze the use of the `READ ANY TABLE` system privilege.

- [Step 1: Create User Accounts](#)
You must create two users, one user to create the policy and a second user whose privilege use will be analyzed.
- [Step 2: Create and Enable a Privilege Analysis Policy](#)
The user `pa_admin` must create and enable the privilege analysis policy.
- [Step 3: Use the READ ANY TABLE System Privilege](#)
User `app_user` uses the `READ ANY TABLE` system privilege.
- [Step 4: Disable the Privilege Analysis Policy](#)
You must disable the policy before you can generate a report that captures the actions of user `app_user`.
- [Step 5: Generate and View a Privilege Analysis Report](#)
With the privilege analysis policy disabled, user `pa_admin` then can generate and view a privilege analysis report.
- [Step 6: Create a Second Capture Run](#)
Next, you are ready to create a second capture run for the `ANY_priv_analysis_pol` privilege analysis policy.
- [Step 7: Remove the Components for This Tutorial](#)
You can remove the components that you created for this tutorial if you no longer need them.

5.4.1 Step 1: Create User Accounts

You must create two users, one user to create the policy and a second user whose privilege use will be analyzed.

1. Log into a PDB as a user who has the `CREATE USER` system privilege.

For example:

```
sqlplus sec_admin@pdb_name  
Enter password: password
```

To find the available PDBs, query the `DBA_PDBS` data dictionary view. To check the current PDB, run the `show con_name` command.

2. Create the following users:

```
CREATE USER pa_admin IDENTIFIED BY password;  
CREATE USER app_user IDENTIFIED BY password;
```

Replace *password* with a password that is secure.

3. Connect as a user who has the privileges to grant roles and system privileges to other users, and who has been granted the owner authorization for the Oracle System Privilege and Role Management realm. (User `SYS` has these privileges by default.)

For example:

```
CONNECT dba_psmith@pdb_name
Enter password: password
```

In SQL*Plus, a user who has been granted the `DV_OWNER` role can check the authorization by querying the `DBA_DV_REALM_AUTH` data dictionary view. To grant the user authorization, use the `DBMS_MACADM.ADD_AUTH_TO_REALM` procedure.

4. Grant the following role and privilege to the users.

```
GRANT CREATE SESSION, CAPTURE_ADMIN TO pa_admin;
GRANT CREATE SESSION, READ ANY TABLE TO app_user;
```

User `pa_admin` will create the privilege analysis policy that will analyze the `READ ANY TABLE` query that user `app_user` will perform.

Related Topics

- [Guidelines for Securing Passwords](#)
Oracle provides guidelines for securing passwords in a variety of situations.

5.4.2 Step 2: Create and Enable a Privilege Analysis Policy

The user `pa_admin` must create and enable the privilege analysis policy.

1. Connect to the PDB as user `pa_admin`.

```
CONNECT pa_admin@pdb_name
Enter password: password
```

2. Create the following privilege analysis policy:

```
BEGIN
  DBMS_PRIVILEGE_CAPTURE.CREATE_CAPTURE(
    name          => 'ANY_priv_analysis_pol',
    description    => 'Analyzes system privilege use',
    type           => DBMS_PRIVILEGE_CAPTURE.G_CONTEXT,
    condition      => 'SYS_CONTEXT(''USERENV'', ''SESSION_USER'')='''APP_USER''';
  END;
/
```

In this example:

- `type` specifies the type of capture condition that is defined by the `condition` parameter, described next. In this policy, the type is a context-based condition.
 - `condition` specifies condition using a Boolean expression that must evaluate to `TRUE` for the policy to take effect. In this case, the condition checks if the session user is `app_user`.
3. Enable the policy and create a capture run for it.

```
BEGIN
  DBMS_PRIVILEGE_CAPTURE.ENABLE_CAPTURE (
    name          => 'ANY_priv_analysis_pol',
    run_name      => 'ANY_priv_pol_run_1');
  END;
```

```
END;
/
```

At this point, the policy is ready to start recording the actions of user `app_user`.

5.4.3 Step 3: Use the READ ANY TABLE System Privilege

User `app_user` uses the `READ ANY TABLE` system privilege.

1. Connect as user `app_user`.

```
CONNECT app_user@pdb_name
Enter password: password
```

2. Query the `HR.EMPLOYEES` table.

```
SELECT FIRST_NAME, LAST_NAME, SALARY FROM HR.EMPLOYEES WHERE SALARY > 12000 ORDER BY
SALARY DESC;
```

FIRST_NAME	LAST_NAME	SALARY
Steven	King	24000
Neena	Kochhar	17000
Lex	De Haan	17000
John	Russell	14000
Karen	Partners	13500
Michael	Hartstein	13000
Shelley	Higgins	12008
Nancy	Greenberg	12008

5.4.4 Step 4: Disable the Privilege Analysis Policy

You must disable the policy before you can generate a report that captures the actions of user `app_user`.

1. Connect as user `pa_admin`.

```
CONNECT pa_admin@pdb_name
Enter password: password
```

2. Disable the `ANY_priv_analysis_pol` privilege policy.

```
EXEC DBMS_PRIVILEGE_CAPTURE.DISABLE_CAPTURE ('ANY_priv_analysis_pol');
```

5.4.5 Step 5: Generate and View a Privilege Analysis Report

With the privilege analysis policy disabled, user `pa_admin` then can generate and view a privilege analysis report.

1. As user `pa_admin`, generate the privilege analysis results.

```
BEGIN
  DBMS_PRIVILEGE_CAPTURE.GENERATE_RESULT (
    name      => 'ANY_priv_analysis_pol',
    run_name  => 'ANY_priv_pol_run_1');
END;
/
```

The generated results are stored in the privilege analysis data dictionary views.

2. Enter the following commands to format the data dictionary view output:

```
col username format a10
col sys_priv format a16
col object_owner format a13
col object_name format a23
col run_name format a27
```

- Find the system privileges that `app_user` used and the objects on which `app_user` used them during the privilege analysis period.

```
SELECT SYS_PRIV, OBJECT_OWNER, OBJECT_NAME, RUN_NAME FROM DBA_USED_PRIVS WHERE
USERNAME = 'APP_USER';
```

Output similar to the following appears. The first row shows that `app_user` used the `READ ANY TABLE` privilege on the `HR.EMPLOYEES` table.

SYS_PRIV	OBJECT_OWNER	OBJECT_NAME	RUN_NAME
	SYSTEM	PRODUCT_PRIVS	ANY_PRIV_POL_RUN_1
	SYS	DUAL	ANY_PRIV_POL_RUN_1
	SYS	DUAL	ANY_PRIV_POL_RUN_1
CREATE SESSION			ANY_PRIV_POL_RUN_1
	SYS	DBMS_APPLICATION_INFO	ANY_PRIV_POL_RUN_1
READ ANY TABLE	HR	EMPLOYEES	ANY_PRIV_POL_RUN_1

At this stage, the privilege analysis results remain available in the privilege analysis data dictionary views, even if you create additional capture runs in the future.

5.4.6 Step 6: Create a Second Capture Run

Next, you are ready to create a second capture run for the `ANY_priv_analysis_pol` privilege analysis policy.

- As user `pa_admin`, enable the `ANY_priv_analysis_pol` privilege analysis policy to use capture run `ANY_priv_pol_run_1`.

```
BEGIN
  DBMS_PRIVILEGE_CAPTURE.ENABLE_CAPTURE (
    name      => 'ANY_priv_analysis_pol',
    run_name  => 'ANY_priv_pol_run_2');
END;
/
```

- Connect as user `app_user`.

```
CONNECT app_user@pdb_name
Enter password: password
```

- Query the `HR.JOBS` table.

```
SELECT MAX_SALARY FROM HR.JOBS WHERE MAX_SALARY > 20000;
```

- Connect as user `pa_admin`.

```
CONNECT pa_admin@pdb_name
Enter password: password
```

- Disable the `ANY_priv_analysis_pol` privilege policy.

```
EXEC DBMS_PRIVILEGE_CAPTURE.DISABLE_CAPTURE ('ANY_priv_analysis_pol');
```

- Generate a second privilege analysis report.

```
BEGIN
  DBMS_PRIVILEGE_CAPTURE.GENERATE_RESULT (
    name      => 'ANY_priv_analysis_pol',
```

```
run_name => 'ANY_priv_pol_run_2');
END;
/
```

- Find the system privileges that `app_user` used and the objects on which this user used them during the privilege analysis period.

```
SELECT SYS_PRIV, OBJECT_OWNER, OBJECT_NAME, RUN_NAME FROM DBA_USED_PRIVS WHERE
USERNAME = 'APP_USER' ORDER BY RUN_NAME;
```

Output similar to the following appears, which now shows the results of both of the capture runs that user `pa_admin` created.

SYS_PRIV	OBJECT_OWNER	OBJECT_NAME	RUN_NAME
READ ANY TABLE	HR	EMPLOYEES	ANY_PRIV_POL_RUN_1
	SYS	DUAL	ANY_PRIV_POL_RUN_1
CREATE SESSION			ANY_PRIV_POL_RUN_1
	SYS	DUAL	ANY_PRIV_POL_RUN_1
	SYSTEM	PRODUCT_PRIVS	ANY_PRIV_POL_RUN_1
	SYS	DBMS_APPLICATION_INFO	ANY_PRIV_POL_RUN_1
	SYS	DUAL	ANY_PRIV_POL_RUN_2
	SYS	DBMS_APPLICATION_INFO	ANY_PRIV_POL_RUN_2
	SYSTEM	PRODUCT_PRIVS	ANY_PRIV_POL_RUN_2
	SYS	DUAL	ANY_PRIV_POL_RUN_2
READ ANY TABLE	HR	JOBS	ANY_PRIV_POL_RUN_2

5.4.7 Step 7: Remove the Components for This Tutorial

You can remove the components that you created for this tutorial if you no longer need them.

- As user `pa_admin`, drop the `ANY_priv_analysis_pol` privilege analysis policy and its associated capture runs.

```
EXEC DBMS_PRIVILEGE_CAPTURE.DROP_CAPTURE ('ANY_priv_analysis_pol');
```

Any capture runs that are associated with this policy are dropped automatically when you run the `DBMS_PRIVILEGE_CAPTURE.DROP_CAPTURE` procedure.

Even though in the next steps you will drop the `pa_admin` user, including any objects created in this user's schema, you must manually drop the `ANY_priv_analysis_pol` privilege analysis policy because this object resides in the `SYS` schema.

- Connect as the user who created the user accounts.

For example:

```
CONNECT sec_admin@pdb_name
Enter password: password
```

- Drop the users `pa_admin` and `app_user`.

```
DROP USER pa_admin CASCADE;
DROP USER app_user;
```

5.5 Tutorial: Analyzing Privilege Use by a User Who Has the DBA Role

This tutorial demonstrates how to analyze the privilege use of a user who has the `DBA` role and performs database tuning operations.

- **Step 1: Create User Accounts**
You must create two users, one to create the privilege analysis policy and a second user whose privilege use will be analyzed.
- **Step 2: Create and Enable a Privilege Analysis Policy**
User `pa_admin` must create the and enable the privilege analysis policy.
- **Step 3: Perform the Database Tuning Operations**
User `tjones` uses the DBA role to perform database tuning operations.
- **Step 4: Disable the Privilege Analysis Policy**
You must disable the policy before you can generate a report that captures the actions of user `tjones`.
- **Step 5: Generate and View Privilege Analysis Reports**
With the privilege analysis policy disabled, user `pa_admin` can generate and view privilege analysis reports.
- **Step 6: Remove the Components for This Tutorial**
You can remove the components that you created for this tutorial if you no longer need them.

5.5.1 Step 1: Create User Accounts

You must create two users, one to create the privilege analysis policy and a second user whose privilege use will be analyzed.

1. Log into a PDB as a user who has the `CREATE USER` system privilege.

For example:

```
sqlplus sec_admin@pdb_name  
Enter password: password
```

To find the available PDBs, query the `DBA_PDBS` data dictionary view. To check the current PDB, run the `show con_name` command.

2. Create the following users:

```
CREATE USER pa_admin IDENTIFIED BY password;  
CREATE USER tjones IDENTIFIED BY password;
```

Replace `password` with a password that is secure.

3. Connect as a user who has the privileges to grant roles and system privileges to other users, and who has been granted the owner authorization for the Oracle System Privilege and Role Management realm. (User `SYS` has these privileges by default.)

For example:

```
CONNECT dba_psmith@pdb_name  
Enter password: password
```

In SQL*Plus, a user who has been granted the `DV_OWNER` role can check the authorization by querying the `DBA_DV_REALM_AUTH` data dictionary view. To grant the user authorization, use the `DBMS_MACADM.ADD_AUTH_TO_REALM` procedure.

4. Grant the following roles and privileges to the users.

```
GRANT CREATE SESSION, CAPTURE_ADMIN TO pa_admin;  
GRANT CREATE SESSION, DBA TO tjones;
```

User `pa_admin` will create the privilege analysis policy that will analyze the database tuning operations that user `tjones` will perform.

Related Topics

- [Guidelines for Securing Passwords](#)
Oracle provides guidelines for securing passwords in a variety of situations.

5.5.2 Step 2: Create and Enable a Privilege Analysis Policy

User `pa_admin` must create the and enable the privilege analysis policy.

1. Connect to the PDB as user `pa_admin`.

```
CONNECT pa_admin@pdb_name
Enter password: password
```

2. Create the following privilege analysis policy:

```
BEGIN
  DBMS_PRIVILEGE_CAPTURE.CREATE_CAPTURE(
    name           => 'dba_tuning_priv_analysis_pol',
    description    => 'Analyzes DBA tuning privilege use',
    type           => DBMS_PRIVILEGE_CAPTURE.G_CONTEXT,
    condition      => 'SYS_CONTEXT(''USERENV'', ''SESSION_USER'')='''TJONES''';
END;
/
```

In this example:

- `type` specifies the type of capture condition that is defined by the `condition` parameter, described next. In this policy, the type is a context-based condition.
 - `condition` specifies condition using a Boolean expression that must evaluate to `TRUE` for the policy to take effect. In this case, the condition checks if the session user is `tjones`.
3. Enable the policy.

```
EXEC DBMS_PRIVILEGE_CAPTURE.ENABLE_CAPTURE ('dba_tuning_priv_analysis_pol');
```

At this point, the policy is ready to start recording the actions of user `tjones`.

5.5.3 Step 3: Perform the Database Tuning Operations

User `tjones` uses the `DBA` role to perform database tuning operations.

1. Connect to the PDB as user `tjones`.

```
CONNECT tjones@pdb_name
Enter password: password
```

2. Run the following script to create the `PLAN_TABLE` table.

```
@$ORACLE_HOME/rdbms/admin/utlxplan.sql
```

The location of this script may vary depending on your operating system. This script creates the `PLAN_TABLE` table in the `tjones` schema.

3. Run the following `EXPLAIN PLAN SQL` statement on the `HR.EMPLOYEES` table:

```
EXPLAIN PLAN
  SET STATEMENT_ID = 'Raise in Tokyo'
```

```
INTO PLAN_TABLE
FOR UPDATE HR.EMPLOYEES
SET SALARY = SALARY * 1.10
WHERE DEPARTMENT_ID =
(SELECT DEPARTMENT_ID FROM HR.DEPARTMENTS WHERE LOCATION_ID = 110);
```

Next, user `tjones` will analyze the `HR.EMPLOYEES` table.

4. Run either of the following scripts to create the `CHAINED_ROWS` table

```
@$ORACLE_HOME/rdbms/admin/utlchain.sql
```

Or

```
@$ORACLE_HOME/rdbms/admin/utlchn1.sql
```

5. Run the `ANALYZE TABLE` statement on the `HR.EMPLOYEES` table.

```
ANALYZE TABLE HR.EMPLOYEES LIST CHAINED ROWS INTO CHAINED_ROWS;
```

5.5.4 Step 4: Disable the Privilege Analysis Policy

You must disable the policy before you can generate a report that captures the actions of user `tjones`.

1. Connect as user `pa_admin`.

```
CONNECT pa_admin@pdb_name
Enter password: password
```

2. Disable the `dba_tuning_priv_analysis_pol` privilege policy.

```
EXEC DBMS_PRIVILEGE_CAPTURE.DISABLE_CAPTURE ('dba_tuning_priv_analysis_pol');
```

5.5.5 Step 5: Generate and View Privilege Analysis Reports

With the privilege analysis policy disabled, user `pa_admin` can generate and view privilege analysis reports.

1. As user `pa_admin`, generate the privilege analysis results.

```
EXEC DBMS_PRIVILEGE_CAPTURE.GENERATE_RESULT ('dba_tuning_priv_analysis_pol');
```

The generated results are stored in the privilege analysis data dictionary views.

2. Enter the following commands to format the data dictionary view output:

```
col username format a8
col sys_priv format a18
col used_role format a20
col path format a150
col obj_priv format a10
col object_owner format a10
col object_name format a10
col object_type format a10
```

3. Find the system privileges and roles that user `tjones` used during the privilege analysis period.

```
SELECT USERNAME, SYS_PRIV, USED_ROLE, PATH
FROM DBA_USED_SYSPRIVS_PATH
WHERE USERNAME = 'TJONES'
ORDER BY 1, 2, 3;
```

Output similar to the following appears:

```

USERNAME SYS_PRIV          USED_ROLE
-----
PATH
-----
TJONES  ANALYZE ANY          IMP_FULL_DATABASE
GRANT_PATH('TJONES', 'DBA')

TJONES  ANALYZE ANY          IMP_FULL_DATABASE
GRANT_PATH('TJONES', 'DBA', 'IMP_FULL_DATABASE')

TJONES  ANALYZE ANY          IMP_FULL_DATABASE
GRANT_PATH('TJONES', 'DBA', 'DATAPUMP_IMP_FULL_DATABASE', 'IMP_FULL_DATABASE')
...

```

4. Find the object privileges and roles that user `tjones` used during the privilege analysis period.

```

col username format a9
col used_role format a10
col object_name format a22
col object_type format a12

SELECT USERNAME, OBJ_PRIV, USED_ROLE,
       OBJECT_OWNER, OBJECT_NAME, OBJECT_TYPE
FROM DBA_USED_OBJPRIVS
WHERE USERNAME = 'TJONES'
ORDER BY 1, 2, 3, 4, 5, 6;

```

Output similar to the following appears:

```

USERNAME  OBJ_PRIV  USED_ROLE  OBJECT_OWN  OBJECT_NAME          OBJECT_TYPE
-----
TJONES    EXECUTE   PUBLIC     SYS         DBMS_APPLICATION_INFO PACKAGE
TJONES    SELECT    PUBLIC     SYS         DUAL                 TABLE
TJONES    SELECT    PUBLIC     SYS         DUAL                 TABLE
TJONES    SELECT    PUBLIC     SYSTEM      PRODUCT_PRIVS       VIEW
...

```

5. Find the unused system privileges for user `tjones`.

```

col username format a9
col sys_priv format a35

SELECT USERNAME, SYS_PRIV
FROM DBA_UNUSED_SYSPRIVS
WHERE USERNAME = 'TJONES'
ORDER BY 1, 2;

USERNAME SYS_PRIV
-----
TJONES  ADMINISTER ANY SQL TUNING SET
TJONES  ADMINISTER DATABASE TRIGGER
TJONES  ADMINISTER RESOURCE MANAGER
TJONES  ADMINISTER SQL TUNING SET
TJONES  ALTER ANY ASSEMBLY
TJONES  ON COMMIT REFRESH
...

```

5.5.6 Step 6: Remove the Components for This Tutorial

You can remove the components that you created for this tutorial if you no longer need them.

1. As user `pa_admin`, drop the `dba_tuning_priv_analysis_pol` privilege analysis policy.

```
EXEC DBMS_PRIVILEGE_CAPTURE.DROP_CAPTURE ('dba_tuning_priv_analysis_pol');
```

Even though in the next steps you will drop the `pa_admin` user, including any objects created in this user's schema, you must manually drop the `dba_tuning_priv_analysis_pol` privilege analysis policy because this object resides in the `SYS` schema.

2. Connect as the user who created the user accounts.

For example:

```
CONNECT sec_admin@pdb_name  
Enter password: password
```

3. Drop the users `pa_admin` and `tjones`.

```
DROP USER pa_admin CASCADE;  
DROP USER tjones;
```

5.6 Tutorial: Capturing Schema Privilege Use

This tutorial shows how to capture a user's schema privilege use for the `SELECT ANY TABLE` and `DELETE ANY TABLE` system privileges on the `HR` schema.

- [Step 1: Create User Accounts](#)
You must create two users, one to create the privilege analysis policy and a second user whose schema privilege use will be analyzed.
- [Step 2: Create and Enable a Privilege Analysis Policy](#)
User `pa_admin` must create the and enable the privilege analysis policy.
- [Step 3: Use the READ ANY TABLE System Privilege](#)
User `sec_user` uses the `SELECT ANY TABLE` system privilege on the `HR` schema.
- [Step 4: Disable the Privilege Analysis Policy](#)
You must disable the policy before you can generate a report that captures the actions of user `sec_user`.
- [Step 5: Generate and View Privilege Analysis Reports](#)
With the privilege analysis policy disabled, user `pa_admin` can generate and view privilege analysis reports.
- [Step 6: Remove the Components for This Tutorial](#)
You can remove the components that you created for this tutorial if you no longer need them.

5.6.1 Step 1: Create User Accounts

You must create two users, one to create the privilege analysis policy and a second user whose schema privilege use will be analyzed.

1. Log into a PDB as a user who has the `CREATE USER` system privilege.

For example:

```
sqlplus sec_admin@pdb_name
Enter password: password
```

To find the available PDBs, query the `DBA_PDBS` data dictionary view. To check the current PDB, run the `show con_name` command.

2. Create the following users:

```
CREATE USER pa_admin IDENTIFIED BY password;
CREATE USER sec_user IDENTIFIED BY password;
```

Replace `password` with a password that is secure.

3. Connect as a user who has the privileges to grant roles and system privileges to other users, and who has been granted the owner authorization for the Oracle System Privilege and Role Management realm. (User `SYS` has these privileges by default.)

For example:

```
CONNECT dba_psmith@pdb_name
Enter password: password
```

In SQL*Plus, a user who has been granted the `DV_OWNER` role can check the authorization by querying the `DBA_DV_REALM_AUTH` data dictionary view. To grant the user authorization, use the `DBMS_MACADM.ADD_AUTH_TO_REALM` procedure.

4. Grant the following roles and privileges to the users.

```
GRANT CREATE SESSION, CAPTURE_ADMIN TO pa_admin;
GRANT CREATE SESSION TO sec_user;
```

User `pa_admin` will create the privilege analysis policy that will analyze the database tuning operations that user `sec_user` will perform.

5. For user `sec_user`, grant the `SELECT ANY TABLE` and `DELETE ANY TABLE` system privileges as schema privileges for the `HR` schema.

```
GRANT SELECT ANY TABLE, DELETE ANY TABLE ON SCHEMA HR TO sec_user;
```

Related Topics

- [Guidelines for Securing Passwords](#)
Oracle provides guidelines for securing passwords in a variety of situations.

5.6.2 Step 2: Create and Enable a Privilege Analysis Policy

User `pa_admin` must create the and enable the privilege analysis policy.

1. Connect to the PDB as user `pa_admin`.

```
CONNECT pa_admin@pdb_name
Enter password: password
```

2. Create the following privilege analysis policy:

```
BEGIN
  DBMS_PRIVILEGE_CAPTURE.CREATE_CAPTURE(
    name          => 'sec_user_capture_pol',
    description   => 'Captures sec_user used and not used privileges',
    type          => DBMS_PRIVILEGE_CAPTURE.G_DATABASE);
END;
/
```

In this example, `type` specifies that the type is a database wide condition.

3. Enable the policy.

```
EXEC DBMS_PRIVILEGE_CAPTURE.ENABLE_CAPTURE ('sec_user_capture_pol');
```

At this point, the policy is ready to start recording the actions of user `sec_user`.

5.6.3 Step 3: Use the READ ANY TABLE System Privilege

User `sec_user` uses the `SELECT ANY TABLE` system privilege on the `HR` schema.

1. Connect as user `sec_user`.

```
CONNECT sec_user@pdb_name
Enter password: password
```

2. Query the `HR.EMPLOYEES` table.

```
SELECT FIRST_NAME, LAST_NAME FROM HR.EMPLOYEES WHERE SALARY > 8000;
```

FIRST_NAME	LAST_NAME
-----	-----
Steven	King
Neena	Kochhar
Lex	De Haan
Alexander	Hunold
Nancy	Greenberg
Daniel	Faviet
...	

5.6.4 Step 4: Disable the Privilege Analysis Policy

You must disable the policy before you can generate a report that captures the actions of user `sec_user`.

1. Connect as user `pa_admin`.

```
CONNECT pa_admin@pdb_name
Enter password: password
```

2. Disable the `sec_user_capture_pol` privilege policy.

```
EXEC DBMS_PRIVILEGE_CAPTURE.DISABLE_CAPTURE ('sec_user_capture_pol');
```

5.6.5 Step 5: Generate and View Privilege Analysis Reports

With the privilege analysis policy disabled, user `pa_admin` can generate and view privilege analysis reports.

1. As user `pa_admin`, generate the privilege analysis results.

```
EXEC DBMS_PRIVILEGE_CAPTURE.GENERATE_RESULT ('sec_user_capture_pol');
```

The generated results are stored in the privilege analysis data dictionary views.

2. Enter the following commands to format the data dictionary view output:

```
col sch_priv format a20
col schema format a20
```

3. Find the schema privileges that user `sec_user` used during the privilege analysis period.

```
SELECT SCH_PRIV, SCHEMA FROM DBA_USED_SCHEMA_PRIVS WHERE USERNAME = 'SEC_USER';
```

Output similar to the following appears:

```
SCH_PRIV          SCHEMA
-----
SELECT ANY TABLE      HR
```

4. Find the unused schema privileges for user `sec_user`.

```
SELECT SCH_PRIV, SCHEMA FROM DBA_UNUSED_SCHEMA_PRIVS WHERE USERNAME = 'SEC_USER';
```

Output similar to the following appears:

```
SCH_PRIV          SCHEMA
-----
DELETE ANY TABLE    HR
```

5.6.6 Step 6: Remove the Components for This Tutorial

You can remove the components that you created for this tutorial if you no longer need them.

1. As user `pa_admin`, drop the `sec_user_capture_pol` privilege analysis policy.

```
EXEC DBMS_PRIVILEGE_CAPTURE.DROP_CAPTURE ('sec_user_capture_pol');
```

Even though in the next steps you will drop the `pa_admin` user, including any objects created in this user's schema, you must manually drop the `sec_user_capture_pol` privilege analysis policy because this object resides in the `SYS` schema.

2. Connect as the user who created the user accounts.

For example:

```
CONNECT sec_admin@pdb_name
Enter password: password
```

3. Drop the users `pa_admin` and `sec_user`.

```
DROP USER pa_admin CASCADE;
DROP USER sec_user;
```

5.7 Privilege Analysis Policy and Report Data Dictionary Views

Oracle Database provides a set of data dictionary views that provide information about analyzed privileges.

[Table 5-1](#) lists these data dictionary views.

Table 5-1 Data Dictionary Views That Display Privilege Analysis Information

View	Description
<code>DBA_PRIV_CAPTURES</code>	Lists information about existing privilege analysis policies
<code>DBA_USED_SCHEMA_PRIVS</code>	Lists the schema privileges that are used for the privilege analysis policies
<code>DBA_USED_SCHEMA_PRIVS_PATH</code>	Lists the schema privileges that are used for the privilege analysis policies. It includes the schema privilege grant paths.

Table 5-1 (Cont.) Data Dictionary Views That Display Privilege Analysis Information

View	Description
DBA_USED_PRIVS	Lists the privileges and capture runs that have been used for reported privilege analysis policies
DBA_UNUSED_GRANTS	Lists the privilege grants that have not been used
DBA_UNUSED_PRIVS	Lists the privileges and capture runs that have not been used for reported privilege analysis policies
DBA_UNUSED_SCHEMA_PRIVS	Lists the system privileges that are not used for the privilege analysis policies
DBA_UNUSED_SCHEMA_PRIVS_PATH	Lists the system privileges that are not used for the privilege analysis policies. It includes the schema privilege grant paths.
DBA_USED_OBJPRIVS	Lists the object privileges and capture runs that have been used for reported privilege analysis policies. It does not include the object grant paths.
DBA_UNUSED_OBJPRIVS	Lists the object privileges and capture runs that have not been used for reported privilege analysis policies. It does not include the object privilege grant paths.
DBA_USED_OBJPRIVS_PATH	Lists the object privileges and capture runs that have been used for reported privilege analysis policies. It includes the object privilege grant paths.
DBA_UNUSED_OBJPRIVS_PATH	Lists the object privileges and capture runs that have not been used for reported privilege analysis policies. It includes the object privilege grant paths.
DBA_USED_SYSPRIVS	Lists the system privileges and capture runs that have been used for reported privilege analysis policies. It does not include the system privilege grant paths.
DBA_UNUSED_SYSPRIVS	Lists the system privileges and capture runs that have not been used for reported privilege analysis policies. It does not include the system privilege grant paths.
DBA_USED_SYSPRIVS_PATH	Lists the system privileges and capture runs that have been used for reported privilege analysis policies. It includes the system privilege grant paths.
DBA_UNUSED_SYSPRIVS_PATH	Lists the system privileges and capture runs that have not been used for reported privilege analysis policies. It includes system privilege grant paths
DBA_USED_PUBPRIVS	Lists all the privileges and capture runs for the PUBLIC role that have been used for reported privilege analysis policies
DBA_USED_USERPRIVS	Lists the user privileges and capture runs that have been used for reported privilege analysis policies. It does not include the user privilege grant paths.
DBA_UNUSED_USERPRIVS	Lists the user privileges and capture runs that have not been used for reported privilege analysis policies. It does not include the user privilege grant paths.
DBA_USED_USERPRIVS_PATH	Lists the user privileges and capture runs that have been used for reported privilege analysis policies. It includes the user privilege grant paths.

Table 5-1 (Cont.) Data Dictionary Views That Display Privilege Analysis Information

View	Description
DBA_UNUSED_USERPRIVS_PATH	Lists the privileges and capture runs that have not been used for reported privilege analysis policies. It includes the user privilege grant paths.

Related Topics

- *Oracle Database Reference*

6

Configuring Centrally Managed Users with Microsoft Active Directory

Oracle Database can authenticate and authorize Microsoft Active Directory users with the database directly without intermediate directories or Oracle Enterprise User Security.

- [Introduction to Centrally Managed Users with Microsoft Active Directory](#)
Centrally managed users (CMU) provides a simpler integration with Microsoft Active Directory to allow centralized authentication and authorization of users.
- [Configuring the Oracle Database-Microsoft Active Directory Integration](#)
Before you can use Microsoft Active Directory to authenticate and authorize users, you must configure the connection from the Oracle database to Active Directory.
- [Configuring Authentication for Centrally Managed Users](#)
You can configure password authentication, Kerberos authentication, or public key infrastructure (PKI) authentication.
- [Configuring Authorization for Centrally Managed Users](#)
With centrally managed users, you can manage the authorization for Active Directory users to access Oracle databases.
- [Integration of Oracle Database with Microsoft Active Directory Account Policies](#)
As part of the Oracle Database-Microsoft Active Directory integration, Oracle Database enforces the Active Directory account policies when Active Directory users log into the Oracle database.
- [Configuring Centrally Managed Users with Oracle Autonomous Database](#)
You can deploy centrally managed users (CMU) on Oracle Autonomous Database.
- [Troubleshooting Centrally Managed Users](#)
Oracle provides error messages that help you troubleshoot common errors that may arise when a Microsoft Active Directory user tries to log in to an Oracle database.

6.1 Introduction to Centrally Managed Users with Microsoft Active Directory

Centrally managed users (CMU) provides a simpler integration with Microsoft Active Directory to allow centralized authentication and authorization of users.

- [About the Oracle Database-Microsoft Active Directory Integration](#)
Centrally managed users provides a simpler integration with Microsoft Active Directory to allow centralized authentication and authorization of users.
- [How Centrally Managed Users with Microsoft Active Directory Works](#)
The integration works by mapping Microsoft Active Directory users and groups directly to Oracle database users and roles.
- [Centrally Managed User-Microsoft Active Directory Architecture](#)
The CMU with Active Directory architecture enables Oracle Database users and roles to be managed in Active Directory.

- [Supported Authentication Methods](#)
The Oracle Database-Microsoft Active Directory integration supports three common authentication methods.
- [Users Supported by Centrally Managed Users with Microsoft Active Directory](#)
CMU with Active Directory supports exclusively mapped users, users mapped to shared schemas, and administrative users.
- [How the Oracle Multitenant Option Affects Centrally Managed Users](#)
PDB users can connect to a central Microsoft Active Directory or to a different Microsoft Active Directory.
- [Centrally Managed Users with Database Links](#)
CMU supports both fixed user database links and connected user database links, but not current user database links.

6.1.1 About the Oracle Database-Microsoft Active Directory Integration

Centrally managed users provides a simpler integration with Microsoft Active Directory to allow centralized authentication and authorization of users.

The minimum version requirement for Active Directory server operating system is Microsoft Windows Server 2012. This minimum supported version will be updated when Microsoft drops support for older releases.

This integration enables organizations to use Active Directory to centrally manage users and roles in multiple Oracle databases with a single directory along with other Information Technology services. Active Directory users can authenticate to the Oracle database by using credentials that are stored in Active Directory. Active Directory users can also be associated with database users (schemas) and roles by using Active Directory groups. Microsoft Active Directory users can be mapped to exclusive or shared Oracle Database users (schemas), and be associated with database roles through their group membership in the directory. Active Directory account policies such as password expiration time and lockout after a specified number of failed login attempts are honored by the Oracle Database when users login.

Before Oracle Database 18c release 1 (18.1), database user authentication and authorization could be integrated with Active Directory by configuring Oracle Enterprise User Security and installing and configuring Oracle Internet Directory (or Oracle Universal Directory). This architecture is still available and will continue to be used by users who must use the Oracle enterprise domain and current user database link between trusted databases, complex enterprise roles, and having a single place for auditing database access privileges and roles.

Note:

Enterprise User Security (EUS) is deprecated with Oracle Database 23ai. Oracle recommends that you migrate to using Centrally Managed Users (CMU). This feature enables you to directly connect with Microsoft Active Directory without an intervening directory service for enterprise user authentication and authorization to the database. If your Oracle Database is in the cloud, you can also choose to move to one of the newer integrations with a cloud identity provider.

The majority of organizations do not have these complex requirements. Instead, they can use centrally managed users (CMU) with Active Directory. This integration is designed for organizations who prefer to use Active Directory as their centralized identity management solution. Oracle Net Naming Services continues to work as it did before with directory services.

Organizations can use Kerberos, PKI, or password authentication with CMU with Active Directory. Use of CMU with Active Directory is backward compatible with currently supported Oracle Database clients. This means that LDAP bind operations are not used for password authentication and you will need to add an Oracle filter to Active Directory along with an extension to the Active Directory schema to store password verifiers. Organizations using Kerberos or PKI will not need to add the filter or extend Active Directory schema.

The Oracle Database-Active Directory integration is particularly beneficial for the following types of users:

- Users who are currently using strong authentication such as Kerberos or Public Key Infrastructure (PKI). These users already use a centralized identity management system
- Users who currently use Oracle Enterprise User Security, Oracle Internet Directory, Oracle Unified Directory, Oracle Virtual Directory, and need to integrate with Active Directory.

6.1.2 How Centrally Managed Users with Microsoft Active Directory Works

The integration works by mapping Microsoft Active Directory users and groups directly to Oracle database users and roles.

In order for the Oracle Database CMU with Active Directory integration to work, the Oracle database must be able to login to a service account specifically created for the database in Active Directory. The database uses this service account to query Active Directory for user and group information when a user logs into the database. This Active Directory service account must have all the privileges required to query the user and group information as well as being able to write updates related to the password policies in Active Directory (for example, failed login attempts, clear failed login attempts). Users can authenticate using passwords, Kerberos, or PKI and either be assigned to an exclusive schema or a shared schema. Mapping of an Active Directory user to a shared schema is determined by the association of the user to an Active Directory group that is mapped to the shared schema. Active Directory groups can also be mapped to database global roles. An Active Directory security administrator can assign a user to groups that are mapped to shared database global users (schemas) and/or database global roles, and hence update privileges and roles that are assigned to the Active Directory user in a database.

6.1.3 Centrally Managed User-Microsoft Active Directory Architecture

The CMU with Active Directory architecture enables Oracle Database users and roles to be managed in Active Directory.

The following figure illustrates the Oracle Database CMU feature. In this figure, users, either through applications as non-administrative users or administrative users, connect to the Oracle database with either password, Kerberos, or public key infrastructure (PKI) authentication. The database connection to Active Directory enables these users and roles to be mapped with Active Directory users and groups. If you plan to use password authentication, then you must install an Oracle filter in Active Directory. You can use an Oracle provided utility to install the Oracle filter that will generate Oracle password verifiers for individual users as needed. The utility can also be used to extend the Active Directory schema to hold the Oracle password verifiers. With Oracle Database centrally managed users, an Active Directory administrator can control the authentication, user management, account policies, and group assignments of Active Directory users and groups who have been mapped to Oracle Database users and roles.

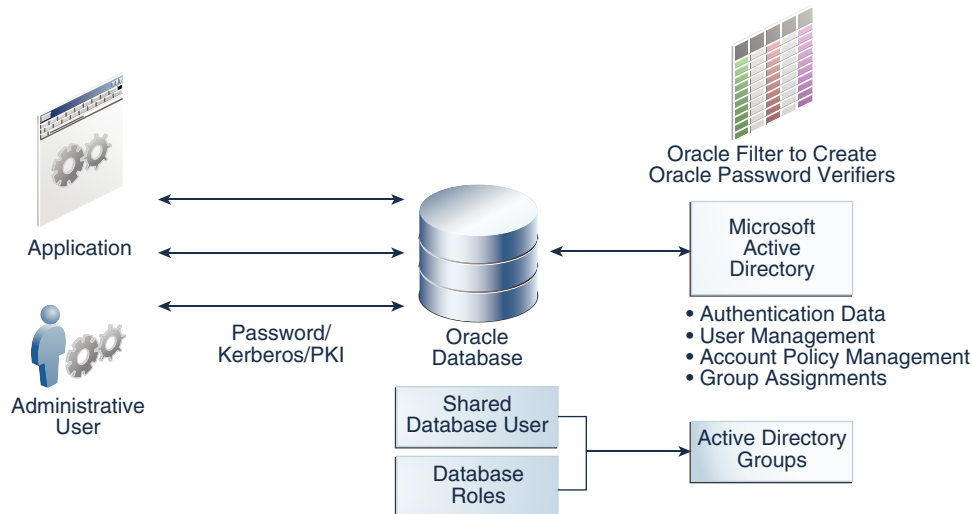

6.1.4 Supported Authentication Methods

The Oracle Database-Microsoft Active Directory integration supports three common authentication methods.

These authentication methods are as follows:

- Password authentication
- Kerberos authentication
- Public key infrastructure (PKI) authentication (certificate-based authentication)

Related Topics

- [Configuring Authentication for Centrally Managed Users](#)
You can configure password authentication, Kerberos authentication, or public key infrastructure (PKI) authentication.

6.1.5 Users Supported by Centrally Managed Users with Microsoft Active Directory

CMU with Active Directory supports exclusively mapped users, users mapped to shared schemas, and administrative users.

These users are as follows:

- Directory users that access an Oracle database using a shared schema.

This type of directory user can connect to a shared schema in the database by being part of a directory group that is mapped to the shared schema (database user). Using shared schemas allows centralized Active Directory management of database users and is the recommended best practices over using exclusive schemas (described next). Even if there is only one user associated with a schema (for example, an administrator responsible for database backup), it is easier to manage adding another backup administrator or removing the existing administrator by making changes only in Active Directory instead of making changes in all associated databases as well.

Users will be given additional privileges appropriate to their task using global roles that are mapped to groups in Active Directory. With this design, a user can change their tasks

within an organization and have new database privileges through a new group in Active Directory.

Active Directory users could accidentally (or on purpose) be a member of multiple groups in Active Directory that are mapped to different shared schemas on the same database. The user could also have an exclusive mapping to a database schema. In cases where the user has multiple possible schema mappings when they login, the following precedence rules apply:

- If an exclusive mapping exists for a user, then that mapping takes precedence over any other shared mappings.
- If multiple shared schema mappings exist for a user, then the shared user mapping with lowest schema ID (`USER_ID`) takes precedence.

Oracle recommends only having one possible mapping per user so unexpected schema mappings do not occur.

- Exclusively mapped global users who are regular Oracle Database users in two- and three-tier applications, or users who have direct privilege grants in the database.

Oracle recommends that you grant privileges to these users through global roles. This type of privilege grant facilitates authorization management by centrally managing privileges and roles for a user instead of having to log in into each database to update privileges and roles for the user.

- Administrative global users, who have the following administrative privileges: `SYSDBA`, `SYSOPER`, `SYSBACKUP`, `SYSDBG`, `SYSKM`, and `SYSRAC`.

You **cannot** grant these administrative privileges through global roles. To authorize an Active Directory user with these administrative privileges, you must map the directory user to a database user (exclusively or with a shared schema) that has the system administrative privilege already granted to the database user account.

Related Topics

- [Configuring Authorization for Centrally Managed Users](#)
With centrally managed users, you can manage the authorization for Active Directory users to access Oracle databases.

6.1.6 How the Oracle Multitenant Option Affects Centrally Managed Users

PDB users can connect to a central Microsoft Active Directory or to a different Microsoft Active Directory.

All PDBs and the root container can have a shared configuration, so that the entire CDB can authenticate and authorize users against a single Active Directory server, multiple Active Directory servers in one Windows domain, or multiple Active Directory servers in trusted Windows domains, based on the shared configuration. Alternatively, individual PDBs can authenticate and authorize users against different Active Directory servers in the same Windows domain or different (trusted or un-trusted) Windows domains, based on their individual configurations.

6.1.7 Centrally Managed Users with Database Links

CMU supports both fixed user database links and connected user database links, but not current user database links.

There is no special requirement for CMU-Active Directory users to use the fixed user database links. CMU-Active Directory users using password, Kerberos, or PKI authentication can use

fixed user database links as regular database users do. Kerberos authentication works the same with Oracle Database strong authentication with database links. For more information, see My Oracle Support note [1370327.1](#).

For CMU-Active Directory users to use connected user database links, only password authentication is supported, and both source and target databases must be configured with CMU-Active Directory to allow the same Active Directory user to log in both databases using password authentication.

6.2 Configuring the Oracle Database-Microsoft Active Directory Integration

Before you can use Microsoft Active Directory to authenticate and authorize users, you must configure the connection from the Oracle database to Active Directory.

- [About Configuring the Oracle Database-Microsoft Active Directory Connection](#)
Before you configure this connection, you must have Microsoft Active Directory installed and configured.
- [Connecting to Microsoft Active Directory](#)
You can configure a Microsoft Active Directory connection during the Oracle database creation or with an existing Oracle database.

6.2.1 About Configuring the Oracle Database-Microsoft Active Directory Connection

Before you configure this connection, you must have Microsoft Active Directory installed and configured.

You must create an Oracle service directory user in Active Directory, configure the Oracle Database connection to Active Directory, and then depending on the authentication type, configure the database and Active Directory for password, Kerberos, or public key infrastructure (PKI) authentication. Before you map Database users and global roles to Active Directory users and groups, you must ensure that the Active Directory users and groups have been created. You will map the database users and global roles to Active Directory users and groups by using the `CREATE USER`, `CREATE ROLE`, `ALTER USER`, `ALTER ROLE` SQL statements with the `GLOBALLY` clause. An Active Directory system administrator must also set up new Active Directory groups with Active Directory users to meet your requirements.

The Active Directory system administrator is responsible for setting Active Directory connections with or without SASL bind. The Oracle Database will automatically try the Active Directory connection first with SASL bind and if it fails, it will try it without SASL bind but still secured with TLS. This means that regardless of how the Microsoft Active Directory administrator may have the SASL settings configured on Active Directory, the Oracle database will connect even if the SASL bind is unsuccessful.

6.2.2 Connecting to Microsoft Active Directory

You can configure a Microsoft Active Directory connection during the Oracle database creation or with an existing Oracle database.

- [Step 1: Create an Oracle Service Directory User Account on Microsoft Active Directory and Grant Permissions](#)
The Oracle service directory user account is for the interaction between Oracle Database and the LDAP directory service.

- **Step 2: For Password Authentication, Install the Password Filter and Extend the Microsoft Active Directory Schema**
You can use the Oracle `opwdintg.exe` executable on the Active Directory server to install the password filter and extend the Active Directory schema.
- **Step 3: If Necessary, Install the Oracle Database Software**
If you have not done so yet, then use Oracle Universal Installer (OUI) to install the Oracle software.
- **Step 4: Create the `dsi.ora` or `ldap.ora` File**
The `dsi.ora` and `ldap.ora` files specify connections for centrally managed users for Active Directory.
- **Step 5: Request an Active Directory Certificate for a Secure Connection**
After you have configured the `dsi.ora` or `ldap.ora` file, you are ready to prepare Microsoft Active Directory and Oracle Database certificates for a secure connection.
- **Step 6: Create the Wallet for a Secure Connection**
After you have copied the Active Directory certificate, you are ready to add it to the Oracle wallet.
- **Step 7: Configure the Microsoft Active Directory Connection**
Next, you are ready to connect the database to Active Directory using the settings you have so far.
- **Step 8: Verify the Oracle Wallet**
The `orapki` utility can verify that the wallet for this database was created successfully.
- **Step 9: Test the Integration**
To test the integration, you must set the `ORACLE_HOME`, `ORACLE_BASE`, and `ORACLE_SID` environment variables and then verify the LDAP parameter settings.

6.2.2.1 Step 1: Create an Oracle Service Directory User Account on Microsoft Active Directory and Grant Permissions

The Oracle service directory user account is for the interaction between Oracle Database and the LDAP directory service.

In addition to being used for the Oracle Database-to-LDAP directory service interaction, the Oracle service directory user account can be used for Kerberos.

This account is an Active Directory user account that Oracle Database uses to bind to Active Directory domain controllers and query for users and groups information from Active Directory, update login success or failure, and if Kerberos is configured, update Kerberos authentication. The minimum permissions required for this account are `Read properties` (of Active Directory users who will log in to a database) permission, and if database password authentication is to be used by Active Directory users, the `Write lockoutTime` (property of the Active Directory users) permission, and `Control Access` (of the `orclCommonAttribute` property of the Active Directory users) permission. Note that the user password that you create for this account does not follow the rules that Oracle user passwords must follow when Oracle password complexity functions are in place.

1. Log in to a Windows domain controller of Microsoft Active Directory as an administrator who has administrative privileges to create a user account and grant permissions to the user account.
2. Create the Oracle service directory user account as an Active Directory user.

Create the service user account in the directory. Depending on the Windows domains that your Active Directory users will use, you can choose where the service user account will be created. Follow these guidelines:

- If all the Active Directory users will be in one domain, then create this account in that domain. Doing so will help performance.
 - If the Active Directory users will be in multiple Windows domains, then create this service user account in a domain that is trusted by all other domains.
 - The domain chosen must be trusted by all other domains.
 - The service user must be able to bind to all of these multiple Windows domains, and must be able to access the properties of Active Directory users in all of these multiple Windows domains with the granted permissions.
 - All other domains must support simple bind over TLS/SSL to allow the access of the service user from the trusted domain.
 - All other domains administrators must grant the required minimum permissions to the service user account from the trusted domain.
3. Grant the Oracle service directory user account in the Active Directory the following permissions on the properties of the Active Directory users who need to access Oracle databases:
- Read `properties` (of Active Directory users who will log in to an Oracle database)
 - Write `lockoutTime` (property of Active Directory users who will use password authentication to log in to an Oracle database)
 - Control Access (of the `orclCommonAttribute` property of the Active Directory users who will use password authentication to log in to an Oracle database)

6.2.2.2 Step 2: For Password Authentication, Install the Password Filter and Extend the Microsoft Active Directory Schema

You can use the Oracle `opwdintg.exe` executable on the Active Directory server to install the password filter and extend the Active Directory schema.

You do not need to perform this step if your authentication method is Kerberos or SSL. The `opwdintg.exe` executable installs the Oracle password filter, extends the Active Directory schema, and creates Active Directory groups to allow Oracle Database password authentication with Active Directory. This procedure adds an `orclCommonAttribute` property to the Active Directory schema for user accounts.

Note:

You must install the Oracle password filter on **every** Windows domain controller in a domain, to ensure that Oracle password verifiers will be generated for Active Directory users in this domain if they need to use password authentication to log in Oracle database.

Note also that `orclCommonAttribute` stores Oracle password verifier for the Active Directory user. This attribute is also used for password authentication by other Oracle products or features such as Enterprise User Security. For security consideration, you should deny everyone except the Oracle service directory user from accessing the `orclCommonAttribute` property. (Note that Oracle Enterprise User Security (EUS) is deprecated with Oracle Database 23ae.)

1. Access the latest version of the `opwdintg.exe` (Oracle Password Integration) utility.

- **If you have a My Oracle Support account:** Log in to your account at [My Oracle Support](#) and then search for Doc ID [2462012.1](#). Download `opwdintg.exe` from this location. This version is the latest version.
 - **If you do not have a My Oracle Support account:** Register for a My Oracle Support account so that you can download the latest version of `opwdintg.exe` from Doc ID [2462012.1](#).
2. Using a secure method of copying (such as `sftp`), copy `opwdintg.exe` to a temporary directory (for example, `C:\temp`) on each Windows domain controller.
 3. Connect to each Windows domain controller as the Active Directory administrator. Currently, the `opwdintg.exe` utility requires English for the Windows OS.
 4. Ensure that the Windows OS language setting is English.
 5. Run the `opwdintg.exe` utility on each Windows domain controller.

If you reinstall an updated password filter using a newer `opwdintg.exe`, then you must restart the domain controller.

Use one of the following methods to run the `opwdintg.exe` utility:

- Open the Windows Explorer and then double click the `opwdintg.exe` utility.
- Open a Windows command prompt and then follow these steps:
 - a. Navigate to the directory where the `opwdintg.exe` utility is located. For example:

```
cd c:\temp
```

- b. Run the utility from the command line by typing the following command:

```
.\opwdintg.exe
```

6. Answer the following prompts:
 - **Do you want to extend AD schema? [Yes/No]:** Enter `Yes`.
Extending the Active Directory schema requires the Windows OS language setting to be English.
 - **Schema extension for this domain will be permanent. Continue? [Yes/No]:** Enter `Yes`.
Note the following:
 - You can only extend the Active Directory schema one time. If you try to extend the schema again, error messages appear, but you can ignore these errors.
 - This step creates the following three verifier groups. If these groups already exist, then errors will appear, but you can ignore these errors. These verifier groups can be moved from the installed AD Users folder or outside this folder structure for user objects.
 - * `ORA_VFR_MD5` is required when the Oracle Database WebDAV client is used.
 - * `ORA_VFR_11G` enables the use of the Oracle Database 11G password verifier.
 - * `ORA_VFR_12C` enables the use of the Oracle Database 12C password verifier.
 - Unless you have backed up the Active Directory schema, once extended, the Active Directory schema extension cannot be reverted.

The next two prompts depend on whether the password filter has been installed already.

- **Found password filter installed already. Do you want to deinstall? [Yes/No]:** This prompt appears if the password filter has already been installed. In most cases, enter `No` to not deinstall the filter.
If you enter `Yes` to deinstall the password filter, then you must re-run `opwdintg.exe` to re-install the password filter after you complete these prompts. Otherwise, after you restart the computer, the password verifiers will no longer be generated when Active Directory users change their passwords.
- **Do you want to install Oracle password filter? [Yes/No]:** This prompt appears if the password filter has not been installed yet. Enter `Yes`.
- **The change requires machine reboot. Do you want to reboot now? [Yes/No]:**
Enter `Yes`.

6.2.2.3 Step 3: If Necessary, Install the Oracle Database Software

If you have not done so yet, then use Oracle Universal Installer (OUI) to install the Oracle software.

You only need to install the Oracle Database software, not the full database. After you install the Oracle database software, you can configure centrally managed users with Active Directory during database creation by using Database Configuration Assistant (DBCA). You can also configure centrally managed users with Active Directory using DBCA or manually after database creation.

- Follow the instructions in the *Oracle Database Installation Guide* for your platform to install the Oracle software.

After you install the Oracle database software, then you can configure centrally managed users with Active Directory during database creation using DBCA. You can also configure centrally managed users with Active Directory using DBCA or manually after the database creation.

6.2.2.4 Step 4: Create the `dsi.ora` or `ldap.ora` File

The `dsi.ora` and `ldap.ora` files specify connections for centrally managed users for Active Directory.

- [Comparison of the `dsi.ora` and `ldap.ora` Files](#)
How you use the `dsi.ora` and `ldap.ora` depends on how `ldap.ora` is used with other services.
- [About Using a `dsi.ora` File](#)
You use a `dsi.ora` file to specify Active Directory servers for centrally managed users.
- [Creating the `dsi.ora` File](#)
The `dsi.ora` configuration file sets the information to find the Active Directory servers for centrally managed users.
- [About Using an `ldap.ora` File](#)
You can use an `ldap.ora` file to specify Active Directory servers for centrally managed users.
- [Creating the `ldap.ora` File](#)
These steps assume that `ldap.ora` is not being used for net naming services and can be used to set up the connection with Active Directory for centrally managed users.

6.2.2.4.1 Comparison of the `dsi.ora` and `ldap.ora` Files

How you use the `dsi.ora` and `ldap.ora` depends on how `ldap.ora` is used with other services.

The `dsi.ora` file specifies connections for centrally managed users for Active Directory. The `ldap.ora` file can also specify the connection to the Active Directory server. However, because each individual PDB cannot have its own `ldap.ora`, and also `ldap.ora` may already be used (or may be used in the future) for other services like net naming services, Oracle recommends the use of `dsi.ora` for centrally managed users.

If all the containers in the CDB (CDB root, application root, application PDB) connect to the same Active Directory server, then you can use a single set of `dsi.ora` and wallet files and use directory objects to point to that location from every container that needs to connect to the Active Directory server. This way, you do not need to maintain multiple sets of the same `dsi.ora` and wallet files. An `ldap.ora` file can also be used to connect all the containers to a single Active Directory server, because each container looks for the `ldap.ora` in the common locations when `dsi.ora` is not present. However, each container looks for the wallet only in container-specific locations.

6.2.2.4.2 About Using a `dsi.ora` File

You use a `dsi.ora` file to specify Active Directory servers for centrally managed users.

You must manually create the `dsi.ora` file to identify the Active Directory servers. The `dsi.ora` file provides Active Directory connection information for all pluggable databases if it is located in the same places where the `ldap.ora` file can be placed. A `dsi.ora` file in a PDB-specific wallet location takes precedence over the main `dsi.ora` file for that PDB only.

Note:

If you are using `ldap.ora` for naming services, then do not make any changes to `ldap.ora` for the CMU with Active Directory configuration. Only use `dsi.ora` to configure CMU-Active Directory.

Placement of `dsi.ora`

Oracle recommends that you use directories for writable files under `$ORACLE_BASE`, not under `$ORACLE_HOME`. Starting with Oracle Database 18c, you can optionally set the `$ORACLE_HOME` directory to be read-only. Hence, you should place the `dsi.ora` file in a directory that is outside of `$ORACLE_HOME` to accommodate the `dsi.ora` configuration for future releases.

Search Order for `dsi.ora`

When you create the `dsi.ora` file, Oracle Database searches for it in the following order:

1. For a PDB, if the database property `CMU_WALLET` is set to a directory object, then Oracle Database searches for it in the location path specified by this directory object.
2. If the `WALLET_LOCATION` setting is included in the `sqlnet.ora` file, then for the root container, Oracle searches for it in the location that is specified in `sqlnet.ora`. For a PDB, Oracle searches for it in the per-PDB wallet location that is in the `WALLET_LOCATION_specified_in_sqlnet.ora/pdb_guid` directory. The parameter `WALLET_LOCATION` is deprecated for use with Oracle Database 23ai for the Oracle Database server. It is not deprecated for use with the Oracle Database client.
3. If the `WALLET_LOCATION` setting is not included in the `sqlnet.ora` file, then Oracle Database searches for it in the default wallet location.

4. If Oracle Database cannot find `dsi.ora` in the wallet location, then Oracle Database searches for it in the following order. These are the same locations that Oracle Database searches for the `ldap.ora` file.
 - a. `$LDAP_ADMIN` environment variable setting
 - b. `$ORACLE_HOME/ldap/admin` directory
 - c. `$TNS_ADMIN` environment variable setting
 - d. `$ORACLE_HOME/network/admin` directory

When to Use `dsi.ora`

Oracle recommends that you use only `dsi.ora` to identify the Active Directory servers for centrally managed users. If both `dsi.ora` and `ldap.ora` are configured in the same database for centrally managed users for Active Directory and are both located in the same directory, then `dsi.ora` takes precedence over the `ldap.ora` file. If they are in different directories, then Oracle uses the first one that it finds in the location precedence list above to find the Active Directory server. If the directory server type in the first found `dsi.ora` or `ldap.ora` is not Active Directory, then centrally managed users will **not** be enabled.

Using `dsi.ora` in a Multitenant Environment

When you set the per-PDB `CMU_WALLET` database property to a directory object, then the `dsi.ora` file for an individual PDB will be in the wallet location that is specified by this per-PDB database property. (You set `CMU_WALLET` in individual PDBs, and you can also set `CMU_WALLET` in the CDB root. However, setting `CMU_WALLET` in the CDB root will only be effective for the root container, not for the entire CDB.) The `CMU_WALLET` property takes precedence over the `WALLET_LOCATION` setting.

If the `CMU_WALLET` database property is not set, and if the `WALLET_LOCATION` parameter in the `sqlnet.ora` file is set, then the `dsi.ora` file for an individual PDB will be in the per-PDB wallet in the `WALLET_LOCATION_specified_in_sqlnet.ora/pdb_guid/` directory.

If neither the `CMU_WALLET` database property nor the `WALLET_LOCATION` parameter in the `sqlnet.ora` file is set, then the default wallet location for an individual container is the `$ORACLE_BASE/admin/db_unique_name/pdb_guid/wallet/` directory. For each PDB to use the default wallet location, you must not set the `CMU_WALLET` database property, and must not set `WALLET_LOCATION` in `sqlnet.ora`.

To find the `db_unique_name`, connect to the CDB root and run the following query:

```
SELECT DB_UNIQUE_NAME FROM V$DATABASE;
```

To find the `pdb_guid`, from the CDB root, run the following query:

```
SELECT PDB_NAME,GUID FROM DBA_PDBS;
```

How the `CMU_WALLET` Database Property Affects the `dsi.ora` File

When you set the `CMU_WALLET` database property to a directory object, then the `dsi.ora` file for an individual PDB will be in the wallet location that is specified by this per-PDB database property. Note that the database property is only effective if the PDB is open. This implies that an Active Directory user with administrative privileges will not be able to start an idle PDB based on the configuration specified by the `CMU_WALLET` database property, because looking up the database property and associated directory object is dependent on the PDB being open.

For example, suppose you want to set the wallet location using `CMU_WALLET`. If the `PATH_PREFIX` clause was not specified when a PDB was created, then you must create a directory object

using an absolute path and then set the `CMU_WALLET` database property on the PDB. For example:

```
CREATE OR REPLACE DIRECTORY example_dir AS '/u01/app/oracle/pdb1/cmu/wallet';
ALTER DATABASE PROPERTY SET CMU_WALLET='EXAMPLE_DIR';
```

This enables Oracle Database to search the `dsi.ora` file in the wallet location that was specified by the directory path `/u01/app/oracle/pdb1/cmu/wallet/`.

If the `PATH_PREFIX` clause was specified when the PDB was created, then you must create a directory object using a relative path and set the `CMU_WALLET` database property on the PDB. For example:

```
CREATE OR REPLACE DIRECTORY example_dir AS 'cmu/wallet';
ALTER DATABASE PROPERTY SET CMU_WALLET='EXAMPLE_DIR';
```

Note that if the directory object name (`example_dir`) is not double quoted, then it is case insensitive in the `CREATE OR REPLACE DIRECTORY` statement and can be in lower case. However, the corresponding directory object name must be in upper case when it is used in the `ALTER DATABASE PROPERTY SET CMU_WALLET` statement.

To look up the wallet location that is set by the database property `CMU_WALLET`, run the following SQL statement:

```
SELECT DIRECTORY_PATH FROM DBA_DIRECTORIES WHERE DIRECTORY_NAME = (SELECT PROPERTY_VALUE
FROM DATABASE_PROPERTIES WHERE PROPERTY_NAME='CMU_WALLET');
```

To unset the wallet location specified by the database property `CMU_WALLET`, run the following statement:

```
ALTER DATABASE PROPERTY REMOVE CMU_WALLET;
```

How the `WALLET_LOCATION` Parameter in `sqlnet.ora` Affects `dsi.ora`

Setting or not setting the `WALLET_LOCATION` parameter in `sqlnet.ora` has the following effects:

- If `WALLET_LOCATION` is not set in `sqlnet.ora`, then you can also place `dsi.ora` in the default wallet directory for the CDB root container, located in the `$ORACLE_BASE/admin/db_unique_name/wallet` directory. However, this will only connect the CDB root container to the Active Directory, not the entire CDB database.
- If `WALLET_LOCATION` is set in `sqlnet.ora`, then you can place the `dsi.ora` in that wallet location, and this will also only connect the CDB root container to the Active Directory, not the entire CDB database.

Modifications to the `dsi.ora` File

Changes to the `dsi.ora` file take effect immediately and do not require you to restart the database. Changes to the wallet also take effect immediately.

6.2.2.4.3 Creating the `dsi.ora` File

The `dsi.ora` configuration file sets the information to find the Active Directory servers for centrally managed users.

To use the `dsi.ora` configuration file:

1. Log in to the host where the Oracle database is located.

2. Choose a directory where to use the `dsi.ora` file, based on the search order for the `dsi.ora` file. (See Related Topics.) If this directory does not exist, then create the directory. Then go to this directory to create the `dsi.ora` file.
3. Add the following parameters to the `dsi.ora` file:

- `DSI_DIRECTORY_SERVERS`, which sets the Active Directory server host and port number, and alternate directory servers. The directory server name must be a fully qualified name. You can also have multiple Active Directory servers here if you want to use multiple Windows domains. For example:

```
DSI_DIRECTORY_SERVERS = (AD-server.production.examplecorp.com:389:636,  
sparky.production.examplecorp.com:389:636)
```

Active Directory domain servers in a high availability and failover configuration can be configured with CMU. You can configure high availability and failover Active Directory domain servers by one of the following methods:

- Using a load balancer in front of the Active Directory domain servers
- Listing each Active Directory domain server by host name or IP address in a list
- Using a domain name that returns a different Active Directory domain server

Using a load balancer is the preferred choice, especially if you already use one for the Active Directory domain servers. The load balancer enables you to manage and add or subtract Active Directory domain servers behind the load balancer without having to make any changes to the `dsi.ora` file. Specifying a list of Active Directory domain servers is quicker and less expensive, but it ties you to the Active Directory domain servers so changes (new or dropped servers) must be reflected in `dsi.ora`. Using a domain name offers some high availability and failover, but it is not an ideal solution. The DNS will need to return different servers instead of the same server every time. CMU will try the first returned server from a domain name look-up and if that fails, then the authentication will fail. However, using domain names gives you some ability to use different Active Directory domain servers without having to specify the list of servers in `dsi.ora`.

- `DSI_DEFAULT_ADMIN_CONTEXT`, which sets the search base where the Active Directory users and groups are located. **This parameter is optional.** By default, Oracle locates Active Directory users and groups in Active Directory's default naming context. Oracle recommends that you do not set this parameter. Set this parameter only if you want to limit the search scope for Active Directory users and groups. For example:

```
DSI_DEFAULT_ADMIN_CONTEXT =  
"OU=sales,DC=production,DC=examplecorp,DC=com"
```

- `DSI_DIRECTORY_SERVER_TYPE`, which determines the Active Directory server access. You must set it to `AD` for Active Directory. Enter this value in upper case.

```
DSI_DIRECTORY_SERVER_TYPE = AD
```

Related Topics

- [About Using a `dsi.ora` File](#)
You use a `dsi.ora` file to specify Active Directory servers for centrally managed users.

6.2.2.4.4 About Using an ldap.ora File

You can use an `ldap.ora` file to specify Active Directory servers for centrally managed users.

If you are already using an `ldap.ora` file for another purpose such as net naming services, then you must use the `dsi.ora` file to configure centrally managed users to connect with Active Directory for user authentication and authorization. Even if Active Directory is already being used for net naming services, then you must create and use a `dsi.ora` file to identify the Active Directory servers for centrally managed users. Even if the database currently is not using `ldap.ora` for another service, Oracle recommends using `dsi.ora` in case `ldap.ora` will be used at a future time for net naming services.

If `ldap.ora` is being used for naming services, then do not make any changes to `ldap.ora`. Only use `dsi.ora` to configure CMU-Active Directory.

Benefit of Using ldap.ora

The benefit of using `ldap.ora` is that you can use the DBCA graphical interface or the DBCA silent mode to complete configuring the connection to the Active Directory servers. When using `dsi.ora`, the steps to complete configuring the connection to Active Directory must be done separately.

Placement of ldap.ora

Typically, the `ldap.ora` file is stored in the `$ORACLE_HOME/network/admin` directory. Usually, the `ldap.ora` file cannot be in the same directory as the `WALLET_LOCATION` that is specified in the `sqlnet.ora` file, unless the `WALLET_LOCATION` is set to `$ORACLE_HOME/network/admin`.

 **Note:**

The parameter `WALLET_LOCATION` is deprecated for use with Oracle Database 23ai for the Oracle Database server. It is not deprecated for use with the Oracle Database client or listener.

For Oracle Database server, Oracle recommends that you use the `WALLET_ROOT` system parameter instead of using `WALLET_LOCATION`.

Search Order for ldap.ora

After you create the `ldap.ora` file, Oracle Database searches for it in the following order:

1. `$LDAP_ADMIN` environment variable setting
2. `$ORACLE_HOME/ldap/admin` directory
3. `$TNS_ADMIN` environment variable setting
4. `$ORACLE_HOME/network/admin` directory

Changing the Contents of ldap.ora

If you change the contents of `ldap.ora` after the database has been started, then you must either restart the database instance or re-run the following DDL to make the updated content in `ldap.ora` effective:

```
ALTER SYSTEM SET LDAP_DIRECTORY_ACCESS = 'PASSWORD';
```

You should set the `LDAP_DIRECTORY_ACCESS` parameter in each PDB, not in the CDB root.

6.2.2.4.5 Creating the `ldap.ora` File

These steps assume that `ldap.ora` is not being used for net naming services and can be used to set up the connection with Active Directory for centrally managed users.

1. Log in to the host where the Oracle database is located.
2. Choose a directory where to use the `ldap.ora` file, based on the search order for the `ldap.ora` file. (See [Related Topics](#).) If this directory does not exist, then create the directory. Then go to this directory to create the `ldap.ora` file.

3. If the `ldap.ora` file does not exist, then create it by using a text editor.

If the `ldap.ora` file does exist, create a backup of this file, and then open `ldap.ora`.

4. Add the following parameters to the `ldap.ora` file:

- `DIRECTORY_SERVERS`, which sets the Active Directory server host and port number, and alternate directory servers. You can also have multiple Active Directory servers here if you want to use multiple Windows domains. The directory server name must be a fully qualified name. For example:

```
DIRECTORY_SERVERS = (AD-server.production.examplecorp.com:389:636,  
sparky.production.examplecorp.com:389:636)
```

- `DEFAULT_ADMIN_CONTEXT`, which sets the search base where the Active Directory users and groups are located. **This parameter is optional.** By default, Oracle locates Active Directory users and groups in the Active Directory's default naming context. Oracle recommends that you do not set this parameter. Set this parameter only if you want to limit the search scope for Active Directory users and groups. For example:

```
DEFAULT_ADMIN_CONTEXT = "OU=sales,DC=production,DC=examplecorp,DC=com"
```

- `DIRECTORY_SERVER_TYPE`, which determines the LDAP server access. You must set it to `AD` for Active Directory. Enter this value in upper case.

```
DIRECTORY_SERVER_TYPE = AD
```

Related Topics

- [About Using an `ldap.ora` File](#)

You can use an `ldap.ora` file to specify Active Directory servers for centrally managed users.

6.2.2.5 Step 5: Request an Active Directory Certificate for a Secure Connection

After you have configured the `dsi.ora` or `ldap.ora` file, you are ready to prepare Microsoft Active Directory and Oracle Database certificates for a secure connection.

- Request the Active Directory certificate from an Active Directory administrator.

Related Topics

- [Management of Certificate Revocation Lists \(CRLs\) with `orapki` Utility](#)

You must manage certificate revocation lists (CRLs) with the `orapki` utility.

6.2.2.6 Step 6: Create the Wallet for a Secure Connection

After you have copied the Active Directory certificate, you are ready to add it to the Oracle wallet.

1. Copy the certificate text file (for example, `AD_CA_Root_cert.txt`) from the Active Directory server to a temporary directory (for example, `/tmp`) on the local host.

The Active Directory certificate can be in either text (BASE64) or binary (DER) format. For additional information on retrieving the certificate from the Active Directory domain server (and configuring the Active Directory domain server), see the My Oracle Support note entitled "How to Configure Centrally Managed Users For Database Release 18c or Later Releases" (Doc ID [2462012.1](#)).

If the wallet location is neither specified by the `CMU_WALLET` database property, nor specified in the `sqlnet.ora` file, then the database will search the following locations in this order for the wallet. The directory location may need to be created.

For the CDB root container:

- a. `$ORACLE_BASE/admin/db_unique_name/wallet/`
- b. `$ORACLE_HOME/admin/db_unique_name/wallet/`

For a PDB:

- a. `$ORACLE_BASE/admin/db_unique_name/pdb_guid/wallet/`
- b. `$ORACLE_HOME/admin/db_unique_name/pdb_guid/wallet/`

Oracle recommends that for each individual container, you place the wallet files in the default wallet location under `$ORACLE_BASE`, that is, in the `$ORACLE_BASE/admin/db_unique_name/pdb_guid/wallet/` directory.

To find the `db_unique_name`, connect to the CDB root and run the following query:

```
SELECT DB_UNIQUE_NAME FROM V$DATABASE;
```

To find the `pdb_guid`, from the CDB root, run the following query:

```
SELECT PDB_NAME,GUID FROM DBA_PDBS;
```

If you are using the `CMU_WALLET` database property to specify the wallet location, then the wallet location specified is for an individual PDB.

If you are using `sqlnet.ora` to specify the wallet location, then the wallet location specified is for the root container. For each PDB, its wallet is located at `WALLET_LOCATION_specified_in_sqlnet.ora/pdb_guid`. You can also place an individual PDB `dsi.ora` in `WALLET_LOCATION_specified_in_sqlnet.ora/pdb_guid`.

Note:

The parameter `WALLET_LOCATION` is deprecated for use with Oracle Database 23ai for the Oracle Database server. It is not deprecated for use with the Oracle Database client or listener. For Oracle Database server, Oracle recommends that you use the `WALLET_ROOT` system parameter instead of using `WALLET_LOCATION`.

2. Create a new wallet.

The following command creates an auto-login wallet in the specified path.

```
orapki wallet create -wallet wallet_location -auto_login
Enter password: password
Enter password again: password
```

3. Create an entry in wallet with the user name of the Oracle service directory user account for performing searches in Active Directory (created in the first step).

For example:

```
mkstore -wrl wallet_location -createEntry ORACLE.SECURITY.USERNAME oracle
```

Starting in Oracle Database 23ai, `mkstore` is deprecated in favor of `orapki`.

4. Create an entry in wallet with the DN of the Oracle service directory user account.

For example:

```
mkstore -wrl wallet_location -createEntry ORACLE.SECURITY.DN
cn=oracle,cn=users,dc=production,dc=examplecorp,dc=com
```

In this example, the DN indicates that the DNS domain is `production.examplecorp.com`. The Windows domain name is just `production`.

5. Create an entry in wallet with the user password credential of the Oracle service directory user account.

For example:

```
mkstore -wrl wallet_location -createEntry ORACLE.SECURITY.PASSWORD password
```

6. Add the certificate to the wallet. Use the Active Directory certificate that you received from the Active Directory administrator.

For example:

```
orapki wallet add -wallet wallet_location -cert /tmp/AD_CA_Root_cert.txt -
trusted_cert
```

If `WALLET_LOCATION` is specified in `sqlnet.ora`, then you must add Active Directory certificates to the PDB specific wallet location (that is, `WALLET_LOCATION_specified_in_sqlnet.ora/pdb_guid`, for each individual PDB). You can also add the Active Directory certificate to the `WALLET_LOCATION_specified_in_sqlnet.ora`. However, it will only be effective for the root container, not for the entire CDB.

7. Verify the credentials.

For example:

```
orapki wallet display -wallet wallet_location
```

The output should be similar to the following:

```
Requested Certificates:
User Certificates:
Oracle Secret Store entries:
ORACLE.SECURITY.DN
ORACLE.SECURITY.PASSWORD
ORACLE.SECURITY.USERNAME
Trusted Certificates:
Subject: CN=ADSVR,DC=production,DC=examplecorp,DC=com
```

Changes to the wallet take effect immediately and do not require a database restart.

6.2.2.7 Step 7: Configure the Microsoft Active Directory Connection

Next, you are ready to connect the database to Active Directory using the settings you have so far.

- [About Configuring the Microsoft Active Directory Connection](#)
To configure the Microsoft Active Directory connection, you can set the parameters in the database or use DBCA.
- [Configuring the Access Manually Using Database System Parameters](#)
You can configure the Active Directory services connection manually by using LDAP-specific Oracle Database system parameters.
- [Configuring the Access Using the Database Configuration Assistant GUI](#)
Oracle Database Configuration Assistant (DBCA) completes the LDAP connection configuration and automatically creates the wallet and stores the Active Directory certificate for use. DBCA only works when `ldap.ora` is configured for CMU-Active Directory.
- [Configuring the Access Using Database Configuration Assistant Silent Mode](#)
Assuming `ldap.ora` (not `dsi.ora`) has been created in the correct location and configured properly, DBCA silent mode can create a new database or alter an existing database for the Microsoft Active Directory-Oracle Database integration.

6.2.2.7.1 About Configuring the Microsoft Active Directory Connection

To configure the Microsoft Active Directory connection, you can set the parameters in the database or use DBCA.

DBCA only recognizes the `ldap.ora` that is configured for centrally managed users, and only creates the wallet in the recommended default location. To use the default wallet locations, you must not set the `CMU_WALLET` database property for a PDB, and you must not set `WALLET_LOCATION` in `sqlnet.ora`.



Note:

Oracle recommends using `dsi.ora` for CMU-Active Directory.

The parameter `WALLET_LOCATION` is deprecated for use with Oracle Database 23ai for the Oracle Database server. It is not deprecated for use with the Oracle Database client or listener.

Related Topics

- [Configuring the Access Manually Using Database System Parameters](#)
You can configure the Active Directory services connection manually by using LDAP-specific Oracle Database system parameters.

6.2.2.7.2 Configuring the Access Manually Using Database System Parameters

You can configure the Active Directory services connection manually by using LDAP-specific Oracle Database system parameters.

1. Ensure that you have created the `dsi.ora` file or the `ldap.ora` file, and that you have created the wallet.

2. Log in to the appropriate PDB as a user who has the `ALTER SYSTEM` system privilege.

For example:

```
sqlplus sec_admin@pdb_name
Enter password: password
```

To find the available PDBs in a CDB, log in to the CDB root container and then query the `PDB_NAME` column of the `DBA_PDBS` data dictionary view. To check the current container, run the `show con_name` command.

3. Modify the `LDAP_DIRECTORY_ACCESS` parameter, which determines the type of LDAP directory access.

Set `LDAP_DIRECTORY_ACCESS` in each PDB, not in the CDB root. Setting this parameter in the CDB root will apply it only to the root, not to the PDBs.

Valid values are `PASSWORD` and `NONE` (to disable the connection). `PASSWORD` requires an Active Directory server certificate and when you create the wallet, you must include the credentials for the Active Directory service user account for Oracle.

For example:

```
ALTER SYSTEM SET LDAP_DIRECTORY_ACCESS = 'PASSWORD';
```

You can also set this parameter in the `spfile` or in the `init.ora` file (if the `init.ora` file is used). Afterward, restart the database.

4. Set the `LDAP_DIRECTORY_SYSAUTH` parameter to `YES`, so that administrative users from Active Directory can log in to Oracle Database with the `SYSDBA`, `SYSOPER`, `SYSBACKUP`, `SYSDBG`, `SYSKM`, or `SYSRAC` administrative privilege.

Set `LDAP_DIRECTORY_SYSAUTH` in each PDB, not in the CDB root. Setting this parameter in the CDB root will apply it only to the root, not to the PDBs.

If you set this parameter to `NO`, then centrally managed users from Active Directory cannot log in to Oracle database with these privileges.

```
ALTER SYSTEM SET LDAP_DIRECTORY_SYSAUTH = YES SCOPE=SPFILE ;
```

You can also set this parameter in the `spfile` or in the `init.ora` file (if the `init.ora` file is used). Afterward, restart the database.

5. Connect to the root as a user with the `SYSDBA` administrative privilege.
6. Close and then re-open the PDB.

```
ALTER PLUGGABLE DATABASE pdb_name CLOSE IMMEDIATE;
ALTER PLUGGABLE DATABASE pdb_name OPEN;
```

After you re-open the PDB, you can log in to the PDB with the `SYSDBA` administrative privilege and check the LDAP parameters settings as follows:

```
show parameter ldap
```

6.2.2.7.3 Configuring the Access Using the Database Configuration Assistant GUI

Oracle Database Configuration Assistant (DBCA) completes the LDAP connection configuration and automatically creates the wallet and stores the Active Directory certificate for use. DBCA only works when `ldap.ora` is configured for CMU-Active Directory.

These instructions assume that you have already installed the Oracle software and that you are using an `ldap.ora` file (not `dsi.ora`) to identify the Active Directory servers for the centrally managed users. If you have not installed the database software yet, then you can install the

software using Oracle Universal Installer (OUI). After that, use DBCA to create the database, and at the same time you can configure the connection for Active Directory centrally managed users.

1. Log in to the host where the Oracle database software is installed as a user who has administrative privileges.

2. Start DBCA.

By default, the DBCA utility is located in the `$ORACLE_HOME/bin` directory.

For example:

```
cd $ORACLE_HOME/bin
./dbca
```

3. Select the Network Configuration option (or when you get to the Network Configuration option when creating the database).

The Specify Network Configuration Details window appears. If the Directory Service Integration area is not visible, then the `ldap.ora` file was not configured correctly. Check the `ldap.ora` configuration that you did earlier, and after you have corrected the file, rerun DBCA.

4. In the Directory Service Integration area, do the following:

- In the **Service username** field, enter the name of the Oracle service directory user account.
- In the **Password** field, enter the password of the Oracle service directory user account.
- In the **Service user DN** field, enter the DN for the Oracle service directory user account. The DN can be retrieved directly from the Active Directory server or from an Active Directory system administrator.
- For **Access Type**, select the type of authentication from the list (for example, **PASSWORD**). (This setting sets the `LDAP_DIRECTORY_ACCESS` parameter.) If necessary, select the **Allow admin privileges authentication** checkbox, which allows Active Directory users to authenticate and use database schemas with administrative privileges (for example, `SYSDBA`, `SYSOPER`, `SYSBACKUP`, and so on). Otherwise, centrally managed users from Active Directory cannot log in to the database with administrative privileges. (This setting corresponds to the `LDAP_DIRECTORY_SYSAUTH` parameter.)
- Provide the path to the Active Directory certificate in the **Certificate file location** field. In a multitenant environment, DBCA recognizes and sets up Active Directory connections for the database instance connection. You must manually configure PDB connections if you want to connect a different Active Directory server to a PDB.
- In the **Wallet password** and **Confirm password** fields, enter and confirm the password for the Oracle wallet that will store the certificate and credential of the Oracle service directory user account. Afterward, DBCA automatically validates the service directory user account, creates the wallet, stores the user credential, and imports the certificate.

5. Click **Next** until you reach the Finish page.

6. Click **Finish**.

Related Topics

- [Step 4: Create the dsi.ora or ldap.ora File](#)
The `dsi.ora` and `ldap.ora` files specify connections for centrally managed users for Active Directory.

- [Configuring the Access Using Database Configuration Assistant Silent Mode](#)
Assuming `ldap.ora` (not `dsi.ora`) has been created in the correct location and configured properly, DBCA silent mode can create a new database or alter an existing database for the Microsoft Active Directory-Oracle Database integration.

6.2.2.7.4 Configuring the Access Using Database Configuration Assistant Silent Mode

Assuming `ldap.ora` (not `dsi.ora`) has been created in the correct location and configured properly, DBCA silent mode can create a new database or alter an existing database for the Microsoft Active Directory-Oracle Database integration.

1. Log in to the host that will have the Oracle database to be used for the integration.
2. Make sure `ldap.ora` is created with the correct content in a correct location.
3. Make sure that the `WALLET_LOCATION` parameter is not specified in the `sqlnet.ora` file.

The parameter `WALLET_LOCATION` is deprecated for use with Oracle Database 23ai for the Oracle Database server. It is not deprecated for use with the Oracle Database client.

4. Run Database Configuration Assistant (DBCA) in silent mode.

To configure the root container of a CDB:

```
cd $ORACLE_HOME/bin

./dbca -silent -configureDatabase -sourceDB db_name
-registerWithDirService true
-dirServiceUser oracle
-dirServiceUserName cn=oracle,cn=users,dc=production,dc=examplecorp,dc=com
-dirServicePassword service_user_password
-ldapDirectoryAccessType PASSWORD
-useSYSAuthForLDAPAccess true
-dirServiceCertificatePath /tmp/AD_CA_Root_cert.txt
-walletPassword wallet_password
```

To configure a pluggable database in a CDB:

```
cd $ORACLE_HOME/bin

./dbca -silent -configurePluggableDatabase -pdbName pdb_name -sourceDB db_name
-registerWithDirService true
-dirServiceUser oracle
-dirServiceUserName cn=oracle,cn=users,dc=production,dc=examplecorp,dc=com
-dirServicePassword service_user_password
-dirServiceCertificatePath /tmp/AD_CA_Root_cert.txt
-walletPassword wallet_password
```

Related Topics

- [About Using an ldap.ora File](#)
You can use an `ldap.ora` file to specify Active Directory servers for centrally managed users.

6.2.2.8 Step 8: Verify the Oracle Wallet

The `orapki` utility can verify that the wallet for this database was created successfully.

1. Log in to the host where a database is used in the integration.
2. Go to the directory that contains the wallet.

If neither the `CMU_WALLET` database property is set for a PDB, nor `WALLET_LOCATION` is set in `sqlnet.ora`, then the default wallet locations are the following:

- For the CDB root, the wallet location is the wallet location is the `$ORACLE_BASE/admin/db_unique_name/wallet/` directory.
- For a PDB, the wallet location is the `$ORACLE_BASE/admin/db_unique_name/pdb_guid/wallet/` directory.

3. At the command line, enter the following commands:

```
ls -ltr wallet_location (to check that the wallet directory contains wallet files)
```

For example:

```
$ ls -ltr $ORACLE_BASE/admin/db_unique_name/pdb_guid/wallet/
total 12
-rw----- 1 creator_user creator_group 1597 Nov 27 22:47 cwallet.sso
-rw----- 1 creator_user creator_group 1552 Nov 27 22:47 ewallet.pl2
-rw-rw-r-- 1 creator_user creator_group 86 Nov 27 22:48 dsi.ora
```

```
orapki wallet display -wallet wallet_location (to find the Oracle Secret Store entries)
```

The output should contain the following entries:

```
Requested Certificates:
User Certificates:
Oracle Secret Store entries:
ORACLE.SECURITY.DN
ORACLE.SECURITY.PASSWORD
ORACLE.SECURITY.USERNAME
Trusted Certificates:
Subject: CN=ADSVR,DC=production,DC=examplecorp,DC=com
```

6.2.2.9 Step 9: Test the Integration

To test the integration, you must set the `ORACLE_HOME`, `ORACLE_BASE`, and `ORACLE_SID` environment variables and then verify the LDAP parameter settings.

1. Log in to the host where a database is used for the integration.
2. Set the `ORACLE_HOME`, `ORACLE_BASE`, and `ORACLE_SID` environment variables.

For example:

```
export ORACLE_HOME=/app/product/18.1/dbhome_1
export ORACLE_BASE=/app
export ORACLE_SID=sales_db
```

3. Log in to the PDB as a user who has the `SYSDBA` administrative privilege.

For example:

```
sqlplus sec_admin@pdb_name as sysdba
Enter password: password
```

To find the available PDBs in a CDB, log in to the CDB root container and then query the `PDB_NAME` column of the `DBA_PDBS` data dictionary view. To check the current container, run the `show con_name` command.

4. Check the LDAP parameter settings:

```
show parameter ldap
```

The output should be similar to the following:

NAME	TYPE	VALUE
ldap_directory_access	string	PASSWORD
ldap_directory_sysauth	string	YES

6.3 Configuring Authentication for Centrally Managed Users

You can configure password authentication, Kerberos authentication, or public key infrastructure (PKI) authentication.

- [Configuring Password Authentication for Centrally Managed Users](#)
Configuring password authentication for centrally managed users entails the use of a password filter with Active Directory to generate and store Oracle Database password verifiers on Active Directory.
- [Configuring Proxy Authentication for Centrally Managed Users](#)
Proxy authentication enables a centrally managed user to proxy to a database schema for tasks such as application maintenance.
- [Configuring Kerberos Authentication for Centrally Managed Users](#)
If you plan to use Kerberos authentication, then you must configure Kerberos in the Oracle database that will be integrated with Microsoft Active Directory.
- [Configuring Authentication Using PKI Certificates for Centrally Managed Users](#)
If you plan to use PKI certificates for the authentication of centrally managed users, then you must configure Transport Layer Security in the Oracle database that will be integrated with Microsoft Active Directory.

6.3.1 Configuring Password Authentication for Centrally Managed Users

Configuring password authentication for centrally managed users entails the use of a password filter with Active Directory to generate and store Oracle Database password verifiers on Active Directory.

- [About Configuring Password Authentication for Centrally Managed Users](#)
To configure password authentication, you must deploy a password filter, extend the Active Directory schema by adding one user attribute, and create groups for generating different versions of password verifiers on Active Directory.
- [Configuring Password Authentication for a Centrally Managed User](#)
You must perform password authentication configuration on Active Directory servers, and also on Oracle databases if it is required that Active Directory users will log in to Oracle databases with administrative privileges.
- [Logging in to an Oracle Database Using Password Authentication](#)
For password authentication, centrally managed users have choices of how to log in to the database.

6.3.1.1 About Configuring Password Authentication for Centrally Managed Users

To configure password authentication, you must deploy a password filter, extend the Active Directory schema by adding one user attribute, and create groups for generating different versions of password verifiers on Active Directory.

For Active Directory users to log in Oracle database with administrative privileges, you must also set a password file with Oracle database.

For password authentication, because Oracle Database does not pass Active Directory users' passwords through the `ldapbind` command to authenticate with Active Directory, you must install an Oracle filter and extend the Active Directory schema. The Oracle filter that you install in Active Directory creates Oracle-specific password verifiers when Active Directory users update their passwords. The Oracle filter does not generate all required Oracle password verifiers when it is first installed; the Oracle filter only generates the Oracle password verifier for a user when the user changes their Active Directory password.

To maintain backward compatibility (if your site requires it), the Oracle filter can generate password verifiers to work with Oracle Database clients for releases 11g, 12c, and 18c. The Oracle password filter uses Active Directory groups named `ORA_VFR_MD5` (for WebDAV), `ORA_VFR_11G` (for release 11g) and `ORA_VFR_12C` (for releases 12c and 18c) to determine which Oracle Database password verifiers to generate. These groups must be created in Active Directory for the Oracle password verifiers to be generated for group member users. These are separate groups that dictate which specific verifiers should be generated for the Active Directory users. For example, if ten directory users need to log in to a newly created Oracle Database release 18c database that only communicated with Oracle Database release 18c and 12c clients, then an Active Directory group `ORA_VFR_12C` will have ten Active Directory users as members. The Oracle filter will only generate 12c verifiers for these ten Active Directory users when they change passwords with Active Directory (18c verifiers are the same as 12c verifiers). If an Active Directory user no longer needs to log in to Oracle databases, in order to clear the Oracle password verifiers generated for the Active Directory user, remove the user from any `ORA_VFR` groups, and reset the password (or require password change) for this user. You can also manually clear the `orclCommonAttribute` attribute for this user. Oracle password verifiers will no longer be generated after the user has been removed from `ORA_VFR` groups.

6.3.1.2 Configuring Password Authentication for a Centrally Managed User

You must perform password authentication configuration on Active Directory servers, and also on Oracle databases if it is required that Active Directory users will log in to Oracle databases with administrative privileges.

1. Deploy the Oracle Database password filter and extend the Active Directory schema.

The utility tool for performing this task, `opwdintg.exe`, is located in `$ORACLE_HOME/bin`. This utility installs the password filter in Active Directory, extends the Active Directory schema to hold the Oracle password verifiers, and creates the Active Directory password verifier groups. The password filter will enable the Microsoft Active Directory user accounts to be authenticated by the Oracle database when connected to clients using WebDAV, 11G, and 12C password verifiers.

- a. To deploy the `opwdintg.exe` executable, copy this file to the Active Directory server and then have the Active Directory administrator run the `opwdintg.exe` utility tool.
- b. Log in to Microsoft Active Directory as a user who has privileges to create and manage user groups.
- c. Check for the following password verifier user groups: `ORA_VFR_MD5`, `ORA_VFR_11G`, and `ORA_VFR_12C`. If these groups do not exist, then rerun the `opwdintg.exe` utility tool.
- d. Add the Microsoft Active Directory users who will use Oracle Database to these groups, following these guidelines:
 - If either the client or the server only permits Oracle Database release 12c authentication, then add the user to the `ORA_VFR_12C` group. (Oracle Database release 18c uses the same verifier as Oracle Database release 12c.)

- If both the client and the server only permit authentication lower than Oracle Database release 12c (that is, they have Oracle Database releases 11g, or 12.1.0.1 clients), then add the user to the `ORA_VFR_11G` group.
- If a user must authenticate through an Oracle Database WebDAV client, then the user must be a member of the `ORA_VFR_MD5` group.

This configuration enables fine-grained control over the generation of the Oracle Database password verifiers. Only the required verifiers for the required users are generated. For example, if Microsoft Active Directory user `pfitch` is added to the `ORA_VFR_12C` and `ORA_VFR_11G` groups, then both the 12C and 11G verifiers will be generated for `pfitch`. This ensures that when applicable, the most secure and strongest verifier is chosen, while in other cases, the 11G verifier is chosen for the Oracle Database release 11g clients.

2. Update the database password file to version 12.2.

If it is required that Active Directory users will log in to Oracle databases with administrative privileges, then update the database password file to version 12.2.

- As a user with administrative privileges, log in to the host where the database that is to be used for the Microsoft Active Directory connection resides.
- Go to the `$ORACLE_HOME/dbs` directory.
- Run the `ORAPWD` utility to set the format to 12.2.

For example:

```
orapwd FILE='/app/oracle/product/18.1/db_1/dbs/orapwdb181' FORMAT=12.2
```

This setting ensures that you can grant the various administrative privileges such as `SYSPOER` and `SYSBACKUP` to the global user.

- Log in to the database instance as a user who has the `ALTER SYSTEM` privilege.
- Make sure that the `LDAP_DIRECTORY_SYSAUTH` parameter is set to `YES` in the `spfile` or the `init.ora` file.
- Set the `REMOTE_LOGIN_PASSWORDFILE` parameter to `EXCLUSIVE` in the `spfile` or the `init.ora` file.
- Connect to the root as a user with the `SYSDBA` administrative privilege.
- Restart the database instance.

- **From a CDB:** Enter the following:

```
SHUTDOWN IMMEDIATE
STARTUP
```

- **From a PDB:** Enter the following:

```
ALTER PLUGGABLE DATABASE pdb_name CLOSE IMMEDIATE;
ALTER PLUGGABLE DATABASE pdb_name OPEN;
```

To find the available PDBs in a CDB, log in to the CDB root container and then query the `PDB_NAME` column of the `DBA_PDBS` data dictionary view. To check the current container, run the `show con_name` command.

```
SHUTDOWN IMMEDIATE
STARTUP
```

Related Topics

- [Step 2: For Password Authentication, Install the Password Filter and Extend the Microsoft Active Directory Schema](#)
You can use the Oracle `opwdintg.exe` executable on the Active Directory server to install the password filter and extend the Active Directory schema.

6.3.1.3 Logging in to an Oracle Database Using Password Authentication

For password authentication, centrally managed users have choices of how to log in to the database.

To log in to a database that is configured to connect to Active Directory, an Active Directory user can use the following logon user name syntax if they are using password authentication:

```
sqlplus /nolog
connect "Windows_domain\Active_Directory_user_name"@tnsname_of_database
Password: password
```

If the password contains special characters, such as `@` and `_`, and you are entering the password in the `CONNECT` line, then enclose the password in double quotation marks. For better security, Oracle recommends that you enter the password at the `Password` prompt. (In that case, you do not need to enclose the password in quotes.)

The TNS alias in the `tnsnames.ora` file corresponds to a PDB of a multitenant database. The following connection assumes the Windows domain name is `production`:

```
connect "production\pfitch"@inst1
```

If the Active Directory user is in the same Active Directory domain as the Oracle Service Directory User Account configured in the database wallet, then an Active Directory user can use this user name (`samAccountName`) directly to log on to the database:

```
sqlplus samAccountName@tnsname_of_database
Enter password: password
```

For example:

```
connect pfitch@inst1
Enter password: password
```

Alternatively, the user can use their Active Directory Windows user logon name with the DNS domain name.

```
connect "Active_Directory_user_name@Windows_DNS_domain_name"@tnsname_of_database
Password: password
```

For example:

```
connect "pfitch@production.examplecorp.com"@inst1
```

6.3.2 Configuring Proxy Authentication for Centrally Managed Users

Proxy authentication enables a centrally managed user to proxy to a database schema for tasks such as application maintenance.

- [About Configuring Proxy Authentication for Centrally Managed Users](#)
Centrally managed users can connect to Oracle Database by using proxy authentication.

- [Configuring Proxy Authentication for the Centrally Managed User](#)
To configure proxy authentication for a centrally managed user, this user must already have a mapping to a global schema (exclusive or shared mapping). A separate database schema for the centrally managed user to proxy to must also be available.
- [Validating the Centrally Managed User Proxy Authentication](#)
You can validate the centrally managed user proxy configuration for password authentication.

6.3.2.1 About Configuring Proxy Authentication for Centrally Managed Users

Centrally managed users can connect to Oracle Database by using proxy authentication.

Proxy authentication is typically used to authenticate the real user and then authorize them to use a database schema with the schema privileges and roles in order to manage an application. Alternatives such as sharing the application schema password are considered insecure and unable to audit which actual user performed an action.

A use case can be in an environment in which a named centrally managed user who is an application database administrator can authenticate by using their credentials and then proxy to a database schema user (for example, `hrapp`). This authentication enables the Active Directory security administrator to use the `hrapp` privileges and roles as user `hrapp` in order to perform application maintenance, yet still use their centrally managed user credentials for authentication. An application administrator can sign in to the database and then proxy to an application schema to manage this schema.

You can configure proxy authentication for password authentication.

6.3.2.2 Configuring Proxy Authentication for the Centrally Managed User

To configure proxy authentication for a centrally managed user, this user must already have a mapping to a global schema (exclusive or shared mapping). A separate database schema for the centrally managed user to proxy to must also be available.

After you ensure that you have this type of user, alter the database user account to enable the centrally managed user to proxy to it.

1. Log in to the Oracle Database instance as a user who has the `ALTER USER` system privileges.
2. Grant permission for the centrally managed user to proxy to the local database user account.

A centrally managed user cannot be referenced in the command so the proxy must be created between the database global user (mapped to the centrally managed user) and the target database user.

In the following example, `hrapp` is the database schema to proxy to, and `peterfitch_schema` is the database global user exclusively mapped to user `peterfitch`.

```
ALTER USER hrapp GRANT CONNECT THROUGH peterfitch_schema;
```

At this stage, the centrally managed user can log in to the database instance using the proxy. For example, to connect using a password verifier:

```
CONNECT peterfitch[hrapp]@connect_string  
Enter password: password
```

6.3.2.3 Validating the Centrally Managed User Proxy Authentication

You can validate the centrally managed user proxy configuration for password authentication.

1. Log in to the Oracle Database instance as a user who has the `CREATE USER` and `ALTER USER` system privileges.
2. Connect as the centrally managed user and run the `SHOW USER` and `SELECT SYS_CONTEXT` commands.

For example, suppose you want to check the proxy authentication of the centrally managed user `peterfitch` when he proxies to database user `hrapp`. You will need to connect to the database using the different types of authentication methods shown here, but the output of the commands that you run will be the same for all types.

```
CONNECT peterfitch[hrapp]/password\!@connect_string
SHOW USER;
--The output should be "USER is HRAPP"
SELECT SYS_CONTEXT('USERENV','AUTHENTICATION_METHOD') FROM DUAL;
--The output should be "PASSWORD_GLOBAL"
SELECT SYS_CONTEXT('USERENV','PROXY_USER') FROM DUAL;
--The output should be "PETERFITCH_SCHEMA"
SELECT SYS_CONTEXT('USERENV','CURRENT_USER') FROM DUAL;
--The output should be "HRAPP"
```

6.3.3 Configuring Kerberos Authentication for Centrally Managed Users

If you plan to use Kerberos authentication, then you must configure Kerberos in the Oracle database that will be integrated with Microsoft Active Directory.

CMU-Active Directory only supports the Microsoft Active Directory Kerberos server. Other non-Active Directory Kerberos servers are not supported with CMU-Active Directory.

 **Note:**

You do not create database users identified externally as an Active Directory user's Kerberos UPN. Instead, you use global users that are mapped to Active Directory users or groups.

Related Topics

- [Mapping a Directory Group to a Shared Database Global User](#)
Most users of the database will be mapped to a shared global database user (schema) through membership in a directory group.
- [Exclusively Mapping a Directory User to a Database Global User](#)
You can map a Microsoft Active Directory user exclusively to an Oracle Database global user.
- [Enabling Kerberos Authentication](#)
To enable Kerberos authentication for Oracle Database, you must first install it, and then follow a set of configuration steps.

6.3.4 Configuring Authentication Using PKI Certificates for Centrally Managed Users

If you plan to use PKI certificates for the authentication of centrally managed users, then you must configure Transport Layer Security in the Oracle database that will be integrated with Microsoft Active Directory.

While Kerberos authentication with CMU requires use of the Microsoft Active Directory-Active Directory Kerberos server, PKI authentication can use third-party CA services, not just the one with Microsoft Active Directory-Active Directory.

 **Note:**

You use an Active Directory user certificate when you configure Transport Layer Security Authentication. However, you do not create database users identified externally as the DN of the Active Directory user certificate. Instead, you use global users that are mapped to Active Directory users or groups.

Related Topics

- [Mapping a Directory Group to a Shared Database Global User](#)
Most users of the database will be mapped to a shared global database user (schema) through membership in a directory group.
- [Exclusively Mapping a Directory User to a Database Global User](#)
You can map a Microsoft Active Directory user exclusively to an Oracle Database global user.
- [Configuring PKI Certificate Authentication](#)
You can configure Oracle Database to use PKI certificates for end-user authentication.

6.4 Configuring Authorization for Centrally Managed Users

With centrally managed users, you can manage the authorization for Active Directory users to access Oracle databases.

Users can be added, modified, or dropped from an organization by using Active Directory without your having to add, modify, or drop the user from every database in your organization.

- [About Configuring Authorization for Centrally Managed Users](#)
You can manage user authorization for a database within Active Directory.
- [Mapping a Directory Group to a Shared Database Global User](#)
Most users of the database will be mapped to a shared global database user (schema) through membership in a directory group.
- [Mapping a Directory Group to a Global Role](#)
Database global roles mapped to directory groups give member users additional privileges and roles above what they have been granted through their login schemas.
- [Exclusively Mapping a Directory User to a Database Global User](#)
You can map a Microsoft Active Directory user exclusively to an Oracle Database global user.

- [Altering or Migrating a User Mapping Definition](#)
You can update an Active Directory user to a Database global user mapping by using the `ALTER USER` statement.
- [Configuring Administrative Users](#)
Administrative users can work as they have in the past, but with CMU, they can be controlled with centralized authentication and authorization if they are using shared schemas.
- [Verifying the Centrally Managed User Logon Information](#)
After you configure and authorize a centrally managed user, you can verify the user logon information by executing a set of SQL queries on the Oracle database side.

6.4.1 About Configuring Authorization for Centrally Managed Users

You can manage user authorization for a database within Active Directory.

Most Oracle Database users will be mapped to a shared database schema (user). This minimizes the work that must be done in each Oracle database when directory users are hired, change jobs within the company, or leave the company. A directory user will be assigned to an Active Directory group that is mapped to an Oracle database global user (schema). When the user logs into the database, the database will query Active Directory to find the groups the user is a member of. If your deployment is using shared schemas, then one of the groups will map to a shared database schema and the user will be assigned to that database schema. The user will have the roles and privileges that granted to the database schema. Because multiple users will be assigned to the same shared database schema, only the minimal set of roles and privileges should be granted to the shared schema. In some cases, no privileges and roles should be granted to the shared schema. Users will be assigned the appropriate set of roles and schemas through database global roles. Global roles are mapped to Active Directory groups. This way, different users can have different roles and privileges even if they are mapped to the same database shared schema. A newly hired user will be assigned to an Active Directory group mapped to a shared schema and then to one or more additional groups mapped to global roles to gain the additional roles and privileges required to complete their tasks. The combination of shared schemas and global roles allows for centralized authorization management with minimal changes to the database operationally. The database must be initially provisioned with the set of shared schemas and global roles mapped to the appropriate Active Directory groups, but then user authorization management can happen within Active Directory.

An Active Directory user can also be exclusively mapped to a database global user. This requires a new user in the database that is mapped directly to the Active Directory user. New users and departing users will require updates to each database they are members of.

Active Directory users requiring administrative privileges such as `SYSOPER` and `SYSBACKUP` cannot be granted these through global roles. Administrative privileges can only be granted to a schema and not a role. But even in these cases with administrative privileges, shared schemas can be used to provide ease of user authorization management. Using a shared schema with the `SYSOPER` privilege will allow new users to be easily added to the Active Directory group mapped to the schema with `SYSOPER` without having to create a new user schema in the database. Even if only one user is assigned to the shared schema, it can still be managed centrally.

When using global roles to grant privileges and roles to the user, remember that the maximum number of enabled roles in a session is 150.

The following types of global user mappings are supported for authorization:

- Map shared global users, in which directory users are assigned to a shared database schema (user) through the mapping of a directory group to the shared schema. The directory users that are members of the group can connect to the database through this shared schema. Use of shared schemas allows for centralized management of user authorization in Active Directory.
- Exclusive global user mappings, in which a dedicated database user is exclusively mapped to a directory user. Not as common as the shared database schema, this user is created for direct database access by using either SQL*Plus or the schema user for two-tier or three-tier applications. Oracle recommends that you grant database privileges to these users through global roles, which facilitates authorization management. However, these users can also have direct privilege grants in the Oracle database, although this is not recommended. This is because two-tier and three-tier applications can use the global user as the database schema, so the global user has the full database privileges on the schema objects as the owner.

It is common for a directory user to be a member of multiple groups. However, only one of these groups should be mapped to a shared schema.

6.4.2 Mapping a Directory Group to a Shared Database Global User

Most users of the database will be mapped to a shared global database user (schema) through membership in a directory group.

The Active Directory group must be created before the database global user can be mapped to it. You can add Active Directory users to the group at any time before the user needs to log in to the database. On the database side, you must have the `CREATE USER` and `ALTER USER` privileges to perform these mappings. This configuration can be used for users who have the password authentication, Kerberos authentication, and public key infrastructure (PKI) authentication methods.

You can assign users who share the same database schema for an application into an Active Directory group. A shared Oracle Database global user (that is, a shared schema) is mapped to an Active Directory group. This way, any Active Directory user of this group can log in to the database through that shared global user account. Although the database global user account is shared by group members, the Active Directory user's authenticated identity (Windows domain and their `samAccountName`), and enterprise identity (DN) are tracked and audited inside the database.

1. Log in to the database instance as a user who has been granted the `CREATE USER` or `ALTER USER` system privilege.
2. Execute the `CREATE USER` or `ALTER USER` statement with the `IDENTIFIED GLOBALLY AS` clause specifying the DN of an Active Directory group.

For example, to map a directory group named `widget_sales_group` in the `sales` organization unit of the `production.examplecorp.com` domain to a shared database global user named `WIDGET_SALES`:

```
CREATE USER widget_sales IDENTIFIED GLOBALLY AS
'CN=widget_sales_group,OU=sales,DC=production,DC=examplecorp,DC=com';
```

All members of the `widget_sales_group` will be assigned to the `widget_sales` shared schema when they log in to the database.

6.4.3 Mapping a Directory Group to a Global Role

Database global roles mapped to directory groups give member users additional privileges and roles above what they have been granted through their login schemas.

1. Log in to the database instance as a user who has been granted the `CREATE ROLE` or `ALTER ROLE` system privilege.
2. Run the `CREATE ROLE` or `ALTER ROLE` statement with the `IDENTIFIED GLOBALLY AS` clause specifying the DN of an Active Directory group.

For example, to map a directory user group named `widget_sales_group` in the `sales` organization unit of the `production.examplecorp.com` domain to a database global role `WIDGET_SALES_ROLE`:

```
CREATE ROLE widget_sales_role IDENTIFIED GLOBALLY AS
'CN=widget_sales_group,OU=sales,DC=production,DC=examplecorp,DC=com';
```

To create a common role called `C##WIDGET_SALES_ROLE`:

```
CREATE ROLE c##widget_sales_role IDENTIFIED GLOBALLY AS
'CN=widget_sales_group,OU=sales,DC=production,DC=examplecorp,DC=com'
CONTAINER = ALL;
```

All members of the `widget_sales_group` will be authorized with the database role `widget_sales_role` when they log in to the database.

6.4.4 Exclusively Mapping a Directory User to a Database Global User

You can map a Microsoft Active Directory user exclusively to an Oracle Database global user.

You perform the configuration on the Oracle Database side only, not the Active Directory side. You must have the `CREATE USER` and `ALTER USER` privileges to perform these mappings. This configuration can be used for users who have the password authentication, Kerberos authentication, and public key infrastructure (PKI) authentication methods.

1. Log in to the database instance as a user who has been granted the `CREATE USER` or `ALTER USER` system privilege.
2. Execute the `CREATE USER` or `ALTER USER` statement with the `IDENTIFIED GLOBALLY AS` clause specifying the DN of an Active Directory user.

For example, to map an existing Active Directory user named `Peter Fitch` (whose `samAccountName` is `pfitch`) in the `sales` organization unit of the `production.examplecorp.com` domain to a database global user named `PETER_FITCH`:

```
CREATE USER peter_fitch IDENTIFIED GLOBALLY AS
'CN=Peter Fitch,OU=sales,DC=production,DC=examplecorp,DC=com';
```

6.4.5 Altering or Migrating a User Mapping Definition

You can update an Active Directory user to a Database global user mapping by using the `ALTER USER` statement.

You can update users whose accounts were created using any of the `CREATE USER` statement clauses: `IDENTIFIED BY password`, `IDENTIFIED EXTERNALLY`, or `IDENTIFIED GLOBALLY`. This is useful when migrating users to using CMU. For example, a database user that is externally authenticated to Kerberos will be identified by their user principal name (UPN). To migrate the user to use CMU with Kerberos authentication, you would need to run the `ALTER USER` statement to declare a global user and identify the user with their Active Directory distinguished name (DN).

1. Log in to the database instance as a user who has been granted the `ALTER USER` system privilege.

2. Run the `ALTER USER` statement with the `IDENTIFIED GLOBALLY AS` clause.

For example:

```
ALTER USER peter_fitch IDENTIFIED GLOBALLY AS  
'CN=Peter Fitch,OU=sales,DC=production,DC=examplecorp,DC=com';
```

6.4.6 Configuring Administrative Users

Administrative users can work as they have in the past, but with CMU, they can be controlled with centralized authentication and authorization if they are using shared schemas.

- [Configuring Database Administrative Users with Shared Access Accounts](#)
Using shared accounts simplifies the management of database administrators for multiple databases as they join, move, and leave the organization.
- [Configuring Database Administrative Users Using Exclusive Mapping](#)
Database administrators can also be mapped to exclusive schemas in databases.

6.4.6.1 Configuring Database Administrative Users with Shared Access Accounts

Using shared accounts simplifies the management of database administrators for multiple databases as they join, move, and leave the organization.

You can assign new database administrators to shared accounts in multiple databases using Active Directory groups without having to create new Oracle database accounts.

1. Ensure that the password file for the current database instance is in the 12.2 format.

```
orapwd file=pwd_file FORMAT=12.2  
Enter password for SYS: password
```

2. In Active Directory, create an Active Directory group (for example, for a database administrator backup users group called `ad_dba_backup_users`).
3. In Oracle Database, create a global user (shared schema) (for example, `db_dba_backup_global_user`) and map this user to the Active Directory `ad_dba_backup_users` group.
4. Grant the `SYSBACKUP` administrative privilege to the global user `db_dba_backup_global_user`.

At this stage, any Active Directory user who is added to the `ad_dba_backup_users` Active Directory group will be assigned to the new database shared schema with the `SYSBACKUP` administrative privilege.

6.4.6.2 Configuring Database Administrative Users Using Exclusive Mapping

Database administrators can also be mapped to exclusive schemas in databases.

1. Ensure that the password file for the current database instance is in the 12.2 format.

```
orapwd file=pwd_file FORMAT=12.2  
Enter password for SYS: password
```

2. Log in to the database instance as a user who can create users and grant administrative privileges to other users.
3. Create a database global user.

For example:

```
CREATE USER peter_fitch IDENTIFIED GLOBALLY AS
'CN=Peter Fitch,OU=sales,DC=production,DC=examplecorp,DC=com';
```

4. Grant this user the administrative privilege.

For example, to grant a user the SYSKM administrative privilege:

```
GRANT SYSKM TO peter_fitch;
```

Due to the amount of work to maintain accounts and the mapping in both the database and Active Directory, a more centralized approach would be to use shared schemas for these administrative accounts as well, even if only one Active Directory user is assigned to the shared database account in some cases.

6.4.7 Verifying the Centrally Managed User Logon Information

After you configure and authorize a centrally managed user, you can verify the user logon information by executing a set of SQL queries on the Oracle database side.

1. Log in to the CDB or PDB as a centrally managed user from Active Directory that you have just configured and authorized.

For example, to log in to the database instance `inst1` as the enterprise user `pfitch`, who is on the Windows domain `production`:

```
sqlplus /nolog
connect "production\pfitch"@inst1
Enter password: password
```

2. Verify the mapped global user.

The mapped global user is the database user account that has the centrally managed user authorization. User `PETER_FITCH` is considered a global user with exclusive mapping for the Active Directory user `pfitch`, while user `WIDGET_SALES` is considered a global user with shared mapping for Active Directory group `widget_sales_group` of which `pfitch` is a member. A global user account has its own schema.

```
SHOW USER;
```

Output similar to the following appears, depending on if it is an exclusive mapping or a shared mapping:

```
USER is "PETER_FITCH"
```

Or

```
USER is "WIDGET_SALES"
```

3. Find the roles that have been granted to the centrally managed user.

```
SELECT ROLE FROM SESSION_ROLES ORDER BY ROLE;
```

Output similar to the following appears:

```
ROLE
-----
WIDGET_SALES_ROLE
...
```

4. Run the following queries to check the `SYS_CONTEXT` namespace values for the current schema being used in this database session, current user name, session user name, authentication method, authenticated identity, enterprise identity, identification type, and LDAP server type.

- Verify the current schema that is being used in this database session. A database schema is an object container that identifies the objects it contains. The current schema is the default container for objects name resolution in this database session.

```
SELECT SYS_CONTEXT('USERENV', 'CURRENT_SCHEMA') FROM DUAL;
```

Output similar to the following appears, depending on if it is an exclusive mapping or a shared mapping:

```
SYS_CONTEXT('USERENV', 'CURRENT_SCHEMA')
-----
PETER_FITCH
```

Or

```
SYS_CONTEXT('USERENV', 'CURRENT_SCHEMA')
-----
WIDGET_SALES
```

- Verify the current user. In this case, the current user is the same as the current schema.

```
SELECT SYS_CONTEXT('USERENV', 'CURRENT_USER') FROM DUAL;
```

Output similar to the following appears, depending on if it is an exclusive mapping or a shared mapping:

```
SYS_CONTEXT('USERENV', 'CURRENT_USER')
-----
PETER_FITCH
```

Or

```
SYS_CONTEXT('USERENV', 'CURRENT_USER')
-----
WIDGET_SALES
```

- Verify the session user.

```
SELECT SYS_CONTEXT('USERENV', 'SESSION_USER') FROM DUAL;
```

Output similar to the following appears, depending on if it is an exclusive mapping or a shared mapping:

```
SYS_CONTEXT('USERENV', 'SESSION_USER')
-----
PETER_FITCH
```

Or

```
SYS_CONTEXT('USERENV', 'SESSION_USER')
-----
WIDGET_SALES
```

- Verify the authentication method.

```
SELECT SYS_CONTEXT('USERENV', 'AUTHENTICATION_METHOD') FROM DUAL;
```

Output similar to the following appears:

```
SYS_CONTEXT('USERENV','AUTHENTICATION_METHOD')
```

```
-----  
PASSWORD_GLOBAL
```

- Verify the authenticated identity for the enterprise user. The Active Directory authenticated user identity is captured and audited when this user logs on to the database.

```
SELECT SYS_CONTEXT('USERENV','AUTHENTICATED_IDENTITY') FROM DUAL;
```

Output similar to the following appears:

```
SYS_CONTEXT('USERENV','AUTHENTICATED_IDENTITY')
```

```
-----  
production\pfitch
```

- Verify the centrally managed user's enterprise identity.

```
SELECT SYS_CONTEXT('USERENV','ENTERPRISE_IDENTITY') FROM DUAL;
```

Output similar to the following appears:

```
SYS_CONTEXT('USERENV','ENTERPRISE_IDENTITY')
```

```
-----  
cn=Peter Fitch,ou=sales,dc=production,dc=examplecorp,dc=com
```

- Verify the identification type.

```
SELECT SYS_CONTEXT('USERENV','IDENTIFICATION_TYPE') FROM DUAL
```

Output similar to the following appears, depending on if it is an exclusive mapping or a shared mapping:

```
SYS_CONTEXT('USERENV','IDENTIFICATION_TYPE')
```

```
-----  
GLOBAL EXCLUSIVE
```

Or

```
SYS_CONTEXT('USERENV','IDENTIFICATION_TYPE')
```

```
-----  
GLOBAL SHARED
```

- Verify the LDAP server type.

```
SELECT SYS_CONTEXT('USERENV','LDAP_SERVER_TYPE') FROM DUAL;
```

Output similar to the following appears. In this case, the LDAP server type is Active Directory.

```
SYS_CONTEXT('USERENV','LDAP_SERVER_TYPE')
```

```
-----  
AD
```

Related Topics

- [Logging in to an Oracle Database Using Password Authentication](#)
For password authentication, centrally managed users have choices of how to log in to the database.

6.5 Integration of Oracle Database with Microsoft Active Directory Account Policies

As part of the Oracle Database-Microsoft Active Directory integration, Oracle Database enforces the Active Directory account policies when Active Directory users log into the Oracle database.

Active Directory account policy settings cover the password policy, account lockout policy, and Kerberos policy. Oracle Database enforces all of the account policies for centrally managed users from Active Directory. For example, Oracle prevents Active Directory users with account status, such as `password expired`, `password must change`, `account locked out`, or `account disabled` from logging in to the database. If you are using Kerberos authentication, then Oracle prevents Active Directory users with expired Kerberos tickets from logging in the database. If you are using password authentication, then an Active Directory user account will be locked out for a specified period of time on Active Directory after the user makes a specified number of failed attempts consecutively when trying to log in to the Oracle database using incorrect passwords. With enforcing the account lockout policy, Oracle effectively prevents password guessing attacks against Active Directory user accounts.



Note:

Oracle supports only the Active Directory default domain policy, but not any fine-grained password policies. For example, if a password expiration is set in the default domain policy but the fine-grained password policy has a shorter expiration, then only the password expiration in default domain policy is honored with Active Directory users who access the Oracle database by using CMU with Active Directory.

6.6 Configuring Centrally Managed Users with Oracle Autonomous Database

You can deploy centrally managed users (CMU) on Oracle Autonomous Database.

For instructions on deploying CMU on Oracle Autonomous Database, see "Use Microsoft Active Directory with Autonomous Database" in *Using Oracle Autonomous Database Serverless*.

6.7 Troubleshooting Centrally Managed Users

Oracle provides error messages that help you troubleshoot common errors that may arise when a Microsoft Active Directory user tries to log in to an Oracle database.

- [ORA-01017 Connection Errors](#)
The `ORA-01017: invalid username/password logon denied` error can be generated due to the differences in how special characters are allowed in Oracle Database and in Microsoft Active Directory.
- [ORA-28274 Connection Errors](#)
The `ORA-28274: No ORACLE password attribute corresponding to user nickname exists` error is generated due to problems with the Active Directory schema or the Oracle service directory.

- [ORA-28276 Connection Errors](#)
The ORA-28276: Invalid ORACLE password attribute error can result from an improperly set `orclCommonAttribute` attribute.
- [ORA-28300 Connection Errors](#)
The ORA-28030: No permission to read user entry in LDAP directory service error is generated due to permissions problems with the Oracle service directory.
- [Using Trace Files to Diagnose CMU Connection Errors](#)
The trace setting `gdsi` tracks centrally managed users (CMU) connection errors.

6.7.1 ORA-01017 Connection Errors

The ORA-01017: invalid username/password logon denied error can be generated due to the differences in how special characters are allowed in Oracle Database and in Microsoft Active Directory.

User names and passwords that centrally managed users (CMU) create follow different creation rules than the rules for Oracle Database user names and passwords. To remedy the problem of ORA-01017 errors, enclose the Active Directory user's user name and password in double quotation marks. For example, for an Active Directory user whose user name is `peter fitch` and whose password is `ILoveMySalads@_home!`, and who is in the same domain as the Oracle service user, the following login works:

```
CONNECT "peter fitch"/"ILoveMySalads@_home!"@orcl
```

If the Active Directory user is in a different domain than the Oracle service user, then the Windows domain (EXAMPLE in this case) must be included in the user name:

```
CONNECT "EXAMPLE\peter fitch"/"ILoveMySalads@_home!"@orcl
```

```
CONNECT "EXAMPLE\peter fitch"@orcl
Enter password: password
```

Note that for the password entered at the `Enter password` prompt, there are 22 characters in all: 20 characters for the `ILoveMySalads@_home!` password, plus two characters for the two double quotation marks.

6.7.2 ORA-28274 Connection Errors

The ORA-28274: No ORACLE password attribute corresponding to user nickname exists error is generated due to problems with the Active Directory schema or the Oracle service directory.

The Active Directory schema may not have been extended or it was populated poorly. Alternatively, the Oracle service directory user does not have required permissions to access the `orclCommonAttribute` attribute of the user who tried to log in to Oracle database.

To remedy this problem:

- **Solution 1:**
 1. Run the `opwdintg.exe` to install the password filter on **every** Windows domain controller in the domain for Active Directory.

2. Restart **each** Windows domain controller server. Each Windows domain controller must be restarted after you install the password filter. Otherwise, the password filter will not work on the Windows domain controller.
 3. Assign the Active Directory users to the appropriate `ORA_VFR` group.
 4. Reset the user password on Active Directory.
 5. Run `ldapsearch` to check that the password has been generated.
- **Solution 2:**
 1. Grant the Oracle service directory user account the `Read Properties` and `Write lockoutTime`, which are permissions to access the properties of the Active Directory user who tries to log in to the database.
 2. Set permissions for `Control Access` on the `orclCommonAttribute` of the Active Directory users.

Related Topics

- [Step 1: Create an Oracle Service Directory User Account on Microsoft Active Directory and Grant Permissions](#)
The Oracle service directory user account is for the interaction between Oracle Database and the LDAP directory service.

6.7.3 ORA-28276 Connection Errors

The ORA-28276: Invalid ORACLE password attribute error can result from an improperly set `orclCommonAttribute` attribute.

For example:

```
SQL> connect "myad\dev"@orcl_db
Enter password: password
```

```
ERROR:
ORA-28276: Invalid ORACLE password attribute.
```

This error occurs when the `orclCommonAttribute` attribute has not been correctly populated with user password. For example:

```
$ ldapsearch -h <AD_Server> -p 389 -D
"cn=oraclservice,cn=users,dc=myad,dc=example,dc=com" -w **** -U 2 -W
"file:wallet_path"
-P password -b "dc=myad,dc=example,dc=com" -s sub "(sAMAccountName=def*)"
dn orclCommonAttributeCN=def,CN=Users,DC=myad,DC=example,DC=com

orclCommonAttribute=
```

To remedy this problem:

1. Run the `opwdintg.exe` to install the password filter on **every** Windows domain controller in the domain for Active Directory.
2. Restart **each** Windows domain controller server. Each Windows domain controller must be restarted after you install the password filter. Otherwise, the password filter will not work on the Windows domain controller.

3. Assign the Active Directory users to the appropriate `ORA_VFR` group.
4. Reset the user password on Active Directory.
5. Run `ldapsearch` to check that the password has been generated.

6.7.4 ORA-28300 Connection Errors

The ORA-28030: No permission to read user entry in LDAP directory service error is generated due to permissions problems with the Oracle service directory.

You can track this error using the CMU trace. For example:

```
2023-03-27 19:51:55.0 - KZLG_ERR: failed to modify user status Insufficient
access
2023-03-27 17:57:27.0 - KZLG_ERR: LDAPERR=50, OER=28300
```

To remedy this problem, In addition), and also the permission

1. Grant the Oracle service directory user account the `Read Properties` and `Write lockoutTime`, which are permissions to access the properties of the Active Directory user who tries to log in to the database.
2. Set permissions for `Control Access` on the `orclCommonAttribute` of the Active Directory users.

Related Topics

- [Step 1: Create an Oracle Service Directory User Account on Microsoft Active Directory and Grant Permissions](#)
The Oracle service directory user account is for the interaction between Oracle Database and the LDAP directory service.
- [Using Trace Files to Diagnose CMU Connection Errors](#)
The trace setting `gdsi` tracks centrally managed users (CMU) connection errors.

6.7.5 Using Trace Files to Diagnose CMU Connection Errors

The trace setting `gdsi` tracks centrally managed users (CMU) connection errors.

As a user who has the `ALTER SYSTEM` privilege and the `SYSDBA` administrative privilege, you can enable this trace event as follows:

```
ALTER SYSTEM SET EVENTS='TRACE[GDSI] DISK LOW';
```

After the Active Directory user tries to log in, and if the login fails, go to the directory that contains the trace files and `grep` these files for the connection errors.

```
grep -i kzlg *.trc
```

Then you can collect and review the trace file that contains the detailed information.

To disable tracing, you can enter the following command:

```
ALTER SYSTEM SET EVENTS='TRACE[GDSI] OFF';
```

7

Authenticating and Authorizing IAM Users for Oracle DBaaS Databases

Identity and Access Management (IAM) users can be configured to connect to an Oracle Database as a service (Oracle DBaaS) instance.

- [Introduction to Authenticating and Authorizing IAM Users for Oracle DBaaS](#)
Before you begin authenticating and authorizing IAM users for an Oracle DBaaS instance, you should understand the overall process.
- [Configuring Oracle DBaaS for IAM](#)
To configure Oracle DBaaS to work with IAM, an Oracle DBaaS database administrator must first enable the IAM integration and then authorize IAM users and roles for Oracle DBaaS.
- [Configuring IAM for Oracle DBaaS](#)
To configure IAM to work with the Oracle DBaaS instance, an IAM administrator may need to create an IAM policy and have users create an IAM database password.
- [Accessing the Database Using an Instance Principal or a Resource Principal](#)
An Oracle Cloud Infrastructure (OCI) application or function can connect to the database instance using its own instance or resource principal.
- [Configuring the Database Client Connection](#)
Configuring the IAM client connection controls the authentication of IAM users to the Oracle DBaaS instance.
- [Accessing a Database Cross-Tenancy Using an IAM Integration](#)
Users and groups in one tenancy can access DBaaS database instances in another tenancy if policies in both tenancies allow this.
- [Database Links in an Oracle DBaaS-to-IAM Integration](#)
The use of database links when accessing the Oracle DBaaS database using IAM credentials is supported.
- [Troubleshooting IAM Connections](#)
The `ORA-01017: invalid username/password; logon denied` error can be caused by several different issues throughout the Oracle DBaaS integration with Identity and Access Management (IAM).

7.1 Introduction to Authenticating and Authorizing IAM Users for Oracle DBaaS

Before you begin authenticating and authorizing IAM users for an Oracle DBaaS instance, you should understand the overall process.

- [About Authenticating and Authorizing IAM Users for Oracle DBaaS](#)
Users for the Oracle DBaaS instance can be centrally managed in Oracle Cloud Infrastructure (OCI) Identity and Access Management (IAM).

- [Architecture of the IAM Integration with Oracle DBaaS](#)
The architecture for the IAM integration with an Oracle DBaaS instance depends on whether the IAM user is using an Oracle Cloud Infrastructure (OCI) IAM database password verifier or an OCI IAM token to authenticate or connect to the DBaaS instance.
- [IAM Users and Groups to Map with Oracle DBaaS](#)
IAM users must be mapped to a schema, either an exclusive mapping of a database schema to an IAM user or to a database shared schema that is mapped to an IAM group the user is a member of.

7.1.1 About Authenticating and Authorizing IAM Users for Oracle DBaaS

Users for the Oracle DBaaS instance can be centrally managed in Oracle Cloud Infrastructure (OCI) Identity and Access Management (IAM).

You can perform this integration in the following Oracle Database environments:

- Oracle Autonomous Database Serverless
- Oracle Autonomous Database on Dedicated Exadata Infrastructure
- Oracle Autonomous Database on Exadata Cloud@Customer
- Oracle Exadata Database Service on Dedicated Infrastructure
- Oracle Exadata Database Service on Cloud@Customer
- Oracle Base Database Service

The instructions for configuring IAM use the term "Oracle DBaaS" to encompass these environments.

Note:

Oracle Database supports the Oracle DBaaS integration for OCI IAM with identity domains as well as the legacy IAM, which does not include identity domains. Both default and non-default domain users and groups are supported when using IAM with identity domains.

Oracle Database only supports Oracle DBaaS integration for OCI IAM with local IAM users when they use legacy IAM tenancies. Federated users are supported when using IAM with identity domains.

The DBaaS integration with OCI IAM does not support users with administrative privileges (*SYSDBA*, *SYSOPER*, *SYSBACKUP*, *SYSDBG*, *SYSKM*, and *SYSRAC*).

An Oracle Database administrator works with an OCI IAM administrator to manage the authentication and authorization of OCI IAM users who need to connect to the Oracle DBaaS instance. The types of Oracle DBaaS instance that IAM users can connect to are Oracle Autonomous Database Serverless, Oracle Autonomous Database on Dedicated Exadata Infrastructure, and Oracle Base Database Service.

This type of connection enables the IAM user to access the Oracle DBaaS. These users typically log in with a user name and password (for example, using SQL*Plus). Alternatively, a user can log in with IAM Single-Sign On (SSO) credentials with a token when accessing the DBaaS instance. The choice to use IAM password authentication or the IAM SSO token authentication depends on the use case and user preference.

Legacy applications using existing supported database clients can migrate seamlessly to using an IAM user name and password. They can also use the IAM database gradual password rollover feature to set a second database password in IAM and update the application passwords without downtime.

Tools and applications that are updated to support IAM tokens can authenticate users directly with IAM and pass the database access token to the DBaaS instance. Existing database tools such as SQL*Plus can use the IAM database password to authenticate with the database directly using existing password login protocol or the database client can request a database token (`db-token`) from OCI IAM using the IAM user name and IAM database password and send the `db-token` to the database for IAM user access. The database client can only request a `db-token` in exchange for the IAM user name and IAM database password. All other IAM credentials (`API-key`, instance principal, resource principal, security token, delegation token) will require the `db-token` to be requested by the application or helper client like OCI CLI. A database access token (`db-token`) is a scoped proof-of-possession (POP) token and comes with a public key. Before the `db-token` is sent to the database, the database client signs the `db-token` with the private key that is associated with token's public key. It provides "proof" that the sender of the token is the rightful holder of the token. The scope can optionally be included as part of the request for the `db-token` to reduce the scope of what the `db-token` can be used for. The default scope for the `db-token` is the entire tenancy but compartment and individual databases can also be defined as the scope. See the `get` description in [OCI CLI Command Reference](#) for more information.

IAM users and OCI applications can request a database token from IAM by using one of the following methods:

- Using an existing, valid security (session) token
- Using an IAM recognized API-key
- Using a delegation token within an OCI cloud shell
- Using an OCI instance principal for an application on OCI compute instance
- Using an OCI resource principal for an application with a resource principal
- Using an IAM user name and IAM database password (can only be requested by database client)

The general process of enabling an IAM user to connect to an Oracle DBaaS instance is as follows:

1. The IAM administrator creates and manages the IAM user accounts and groups, adding IAM users to appropriate IAM groups based on their tasks.
2. On the Oracle DBaaS instance, the database administrator enables the connection between the Oracle DBaaS and the IAM endpoint.
If the database is Autonomous Database on Dedicated Exadata Infrastructure, then the IAM connection for new PDBs is automatically enabled. Check the Oracle DBaaS documentation for details.
3. On the Oracle DBaaS server, the database administrator enables the authorization of the IAM users by performing the following types of mappings:
 - Mapping an IAM group to a shared Oracle Database global user account
 - Mapping an IAM group to an Oracle Database global role
 - Exclusively mapping the IAM user to an Oracle Database global user

The IAM user must be mapped to one schema, either exclusively or to a shared schema. They can optionally be members in an IAM group that is mapped to one or more global roles.

4. The following use cases are some common scenarios to connect to the Oracle DBaaS with centralized IAM authentication and authorization:
 - Connecting using SQL*Plus to the Oracle DBaaS using an IAM user name and IAM database password.
 - Using SQL*Plus to connect using an IAM SSO token.
 - Using SQLcl to connect to the Oracle DBaaS using the IAM password or IAM token.
 - Using SQL*Plus within the Oracle Cloud Infrastructure (OCI) Cloud Shell to connect to the Oracle DBaaS using the IAM password or IAM SSO token. Authenticating and authorization with IAM will take additional time as opposed to authenticating to a local database user account (non-global).

Related Topics

- [Oracle Autonomous Database Serverless](#)
- [Oracle Autonomous Database on Dedicated Exadata Infrastructure](#)
- [Oracle Autonomous Database on Exadata Cloud@Customer](#)
- [Oracle Exadata Database Service on Dedicated Infrastructure](#)
- [Oracle Exadata Database Service on Cloud@Customer](#)
- [Oracle Base Database Service](#)
- [Enabling External Authentication for Oracle DBaaS](#)
The method of enabling an IAM connection with Oracle DBaaS depends on the platform of Oracle DBaaS that you are using.

7.1.2 Architecture of the IAM Integration with Oracle DBaaS

The architecture for the IAM integration with an Oracle DBaaS instance depends on whether the IAM user is using an Oracle Cloud Infrastructure (OCI) IAM database password verifier or an OCI IAM token to authenticate or connect to the DBaaS instance.

The following diagram illustrates how using an Oracle Cloud Infrastructure (OCI) IAM database password verifier to authenticate with the Oracle DBaaS works:

Figure 7-1 IAM User Authenticating to Oracle DBaaS with an OCI IAM Database Password Verifier

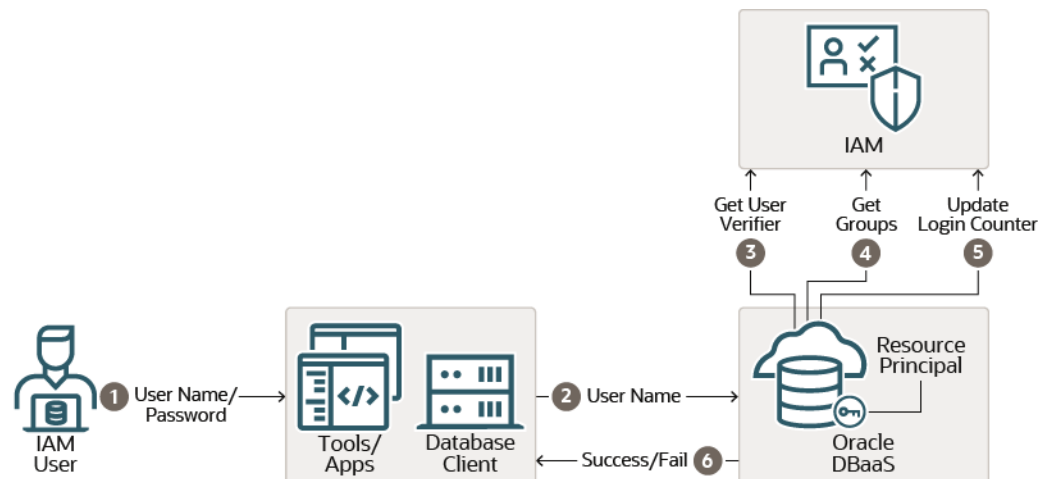

1. The IAM user logs in to a tool or application client that is associated with the Oracle Database client. This user logs in with their IAM user name and IAM database password, which begins the authentication process. The user can use any database client that is at least Oracle Database release 12.1.0.2. Earlier versions of the database client do not support the 12C database verifier.
2. The IAM user connection request is sent through the database client.
3. After the IAM user name is sent to the Oracle DBaaS instance, the database requests the user's Oracle Cloud Infrastructure (OCI) IAM database password verifier from IAM. (The IAM user profile stores the IAM database password verifier.) This verifier is a hashed version of the password, not clear text. If the password verifier from IAM matches the password verifier generated by the database client, then the user is authenticated. The Oracle DBaaS instance uses a resource principal to communicate with IAM. The resource principal is the Oracle DBaaS identity that is recognized by IAM and used by the database to securely communicate with IAM.
4. When the authentication succeeds, the Oracle DBaaS instance retrieves the IAM user groups. If the IAM user is mapped to an Oracle Database schema and the user has not been locked out of their OCI account, then the IAM user successfully accesses the database. The user is also granted any global roles that are mapped to a group the user is a member of.
5. The Oracle Cloud Infrastructure (OCI) login counter tracks logins for both the OCI console and OCI database passwords. A successful database login using the IAM database password will reset this counter.
6. Based on the outcome of the preceding steps, the IAM user database access attempt either succeeds or fails.

The following diagram illustrates the start of actions that take place when an IAM user or an Oracle Cloud Infrastructure (OCI) application accesses the Oracle DBaaS instance using an OCI IAM token:

Figure 7-2 IAM User or OCI Application Authenticating to an Oracle DBaaS with an OCI IAM Token, Part 1

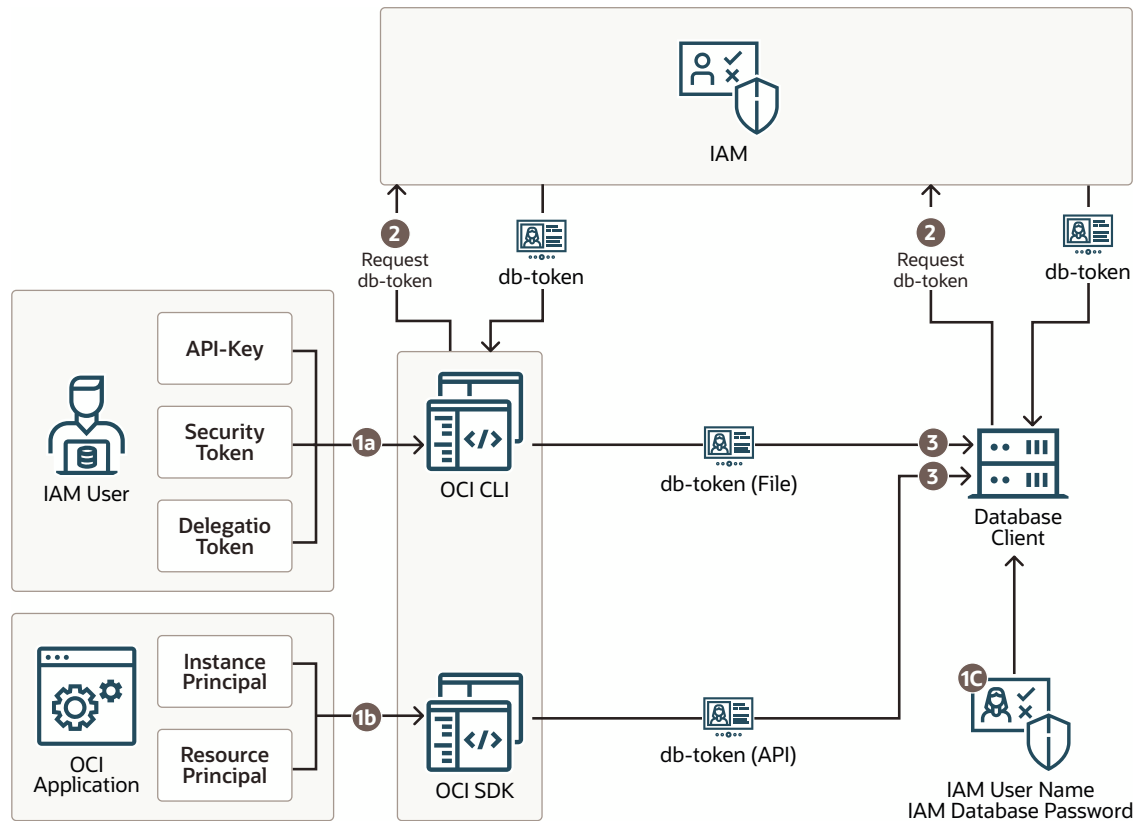

1. Access to the database requires one of the following:
 - **1a:** From an IAM user, the user must have an API-key stored in their local system or have a security token from signing into OCI recently. An API-key, security token, delegation token, instance principal, can be used with the OCI CLI. If a current and valid security token is not available, then the user can be prompted to authenticate with OCI IAM. (See [User Credentials](#) for information about the available user credentials.) In an OCI cloud shell environment, a delegation token will be available.
 - **1b:** For an OCI application, the application must have be configured to have an instance principal or a resource principal. All key types (API-key, security token, delegation token, instance principal, and resource principal) can be used with the OCI SDK.
 - **1c:** You can configure the database client to request a db-token from IAM by using the IAM user name and IAM database password. Only the database client can use this type of token to access the database. The database client cannot request a db-token using any other credential.
2. The application, OCI CLI, or the database client makes a call to IAM requesting the db-token using one of the principal credentials. Only the db-token can be used to access the Oracle DBaaS. Requesting a db-token can be done by an application written with the Oracle Cloud Infrastructure (OCI) public SDK to connect with OCI IAM. (See [Software Development Kits and Command Line Interface](#).) If an application cannot be changed to connect directly with OCI IAM using the OCI public SDK, then a helper tool such as the OCI command line interface (OCI CLI) can be used to retrieve the db-token for the user.

The database client can also be configured to request a `db-token` using the IAM user name and IAM database password.

- An application or tool that has been updated to work with IAM can then pass the `db-token` directly to the database client through the client API as an attribute. If an application cannot be updated to get the `db-token` directly, then a helper tool such as OCI CLI can put the `db-token` into the default or specified location in the local directory. The `TOKEN_AUTH=OCI_TOKEN` setting in the connect string or the `sqlnet.ora` file enables the database client to retrieve the `db-token` from the default or specified file location. A user can request a token at the OCI CLI by running the `oci iam db-token get` command and specifying their profile, which stores their user account credentials. For example:

```
oci iam db-token get --profile PeterFitch
```

The directory location for the `db-token` and the corresponding private key should only have enough permission for the OCI CLI to write the files to the location and the database client to retrieve these files (for example, just read and write by the process user). Because the token and key allow access to the database, they should be protected within the file system.

The following diagram illustrates the continuation of the OCI IAM token authentication process:

Figure 7-3 IAM User or OCI Application Authenticating to an Oracle DBaaS with an OCI IAM Token, Part 2

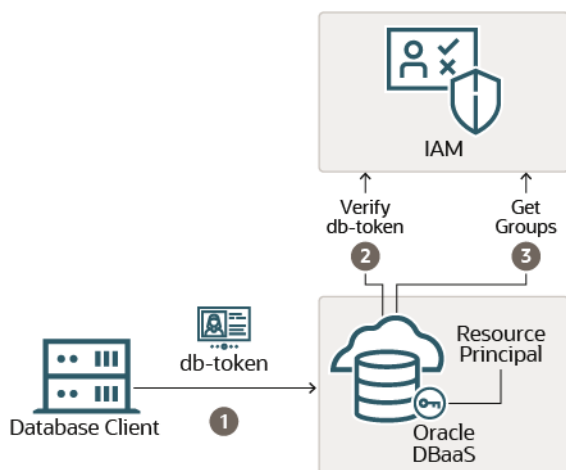

- The `db-token` is signed and sent to the Oracle DBaaS instance. TLS must be enabled on the database client-server link as well as DN matching. (When you use the Autonomous Database wallet files to connect to the Autonomous Database instance, TLS and DNS matching is already set for you.) DN matching is on by default with the JDBC driver, but will need to be configured for the OCI-C database client (and instant client). A `db-token` that the database client retrieves by using an IAM user name and IAM database password does not come with a private key and is not signed by the database client.
- The Oracle DBaaS instance will request the IAM public key, if a valid copy is not already available locally. This key will be used to validate that the `db-token` was sent by IAM. The Oracle DBaaS instance uses a resource principal to communicate with IAM.
- After this authorization step completes successfully, the Oracle DBaaS instance will request the IAM user's groups from IAM. This action will map the user to a global schema and also to map the user to any global roles that the user is a member of. After the IAM

user has successfully completed these steps, the user has access to the Oracle DBaaS instance.

IAM SSO token-based authentication requires that you download the latest Oracle Database 19c (19.16) clients.

Related Topics

- [Using Oracle Autonomous Database Serverless](#)

7.1.3 IAM Users and Groups to Map with Oracle DBaaS

IAM users must be mapped to a schema, either an exclusive mapping of a database schema to an IAM user or to a database shared schema that is mapped to an IAM group the user is a member of.

An IAM user must be mapped to a database schema to successfully complete the login and authorization steps. An IAM user can be directly mapped to a database schema if the IAM user needs to maintain their own schema objects (exclusive mapping). More commonly, an IAM user is a member of an IAM group that is mapped to a database schema (shared schema mapping). Shared schema mapping allows multiple IAM users to share the same schema so a new database schema is not required to be created every time a new user joins the organization. This operational efficiency allows database administrators to focus on database application maintenance, performance, and tuning tasks instead of configuring new users, updating privileges and roles, and removing accounts.

Database administrators for a group of databases can be members of an IAM group (for example, sales application developers for a sales application are in an IAM group called `sales_app_dev_group`). In this scenario, all the related databases can map the shared schema to the `sales_app_dev_group` group. Database global roles cannot be granted to a schema; they can only be mapped to an IAM group. Global roles can differentiate IAM user privileges when multiple IAM users are mapped to the same shared schema.

Remember that an IAM user **must** be mapped exclusively to a database schema or to a shared schema so that the IAM user can access the Oracle DBaaS instance.

7.2 Configuring Oracle DBaaS for IAM

To configure Oracle DBaaS to work with IAM, an Oracle DBaaS database administrator must first enable the IAM integration and then authorize IAM users and roles for Oracle DBaaS.

- [Enabling External Authentication for Oracle DBaaS](#)
The method of enabling an IAM connection with Oracle DBaaS depends on the platform of Oracle DBaaS that you are using.
- [Configuring Authorization for IAM Users and Oracle Cloud Infrastructure Applications](#)
An Oracle DBaaS database administrator can map IAM users and Oracle Cloud Infrastructure (OCI) applications to the Oracle Database global schemas and global roles.
- [Configuring IAM Proxy Authentication](#)
Proxy authentication allows an IAM user to proxy to a database schema for tasks such as application maintenance.

7.2.1 Enabling External Authentication for Oracle DBaaS

The method of enabling an IAM connection with Oracle DBaaS depends on the platform of Oracle DBaaS that you are using.

- **Oracle Autonomous Database on Dedicated Exadata Infrastructure:** The IAM connection is automatically configured to work with this platform. See *Using Oracle Autonomous Database on Dedicated Exadata Infrastructure*.
- **Oracle Autonomous Database Serverless:** The IAM connection must be enabled to work with this platform. See *Using Oracle Autonomous Database Serverless*.
- **Oracle Base Database Service:** See Use Identity and Access Management Authentication with Base Database Service.
- **Oracle Exadata Database Service on Dedicated Infrastructure:** See [Connect Identity and Access Management \(IAM\) Users to Oracle Exadata Database Service on Dedicated Infrastructure](#).

Databases Other Than Oracle Autonomous Database Serverless

1. Refer to the documentation for your Oracle DBaaS platform for prerequisites and other information you may need.
2. For non-Oracle Autonomous Database instances, set the `IDENTITY_PROVIDER_CONFIG` parameter.

```
ALTER SYSTEM SET IDENTITY_PROVIDER_TYPE=OCI_IAM SCOPE=BOTH;
```

If `IDENTITY_PROVIDER_CONFIG` had been set to a different value, then run the following statement:

```
ALTER SYSTEM RESET IDENTITY_PROVIDER_CONFIG SCOPE=BOTH;
```

The `IDENTITY_PROVIDER_CONFIG` parameter may have been set to a different value because a different identity provider, such as Microsoft Azure, had been used.

7.2.2 Configuring Authorization for IAM Users and Oracle Cloud Infrastructure Applications

An Oracle DBaaS database administrator can map IAM users and Oracle Cloud Infrastructure (OCI) applications to the Oracle Database global schemas and global roles.

- [About Configuring Authorization for IAM Users and Oracle Cloud Infrastructure Applications](#)
You create the mappings for IAM users and Oracle Cloud Infrastructure (OCI) applications to database users (schemas) in the Oracle DBaaS.
- [Mapping an IAM Group to a Shared Oracle Database Global User](#)
Oracle Database global users that are mapped to IAM groups and IAM dynamic groups give IAM users and OCI applications a schema when they log in along with the privileges and roles granted to that schema.
- [Mapping an IAM Group to an Oracle Database Global Role](#)
Oracle Database global roles that are mapped to IAM groups and dynamic groups give member users and applications additional privileges and roles above what they have been granted through their login schemas.
- [Exclusively Mapping an IAM User to an Oracle Database Global User](#)
You can map an IAM user exclusively to an Oracle Database global user.

- [Altering or Migrating an IAM User Mapping Definition](#)
You can update an IAM user to a database global user mapping by using the `ALTER USER` statement.
- [Mapping Instance and Resource Principals](#)
Applications can use instance principals and resource principals to retrieve database tokens and establish a connection to an Oracle DBaaS instance.
- [Verifying the IAM User Logon Information](#)
After you configure and authorize an IAM user for the Oracle DBaaS instance, you can verify the user logon information by executing a set of SQL queries on the Oracle database side.

7.2.2.1 About Configuring Authorization for IAM Users and Oracle Cloud Infrastructure Applications

You create the mappings for IAM users and Oracle Cloud Infrastructure (OCI) applications to database users (schemas) in the Oracle DBaaS.

There is a difference with authorization between IAM database password authentication and using IAM token based authentication. IAM database password verifier authorization is only based on mappings of database schemas and global roles to IAM users and group. With IAM token based authentication, IAM policies are an additional authorization for IAM users to access their tenancy databases. An IAM user must be authorized through an IAM policy **and** be authorized through a mapping to a database global schema (exclusive or shared).

For both token and password verifier database access, you create the mappings for IAM users and OCI applications to the Oracle DBaaS instance. The IAM user accounts themselves are managed in IAM. The user accounts and user groups can be in either the default domain or in a custom, non-default domain.

When the IAM user accesses the Oracle DBaaS instance with a token, the database will perform an authorization check against IAM policies to ensure the user is allowed to access the database. If the IAM user is allowed to access the database by IAM policy, then the database will query IAM for the user groups. When using password verifier authentication, the database will query IAM for user groups once the IAM user successfully completes authentication. The database queries the IAM endpoint to find the groups of which the user is a member. If your deployment is using shared schemas, then one of the IAM groups will map to a shared database schema and the IAM user will be assigned to that database schema. The IAM user will have the roles and privileges that are granted to the database schema. Because multiple IAM users can be assigned to the same shared database schema, only the minimal set of roles and privileges should be granted to the shared schema. In some cases, no privileges and roles should be granted to the shared schema. Users will be assigned the appropriate set of roles and schemas through database global roles. Global roles are mapped to IAM groups. This way, different users can have different roles and privileges even if they are mapped to the same database shared schema. A newly hired user will be assigned to an IAM group mapped to a shared schema and then to one or more additional groups mapped to global roles to gain the additional roles and privileges required to complete their tasks. The combination of shared schemas and global roles allows for centralized authorization management with minimal changes to the database operationally. The database must be initially provisioned with the set of shared schemas and global roles mapped to the appropriate IAM groups, but then user authorization management can happen within IAM.

Ensure that the IAM user is only mapped to one schema, either through exclusive mapping to a database schema or as a member of one IAM group that is mapped to a shared database schema. If more than one schema is mapped for an IAM user, then the database will take

exclusive mapping as precedence over any group mapping to a shared schema. If more than one group is mapped for a user, then the database will select the oldest mapping.

When using global roles to grant privileges and roles to the user, remember that the maximum number of enabled roles in a session is 150.

If you drop and recreate IAM users and groups using the same names, then the mappings from the database to IAM using the same names will continue to work. However, recreating an IAM user will require the IAM user to do one or more of the following: create the IAM database password, re-upload the API public key, update the OCI configuration file, and then re-examine the IAM policy for database authentication and authorization with IAM. If the IAM policy specifies a group that can use or manage the `database-connections` and `autonomous-database-family` resource types, then the user will need to be added to that group to allow IAM authentication and authorization.

Accessing the database with tokens requires the user to be authorized by IAM policy and by database mapping. Accessing the database with the IAM database password verifier requires authorization through database mapping. If no database schema mapping exists for the IAM user, the IAM user is prevented from accessing the database even if they have a valid token or password.

IAM users get their authorizations to perform various tasks based on the roles that they have been granted. The following scenarios are possible:

- **IAM group mapped to a shared Oracle Database global user:** With the shared database global user account, an IAM user is assigned to a shared database schema (user) through the mapping of an IAM group to the shared schema. The IAM users that are members of the group can connect to the database through this shared schema. Use of shared schemas allows for centralized management of user authorization in IAM.
- **IAM group mapped to an Oracle Database global role:** The privileges that have been granted to the shared Oracle Database global role become available to the users who have added to the IAM group.
- **Local IAM user exclusively mapped to an Oracle Database global user:** With an exclusive global user mapping, a dedicated database user is exclusively mapped to a local IAM user. Not as common as the shared database schema, this user is created for when the user requires their own schema objects. Oracle recommends that you grant database privileges to these users through global roles, which facilitates authorization management. These users can also have direct privilege and role grants to their exclusive schema. In IAM with Identity Domains, users and groups are supported in the default domain as well as custom non-default domains. The default domain can be `NULL` or `default`. When you specify users and groups in the default domain, then no domain prefix is required. When you specify users and groups in a non-default domain, then the domain must be prefixed.

7.2.2.2 Mapping an IAM Group to a Shared Oracle Database Global User

Oracle Database global users that are mapped to IAM groups and IAM dynamic groups give IAM users and OCI applications a schema when they log in along with the privileges and roles granted to that schema.

1. Log in to the Oracle DBaaS instance as a user who has the `CREATE USER` or `ALTER USER` system privilege.
2. Run the `CREATE USER` or `ALTER USER` statement with the `IDENTIFIED GLOBALLY AS` clause specifying the IAM group name (which can be a dynamic group).

For example, to create a new database global user account named `shared_sales_schema` and map it to an existing IAM group named `WidgetSalesGroup`:

```
CREATE USER shared_sales_schema IDENTIFIED GLOBALLY AS
'IAM_GROUP_NAME=WidgetSalesGroup';
```

The following example shows how to accomplish this for a non-default domain:

```
CREATE USER shared_sales_schema IDENTIFIED GLOBALLY AS
'IAM_GROUP_NAME=sales_domain/WidgetSalesGroup';
```

7.2.2.3 Mapping an IAM Group to an Oracle Database Global Role

Oracle Database global roles that are mapped to IAM groups and dynamic groups give member users and applications additional privileges and roles above what they have been granted through their login schemas.

Global roles cannot be granted to a database schema (user), they can only be mapped to a group and be assigned to an IAM user when accessing the database.

1. Log in to the Oracle DBaaS instance as a user who has been granted the `CREATE ROLE` or `ALTER ROLE` system privilege
2. Run the `CREATE ROLE` or `ALTER ROLE` statement with the `IDENTIFIED GLOBALLY AS` clause specifying the name of the IAM group (which can be a dynamic group).

For example, to create a new database global role named `widget_mgr_role` and map it to an existing IAM group named `WidgetManagerGroup`, using the default domain:

```
CREATE ROLE widget_mgr_role IDENTIFIED GLOBALLY AS
'IAM_GROUP_NAME=WidgetManagerGroup';
```

The following example shows how to create the role by specifying a non-default domain, `sales_domain`:

```
CREATE ROLE widget_sales_role IDENTIFIED GLOBALLY AS
'IAM_GROUP_NAME=sales_domain/WidgetManagerGroup';
```

All members of the `WidgetManagerGroup` in the `sales_domain` domain will be authorized with the database global role `widget_sales_role` when they log in to the database.

7.2.2.4 Exclusively Mapping an IAM User to an Oracle Database Global User

You can map an IAM user exclusively to an Oracle Database global user.

1. Log in to the Oracle DBaaS instance as a user who has been granted the `CREATE USER` or `ALTER USER` system privilege.
2. Run the `CREATE USER` or `ALTER USER` statement with the `IDENTIFIED GLOBALLY AS` clause specifying the IAM database user name.

By default, the IAM database user name is the same as the IAM user name, including the domain name. You can also create a unique IAM database user name for ease of authentication to the database. In your OCI IAM user profile, you can create a unique IAM database user name for ease of authentication to the database. This can be set when you

create and manage your IAM database password in your IAM profile. Adding or changing the IAM database user name will invalidate the IAM user to schema mapping, so the database schema will need to be remapped to the new IAM database user name.

For example, to create a new database global user named `peter_fitch` and map this user to an existing IAM user named with an IAM database user name of `peterfitch`, using the default domain:

```
CREATE USER peter_fitch IDENTIFIED GLOBALLY AS
'IAM_PRINCIPAL_NAME=peterfitch';
```

The following example shows how to create the user by specifying a non-default domain, `sales_domain`:

```
CREATE USER peter_fitch2 IDENTIFIED GLOBALLY AS
'IAM_PRINCIPAL_NAME=sales_domain/peterfitch';
```

7.2.2.5 Altering or Migrating an IAM User Mapping Definition

You can update an IAM user to a database global user mapping by using the `ALTER USER` statement.

You can update database schemas that were mapped to an IAM user, and whose accounts were created using any of the `CREATE USER` statement clauses: `IDENTIFIED BY password`, `IDENTIFIED EXTERNALLY`, or `IDENTIFIED GLOBALLY`. This is useful when migrating existing schemas to using IAM. If you delete and recreate an IAM user or an IAM group using the exact same name as the previous IAM user or group, then the existing mapping from the database that uses that IAM user or IAM group name will continue to work.

1. Log in to the Oracle DBaaS instance as a user who has been granted the `ALTER USER` system privilege.
2. Run the `ALTER USER` statement with the `IDENTIFIED GLOBALLY AS` clause.

For example, suppose you want to change the existing schema `shared_sales_schema` to a different IAM group:

```
ALTER USER shared_sales_schema IDENTIFIED GLOBALLY AS
'IAM_GROUP_NAME=BiggerWidgetSalesGroup';
```

The following example shows how to modify the schema by specifying a non-default domain, `sales_domain`:

```
ALTER USER shared_sales_schema IDENTIFIED GLOBALLY AS
'IAM_GROUP_NAME=sales_domain/BiggerWidgetSalesGroup';
```

7.2.2.6 Mapping Instance and Resource Principals

Applications can use instance principals and resource principals to retrieve database tokens and establish a connection to an Oracle DBaaS instance.

You can exclusively map instance principals and resource principals to a global schema (database user) or you can map them by using dynamic groups to a shared schema.

You can only use instance principal and resource principal OCIDs to map them exclusively or to a shared schema. Instance principal and resource principal dynamic groups can also be mapped to global roles.

Examples are as follows:

- Exclusive schema mapping using an instance principal (`ip_user`) and a resource principal (`rp_user`):

```
CREATE USER ip_user IDENTIFIED GLOBALLY AS
'IAM_PRINCIPAL_OCID=ocid1.instance.region1.sea.abcdef123456';
```

```
CREATE USER rp_user IDENTIFIED GLOBALLY AS
'IAM_PRINCIPAL_OCID=ocid1.dbsystem.oc1.sea.abcdef123456';
```

- Shared schema mapping using dynamic group:

```
CREATE USER iam_dg IDENTIFIED GLOBALLY AS 'IAM_GROUP_NAME=DB_Principals';
```

- Mapping to a global role;

```
CREATE ROLE app_role IDENTIFIED GLOBALLY AS
'IAM_GROUP_NAME=application_principals';
```

Related Topics

- [Managing Dynamic Groups](#)
- [Calling Services from an Instance](#)
- [Accessing Other Oracle Cloud Infrastructure Resources from Running Functions](#)

7.2.2.7 Verifying the IAM User Logon Information

After you configure and authorize an IAM user for the Oracle DBaaS instance, you can verify the user logon information by executing a set of SQL queries on the Oracle database side.

1. Log in to the Oracle DBaaS instance as an IAM user that you have just configured and authorized.

For example, to log in to the database instance `inst1` as the database global user `peterfitch`, who is using the default domain in IAM:

```
sqlplus /nolog
CONNECT "peterfitch"@inst1
Enter password: password
```

This example shows how to log in if user `peterfitch` is in a non-default domain, `sales_domain`:

```
sqlplus /nolog
CONNECT "sales_domain/peterfitch"@inst1
Enter password: password
```

2. Verify the mapped global user.

The mapped global user is the database user account that has the IAM user authorization. User `PETER_FITCH_SCHEMA` is considered a global user with exclusive mapping for the IAM user `peterfitch`, while user `WIDGET_SALES` is considered a global user with shared mapping for IAM group `widget_sales_group` of which `peterfitch` is a member.

```
SHOW USER;
```

Output similar to the following appears, depending on if it is an exclusive mapping or a shared mapping:

```
USER is "PETER_FITCH_SCHEMA"
```

Or

```
USER is "WIDGET_SALES"
```

- Find the roles that have been granted to the centrally managed user.

```
SELECT ROLE FROM SESSION_ROLES ORDER BY ROLE;
```

Output similar to the following appears:

```
ROLE
-----
WIDGET_SALES_ROLE
...
```

- Run the following queries to check the `SYS_CONTEXT` namespace values for the current schema being used in this database session, current user name, session user name, authentication method, authenticated identity, enterprise identity, identification type, and server type.
 - Verify the current schema that is being used in this database session. A database schema is an object container that identifies the objects it contains. The current schema is the default container for objects name resolution in this database session.

```
SELECT SYS_CONTEXT('USERENV', 'CURRENT_SCHEMA') FROM DUAL;
```

Output similar to the following appears, depending on if it is an exclusive mapping or a shared mapping:

```
SYS_CONTEXT('USERENV', 'CURRENT_SCHEMA')
-----
PETER_FITCH_SCHEMA
```

Or

```
SYS_CONTEXT('USERENV', 'CURRENT_SCHEMA')
-----
WIDGET_SALES
```

- Verify the current user. In this case, the current user is the same as the current schema.

```
SELECT SYS_CONTEXT('USERENV', 'CURRENT_USER') FROM DUAL;
```

Output similar to the following appears, depending on if it is an exclusive mapping or a shared mapping:

```
SYS_CONTEXT('USERENV', 'CURRENT_USER')
-----
PETER_FITCH_SCHEMA
```

Or

```
SYS_CONTEXT('USERENV', 'CURRENT_USER')
```

```
-----  
WIDGET_SALES
```

- Verify the session user.

```
SELECT SYS_CONTEXT('USERENV', 'SESSION_USER') FROM DUAL;
```

Output similar to the following appears, depending on if it is an exclusive mapping or a shared mapping:

```
SYS_CONTEXT('USERENV', 'SESSION_USER')
```

```
-----  
PETER_FITCH_SCHEMA
```

Or

```
SYS_CONTEXT('USERENV', 'SESSION_USER')
```

```
-----  
WIDGET_SALES
```

- Verify the authentication method.

```
SELECT SYS_CONTEXT('USERENV', 'AUTHENTICATION_METHOD') FROM DUAL;
```

Output similar to the following appears:

```
SYS_CONTEXT('USERENV', 'AUTHENTICATION_METHOD')
```

```
-----  
PASSWORD_GLOBAL
```

If the user is authenticating with a token, then the output is `TOKEN_GLOBAL`.

- Verify the authenticated identity for the enterprise user. The IAM authenticated user identity is captured and audited when this user logs on to the database.

```
SELECT SYS_CONTEXT('USERENV', 'AUTHENTICATED_IDENTITY') FROM DUAL;
```

Output similar to the following appears:

```
SYS_CONTEXT('USERENV', 'AUTHENTICATED_IDENTITY')
```

```
-----  
sales_domain/peterfitch
```

- If a user nickname has been set for the enterprise user, then verify this nickname.

```
SELECT SYS_CONTEXT('USERENV', 'USER_NICKNAME') FROM DUAL;
```

Output similar to the following appears:

```
SYS_CONTEXT('USERENV', 'USER_NICKNAME')
```

```
-----  
pfitch
```

- Verify the centrally managed user's enterprise identity.

```
SELECT SYS_CONTEXT('USERENV', 'ENTERPRISE_IDENTITY') FROM DUAL;
```

Enterprise Identity will show the OCI Identity (OCID) of the IAM user or OCI application. Output similar to the following appears:

```
SYS_CONTEXT('USERENV', 'ENTERPRISE_IDENTITY')
```

```
-----  
ocid1.user.region1..aaaaaaaaj7ot4g2sagkjt3enbg4ied3x554zwywurgm2232j4crm5zha
```

- Verify the identification type.

```
SELECT SYS_CONTEXT('USERENV', 'IDENTIFICATION_TYPE') FROM DUAL
```

Output similar to the following appears, depending on if it is an exclusive mapping or a shared mapping:

```
SYS_CONTEXT('USERENV', 'IDENTIFICATION_TYPE')
```

```
-----
GLOBAL EXCLUSIVE
```

Or

```
SYS_CONTEXT('USERENV', 'IDENTIFICATION_TYPE')
```

```
-----
GLOBAL SHARED
```

- Verify the server type.

```
SELECT SYS_CONTEXT('USERENV', 'LDAP_SERVER_TYPE') FROM DUAL;
```

Output similar to the following appears. In this case, the LDAP server type is IAM.

```
SYS_CONTEXT('USERENV', 'LDAP_SERVER_TYPE')
```

```
-----
OCI_IAM
```

7.2.3 Configuring IAM Proxy Authentication

Proxy authentication allows an IAM user to proxy to a database schema for tasks such as application maintenance.

- [About Configuring IAM Proxy Authentication](#)
IAM users can connect to Oracle DBaaS by using proxy authentication.
- [Configuring Proxy Authentication for the IAM User](#)
To configure proxy authentication for an IAM user, the IAM user must already have a mapping to a global schema (exclusive or shared mapping). A separate database schema for the IAM user to proxy to must also be available.
- [Validating the IAM User Proxy Authentication](#)
You can validate the IAM user proxy configuration for both password and token authentication methods.

7.2.3.1 About Configuring IAM Proxy Authentication

IAM users can connect to Oracle DBaaS by using proxy authentication.

Proxy authentication is typically used to authenticate the real user and then authorize them to use a database schema with the schema privileges and roles in order to manage an application. Alternatives such as sharing the application schema password are considered insecure and unable to audit which actual user performed an action.

A use case can be in an environment in which a named IAM user who is an application database administrator can authenticate by using their credentials and then proxy to a database schema user (for example, `hrapp`). This authentication enables the IAM administrator to use the `hrapp` privileges and roles as user `hrapp` in order to perform application maintenance, yet still use their IAM credentials for authentication. An application database administrator can sign in to the database and then proxy to an application schema to manage this schema.

You can configure proxy authentication for both the password authentication and token authentication methods.

7.2.3.2 Configuring Proxy Authentication for the IAM User

To configure proxy authentication for an IAM user, the IAM user must already have a mapping to a global schema (exclusive or shared mapping). A separate database schema for the IAM user to proxy to must also be available.

After you ensure that you have this type of user, alter the database user to allow the IAM user to proxy to it.

1. Log in to the Autonomous Database instance as a user who has the `ALTER USER` system privileges.
2. Grant permission for the IAM user to proxy to the local database user account.

An IAM user cannot be referenced in the command so the proxy must be created between the database global user (mapped to the IAM user) and the target database user.

In the following example, `hrapp` is the database schema to proxy to, and `peterfitch_schema` is the database global user exclusively mapped to user `peterfitch`.

```
ALTER USER hrapp GRANT CONNECT THROUGH peterfitch_schema;
```

At this stage, the IAM user can log in to the database instance using the proxy. For example, to connect using a password verifier:

```
CONNECT peterfitch[hrapp]@connect_string
Enter password: password
```

To connect using a token:

```
CONNECT [hrapp]/@connect_string
```

7.2.3.3 Validating the IAM User Proxy Authentication

You can validate the IAM user proxy configuration for both password and token authentication methods.

1. Log in to the Autonomous Database instance as a user who has the `CREATE USER` and `ALTER USER` system privileges.
2. Connect as the IAM user and run the `SHOW USER` and `SELECT SYS_CONTEXT` commands.

For example, suppose you want to check the proxy authentication of the IAM user `peterfitch` when they proxy to database user `hrapp`. Run the following queries after you proxy to the database using an IAM user. Depending on how you authenticate and access the database, you will get different values for these queries.

- For password authentication, assuming the IAM user is in the default domain:

```
CONNECT peterfitch[hrapp]/password\!@connect_string
SHOW USER;
--The output should be USER is "HRAPP"
SELECT SYS_CONTEXT('USERENV','AUTHENTICATION_METHOD') FROM DUAL;
--The output should be "PASSWORD_GLOBAL_PROXY"
SELECT SYS_CONTEXT('USERENV','PROXY_USER') FROM DUAL;
```

```
--The output should be "PETERFITCH_SCHEMA"
SELECT SYS_CONTEXT('USERENV','CURRENT_USER') FROM DUAL;
--The output should be "HRAPP"
```

- For token authentication, for a user who is in a non-default domain, `sales_domain`:

```
CONNECT [hrapp]/@connect_string
SHOW USER;
--The output should be USER is "HRAPP"
SELECT SYS_CONTEXT('USERENV','AUTHENTICATION_METHOD') FROM DUAL;
--The output should be "TOKEN_GLOBAL_PROXY"
SELECT SYS_CONTEXT('USERENV','PROXY_USER') FROM DUAL;
--The output should be "PETERFITCH_SCHEMA"
SELECT SYS_CONTEXT('USERENV','CURRENT_USER') FROM DUAL;
--The output should be "HRAPP"
```

7.3 Configuring IAM for Oracle DBaaS

To configure IAM to work with the Oracle DBaaS instance, an IAM administrator may need to create an IAM policy and have users create an IAM database password.

- [Creating an IAM Policy to Authorize Users Authenticating with Tokens](#)
To configure IAM to work with the Oracle DBaaS instance, an IAM administrator must create an IAM policy (if using IAM tokens), create IAM groups and manage group membership.
- [Creating an IAM Database Password](#)
The IAM database password, different from the Oracle Cloud Infrastructure (OCI) console password, and set by the IAM user, is required for the Oracle DBaaS password verification process.

7.3.1 Creating an IAM Policy to Authorize Users Authenticating with Tokens

To configure IAM to work with the Oracle DBaaS instance, an IAM administrator must create an IAM policy (if using IAM tokens), create IAM groups and manage group membership.

The IAM administrator should work with the database administrator to create the appropriate IAM groups for databases. Individual IAM users will need to create an IAM database password in their profile if they are using password verifiers.

You do not need to create a policy for users who are authenticating with password verifiers.

- Use the `allow group` command to create the policy. For example:

```
allow group DBUsers to use database-connections in tenancy
```

- To create a policy that limits members of `DBUsers` group to access DBaaS instances in compartment `testing_compartment` only

```
allow group DBUsers to use autonomous-database-family in compartment
testing_compartment
```

- To create a policy that limits group access to a single database in a compartment:

```
allow group DBUsers to use autonomous-database-family in compartment
testing_compartment where target.database.id =
'ocidl.autonomousdatabase.oc1.iad.aaaabbbbcccc'
```

Note the following:

- The `database-connections` resource type is included in the `autonomous-database-family` resource type. Either resource can be used, depending on your use case.
- The minimum verb to enable access to the database is `use`. You can also use the `manage` verb to enable access to the database.
- Dynamic group names are case sensitive when they are used in this policy. You must use the exact case for the dynamic group name when using it with this policy.

See [Oracle Cloud Infrastructure Documentation](#) for more information about the syntax of policy statements.

7.3.2 Creating an IAM Database Password

The IAM database password, different from the Oracle Cloud Infrastructure (OCI) console password, and set by the IAM user, is required for the Oracle DBaaS password verification process.

The set of allowed characters for the OCI IAM database password is similar to the set of allowed characters for the OCI console password except that the double quotation mark character is not allowed for the OCI IAM database password. See [Managing User Credentials](#) for information about creating an IAM database password.

1. Log in to the OCI console to your user page.
2. Access **My profile** or **User settings** (top right in the navigation toolbar) depending on the IAM version that you are using.
3. In your profile or settings, in the left, under Resources, click on the **Database Passwords** link.
4. Click the **Create Database Password** button.
5. Add a description and the password, ensuring that you apply the listed complexity rules.
6. Click **Create Database Password** to save the password.

After the password is created, its description and creation date are listed under Database Passwords.

7.4 Accessing the Database Using an Instance Principal or a Resource Principal

An Oracle Cloud Infrastructure (OCI) application or function can connect to the database instance using its own instance or resource principal.

You can map instance principals and resource principals exclusively to a database global schema or to a shared schema using a mapping to a dynamic group. When mapping instance

principals and resource principals exclusively to a database global schema, you must use the principal OCID. For example:

```
CREATE USER widget IDENTIFIED GLOBALLY
AS 'IAM_PRINCIPAL_OCID=ocid1.instance.region1.sea.1234567890abcdef';
```

When using shared schemas, you must add instance principals and resource principals to a dynamic group, and map the dynamic group to the shared schema.

Related Topics

- [Managing Dynamic Groups](#)
- [Calling Services from an Instance](#)
- [Accessing Other Oracle Cloud Infrastructure Resources from Running Functions](#)
- [Accessing the Oracle Cloud Infrastructure API Using Instance Principals](#)
- [Using Oracle Autonomous Database Serverless](#)

7.5 Configuring the Database Client Connection

Configuring the IAM client connection controls the authentication of IAM users to the Oracle DBaaS instance.

- [About Connecting to an Autonomous Database Instance Using IAM](#)
IAM users can connect to the Autonomous Database instance by using either an IAM database password verifier or an IAM token.
- [Supported Client Drivers for IAM Connections](#)
Oracle DBaaS supports several types of client drivers for IAM connections.
- [Using Centralized Oracle Cloud Infrastructure Services for Net Naming and Secrets](#)
You can use the Oracle Cloud Infrastructure (OCI) object store and vault to centrally store net names and secrets.
- [Client Connections That Use an IAM Database Password Verifier](#)
After you have configured the authorization needed for the IAM user, this user can log in using existing client application, such as SQL*Plus or SQLcl without additional configuration.
- [Client Connections That Use a Token Requested by an IAM User Name and Database Password](#)
You can create a client connection that uses a token requested by an IAM user name and database password.
- [Client Connections That Use a Token Requested by a Client Application or Tool](#)
For IAM token access to the Autonomous Database, the client application or tool requests a database token from IAM for the IAM user.
- [TLS Connections without Client Wallets](#)
The use of Transport Layer Security (TLS) connections without client wallets is supported for IAM connections.
- [Enabling Clients to Directly Retrieve IAM Tokens](#)
You can set parameters to enable clients to directly retrieve IAM tokens on their own.
- [Common Database Client Configurations](#)
IAM users can connect to the Oracle DBaaS instance using client tools such as SQLcl on a laptop.

- [Using OCI Object Store for Network Service Configuration Information](#)
You can store connect string and other network configuration information in the OCI Object Store.

7.5.1 About Connecting to an Autonomous Database Instance Using IAM

IAM users can connect to the Autonomous Database instance by using either an IAM database password verifier or an IAM token.

Using the IAM database password verifier is similar to the Oracle Database password authentication process. However, instead of the password verifier (encrypted hash of the password) being stored in the Oracle database, the verifier is instead stored as part of the Oracle Cloud Infrastructure (OCI) IAM user profile.

The second connection method, the use of an IAM token for the database, is more modern. The use of token-based access is a better fit for Cloud resources such as Autonomous Database. The token is based on the strength that the IAM endpoint can enforce. This can be multi-factor authentication, which is stronger than the use of passwords alone. Another benefit of using tokens is that the password verifier (which is considered sensitive) is never stored or available in memory. A TCPS (TLS) connection is required when using tokens for database access.



Note:

You cannot configure native network encryption when passing an IAM token. Only Transport Layer Security (TLS) by itself is supported, not native network encryption or native network encryption with TLS.

7.5.2 Supported Client Drivers for IAM Connections

Oracle DBaaS supports several types of client drivers for IAM connections.

IAM database password verifiers work with any supported database client. Using IAM tokens requires the latest Oracle Database client 19c (at least 19.16). Some earlier clients (19c and 21c) provide a limited set of capabilities for token access. Oracle Database client 21c does not fully support the IAM token access feature. Oracle Database client 23ai supports the IAM token access feature.

7.5.3 Using Centralized Oracle Cloud Infrastructure Services for Net Naming and Secrets

You can use the Oracle Cloud Infrastructure (OCI) object store and vault to centrally store net names and secrets.

This functionality is currently supported with the JDBC-thin and .NET-thin drivers.

See the following guides:

- *Oracle Database Net Services Administrator's Guide*
- *Oracle Database Net Services Reference*

7.5.4 Client Connections That Use an IAM Database Password Verifier

After you have configured the authorization needed for the IAM user, this user can log in using existing client application, such as SQL*Plus or SQLcl without additional configuration.

The IAM user enters the IAM user name and IAM database password (not the Oracle Cloud Infrastructure (OCI) console password) using any currently supported database client. The only constraint is that the database client version be either Oracle Database release 12.1.0.2 or later to use Oracle Database 12c passwords. The database client must be able to use the 12C password verifier. Using the 11G verifier encryption is not supported with IAM. No special client or tool configuration is needed for the IAM user to connect to the OCI DBaaS instance.

7.5.5 Client Connections That Use a Token Requested by an IAM User Name and Database Password

You can create a client connection that uses a token requested by an IAM user name and database password.

- [About Client Connections That Use a Token Requested by an IAM User Name and Database Password](#)
IAM users can connect to the Oracle DBaaS instance by using an IAM token that was retrieved using an IAM user name and IAM database password.
- [Parameters to Set for Client Connections That Use a Token Requested by an IAM User Name and Database Password](#)
To set these parameters, you modify either the `sqlnet.ora` file or the `tnsnames.ora` file.
- [Configuring the Database Client to Retrieve a Token Using an IAM User Name and Database Password](#)
You can configure the database client to retrieve the IAM database token using the provided IAM user name and IAM database password.
- [Configuring a Secure External Password Store Wallet to Retrieve an IAM Token](#)
You can enable an IAM user name and a secure external password store (SEPS) to request the IAM database token.

7.5.5.1 About Client Connections That Use a Token Requested by an IAM User Name and Database Password

IAM users can connect to the Oracle DBaaS instance by using an IAM token that was retrieved using an IAM user name and IAM database password.

In both cases, the token is retrieved by using a database password, either by using SQL*Plus or through a SEPS.

In previous releases, you could only use the IAM user name and database password to get a password verifier from IAM. Getting a token with these credentials is more secure than getting a password verifier because a password verifier is considered sensitive. Using a token means that you do not need to pass or use the verifier. Applications cannot pass a token that was retrieved by the IAM user name and password through the database client API. Only the database client can retrieve this type of token. A database client can only retrieve a database token using the IAM user name and IAM database password.

You can enter the IAM username and IAM database password directly into the tool or use a SEPS wallet to hold these credentials securely.

7.5.5.2 Parameters to Set for Client Connections That Use a Token Requested by an IAM User Name and Database Password

To set these parameters, you modify either the `sqlnet.ora` file or the `tnsnames.ora` file.

Token-Specific Parameters for IAM User Name and Database Password Token Requests

- **PASSWORD_AUTH Parameter**

Sets the authentication method. This configuration must use a setting of `OCI_TOKEN`. Getting a token using the user and password credentials is more secure than using a password verifier, since a password verifier is considered sensitive. This parameter is required for retrieving the IAM bearer token with an IAM user name and database password.

Syntax:

```
PASSWORD_AUTH=authentication_method
```

Example:

```
PASSWORD_AUTH=OCI_TOKEN
```

- **OCI_IAM_URL Parameter**

Specifies the IAM URL that the database client must connect with to get the database token. This parameter is required for retrieving the IAM bearer token with an IAM user name and database password. This setting is specific to your region. See [Identity and Access Management Data Plane API](#) for the appropriate URL for your region. Then append `/v1/actions/generateScopedAccessBearerToken` to the regional URL.

Syntax:

```
OCI_IAM_URL=authentication_regional_endpoint.com/v1/actions/generateScopedAccessBearerToken
```

Example:

The following example uses the Phoenix URL (`https://auth.us-phoenix-1.oraclecloud.com`):

```
https://auth.us-phoenix-1.oraclecloud.com/v1/actions/generateScopedAccessBearerToken
```

- **OCI_TENANCY Parameter**

Specifies the OCID of the user's tenancy. You can find this setting under the user's icon at the top right of the OCI console. This parameter is required for retrieving the IAM bearer token with an IAM user name and database password.

Syntax:

```
OCI_TENANCY=tenancy_OCI..OCID
```

Example:

```
OCI_TENANCY=ocid1.tenancy.region1..12345
```

- **OCI_COMPARTMENT Parameter**

Specifies the scope of the database token request. Note that there are two periods after *region_name*. The token will only be usable for databases in the specified compartment. If you omit this value, then the entire tenancy is the scope of the request. This parameter is optional, except if `OCI_DATABASE` is set.

Syntax:

```
OCI_COMPARTMENT=compartment_OCID
```

Example:

```
OCI_COMPARTMENT=ocid1.compartment.region1..12345
```

- **OCI_DATABASE Parameter**

Specifies the OCID of the database to access. This parameter limits the token to the database only. This parameter is optional.

Syntax:

```
OCI_DATABASE=database_OCID
```

Example:

```
OCI_DATABASE=ocid1.autonomousdatabase.oc1.iad.12345
```

DN-Specific Parameters for IAM User Name and Database Password Token Requests

- **SSL_SERVER_CERT_DN Parameter**

Specifies the distinguished name (DN) of the database server for this client. (Note that this parameter is not specific to the bearer tokens.)

Syntax:

```
SSL_SERVER_CERT_DN=DN
```

Example:

```
SSL_SERVER_CERT_DN="C=US,O=ExampleCorporation,CN=sslserver2"
```

- **SSL_SERVER_DN_MATCH Parameter**

Enforces server-side validation through DN matching. Set this parameter to `TRUE`.

Syntax:

```
SSL_SERVER_DN_MATCH=TRUE|FALSE
```

Example:

```
SSL_SERVER_DN_MATCH=TRUE
```

sqlnet.ora Example

```
PASSWORD_AUTH=OCI_TOKEN
OCI_IAM_URL=https://auth.region1.example.com/v1/actions/
generateScopedAccessBearerToken
OCI_TENANCY=ocid1.tenancy..12345
OCI_COMPARTMENT=ocid1.compartment.region1..12345
OCI_DATABASE=ocid1.autonomousdatabase.oc1.iad.12345
SSL_SERVER_CERT_DN="C=US,O=ExampleCorporation,CN=sslserver2"
SSL_SERVER_DN_MATCH=TRUE
```

tnsnames.ora Example

```
db_connection=
  (DESCRIPTION=
    (ADDRESS=(PROTOCOL=tcps) (HOST=sales1-svr) (PORT=5678))
    (SECURITY=
      (PASSWORD_AUTH=OCI_TOKEN)
      (OCI_IAM_URL=https://auth.region1.example.com/v1/actions/
generateScopedAccessBearerToken)
      (OCI_TENANCY=ocid1.tenancy..12345)
      (OCI_COMPARTMENT=ocid1.compartment.region1..12345)
      (OCI_DATABASE=ocid1.autonomousdatabase.oc1.iad.12345)
      (SSL_SERVER_CERT_DN="C=US,O=ExampleCorporation,CN=sslserver2")
      (SSL_SERVER_DN_MATCH=TRUE))
    (CONNECT_DATA=(SERVICE_NAME=sales.us.example.com)))
```

In this specification:

- (PROTOCOL=tcps) sets the protocol to TCPS. You must use TCPS as the protocol or the connection will fail. TCPS must be enabled when passing tokens from the database client to the server.
- SECURITY is where you set the authentication and DN parameters.

7.5.5.3 Configuring the Database Client to Retrieve a Token Using an IAM User Name and Database Password

You can configure the database client to retrieve the IAM database token using the provided IAM user name and IAM database password.

1. Log in to the Oracle DBaaS client.
2. Set the appropriate parameters to retrieve a token that will be requested by an IAM user name and database password.
3. In the `sqlnet.ora` file, set the `WALLET_LOCATION` parameter to the location of the client. The root certificates will reside in this directory.

For example:

```
WALLET_LOCATION =  
  (SOURCE=  
    (METHOD=FILE)  
    (METHOD_DATA=  
      DIRECTORY=/ora_db/wallet)
```

Related Topics

- [Parameters to Set for Client Connections That Use a Token Requested by an IAM User Name and Database Password](#)
To set these parameters, you modify either the `sqlnet.ora` file or the `tnsnames.ora` file.

7.5.5.4 Configuring a Secure External Password Store Wallet to Retrieve an IAM Token

You can enable an IAM user name and a secure external password store (SEPS) to request the IAM database token.

1. Log in to the Oracle DBaaS client.
2. Configure this client to use the secure external password store.
3. Set the appropriate parameters to retrieve a token that will be requested by an IAM user name and database password.

Related Topics

- [Configuring a Client to Use the Secure External Password Store](#)
You can configure a client to use the secure external password store feature by using the `mkstore` command-line utility.
- [Parameters to Set for Client Connections That Use a Token Requested by an IAM User Name and Database Password](#)
To set these parameters, you modify either the `sqlnet.ora` file or the `tnsnames.ora` file.

7.5.6 Client Connections That Use a Token Requested by a Client Application or Tool

For IAM token access to the Autonomous Database, the client application or tool requests a database token from IAM for the IAM user.

The client application will pass the database token directly to the database client through the database client API.

If the application or tool has not been updated to request an IAM token, then the IAM user can use Oracle Cloud Infrastructure (OCI) command line interface (CLI) to request and store the database token. You can request a database access token (`db-token`) using the following credentials:

- Security tokens (with IAM authentication), delegation tokens (in the OCI cloud shell) and `API-keys`, which are credentials that represent the IAM user to enable the authentication
- Instance principal tokens, which enable instances to be authorized actors (or principals) to perform actions on service resources after authenticating

- Resource principal token, which is a credential that enables the application to authenticate itself to other Oracle Cloud Infrastructure services
- Using an IAM user name and IAM database password (can only be requested by database client).

When the IAM users logs into the client with a slash / login and the `OCI_IAM` parameter is configured (`sqlnet.ora`, `tnsnames.ora`, or as part of a connect string), then the database client retrieves the database token from a file. If the IAM user submits a user name and password, the connection will use the IAM database verifier access described for client connections that use IAM database password verifiers. The instructions in this guide show how to use the OCI CLI as a helper for the database token. If the application or tool has been updated to work with IAM, then follow the instructions for the application or tool. Some common use cases include the following: SQLPlus on-premises, SQLcl on-premises, SQL*Plus in Cloud Shell, or applications that use SEP wallets.

Related Topics

- [Client Connections That Use an IAM Database Password Verifier](#)
After you have configured the authorization needed for the IAM user, this user can log in using existing client application, such as SQL*Plus or SQLcl without additional configuration.

7.5.7 TLS Connections without Client Wallets

The use of Transport Layer Security (TLS) connections without client wallets is supported for IAM connections.

Before you configure this type of connection, ensure that the Oracle DBaaS environment meets the requirements.

Related Topics

- [Configuring TLS Using a Public Certificate Authority Root of Trust for the Database Server Certificate](#)
Before you can configure TLS without using client wallets, you must first create the server wallet and ensure that the database and listener are properly configured.

7.5.8 Enabling Clients to Directly Retrieve IAM Tokens

You can set parameters to enable clients to directly retrieve IAM tokens on their own.

This feature is available in environments that use JDBC-thin clients, ODP.NET Core classes, or ODP.NET Managed Driver classes. It enables the client to display a dialog box to prompt for the user's authentication. To enable this feature, you must set the following parameters in either the client's `sqlnet.ora` file or in a connect string. The connect string takes precedence over `sqlnet.ora`.

Table 7-1 Parameters to Directly Retrieve Tokens

Parameter	Description
<code>OCI_INTERACTIVE</code> setting in <code>TOKEN_AUTH</code>	Set this to <code>OCI_INTERACTIVE</code> to signal the database client to retrieve the db-token directly from OCI IAM. <code>TOKEN_AUTH=OCI_INTERACTIVE</code>

Table 7-1 (Cont.) Parameters to Directly Retrieve Tokens

Parameter	Description
OCI_CONFIG_FILE	Specifies the location of the Oracle Cloud Infrastructure (OCI) configuration file that contains the user's client connection information. If you do not set this parameter, then Oracle Database searches for this configuration file in <code>C:/user_profile/.oci/config</code> . If the configuration file is not in that location, then Oracle Database prompts the user for a region ID, presenting a list of region IDs from which the user can choose.
OCI_PROFILE	Specifies the default user profile that is set in the OCI configuration file.

7.5.9 Common Database Client Configurations

IAM users can connect to the Oracle DBaaS instance using client tools such as SQLcl on a laptop.

- [Configuring a Client Connection for SQL*Plus That Uses an IAM Database Password](#)
You can configure SQL*Plus to use an IAM database password.
- [Configuring a Client Connection for SQL*Plus That Uses an IAM Token](#)
You can configure a client connection for SQL*Plus that uses an IAM token.

7.5.9.1 Configuring a Client Connection for SQL*Plus That Uses an IAM Database Password

You can configure SQL*Plus to use an IAM database password.

- As the IAM user, log in to the Autonomous Database instance by using the following syntax:

```
CONNECT user_name@db_connect_string
Enter password: password
```

In this specification, *user_name* is the IAM user name. There is a limit of 128 bytes for the combined *domain_name/user_name*.

The following example shows how IAM user `peter_fitch` can log in to an Autonomous Database instance.

```
sqlplus /nolog
connect peter_fitch@db_connect_string
Enter password: password
```

Some special characters will require double quotation marks around `user_name` and `password`. For example:

```
"peter_fitch@example.com"@db_connect_string  
"IAM database password"
```

7.5.9.2 Configuring a Client Connection for SQL*Plus That Uses an IAM Token

You can configure a client connection for SQL*Plus that uses an IAM token.

1. Ensure you have an IAM user account.
2. Check with an IAM administrator and an Oracle Database administrator to ensure you have a policy allowing you to access the database in the compartment or your tenancy and that you are mapped to a global schema in the database.
3. If your application or tool does not support direct IAM integration, then download, install, and configure the OCI CLI. (See [OCI Command Line Interface Quickstart](#).) Set up an API key as part of the OCI CLI configuration and select default values.

a. Set up the API key access for the IAM user.

b. Retrieve the `db-token`. For example:

- Retrieving a `db-token` with an `API-key` using the Oracle Cloud Infrastructure (OCI) command-line interface:

```
oci iam db-token get
```

- Retrieving a `db-token` with a security (or session) token:

```
oci iam db-token get --auth security_token
```

If the security token has expired, a window will appear so the user can log in to OCI again. This generates the security token for the user. OCI CLI will use this refreshed token to get the `db-token`.

- Retrieving a `db-token` with a delegation token: When you log in to the cloud shell, the delegation token is automatically generated and placed in the `/etc` directory. To get this token, run the following command in the cloud shell:

```
oci iam db-token get
```

- Retrieving an instance token by using the OCI command-line interface:

```
oci iam db-token get --auth instance_principal
```

c. The database client can also be configured to retrieve a database token using the IAM username and IAM database password.

See [Client Connections That Use a Token Requested by an IAM User Name and Database Password](#) for more information.

See [Required Keys and OCIDs](#) for more information.

4. Ensure that you are using the latest release updates for the Oracle Database client releases 19c, 21c, or 23ai.

This configuration only works with the Oracle Database client release 19c, 21c, or 23ai.

5. Follow the existing process to download the wallet from the Autonomous Database and then follow the directions for configuring it for use with SQL*Plus.
 - a. Confirm that DN matching is enabled by looking for `SSL_SERVER_DN_MATCH=ON` in `sqlnet.ora`.
 - b. Configure the database client to use the IAM token by adding `TOKEN_AUTH=OCI_TOKEN` to the `sqlnet.ora` file. Because you will be using the default locations for the database token file, you do not need to include the token location.

The `TOKEN_AUTH` and `TOKEN_LOCATION` values in the `tnsnames.ora` connect strings take precedence over the `sqlnet.ora` settings for that connection. For example, for the connect string, assuming that the token is in the default location (`~/oci/db-token` for Linux):

```
(description=
  (retry_count=20) (retry_delay=3)
  (address=(protocol=tcps) (port=1522)
  (host=example.us-phoenix-1.oraclecloud.com)

  (connect_data=(service_name=aaabbbccc_exampledb_high.example.oraclecloud.com)
  (security=(ssl_server_dn_match=yes)
  (TOKEN_AUTH=OCI_TOKEN)))
```

After the connect string is updated with the `TOKEN_AUTH` parameter, the IAM user can log in to the Autonomous Database instance by running the following command to start SQL*Plus. You can include the connect descriptor itself or use the name of the descriptor from the `tnsnames.ora` file.

```
connect /@exampledb_high
```

Or:

```
connect /@(description=
  (retry_count=20) (retry_delay=3)
  (address=(protocol=tcps) (port=1522)
  (host=example.us-phoenix-1.oraclecloud.com)

  (connect_data=(service_name=aaabbbccc_exampledb_high.example.oraclecloud.com)
  (security=(ssl_server_cert_dn="CN=example.uscom-east-1.oraclecloud.com,
  O=Example Corporation,
  L=Redwood City, ST=California, C=US")
  (TOKEN_AUTH=OCI_TOKEN)))
```

The database client is already configured to get a `db-token` because `TOKEN_AUTH` has already been set, either through the `sqlnet.ora` file or in a connect string. The database client gets the `db-token` and signs it using the private key and then sends the token to the Autonomous Database. If an IAM user name and IAM database password are specified instead of slash `/`, then the database client will connect using the password instead of using the `db-token`.

7.5.10 Using OCI Object Store for Network Service Configuration Information

You can store connect string and other network configuration information in the OCI Object Store.

See [OCI Object Storage JSON File](#) in the *Oracle Database Net Services Administrator's Guide* for more information.

7.6 Accessing a Database Cross-Tenancy Using an IAM Integration

Users and groups in one tenancy can access DBaaS database instances in another tenancy if policies in both tenancies allow this.

- [About Cross-Tenancy Access for IAM Users to DBaaS Instances](#)
Cross-tenancy access to an Oracle Cloud Infrastructure (OCI) DBaaS instance is similar to a single tenancy scenario except that tenancy information is required for mappings and token requests and a policy is required in both tenancies to allow this cross tenancy database resource access.
- [Configuring Policies](#)
You must create policies in both the user tenancy and the database resource tenancy to allow cross-tenancy database access.
- [Mapping Database Schemas and Roles to Users and Groups in Another Tenancy](#)
When you perform this type of mapping, you must add the tenancy OCID to the mapping information so the database knows it is cross-tenancy access.
- [Configuring Database Clients for Cross-Tenancy Access](#)
You can configure some database clients directly.
- [Requesting Cross-Tenancy Tokens Using the OCI Command-Line Interface](#)
You must add the `--scope` parameter to the Oracle Cloud Infrastructure (OCI) command-line interface command to get a `db-token` for a cross-tenancy request. If the database you are accessing is in a different region than the user tenancy home region, then the region must also be added to the OCI CLI command using the `--region` parameter.

7.6.1 About Cross-Tenancy Access for IAM Users to DBaaS Instances

Cross-tenancy access to an Oracle Cloud Infrastructure (OCI) DBaaS instance is similar to a single tenancy scenario except that tenancy information is required for mappings and token requests and a policy is required in both tenancies to allow this cross tenancy database resource access.

The following figure illustrates the process for a cross-tenancy access to an OCI DBaaS instance.

Figure 7-4 Cross-Tenancy Access to an OCI DBaaS Instance

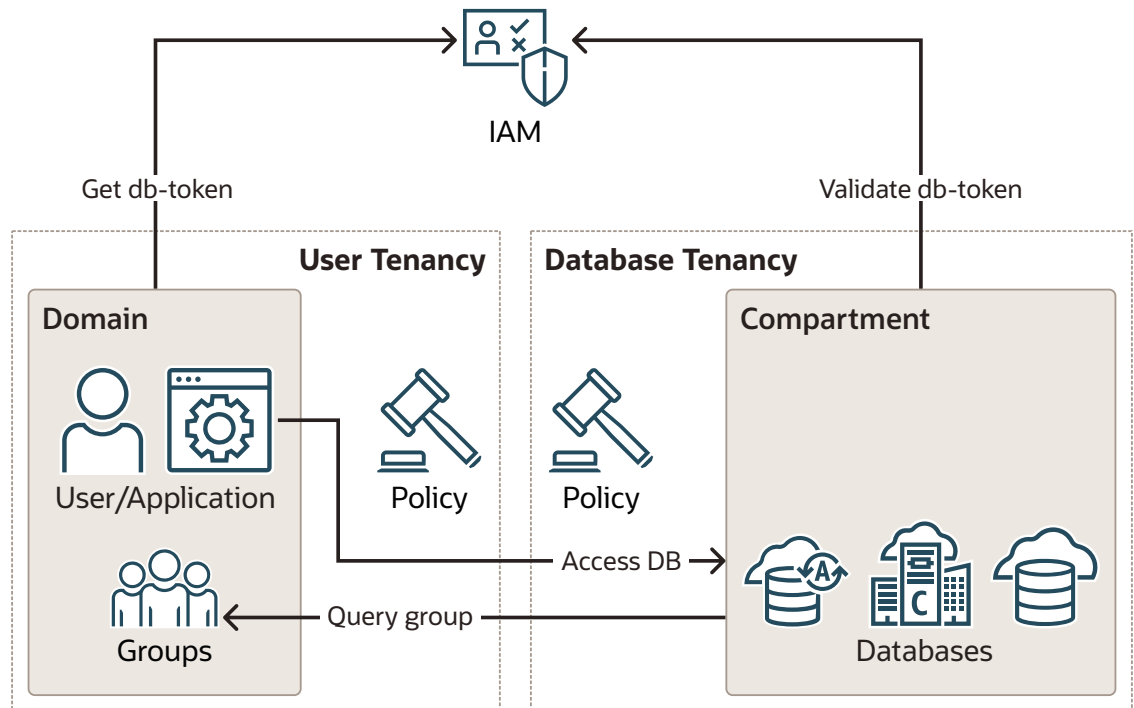

The cross-tenancy process is as follows:

1. The policy is required in both tenancies to endorse and admit access cross tenancy.
2. The IAM principal (user or application) requests a db-token for a cross-tenancy resource.
3. The db-token is returned and is used to access the database in a different tenancy
4. The database will make a cross-tenancy group query for the user's groups and map principal to global schema and optional global roles.

You must subscribe the user tenancy to the same regions in which the databases are located. For example, if the databases in the database tenancy are in the PHX and IAD regions, then you must subscribe the user tenancy to these regions. This is not the home region, just the additional subscribed regions in the user tenancy.

7.6.2 Configuring Policies

You must create policies in both the user tenancy and the database resource tenancy to allow cross-tenancy database access.

- [Configuring the Source User Tenancy](#)
Two policies are required to allow cross-tenancy access in the user tenancy.
- [Configuring the Target Database Resource Tenancy](#)
The database tenancy will need matching policies to enable access to the users from the user tenancy as well as allow its own databases to query group information in the user tenancy
- [Policy Examples for Cross-Tenancy Access](#)
Examples include using a WHERE clause to refine the cross-tenancy configuration, and other methods of performing this type of configuration.

7.6.2.1 Configuring the Source User Tenancy

Two policies are required to allow cross-tenancy access in the user tenancy.

The first policy is to allow a user tenancy group to access a database in a different tenancy. The second policy allows a database in the database tenancy to query group information in the user tenancy.

1. In the OCI console, select **Identity & Security**.
2. Under **Identity**, select **Policies**.
3. Click **Create Policy** and in the Policy Builder select **Show manual editor**.
4. Use the `DEFINE` statement to make it easier to read the actual policies.

For example:

```
DEFINE tenancy database_tenancy as ocid1.tenancy.OCID
```

5. Endorse the tenancy group `domainA/xt_db_users` to use `database_connections` in tenancy `database_tenancy`.

This allows users of the `xt_db_users` group in `domainA` to access any database in tenancy `database_tenancy`.

```
ENDORSE group domainA/xt_db_users to use database-connections in tenancy database_tenancy
```

6. Use the `ADMIT` statement to create an Admit policy to allow any database in the database tenancy to query group information for specific IAM users in the user tenancy.

```
ADMIT any-user of tenancy database_tenancy to {GROUP_MEMBERSHIP_INSPECT, AUTHENTICATION_INSPECT} in tenancy
```

7.6.2.2 Configuring the Target Database Resource Tenancy

The database tenancy will need matching policies to enable access to the users from the user tenancy as well as allow its own databases to query group information in the user tenancy

1. In the OCI console, select **Identity & Security**.
2. Under **Identity**, select **Policies**.
3. Click **Create Policy** and in the Policy Builder select **Show manual editor**.
4. Use `DEFINE` to make it easier to troubleshoot and read the policies.

```
DEFINE tenancy user_tenancy as ocid1.tenancy.OCID  
DEFINE group xt_db_users as ocid1.group.defg
```

5. Use `ADMIT` to create an Admit policy in the tenancy to match the Endorse policy from the user tenancy.

The Admit policy must match the `ENDORSE` policy in the user tenancy so that it can enable users from the `user_tenancy` to access databases in this tenancy.

```
ADMIT group xt_db_users of tenancy user_tenancy to use database-connections in tenancy
```

6. Create an Endorse policy, which will match the Admit policy created in the User tenancy.

The Endorse policy will enable databases in the database tenancy to query group information from the `user_tenancy`.

```
ENDORSE any-user to {GROUP_MEMBERSHIP_INSPECT, AUTHENTICATION_INSPECT} in tenancy user_tenancy
```

While using `any-user` makes it easy to understand the required policies, Oracle recommends that you use stronger constraints in addition to or instead of using `any-user`. The `any-user` option will allow any principal or resource to query user groups in the `user_tenancy`. Ideally, you should limit this to just allowing the database resources (resource principals) to make the group queries. You can do this by adding a `WHERE` clause to the policies or by adding a dynamic group that limits it to the members of the dynamic group. Defining every possible way to specify dynamic groups and policies is outside the scope of this topic. You can find more information from these sources:

- [Managing Dynamic Groups](#)
- [Managing Policies](#)

7.6.2.3 Policy Examples for Cross-Tenancy Access

Examples include using a `WHERE` clause to refine the cross-tenancy configuration, and other methods of performing this type of configuration.

You can add a `WHERE` clause to limit the database resources allowed to make the cross-tenancy group query:

```
ADMIT any-user of tenancy db_tenancy to {GROUP_MEMBERSHIP_INSPECT, AUTHENTICATION_INSPECT} in tenancy where request.principal.type = 'dbsystem'
```

This Admit policy allows any Base Database Service (resource type: `dbsystem`) in the `db_tenancy` to query a user's group information from the user tenancy. Resource type names are in the table below.

A similar method can be done by putting the same resource type into a dynamic group:

```
dynamic group: db_principals
any {resource.type = 'dbsystem', resource.type = 'vmcluster', resource.type = 'cloudvmcluster'}
```

The dynamic group in the preceding example includes database instances for Oracle Base Database Service (`dbsystem`), Oracle Exadata Cloud@Customer (`vmcluster`), and Oracle Exadata Database Service (`cloudvmcluster`).

This example uses a dynamic group instead of `any-user`:

```
ADMIT dynamic group db_principals of tenancy db_tenancy to
{GROUP_MEMBERSHIP_INSPECT, AUTHENTICATION_INSPECT} in tenancy
```

You can also add all resource principals in a compartment using `resource.compartment.id`. However, this might also allow other non-database resource principals to make the cross-tenancy group query. The following table provides a mapping of the various resource types with the DBaaS platform name:

DBaaS Platform Name	Resource Type Name
ADB-S	autonomousdatabase
ADB-D (OPC)	cloudautonomousvmcluster*
Base DBS	dbssystem
ExaCS	cloudvmcluster
ExaCC	vmcluster

* Older ADBD instances may still be using the `autonomousexainfrastructure` resource type.

7.6.3 Mapping Database Schemas and Roles to Users and Groups in Another Tenancy

When you perform this type of mapping, you must add the tenancy OCID to the mapping information so the database knows it is cross-tenancy access.

Use a full colon to separate the tenancy OCID when you use the `CREATE USER` and `CREATE ROLE` statements in SQL*Plus.

- To use the `CREATE USER` statement to perform the mapping:

The following examples show exclusive and shared schema mapping with principals and groups in default and non-default domains. When using default domains, you do not need to include a domain name.

```
CREATE USER schema1 IDENTIFIED GLOBALLY
AS 'IAM_PRINCIPAL_NAME=ocid1.tenancy.OCID:example_domain/
peter.fitch@oracle.com';
```

```
CREATE USER schema2 IDENTIFIED GLOBALLY
AS 'IAM_PRINCIPAL_NAME=ocid1.tenancy.OCID:peter.fitch@oracle.com';
```

```
CREATE USER qa_db_user_group IDENTIFIED GLOBALLY
AS 'IAM_GROUP_NAME=ocid1.tenancy.OCID:example_domain/xt_db_users';
```

```
CREATE USER qa_sales_user_group IDENTIFIED GLOBALLY
AS 'IAM_GROUP_NAME=ocid1.tenancy.OCID:sales_users';
```

```
CREATE USER xt_ip_user IDENTIFIED GLOBALLY
AS 'IAM_PRINCIPAL_OCID=ocid1.instance.region1.sea.OCID';
GRANT CREATE SESSION TO xt_ip_user;
```

```
CREATE USER xt_iam_dg IDENTIFIED GLOBALLY
```

```
AS 'IAM_GROUP_NAME=ocidl.tenancy.region1.OCID:sales_principals';
GRANT CREATE SESSION TO xt_iam_dg;
```

- To use the `CREATE ROLE` statement to perform the mapping:

The following examples show global role mapping with groups in default and non-default domains. When using default domains, you do not need to include a domain name.

```
CREATE ROLE globalrole1 IDENTIFIED GLOBALLY
AS 'IAM_GROUP_NAME=ocidl.tenancy.abcdef:example_domain/xt_db_users';

CREATE ROLE globalrole2 IDENTIFIED GLOBALLY
AS 'IAM_GROUP_NAME=ocidl.tenancy.abcdef:sales_users';
```

7.6.4 Configuring Database Clients for Cross-Tenancy Access

You can configure some database clients directly.

The database tenancy must be identified in either the connect string or in `sqlnet.ora` if the client is configured to directly get the access token from OCI IAM. Review client-specific documentation for specific parameter values (JDBC-thin, ODP.NET-core, managed).

7.6.5 Requesting Cross-Tenancy Tokens Using the OCI Command-Line Interface

You must add the `--scope` parameter to the Oracle Cloud Infrastructure (OCI) command-line interface command to get a `db-token` for a cross-tenancy request. If the database you are accessing is in a different region than the user tenancy home region, then the region must also be added to the OCI CLI command using the `--region` parameter.

See [Optional Parameters](#) for more details about using the optional parameters of the `oci get` command.

You can scope it for the entire tenancy or scope it to a compartment or database in the tenancy. When scoping for cross tenancy compartment or database, you do not need to also add the tenancy information because the compartment and database OCIDs are unique across OCI.

Certain clients can request the tokens directly from MSEI. Refer to their documentation on setting the parameters to get the MSEI `OAuth2` access tokens.

7.7 Database Links in an Oracle DBaaS-to-IAM Integration

The use of database links when accessing the Oracle DBaaS database using IAM credentials is supported.

The method of configuring database links for Oracle DBaaS connections to IAM depends on the Oracle DBaaS platform. Review the topic below that corresponds to your Oracle DBaaS platform and then click on the associated link for more information.

- **Oracle Autonomous Database Serverless:** You can use fixed user database links in which a database user is used for the fixed database link. The database user for creating the database link can only use password authentication with the database link. The IAM user can authenticate to the source database using either password or token access. You

cannot configure IAM users as fixed database links, nor can you use connected or current user database links. See *Using Oracle Autonomous Database Serverless*

- **Oracle Autonomous Database on Dedicated Exadata Infrastructure and all non-Autonomous Database DBaaS platforms:** You can use connected user and fixed user database links, but not current user database links. For connected user database links, an IAM user must be provisioned to both the source and target link databases. You can use a database password verifier or an IAM database token to connect and use connected user database links. For a fixed user database link, a user can connect to the target database using a target database user with password authentication. In addition, an IAM user can connect to the first PDB by using an IAM user name and password or an IAM token. See *Using Oracle Autonomous Database on Dedicated Exadata Infrastructure*

7.8 Troubleshooting IAM Connections

The `ORA-01017: invalid username/password; logon denied` error can be caused by several different issues throughout the Oracle DBaaS integration with Identity and Access Management (IAM).

- [Areas to Check on the Client-Side for ORA-01017 Errors](#)
Client-side `ORA-01017` errors can result from problems with IAM credentials, client configuration, or problems with the IAM profile.
- [Database Client Trace Files](#)
You can generate two levels of trace files to troubleshoot IAM connections on client side.
- [Check in the Oracle Cloud Infrastructure IAM and the Oracle Database for ORA-01017 Errors](#)
`ORA-01017` errors in the Oracle Database instance can arise from the way that the database was enabled to work with IAM.
- [ORA-01017 Errors Caused by Improperly Configured IAM Users](#)
Several `ORA-01017` errors can arise from improperly configured IAM users.
- [ORA-12599 and ORA-03114 Errors Caused When Trying to Access a Database Using a Token](#)
The `ORA-12599: TNS: cryptographic checksum mismatch` and `ORA-03114: not connected to ORACLE` errors indicate that the database to which you are trying to connect is protected by native network encryption.
- [Actions IAM Administrators Can Take to Address ORA-01017 Errors](#)
Several actions to remedy `ORA-01017` errors can only be performed by IAM administrators.

7.8.1 Areas to Check on the Client-Side for ORA-01017 Errors

Client-side `ORA-01017` errors can result from problems with IAM credentials, client configuration, or problems with the IAM profile.

Troubleshooting the IAM Token

- **Check the version of the Oracle Cloud Infrastructure (OCI) CLI used for the token.**
The OCI CLI must be at least OCI version 3.4, which includes the command to get the new `db-token` from IAM. To check the version of OCI, run the following command:

```
oci --version
```

- **Check the Oracle Database Client version.** You can find the latest version by checking the Oracle Database documentation. Currently, only the following drivers are supported:
 - JDBC: Version 19.13.0.0.1 and later versions of 19c JDBC clients JDBC: Version 21.5 and later versions of 21c
 - Instant Client/SQL*Plus (Linux only): Version 19.13 (annotated with -2) and later versions of 19c
 - Instant Client/OCI/SQL*Plus (Linux only): Version 21.5 and later versions of 21c (Not all features are supported with Instant Client/OCI version 21c. Oracle recommends that you use the latest 19c or version 23ai client, if possible.)
 - SQLcl: version 21.4 and later
 - ODP.net: Version 19.13 and higher versions of 19c
 - ODP.net: Version 21.4 and higher versions of 21c
 - Oracle Database release 23ai: All clients

The latest version of these drivers is needed when you use IAM tokens to access the database. All supported database clients will work when using IAM database passwords.

- **Check the token location that was specified in the tnsnames.ora file.** The database clients and OCI CLI use the same default location for storing and retrieving database tokens and the private key (`~/.oci/db-token`). You can specify a different location, but both OCI CLI and the database client must be configured to use the same directory. Ensure that the correct `TOKEN_LOCATION` value is specified in the connect string, in the `tnsnames.ora` or `sqlnet.ora` file. The connect string takes precedence over `tnsnames.ora`, which takes precedence over the value of `TOKEN_LOCATION` in `sqlnet.ora`.
- **Check if the token has expired.** The IAM database token is only valid for one hour. After the database token has expired, re-run the following OCI CLI command to request another token if you are using an `API-key`:

```
oci iam db-token get
```

- **Check the TOKEN_AUTH parameter value in tnsnames.ora.** Ensure that the parameter `TOKEN_AUTH=OCI_TOKEN` is set in either the connect string, `tnsnames.ora`, or `sqlnet.ora`. The connect string takes precedence over `tnsnames.ora`, which takes precedence over `sqlnet.ora` for the value of `TOKEN_AUTH`.
- **Check if there is a missing token or private key from the default user-specified token location.** Ensure that both the token and the private key are in the directory that is specified by the `TOKEN_LOCATION` after you run the OCI CLI command `oci cli db-token get`. You can find the `db-token` and private key location by running the following command:

```
[oracle@localhost ~]$ oci iam db-token get
```

Output similar to the following appears:

```
Private key written at /home/oracle/.oci/db-token/oci_db_key.pem
db-token written at: /home/oracle/.oci/db-token/token
db-token is valid until 2022-01-05 15:36:51
```

If the location does not match the `TOKEN_LOCATION` setting, either update the OCI CLI command or update the `TOKEN_LOCATION` parameter.

- **Check your OCI IAM profile.**

- Ensure that the public API-key exists in the OCI user account. The OCI CLI will default to using the `API-key` on the client to request a `db-token` from IAM. If the public API-key is not in the OCI user account, then IAM will not return a database token.
- Ensure that the IAM account is not locked. If it is, then ask the IAM administrator to unlock it.
- If you are using the IAM database password, then ensure that you set the IAM database password in your IAM profile.
- **If you are not using the API-key, then explicitly state that you are using the security token.** Use the following command:

```
oci iam db-token get --auth security_token
```

If the security token does not exist or has expired, this command will try to open the browser for you to sign into IAM (or your federated IdP). This command will fail if you do not have a browser in your environment.

Troubleshooting Both the IAM Database Password and the IAM Token

- **Check client tracing on Oracle Instant Client only.** Client tracing can provide some information when you use SQL*Plus with the Instant Client. You can generate Oracle Database client trace files using two different tracing levels.

Related Topics

- [Database Client Trace Files](#)
You can generate two levels of trace files to troubleshoot IAM connections on client side.

7.8.2 Database Client Trace Files

You can generate two levels of trace files to troubleshoot IAM connections on client side.

The two levels of trace files that you can generate are as follows:

- Low level tracing prints traces in case of failures:
 - If TCPS is not set up for the IAM connection, then it prints a message that the protocol has to be TCPS.
 - If `SSL_SERVER_DN_MATCH` is not set to `TRUE`, then it prints a message that the value is `FALSE`.
 - If an invalid `TOKEN_LOCATION` has been specified, then it prints a message that the token location does not exist.
 - If the `db-token` and private key are not present at the specified `TOKEN_LOCATION` or the default token location, then it prints a message.
 - If the application has passed in only `db-token` or private key, it prints a message for the missing attribute.
 - If the `db-token` has expired, then it prints a message.
- High level tracing prints traces in case of failure as mentioned above. In addition, it prints traces in case of success, as follows:
 - It prints where `SSL_SERVER_DN_MATCH` is present, `tnsnames.ora` or `sqlnet.ora`. It also prints the value as `TRUE` if set to `TRUE`.

- If both the `db-token` and private key are set by the application, then it prints a message.
- If `TOKEN_AUTH` has the correct value `OCI_TOKEN`, then it prints the value.
- If `db-token` is not expired, then it prints a message.

To control client tracing for IAM connections, you can use one of these methods:

- Add the following settings to the client side `sqlnet.ora` file:
 - `EVENT_25701=14` for low level tracing
 - `EVENT_25701=15` for high level tracing
- Set the environment variable `EVENT_25701`:
 - `EVENT_25701=14` for low level tracing
 - `EVENT_25701=15` for high level tracing

Client trace files are created in the following locations:

- **Linux:** `$ORACLE_HOME/log/diag/clients`
- **Windows:** `%ORACLE_HOME%\log\diag\clients`

You can use the `ADR_BASE` parameter in the client side `sqlnet.ora` to specify the directory in which tracing messages are stored. Ensure that the directory path is valid and has write permissions. Ensure that the `diag_adr_enabled` parameter is not set to `false`.

An example of setting `ADR_BASE` is as follows:

```
ADR_BASE=/oracle/iam/trace
```

7.8.3 Check in the Oracle Cloud Infrastructure IAM and the Oracle Database for ORA-01017 Errors

ORA-01017 errors in the Oracle Database instance can arise from the way that the database was enabled to work with IAM.

- **Check if the IAM configuration has been enabled.** The OCI server must be configured for IAM integration and one or more database schemas (database users) must be mapped to IAM users or groups. This applies to both the IAM token and IAM database password use cases. To check if the configuration has been enabled, run the following command in SQL*Plus:

```
SELECT NAME, VALUE
FROM V$PARAMETER
WHERE NAME='identity_provider_type';
```

Alternatively, you can use this command:

```
SHOW PARAMETER IDENTITY_PROVIDER_TYPE
```

If the returned value does not equal `OCI_IAM`, then enable the external authentication.

- **Check the schemas that have been mapped to IAM.** Note which IAM users and IAM groups are used in the mapping. You can find this information by running the following query in SQL*Plus:

```
SELECT USERNAME, EXTERNAL_NAME, CREATED
FROM DBA_USERS
WHERE AUTHENTICATION_TYPE='GLOBAL';
```

In the output, check that there is at least one `EXTERNAL_NAME` that starts with either `IAM_USER` or `IAM_GROUP`. Make a note of the IAM user or group name. If there are no global schemas, then you must create a new schema, or alter an existing schema, and then map it to an IAM user or IAM group that the user is a member of.

- **Check if the Oracle Database instance needs to be restarted.** In some cases, a database instance that existed before the IAM configuration was introduced may need to be restarted. But before doing so, follow all other troubleshooting guidelines before trying to restart the database.

Related Topics

- [Configuring Authorization for IAM Users and Oracle Cloud Infrastructure Applications](#)
An Oracle DBaaS database administrator can map IAM users and Oracle Cloud Infrastructure (OCI) applications to the Oracle Database global schemas and global roles.

7.8.4 ORA-01017 Errors Caused by Improperly Configured IAM Users

Several `ORA-01017` errors can arise from improperly configured IAM users.

- **Ensure that the IAM user can log in to the Oracle DBaaS instance.** Ask the IAM user to try logging in as an IAM user but not as a federated user. Ensure that this user is not locked out of the account. (The user should contact an IAM administrator if this happens.) If the user's IAM account is locked, then this user cannot log in to the Oracle DBaaS instance. You should also check the IAM user name and IAM groups that the user is a member of. One of these (user name or group names) should match the mapped IAM user and group name that you found from the Oracle DBaaS server. If there is no mapping, then the user will be denied access to the database. If this is the case, then an IAM administrator should add the user to an IAM group that is mapped to the DBaaS instance that the user needs to access.
- **Ensure that the API public key is registered in the IAM user profile.** If the Oracle DBaaS instance configuration with IAM uses tokens, and if you use an `API-key` to retrieve the database token, then the API public key needs to be registered in the user's IAM user profile.
- **Ensure that the IAM database password has been set in the IAM user profile.** If the Oracle DBaaS instance configuration with IAM uses database password authentication, then ensure that an IAM database password has been set in the user IAM user profile. In addition, ensure that `Database Passwords` is an allowed setting in the `User Capability` section of the IAM user profile.

Related Topics

- [Configuring Authorization for IAM Users and Oracle Cloud Infrastructure Applications](#)
An Oracle DBaaS database administrator can map IAM users and Oracle Cloud Infrastructure (OCI) applications to the Oracle Database global schemas and global roles.

7.8.5 ORA-12599 and ORA-03114 Errors Caused When Trying to Access a Database Using a Token

The ORA-12599: TNS: cryptographic checksum mismatch and ORA-03114: not connected to ORACLE errors indicate that the database to which you are trying to connect is protected by native network encryption.

When tokens are being used to access an Oracle database, a Transport Layer Security (TLS) connection must be established, not network native encryption. To remedy these errors, ensure that TLS is properly configured for your database. You should test the configuration with a local database user name and password and check the following `SYSCONTEXT` `USERENV` parameters:

- `NETWORK_PROTOCOL`
- `TLS_VERSION`

Related Topics

- [Configuring PKI Certificate Authentication](#)
You can configure Oracle Database to use PKI certificates for end-user authentication.

7.8.6 Actions IAM Administrators Can Take to Address ORA-01017 Errors

Several actions to remedy ORA-01017 errors can only be performed by IAM administrators.

- **Check if the IAM user needs to recreate API-keys.** If the IAM user was deleted and then recreated with the exact same user name, then Oracle Cloud Infrastructure (OCI) IAM will consider this as a different user with a different user OCID. In this case, the IAM user will need to recreate their user account and `API-key`. This action does not affect the IAM user and IAM group mappings in the database.
- **If necessary, unlock the IAM user account.** If the user is inactive or otherwise locked, then an IAM administrator will need to unlock the user account before database access can be allowed.
- **Check the IAM policy.** An IAM policy is required to allow the user to use IAM database tokens to access the database. The resource is called `database-connections` and it is also a member of the `autonomous-database-family`. You do not need to create IAM policies if the Oracle DBaaS instance uses IAM database passwords. When you configure the IAM policy, remember that the `use` or `manage` tag is required for the policy. For example:
 - Set `allow all-users to use autonomous-database-family` in the tenancy. This enables all IAM tenancy users to use IAM database tokens to access all Oracle DBaaS instances in the tenancy.
 - Set `allow group DBUsers to use database-connections` in the `production_compartment` compartment. This enables IAM users who are members of the `DBUsers` IAM group to use IAM tokens to access databases in the `production_compartment` compartment.
- **Check the mappings for IAM users and groups.** The IAM user either has an exclusive mapping from a schema (that is, a database user) in the database or is a member of an IAM group that is mapped to a schema in the database. Run the following SQL*Plus query

and review its output to find the mapped IAM users and groups. Ensure that the user has one mapping to a database schema.

```
SELECT USERNAME, EXTERNAL_NAME,  
FROM DBA_USERS  
WHERE AUTHENTICATION_TYPE='GLOBAL';
```

Related Topics

- [Creating an IAM Policy to Authorize Users Authenticating with Tokens](#)
To configure IAM to work with the Oracle DBaaS instance, an IAM administrator must create an IAM policy (if using IAM tokens), create IAM groups and manage group membership.

8

Authenticating and Authorizing Microsoft Azure Users for Oracle Databases

An Oracle database can be configured for Microsoft Azure users of Microsoft Entra ID (previously called Microsoft Azure AD) to connect using single sign-on authentication.



Note:

Microsoft recently changed the name of Microsoft Azure AD to Microsoft Entra ID. This name change is used in the current Oracle Database documentation. Earlier Oracle Database releases use the name Azure AD.

- [Introduction to Oracle Database Integration with Microsoft Entra ID](#)
Before you begin configuring Microsoft Entra AD to access an Oracle database, you must understand the overall process.
- [Configuring the Oracle Database for Microsoft Entra ID Integration](#)
The Microsoft Entra ID integration with the Oracle Database instance requires the database to be registered with Entra ID.
- [Mapping Oracle Database Schemas and Roles](#)
Azure users will be mapped to one database schema and optionally to one or more database roles.
- [Configuring Entra ID Client Connections to the Oracle Database](#)
You can configure client connections to connect with the registered database.
- [Configuring Microsoft Entra ID Proxy Authentication](#)
Proxy authentication allows an Azure user to proxy to a database schema for tasks such as application maintenance.
- [Configuring Microsoft Power BI Single-Sign On](#)
Users have an option of a simpler configuration if only Power BI users will connect to the Oracle Database.
- [Troubleshooting Microsoft Entra ID Connections](#)
You can use trace files to diagnose problems with Microsoft Entra ID connections. You also can easily remedy `ORA-12599` and `ORA-03114` errors.

8.1 Introduction to Oracle Database Integration with Microsoft Entra ID

Before you begin configuring Microsoft Entra AD to access an Oracle database, you must understand the overall process.

- [About Integrating Oracle Database with Microsoft Entra ID](#)
Oracle Database and Microsoft Entra ID can be configured to allow users and applications to connect to the database using their Entra ID credentials.

- [Architecture of Oracle Database Integration with Microsoft Entra ID](#)
Microsoft Azure Active Directory access tokens follow the OAuth 2.0 standard with extensions.
- [Azure Users Mapping to an Oracle Database Schema and Roles](#)
Microsoft Azure users must be mapped to an Oracle Database schema and have the necessary privileges (through roles) before being able to authenticate to the Oracle Database instance.
- [Use Cases for Connecting to an Oracle Database Using Entra ID](#)
Oracle Database supports several use cases for connecting to the database.
- [General Process of Authenticating Microsoft Entra ID Identities with Oracle Database](#)
The Oracle Database administrator and the Microsoft Entra ID administrator play roles to allow Azure users to connect to the database using Entra ID OAuth2 access tokens.

8.1.1 About Integrating Oracle Database with Microsoft Entra ID

Oracle Database and Microsoft Entra ID can be configured to allow users and applications to connect to the database using their Entra ID credentials.

Azure users and applications can log in with Entra ID Single Sign On (SSO) credentials to access the database. This is done with an Entra ID OAuth2 access token that the user or application first requests from Entra ID. This OAuth2 access token contains the user identity and database access information and is then sent to the database. Refer to the Microsoft article [Passwordless authentication options for Azure Active Directory](#) for information about configuring multi-factor and passwordless authentication.

You can perform this integration in the following Oracle Database environments:

- On-premises Oracle Database release 19.18 and later, excluding 21c
- All Oracle Database server platforms: Linux, Windows, AIX, Solaris, and HPUX
- Oracle Autonomous Database Serverless
- Oracle Autonomous Database on Dedicated Exadata Infrastructure
- Oracle Autonomous Database on Exadata Cloud@Customer
- Oracle Exadata Database Service on Dedicated Infrastructure
- Oracle Exadata Database Service on Cloud@Customer
- Oracle Base Database Service

The instructions for configuring Entra ID use the term "Oracle Database" to encompass these environments.

This type of integration enables the Azure user to access an Oracle Database instance. Azure users and applications can log in with Entra ID Single Sign On (SSO) credentials to get an Entra ID OAuth2 access token to send to the database.

The Entra ID administrator creates and registers Oracle Database with Entra ID. Within Entra ID, this is called an app registration, which is short for application registration. This is the digital information that Entra ID must know about the software that is using Entra ID. The Entra ID administrator also creates application (app) roles for the database app registration in Entra ID. App roles connect Azure users, groups, and applications to database schemas and roles. The Entra ID administrator assigns Azure users, groups, or applications to the app roles. These app roles are mapped to a database global schema or a global role or to both a schema and a role. An Azure user, group, or application that is assigned to an app role will be mapped to a database global schema, global role, or to both a schema and a role. An Oracle global schema can also be mapped exclusively to an Azure user. An Azure guest user (non-organization user)

or an Entra ID service principal (application) can only be mapped to a database global schema through an Entra ID app role. An Oracle global role can only be mapped from an Azure app role and cannot be mapped from an Azure user.

Tools and applications that are updated to support Entra ID tokens can authenticate users directly with Entra ID and pass the database access token to the Oracle Database instance. You can configure existing database tools such as SQL*Plus to use an Entra ID token from a file location. In these cases, Entra ID tokens can be retrieved using tools like Microsoft PowerShell or Azure CLI and put into a file location. An Entra ID OAuth2 database access tokens are issued with an expiration time. The Oracle Database client driver will ensure that the token is in a valid format and that it has not expired before passing it to the database. The token is scoped for the database, which means that there is information in the token about the database where the token will be used. The app roles the Entra ID principal was assigned to in the database Entra ID app registration are included as part of the access token. The directory location for the Entra ID token should only have enough permission for the user to write the token file to the location and the database client to retrieve these files (for example, just read and write by the user). Because the token allows access to the database, it should be protected within the file system.

Azure users can request a token from Entra ID using a number of methods to open an Azure login window to enter their Entra ID credentials.

Oracle Database accepts tokens representing the following Entra ID principals:

- Azure user, who is registered user in the Entra ID tenancy
- Guest user, who is registered as a guest user in the Entra ID tenancy
- Service, which is the registered application connecting to the database as itself with the client credential flow (connection pool use case)

Oracle Database supports the following Entra ID authentication flows:

- Interactive flow (also called authorization code flow) using Proof Key for Code Exchange (PKCE), most commonly used for human users (not applications) to authenticate to Entra ID in a client environment with a browser
- Client credentials, which are for database applications that connect as themselves (and not the end-user)
- On-Behalf-Of (OBO), where an application requests an access token on behalf of a logged-in user to send to the database
- Resource owner password credential (ROPC), which is not recommended for production use, but can be used in test environments where a pop-up browser user authentication would be difficult to incorporate. ROPC needs the Entra ID user name and password credential to be part of the token request call.

**Note:**

The DBaaS integration with Microsoft Entra ID does not support users with administrative privileges (SYSDBA, SYSOPER, SYSBACKUP, SYSDG, SYSKM, and SYSRAC).

Related Topics

- [Oracle Autonomous Database Serverless](#)
- [Oracle Autonomous Database on Dedicated Exadata Infrastructure](#)
- [Oracle Autonomous Database on Exadata Cloud@Customer](#)

- [Oracle Exadata Database Service on Dedicated Infrastructure](#)
- [Oracle Exadata Database Service on Cloud@Customer](#)
- [Oracle Base Database Service](#)

8.1.2 Architecture of Oracle Database Integration with Microsoft Entra ID

Microsoft Azure Active Directory access tokens follow the OAuth 2.0 standard with extensions.

The Entra ID access token will be needed before you access the database from the database client (for example, with SQLPlus or SQLcl). The Oracle clients (for example, OCI, JDBC, and ODP) can be configured to pick up an Entra ID token from a file location or the token can be passed to the client through the database client API. An Azure user can use a script (examples available from Microsoft) to retrieve a token and put it into a file location for the database client to retrieve. Applications can use the Azure SDK to get an access token and pass the token through the database client API. Command-line tools such as Microsoft PowerShell or the Azure command-line interface can be used to retrieve the Entra ID token if the application cannot directly get the token.

The following diagram is a generalized flow diagram for OAuth 2.0 standard, using the OAuth2 token. See [Authentication flow support in MSAL](#) in the Microsoft Entra ID documentation for more details about each supported flow.

Figure 8-1 Azure User Accessing the Database with the Interactive Authorization Code Flow

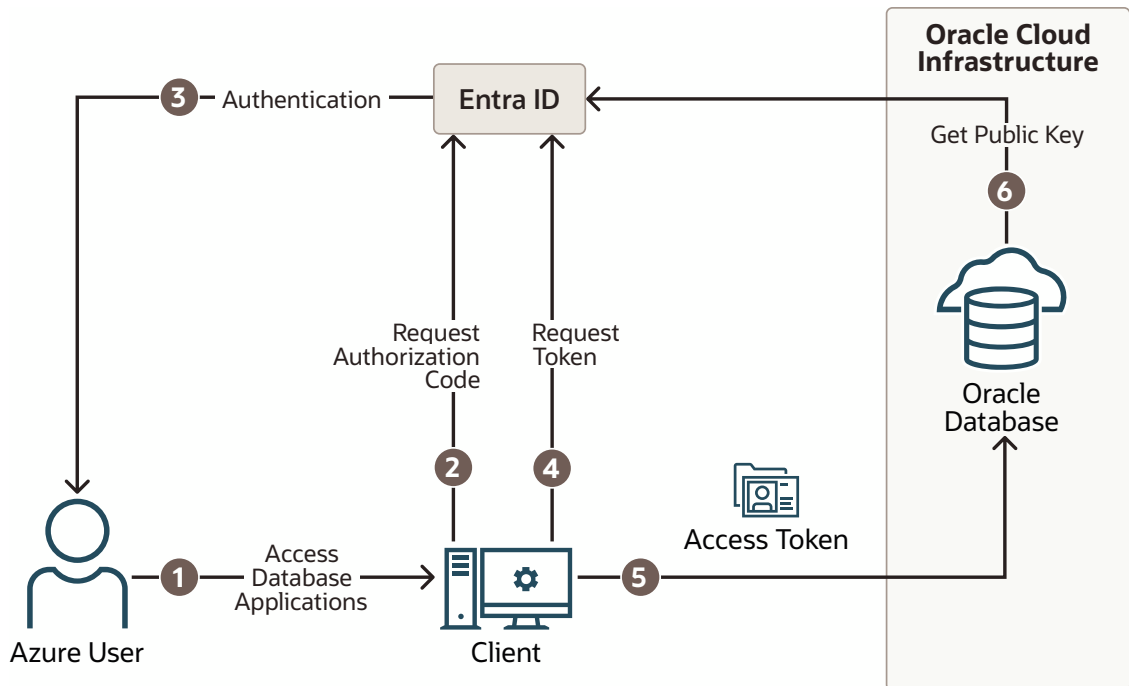

The authorization code flow is an OAuth2 standard and is described in detail as part of the standards. There are two steps in the flow. The first step authenticates the user and retrieves the authorization code. The second step uses the authorization code to get the database access token.

1. The Azure user requests access to the resource, the Oracle Database instance.

2. The database client or application requests an authorization code from Entra ID.
3. Entra ID authenticates the Azure user and returns the authorization code.
4. The helper tool or application uses the authorization code with Entra ID to exchange it for the OAuth2 token.
5. The database client sends the OAuth2 access token to the Oracle database. The token includes the database app roles the user was assigned to in the Entra ID app registration for the database.
6. The Oracle Database instance uses the Entra ID public key to verify that the access token was created by Entra ID.

Both the database client and the database server must be registered with the **app registrations** feature in the Azure Active Directory section of the Azure portal. The database client must be registered with Entra ID app registration. Permission must also be granted to allow the database client to get an access token for the database.

8.1.3 Azure Users Mapping to an Oracle Database Schema and Roles

Microsoft Azure users must be mapped to an Oracle Database schema and have the necessary privileges (through roles) before being able to authenticate to the Oracle Database instance.

In Microsoft Azure, an Entra ID administrator can assign users, groups, and applications to the database app roles.

Exclusively mapping an Entra ID user to a database schema requires the database administrator to create and manage a database schema for the lifecycle of the user (joining, moving, leaving). The database administrator must create the schema when the user joins the organization. The database administrator must also modify the privileges and roles that are granted to the database schema to align them with the tasks the Azure user is assigned to. When the Azure user leaves the organization, the database administrator must drop the database schema so that an unused account is not left on the database. Using the database app roles enables the Entra ID administrator to control access and roles by assigning users to app roles that are mapped to global schemas and global roles. This way, user access to the database is managed by Entra ID administrators and database administrators do not need to create, manage, and drop schemas for every user.

An Azure user can be mapped to a database schema (user) either exclusively or through an app role.

- **Creating an exclusive mapping between an Azure user and an Oracle Database schema.** In this type of mapping, the database schema must be created for the Azure user. Database privileges and roles that are needed by the Azure user must be granted to the database schema. The database schema not only must be created when the Azure user is authorized to the database, but the granted privileges and roles must be modified as the Entra ID roles and tasks change. Finally, the database schema must be dropped when the Azure user leaves the organization.
- **Creating a shared mapping between an Entra ID app role and an Oracle Database schema.** This type of mapping, which is more common than exclusive mappings, is for Azure users who have been assigned directly to the app role or is a member of an Entra ID group that is assigned to the app role. The app role is mapped to an Oracle Database schema (shared schema mapping). Shared schema mapping allows multiple Azure users to share the same Oracle Database schema so a new database schema is not required to be created every time a new user joins the organization. This operational efficiency allows database administrators to focus on database application maintenance, performance, and

tuning tasks instead of configuring new users, updating privileges and roles, and removing accounts.

In addition to database roles and privileges being granted directly to the mapped global schema, additional roles and privileges can be granted through mapped global roles. Different Azure users mapped to the same shared global schema may need different privileges and roles. Azure app roles can be mapped to Oracle Database global roles. Azure users who are assigned to the app role or are a member of an Entra ID group that is assigned to the app role will be granted the Oracle Database global role when they access the database.

The following diagram illustrates the different types of assignments and mappings that are available.

Figure 8-2 Assignments and Mappings Between Entra ID and Oracle Database

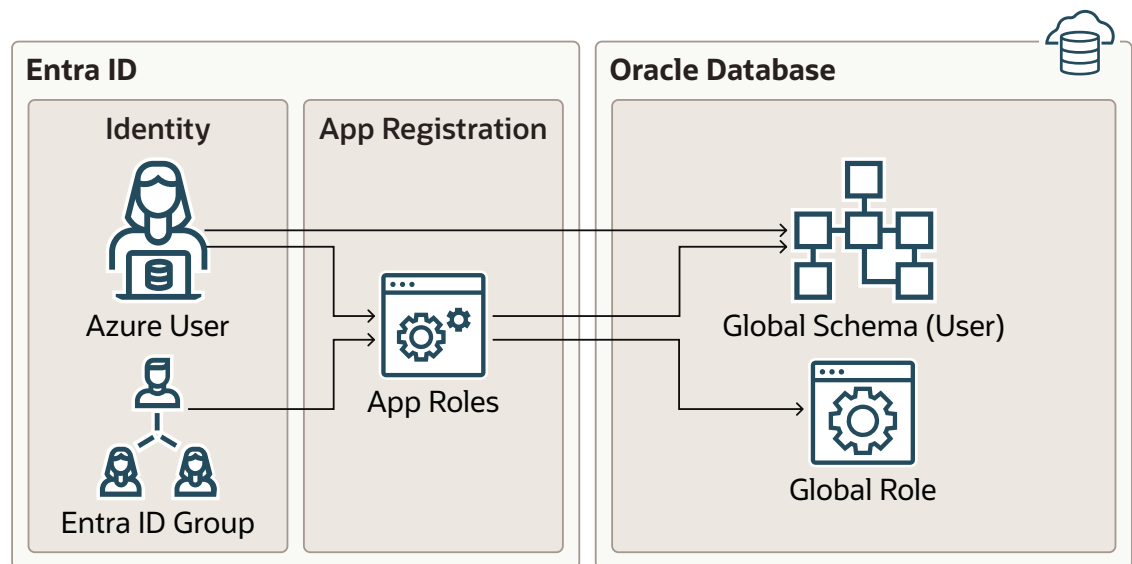

These mappings are as follows:

- An Azure user can be mapped directly to an Oracle Database global schema (user).
- An Azure user, Entra ID group, or application is assigned to an app role, which is then mapped to either an Oracle Database global schema (user) or a global role.

8.1.4 Use Cases for Connecting to an Oracle Database Using Entra ID

Oracle Database supports several use cases for connecting to the database.

- **OAuth2 authorization code flow:** This is the most common flow for human users. The client directs the Azure user to Entra ID to get the authorization code. This code is used to get the database access token. See the Microsoft Azure article [Microsoft identity platform and OAuth 2.0 authorization code flow](#).
- **Resource owner password credentials (ROPC):** This flow is not recommended for production servers. It is useful for test software that cannot work with a pop-up authentication window. It is used in non-graphic user interface environments when a pop-up window cannot be used to authenticate a user.
- **Client credentials:** This flow is used for applications to connect with the database. The application must register with Entra ID app registration and needs a client ID and client

password. These client credentials must be used to get the database access token from Entra ID when the application connects to the database. The application can pass the token through the file system or through the database client API.

- **On-behalf-of (OBO) token:** An Azure application requests an OBO token for a logged in user. The OBO token will also be an access token for the database with the Azure user identity and assigned app roles for the database. This enables the Azure user to log in to the database as the user and not the application. Only an application can request an OBO token for its Azure user and pass it to the database client through the API.

8.1.5 General Process of Authenticating Microsoft Entra ID Identities with Oracle Database

The Oracle Database administrator and the Microsoft Entra ID administrator play roles to allow Azure users to connect to the database using Entra ID OAuth2 access tokens.

The general process is as follows:

1. The Oracle Database administrator ensures that the Oracle Database environment meets the requirements for the Microsoft Entra ID integration. See Oracle Database Requirements for the Microsoft Entra ID Integration.
2. The Entra ID administrator creates an Entra ID app registration for the database and the Oracle Database administrator enables the database to use Entra ID tokens for database access.
As part of the app registration process, the Entra ID administrator creates Azure app roles to be used for the mappings between the Azure users, groups, and applications to the Oracle Database schemas and roles.
3. The Oracle Database administrator creates and maps global schemas to either an Azure user (exclusive schema mapping) or to an Azure app role (shared schema mapping). The Azure user or application must be mapped to one schema.
4. Optionally, the Oracle administrator creates and maps global Oracle Database roles to Azure app roles.
5. The Azure end user who wants to connect with the Oracle Database instance registers the client application as an Entra ID client (similar to how the Oracle database is registered). The Entra ID client will have a client identification and a client secret, unless the application client is public. If the application client is public, then only the application client identification is necessary.
6. The Azure user (who can be a database administrator) connects using an utility such as PowerShell or the Azure command-line interface to retrieve the OAuth2 database access token and store it in a local file directory. An application can also request an Entra ID OAuth2 access token directly from Entra ID and pass it through a database client API. Refer to the following Oracle Database client documentation for information about passing Entra ID OAuth2 tokens:
 - JDBC-thin clients: *Oracle Database JDBC Developer's Guide*
 - Oracle Call Interface (OCI): *Oracle Call Interface Developer's Guide*
 - Oracle Data Provider for .NET (ODP): *Oracle Data Provider for .NET Developer's Guide* Connecting to Oracle Database
7. Once connected to the Oracle Database instance, the Azure end user performs database operations as needed.

8.2 Configuring the Oracle Database for Microsoft Entra ID Integration

The Microsoft Entra ID integration with the Oracle Database instance requires the database to be registered with Entra ID.

- [Oracle Database Requirements for the Microsoft Entra ID Integration](#)
Before you can configure an Oracle Database instance with Microsoft Entra ID, you must ensure that your environment meets special requirements.
- [Registering the Oracle Database Instance with a Microsoft Entra ID Tenancy](#)
A user with Entra ID administrator privileges uses Microsoft Entra ID to register the Oracle Database instance with the Microsoft Entra ID tenancy.
- [Enabling Microsoft Entra ID v2 Access Tokens](#)
Oracle Database supports integration with the v1 and v2 Azure AD OAuth2 access token.
- [Managing App Roles in Microsoft Entra ID](#)
In Entra ID, you can create and manage app roles that will be assigned to Azure users and groups and also be mapped to Oracle Database global schemas and roles.
- [Enabling Entra ID External Authentication for Oracle Database](#)
You need to enable Microsoft Entra ID external authentication with Oracle Database.
- [Disabling Entra ID External Authentication for Oracle Database](#)
To disable Entra ID External authentication for an Oracle Database instance, you must use the `ALTER SYSTEM` statement.

8.2.1 Oracle Database Requirements for the Microsoft Entra ID Integration

Before you can configure an Oracle Database instance with Microsoft Entra ID, you must ensure that your environment meets special requirements.

For an on-premises, non-cloud Oracle database, follow the steps in this document. If your Oracle database is in one of the following DBaaS platforms, then refer to the platform documentation for additional requirements.

- [Using Oracle Autonomous Database Serverless](#)
- [Using Oracle Autonomous Database on Dedicated Exadata Infrastructure](#)
- [Use Azure Active Directory Authentication with Base Database Service](#)
- [Use Azure Active Directory Authentication with Exadata Database on Dedicated Infrastructure](#)

Note the following:

- The Oracle Database server must be able to request the Entra ID public key. Depending on the enterprise network connectivity setup, you may need to configure a proxy setting.
- Users and applications that need to request an Entra ID token must also be able to have network connectivity to Entra ID. You may need to configure a proxy setting for the connection.
- You must configure Transport Layer Security (TLS) between the Oracle Database client and the Oracle Database server so that the token can be transported securely. This TLS connection can be either one-way or mutual.

- You can create the TLS server certificate to be self-signed or be signed by a well known certificate authority. The advantage of using a certificate that is signed by a well known Certificate Authority (CA) is that the database client can use the system default certificate store to validate the Oracle Database server certificate instead of having to create and maintain a local wallet with the root certificate. Note that this applies to Linux and Windows clients only.

Related Topics

- [Configuring TLS Using a Public Certificate Authority Root of Trust for the Database Server Certificate](#)
Before you can configure TLS without using client wallets, you must first create the server wallet and ensure that the database and listener are properly configured.

8.2.2 Registering the Oracle Database Instance with a Microsoft Entra ID Tenancy

A user with Entra ID administrator privileges uses Microsoft Entra ID to register the Oracle Database instance with the Microsoft Entra ID tenancy.

1. Log in to the Azure portal as an administrator who has Microsoft Entra ID privileges to register applications.
2. In the Azure Active directory admin center page, from the left navigation bar, select **Azure Active Directory**.
3. In the MS - App registrations page, select **App registrations** from the left navigation bar.
4. Select **New registration**.

The Register an application window appears.

Register an application ...

*** Name**
The user-facing display name for this application (this can be changed later).

ExampleDatabase ✓

Supported account types

Who can use this application or access this API?

Accounts in this organizational directory only (az207oracle only - Single tenant)

Accounts in any organizational directory (Any Azure AD directory - Multitenant)

Accounts in any organizational directory (Any Azure AD directory - Multitenant) and personal Microsoft accounts (e.g. Skype, Xbox)

Personal Microsoft accounts only

[Help me choose...](#)

Redirect URI (optional)
We'll return the authentication response to this URI after successfully authenticating the user. Providing this now is optional and it can be changed later, but a value is required for most authentication scenarios.

Select a platform ▼ e.g. https://example.com/auth

Register an app you're working on here. Integrate gallery apps and other apps from outside your organization by adding from [Enterprise applications](#).

By proceeding, you agree to the [Microsoft Platform Policies](#) ↗

Register

5. In the Register an application page, enter the following Oracle Database instance registration information:
 - In the **Name** field, enter a name for the Oracle Database instance connection (for example, *Example Database*).
 - Under Supported account types, select the account type that matches your use case.
 - **Accounts in this organizational directory only (tenant_name only - Single tenant)**
 - **Accounts in any organizational directory (Any Entra ID directory - Multitenant)**
 - **Accounts in any organizational directory (Any Entra ID directory - Multitenant) and personal Microsoft accounts (e.g. Skype, Xbox)**
 - **Personal Microsoft accounts only**

6. Bypass the Redirect URI (Optional) settings. You do not need to create a redirect URI because Entra ID does not need one for the database server.

7. Click **Register**.

After you click **Register**, Entra ID displays the app registration's Overview pane, which will show the Application (client) ID under Essentials. This value is a unique identifier for the application in the Microsoft identity platform. Note the term Application refers to the Oracle Database instance.

8. Register a scope for the database app registration.

A scope is a permission to access the database. Each database will need a scope so that clients can establish a trust with the database by requesting permission to use the database scope. This allows the database client to get access tokens for the database.

- a. In the left navigation bar, select **Expose an API**.
- b. Under Set the App ID URI, in the **Application ID URI** field, enter the app ID URI for the database connection using the following format, and then click **Save**:

your_tenancy_url/application_(client)_id

In this specification:

- *your_tenancy_url* must include `https` as the prefix and the fully qualified domain name of your Entra ID tenancy.
- *application_(client)_id* is the ID that was generated when you registered the Oracle Database instance with Entra ID. It is displayed in the Overview pane of the app registration.

For example:

`https://sales_west.example.com/1aa11111-1a1z-1a11-1a1a-11aa11a1a1a`

- c. Select **Add a scope** and then enter the following settings:

Add a scope

Scope name * ⓘ
session:scope:connect
https://sales_west.example.com/1aa11111-1a1z-1a11-1a1a-11aa11a1aa1a/session:scope:connect

Who can consent? ⓘ
 Admins and users Admins only

Admin consent display name * ⓘ
Connect to Example Database

Admin consent description * ⓘ
Connect to Example Database

User consent display name ⓘ
Connect to Example Database

User consent description ⓘ
Connect to Example Database

State ⓘ
 Enabled Disabled

- **Scope name** specifies a name for the scope. Enter the following name:

```
session:scope:connect
```

This name can be any text. However, a scope name must be provided. You will need to use this scope name later when you give consent to the database client application to access the database.

- **Who can consent** specifies the necessary permissions. Select **Admins and users**, or for higher restrictions, **Admins only**.
- **Admin consent display name** describes the scope's purpose (for example, `Connect to Oracle`), which only administrators can see.
- **Admin consent display name** describes the scope's purpose (for example, `Connect to Example Database`), which only administrators can see.

- **User consent display name** is a short description of the purpose of the scope (for example, `Connect to Example Database`), which users can see if you specify **Admins and users** in **Who can consent**.
- **User consent description** is a more detailed description of the purpose of the scope (for example, `Connect to Example Database`), which users can see if you specify **Admins and users** in **Who can consent**.
- **State** enables or disables the connection. Select **Enabled**.

After you complete these steps, you are ready to add one or more Azure app roles, and then perform the mappings of Oracle schemas and roles.

Related Topics

- [Quickstart: Register an application with the Microsoft identity platform](#)

8.2.3 Enabling Microsoft Entra ID v2 Access Tokens

Oracle Database supports integration with the v1 and v2 Azure AD `OAuth2` access token.

Oracle Database supports the Entra ID v2 token as well as the default v1 token. However, to use the Entra ID v2 token, you must perform some additional steps to ensure it works with the Oracle Database. You can use this token with applications that are registered in the Azure portal using the **App registrations** experience.

When you use the Azure AD v2 `OAuth2` access token, the credential flow continues to work as it did before without any changes. However, the `upn:` claim must be added when you use v2 tokens with the interactive flow.

1. Check the version of the Entra ID access token that you are using.
2. Log in to the Microsoft Entra ID portal.
3. Search for and select **Entra ID**.
4. Under **Manage**, select **App registrations**.
5. Choose the application for which you want to configure optional claims based on your scenario and desired outcome.
6. Under **Manage**, select **Token configuration**.
7. Click **Add optional claim** and select **upn**.

When you use v2 tokens, the `aud:` claim only reflects the APP ID value. You do not need to set the `https:domain` prefix to the APP ID URI when v2 tokens are being used. This simplifies the configuration for the database because the default APP ID URI can be used.

Related Topics

- [Checking the Entra ID Access Token Version](#)
You can check the version of the Entra ID access token that your site uses by using the JSON Web Tokens web site.

8.2.4 Managing App Roles in Microsoft Entra ID

In Entra ID, you can create and manage app roles that will be assigned to Azure users and groups and also be mapped to Oracle Database global schemas and roles.

- [Creating a Microsoft Entra ID App Role](#)
Azure users, groups, and applications that need to connect to the database will be assigned to the database app roles.
- [Assigning Users and Groups to the Microsoft Entra ID App Role](#)
Before Microsoft Azure users can have access to the Oracle database, they must first be assigned to the app roles that will be mapped to Oracle Database schema users or roles.
- [Assigning an Application to an App Role](#)
An application that must connect to the database using the client credential flow must to be assigned to an app role.

8.2.4.1 Creating a Microsoft Entra ID App Role

Azure users, groups, and applications that need to connect to the database will be assigned to the database app roles.

See the Microsoft Azure article [Create and assign a custom role in Azure Active Directory](#) for detailed steps on how to create an app role. The following steps describe how to create the app role for use with an Oracle database.

1. Log in to Entra ID as an administrator who has privileges for creating app roles.
2. Access the Oracle Database app registration that you created.
 - a. Use the **Directory + subscription** filter to locate the Entra ID tenant that contains the Oracle Database app registration.
 - b. Select **Azure Active Directory**.
 - c. Under **Manage**, select **App registrations**, and then select the Oracle Database instance that you registered earlier.
3. Under **Manage**, select **App roles**.
4. In the App roles page, select **Create app role**.
5. In the Create app role page, enter the following information:
 - **Display name** is the displayed name of the role (for example, HR App Schema). You can include spaces in this name.
 - **Value** is the actual name of the role (for example, HR_APP). Ensure that this setting matches exactly the string that is referenced in the database mapping to a schema or role. Do not include spaces in this name.
 - **Description** provides a description of the purpose of this role.
 - **Do you want to enable this app role?** enables you to activate the role.
6. Click **Apply**.

The app role appears in the App roles pane.

App roles ✨ ...

+ Create app role | 🗨️ Got feedback?

i Got a second to give us some feedback? →

App roles

App roles are custom roles to assign permissions to users or apps. The application defines and publishes the app roles and interprets them as permissions during authorization.

[How do I assign App roles](#)

Display name	Description	Allowed member types	Value	ID	State
dba_admin	App role for DBA Admins	Users/Groups,Applications	dba_admin	f09047ea-6468-4ae9-...	Enabled

8.2.4.2 Assigning Users and Groups to the Microsoft Entra ID App Role

Before Microsoft Azure users can have access to the Oracle database, they must first be assigned to the app roles that will be mapped to Oracle Database schema users or roles.

See the Microsoft Azure article [Add app roles to your application and receive them in the token](#) for detailed steps assigning users and groups to an app role. The following steps explain how to do this for an Oracle database.

1. Log in to Entra ID as an administrator who has privileges for assigning Azure users and Entra ID groups to app roles.
2. In enterprise applications, find the name of the Oracle Database app registration that you created. This is automatically created when you create an app registration.
 - a. Use the **Directory + subscription** filter to locate the Azure Active Directory tenant that contains the Oracle connection.
 - b. Select **Azure Active Directory**.
 - c. Under **Manage**, select **Enterprise applications**, and then select the Oracle Database app registration name that you registered earlier.
3. Under Getting Started, select **Assign users and groups**.
4. Select **Add user/group**.
5. In the Add assignment window, select **Users and groups** to display a list of users and security groups.
6. From this list, select the users and groups that you want to assign to the app role, and then click **Select**.
7. In the Add assignment window, select **Select a role** to display a list of the app roles that you have created.
8. Select the app role and then select **Select**.
9. Click **Assign**.

8.2.4.3 Assigning an Application to an App Role

An application that must connect to the database using the client credential flow must to be assigned to an app role.

1. Log in to Entra ID as an administrator who has privileges for assigning Azure users and Entra ID groups to app roles.
2. Access the app registration for the application.
3. Under Manage, select **API permissions**.
4. In the Configured permissions area, select **+ Add a permission**.
5. In the Request API permission pane, select the **My APIs** tab.
6. Select the Oracle Database app that you want to give permission for this application to access. Then select the **Application permissions** option.
7. Select the database app roles to assign to the application and then click the **Add Permission** box at the bottom of the screen to assign the app roles and close the dialog box. Ensure that the app roles that you just assigned appear under Configured permissions.

Search (Ctrl+/) Refresh Got feedback?

Successfully granted admin consent for the requested permissions.

The "Admin consent required" column shows the default value for an organization. However, user consent can be customized per permission, user, or app. This column may not reflect the value.

Configured permissions

Applications are authorized to call APIs when they are granted permissions by users/admins as part of the consent process. The list of configured permissions should include all the permissions the application needs. [Learn more about permissions and consent](#)

+ Add a permission Grant admin consent for examplecompany

API / Permissions name	Type	Description	Admin consent requ...	Status
ExampleDatabase (1)				
hr_admin	Application	hr_admin	Yes	Granted for exampleco...
Microsoft Graph (1)				
User.Read	Delegated	Sign in and read user profile	No	Granted for exampleco...

To view and manage permissions and user consent, try [Enterprise applications](#).

8. Select **Grant admin consent for tenancy** to grant consent for the tenancy users, then select **Yes** in the confirmation dialog box.

Related Topics

- [Configure the admin consent workflow](#)

8.2.5 Enabling Entra ID External Authentication for Oracle Database

You need to enable Microsoft Entra ID external authentication with Oracle Database.

For additional information about Entra ID authentication for your platform, see the [documentation links](#) below.

1. Log in to the Oracle Database instance as a user who has been granted the `ALTER SYSTEM` system privilege.
2. Set the `IDENTITY_PROVIDER_TYPE` parameter as follows:

```
ALTER SYSTEM SET IDENTITY_PROVIDER_TYPE=AZURE_AD SCOPE=BOTH;
```

3. Ensure that you set the `IDENTITY_PROVIDER_TYPE` parameter correctly.

```
SELECT NAME, VALUE FROM V$PARAMETER WHERE NAME='identity_provider_type';
```

The following output should appear:

```
NAME                                VALUE
-----                                -
identity_provider_type             AZURE_AD
```

4. Set the `IDENTITY_PROVIDER_CONFIG` parameter by using the following syntax:

```
ALTER SYSTEM SET IDENTITY_PROVIDER_CONFIG =
' {
  "application_id_uri": string , // from registered app, to be mapped in
  jwt "aud" claim;
                                     // Domain qualified to support cross
  tenancy resource access
  "tenant_id": string, // from tenant config
  "app_id": string // from registered resource app
}' SCOPE=BOTH;
```

For example:

```
ALTER SYSTEM SET IDENTITY_PROVIDER_CONFIG =
' {
  "application_id_uri" : "https://www.example.com/11aa1a11-
  aaaa-1111-1111-1111aa1111",
  "tenant_id" : "111a1111-a11a-111a-1a1a-1111111111a",
  "app_id" : "11aa1a11-aaaa-1111-1111-1111aa1111"
}' SCOPE=BOTH;
```

See the following platform-specific documentation for information about enabling Oracle Database for Entra ID external authentication, in addition to the information detailed in this document for on-premises (non-cloud) Oracle databases.

- [Using Oracle Autonomous Database Serverless](#)
- [Oracle Autonomous Database on Dedicated Exadata Infrastructure](#)

8.2.6 Disabling Entra ID External Authentication for Oracle Database

To disable Entra ID External authentication for an Oracle Database instance, you must use the `ALTER SYSTEM` statement.

In addition to Oracle Database, this procedure can be used for Oracle Autonomous Database on Dedicated Exadata Infrastructure and Oracle Exadata Cloud Service (Oracle ExaCS). If you want to disable Entra ID external authentication with these products, see their product documentation.

To disable Entra ID from Oracle Autonomous Database Serverless, see *Using Oracle Autonomous Database Serverless*. The following procedure applies to all other platforms:

1. Log in to the Oracle Database instance as a user who has been granted the `ALTER SYSTEM` system privilege.
2. Set the identity provider parameters as follows:

```
ALTER SYSTEM RESET IDENTITY_PROVIDER_CONFIG SCOPE=BOTH;
ALTER SYSTEM RESET IDENTITY_PROVIDER_TYPE SCOPE=BOTH;
```

8.3 Mapping Oracle Database Schemas and Roles

Azure users will be mapped to one database schema and optionally to one or more database roles.

- [Exclusively Mapping an Oracle Database Schema to a Microsoft Azure User](#)
You can exclusively map an Oracle Database schema to a Microsoft Azure user.
- [Mapping a Shared Oracle Schema to an App Role](#)
In this mapping, an Oracle schema is mapped to an app role. Therefore, anyone who has that app role would get the same shared schema.
- [Mapping an Oracle Database Global Role to an App Role](#)
Oracle Database global roles that are mapped to Entra ID app roles give Azure users and applications additional privileges and roles above those that they have been granted through their login schemas.

8.3.1 Exclusively Mapping an Oracle Database Schema to a Microsoft Azure User

You can exclusively map an Oracle Database schema to a Microsoft Azure user.

1. Log in to the Oracle Database instance as a user who has been granted the `CREATE USER` or `ALTER USER` system privilege.
2. Run the `CREATE USER` or `ALTER USER` statement with the `IDENTIFIED GLOBALLY AS` clause specifying the Azure user name.

For example, to create a new database schema user named `peter_fitch` and map this user to an existing Azure user named `peter.fitch@example.com`:

```
CREATE USER peter_fitch IDENTIFIED GLOBALLY AS  
'AZURE_USER=peter.fitch@example.com';
```

3. Grant the `CREATE SESSION` privilege to the user.

```
GRANT CREATE SESSION TO peter_fitch;
```

8.3.2 Mapping a Shared Oracle Schema to an App Role

In this mapping, an Oracle schema is mapped to an app role. Therefore, anyone who has that app role would get the same shared schema.

1. Log in to the Oracle Database instance as a user who has the `CREATE USER` or `ALTER USER` system privilege.
2. Run the `CREATE USER` or `ALTER USER` statement with the `IDENTIFIED GLOBALLY AS` clause specifying the Azure application role name.

For example, to create a new database global user account (schema) named `dba_azure` and map it to an existing Entra ID application role named `AZURE_DBA`:

```
CREATE USER dba_azure IDENTIFIED GLOBALLY AS 'AZURE_ROLE=AZURE_DBA';
```

8.3.3 Mapping an Oracle Database Global Role to an App Role

Oracle Database global roles that are mapped to Entra ID app roles give Azure users and applications additional privileges and roles above those that they have been granted through their login schemas.

1. Log in to the Oracle Database instance as a user who has been granted the `CREATE ROLE` or `ALTER ROLE` system privilege
2. Run the `CREATE ROLE` or `ALTER ROLE` statement with the `IDENTIFIED GLOBALLY AS` clause specifying the name of the Entra ID application role.

For example, to create a new database global role named `widget_sales_role` and map it to an existing Entra ID application role named `WidgetManagerGroup`:

```
CREATE ROLE widget_sales_role IDENTIFIED GLOBALLY AS  
'AZURE_ROLE=WidgetManagerGroup';
```

8.4 Configuring Entra ID Client Connections to the Oracle Database

You can configure client connections to connect with the registered database.

- [About Configuring Client Connections to Entra ID](#)
There are three different ways for an Oracle Database client to use an Entra ID `OAuth2` token to send to the database for access.
- [Operational Flow for SQL*Plus Client Connection to Oracle Database Using Microsoft Entra ID `OAuth2` Token](#)
The connection between the Azure user, Entra ID, and an Oracle database relies on the passing of the `OAuth2` token throughout these three components.
- [Supported Client Drivers for Entra ID Connections](#)
Oracle Database supports several types of client drivers for Entra ID connections.
- [Registering a Client with Entra ID Application Registration](#)
This type of registration is similar to registering Oracle Database with Entra ID app registration.
- [Configuration of Clients to Work with Microsoft Entra ID Tokens](#)
Depending on the Oracle Database client, you can configure the client to either directly request the token from Entra ID or retrieve it from a file location.
- [Examples of Retrieving Entra ID `OAuth2` Tokens Outside an Oracle Database Client](#)
These examples show different ways that you can retrieve Entra ID `OAuth2` token separately from the database client if you are not using the database client to retrieve the tokens directly.
- [Creating a Network Proxy for the Database to Connect with the Internet](#)
This network proxy will enable the Oracle database to reach the Entra ID endpoint.
- [Using Centralized Entra ID Services for Net Naming and Secrets](#)
You can use the Azure app configuration and Azure Vault to centrally store net names and secrets.

8.4.1 About Configuring Client Connections to Entra ID

There are three different ways for an Oracle Database client to use an Entra ID OAuth2 token to send to the database for access.

- Connect to Entra ID endpoint directly and retrieve the token for the user (interactive flow).
- Retrieve the token from a file location (all supported Entra ID flows).
- Pass the token to the client by using the client API (all supported Entra ID flows).

Oracle Database supports several Entra ID flows for different use cases. You should review the details of each flow in the Microsoft documentation. Each database client can support different flows with different versions. Details of these types are available in the JDBC, ODP.NET, and other platform-specific client documentation for the supported Entra ID flows for the client. This section focuses on the use of the OCI and Instant Clients, which are also called thick clients.

The types of available flows are as follows:

- The interactive flow (also known as the OAuth2 authz flow) is the primary flow used by human actors. This flow requires an environment that can open a browser so that the user to enter their Entra ID credentials.
- The device code flow is supported by some clients, but not currently with the OCI and Instant Clients. This type of flow is also for human actors but for environments that cannot open a browser.
- The managed identity flow (supported by some clients, but not the OCI and Instant Clients) is for applications that run on Azure compute nodes and have access to the managed identity for the node.
- The client credential flow is designed for applications, especially if they are not running in an Azure environment.
- The Resource Owner Password Credential (ROPC) flow is not recommended for production use.

When a user must access the database as a human actor, Oracle recommends that you configure the interactive flow and configure the database client to retrieve the token directly from Entra ID. An application will need to use the client credential flow. Commonly, the application will use a script that is run periodically to retrieve a token from Entra ID and place it into a file location for the database client to use. If the application can be modified to integrate with the Entra ID SDK, then it can alternatively use the SDK to retrieve the token and pass it to the client using the client API.

You should choose the client connection method that works best with your use case. This guide provides examples of connecting SQL*Plus with different methods of getting an Entra ID OAuth2 access token. All Oracle Database release 19c clients can accept a token that is passed as a file or through the client API. The JDBC-thin, Instant Client, and ODP.net drivers also accept the token through the database client API from an application. Tools such as PowerShell or Azure CLI can retrieve the Entra ID OAuth2 access token for use by the client driver. To retrieve an Entra ID token, the client must be registered through the Entra ID app (application) registration process. Registering the client is similar to registering the Oracle Database server with Entra ID using the app registration. Both the database and client must be registered with Entra ID.

The database must be registered so the client can get permission to get an access token for the database. The client must be registered so that Entra ID can recognize a trusted client is asking for an access token.

See the following Microsoft Azure articles for more information about connecting clients to Entra ID:

- [Quickstart: Configure a client application to access a web API](#)
- [Choose the right Azure command-line tool](#)
- [Get Entra ID tokens by using the Microsoft Authentication Library](#)
- [Install the Azure CLI on Linux](#)

Related Topics

- *Oracle Database JDBC Developer's Guide*
- *Oracle Data Provider for .NET Developer's Guide*

8.4.2 Operational Flow for SQL*Plus Client Connection to Oracle Database Using Microsoft Entra ID OAuth2 Token

The connection between the Azure user, Entra ID, and an Oracle database relies on the passing of the OAuth2 token throughout these three components.

There are three ways for an Oracle Database client to send an Entra ID OAuth2 token to an Oracle database.

- Through the Oracle Database client
- By specifying a file location
- Using the the Oracle Database client API

Using an Oracle Database Client to Send the Entra ID OAuth2 Token to the Oracle Database

The Oracle Database client can request an OAuth2 token directly from the Entra ID endpoint. This method simplifies the required configuration. The following diagram shows the use of the interactive flow with a public client. The interactive flow is also called the OAuth2 authorization flow. See the [Microsoft identity platform and OAuth2.0 authorization code flow](#) Microsoft article for detailed information about the authorization flow.

Figure 8-3 Entra ID OAuth2 Tokens Sent to the Oracle Database Using Client

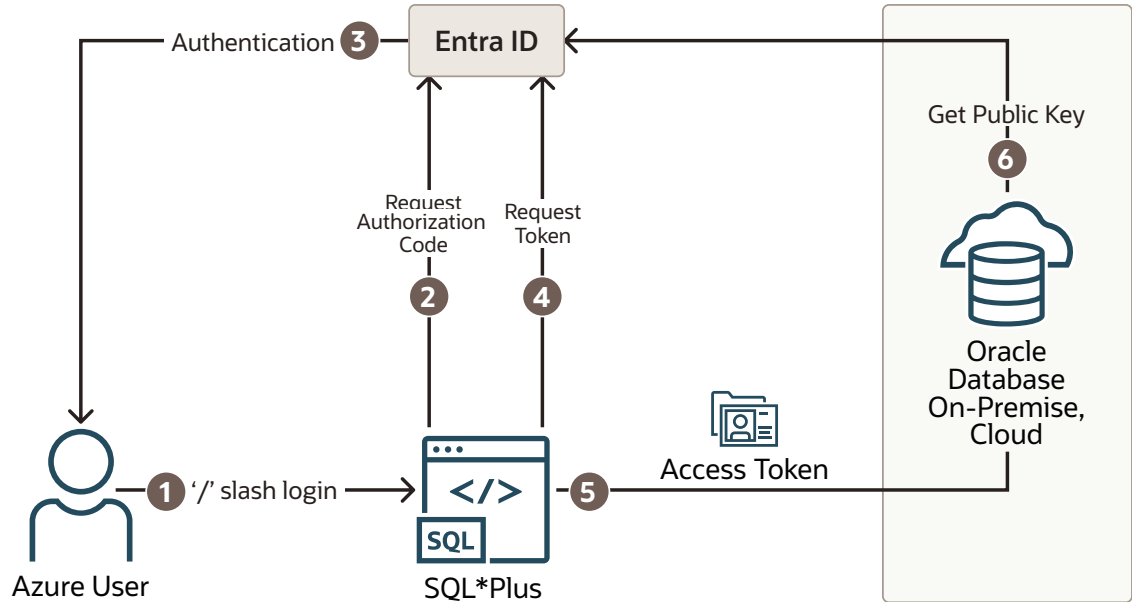

1. The user uses a / slash login to use the Azure SSO login. The connect string (or `sqlnet.ora`) includes all the parameters that are required for the Oracle Database client to get a token for the user.
2. The Oracle Database client connects with the Entra ID endpoint to request an authorization code.
3. If the user has not logged in with Entra ID, then a browser window opens and requests the user to enter their Azure SSO credentials.
4. The Oracle Database client requests an OAuth2 access token using the authorization code.
5. When the Oracle Database client receives the OAuth2 access token, it sends this token to the Oracle database.
6. The Oracle database verifies that the access token came from Entra ID (using the Entra ID public key) and then checks the token for additional claims. Next, the database finds the schema mapping (exclusive or shared) and creates the session. The database will also grant any global roles that the Azure user is also assigned to through an app role.

Specifying a File Location to Send the Entra ID OAuth2 Token to the Oracle Database

The following diagram illustrates how a file location can be used to send the Entra ID OAuth2 token to an Oracle database.

Figure 8-4 Entra ID OAuth2 Tokens Sent to the Oracle Database Using File Location

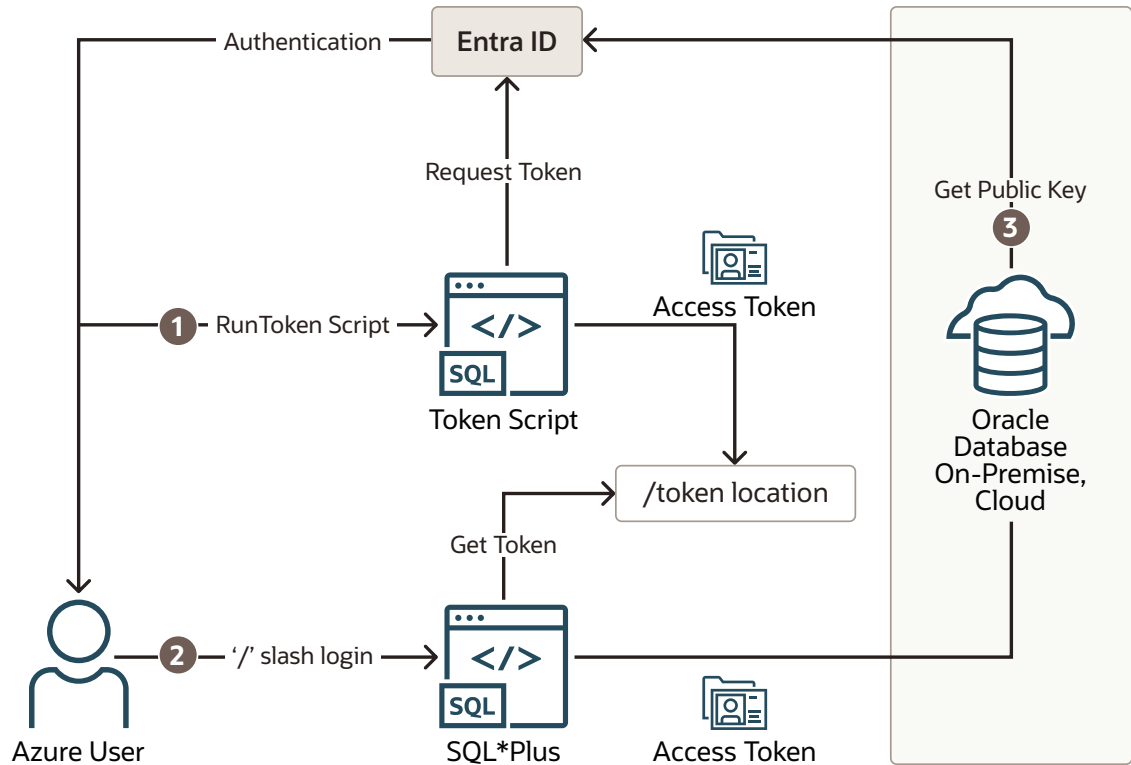

1. The Azure user requests an Entra ID access token for the database using a script and the returned token is written into a file called `token` at a file location. The Azure user may be requested to authenticate with Entra ID at this time.
2. The Azure user connects to the database using the `/ slash login`. Either the `sqlnet.ora` or `tnsnames.ora` connection string tells the Oracle Instant Client that an Entra ID OAuth2 token is needed and to retrieve it from a specified file location. The access token is then sent to the Oracle database.
3. The Oracle database verifies that the access token came from Entra ID (using the Entra ID public key) and then checks the token for additional claims. The database then finds the schema mapping (exclusive or shared) and creates the database session. The database will also grant any global roles that the Azure user is also assigned to through an app role.

Using the Oracle Database Client API to Send the Entra ID OAuth2 Token to the Oracle Database

The following diagram illustrates how the Oracle Database Client API can be used to send the Entra ID OAuth2 Token to the Oracle database.

Figure 8-5 Entra ID OAuth2 Tokens Sent to the Oracle Database Using the Client API

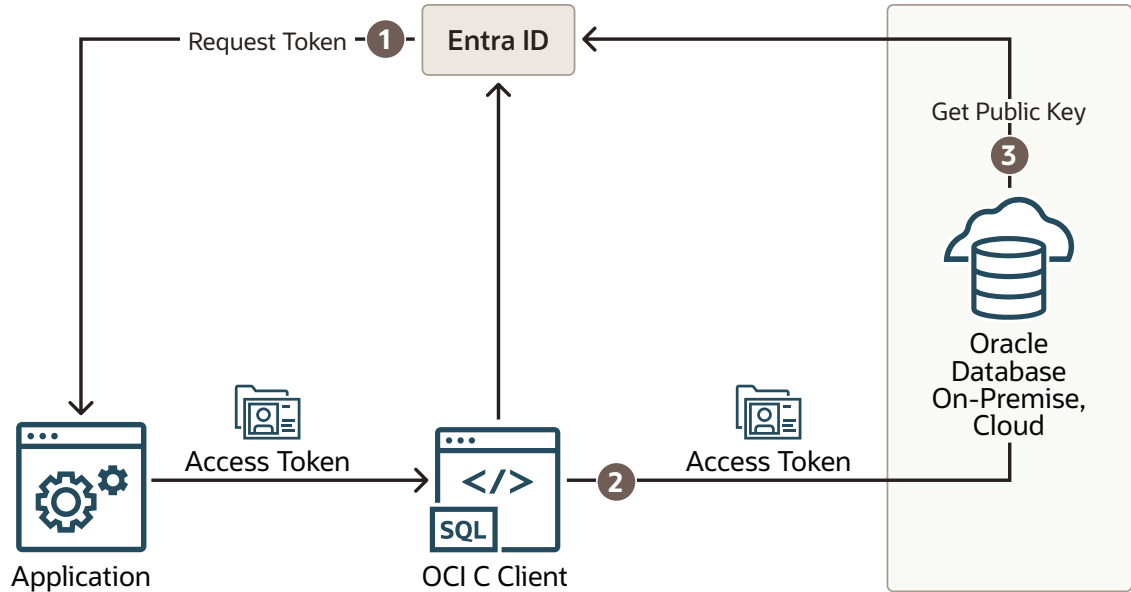

1. The application requests an Entra ID access token for the Oracle database using a script. The returned token is then sent to the database client using the client API. The token can represent the user (on-behalf-of token flow) or the application (client credential flow)
2. The Oracle Database client sends the access token to the Oracle database.
3. The Oracle database verifies that the access token came from Entra ID (using the Entra ID public key) and then checks the token for additional claims. The database finds the schema mapping (exclusive or shared) and creates the session. The database will also grant any global roles that the application or user is assigned to through an app role.

8.4.3 Supported Client Drivers for Entra ID Connections

Oracle Database supports several types of client drivers for Entra ID connections.

Oracle recommends that you use the latest quarterly patch for the supported versions because enhancements are added with the quarterly releases. In addition, some features will only exist in the Oracle Database 23ai version and will not be backported.

- **Thick clients (OCI C driver, Oracle Instant Client, Oracle Data Provider - Unmanaged (ODP.NET-Unmanaged), JDBC-thick, and others based on OCI C driver):** Oracle Database 19.16 (July 2022) and above, not supported with 21c, fully supported with Database 23ai
- **JDBC-thin:** Oracle Database 19.16 (July 2022), Oracle Database 21.8 (October 2022)
- **Oracle Data Provider (ODP.NET core, managed):** Oracle Database 19.16, Oracle Database 21.7
- **Python-thin:** 1.1.0+
- **Node.js-thin:** v6.3+

8.4.4 Registering a Client with Entra ID Application Registration

This type of registration is similar to registering Oracle Database with Entra ID app registration.

- [Confidential and Public Client Registration](#)
You can register the database client with Entra ID as either confidential or public depending on your use case.
- [Registering a Database Client App with Entra ID](#)
Creating the client app registration is similar to creating the Oracle Database instance with the Microsoft Entra ID tenancy.

8.4.4.1 Confidential and Public Client Registration

You can register the database client with Entra ID as either confidential or public depending on your use case.

See the Microsoft Azure article [Authentication flows and application scenarios](#) for detailed information about authentication flows and application scenarios.

Registering a confidential client app requires that the client have a secret, in addition to the client ID. The confidential client app uses both the client ID and the secret when it makes Entra ID requests. However, in an enterprise, it is not practical for every SQL*Plus and SQLcl user to create a separate app registration with its own secret. In addition, a secret is no longer a secret when you start to share it within an organization. It is far better to just create a public client app. A public client app does not have a secret; it only has a client ID. All database tool users can use the public client ID when they connect to Entra ID to get an access token. The Azure user still needs to authenticate to Entra ID with their own user credential.

8.4.4.2 Registering a Database Client App with Entra ID

Creating the client app registration is similar to creating the Oracle Database instance with the Microsoft Entra ID tenancy.

1. Log in to the Azure portal as an administrator who has Microsoft Entra ID privileges to register applications.
2. In the Azure Active directory admin center page, from the left navigation bar, select **Microsoft Entra ID**.
3. In the MS - App registrations page, select **App registrations** from the left navigation bar.
4. Select **New registration**.
5. In the Register an application page, enter the following Oracle Database client registration information:
 - In the **Name** field, enter a name for the client app (for example, *DatabaseClientApplication*).
 - Under Supported account types, select the account type that matches your use case.
 - **Accounts in this organizational directory only (tenant_name only - Single tenant)**
 - **Accounts in any organizational directory (Any Entra ID directory - Multitenant)**
 - **Accounts in any organizational directory (Any Entra ID directory - Multitenant) and personal Microsoft accounts (e.g. Skype, Xbox)**
 - **Personal Microsoft accounts only**
6. Under Redirect URI (optional), configure the redirect URI for the client app.

Redirect URI (optional)

We'll return the authentication response to this URI after successfully authenticating the user. Providing this now is optional and it can be changed later, but a value is required for most authentication scenarios.

Public client/native (mobile ...

- Select **Public client/native (mobile & desktop), Web, or Single-page application (SPA)**. Choose **Public client** if this client app will be used by multiple users such as database administrators who need to use SQL*Plus to access the Oracle Database instance.
- Add a redirect URI of `http://localhost`, unless you have another address to use. This redirect URI is needed for the authorization flow.

7. Click **Register**.

At this stage, the database client has been registered with Entra ID. Next, you must add the new client to the list of authorized client apps for the Oracle Database instance.

8. To add the new client to this list of client apps, do the following:

- Make a note of the new client's Application (client) ID. This ID is in the Overview page for the app.

The screenshot shows the 'Overview' page for a client application in the Microsoft Entra ID portal. The application name is 'DatabaseClientApplication'. The 'Essentials' section lists the following details:

- Display name: DatabaseClientApplication
- Application (client) ID: 76591191-fa75-47b1-9d4c-d314fb7e769e
- Object ID: 364940c1-edeb-4615-97e0-b0ef6793b43
- Directory (tenant) ID: 443e3044-e82d-410a-8b0a-57498722241d
- Supported account types: My organization only

On the right side, there are links for 'Client credentials', 'Redirect URIs', 'Application ID URI', and 'Managed application in L...'.

- On the App registrations page, open the app registration page for the database server by selecting it from the menu.
- On the left side, select **Expose an API**.
- Scroll down on the main page until you see **Authorized client applications**.
- Select **+** to add a client application.
- Copy the new client's Application (client) ID to the **Client Id** field.

Authorized client applications

Authorizing a client application indicates that this API trusts the application and users should not be asked to consent when the client calls this API.

+ Add a client application

Client Id	Scopes
76591191-fa75-47b1-9d4c-d314fb7e769e	1

- Click **Add application**.

Related Topics

- [Quickstart: Register an application with the Microsoft identity platform](#)

8.4.5 Configuration of Clients to Work with Microsoft Entra ID Tokens

Depending on the Oracle Database client, you can configure the client to either directly request the token from Entra ID or retrieve it from a file location.

- [Configuring Clients to Work with Microsoft Entra ID Tokens](#)
There are different ways to configure your database client to work with Entra ID OAuth2 access tokens.
- [Enabling Clients to Directly Retrieve Entra ID Tokens](#)
You can set parameters to enable clients to directly retrieve Entra ID tokens on their own.
- [Client Credential Flow](#)
The client credential flow allows on-premises applications and applications in non-Azure cloud environments to get an MS-EI OAuth2 token to connect to the Oracle Database.
- [Enabling Clients to Retrieve Entra ID Tokens from a File Location](#)
If you choose to retrieve the Entra ID location from a file location when you use the / slash login, then you will need to configure your client.
- [Using Azure App Configuration Store for Network Service Configuration Information](#)
You can store connect string and other network configuration information in Azure App Configuration Store.

8.4.5.1 Configuring Clients to Work with Microsoft Entra ID Tokens

There are different ways to configure your database client to work with Entra ID OAuth2 access tokens.

Depending on your use case (flow), the database client can directly request the OAuth2 token from the Entra ID endpoint. In other cases, a separate utility will need to be run to get the token and put it into a file location for use by the database client. An application can also use the Azure SDK to get a token and send it through the database client API. Refer to the database client specific documentation for using the client API and for client configuration information. Before you can request a token from Entra ID, you must perform the following configuration.

1. Ensure that you have an Azure user account.
2. Check with an Entra ID administrator or Oracle Database administrator for one of the following:
 - An application client ID that you can use to get Entra ID tokens. If you have Entra ID privileges to do so, then create your own client app registration, similar to registering the Oracle Database instance with an Entra ID tenancy.
 - You are mapped to a global schema in the database either directly or through an app role.
3. Ensure that you are using the latest release updates for the Oracle Database client releases 19c or 23ai and later.

Entra ID integration is not supported with Oracle Database 21c.

A TLS connection is required between the database client and the database server to pass OAuth2 tokens. You can use TLS (server authentication) or mTLS (client and server authentication). If your database client and platform support it, then you can simply use your system default certificate store when using TLS and not use a wallet. In addition to using TLS, you must specify either partial or full DN matching (`SSL_SERVER_DN_MATCH = ON`).

8.4.5.2 Enabling Clients to Directly Retrieve Entra ID Tokens

You can set parameters to enable clients to directly retrieve Entra ID tokens on their own.

Oracle Database clients differ by platform and version for what flows they support. The following table shows what each client can support.

Table 8-1 Parameters to Directly Retrieve Tokens

Database Clients	Passing Using Client API	Using File Location	Database Client Direct Support
Thick clients (OCI C driver, Instant Clients Along with platform specific drivers that use the thick client (for example, JDBC-thick, ODP.NET unmanaged, Python-thick)	Client versions 19.16+, not 21c, all 23ai Supported for all flows (interactive, client credential, OBO, ROPC)	Client versions 19.16+, not 21c, all 23ai Supported for all flows (interactive, client credential, OBO, ROPC)	Client version 23.4+ Interactive flow support only
JDBC-thin	Client versions 19.16+, 21.7+, all 23ai Supported for all flows (interactive, client credential, OBO, ROPC)	Client versions 19.16+, 21.7+, all 23ai Supported for all flows (interactive, client credential, OBO, ROPC)	Client version 23ai Supports the following flows (interactive, device code, client credential, managed identity, OBO, ROPC)
ODP.NET core, managed	Client versions 19.16+, 21.7+, all 23ai Supported for all flows (interactive, client credential, OBO, ROPC)	Client versions 19.16+, 21.7+, all 23ai Supported for all flows (interactive, client credential, OBO, ROPC)	Client version 23ai Supports the following flows (interactive, device code, client credential, managed identity, OBO, ROPC)
Python-thin	Not supported	Not supported	Not supported
Node.js	Not supported.	Not supported	Not supported

The connect string parameters are common across the database clients. Refer to each database client documentation (JDBC-thin, ODP.NET core, managed) for more specific information regarding this feature with those drivers. The following information is specifically for the OCI thick client/Instant client. However, the information about connect string parameters will remain consistent across the drivers.

To enable this feature in the client to get a token directly from Entra ID for a supported flow, you must set the following parameters in either the client's `sqlnet.ora` file or in a connect string. The connect string takes precedence over `sqlnet.ora`.

In order for the database client to retrieve the Entra ID OAuth2 token, the database client must be able to connect with the Entra ID endpoint. If you are working behind a firewall, you may need to set a proxy to reach the internet. See the [Troubleshooting Microsoft Entra ID Connections](#) section if you're not sure if you are able to connect to the internet.

Table 8-2 Parameters to Directly Retrieve Tokens

Parameter	Description
TOKEN_AUTH	<p>Sets the token authentication. This parameter is mandatory when you are asking the database client to get the database token or pick it up from a file location. This parameter is not required when you are passing the token through the client API. Enter one of the following values:</p> <ul style="list-style-type: none"> AZURE_INTERACTIVE tells the driver that it must use the Entra OAuth2 interactive (OAuth2 authorization) flow to get an access token for the database. This configures the database client to get the token directly from Entra ID without having to use an external script. This is for human users who are logging into tools such as SQLcl and can also open a browser window in their environment to authenticate AZURE_DEVICE_CODE signals the database driver to follow the device code flow for requesting an Entra ID access token. This is also for human users, when their environment cannot open a browser: a command line only environment. A device code and Entra ID login URL is written out to the standard output of the tool and the user logs into Entra ID on their cellphone or laptop, and then enters the device code. Users are authenticated through a separate channel and then allowed to continue access the database if the authentication is successful. AZURE_MANAGED_IDENTITY enables the driver to authenticate as an identity that has been assigned to the host system. The host system must be a resource which is managed by Entra ID, such as a virtual machine. AZURE_SERVICE_PRINCIPAL enables the driver to authenticate using a secret or certificate of the registered application.
CLIENT_ID	The unique application (client) ID assigned to your app by Entra ID when the app was registered. This app is your database client that will request to get an access token for the database for the user. This is not the client ID for the database server.
AZURE_DB_APP_ID_URI	The application ID URI is a URI that uniquely identifies the database in your Entra ID. You get this value from the overview screen of your database Entra ID app registration.
TENANT_ID	Specifies the Azure tenancy ID of the database.
REDIRECT_URI	Optional parameter for setting the port number for the HTTP server. This URL obtains the authorization code from the Entra authentication endpoint and determines which port to use to receive the authorization code. If REDIRECT_URI is not set, then the default is <code>http://localhost:8400</code> . If 8400 is already in use, then Oracle Database tries the next available number after 8400, ranging from 8400 to 90000. If you explicitly specify an unavailable port number, then the connection fails.

See *Oracle Database Net Services Reference* for specific information about each parameter. The following is an example of specifying use of interactive flow to get a token.

```
conn /@ (DESCRIPTION= (ADDRESS= (PROTOCOL=tcps) (HOST=example.us-
phoenix-1.oraclecloud.com) (PORT=6010) )
```

```
(SECURITY=(SSL_SERVER_DN_MATCH=YES)
(AZURE_DB_APP_ID_URI=https://oracleddevelopment.onmicrosoft.com/
11111111-11a1-1a11-111a-a11a11111111)
(TENANT_ID=1a111aa1-a1a1-1a11-a1a1-a11aaaaa1111)
(CLIENT_ID=aa11a111-111a-1a11-1aa1-1aa1a1aa1111)
(TOKEN_AUTH=AZURE_INTERACTIVE))
(CONNECT_DATA=(SERVICE_NAME=cdb1_pdb3.regress.rdbms.dev.us.oracle.com)))
```

8.4.5.3 Client Credential Flow

The client credential flow allows on-premises applications and applications in non-Azure cloud environments to get an MS-EI OAuth2 token to connect to the Oracle Database.

The client credential flow is supported using the token file passing method and through the OCI-C client API since Oracle Database 19c (not Oracle Database 21c). The Oracle Database 23ai OCI-C client also supports getting the MS-EI OAuth2 token directly from the MS-EI endpoint without requiring a script to initially get the token. In order to get the token for the Client Credential flow, the client will need a client ID and a client secret from MS-EI when the application is registered using MS-EI app registration. This is different than when setting up a public client for DBAs to connect to the database using the interactive flow. A public client doesn't need a client secret since the human user will be signing into Azure using their credentials. In the client credential flow, the application must have a client secret to authenticate to MS-EI and get a token. Since the client secret is sensitive, we recommend using an Oracle Wallet to store the client ID and client secret.

There are a few differences between the client used for interactive flow (for human users) and the client credential flow (for applications). In the interactive flow, users and groups are mapped to the database app roles in MS-EI enterprise applications. With the client credential flow, the client application can only be mapped to a database app role directly.

Follow the below steps to configure client credential flow between the Oracle Database and Microsoft Entra ID.

Register the Oracle Database with Microsoft Entra ID

Follow the below Microsoft documentation to create an app registration for the application client:

1. [Register an application](#)
2. [Expose scopes in web API registrations](#)
3. [Grant scopes permission to web API](#)

Ensure that you:

- You are an owner of the database app
- Create an app role in the database app for the application
- Create a client secret for the application client app
- Create an API permission to connect to the database app and grant consent to it

Create an application role mapping in Oracle Database

In the previous step you created a new application role. You now have to create a schema mapping in the database and grant the appropriate roles and privileges to the schema for the new role.

1. Log in to the Oracle Database instance as a user who has the `CREATE USER` or `ALTER USER` system privilege.
2. Run the `CREATE USER` or `ALTER USER` statement with the `IDENTIFIED GLOBALLY AS` clause specifying the Azure application role name.
For example, to create a new database global user account (schema) named `hr_app` and map it to an existing Entra ID application role named `hrapp`:

```
CREATE USER hr_app IDENTIFIED GLOBALLY AS 'AZURE_ROLE=HRAPP';
```

Configure the Oracle Call Interface (OCI-C) client for client credential flow

You must define parameters for the OCI-C client to get an OAuth2 token for the application credential flow.

The following parameters can be defined either in the `sqlnet.ora` file or in the `tnsnames.ora` file. Parameters in the `tnsnames.ora` file will have precedence over the same parameter in `sqlnet.ora`.

Parameter	Value	Usage Notes
<code>TOKEN_AUTH</code>	<code>AZURE_SERVICE_PRINCIPAL</code>	This tells the OCI-C driver to follow the client credential flow
<code>TENANT_ID</code>	The tenancy ID for the application app registration	This may or may not be the same tenancy for the database app registration
<code>AZURE_DB_APP_ID_URI</code>	This is from the database app registration	This was configured when creating the database app registration
<code>CLIENT_ID</code>	This is the client ID for the application app registration	This is not the client id from the database app registration
<code>AZURE_CREDENTIALS</code>	This is the location of the wallet holding the client secret	

Here is a sample connect string:

```
conn2=
  (DESCRIPTION=
    (ADDRESS=
      (PROTOCOL=tcps)
      (HOST=phoenix99201)
      (PORT=6679)
    )
    (SECURITY=
      (SSL_SERVER_CERT_DN="C=US,O=OracleCorporation,CN=sslserver3")
      (TOKEN_AUTH=AZURE_SERVICE_PRINCIPAL)
      (TENANT_ID=aaaaaaaa-bbbb-cccc-eeee)
      (AZURE_DB_APP_ID_URI=https://examplecorp.onmicrosoft.com/aaaa-
bbbb-cccc-dddd)
      (CLIENT_ID=aaaa-bbbb-cccc-dddd-eeee)
      (AZURE_CREDENTIALS=/scratch/secret)
    )
    (CONNECT_DATA=
      (SERVICE_NAME=database.examplecorp.com)
    )
  )
```

The first four parameter values can be in the connect string or `sqlnet.ora` file. But the client secret needs to be in the wallet with the location identified by `AZURE_CREDENTIALS`.

The client secret is paired with the client ID in the wallet. The database driver will look up the client secret in the wallet using the `CLIENT_ID` parameter. The client ID is a case sensitive parameter so the case for the client ID in the wallet must match the case of the client ID in the connect string or `sqlnet.ora`.

When you display the wallet content, you will find something similar to:

```
oracle.security.azure.credential.<client id> = <client secret>
```

The `CLIENT_ID` and `CLIENT_SECRET` is obfuscated/encrypted in the wallet and only user with right privilege can open/view the value.

Create the wallet for storing the client secret

Use `orapki` to create the wallet and store the client secret.

1. Create a wallet and set the wallet password:

```
orapki wallet create -wallet . -auto_login_only
```

2. Create an entry with the client id and client secret:

```
orapki secretstore create_entry -wallet . -alias  
oracle.security.azure.credential.<CLIENT_ID> -secret <CLIENT_SECRET>
```

- Display the entry:

```
orapki wallet display -wallet .
```

- Show a specific entry:

```
orapki secretstore view_entry -wallet . -alias  
oracle.security.azure.credential.<CLIENT_ID>
```

- Modify the entry:

```
orapki secretstore modify_entry -wallet . -alias  
oracle.security.azure.credential.<CLIENT_ID> -secret <CLIENT_SECRET>
```

- Delete the entry:

```
orapki secretstore delete_entry -wallet . -alias  
oracle.security.azure.credential.<CLIENT_ID>
```

Related Topics

- [orapki Utility Commands Summary](#)

The `orapki` commands perform a variety of wallet, certificate revocation lists (CRL), and certificate management tasks.

8.4.5.4 Enabling Clients to Retrieve Entra ID Tokens from a File Location

If you choose to retrieve the Entra ID location from a file location when you use the / slash login, then you will need to configure your client.

You can configure the Entra ID file location in either the `sqlnet.ora` file or the `tnsnames.ora` file.

- On the client, set or check the following parameters in the `tnsnames.ora` connect string or in the `sqlnet.ora` file:
 - `SSL_SERVER_DN_MATCH`: Ensure that this parameter is set to `ON` so that DN matching is enabled.
 - `TOKEN_AUTH`: Set this parameter to `OAUTH`.
 - `TOKEN_LOCATION`: Set this parameter to the file location of the token. There is no default location for the token. If the token is named `token`, then you only need to specify the file directory (for example, `/test/oracle/aad-token`). If the token name is different from `token` (for example, `azure.token`), then you must include this name in the path (for example, `/test/oracle/aad-token/azure.token`).

The parameter values in the `tnsnames.ora` connect string take precedence over the `sqlnet.ora` settings for that connection. The following code is an example of a `tnsnames.ora` entry. In this case, `SSL_SERVER_DN_MATCH` is specified in `sqlnet.ora` and will not appear in the connect string:

```
(description=
  (retry_count=20) (retry_delay=3)
  (address=(protocol=tcps) (port=1522)
  (host=example.us-phoenix-1.oraclecloud.com))

(connect_data=(service_name=aaabbbccc_exampledb_high.example.oraclecloud.com))
  (security=(ssl_server_cert_dn="CN=example.uscom-east-1.oraclecloud.com,
    OU=Oracle BMCS US, O=Example Corporation,
    L=Redwood City, ST=California, C=US")
  (TOKEN_AUTH=OAUTH) (TOKEN_LOCATION="/oracle/tokens/aad-token"))
```

After the connect string is updated with these parameters, the Azure user can log in to the Oracle Database instance by first running the external utility to get the token and then running the following command to start SQL*Plus. You can include the connect descriptor itself or use the name of the descriptor from the `tnsnames.ora` file.

```
connect /@exampledb_high
```

The database client is already configured to get an Azure OAuth2 token because `TOKEN_AUTH` has already been set, either through the connect string or the `sqlnet.ora` file. The database client gets the OAuth2 token and then sends the token to the Oracle Database instance.

8.4.5.5 Using Azure App Configuration Store for Network Service Configuration Information

You can store connect string and other network configuration information in Azure App Configuration Store.

See [Azure App Configuration Store](#) in the *Oracle Database Net Services Administrator's Guide* for more information.

8.4.6 Examples of Retrieving Entra ID OAuth2 Tokens Outside an Oracle Database Client

These examples show different ways that you can retrieve Entra ID OAuth2 token separately from the database client if you are not using the database client to retrieve the tokens directly.

- [About Examples of Retrieving Microsoft Entra ID OAuth2 Tokens Outside of an Oracle Database Client](#)
Oracle Database clients have differing abilities in directly retrieving an Entra ID OAuth2 token.
- [Example: Requesting a Token Using a Python Script for the Interactive \(Authorization\) Flow](#)
The interactive (authorization) flow is the most common for human users to access the database.
- [Example: Requesting a Token Using Azure CLI for the Interactive \(Authorization\) Flow](#)
This example shows how to use the Azure CLI to retrieve an access token and then write the token to a file.
- [Requesting a Token Using the Azure CLI for the Client Credential Flow](#)
The client credential flow is used for applications that need to use an Entra ID OAuth2 token to access the database.

8.4.6.1 About Examples of Retrieving Microsoft Entra ID OAuth2 Tokens Outside of an Oracle Database Client

Oracle Database clients have differing abilities in directly retrieving an Entra ID OAuth2 token.

Review the specific client documentation for configuring the database client to retrieve tokens for different flows. The other two ways to work with Entra ID tokens are as follows:

- Passing tokens by using the client API
- Passing tokens through the file system

Review the client documentation on using the API. A utility or script is used to request a token from Entra ID and store it in a file location for the database client to pick up. Using a script or utility to request and store the token is outside Oracle Database. There are many examples available from Microsoft and others on the internet on how to get an Entra ID token. (Also search for Azure AD OAuth2 token). The samples in this section are just some examples and not supported by Oracle.

8.4.6.2 Example: Requesting a Token Using a Python Script for the Interactive (Authorization) Flow

The interactive (authorization) flow is the most common for human users to access the database.

If the user has not already logged into their Azure account, they will be prompted with a web page to enter their Azure credentials. They will also need to complete any multi-factor authentication required by the organization before they retrieve the database OAuth2 access token. This example with the Microsoft Authentication Library (MSAL) is in Python and can be run on a variety of platforms such as Windows PowerShell and Linux. Because the

authorization flow requires two round trips to Azure AD, it is best handled using the MSAL. See the Microsoft article [Get Entra ID tokens by using the Microsoft Authentication Library](#) for how to use a python script with MSAL. These instructions are for the Databricks service, but the scope is changed to the database App ID URI and scope instead of the Databricks scope.

1. Bypass the steps to set up the client app registration, since you have already accomplished that step except make sure you add a Redirect URI (`http://localhost`) for your client app registration.
2. Go directly to **Get Entra ID tokens by using the MSAL Python library**.

You will need the Directory (tenant) ID, Client ID for the public app client, and the database App ID URI and scope. You will see a code section for **scopes** with directions to not modify this variable. Because this python code was written for Databricks scope, you will need to change this scope variable to the scope of your database. For example:

```
scopes = ['https://example.com/1111a1a1-a1aa-1a11-11aa-1a1a11a11111/
session:connect']
```

3. Modify the code to write the token to a file location.

Use the following example code and append it to the print statements at the end. Note the extra lines to back up and restore the original `stdout`.

```
stdout_backup = sys.stdout
with open('token', 'w') as token_file:
    sys.stdout = token_file
    print(acquire_tokens_result['access_token'])

sys.stdout = stdout_backup
```

8.4.6.3 Example: Requesting a Token Using Azure CLI for the Interactive (Authorization) Flow

This example shows how to use the Azure CLI to retrieve an access token and then write the token to a file.

See the Microsoft article [Install the Azure CLI on Linux](#) for information about installing the Azure CLI.

1. Log in to your Azure tenancy.

```
$ az login
```

2. Get an access token and assign it to the token variable using the following syntax:

```
token=$(az account get-access-token --resource=database_app_id_uri --query
accessToken --output tsv)
```

For example:

```
token=$(az account get-access-token --resource=https://example.com/
1111a1a1-a1aa-1a11-11aa-1a1a11a11111 --query accessToken --output tsv)
```

If you get an Azure CLI error saying that the client app ID does not have permission to access the database resource, then copy the client app ID from the error message and

add it to the list of authorized client applications for the database resource. (Go to the database app registration in Entra ID, click **Expose an API** and then **Add a client application**).

3. Write the token to a file.

```
$ echo "$token" >> token
```

8.4.6.4 Requesting a Token Using the Azure CLI for the Client Credential Flow

The client credential flow is used for applications that need to use an Entra ID OAuth2 token to access the database.

Because applications are "headless" and do not have a user to authenticate interactively with the Azure portal, the interactive flow cannot be used with applications. The client credential flow is designed for applications. In these flows, the application app registration requires a client secret along with the client ID. These are used to retrieve the Entra ID OAuth2 database access token.

After the script gets the token, this token will need to be written to a file (as shown in the examples in this section) so that the database client can access it. Microsoft provides several examples for a service principal to request a token. See then Microsoft article [Get Microsoft Entra ID \(formerly Azure Active Directory\) tokens for service principals](#).

8.4.7 Creating a Network Proxy for the Database to Connect with the Internet

This network proxy will enable the Oracle database to reach the Entra ID endpoint.

- [About Creating a Network Proxy for the Database to Connect with the Internet](#)
The Oracle database must connect to Entra ID endpoints and it may require network configuration and default trust store access.
- [Testing the Accessibility of the Entra ID Endpoint](#)
You must ensure that your Oracle Database can access the Entra ID endpoint.
- [Creating the Network Proxy for the Default Oracle Database Environment](#)
To create the network proxy, you must set environment variables and then restart the listener.
- [Creating the Network Proxy for an Oracle Real Application Clusters Environment](#)
To create the network proxy, you must set an environment variable and then restart the database.
- [Creating the Network Proxy in the Windows Registry Editor](#)
To create the network proxy in a Windows environment, you must update the Registry Editor (`regedit`).

8.4.7.1 About Creating a Network Proxy for the Database to Connect with the Internet

The Oracle database must connect to Entra ID endpoints and it may require network configuration and default trust store access.

You can configure the database when HTTP network proxy is in place in an enterprise, for a default Oracle Database environment and for an Oracle Real Applications Clusters environment. The database establishes a Transport Layer Security (TLS) link to Entra ID, so it

also needs access to the default trust store on the database server. To enable this, ensure that the database server has access to the system default certificate store.

Related Topics

- [Certificate Store Location for System Wallets](#)
System wallets are located in the certificate store location.

8.4.7.2 Testing the Accessibility of the Entra ID Endpoint

You must ensure that your Oracle Database can access the Entra ID endpoint.

If your database client is configured to get Microsoft Entra ID OAuth2 tokens, then the database client must be able to access the Entra ID endpoint. Run the following command to check if you have internet access:

```
curl https://login.windows.net/common/discovery/keys
```

A status code of 200 indicates success.

Check with your IT help desk for the proxy information if you weren't successful running this command.

For an Oracle database to accept Entra ID OAuth2 tokens, the database must request the public key from the Microsoft Entra ID endpoint.

- Run the following test to determine if the database can connect with the Microsoft Entra ID endpoint:

```
SET SERVEROUTPUT ON SIZE 40000
DECLARE
    req UTL_HTTP.REQ;
    resp UTL_HTTP.RESP;
BEGIN
    UTL_HTTP.SET_WALLET(path => 'system:');
    req := UTL_HTTP.BEGIN_REQUEST('https://login.windows.net/common/
discovery/keys');
    resp := UTL_HTTP.GET_RESPONSE(req);
    DBMS_OUTPUT.PUT_LINE('HTTP response status code: ' || resp.status_code);
    UTL_HTTP.END_RESPONSE(resp);
END;
/
```

If this test is successful, then a PL/SQL procedure successfully completed message appears.

If the following messages appear, then it means that a database network access control list (ACL) policy blocked your test and you will need to temporarily set an access control list policy to allow you to test this:

```
ORA-29273: HTTP request failed
ORA-24247: network access denied by access control list (ACL)
```

1. Set the ACL as follows:

```
BEGIN
DBMS_NETWORK_ACL_ADMIN.APPEND_HOST_ACE(
  host => '*',
  ace => xs$ace_type(privilege_list => xs$name_list('connect'),
                    principal_name => 'username_placeholder',
                    principal_type => xs_acl.ptype_db));
END;
/
```

Replace *username_placeholder* with the user name of the database user who is running the test. For example:

```
BEGIN
DBMS_NETWORK_ACL_ADMIN.APPEND_HOST_ACE(
  host => '*',
  ace => xs$ace_type(privilege_list => xs$name_list('connect'),
                    principal_name => 'DBA_DEBRA',
                    principal_type => xs_acl.ptype_db));
END;
/
```

2. Try running the test again.

3. Remove the ACL, because you now no longer need it. For example, assuming your user name is *dba_debra*:

```
BEGIN
DBMS_NETWORK_ACL_ADMIN.REMOVE_HOST_ACE(
  host => '*',
  ace => xs$ace_type(privilege_list => xs$name_list('connect'),
                    principal_name => 'DBA_DEBRA',
                    principal_type => xs_acl.ptype_db));
END;
/
```

If the database cannot connect with the Microsoft Entra ID endpoint, even after you set the ACL policy, you will most likely need to set the `HTTP_PROXY` package for your database. Review the topics listed in Related Topics, depending if you are using a default Oracle Database environment or an Oracle Real Application Clusters RAC environment. Your network administrator should be able to tell you what the correct `HTTP_PROXY` setting should be.

Related Topics

- [Creating the Network Proxy for the Default Oracle Database Environment](#)
To create the network proxy, you must set environment variables and then restart the listener.
- [Creating the Network Proxy for an Oracle Real Application Clusters Environment](#)
To create the network proxy, you must set an environment variable and then restart the database.

8.4.7.3 Creating the Network Proxy for the Default Oracle Database Environment

To create the network proxy, you must set environment variables and then restart the listener.

You do not need to restart the database.

1. In the server where the Oracle database is installed, set the `http_proxy` environment variable.

For example:

```
export http_proxy=http://www-proxy-example.com:80/
```

2. Restart the listener.

```
lsnrctl stop  
lsnrctl start
```

 **Note:**

The `http_proxy` environment variable must be set. If the `https_proxy` environment variable is set, but not the `http_proxy` variable, then set the `http_proxy` environment variable to the same value set for the `https_proxy` environment variable.

8.4.7.4 Creating the Network Proxy for an Oracle Real Application Clusters Environment

To create the network proxy, you must set an environment variable and then restart the database.

1. In the server where the Oracle database is installed, set the `http_proxy` environment variable.

Use this syntax to set the network proxies. The proxy command that you enter must have `http://` preceding the proxy name and must have the port number at the end of the proxy:

```
http_proxy=http://.....:80/
```

For example:

```
srvctl setenv database -db db_name -env "http_proxy=http://www-  
proxy.example.com:80/"
```

2. Stop the database.

```
srvctl stop database -db db_name
```

3. Display the environment variable values to ensure that they are correctly set.

```
$ srvctl getenv database -db db_name
```

Output similar to the following should appear:

```
db_name:
http_proxy=http://www-proxy.example.com:80/
https_proxy=http://www-proxy.example.com:80/
```

4. Restart the database.

```
$ srvctl start database -db db_name
```

8.4.7.5 Creating the Network Proxy in the Windows Registry Editor

To create the network proxy in a Windows environment, you must update the Registry Editor (regedit).

1. Start the Registry Editor (regedit).
2. Locate the `\HKEY_LOCAL_MACHINE\SYSTEM\CurrentControlSet\Services\OracleServiceversion` key.
3. Select this key, and then in the right panel, locate **Environment**.
4. Edit **Environment** to add a new multi-string value to it.

The following example uses the domain of `example.com`:



5. Click **OK**.
6. Restart the database server.

For example:

```
net start Oracle_service_name
sqlplus "/as sysdba"
startup;
```

7. Open the PDBs.

```
ALTER PLUGGABLE DATABASE ALL OPEN;
```

8.4.8 Using Centralized Entra ID Services for Net Naming and Secrets

You can use the Azure app configuration and Azure Vault to centrally store net names and secrets.

This functionality is currently supported with the JDBC-thin and .NET-thin drivers.

See the following guides:

- *Oracle Database Net Services Administrator's Guide*
- *Oracle Database Net Services Reference*

8.5 Configuring Microsoft Entra ID Proxy Authentication

Proxy authentication allows an Azure user to proxy to a database schema for tasks such as application maintenance.

- [About Configuring Microsoft Entra ID Proxy Authentication](#)
Azure users can connect to Oracle Autonomous Database by using proxy authentication.
- [Configuring Proxy Authentication for the Azure User](#)
To configure proxy authentication for an Azure user, this user must already have a mapping to a global schema (exclusive or shared mapping). A separate database schema for the Azure user to proxy to must also be available.
- [Validating the Azure User Proxy Authentication](#)
You can validate the Azure user proxy configuration for token authentication.

8.5.1 About Configuring Microsoft Entra ID Proxy Authentication

Azure users can connect to Oracle Autonomous Database by using proxy authentication.

Proxy authentication is typically used to authenticate the real user and then authorize them to use a database schema with the schema privileges and roles in order to manage an application. Alternatives such as sharing the application schema password are considered insecure and unable to audit which actual user performed an action.

A use case can be in an environment in which a named Azure user who is an application database administrator can authenticate by using their credentials and then proxy to a database schema user (for example, `hrapp`). This authentication enables the Entra ID administrator to use the `hrapp` privileges and roles as user `hrapp` in order to perform application maintenance, yet still use their Entra ID credentials for authentication. An application database administrator can sign in to the database and then proxy to an application schema to manage this schema.

8.5.2 Configuring Proxy Authentication for the Azure User

To configure proxy authentication for an Azure user, this user must already have a mapping to a global schema (exclusive or shared mapping). A separate database schema for the Azure user to proxy to must also be available.

After you ensure that you have this type of user, alter the database user to allow the Azure user to proxy to it.

1. Log in to the Autonomous Database instance as a user who has the `ALTER USER` system privileges.
2. Grant permission for the Azure user to proxy to the local database user account.

An Azure user cannot be referenced in the command so the proxy must be created between the database global user (mapped to the Azure user) and the target database user.

In the following example, `hrapp` is the database schema to proxy to, and `peterfitch_schema` is the database global user exclusively mapped to user `peterfitch`.

```
ALTER USER hrapp GRANT CONNECT THROUGH peterfitch_schema;
```

At this stage, the Azure user can log in to the database instance using the proxy. For example:

```
CONNECT [hrapp]/@connect_string
```

8.5.3 Validating the Azure User Proxy Authentication

You can validate the Azure user proxy configuration for token authentication.

1. Log in to the Oracle Autonomous Database instance as a user who has the `CREATE USER` and `ALTER USER` system privileges.
2. Connect as the Azure user and run the `SHOW USER` and `SELECT SYS_CONTEXT` commands.

For example, suppose you want to check the proxy authentication of the Azure user `peterfitch` when they proxy to database user `hrapp`:

```
CONNECT [hrapp]/@connect_string
SHOW USER;
--The output should be USER is "HRAPP "
SELECT SYS_CONTEXT('USERENV','AUTHENTICATION_METHOD') FROM DUAL;
--The output should be "TOKEN_GLOBAL"
SELECT SYS_CONTEXT('USERENV','PROXY_USER') FROM DUAL;
--The output should be "PETERFITCH_SCHEMA"
SELECT SYS_CONTEXT('USERENV','CURRENT_USER') FROM DUAL;
--The output should be "HRAPP"
```

8.6 Configuring Microsoft Power BI Single-Sign On

Users have an option of a simpler configuration if only Power BI users will connect to the Oracle Database.

- [About Configuring Microsoft Power BI Single-Sign On](#)
Users of the Microsoft Power BI data visualization tool frequently also use Microsoft Entra ID (MSEI). These users want to use their MSEI Single Sign-On (SSO) credentials to access their Oracle data sources seamlessly.
- [Configuring the Oracle Database](#)
Configure the Oracle database to accept access tokens from Microsoft Power BI.
- [Authorizing the User](#)
The Power BI Azure AD user must be authorized to the database.
- [Connecting Power BI to Oracle Database using Microsoft Entra ID](#)
Once the database has been configured, you will need to configure Power BI Desktop or service.

8.6.1 About Configuring Microsoft Power BI Single-Sign On

Users of the Microsoft Power BI data visualization tool frequently also use Microsoft Entra ID (MSEI). These users want to use their MSEI Single Sign-On (SSO) credentials to access their Oracle data sources seamlessly.

Previously, Power BI users either had to access the Oracle Database using the database local username and password or had to migrate data from the Oracle Database to a different database if the security teams demanded centralized access management.

By using MSEI SSO to access Oracle data sources, security is improved since the users are centrally managed and Azure AD tokens are used instead of password credentials. Ease of use for DBAs is also improved since data can remain in the Oracle Database and not have to be migrated. Users also benefit since they can use their SSO to access their source database and not have to remember and continuously rotate their database password credentials.

Configuring Microsoft Power BI SSO is supported with:

- Oracle Database server 23ai (on-premises and cloud)
- Oracle Database server 19c (19.20 and above, on-premises and cloud)
- Any database client that supports MSEI tokens
See [Supported Client Drivers for Entra ID Connections](#) for more information.

The following diagram illustrates how MSEI SSO can be used to access the Oracle database used as a source for Microsoft Power BI.

Figure 8-6 Microsoft Entra ID Access Tokens Sent to the Oracle Database For Power BI

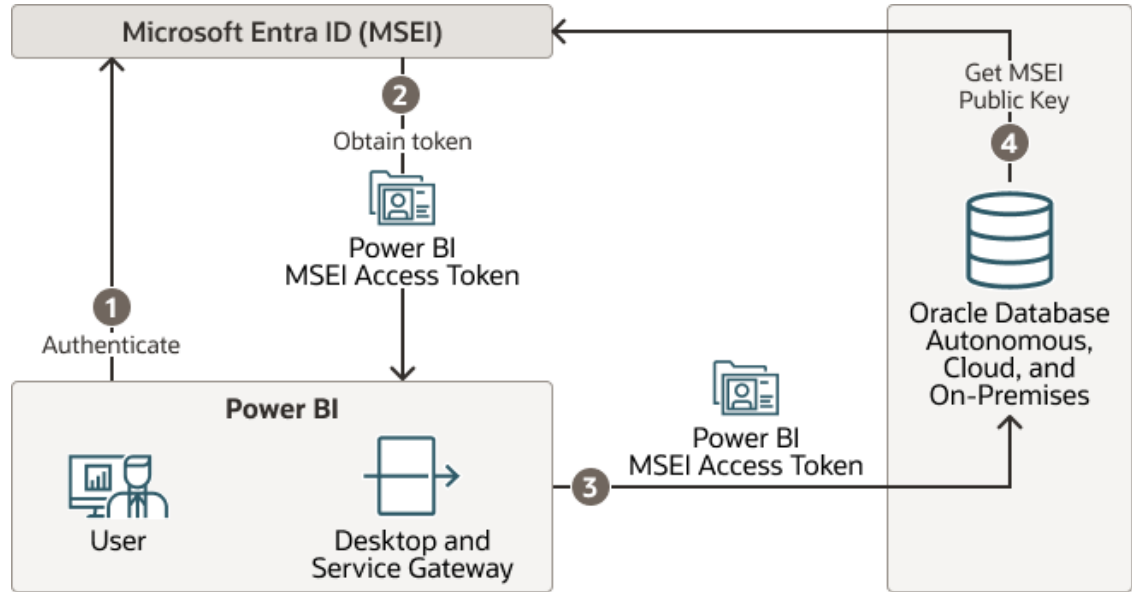

1. Power BI user authenticates themselves with MSEI
2. Power BI gets the user's access token for the database when a connection is opened to the database
3. Power BI sends the MSEI Power BI access token to the Oracle Database
4. The Oracle Database caches the MSEI public key to validate the MSEI Power BI token

Related Topics

- [Power BI Desktop: Connect to Oracle Database](#)
- [Power BI Serve: Connect to Oracle Database](#)
- [Configure the Oracle Database for Power BI \(video\)](#)
- [Configure Power BI Desktop \(video\)](#)
- [Microsoft Power BI documentation](#)

8.6.2 Configuring the Oracle Database

Configure the Oracle database to accept access tokens from Microsoft Power BI.

Prerequisites:

The Oracle database must be registered with MSEI app registration.

1. Set the external identity provider as Microsoft Entra ID:

```
ALTER SYSTEM SET IDENTITY_PROVIDER_TYPE=AZURE_AD SCOPE=BOTH;
```

2. Configure the external identify provider.

```
ALTER SYSTEM SET identity_provider_config='{ "application_id_uri":  
111-111-111, "tenant_id": "111-111-111", "app_id": "111-111-111" }';
```

**Note:**

The values `identity_provider_config` can be anything such as the "111-111-111" used in this example when working with Power BI access tokens

This configuration is specific for Power BI user SSO integration. Power BI user SSO integration is also supported with the full MSEI integration. The full MSEI integration allows both the Power BI user access as well as DBAs using SQLPlus and the MSEI interactive login and applications using client credential flow to access the database. The simpler Power BI SSO configuration described in this topic only allows Power BI users to access the database.

See [Configuring the Oracle Database for Microsoft Entra ID Integration](#) for more information about MSEI full integration.

8.6.3 Authorizing the User

The Power BI Azure AD user must be authorized to the database.

1. Log in to the Oracle database instance as a user who has the `CREATE USER` and `ALTER USER` system privileges.
2. Run the following command to create the Power BI Microsoft Entra ID user in the database:

```
CREATE USER <first_last> IDENTIFIED GLOBALLY AS  
'AZURE_USER=<first.last@example.com>';GRANT CREATE SESSION TO <first_last>;
```

All privileges and roles required by the user must be granted to the database schema/user. Power BI users cannot use a shared schema configuration; they can only use exclusive mapping to a schema.

8.6.4 Connecting Power BI to Oracle Database using Microsoft Entra ID

Once the database has been configured, you will need to configure Power BI Desktop or service.

Follow the instructions in this Oracle blog: [Microsoft Power BI can now connect with the Oracle Database using Microsoft Entra ID SSO tokens](#).

8.7 Troubleshooting Microsoft Entra ID Connections

You can use trace files to diagnose problems with Microsoft Entra ID connections. You also can easily remedy `ORA-12599` and `ORA-03114` errors.

- [Trace Files for Troubleshooting Oracle Database Client Connections with Entra ID](#)
You can use trace files to troubleshoot the Oracle Database integration with Entra ID.
- [ORA-12599 and ORA-03114 Errors Caused When Trying to Access a Database Using a Token](#)
The `ORA-12599: TNS: cryptographic checksum mismatch` and `ORA-03114: not connected to ORACLE` errors indicate that the database to which you are trying to connect is protected by native network encryption.

- [Checking the Entra ID Access Token Version](#)
You can check the version of the Entra ID access token that your site uses by using the JSON Web Tokens web site.

8.7.1 Trace Files for Troubleshooting Oracle Database Client Connections with Entra ID

You can use trace files to troubleshoot the Oracle Database integration with Entra ID.

- [About Trace Files Used for Troubleshooting Connections](#)
You can generate two levels of trace files to troubleshoot Entra ID connections on client side.
- [Setting Client Tracing for Token Authentication](#)
You can add `EVENT` settings to the client-side `sqlnet.ora` file to control client tracing.

8.7.1.1 About Trace Files Used for Troubleshooting Connections

You can generate two levels of trace files to troubleshoot Entra ID connections on client side.

The two levels of trace files that you can generate are as follows:

- Low level tracing prints traces in case of failures:
 - If TCPS is not set up for the Entra ID connection, then it prints a message that the protocol has to be TCPS.
 - If `SSL_SERVER_DN_MATCH` is not set to `TRUE`, then it prints a message that the value is `FALSE`.
 - If `TOKEN_LOCATION` has not been specified, then it prints a message that the token location does not exist.
 - If the token is not present at the specified `TOKEN_LOCATION`, then it prints a message.
 - If the application has passed in the token without setting `OCI_ATTR_TOKEN_ISBEARER` to `true`, it prints a message for the missing attribute.
 - If the application has set `OCI_ATTR_TOKEN_ISBEARER` to `TRUE` and not passed in the token, it prints a message for the missing attribute.
 - If the token has expired, then it prints a message.
 - If the token is a Microsoft Entra ID v2.0 token and it does not contain upn claim or roles claim, then it prints out a message that the needed claim is missing.
- High level tracing prints traces in case of failure as mentioned above. In addition, it prints traces in case of success, as follows:
 - It prints where `SSL_SERVER_DN_MATCH` is present, `tnsnames.ora` or `sqlnet.ora`. It also prints the value as `TRUE` if set to `TRUE`.
 - If both the token and `OCI_ATTR_TOKEN_ISBEARER=true` are set by the application, then it prints a message.
 - If `TOKEN_AUTH` has the correct value `OAUTH`, then it prints the value.
 - If the token is not expired, then it prints a message.
 - If the token is a Microsoft Entra ID v2.0 token and the upn claim or roles claim exist, then it prints out a message that the needed claim exists.

8.7.1.2 Setting Client Tracing for Token Authentication

You can add `EVENT` settings to the client-side `sqlnet.ora` file to control client tracing.

These `EVENT` settings can be used for both IAM and Entra ID connections with Oracle Database.

- Use either of the following methods:
 - Add the following settings to the client side `sqlnet.ora` file:
 - * `EVENT_25701=14` for low level tracing
 - * `EVENT_25701=15` for high level tracing
 - Set the environment variable `EVENT_25701`:
 - * `EVENT_25701=14` for low level tracing
 - * `EVENT_25701=15` for high level tracing

Client trace files are created in the following locations:

- **Linux:** `$ORACLE_HOME/log/diag/clients`
- **Windows:** `%ORACLE_HOME%\log\diag\clients`

You can use the `ADR_BASE` parameter in the client side `sqlnet.ora` to specify the directory in which tracing messages are stored. Ensure that the directory path is valid and has write permissions. Ensure that the `DIAG_ADR_ENABLED` parameter is not set to `FALSE`.

An example of setting `ADR_BASE` is as follows:

```
ADR_BASE=/oracle/oauth2/trace
```

8.7.2 ORA-12599 and ORA-03114 Errors Caused When Trying to Access a Database Using a Token

The `ORA-12599: TNS: cryptographic checksum mismatch` and `ORA-03114: not connected to ORACLE` errors indicate that the database to which you are trying to connect is protected by native network encryption.

When tokens are being used to access an Oracle database, a Transport Layer Security (TLS) connection must be established, not network native encryption. To remedy these errors, ensure that TLS is properly configured for your database. You should test the configuration with a local database user name and password and check the following `SYSCONTEXT` `USERENV` parameters:

- `NETWORK_PROTOCOL`
- `TLS_VERSION`

Related Topics

- [Configuring PKI Certificate Authentication](#)
You can configure Oracle Database to use PKI certificates for end-user authentication.

8.7.3 Checking the Entra ID Access Token Version

You can check the version of the Entra ID access token that your site uses by using the JSON Web Tokens web site.

By default, Entra ID v1 access token, but your site may have chosen to use v2. Oracle Database supports v1 tokens and Autonomous Database Serverless supports v2 tokens, as well. If you want to use the v2 access tokens, then you can enable their use for the Oracle database. To find the version of the Entra ID access token that you are using, you can either check with your Entra ID administrator, or confirm the version from the JSON Web Tokens website, as follows.

1. Go to the JSON Web Tokens website.

```
https://jwt.io/
```

2. Copy and paste the token string into the **Encoded** field.
3. Check the **Decoded** field, which displays information about the token string.

Near or at the bottom of the field, you will see a claim entitled `ver`, which indicates either of the following versions:

- `"ver": "1.0"`
- `"ver": "2.0"`

Related Topics

- [Enabling Microsoft Entra ID v2 Access Tokens](#)
Oracle Database supports integration with the v1 and v2 Azure AD OAuth2 access token.

9

Managing Security for Definer's Rights and Invoker's Rights

Invoker's rights and definer's rights have several security advantages when used to control access to privileges during user-defined procedure executions.

- [About Definer's Rights and Invoker's Rights](#)
Definer's rights and invoker's rights are used to control access to privileges during user-defined procedure executions necessary to run a user-created procedure, or program unit.
- [How Procedure Privileges Affect Definer's Rights](#)
The owner of a procedure, called the *definer*, must have the necessary object privileges for objects that the procedure references.
- [How Procedure Privileges Affect Invoker's Rights](#)
An invoker's rights procedure runs with all of the invoker's privileges.
- [When You Should Create Invoker's Rights Procedures](#)
Oracle recommends that you create invoker's rights procedures in certain situations.
- [Controlling Invoker's Rights Privileges for Procedure Calls and View Access](#)
The `INHERIT PRIVILEGES` and `INHERIT ANY PRIVILEGES` privileges regulate the privileges used when invoker's rights procedures are run.
- [Definer's Rights and Invoker's Rights in Views](#)
The `BEQUEATH` clause in the `CREATE VIEW SQL` statement can control definer's rights and invoker's rights in user-created views.
- [Using Code Based Access Control for Definer's Rights and Invoker's Rights](#)
Code based access control, used to attach database roles to PL/SQL functions, procedures, or packages, works well with invoker's rights and definer's procedures.
- [Controlling Definer's Rights Privileges for Database Links](#)
You can control privilege grants for definer's rights procedures if your applications use database links and definer's rights procedures.

9.1 About Definer's Rights and Invoker's Rights

Definer's rights and invoker's rights are used to control access to privileges during user-defined procedure executions necessary to run a user-created procedure, or program unit.

In a definer's rights procedure, the procedure runs with the privileges of the owner, not the current user. The privileges are bound to the schema in which they were created. An invoker's rights procedure runs with the privileges of the current user, that is, the user who invokes the procedure. These procedures are not bound to a particular schema. They can be run by a variety of users and allow multiple users to manage their own data by using centralized application logic. Invoker's rights procedures are created with the `AUTHID` clause in the declaration section of the procedure code.

For example, suppose user `bixby` creates a procedure that is designed to modify table `cust_records` and then grants the `EXECUTE` privilege on this procedure to user `rlayton`. If `bixby` had created the procedure with definer's rights, then the procedure would look for table

`cust_records` in `bixby`'s schema. Had the procedure been created with invoker's rights, then when `rlayton` runs it, the procedure would look for table `cust_records` in `rlayton`'s schema.

By default, all procedures are considered definer's rights. You can designate a procedure to be an invoker's rights procedure by using the `AUTHID CURRENT_USER` clause when you create or modify it, or you can use the `AUTHID DEFINER` clause to make it a definer's rights procedure.

You can create privilege analysis policies to capture privilege use of definer's rights and invoker's rights procedures.

Related Topics

- [Performing Privilege Analysis to Identify Privilege Use](#)
Privilege analysis dynamically analyzes the privileges and roles that users use and do not use.
- [Oracle Database PL/SQL Language Reference](#)

9.2 How Procedure Privileges Affect Definer's Rights

The owner of a procedure, called the *definer*, must have the necessary object privileges for objects that the procedure references.

If the procedure owner grants to another user the right to use the procedure, then the privileges of the procedure owner (on the objects the procedure references) apply to the grantee's exercise of the procedure. The privileges of the procedure's definer must be granted directly to the procedure owner, not granted through roles. These are called definer's rights.

The user of a procedure who is not its owner is called the *invoker*. Additional privileges on referenced objects are required for an invoker's rights procedure, but not for a definer's rights procedure.

A user of a definer's rights procedure requires only the privilege to run the procedure and no privileges on the underlying objects that the procedure accesses. This is because a definer's rights procedure operates under the security domain of the user who owns the procedure, regardless of who is executing it. The owner of the procedure must have all the necessary object privileges for referenced objects. Fewer privileges need to be granted to users of a definer's rights procedure. This results in stronger control of database access.

You can use definer's rights procedures to control access to private database objects and add a level of database security. By writing a definer's rights procedure and granting only the `EXECUTE` privilege to a user, this user can be forced to access the referenced objects only through the procedure.

At run time, Oracle Database checks whether the privileges of the owner of a definer's rights procedure allow access to that procedure's referenced objects, before the procedure is run. If a necessary privilege on a referenced object was revoked from the owner of a definer's rights procedure, then no user, including the owner, can run the procedure.

An example of when you may want to use a definer's rights procedure is as follows: Suppose that you must create an API whose procedures have unrestricted access to its tables, but you want to prevent ordinary users from selecting table data directly, and from changing it with `INSERT`, `UPDATE`, and `DELETE` statements. To accomplish this, in a separate, low-privileged schema, create the tables and the procedures that comprise the API. By default, each procedure is a definer's rights unit, so you do not need to specify `AUTHID DEFINER` when you create it. Then grant the `EXECUTE` privilege to the users who must use this API, but do not grant any privileges that allow data access. This solution gives you complete control over your API behavior and how users have access to its underlying objects.

Oracle recommends that you create your definer's rights procedures, and views that access these procedures, in their own schema. Grant this schema very low privileges, or no privileges at all. This way, when other users run these procedures or views, they will not have access to any unnecessarily high privileges from this schema.

 **Note:**

Trigger processing follows the same patterns as definer's rights procedures. The user runs a SQL statement, which that user is privileged to run. As a result of the SQL statement, a trigger is fired. The statements within the triggered action temporarily run under the security domain of the user that owns the trigger.

Related Topics

- [How Roles Work in PL/SQL Blocks](#)
Role behavior in a PL/SQL block is determined by the type of block and by definer's rights or invoker's rights.
- [Oracle Database Concepts](#)

9.3 How Procedure Privileges Affect Invoker's Rights

An invoker's rights procedure runs with all of the invoker's privileges.

Oracle Database enables the privileges that were granted to the invoker through any of the invoker's enabled roles to take effect, unless a definer's rights procedure calls the invoker's rights procedure directly or indirectly. A user of an invoker's rights procedure must have privileges (granted to the user either directly or through a role) on objects that the procedure accesses through external references that are resolved in the schema of the invoker. When the invoker runs an invoker's rights procedure, this user temporarily has *all* of the privileges of the invoker.

The invoker must have privileges at run time to access program references embedded in DML statements or dynamic SQL statements, because they are effectively recompiled at run time.

For all other external references, such as direct PL/SQL function calls, Oracle Database checks the privileges of the owner at compile time, but does not perform a run-time check. Therefore, the user of an invoker's rights procedure does not need privileges on external references outside DML or dynamic SQL statements. Therefore, the developer of an invoker's rights procedure only needs to grant privileges on the procedure itself, not on all objects directly referenced by the invoker's rights procedure.

You can create a software bundle that consists of multiple program units, some with definer's rights and others with invoker's rights, and restrict the program entry points (*controlled step-in*). A user who has the privilege to run an entry-point procedure can also run internal program units indirectly, but cannot directly call the internal programs. For very precise control over query processing, you can create a PL/SQL package specification with explicit cursors.

Related Topics

- [Controlling Invoker's Rights Privileges for Procedure Calls and View Access](#)
The `INHERIT PRIVILEGES` and `INHERIT ANY PRIVILEGES` privileges regulate the privileges used when invoker's rights procedures are run.

9.4 When You Should Create Invoker's Rights Procedures

Oracle recommends that you create invoker's rights procedures in certain situations.

These situations are as follows:

- **When creating a PL/SQL procedure in a high-privileged schema.** When lower-privileged users invoke the procedure, then it can do no more than those users are allowed to do. In other words, the invoker's rights procedure runs with the privileges of the invoking user.
- **When the PL/SQL procedure contains no SQL and is available to other users.** The `DBMS_OUTPUT` PL/SQL package is an example of a PL/SQL subprogram that contains no SQL and is available to all users. The reason you should use an invoker's rights procedure in this situation is because the unit issues no SQL statements at run time, so the run-time system does not need to check their privileges. Specifying `AUTHID CURRENT_USER` makes invocations of the procedure more efficient, because when an invoker's right procedure is pushed onto, or comes from, the call stack, the values of `CURRENT_USER` and `CURRENT_SCHEMA`, and the currently enabled roles do not change.

Related Topics

- [Configuration of Oracle Virtual Private Database Policies](#)
The `DBMS_RLS` PL/SQL package can configure Oracle Virtual Private Database (VPD) policies.
- [About ANY Privileges and the PUBLIC Role](#)
System privileges that use the `ANY` keyword enable you to set privileges for an entire category of objects in the database.

See Also:

- *Oracle Database PL/SQL Packages and Types Reference* for information about how Oracle Database handles name resolution and privilege checking at runtime using invoker's and definer's rights
- *Oracle Database PL/SQL Packages and Types Reference* for more information about the differences between invoker's rights and definer's rights units
- *Oracle Database PL/SQL Packages and Types Reference* for information about defining explicit cursors in the `CREATE PACKAGE` statement

9.5 Controlling Invoker's Rights Privileges for Procedure Calls and View Access

The `INHERIT PRIVILEGES` and `INHERIT ANY PRIVILEGES` privileges regulate the privileges used when invoker's rights procedures are run.

- [How the Privileges of a Schema Affect the Use of Invoker's Rights Procedures](#)
An invoker's rights procedure is useful in situations where a lower-privileged user must run a procedure owned by a higher-privileged user.

- [How the INHERIT \[ANY\] PRIVILEGES Privileges Control Privilege Access](#)
Use the `INHERIT PRIVILEGES` and `INHERIT ANY PRIVILEGES` privileges to secure invoker's rights procedures.
- [Grants of the INHERIT PRIVILEGES Privilege to Other Users](#)
By default, all users are granted `INHERIT PRIVILEGES ON USER newuser TO PUBLIC`.
- [Example: Granting INHERIT PRIVILEGES on an Invoking User](#)
The `GRANT` statement can grant the `INHERIT PRIVILEGES` privilege on an invoking user to a procedure owner.
- [Example: Revoking INHERIT PRIVILEGES](#)
The `REVOKE` statement can revoke the `INHERIT PRIVILEGES` privilege from a user.
- [Grants of the INHERIT ANY PRIVILEGES Privilege to Other Users](#)
By default, user `SYS` has the `INHERIT ANY PRIVILEGES` system privilege and can grant this privilege to other database users or roles.
- [Example: Granting INHERIT ANY PRIVILEGES to a Trusted Procedure Owner](#)
The `GRANT` statement can grant the `INHERIT ANY PRIVILEGES` privilege to trusted procedure owners.
- [Managing INHERIT PRIVILEGES and INHERIT ANY PRIVILEGES](#)
By default, `PUBLIC` has the `INHERIT PRIVILEGE` privilege on new and upgraded user accounts; the `SYS` user has the `INHERIT ANY PRIVILEGES` privilege.

9.5.1 How the Privileges of a Schema Affect the Use of Invoker's Rights Procedures

An invoker's rights procedure is useful in situations where a lower-privileged user must run a procedure owned by a higher-privileged user.

When a user runs an invoker's rights procedure (or any PL/SQL program unit that has been created with the `AUTHID CURRENT_USER` clause), the procedure temporarily inherits all of the privileges of the invoking user while the procedure runs.

During that time, the procedure owner has, through the procedure, access to this invoking user's privileges. Consider the following scenario:

1. User `ebrown` creates the `check_syntax` invoker's rights procedure and then grants user `jward` the `EXECUTE` privilege on it.
2. User `ebrown`, who is a junior programmer, has only the minimum set of privileges necessary for their job. The `check_syntax` procedure resides in `ebrown`'s schema.
3. User `jward`, who is a manager, has a far more powerful set of privileges than user `ebrown`.
4. When user `jward` runs the `check_syntax` invoker's rights procedure, the procedure inherits user `jward`'s higher privileges while it runs.
5. Because user `ebrown` owns the `check_syntax` procedure, this user has access to user `jward`'s privileges whenever `jward` runs the `check_syntax` procedure.

The danger in this type of situation—in which the lower privileged `ebrown`'s procedure has access to `jward`'s higher privileges whenever `jward` runs the procedure—lies in the risk that the procedure owner can misuse the higher privileges of the invoking user. For example, user `ebrown` could make use of `jward`'s higher privileges by rewriting the `check_syntax` procedure to give `ebrown` a raise or delete `ebrown`'s bad performance appraisal record. Or, `ebrown` originally could have created the procedure as a definer's rights procedure, granted its `EXECUTE` privilege to `jward`, and then later on change it to a potentially malicious invoker's rights procedure

without letting `jward` know. These types of risks increase when random users, such as application users, have access to a database that uses invoker's rights procedures.

When user `jward` runs `ebrown`'s invoker's rights procedure, there is an element of trust involved. This user must be assured that `ebrown` will not use the `check_syntax` procedure in a malicious way when it accesses `jward`'s privileges. The `INHERIT PRIVILEGES` and `INHERIT ANY PRIVILEGES` privileges can help user `jward` control whether user `ebrown`'s procedure can have access to `jward`'s privileges. Any user can grant or revoke the `INHERIT PRIVILEGES` privilege on themselves to the user whose invoker's rights procedures they want to run. `SYS` users manage the `INHERIT ANY PRIVILEGES` privilege.

9.5.2 How the INHERIT [ANY] PRIVILEGES Privileges Control Privilege Access

Use the `INHERIT PRIVILEGES` and `INHERIT ANY PRIVILEGES` privileges to secure invoker's rights procedures.

The `INHERIT PRIVILEGES` and `INHERIT ANY PRIVILEGES` privileges regulate the privileges used when a user runs an invoker's rights procedure or queries a `BEQUEATH CURRENT_USER` view that references an invoker's rights procedure.

When a user runs an invoker's rights procedure, Oracle Database checks it to ensure that the procedure owner has either the `INHERIT PRIVILEGES` privilege on the invoking user, or if the owner has been granted the `INHERIT ANY PRIVILEGES` privilege. If the privilege check fails, then Oracle Database returns an `ORA-06598: insufficient INHERIT PRIVILEGES privilege error`.

The benefit of these two privileges is that they give invoking users control over who can access their privileges when they run an invoker's rights procedure or query a `BEQUEATH CURRENT_USER` view.

9.5.3 Grants of the INHERIT PRIVILEGES Privilege to Other Users

By default, all users are granted `INHERIT PRIVILEGES ON USER newuser TO PUBLIC`.

This grant takes place when the user accounts are created or when accounts that were created earlier are upgraded to the current release.

The invoking user can revoke the `INHERIT PRIVILEGE` privilege from other users on the invoking user and then grant it only to users that the invoking user trusts.

The syntax for the `INHERIT PRIVILEGES` privilege grant is as follows:

```
GRANT INHERIT PRIVILEGES ON USER invoking_user TO procedure_owner;
```

In this specification:

- *invoking_user* is the user who runs the invoker's rights procedure. This user must be a database user account.
- *procedure_owner* is the user who owns the invoker's rights procedure. This value must be a database user account. As an alternative to granting the `INHERIT PRIVILEGES` privilege to the procedure's owner, you can grant the privilege to a role that is in turn granted to the procedure.

The following users or roles must have the `INHERIT PRIVILEGES` privilege granted to them by users who will run their invoker's rights procedures:

- Users or roles who own the invoker's rights procedures
- Users or roles who own `BEQUEATH CURRENT_USER` views

9.5.4 Example: Granting `INHERIT PRIVILEGES` on an Invoking User

The `GRANT` statement can grant the `INHERIT PRIVILEGES` privilege on an invoking user to a procedure owner.

[Example 9-1](#) shows how the invoking user `jward` can grant user `ebrown` the `INHERIT PRIVILEGES` privilege.

Example 9-1 Granting `INHERIT PRIVILEGES` on an Invoking User to a Procedure Owner

```
GRANT INHERIT PRIVILEGES ON USER jward TO ebrown;
```

The statement enables any invoker's rights procedure that `ebrown` writes, or will write in the future, to access `jward`'s privileges when `jward` runs it.

9.5.5 Example: Revoking `INHERIT PRIVILEGES`

The `REVOKE` statement can revoke the `INHERIT PRIVILEGES` privilege from a user.

[Example 9-2](#) shows how user `jward` can revoke the use of their privileges from `ebrown`.

Example 9-2 Revoking `INHERIT PRIVILEGES`

```
REVOKE INHERIT PRIVILEGES ON USER jward FROM ebrown;
```

9.5.6 Grants of the `INHERIT ANY PRIVILEGES` Privilege to Other Users

By default, user `SYS` has the `INHERIT ANY PRIVILEGES` system privilege and can grant this privilege to other database users or roles.

As with all `ANY` privileges, only grant this privilege to trusted users or roles. Once a user or role has been granted the `INHERIT ANY PRIVILEGES` privilege, then this user's invoker's rights procedures have access to the privileges of the invoking user. You can find the users who have been granted the `INHERIT ANY PRIVILEGES` privilege by querying the `DBA_SYS_PRIVS` data dictionary view.

9.5.7 Example: Granting `INHERIT ANY PRIVILEGES` to a Trusted Procedure Owner

The `GRANT` statement can grant the `INHERIT ANY PRIVILEGES` privilege to trusted procedure owners.

[Example 9-3](#) shows how to grant the `INHERIT ANY PRIVILEGES` privilege to user `ebrown`.

Example 9-3 Granting `INHERIT ANY PRIVILEGES` to a Trusted Procedure Owner

```
GRANT INHERIT ANY PRIVILEGES TO ebrown;
```

Be careful about revoking the `INHERIT ANY PRIVILEGES` privilege from powerful users. For example, suppose user `SYSTEM` has created a set of invoker's rights procedures. If you revoke `INHERIT ANY PRIVILEGES` from `SYSTEM`, then other users cannot run this user's procedures, unless they have specifically granted user `SYSTEM` the `INHERIT PRIVILEGE` privilege.

9.5.8 Managing INHERIT PRIVILEGES and INHERIT ANY PRIVILEGES

By default, `PUBLIC` has the `INHERIT PRIVILEGE` privilege on new and upgraded user accounts; the `SYS` user has the `INHERIT ANY PRIVILEGES` privilege.

Oracle by default configures a set of grants of `INHERIT PRIVILEGES` that are designed to help protect against misuse of the privileges of various Oracle-defined users.

You can choose to revoke the default grant of `INHERIT PRIVILEGES ON USER user_name` TO `PUBLIC` for a customer-defined user and grant more specific grants of `INHERIT PRIVILEGES` as appropriate for that particular user. To find the users who have been granted the `INHERIT ANY PRIVILEGES` privilege, query the `DBA_SYS_PRIVS` data dictionary view.

1. Revoke the `INHERIT PRIVILEGES` privilege from `PUBLIC`.

For example:

```
REVOKE INHERIT PRIVILEGES ON invoking_user FROM PUBLIC;
```

Be aware that this time, any users who run invoker's rights procedures cannot do so, due to run-time errors from failed `INHERIT PRIVILEGES` checks.

2. Selectively grant the `INHERIT PRIVILEGES` privilege to trusted users or roles.
3. Similarly, selectively grant the `INHERIT ANY PRIVILEGES` privilege only to trusted users or roles.

You can create an audit policy to audit the granting and revoking of these two privileges, but you cannot audit run-time errors that result from failed `INHERIT PRIVILEGES` privilege checks.

See Also:

- [Oracle Database PL/SQL Packages and Types Reference](#) for information about SQL injection attacks
- [Oracle Database PL/SQL Packages and Types Reference](#) for more information about the `GRANT` statement and default privileges

9.6 Definer's Rights and Invoker's Rights in Views

The `BEQUEATH` clause in the `CREATE VIEW` SQL statement can control definer's rights and invoker's rights in user-created views.

- [About Controlling Definer's Rights and Invoker's Rights in Views](#)
You can configure user-defined views to accommodate invoker's rights functions that are referenced in the view.
- [Using the BEQUEATH Clause in the CREATE VIEW Statement](#)
The `BEQUEATH` controls how an invoker's right function can be run using the rights of the invoking user.
- [Finding the User Name or User ID of the Invoking User](#)
PL/SQL functions can be used to find the invoking user, based on whether invoker's rights or definer's rights are being used.

- [Finding BEQUEATH DEFINER and BEQUEATH_CURRENT_USER Views](#)
You can find out if a view is a `BEQUEATH DEFINER` or `BEQUEATH CURRENT_USER` view.

9.6.1 About Controlling Definer's Rights and Invoker's Rights in Views

You can configure user-defined views to accommodate invoker's rights functions that are referenced in the view.

When a user invokes an identity- or privilege-sensitive SQL function or an invoker's rights PL/SQL or Java function, then current schema, current user, and currently enabled roles within the operation's execution can be inherited from the querying user's environment, rather than being set to the owner of the view.

This configuration does not turn the view itself into an invoker's rights object. Name resolution within the view is still handled using the view owner's schema, and privilege checking for the view is done using the view owner's privileges. However, at runtime, the function referenced by view runs under the invoking user's privileges rather than those of the view owner's.

The benefit of this feature is that it enables functions such as `SYS_CONTEXT` and `USERENV`, which must return information accurate for the invoking user, to return consistent results when these functions are referenced in a view.

9.6.2 Using the BEQUEATH Clause in the CREATE VIEW Statement

The `BEQUEATH` controls how an invoker's right function can be run using the rights of the invoking user.

To enable an invoker's rights function to be run using the rights of the user issuing SQL that references the view, in the `CREATE VIEW` statement, you can set the `BEQUEATH` clause to `CURRENT_USER`.

If you plan to issue a SQL query or DML statement against the view, then the view owner must be granted the `INHERIT PRIVILEGES` privilege on the invoking user or the view owner must have the `INHERIT ANY PRIVILEGES` privilege. If not, then when a `SELECT` query or DML statement involves a `BEQUEATH CURRENT_USER` view, the run-time system will raise error `ORA-06598: insufficient INHERIT PRIVILEGES privilege`.

- Use the `BEQUEATH CURRENT_USER` clause to set the view's function to be run using invoker's rights.

For example:

```
CREATE VIEW MY_OBJECTS_VIEW BEQUEATH CURRENT_USER AS
  SELECT GET_OBJS_FUNCTION;
```

If you want the function within the view to be run using the view owner's rights, then you should either omit the `BEQUEATH` clause or set it to `DEFINER`.

For example:

```
CREATE VIEW my_objects_view BEQUEATH DEFINER AS
  SELECT OBJECT_NAME FROM USER_OBJECTS;
```

Related Topics

- [Controlling Invoker's Rights Privileges for Procedure Calls and View Access](#)
The `INHERIT PRIVILEGES` and `INHERIT ANY PRIVILEGES` privileges regulate the privileges used when invoker's rights procedures are run.

 **See Also:**

- *Oracle Database SQL Language Reference* for additional information about granting the `INHERIT PRIVILEGES` and `INHERIT ANY PRIVILEGES` privileges
- *Oracle Database Real Application Security Administrator's and Developer's Guide* for information about how to use `BEQUEATH CURRENT_USER` views with Oracle Database Real Application Security applications

9.6.3 Finding the User Name or User ID of the Invoking User

PL/SQL functions can be used to find the invoking user, based on whether invoker's rights or definer's rights are being used.

- Use the `ORA_INVOKING_USER` or `ORA_INVOKING_USERID` function to find the invoking user based on whether invoker's rights or definer's rights:
 - `ORA_INVOKING_USER`: Use this function to return the name of the user who is invoking the current statement or view. This function treats the intervening views as specified by their `BEQUEATH` clauses. If the invoking user is an Oracle Database Real Application Security-defined user, then this function returns `XS$NULL`.
 - `ORA_INVOKING_USERID`: Use this function to return the identifier (ID) of the user who is invoking the current statement or view. This function treats the intervening views as specified by their `BEQUEATH` clauses. If the invoking user is an Oracle Database Real Application Security-defined user, then this function returns an ID that is common to all Real Application Security sessions but is different from the ID of any database user.

For example:

```
CONNECT HR@pdb_name
Enter password: password

SELECT ORA_INVOKING_USER FROM DUAL;

ORA_INVOKING_USER
-----
HR
```

 **See Also:**

Oracle Database Real Application Security Administrator's and Developer's Guide for information about similar functions that are used for Oracle Database Real Application Security applications

9.6.4 Finding BEQUEATH DEFINER and BEQUEATH_CURRENT_USER Views

You can find out if a view is a `BEQUEATH DEFINER` or `BEQUEATH CURRENT_USER` view.

- To find if a view is `BEQUEATH DEFINER` or `BEQUEATH CURRENT_USER` view, query the `BEQUEATH` column of a `*_VIEWS` or `*_VIEWS_AE` static data dictionary view for that view.

For example:

```
SELECT BEQUEATH FROM USER_VIEWS WHERE VIEW_NAME = 'MY_OBJECTS';  
  
BEQUEATH  
-----  
CURRENT_USER
```

9.7 Using Code Based Access Control for Definer's Rights and Invoker's Rights

Code based access control, used to attach database roles to PL/SQL functions, procedures, or packages, works well with invoker's rights and definer's procedures.

- [About Using Code Based Access Control for Applications](#)
You can use code based access control (CBAC) to better manage definer's rights program units.
- [Who Can Grant Code Based Access Control Roles to a Program Unit?](#)
Code based access control roles can be granted to a program unit if a set of conditions are met.
- [How Code Based Access Control Works with Invoker's Rights Program Units](#)
Code based access control can run a program unit in an invoking user's context and with roles associated with this context.
- [How Code Based Access Control Works with Definer's Rights Program Units](#)
Code based access control can be used to secure definer's rights.
- [Grants of Database Roles to Users for Their CBAC Grants](#)
The `DELEGATE` option in the `GRANT` statement can limit privilege grants to roles by users responsible for CBAC grants.
- [Grants and Revokes of Database Roles to a Program Unit](#)
The `GRANT` and `REVOKE` statements can grant database roles to or revoke database roles from a program unit.
- [Tutorial: Controlling Access to Sensitive Data Using Code Based Access Control](#)
This tutorial demonstrates how to control access to sensitive data in the `HR` schema by using code based access control.

9.7.1 About Using Code Based Access Control for Applications

You can use code based access control (CBAC) to better manage definer's rights program units.

Applications must often run program units in the caller's environment, while requiring elevated privileges. PL/SQL programs traditionally make use of definer's rights to temporarily elevate the privileges of the program.

However, definer's rights based program units run in the context of the definer or the owner of the program unit, as opposed to the invoker's context. Also, using definer's rights based programs often leads to the program unit getting more privileges than required.

Code based access control (CBAC) provides the solution by enabling you to attach database roles to a PL/SQL function, procedure, or package. These database roles are enabled at run time, enabling the program unit to run with the required privileges in the calling user's environment.

You can create privilege analysis policies that capture the use of CBAC roles.

Related Topics

- [Performing Privilege Analysis to Identify Privilege Use](#)
Privilege analysis dynamically analyzes the privileges and roles that users use and do not use.

9.7.2 Who Can Grant Code Based Access Control Roles to a Program Unit?

Code based access control roles can be granted to a program unit if a set of conditions are met.

These conditions are as follows:

- The grantor is user `SYS` or owns the program unit.
- If the grantor owns the program unit, then the grantor must have the `GRANT ANY ROLE` system privilege, or have the `ADMIN` or `DELEGATE` option for the roles that they want to grant to program units.
- The roles to be granted are directly granted roles to the owner.
- The roles to be granted are standard database roles.

If these three conditions are not met, then error `ORA-28702: Program unit string is not owned by the grantor` is raised if the first condition is not met, and error `ORA-1924: role 'string' not granted or does not exist` is raised if the second and third conditions are not met.

Related Topics

- [Grants of Database Roles to Users for Their CBAC Grants](#)
The `DELEGATE` option in the `GRANT` statement can limit privilege grants to roles by users responsible for CBAC grants.
- [Grants and Revokes of Database Roles to a Program Unit](#)
The `GRANT` and `REVOKE` statements can grant database roles to or revoke database roles from a program unit.

9.7.3 How Code Based Access Control Works with Invoker's Rights Program Units

Code based access control can run a program unit in an invoking user's context and with roles associated with this context.

Consider a scenario where there are two application users, 1 and 2. Application user 2 creates the invoker's right program unit, grants database role 2 to the invoker's rights unit, and then grants `EXECUTE` privileges on the invoker's rights unit to application user 1.

[Figure 9-1](#) shows the database roles 1 and 2 granted to application users 1 and 2, and an invoker's right program unit.

Figure 9-1 Roles Granted to Application Users and Invoker's Right Program Unit

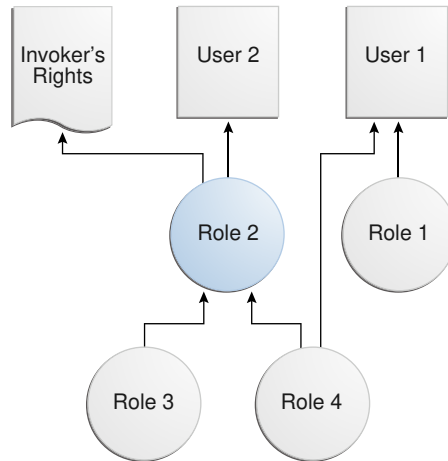

The grants are as follows:

- Application user 1 is directly granted database roles 1 and 4.
- Application user 2 is directly granted database role 2, which includes application roles 3 and 4.
- The invoker's right program unit is granted database role 2.

When application user 1 logs in and runs the invoker's rights program unit, then the invoker's rights unit runs with the combined database roles of user 1 and the database roles attached to the invoker's rights unit.

Figure 9-2 shows the security context in which the invoker's rights unit is run. When application user 1 first logs on, application user 1 has the database `PUBLIC` role (by default), and the database roles 1 and 4, which have been granted to it. Application user 1 next runs the invoker's rights program unit created by application user 2.

The invoker's rights unit runs in application user 1's context, and has the additional database role 2 attached to it. Database roles 3 and 4 are included, as they are a part of database role 2. After the invoker's rights unit exits, then application user 1 only has the application roles that have been granted to it, `PUBLIC`, role 1, and role 4.

Figure 9-2 Security Context in Which Invoker's Right Program Unit IR Is Run

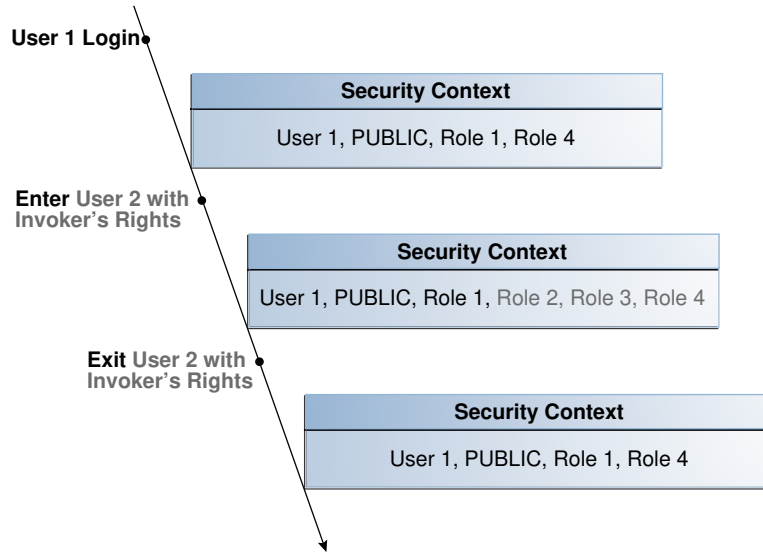

9.7.4 How Code Based Access Control Works with Definer's Rights Program Units

Code based access control can be used to secure definer's rights.

Code based access control works with definer's rights program units to enable the program unit to run using the defining user's rights, with the privileges of a combined set of database roles that are associated with this user.

Consider a scenario where application user 2 creates a definer's rights program unit, grants role 2 to the definer's rights program unit, and then grants the `EXECUTE` privilege on the definer's rights program unit to application user 1.

Figure 9-3 shows the database roles granted to application users 1 and 2, and a definer's rights program unit.

Figure 9-3 Roles Granted to Application Users and Definer's Rights Program Unit

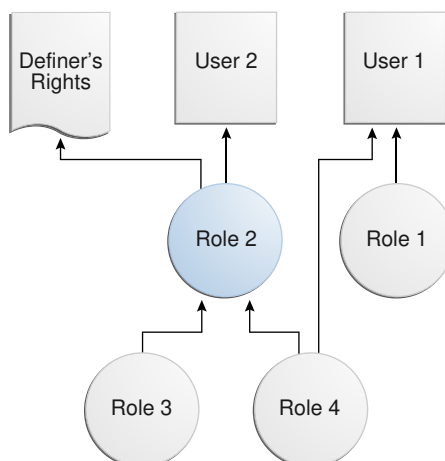

The grants are as follows:

- Application user 1 is directly granted database roles 1 and 4.
- Application user 2 is directly granted database role 2, which includes database roles 3 and 4.
- The definer's right program unit is granted database role 2.

When application user 1 logs in and runs definer's right program unit, then the definer's rights unit runs with the combined database roles of application user 2 and the database roles attached to the definer's rights unit (roles 2, 3, and 4).

Figure 9-4 shows the security context in which the definer's right program unit is run. When application user 1 first logs on, application user 1 has the database PUBLIC role (by default), and the database roles 1 and 4, which have been granted to it. Application user 1 next runs the definer's rights program unit created by application user 2.

The definer's rights program unit runs in application user 2's context, and has the additional database role 2 attached to it. Database roles 3 and 4 are included, as they are a part of database role 2. After the definer's rights unit exits, application user 1 only has the database roles that have been granted to it (PUBLIC, role 1, and role 4).

Figure 9-4 Security Context in Which Definer's Right Program Unit DR Is Run

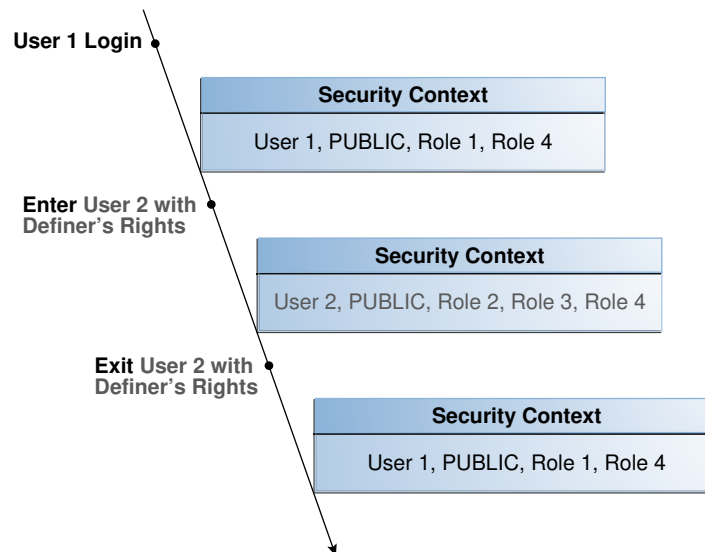

9.7.5 Grants of Database Roles to Users for Their CBAC Grants

The `DELEGATE` option in the `GRANT` statement can limit privilege grants to roles by users responsible for CBAC grants.

When you grant a database role to a user who is responsible for CBAC grants, you can include the `DELEGATE` option in the `GRANT` statement to prevent giving the grantee additional privileges on the roles.

The `DELEGATE` option enables the roles to be granted to program units, but it does not permit the granting of the role to other principals or the administration of the role itself. You also can use the `ADMIN` option for the grants, which does permit the granting of the role to other principals. Both the `ADMIN` and `DELEGATE` options are compatible; that is, you can grant both to

a user, though you must do this in separate `GRANT` statements for each option. To find if a user has been granted a role with these options, query the `DELEGATE_OPTION` column or the `ADMIN_OPTION` column of either the `USER_ROLE_PRIVS` or `DBA_ROLE_PRIVS` for the user.

The syntax for using the `DELEGATE` and `ADMIN` option is as follows:

```
GRANT role_list to user_list WITH DELEGATE OPTION;

GRANT role_list to user_list WITH ADMIN OPTION;
```

For example:

```
GRANT cb_role1 to usr1 WITH DELEGATE OPTION;

GRANT cb_role1 to usr1 WITH ADMIN OPTION;

GRANT cb_role1, cb_role2 to usr1, usr2 with DELEGATE OPTION;

GRANT cb_role1, cb_role2 to usr1, usr2 with ADMIN OPTION;
```

You can use the `DELEGATE` option for common grants such as granting common roles to common users, just as you can with the `ADMIN` option.

For example:

```
GRANT c##cb_role1 to c##usr1 WITH DELEGATE OPTION CONTAINER = ALL;
```

Be aware that CBAC grants themselves can only take place locally in a PDB.



See Also:

Oracle Database SQL Language Reference for more information about the `ADMIN` option

9.7.6 Grants and Revokes of Database Roles to a Program Unit

The `GRANT` and `REVOKE` statements can grant database roles to or revoke database roles from a program unit.

The following syntax to grants or revokes database roles for a PL/SQL function, procedure, or package:

```
GRANT role_list TO code_list
REVOKE {role_list | ALL} FROM code_list
```

In this specification:

```
role_list ::= code-based_role_name[, role_list]
code_list ::= {
    {FUNCTION [schema.]function_name}
  | {PROCEDURE [schema.]procedure_name}
  | {PACKAGE [schema.]package_name}
  }[, code_list]
```

For example:

```
GRANT cb_role1 TO FUNCTION func1, PACKAGE pack1;

GRANT cb_role2, cb_role3 TO FUNCTION HR.func2, PACKAGE SYS.pack2;

REVOKE cb_role1 FROM FUNCTION func1, PACKAGE pack1;

REVOKE ALL FROM FUNCTION HR.func2, PACKAGE SYS.pack2;
```

Related Topics

- [Who Can Grant Code Based Access Control Roles to a Program Unit?](#)
Code based access control roles can be granted to a program unit if a set of conditions are met.
- [Grants of Database Roles to Users for Their CBAC Grants](#)
The `DELEGATE` option in the `GRANT` statement can limit privilege grants to roles by users responsible for CBAC grants.

9.7.7 Tutorial: Controlling Access to Sensitive Data Using Code Based Access Control

This tutorial demonstrates how to control access to sensitive data in the `HR` schema by using code based access control.

- [About This Tutorial](#)
In this tutorial, you will create a user who must have access to specific employee information for the user's department.
- [Step 1: Create the User and Grant HR the CREATE ROLE Privilege](#)
To begin, you must create the "Finance" user account and then grant this the `HR` user the `CREATE ROLE` privilege.
- [Step 2: Create the print_employees Invoker's Rights Procedure](#)
The `print_employees` invoker's rights procedure shows employee information in the current user's department.
- [Step 3: Create the hr_clerk Role and Grant Privileges for It](#)
Next, you are ready to create the `hr_clerk` role, which must have the `EXECUTE` privilege on the `print_employees` procedure.
- [Step 4: Test the Code Based Access Control HR.print_employees Procedure](#)
At this stage, you are ready to test the code based access control `HR.print_employees` procedure.
- [Step 5: Create the view_emp_role Role and Grant Privileges for It](#)
Next, user `HR` must create the `view_emp_role` role and then grant privileges to it.
- [Step 6: Test the HR.print_employees Procedure Again](#)
With the appropriate privileges in place, user "Finance" can try the `HR.print_employees` procedure again.
- [Step 7: Remove the Components of This Tutorial](#)
If you no longer need the components of this tutorial, then you can remove them.

9.7.7.1 About This Tutorial

In this tutorial, you will create a user who must have access to specific employee information for the user's department.

However, the table `HR.EMPLOYEES` contains sensitive information such as employee salaries, which must not be accessible to the user. You will implement access control using code based access control. The employee data will be shown to the user through an invoker's rights procedure. Instead of granting the `SELECT` privilege directly to the user, you will grant the `SELECT` privilege to the invoker's rights procedure through a database role. In the procedure, you will hide the sensitive information, such as salaries. Because the procedure is an invoker's rights procedure, you know the caller's context inside the procedure. In this case, the caller's context is for the Finance department. The user is named "Finance", so that only data for employees who work in the Finance department is accessible to the user.

9.7.7.2 Step 1: Create the User and Grant HR the CREATE ROLE Privilege

To begin, you must create the "Finance" user account and then grant this the HR user the `CREATE ROLE` privilege.

1. Log into a PDB as an administrator who has privileges to create user accounts and roles.

For example:

```
sqlplus sec_admin@pdb_name
Enter password: password
```

To find the available PDBs, query the `DBA_PDBS` data dictionary view. To check the current PDB, run the `show con_name` command.

2. Create the "Finance" user account.

```
GRANT CONNECT TO "Finance" IDENTIFIED BY password;
```

Ensure that you enter "Finance" in the case shown, enclosed by double quotation marks. Replace `password` with a password that is secure.

3. Grant the `CREATE ROLE` privilege to user HR.

```
GRANT CREATE ROLE TO HR;
```

Related Topics

- [Guidelines for Securing Passwords](#)
Oracle provides guidelines for securing passwords in a variety of situations.

9.7.7.3 Step 2: Create the print_employees Invoker's Rights Procedure

The `print_employees` invoker's rights procedure shows employee information in the current user's department.

You must create this procedure as an invoker's rights procedure because you must know who the caller is when inside the procedure.

1. Connect to the PDB as user HR.

```
CONNECT HR@pdb_name
Enter password: password
```

2. Create the `print_employees` procedure as follows.

```
create or replace procedure print_employees
authid current_user
as
begin
  dbms_output.put_line(rpad('ID', 10) ||
```

```

        rpad('First Name', 15) ||
        rpad('Last Name', 15)  ||
        rpad('Email', 15)     ||
        rpad('Phone Number', 20));
for rec in (select e.employee_id, e.first_name, e.last_name,
                 e.email, e.phone_number
            from hr.employees e, hr.departments d
            where e.department_id = d.department_id
                  and d.department_name =
                        sys_context('userenv', 'current_user'))
loop
    dbms_output.put_line(rpad(rec.employee_ID, 10) ||
                        rpad(rec.first_name, 15)  ||
                        rpad(rec.last_name, 15)   ||
                        rpad(rec.email, 15)      ||
                        rpad(rec.phone_number, 20));
end loop;
end;
/

```

In this example:

- `dbms_output.put_line` prints the table header.
- `for rec in (select ...` finds the employee information for the caller's department, which for this tutorial is the Finance department for user "Finance". Had you created a user named "Marketing" (which is also listed in the `DEPARTMENT_NAME` column of the `HR.EMPLOYEES` table), then the procedure could capture information for Marketing employees.
- `loop` and `dbms_output.put_line` populate the output with the employee data from the Finance department.

9.7.7.4 Step 3: Create the `hr_clerk` Role and Grant Privileges for It

Next, you are ready to create the `hr_clerk` role, which must have the `EXECUTE` privilege on the `print_employees` procedure.

After you create this role, you must grant it to "Finance".

1. Create the `hr_clerk` role.

```
CREATE ROLE hr_clerk;
```

2. Grant the `EXECUTE` privilege on the `print_employees` procedure to the `hr_clerk` role.

```
GRANT EXECUTE ON print_employees TO hr_clerk;
```

3. Grant the `hr_clerk` role to "Finance".

```
GRANT hr_clerk TO "Finance";
```

9.7.7.5 Step 4: Test the Code Based Access Control `HR.print_employees` Procedure

At this stage, you are ready to test the code based access control `HR.print_employees` procedure.

To test the code based access control `HR.print_employees` procedure, user "Finance" must query the `HR.EMPLOYEES` table and try to run the `HR.print_employees` procedure.

1. Connect to the PDB as user "Finance".

```
CONNECT "Finance"@pdb_name
Enter password: password
```

2. Try to directly query the HR.EMPLOYEES table.

```
SELECT EMPLOYEE_ID, FIRST_NAME, LAST_NAME, SALARY FROM HR.EMPLOYEES;
```

The query fails because user Finance does not have the SELECT privilege for HR.EMPLOYEES.

```
ERROR at line 1:
ORA-00942: table or view does not exist
```

3. Run the HR.print_employees procedure.

```
EXEC HR.print_employees;
```

The query fails because user "Finance" does not have the appropriate privileges.

```
ERROR at line 1:
ORA-00942: table or view does not exist
ORA-06512: at "HR.PRINT_EMPLOYEES", line 13ORA-06512: at line 1
```

9.7.7.6 Step 5: Create the view_emp_role Role and Grant Privileges for It

Next, user HR must create the view_emp_role role and then grant privileges to it.

User HR grants the SELECT privilege HR.EMPLOYEES and HR.DEPARTMENTS to the view_emp_role role, and then grants SELECT on HR.EMPLOYEES and HR.DEPARTMENTS to the view_emp_role role.

1. Connect to the PDB as user HR.

```
CONNECT HR@pdb_name
Enter password: password
```

2. Create the view_emp_role role.

```
CREATE ROLE view_emp_role;
```

3. Grant the SELECT privilege on HR.EMPLOYEES and HR.DEPARTMENTS to the view_emp_role role.

```
GRANT SELECT ON HR.EMPLOYEES TO view_emp_role;
GRANT SELECT ON HR.DEPARTMENTS TO view_emp_role;
```

4. Grant the view_emp_role role to the HR.print_employees invoker's rights procedure.

```
GRANT view_emp_role TO PROCEDURE HR.print_employees;
```

9.7.7.7 Step 6: Test the HR.print_employees Procedure Again

With the appropriate privileges in place, user "Finance" can try the HR.print_employees procedure again.

1. Connect to the PDB as user "Finance".

```
CONNECT "Finance"@pdb_name
Enter password: password
```

2. Set the server output to display.

```
SET SERVEROUTPUT ON;
```

3. Try to directly query the HR.EMPLOYEES table.

```
SELECT EMPLOYEE_ID, FIRST_NAME, LAST_NAME, SALARY FROM HR.EMPLOYEES;
```

The query fails.

```
ERROR at line 1:  
ORA-00942: table or view does not exist
```

4. Run the `HR.print_employees` procedure to show the employee information.

```
EXEC HR.print_employees;
```

The call succeeds.

ID	First Name	Last Name	Email	Phone Number
108	Nancy	Greenberg	NGREENBE	515.124.4569
109	Daniel	Faviet	DFAVIET	515.124.4169
110	John	Chen	JCHEN	515.124.4269
111	Ismael	Sciarra	ISCIARRA	515.124.4369
112	Jose Manuel	Urman	JMURMAN	515.124.4469
113	Luis	Popp	LPOPP	515.124.4567

```
PL/SQL procedure successfully completed.
```

9.7.7.8 Step 7: Remove the Components of This Tutorial

If you no longer need the components of this tutorial, then you can remove them.

1. Connect to the PDB as a user with administrative privileges.

For example:

```
CONNECT sec_admin@pdb_name  
Enter password: password
```

2. Drop the user "Finance".

```
DROP USER "Finance";
```

3. Drop the `hr_clerk` role.

```
DROP ROLE hr_clerk;
```

4. Connect as user HR.

```
CONNECT HR@pdb_name  
Enter password: password
```

5. Drop the `view_emp_role` role and the `HR.print_employees` procedure.

```
DROP ROLE view_emp_role;  
DROP PROCEDURE print_employees;
```

6. Connect as the administrative user.

```
CONNECT sec_admin@pdb_name  
Enter password: password
```

7. Revoke the `CREATE ROLE` privilege from HR.

```
REVOKE CREATE ROLE FROM HR;
```

9.8 Controlling Definer's Rights Privileges for Database Links

You can control privilege grants for definer's rights procedures if your applications use database links and definer's rights procedures.

- [About Controlling Definer's Rights Privileges for Database Links](#)
When a definer's rights procedure connects to a database link, operations on the database link should use the procedure owner's credentials.
- [Grants of the INHERIT REMOTE PRIVILEGES Privilege to Other Users](#)
The `INHERIT REMOTE PRIVILEGES` privilege enables the current user to have explicit privileges over the connected user in the database.
- [Example: Granting INHERIT REMOTE PRIVILEGES on a Connected User](#)
You can grant the `INHERIT REMOTE PRIVILEGES` privilege on a connected user to the current user.
- [Grants of the INHERIT ANY REMOTE PRIVILEGES Privilege to Other Users](#)
The `INHERIT ANY REMOTE PRIVILEGES` privilege enables the grantee user to open a `connected_user` database link as any user.
- [Revokes of the INHERIT \[ANY\] REMOTE PRIVILEGES Privilege](#)
The methods for revoking the `INHERIT REMOTE PRIVILEGES` and `INHERIT ANY REMOTE PRIVILEGES` privileges differ.
- [Example: Revoking the INHERIT REMOTE PRIVILEGES Privilege](#)
The `REVOKE SQL` statement can revoke the `INHERIT REMOTE PRIVILEGES` privilege.
- [Example: Revoking the INHERIT REMOTE PRIVILEGES Privilege from PUBLIC](#)
The `REVOKE SQL` statement can revoke the `INHERIT REMOTE PRIVILEGES` from `PUBLIC`, as well as from individual procedure owners.
- [Tutorial: Using a Database Link in a Definer's Rights Procedure](#)
This tutorial demonstrates how the `INHERIT REMOTE PRIVILEGES` privilege works in a definer's rights procedure that uses a database link.

9.8.1 About Controlling Definer's Rights Privileges for Database Links

When a definer's rights procedure connects to a database link, operations on the database link should use the procedure owner's credentials.

The `INHERIT REMOTE PRIVILEGES` and `INHERIT ANY REMOTE PRIVILEGES` privileges apply when a connected user database link is used with a definer's rights procedure. These privileges allow the use of the credentials of the logged-in user for connected user database link operations with definer rights procedures.

You can perform a grant of the `INHERIT REMOTE PRIVILEGES` and `INHERIT ANY REMOTE PRIVILEGES` privileges so the users who invoke the definer's rights procedure can use a connected user database link within a definer's rights block. A definer's rights procedure runs with the privileges of the procedure owner. However, a connected user database link operation must have the credentials of the logged in user. Hence, the `INHERIT REMOTE PRIVILEGES` and `INHERIT ANY REMOTE PRIVILEGES` privileges are required to be granted to enable the database link operations within the definer's rights block.

Be aware that during an upgrade, the `INHERIT REMOTE PRIVILEGES` and `INHERIT ANY REMOTE PRIVILEGES` privileges are not granted by default to any existing users.

The `INHERIT REMOTE PRIVILEGES` and `INHERIT ANY REMOTE PRIVILEGES` privileges apply only to situations in which users are trying to connect to user database links in a definer's rights procedure. In addition, these privileges apply to both privately created and publicly created database links. By default, database links are created as private links. In addition, by default, `INHERIT REMOTE PRIVILEGES` is not granted to `PUBLIC`.

The ways that you can perform grants of these privileges are as follows:

- `GRANT INHERIT REMOTE PRIVILEGES ON USER dbuser_1 TO dbuser_2`: In this scenario, *dbuser_1* can explicitly grant the `INHERIT REMOTE PRIVILEGE` privilege to *dbuser_2* and use a definer's rights procedure that user *dbuser_2* owns.
- `GRANT INHERIT REMOTE PRIVILEGES ON USER dbuser_1 TO PUBLIC`. In this scenario, *dbuser_1* grants the `INHERIT REMOTE PRIVILEGE` privilege to public. This grant enables *dbuser_1* to use the definer's rights procedures that any other user owns.
- `GRANT INHERIT ANY REMOTE PRIVILEGES TO dbuser_2`: In this scenario, any user can use the definer's rights procedures that *dbuser_2* owns.

If the user does not have the `INHERIT REMOTE PRIVILEGE` privilege and tries to run the definer's rights privilege, then the `ORA-25433: User does not have INHERIT REMOTE PRIVILEGES` error appears.

9.8.2 Grants of the `INHERIT REMOTE PRIVILEGES` Privilege to Other Users

The `INHERIT REMOTE PRIVILEGES` privilege enables the current user to have explicit privileges over the connected user in the database.

The syntax for granting the `INHERIT REMOTE PRIVILEGES` privilege is as follows:

```
GRANT INHERIT REMOTE PRIVILEGES ON USER connected_user TO current_user;
```

In this specification:

- *connected_user* is the user who runs the definer's rights procedure.
- *current_user* is the user who owns the definer's right procedure. This value must be a database user account. As an alternative to granting the `INHERIT REMOTE PRIVILEGES` privilege to the procedure's owner, you can grant the privilege to a role that is in turn granted to the procedure.

Users or roles who own the definer's rights procedures must have the `INHERIT REMOTE PRIVILEGES` privilege granted to them by users who will run their definer's rights procedures.

Any user can grant or revoke the `INHERIT REMOTE PRIVILEGES` privilege on themselves to the user whose definer's rights procedures they want to run.

9.8.3 Example: Granting `INHERIT REMOTE PRIVILEGES` on a Connected User

You can grant the `INHERIT REMOTE PRIVILEGES` privilege on a connected user to the current user.

In this example, the connected user, *jward*, must have remote privileges on the current user, *ebrown*. This enables *jward* to run the definer's right procedure that *ebrown* created.

[Example 9-4](#) shows how an administrator (or user *jward*) can grant the `INHERIT REMOTE PRIVILEGES` on user *jward* to user *ebrown*. This privilege grant enables any definer's rights procedure that *ebrown* writes, or will write in the future, to access *ebrown*'s privileges when the procedure is run.

Example 9-4 Granting `INHERIT REMOTE PRIVILEGES` on a Connected User to the Current User

```
GRANT INHERIT REMOTE PRIVILEGES ON USER jward TO ebrown;
```

9.8.4 Grants of the INHERIT ANY REMOTE PRIVILEGES Privilege to Other Users

The `INHERIT ANY REMOTE PRIVILEGES` privilege enables the grantee user to open a `connected_user` database link as any user.

As with all ANY privileges, `INHERIT ANY REMOTE PRIVILEGES` is a powerful privilege that must only be granted to trusted users. By default, user `SYS` has the `INHERIT ANY REMOTE PRIVILEGES` system privilege WITH `GRANT OPTION`. To find users who have been granted the `INHERIT ANY REMOTE PRIVILEGES` privilege, query the `DBA_SYS_PRIVS` data dictionary view.

For better security, Oracle recommends that you protect the `INHERIT ANY REMOTE PRIVILEGES` privilege with a PDB lockdown profile. A PDB lockdown profile prevents local pluggable database (PDB) users from opening a connected user database link as a common user, irrespective of the kind of `INHERIT REMOTE PRIVILEGE` the PDB user has. If the PDB is protected by a PDB lockdown profile, then grants such as `GRANT INHERIT REMOTE PRIVILEGES` and `GRANT INHERIT ANY REMOTE` privileges succeed but the effects of these grants do not apply as long as the PDB lockdown continues.

The syntax for granting the `INHERIT ANY REMOTE PRIVILEGES` privilege is as follows:

```
GRANT INHERIT ANY REMOTE PRIVILEGES TO current_user;
```

In this specification, `current_user` is the user who owns the define's right procedure.

Related Topics

- [Restricting Operations on PDBs Using PDB Lockdown Profiles](#)
You can use PDB lockdown profiles to restrict sets of user operations in pluggable databases (PDBs).

9.8.5 Revokes of the INHERIT [ANY] REMOTE PRIVILEGES Privilege

The methods for revoking the `INHERIT REMOTE PRIVILEGES` and `INHERIT ANY REMOTE PRIVILEGES` privileges differ.

The `INHERIT REMOTE PRIVILEGES` privilege can be revoked by a user from another user. The `INHERIT ANY REMOTE PRIVILEGES` privilege must be revoked by a user with administrative privileges.

The revocation syntax is as follows

```
REVOKE INHERIT REMOTE PRIVILEGES ON USER connected_user FROM current_user;
```

In this specification:

- `connected_user` is the user who runs the definer's rights procedure.
- `current_user` is the user who owns the definer's rights procedure.

If you want to revoke the `INHERIT REMOTE PRIVILEGES` or `INHERIT ANY REMOTE PRIVILEGES` privilege from a user, use the standard revocation syntax, as follows:

```
REVOKE INHERIT REMOTE PRIVILEGES FROM connected_user;  
REVOKE INHERIT ANY REMOTE PRIVILEGES FROM current_user;
```

Related Topics

- [Oracle Database SQL Language Reference](#)

9.8.6 Example: Revoking the INHERIT REMOTE PRIVILEGES Privilege

The `REVOKE` SQL statement can revoke the `INHERIT REMOTE PRIVILEGES` privilege.

After you revoke the `INHERIT REMOTE PRIVILEGES` privilege, if user `jward` runs a definer's rights procedure that `jward` owns, then any operation on a connected user database link inside the definer's rights procedure fails because `jward` has explicitly denied `ebrown` the privilege to open a connected user database link using `jward`'s credentials.

[Example 9-5](#) shows how to revoke the `INHERIT REMOTE PRIVILEGES` procedure on the connecting user, `jward`, from the procedure owner, `ebrown`.

Example 9-5 Revoking the INHERIT REMOTE PRIVILEGES Privilege

```
REVOKE INHERIT REMOTE PRIVILEGES ON USER jward FROM ebrown;
```

9.8.7 Example: Revoking the INHERIT REMOTE PRIVILEGES Privilege from PUBLIC

The `REVOKE` SQL statement can revoke the `INHERIT REMOTE PRIVILEGES` from `PUBLIC`, as well as from individual procedure owners.

[Example 9-6](#) shows how to revoke this privilege from `PUBLIC`.

Example 9-6 Revoking the INHERIT REMOTE PRIVILEGES Privilege from PUBLIC

```
REVOKE INHERIT REMOTE PRIVILEGES FROM PUBLIC;
```

9.8.8 Tutorial: Using a Database Link in a Definer's Rights Procedure

This tutorial demonstrates how the `INHERIT REMOTE PRIVILEGES` privilege works in a definer's rights procedure that uses a database link.

- [About This Tutorial](#)
In this tutorial, you test the privilege grant and revoke of the `INHERIT REMOTE PRIVILEGES` privilege.
- [Step 1: Create User Accounts](#)
You must create a user who creates a definer's rights procedure that has a database link, and a second user who runs this procedure.
- [Step 2: As User `dbuser2`, Create a Table to Store User IDs](#)
The user IDs in this table are the IDs that the database link uses.
- [Step 3: As User `dbuser1`, Create a Database Link and Definer's Rights Procedure](#)
User `dbuser1` is ready to create a database link and then a definer's rights procedure that references the database link.
- [Step 4: Test the Definer's Rights Procedure](#)
User `dbuser2` must grant `INHERIT REMOTE PRIVILEGES` to `dbuser1` before the definer's rights procedure can be tested.
- [Step 5: Remove the Components of This Tutorial](#)
If you no longer need the components of this tutorial, then you can remove them.

9.8.8.1 About This Tutorial

In this tutorial, you test the privilege grant and revoke of the `INHERIT REMOTE PRIVILEGES` privilege.

To accomplish this, you must create two users, one who creates a definer's rights procedure that refers to a database link, and a second user to run this definer's rights procedure. Both users create identical look-up tables in their schemas. The definer's rights procedure must enable the second user to query the lookup table that belongs to the definer's rights users.

9.8.8.2 Step 1: Create User Accounts

You must create a user who creates a definer's rights procedure that has a database link, and a second user who runs this procedure.

1. Log in to a PDB as a user who has privileges to create users and perform privilege grants.

For example:

```
sqlplus sec_admin@pdb_name
Enter password: password
```

To find the available PDBs, query the `DBA_PDBS` data dictionary view. To check the current PDB, run the `show con_name` command.

2. Create the user accounts as follows:

```
GRANT CONNECT, RESOURCE, UNLIMITED TABLESPACE TO dbuser1 IDENTIFIED BY password;
GRANT CONNECT, RESOURCE, UNLIMITED TABLESPACE TO dbuser2 IDENTIFIED BY password;
```

Replace `password` with a password that is secure.

Related Topics

- [Guidelines for Securing Passwords](#)
Oracle provides guidelines for securing passwords in a variety of situations.

9.8.8.3 Step 2: As User dbuser2, Create a Table to Store User IDs

The user IDs in this table are the IDs that the database link uses.

1. Connect to the PDB as user `dbuser2` to instance `inst1`.

```
connect dbuser2@inst1
Enter password: password
```

The `tnsnames.ora` `SERVICE_NAME` setting for this instance maps to the correct PDB.

2. Create the following table:

```
CREATE TABLE dbusertab(ID NUMBER(2));
```

3. Populate this table with the ID value 10.

```
INSERT INTO dbusertab VALUES(10);
```

9.8.8.4 Step 3: As User dbuser1, Create a Database Link and Definer's Rights Procedure

User `dbuser1` is ready to create a database link and then a definer's rights procedure that references the database link.

1. Connect as user `dbuser1` to instance `inst1`.

```
connect dbuser1@inst1
Enter password: password
```

2. Create a database link, which will be used in the definer's rights procedure.

```
CREATE DATABASE LINK dblink USING 'inst1';
```

3. Create a `dbusertab` table and then populate it with the ID 20.

```
CREATE TABLE DBUSERTAB(ID NUMBER(2));
INSERT INTO dbusertab VALUES(20);
```

4. Create a definer's rights procedure that contains a reference to the database link

```
CREATE OR REPLACE PROCEDURE test_remote_db_link
AS
v_id varchar(50);
BEGIN
    SELECT ID INTO v_id FROM dbusertab@dblink;
    DBMS_OUTPUT.PUT_LINE('v_id : ' || v_id);
END ;
/
```

5. Test the definer's rights procedure.

```
SET SERVEROUTPUT ON
EXEC test_remote_db_link;
```

The output should be as follows, indicating that user `dbuser1` has run the procedure on `dbuser1`'s own version of the table `dbusertab`:

```
v_id : 20
```

6. Grant the user `dbuser2` the `EXECUTE` privilege on the `test_remote_db_link` procedure.

```
GRANT EXECUTE ON test_remote_db_link TO dbuser2;
```

9.8.8.5 Step 4: Test the Definer's Rights Procedure

User `dbuser2` must grant `INHERIT REMOTE PRIVILEGES` to `dbuser1` before the definer's rights procedure can be tested.

1. Connect as user `dbuser2` to instance `inst1`.

```
connect dbuser2@inst1
Enter password: password
```

2. Grant the `INHERIT REMOTE PRIVILEGE` privilege on user `dbuser2` to `dbuser1`.

```
GRANT INHERIT REMOTE PRIVILEGES ON user dbuser2 TO dbuser1;
```

3. Relog back in, because the grant does not take effect until you start a new session.

```
connect dbuser2@inst1
Enter password: password
```

4. Run the `test_remote_db_link` definer's rights procedure:

```
SET SERVEROUTPUT ON
EXEC dbuser1.test_remote_db_link;
```

The output shows the following, which indicates that user `dbuser1` is able to use the database link to connect to the schema of `dbuser2` and access the values in the `dbusertab` table in `dbuser2`'s schema.

```
v_id : 10
```

5. Revoke the `INHERIT REMOTE PRIVILEGE` privilege on `dbuser2` from `dbuser1`.

```
REVOKE INHERIT REMOTE PRIVILEGES ON USER dbuser2 FROM dbuser1;
```

6. Try executing the `test_remote_db_link` definer's rights procedure again.

```
EXEC dbuser1.test_remote_db_link;
```

The `ORA-25433: User DBUSER1 does not have INHERIT REMOTE PRIVILEGES on connected user DBUSER2 error should appear.`

9.8.8.6 Step 5: Remove the Components of This Tutorial

If you no longer need the components of this tutorial, then you can remove them.

1. Connect to the PDB as a user who has privileges to drop user accounts and database links

For example:

```
connect sec_admin@pdb_name
Enter password: password
```

2. Drop the user accounts.

```
DROP USER dbuser1 CASCADE;
DROP USER dbuser2 CASCADE;
```

3. Drop the `dblink` database link.

```
DROP PUBLIC DATABASE LINK dblink;
```

10

Managing Fine-Grained Access in PL/SQL Packages and Types

Oracle Database provides PL/SQL packages and types for fine-grained access to control access to external network services and wallets.

- [About Managing Fine-Grained Access in PL/SQL Packages and Types](#)
You can configure user access to external network services and wallets through a set of PL/SQL packages and one type.
- [About Fine-Grained Access Control to External Network Services](#)
Oracle Application Security access control lists (ACL) can implement fine-grained access control to external network services.
- [About Access Control to Oracle Wallets](#)
Encrypting communication between a remote web service and the Oracle database, acting as a client to this service, is an established industry best practice.
- [Upgraded Applications That Depend on Packages That Use External Network Services](#)
Upgraded applications may have [ORA-24247](#) network access errors.
- [Configuring Access Control for External Network Services](#)
The `DBMS_NETWORK_ACL` packages configures access control for external network services.
- [Configuring Access Control to an Oracle Wallet](#)
Fine-grained access control for Oracle wallets provide user access to network services that require passwords or certificates.
- [Examples of Configuring Access Control for External Network Services](#)
You can configure access control for a variety of situations, such as for a single role and network connection.
- [Specifying a Group of Network Host Computers](#)
You can use wildcards to specify a group of network host computers.
- [Precedence Order for a Host Computer in Multiple Access Control List Assignments](#)
The access control list assigned to a domain has a lower precedence than those assigned to the subdomains.
- [Precedence Order for a Host in Access Control List Assignments with Port Ranges](#)
The precedence order for a host in an access control list is determined by the use of port ranges.
- [Checking Privilege Assignments That Affect User Access to Network Hosts](#)
Both administrators and users can check network connection and domain privileges.
- [Configuring Network Access for Java Debug Wire Protocol Operations](#)
Before you can debug Java PL/SQL procedures, you must be granted the `jdbcwp` ACL privilege.
- [Data Dictionary Views for Access Control Lists Configured for User Access](#)
Oracle Database provides data dictionary views that you can use to find information about existing access control lists.

10.1 About Managing Fine-Grained Access in PL/SQL Packages and Types

You can configure user access to external network services and wallets through a set of PL/SQL packages and one type.

These packages are the `UTL_TCP`, `UTL_SMTP`, `UTL_MAIL`, `UTL_HTTP`, and `UTL_INADDR`, and the `DBMS_LDAP` PL/SQL packages, and the `HttpUriType` type.

The following scenarios are possible:

- **Configuring fine-grained access control for users and roles that need to access external network services from the database.** This way, specific groups of users can connect to one or more host computers, based on privileges that you grant them. Typically, you use this feature to control access to applications that run on specific host addresses.
- **Configuring fine-grained access control to Oracle wallets to make HTTP requests that require password or client-certificate authentication.** This feature enables you to grant privileges to users who are using passwords and client certificates stored in Oracle wallets to access external protected HTTP resources through the `UTL_HTTP` package. For example, you can configure applications to use the credentials stored in the wallets instead of hard-coding the credentials in the applications.

10.2 About Fine-Grained Access Control to External Network Services

Oracle Application Security access control lists (ACL) can implement fine-grained access control to external network services.

This guide explains how to configure the access control for database users and roles by using the `DBMS_NETWORK_ACL_ADMIN` PL/SQL package.

This feature enhances security for network connections because it restricts the external network hosts that a database user can connect to using the PL/SQL network utility packages `UTL_TCP`, `UTL_SMTP`, `UTL_MAIL`, `UTL_HTTP`, and `UTL_INADDR`; the `DBMS_LDAP` and `DBMS_DEBUG_JDWP` PL/SQL packages; and the `HttpUriType` type. Otherwise, an intruder who gained access to the database could maliciously attack the network, because, by default, the PL/SQL utility packages are created with the `EXECUTE` privilege granted to `PUBLIC` users. These PL/SQL network utility packages, and the `DBMS_NETWORK_ACL_ADMIN` and `DBMS_NETWORK_ACL_UTILITY` packages, support both IP Version 4 (IPv4) and IP Version 6 (IPv6) addresses. This guide explains how to manage access control to both versions.

Be aware that outbound Transport Layer Security (TLS) connections with `UTL_HTTP` cannot use the default trust store. You must create an Oracle wallet to hold the trust certificates.

Related Topics

- [Tutorial: Adding an Email Alert to a Fine-Grained Audit Policy](#)
This tutorial demonstrates how to create a fine-grained audit policy that generates an email alert when users violate the policy.
- [About Oracle Database Net Services Administrator's Guide](#)

- [Managing Oracle Database Wallets and Certificates](#)
You can use the `orapki` command line utility and `sqlnet.ora` parameters to manage public key infrastructure (PKI) elements.

10.3 About Access Control to Oracle Wallets

Encrypting communication between a remote web service and the Oracle database, acting as a client to this service, is an established industry best practice.

Oracle Database supports network encryption using Transport Layer Security (TLS) when invoking remote services. It also supports authentication methods that may be required. The Oracle database must be aware of the remote site's server certificate before it can securely establish the connection.

There are two ways to handle this configuration:

- **Using the system certificate store.** This method can be used for common TLS-protected web services (that is, HTTPS calls). To configure the system certificate store, you can use the `UTL_HTTP` PL/SQL package.
- **Storing the certificate in an Oracle wallet.** The use of Oracle wallets is beneficial because it provides secure storage of passwords and client certificates necessary to access protected Web pages. The Oracle wallet provides secure storage of user passwords and client certificates. To configure access control to a wallet, you must have the following components:
 - An Oracle wallet, which you can create by using the Oracle Database `orapki` or `mkstore` utility. The HTTP request will use the external password store or the client certificate in the wallet to authenticate the user.
 - An access control list, which you use to grant privileges to the user to use the wallet. To configure the access control list, you use the `DBMS_NETWORK_ACL_ADMIN` PL/SQL package.

Related Topics

- [Configuring Access Control to an Oracle Wallet](#)
Fine-grained access control for Oracle wallets provide user access to network services that require passwords or certificates.

10.4 Upgraded Applications That Depend on Packages That Use External Network Services

Upgraded applications may have `ORA-24247` network access errors.

If you have upgraded from a release before Oracle Database 11g Release 1 (11.1), and your applications depend on PL/SQL network utility packages (`UTL_TCP`, `UTL_SMTP`, `UTL_MAIL`, `UTL_HTTP`, `UTL_INADDR`, and `DBMS_LDAP`) or the `HttpUriType` type, then the `ORA-24247` error may occur when you try to run the application.

The error message is as follows:

```
ORA-24247: network access denied by access control list (ACL)
```

Use the procedures in this chapter to reconfigure the network access for the application.

 **See Also:**

Oracle Database Upgrade Guide for compatibility issues for applications that depend on the PL/SQL network utility packages

10.5 Configuring Access Control for External Network Services

The `DBMS_NETWORK_ACL` packages configures access control for external network services.

- [Syntax for Configuring Access Control for External Network Services](#)
You can use the `DBMS_NETWORK_ACL_ADMIN.APPEND_HOST_ACE` procedure to grant the access control privileges to a user.
- [Enabling the Listener to Recognize Access Control for External Network Services](#)
A `TNS-01166: Listener rejected registration or update of service ACL error` can result if the listener is not configured to recognize access control for external network services.
- [Example: Configuring Access Control for External Network Services](#)
The `DBMS_NETWORK_ACL_ADMIN.APPEND_HOST_ACE` procedure can configure access control for external network services.
- [Revoking Access Control Privileges for External Network Services](#)
You can remove access control privileges for external network services.
- [Example: Revoking External Network Services Privileges](#)
The `DBMS_NETWORK_ACL_ADMIN.REMOVE_HOST_ACE` procedure can be used to revoke external network privileges.

10.5.1 Syntax for Configuring Access Control for External Network Services

You can use the `DBMS_NETWORK_ACL_ADMIN.APPEND_HOST_ACE` procedure to grant the access control privileges to a user.

This procedure appends an access control entry (ACE) with the specified privilege to the ACL for the given host, and creates the ACL if it does not exist yet. The resultant configuration resides in the `SYS` schema, not the schema of the user who created it.

The syntax is as follows:

```

BEGIN
  DBMS_NETWORK_ACL_ADMIN.APPEND_HOST_ACE (
    host          => 'host_name',
    lower_port    => null|port_number,
    upper_port    => null|port_number,
    ace           => ace_definition);
END;
```

In this specification:

- `host`: Enter the name of the host. It can be the host name or an IP address of the host. You can use a wildcard to specify a domain or an IP subnet. Be aware of the precedence order for a host computer in multiple access control list assignments when you use wildcards in domain names.) The host or domain name is case insensitive. Examples are as follows:

```
host      => 'www.example.com',
```

```
host      => '*example.com',
```

- **lower_port:** (Optional) For TCP connections, enter the lower boundary of the port range. Use this setting for the `connect` privilege only. Omit it for the `resolve` privilege. The default is `null`, which means that there is no port restriction (that is, the ACL applies to all ports). The range of port numbers is between 1 and 65535.

For example:

```
lower_port => 80,
```

- **upper_port:** (Optional) For TCP connections, enter the upper boundary of the port range. Use this setting for `connect` privileges only. Omit it for the `resolve` privilege. The default is `null`, which means that there is no port restriction (that is, the ACL applies to all ports). The range of port numbers is between 1 and 65535

For example:

```
upper_port => 3999);
```

If you enter a value for the `lower_port` and leave the `upper_port` at `null` (or just omit it), then Oracle Database assumes the `upper_port` setting is the same as the `lower_port`. For example, if you set `lower_port` to 80 and omit `upper_port`, the `upper_port` setting is assumed to be 80.

The `resolve` privilege in the access control list has no effect when a port range is specified in the access control list assignment.

- **ace:** Define the ACE by using the `XS$ACE_TYPE` constant, in the following format:

```
ace      => xs$ace_type(privilege_list => xs$name_list('privilege'),
                    principal_name => 'user_or_role',
                    principal_type => xs$ace_type_user));
```

In this specification:

- **privilege_list:** Enter one or more of the following privileges, which are case insensitive. Enclose each privilege with single quotation marks and separate each with a comma (for example, `'http', 'http_proxy'`).

For tighter access control, grant only the `http`, `http_proxy`, or `smtp` privilege instead of the `connect` privilege if the user uses the `UTL_HTTP`, `HttpUriType`, `UTL_SMTP`, or `UTL_MAIL` only.

- `http`: Makes an HTTP request to a host through the `UTL_HTTP` package and the `HttpUriType` type

- `http_proxy`: Makes an HTTP request through a proxy through the `UTL_HTTP` package and the `HttpUriType` type. You must include `http_proxy` in conjunction to the `http` privilege if the user makes the HTTP request through a proxy.

- `smtp`: Sends SMTP to a host through the `UTL_SMTP` and `UTL_MAIL` packages

- `resolve`: Resolves a network host name or IP address through the `UTL_INADDR` package

- `connect`: Grants the user permission to connect to a network service at a host through the `UTL_TCP`, `UTL_SMTP`, `UTL_MAIL`, `UTL_HTTP`, and `DBMS_LDAP` packages, or the `HttpUriType` type

- `jdwp`: Used for Java Debug Wire Protocol debugging operations for Java or PL/SQL stored procedures.

- `principal_name`: Enter a database user name or role. This value is case insensitive, unless you enter it in double quotation marks (for example, `"ACCT_MGR"`).
- `principal_type`: Enter `XS_ACL.PTYPE_DB` for a database user or role. You must specify `PTYPE_DB` because the `principal_type` value defaults to `PTYPE_XS`, which is used to specify an Oracle Database Real Application Security application user.

Related Topics

- [Precedence Order for a Host Computer in Multiple Access Control List Assignments](#)
The access control list assigned to a domain has a lower precedence than those assigned to the subdomains.
- [Configuring Network Access for Java Debug Wire Protocol Operations](#)
Before you can debug Java PL/SQL procedures, you must be granted the `jdwp` ACL privilege.

See Also:

Oracle Database Real Application Security Administrator's and Developer's Guide for information about additional `XS$ACE_TYPE` parameters that you can include for the `ace` parameter setting: `granted`, `inverted`, `start_date`, and `end_date`

10.5.2 Enabling the Listener to Recognize Access Control for External Network Services

A `TNS-01166: Listener rejected registration or update of service ACL error` can result if the listener is not configured to recognize access control for external network services.

1. Add the following line to the `listener.ora` file:

```
LOCAL_REGISTRATION_ADDRESS_LISTENER = ON
```

2. Restart the listener.

```
./lsnrctl stop
./lsnrctl start
```

10.5.3 Example: Configuring Access Control for External Network Services

The `DBMS_NETWORK_ACL_ADMIN.APPEND_HOST_ACE` procedure can configure access control for external network services.

[Example 10-1](#) shows how to grant the `http` and `smtp` privileges to the `acct_mgr` database role for an ACL created for the host `www.example.com`.

Example 10-1 Granting Privileges to a Database Role External Network Services

```
BEGIN
DBMS_NETWORK_ACL_ADMIN.APPEND_HOST_ACE(
  host      => 'www.example.com',
  ace       => xs$ace_type(privilege_list => xs$name_list('http', 'smtp'),
                          principal_name => 'acct_mgr',
                          principal_type => xs_acl.ptype_db));
```

```
END;
/
```

10.5.4 Revoking Access Control Privileges for External Network Services

You can remove access control privileges for external network services.

- To revoke access control privileges for external network services, run the `DBMS_NETWORK_ACL_ADMIN.REMOVE_HOST_ACE` procedure.

Related Topics

- [Oracle Database PL/SQL Packages and Types Reference](#)

10.5.5 Example: Revoking External Network Services Privileges

The `DBMS_NETWORK_ACL_ADMIN.REMOVE_HOST_ACE` procedure can be used to revoke external network privileges.

[Example 10-2](#) shows how to revoke external network privileges.

Example 10-2 Revoking External Network Services Privileges

```
BEGIN
DBMS_NETWORK_ACL_ADMIN.REMOVE_HOST_ACE (
  host      => 'www.example.com',
  lower_port => 80,
  upper_port => upper_port => 3999,
  ace       => xs$ace_type(privilege_list => xs$name_list('http', 'smtp'),
                          principal_name => 'acct_mgr',
                          principal_type => xs_acl.ptype_db),
  remove_empty_acl => TRUE);
END;
/
```

In this specification, the `TRUE` setting for `remove_empty_acl` removes the ACL when it becomes empty when the ACE is removed.

10.6 Configuring Access Control to an Oracle Wallet

Fine-grained access control for Oracle wallets provide user access to network services that require passwords or certificates.

- [About Configuring Access Control to an Oracle Wallet](#)
You can configure access control to grant access to passwords and client certificates.
- [Step 1: Configure the Operating System Certificate Store as the Default Wallet Path](#)
You can use the `UTL_HTTP`, `UTL_TCP`, or `UTL_SMTP` PL/SQL packages to configure a the system's certificate store to act in place of an Oracle wallet.
- [Step 2: Configure Access Control Privileges for the Oracle Wallet](#)
After you have created the wallet, you are ready to configure access control privileges for the wallet.
- [Step 3: Make the HTTP Request with the Passwords and Client Certificates](#)
The `UTL_HTTP` package can create an HTTP request object to hold wallet information, which can authenticate using a client certificate or a password.
- [Revoking Access Control Privileges for Oracle Wallets](#)
You can revoke access control privileges for an Oracle wallet.

- [Troubleshooting ORA-29024 Errors](#)
The ORA-29024: Certificate validation failure error occurs when the facility, component, or product or a failing operation is expecting an Oracle wallet.

10.6.1 About Configuring Access Control to an Oracle Wallet

You can configure access control to grant access to passwords and client certificates.

These passwords and client certificates are stored in an Oracle wallet. The access control that you configure enables users to authenticate themselves to an external network service when using the PL/SQL network utility packages.

This enables the user to gain access to the network service that requires password or certificate identification.

10.6.2 Step 1: Configure the Operating System Certificate Store as the Default Wallet Path

You can use the `UTL_HTTP`, `UTL_TCP`, or `UTL_SMTP` PL/SQL packages to configure a the system's certificate store to act in place of an Oracle wallet.

In previous releases, you used `orapki` to create a wallet. If you choose to create a wallet, then make a note of the directory in which you created the wallet. You will need this directory path when you complete the procedures in this section. However, using the operating system certificate in place of a wallet greatly improves Oracle Database performance.

In a new connected session, `UTL_HTTP` uses the default system certificate store. If `UTL_HTTP.SET_WALLET` had been set, then setting `UTL_HTTP.SET_WALLET` to `system:` overrides the previous `UTL_HTTP.SET_WALLET` setting.

- To use the system certificate, specify `system:` (including the colon), in the following commands:
 - Run the `UTL_HTTP.SET_WALLET('system:')` procedure to explicitly request to use the system's certificate store. (In the absence of any configuration, the `UTL_HTTP` package uses the system's certificate store as the default wallet.)
 - Pass `wallet_path => 'system:'` to the `UTL_HTTP.REQUEST()` procedure and related functions in the package.
 - For the `UTL_TCP` and `UTL_SMTP` packages, set any procedures that use the `wallet_path` parameter to the `'system:'` setting.

Related Topics

- [Example: Configuring ACL Access Using Passwords in a Non-Shared Wallet](#)
The `DBMS_NETWORK_ACL_ADMIN` and `UTL_HTTP` PL/SQL packages can configure ACL access using passwords in a non-shared wallet.
- [Example: Configuring ACL Access for a Wallet in a Shared Database Session](#)
The `DBMS_NETWORK_ACL_ADMIN` and `UTL_HTTP` PL/SQL packages can configure ACL access for a wallet in a shared database session.

10.6.3 Step 2: Configure Access Control Privileges for the Oracle Wallet

After you have created the wallet, you are ready to configure access control privileges for the wallet.

- Use the `DBMS_NETWORK_ACL_ADMIN.APPEND_WALLET_ACE` procedure to configure the wallet access control privileges.

The syntax for the `DBMS_NETWORK_ACL_ADMIN.APPEND_WALLET_ACE` procedure is as follows:

```
BEGIN
  DBMS_NETWORK_ACL_ADMIN.APPEND_WALLET_ACE (
    wallet_path => 'directory_path_to_wallet',
    ace         => xs$ace_type(privilege_list => xs$name_list('privilege'),
                              principal_name => 'user_or_role',
                              principal_type => xs$ace_type_user));
END;
```

In this specification:

- `wallet_path`: Enter the path to the directory that contains the wallet that you just created. When you specify the wallet path, you must use an absolute path and include `file:` before this directory path. Do not use environment variables, such as `$ORACLE_HOME`, nor insert a space after `file:` and before the path name. For example:

```
wallet_path => 'file:/oracle/wallets/hr_wallet',
```

- `ace`: Define the ACL by using the `XS$ACE_TYPE` constant. For example:

```
ace         => xs$ace_type(privilege_list => xs$name_list(privilege),
                          principal_name => 'hr_clerk',
                          principal_type => xs_acl.ptype_db);
```

In this specification, `privilege` must be one of the following when you enter wallet privileges using `xs$ace_type` (note the use of underscores in these privilege names):

- * `use_client_certificates`
- * `use_passwords`

Be aware that for wallets, you must specify either the `use_client_certificates` or `use_passwords` privileges.

See Also:

Oracle Database Real Application Security Administrator's and Developer's Guide for information about additional `XS$ACE_TYPE` parameters that you can include for the `ace` parameter setting: `granted`, `inverted`, `start_date`, and `end_date`

Related Topics

- [Step 1: Configure the Operating System Certificate Store as the Default Wallet Path](#)
You can use the `UTL_HTTP`, `UTL_TCP`, or `UTL_SMTP` PL/SQL packages to configure a the system's certificate store to act in place of an Oracle wallet.
- [Syntax for Configuring Access Control for External Network Services](#)
You can use the `DBMS_NETWORK_ACL_ADMIN.APPEND_HOST_ACE` procedure to grant the access control privileges to a user.

10.6.4 Step 3: Make the HTTP Request with the Passwords and Client Certificates

The `UTL_HTTP` package can create an HTTP request object to hold wallet information, which can authenticate using a client certificate or a password.

- [Making the HTTPS Request with the Passwords and Client Certificates](#)
The `UTL_HTTP` package makes Hypertext Transfer Protocol (HTTP) callouts from SQL and PL/SQL.
- [Using a Request Context to Hold the Wallet When Sharing the Session with Other Applications](#)
You should use a request context to hold the wallet when other applications share the database session.
- [Use of Only a Client Certificate to Authenticate](#)
Only a client certificate can authenticate users, as long as the user has been granted the appropriate privilege in the ACL wallet.
- [Use of a Password to Authenticate](#)
If the protected URL being requested requires username and password authentication, then set the username and password from the wallet to authenticate.

10.6.4.1 Making the HTTPS Request with the Passwords and Client Certificates

The `UTL_HTTP` package makes Hypertext Transfer Protocol (HTTP) callouts from SQL and PL/SQL.

- Use the `UTL_HTTP` PL/SQL package to create a request context object that is used privately with the HTTP request and its response.

For example:

```
DECLARE
  req_context UTL_HTTP.REQUEST_CONTEXT_KEY;
  req         UTL_HTTP.REQ;
BEGIN
  req_context := UTL_HTTP.CREATE_REQUEST_CONTEXT (
    wallet_path      => 'file:path_to_directory_containing_wallet',
    wallet_password  => 'wallet_password'|NULL);
  req := UTL_HTTP.BEGIN_REQUEST(
    url              => 'URL_to_application',
    request_context  => 'request_context'|NULL);
  ...
END;
```

In this specification:

- `req_context`: Use the `UTL_HTTP.CREATE_REQUEST_CONTEXT_KEY` data type to create the request context object. This object stores a randomly-generated numeric key that Oracle Database uses to identify the request context. The `UTL_HTTP.CREATE_REQUEST_CONTEXT` function creates the request context itself.
- `req`: Use the `UTL_HTTP.REQ` data type to create the object that will be used to begin the HTTP request. You will refer to this object later on, when you set the user name and password from the wallet to access a password-protected Web page.
- `wallet_path`: Enter the path to the directory that contains the wallet. Ensure that this path is the same path you specified when you created access control list earlier when

configuring access control privileges for the Oracle wallet. You must include `file:` before the directory path. Do not use environment variables, such as `$ORACLE_HOME`.

For example:

```
wallet_path          => 'file:/oracle/wallets/hr_wallet',
```

- `wallet_password`: Enter the password used to open the wallet. The default is `NULL`, which is used for auto-login wallets. For example:

```
wallet_password      => 'wallet_password');
```

- `url`: Enter the URL to the application that uses the wallet.

For example:

```
url                  => 'www.hr_access.example.com',
```

- `request_context`: Enter the name of the request context object that you created earlier in this section. This object prevents the wallet from being shared with other applications in the same database session.

For example:

```
request_context      => req_context);
```

Related Topics

- [Step 2: Configure Access Control Privileges for the Oracle Wallet](#)
After you have created the wallet, you are ready to configure access control privileges for the wallet.
- *Oracle Database PL/SQL Packages and Types Reference*

10.6.4.2 Using a Request Context to Hold the Wallet When Sharing the Session with Other Applications

You should use a request context to hold the wallet when other applications share the database session.

If your application has exclusive use of the database session, you can hold the wallet in the database session by using the `UTL_HTTP.SET_WALLET` procedure.

- Use the `UTL_HTTP.SET_WALLET` procedure to configure the request to hold the wallet.

For example:

```
DECLARE
  req          UTL_HTTP.REQ;
BEGIN
  UTL_HTTP.SET_WALLET(
    path          => 'file:path_to_directory_containing_wallet',
    password      => 'wallet_password'|NULL);
  req := UTL_HTTP.BEGIN_REQUEST(
    url           => 'URL_to_application');
  ...
END;
```

If the protected URL being requested requires the user name and password to authenticate, then you can use the `SET_AUTHENTICATION_FROM_WALLET` procedure to set the user name and password from the wallet to authenticate.

10.6.4.3 Use of Only a Client Certificate to Authenticate

Only a client certificate can authenticate users, as long as the user has been granted the appropriate privilege in the ACL wallet.

If the protected URL being requested requires only the client certificate to authenticate, then the `BEGIN_REQUEST` function sends the necessary client certificate from the wallet. Assuming the user has been granted the `use_client_certificates` privilege in the ACL assigned to the wallet.

The authentication should succeed at the remote Web server and the user can proceed to retrieve the HTTP response by using the `GET_RESPONSE` function.

10.6.4.4 Use of a Password to Authenticate

If the protected URL being requested requires username and password authentication, then set the username and password from the wallet to authenticate.

For example:

```
DECLARE
  req_context UTL_HTTP.REQUEST_CONTEXT_KEY;
  req         UTL_HTTP.REQ;
BEGIN
  ...
  UTL_HTTP.SET_AUTHENTICATION_FROM_WALLET(
    r           => HTTP_REQUEST,
    alias       => 'alias_to_retrieve_credentials_stored_in_wallet',
    scheme      => 'AWS|Basic',
    for_proxy   => TRUE|FALSE);
END;
```

In this specification:

- `r`: Enter the HTTP request defined in the `UTL_HTTP.BEGIN_REQUEST` procedure that you created above, in the previous section. For example:

```
r           => req,
```

- `alias`: Enter the alias used to identify and retrieve the user name and password credential stored in the Oracle wallet. For example, assuming the alias used to identify this user name and password credential is `hr_access`.

```
alias       => 'hr_access',
```

- `scheme`: Enter one of the following:
 - `AWS`: Specifies the Amazon Simple Storage Service (S3) scheme. Use this scheme only if you are configuring access to the Amazon.com Web site. (Contact Amazon for more information about this setting.)
 - `Basic`: Specifies HTTP basic authentication. The default is `Basic`.

For example:

```
scheme      => 'Basic',
```

- `for_proxy`: Specify whether the HTTP authentication information is for access to the HTTP proxy server instead of the Web server. The default is `FALSE`.

For example:

```
for_proxy => TRUE);
```

The use of the user name and password in the wallet requires the `use_passwords` privilege to be granted to the user in the ACL assigned to the wallet.

10.6.5 Revoking Access Control Privileges for Oracle Wallets

You can revoke access control privileges for an Oracle wallet.

- To revoke privileges from access control entries (ACE) in the access control list (ACL) of a wallet, run the `DBMS_NETWORK_ACL_ADMIN.REMOVE_WALLET_ACE` procedure.

For example:

```
BEGIN
DBMS_NETWORK_ACL_ADMIN.REMOVE_WALLET_ACE (
  wallet_path => 'file:/oracle/wallets/hr_wallet',
  ace         => xs$ace_type(privilege_list => xs$name_list(privilege),
                             principal_name => 'hr_clerk',
                             principal_type => xs_acl.p_type_db),
  remove_empty_acl => TRUE);
END;
/
```

In this example, the `TRUE` setting for `remove_empty_acl` removes the ACL when it becomes empty when the wallet ACE is removed.

10.6.6 Troubleshooting ORA-29024 Errors

The `ORA-29024: Certificate validation failure` error occurs when the facility, component, or product or a failing operation is expecting an Oracle wallet.

You can troubleshoot this error by using the following methods, in this order:

1. Check is the relevant Oracle documentation for the steps related to the failing configuration.

For example, if this error is occurs while using `UTL_HTTP`, then it means that a secure web site is being accessed without a wallet and this operation needs a wallet created. See *Oracle Database PL/SQL Packages and Types Reference* for information about using the `UTL_HTTP` PL/SQL package.

In another example, the error can occur while making a remote connection to the database server over a TLS connection, which indicates that this connection is expecting an Oracle wallet. Troubleshooting this problem requires a proper understanding of Oracle Wallets and certificates. See [Configuring PKI Certificate Authentication](#).

2. After the wallet is configured according to the documentation, if the error still occurs, then try the following solutions:

- Open the wallet using the `orapki` utility as follows:

```
orapki wallet display -wallet wallet_file_directory
```

If this command fails, then it means that the wallet is corrupt. Create a new wallet and recheck the scenario.

- If the current configuration needs a wallet with a user and trusted certificates, then check whether both the user and trusted certificates are valid and not expired or revoked.

- If this error occurs while using the wallet with a UTL_HTTP configuration, then check whether all the certificates of the secure web site are there in the wallet and the certificate chain is complete.
- If there is a proxy server involved, then ensure that the target website is in the proxy allowlist.

See the following My Oracle Support notes for information about getting a complete certificate chain of a secure site for a UTL_HTTPS call.

- [Note 169768.1](#) Configuring Wallet Manager to enable HTTPS connections via UTL_HTTP.REQUEST
- [Note 230917.1](#) Troubleshooting the UTL_HTTP Package

10.7 Examples of Configuring Access Control for External Network Services

You can configure access control for a variety of situations, such as for a single role and network connection.

- [Example: Configuring Access Control for a Single Role and Network Connection](#)
The DBMS_NETWORK_ACL_ADMIN.APPEND_HOST_ACE procedure can configure access control for a single role and network connection.
- [Example: Configuring Access Control for a User and Role](#)
The DBMS_NETWORK_ACL_ADMIN.APPEND_HOST_ACE can configure access control to deny or grant privileges for a user and a role.
- [Example: Using the DBA_HOST_ACES View to Show Granted Privileges](#)
The DBA_HOST_ACE data dictionary view shows privileges that have been granted to users.
- [Example: Configuring ACL Access Using Passwords in a Non-Shared Wallet](#)
The DBMS_NETWORK_ACL_ADMIN and UTL_HTTP PL/SQL packages can configure ACL access using passwords in a non-shared wallet.
- [Example: Configuring ACL Access for a Wallet in a Shared Database Session](#)
The DBMS_NETWORK_ACL_ADMIN and UTL_HTTP PL/SQL packages can configure ACL access for a wallet in a shared database session.

10.7.1 Example: Configuring Access Control for a Single Role and Network Connection

The DBMS_NETWORK_ACL_ADMIN.APPEND_HOST_ACE procedure can configure access control for a single role and network connection.

[Example 10-3](#) shows how you would configure access control for a single role (acct_mgr) and grant this role the http privilege for access to the www.us.example.com host. The privilege expires January 1, 2013.

Example 10-3 Configuring Access Control for a Single Role and Network Connection

```
BEGIN
DBMS_NETWORK_ACL_ADMIN.APPEND_HOST_ACE (
  host      => 'www.us.example.com',
  lower_port => 80,
  ace       => xs$ace_type(privilege_list => xs$name_list('http'),
                          principal_name => 'acct_mgr',
```

```

principal_type => xs_acl.p_type_db,
end_date => TIMESTAMP '2013-01-01 00:00:00.00 -08:00');
END;
/

```

10.7.2 Example: Configuring Access Control for a User and Role

The `DBMS_NETWORK_ACL_ADMIN.APPEND_HOST_ACE` can configure access control to deny or grant privileges for a user and a role.

Afterwards, you can query the `DBA_HOST_ACES` data dictionary view to find information about the privilege grants.

Example 10-4 grants to a database role (`acct_mgr`) but denies a particular user (`psmith`) even if that user has the role. The order is important because ACEs are evaluated in the given order. In this case, the deny ACE (`granted => false`) must be appended first or else the user cannot be denied.

Example 10-4 Configuring Access Control Using a Grant and a Deny for User and Role

```

BEGIN
DBMS_NETWORK_ACL_ADMIN.APPEND_HOST_ACE(
  host      => 'www.us.example.com',
  lower_port => 80,
  upper_port => 80,
  ace       => xs$ace_type(privilege_list => xs$name_list('http'),
                          principal_name => 'psmith',
                          principal_type => xs_acl.p_type_db,
                          granted       => false));

DBMS_NETWORK_ACL_ADMIN.APPEND_HOST_ACE(
  host      => 'www.us.example.com',
  lower_port => 80,
  upper_port => 80,
  ace       => xs$ace_type(privilege_list => xs$name_list('http'),
                          principal_name => 'acct_mgr',
                          principal_type => xs_acl.p_type_db,
                          granted       => true));
END;

```

10.7.3 Example: Using the DBA_HOST_ACES View to Show Granted Privileges

The `DBA_HOST_ACE` data dictionary view shows privileges that have been granted to users.

Example 10-5 shows how the `DBA_HOST_ACES` data dictionary view displays the privilege granted in the previous access control list.

Example 10-5 Using the DBA_HOST_ACES View to Show Granted Privileges

```
SELECT PRINCIPAL, PRIVILEGE, GRANT_TYPE FROM DBA_HOST_ACE WHERE PRIVILEGE = 'HTTP';
```

PRINCIPAL	PRIVILEGE	GRANT_TYPE
PSMITH	HTTP	FALSE
ACCT_MGR	HTTP	TRUE

10.7.4 Example: Configuring ACL Access Using Passwords in a Non-Shared Wallet

The `DBMS_NETWORK_ACL_ADMIN` and `UTL_HTTP` PL/SQL packages can configure ACL access using passwords in a non-shared wallet.

Example 10-6 configures wallet access for two Human Resources department roles, `hr_clerk` and `hr_manager`. These roles use the `use_passwords` privilege to access passwords stored in the wallet. In this example, the wallet will not be shared with other applications within the same database session.

Example 10-6 Configuring ACL Access Using Passwords in a Non-Shared Wallet

```

/* 1. At a command prompt, create the wallet. The following example uses the
   user name hr_access as the alias to identify the user name and password
   stored in the wallet. You must use this alias name when you call the
   SET_AUTHENTICATION_FROM_WALLET procedure later on. */
$ mkstore -wrl $ORACLE_HOME/wallets/hr_wallet -create
Enter password: password
Enter password again: password
$ mkstore -wrl $ORACLE_HOME/wallets/hr_wallet -createCredential hr_access hr_usr
Your secret/Password is missing in the command line
Enter your secret/Password: password
Re-enter your secret/Password: password
Enter wallet password: password

/* 2. In SQL*Plus, create an access control list to grant privileges for the
   wallet. The following example grants the use_passwords privilege to the
   hr_clerk role.*/
BEGIN
DBMS_NETWORK_ACL_ADMIN.APPEND_WALLET_ACE (
  wallet_path => 'file:/oracle/wallets/hr_wallet',
  ace         => xs$acl_type(privilege_list => xs$name_list('use_passwords'),
                             principal_name => 'hr_clerk',
                             principal_type => xs_acl.p_type_db));
END;
/

/* 3. Create a request context and request object, and then set the authentication
   for the wallet. */
DECLARE
  req_context  UTL_HTTP.REQUEST_CONTEXT_KEY;
  req          UTL_HTTP.REQ;

BEGIN
  req_context := UTL_HTTP.CREATE_REQUEST_CONTEXT(
    wallet_path      => 'file:/oracle/wallets/hr_wallet',
    wallet_password  => NULL,
    enable_cookies  => TRUE,
    max_cookies     => 300,
    max_cookies_per_site => 20);
  req := UTL_HTTP.BEGIN_REQUEST(
    url              => 'www.hr_access.example.com',
    request_context => req_context);
  UTL_HTTP.SET_AUTHENTICATION_FROM_WALLET(
    r               => req,
    alias           => 'hr_access',
    scheme          => 'Basic',
    for_proxy       => FALSE);

```

```
END;  
/
```

10.7.5 Example: Configuring ACL Access for a Wallet in a Shared Database Session

The `DBMS_NETWORK_ACL_ADMIN` and `UTL_HTTP` PL/SQL packages can configure ACL access for a wallet in a shared database session.

[Example 10-7](#) configures the wallet to be used for a shared database session; that is, all applications within the current database session will have access to this wallet.

Example 10-7 Configuring ACL Access for a Wallet in a Shared Database Session

/* Follow these steps:

1. Use the `orapki` utility to create the wallet and add the client certificate. For example:

```
orapki wallet create -wallet wallet_location  
orapki wallet add -wallet wallet_location -trusted_cert -cert  
certificate_location
```

2. In `SQL*Plus`, configure access control to grant privileges for the wallet. The following example grants the `use_client_certificates` privilege to the `hr_clerk` and `hr_mgr` roles. ***/**

```
BEGIN  
DBMS_NETWORK_ACL_ADMIN.APPEND_WALLET_ACE (  
  wallet_path => 'file:/oracle/wallets/hr_wallet',  
  ace        => xs$ace_type(privilege_list => xs$name_list('use-client_certificates'),  
                           principal_name => 'hr_clerk',  
                           principal_type => xs_acl.p_type_db));  
  
DBMS_NETWORK_ACL_ADMIN.APPEND_WALLET_ACE (  
  wallet_path => 'file:/oracle/wallets/hr_wallet',  
  ace        => xs$ace_type(privilege_list => xs$name_list('use_client_certificates'),  
                           principal_name => 'hr_mgr',  
                           principal_type => xs_acl.p_type_db));  
  
END;  
/  
COMMIT;
```

/* 3. Create a request object to handle the HTTP authentication for the wallet.*/

```
DECLARE  
  req UTL_HTTP.req;  
BEGIN  
  UTL_HTTP.SET_WALLET(  
    path          => 'file:/oracle/wallets/hr_wallet',  
    password     => NULL);  
  req := UTL_HTTP.BEGIN_REQUEST(  
    url          => 'www.hr_access.example.com',  
    method      => 'POST',  
    http_version => NULL,  
    request_context => NULL);  
END;  
/
```

10.8 Specifying a Group of Network Host Computers

You can use wildcards to specify a group of network host computers.

- To assign an access control list to a group of network host computers, use the asterisk (*) wildcard character.

For example, enter `*.example.com` for host computers that belong to a domain or `192.0.2.*` for IPv4 addresses that belong to an IP subnet. The asterisk wildcard must be at the beginning, before a period (.) in a domain, or at the end, after a period (.), in an IP subnet. For example, `*.example.com` is valid, but `*example.com` and `*.example.*` are not. Be aware that the use of wildcard characters affects the order of precedence for multiple access control lists that are assigned to the same host computer. You cannot use wildcard characters for IPv6 addresses.

The Classless Inter-Domain Routing (CIDR) notation defines how IPv4 and IPv6 addresses are categorized for routing IP packets on the internet. The `DBMS_NETWORK_ACL_ADMIN` package supports CIDR notation for both IPv4 and IPv6 addresses. This package considers an IPv4-mapped IPv6 address or subnet equivalent to the IPv4-native address or subnet it represents. For example, `::ffff:192.0.2.1` is equivalent to `192.0.2.1`, and `::ffff:192.0.2.1/120` is equivalent to `192.0.2.*`.

10.9 Precedence Order for a Host Computer in Multiple Access Control List Assignments

The access control list assigned to a domain has a lower precedence than those assigned to the subdomains.

For multiple access control lists that are assigned to the host computer and its domains, the access control list that is assigned to the host computer takes precedence over those assigned to the domains.

The access control list assigned to a domain has a lower precedence than those assigned to the subdomains. For example, Oracle Database first selects the access control list assigned to the host `server.us.example.com`, ahead of other access control lists assigned to its domains. If additional access control lists were assigned to the sub domains, their order of precedence is as follows:

1. `server.us.example.com`
2. `*.us.example.com`
3. `*.example.com`
4. `*.com`
5. `*`

Similarly, for multiple access control lists that are assigned to the IP address (both IPv4 and IPv6) and the subnets it belongs to, the access control list that is assigned to the IP address takes precedence over those assigned to the subnets. The access control list assigned to a subnet has a lower precedence than those assigned to the smaller subnets it contains.

For example, Oracle Database first selects the access control list assigned to the IP address `192.0.2.3`, ahead of other access control lists assigned to the subnets it belongs to. If additional access control lists were assigned to the subnets, their order of precedence is as follows:

1. 192.0.2.3 (or ::ffff:192.0.2.3)
2. 192.0.2.3/31 (or ::ffff:192.0.2.3/127)
3. 192.0.2.3/30 (or ::ffff:192.0.2.3/126)
4. 192.0.2.3/29 (or ::ffff:192.0.2.3/125)
5. ...
6. 192.0.2.3/24 (or ::ffff:192.0.2.3/120 or 192.0.2.*)
7. ...
8. 192.0.2.3/16 (or ::ffff:192.0.2.3/112 or 192.0.*)
9. ...
10. 192.0.2.3/8 (or ::ffff:192.0.2.3/104 or 192.*)
11. ...
12. ::ffff:192.0.2.3/95
13. ::ffff:192.0.2.3/94
14. ...
15. *

10.10 Precedence Order for a Host in Access Control List Assignments with Port Ranges

The precedence order for a host in an access control list is determined by the use of port ranges.

When an access control list is assigned to a host computer, a domain, or an IP subnet with a port range, it takes precedence over the access control list assigned to the same host, domain, or IP subnet without a port range.

For example, suppose you have TCP connections to any port between port 80 and 99 at `server.us.example.com`. Oracle Database first selects the access control list assigned to port 80 through 99 at `server.us.example.com`, ahead of the other access control list assigned to `server.us.example.com` that is without a port range.

10.11 Checking Privilege Assignments That Affect User Access to Network Hosts

Both administrators and users can check network connection and domain privileges.

- [About Privilege Assignments that Affect User Access to Network Hosts](#)
Oracle provides DBA-specific data dictionary views to find information about privilege assignments.
- [How to Check User Network Connection and Domain Privileges](#)
A database administrator can query the `DBA_HOST_ACES` data dictionary view to find the privileges that have been granted for specific users or roles.

- [Example: Administrator Checking User Network Access Control Permissions](#)
The `DBA_HOST_ACES` data dictionary view can check the network access control permissions for users.
- [How Users Can Check Their Network Connection and Domain Privileges](#)
Users can query the `USER_HOST_ACES` data dictionary view to check their network and domain permissions.
- [Example: User Checking Network Access Control Permissions](#)
The `USER_HOST_ACES` data dictionary view shows network access control permissions for a host computer.

10.11.1 About Privilege Assignments that Affect User Access to Network Hosts

Oracle provides DBA-specific data dictionary views to find information about privilege assignments.

Database administrators can use the `DBA_HOST_ACES` data dictionary view to query network privileges that have been granted to or denied from database users and roles in the access control lists, and whether those privileges take effect during certain times only

Using the information provided by the view, you may need to combine the data to determine if a user is granted the privilege at the current time, the roles the user has, the order of the access control entries, and so on.

Users without database administrator privileges do not have the privilege to access the access control lists or to invoke those `DBMS_NETWORK_ACL_ADMIN` functions. However, they can query the `USER_HOST_ACES` data dictionary view to check their privileges instead.

Database administrators and users can use the following `DBMS_NETWORK_ACL_UTILITY` functions to determine if two hosts, domains, or subnets are equivalent, or if a host, domain, or subnet is equal to or contained in another host, domain, or subnet:

- `EQUALS_HOST`: Returns a value to indicate if two hosts, domains, or subnets are equivalent
- `CONTAINS_HOST`: Returns a value to indicate if a host, domain, or subnet is equal to or contained in another host, domain, or subnet, and the relative order of precedence of the containing domain or subnet for its ACL assignments

If you do not use IPv6 addresses, database administrators and users can use the following `DBMS_NETWORK_ACL_UTILITY` functions to generate the list of domains or IPv4 subnet a host belongs to and to sort the access control lists by their order of precedence according to their host assignments:

- `DOMAINS`: Returns a list of the domains or IP subnets whose access control lists may affect permissions to a specified network host, subdomain, or IP subnet
- `DOMAIN_LEVEL`: Returns the domain level of a given host

10.11.2 How to Check User Network Connection and Domain Privileges

A database administrator can query the `DBA_HOST_ACES` data dictionary view to find the privileges that have been granted for specific users or roles.

The `DBA_HOST_ACES` view shows the access control lists that determine the access to the network connection or domain, and then determines if each access control list grants

(GRANTED), denies (DENIED), or does not apply (NULL) to the access privilege of the user. Only the database administrator can query this view.

10.11.3 Example: Administrator Checking User Network Access Control Permissions

The `DBA_HOST_ACES` data dictionary view can check the network access control permissions for users.

[Example 10-8](#) shows how a database administrator can check the privileges for user `preston` to connect to `www.us.example.com`.

In this example, user `preston` was granted privileges for all the network host connections found for `www.us.example.com`. However, suppose `preston` had been granted access to a host connection on port 80, but then denied access to the host connections on ports 3000–3999. In this case, you must configure access control for the host connection on port 80, and a separate access control configuration for the host connection on ports 3000–3999.

Example 10-8 Administrator Checking User Network Access Control Permissions

```
SELECT HOST, LOWER_PORT, UPPER_PORT,
       ACE_ORDER, PRINCIPAL, PRINCIPAL_TYPE,
       GRANT_TYPE, INVERTED_PRINCIPAL, PRIVILEGE,
       START_DATE, END_DATE
FROM (SELECT ACES.*,
            DBMS_NETWORK_ACL_UTILITY.CONTAINS_HOST('www.us.example.com', HOST) PRECEDENCE
      FROM DBA_HOST_ACES ACES)
WHERE PRECEDENCE IS NOT NULL
ORDER BY PRECEDENCE DESC,
         LOWER_PORT NULLS LAST,
         UPPER_PORT NULLS LAST,
         ACE_ORDER;
```

HOST	LOWER_PORT	UPPER_PORT	ACE_ORDER	PRINCIPAL	PRINCIPAL_TYPE	GRANT_TYPE
www.us.example.com	80	80	1	PRESTON	DATABASE USER	GRANT
NO	HTTP					
www.us.example.com	80	80	2	SEBASTIAN	DATABASE USER	GRANT
NO	HTTP					
*.us.example.com			1	ACCT_MGR	DATABASE USER	GRANT
NO	CONNECT					
*			1	HR_DBA	DATABASE USER	GRANT
NO	CONNECT					
*			1	HR_DBA	DATABASE USER	GRANT
NO	RESOLVE					

10.11.4 How Users Can Check Their Network Connection and Domain Privileges

Users can query the `USER_HOST_ACES` data dictionary view to check their network and domain permissions.

The `USER_HOST_ACES` view is `PUBLIC`, so all users can query it.

This view hides the access control lists from the user. It evaluates the permission status for the user (GRANTED or DENIED) and filters out the NULL case because the user does not need to know when the access control lists do not apply to them. In other words, Oracle Database only

shows the user on the network hosts that explicitly grant or deny access to them. Therefore, the output does not display the *.example.com and * that appear in the output from the database administrator-specific DBA_HOST_ACES view.

10.11.5 Example: User Checking Network Access Control Permissions

The USER_HOST_ACES data dictionary view shows network access control permissions for a host computer.

Example 10-9 shows how user preston can check their privileges to connect to www.us.example.com.

Example 10-9 User Checking Network Access Control Permissions

```
SELECT HOST, LOWER_PORT, UPPER_PORT, PRIVILEGE, STATUS
   FROM (SELECT ACES.*,
        DBMS_NETWORK_ACL_UTILITY.CONTAINS_HOST('www.us.example.com', HOST) PRECEDENCE
        FROM USER_HOST_ACES ACES)
 WHERE PRECEDENCE IS NOT NULL
 ORDER BY PRECEDENCE DESC,
          LOWER_PORT NULLS LAST,
          UPPER_PORT NULLS LAST;
```

HOST	LOWER_PORT	UPPER_PORT	PRIVILEGE	STATUS
www.us.example.com	80	80	HTTP	GRANTED

10.12 Configuring Network Access for Java Debug Wire Protocol Operations

Before you can debug Java PL/SQL procedures, you must be granted the jdwp ACL privilege.

If you want to debug Java PL/SQL procedures in the database through a Java Debug Wire Protocol (JDWP)-based debugger, such as SQL Developer, JDeveloper, or Oracle Developer Tools For Visual Studio (ODT), then you must be granted the jdwp ACL privilege to connect your database session to the debugger at a particular host.

The jdwp privilege is needed in conjunction with the DEBUG CONNECT SESSION system privilege.

If you have not been granted the jdwp ACL privilege, then when you try to debug your Java and PL/SQL stored procedures from a remote host, the following errors may appear:

```
ORA-24247: network access denied by access control list (ACL)
ORA-06512: at "SYS.DBMS_DEBUG_JDWP", line line_number
```

- To configure network access for JDWP operations, use the DBMS_NETWORK_ACL_ADMIN.APPEND_HOST_ACE procedure.

The following example illustrates how to configure network access for JDWP operations.

```
BEGIN
  DBMS_NETWORK_ACL_ADMIN.APPEND_HOST_ACE (
    host      => 'host',
    lower_port => null|port_number,
    upper_port => null|port_number,
    ace => xs$ace_type(privilege_list => xs$name_list('jdwp'),
                      principal_name => 'username',
                      principal_type => xs_acl.ptype_db));
```

```
END;
/
```

In this specification:

- *host* can be a host name, domain name, IP address, or subnet.
- *port_number* enables you to specify a range of ports. If you want to use any port, then omit the *lower_port* and *upper_port* values.
- *username* is case-insensitive unless it is quoted (for example, `principal_name => 'PSMITH'`).

See Also:

- *Oracle Database Java Developer's Guide* for more information about debugging server applications with JDWP
- *Oracle SQL Developer User's Guide* for information about remote debugging in SQL Developer

10.13 Data Dictionary Views for Access Control Lists Configured for User Access

Oracle Database provides data dictionary views that you can use to find information about existing access control lists.

[Table 10-1](#) lists these views.

Table 10-1 Data Dictionary Views That Display Information about Access Control Lists

View	Description
DBA_HOST_ACES	Shows the network privileges defined for the network hosts. The <code>SELECT</code> privilege on this view is granted to the <code>SELECT_CATALOG_ROLE</code> role only.
DBA_WALLET_ACES	Lists the wallet path, ACE order, start and end times, grant type, privilege, and information about principals
DBA_WALLET_ACLS	Shows the access control list assignments to the wallets. The <code>SELECT</code> privilege on this view is granted to the <code>SELECT_CATALOG_ROLE</code> role only.
DBA_HOST_ACLS	Shows the access control list assignments to the network hosts. The <code>SELECT</code> privilege on this view is granted to the <code>SELECT_CATALOG_ROLE</code> role only.
USER_HOST_ACES	Shows the status of the network privileges for the current user to access network hosts. The <code>SELECT</code> privilege on the view is granted to <code>PUBLIC</code> .
USER_WALLET_ACES	Shows the status of the wallet privileges for the current user to access contents in the wallets. The <code>SELECT</code> privilege on the view is granted to <code>PUBLIC</code> .

Related Topics

- *Oracle Database Reference*

11

Managing Security for a Multitenant Environment in Enterprise Manager

You can manage common and local users and roles by using Oracle Enterprise Manager.

- [About Managing Security for a Multitenant Environment in Enterprise Manager](#)
You can use Oracle Enterprise Manager Cloud Control to create, manage, and monitor common users and roles for both the root and the associated pluggable databases (PDBs).
- [Logging into a Multitenant Environment in Enterprise Manager](#)
You can log in to a CDB or a PDB, and switch from a PDB to a different PDB or to the root.
- [Managing Common and Local Users in Enterprise Manager](#)
Oracle Enterprise Manager enables you to create, edit, and drop common and local users.
- [Managing Common and Local Roles and Privileges in Enterprise Manager](#)
You can use Oracle Enterprise Manager to create, edit, drop, and revoke common and local roles.

11.1 About Managing Security for a Multitenant Environment in Enterprise Manager

You can use Oracle Enterprise Manager Cloud Control to create, manage, and monitor common users and roles for both the root and the associated pluggable databases (PDBs).

Enterprise Manager enables you to switch easily between the root and a designated PDB.

11.2 Logging into a Multitenant Environment in Enterprise Manager

You can log in to a CDB or a PDB, and switch from a PDB to a different PDB or to the root.

- [Logging into a CDB or a PDB](#)
Different variations of the Enterprise Manager Database login page appear automatically based on the feature that you requested while logging in.
- [Switching to a Different PDB or to the Root](#)
From Oracle Enterprise Manager, you can switch from one PDB to a different PDB, or to the root.

11.2.1 Logging into a CDB or a PDB

Different variations of the Enterprise Manager Database login page appear automatically based on the feature that you requested while logging in.

To log in as a CDB administrator (an Enterprise Manager user who has the `CONNECT` privilege on the CDB target) to use a CDB-scoped feature:

1. Log into Oracle Enterprise Manager Cloud Control as either user `SYSTEM` or `SYSMAN`.

The URL is as follows:

```
https://host:port/em
```

2. Navigate to the Databases page.
3. Select the database that you want to access.

The database home page appears.

4. Select the menu item for the action that you want to perform, such as selecting **Administration**, then **Security**, and then **Users** to authenticate a user.

The Database Login page appears. The following example shows the Database Login page for the CDB (because the database name is shown as CDB\$ROOT). Because of this name, this page is colloquially referred to as the database login page for the `root` of the multitenant environment. The **Database** field refers to the current database; had you selected a PDB, then the name of the PDB would appear in this field.

The screenshot shows the Oracle Enterprise Manager interface for Cloud Control 12c. The breadcrumb navigation indicates the current location is 'database / CDB\$ROOT'. Below the navigation, there are tabs for 'Oracle Database', 'Performance', 'Availability', 'Schema', and 'Administration'. The main section is titled 'Database Login' and contains the following fields and controls:

- * Database:** A text input field containing 'CDB\$ROOT' with a search icon to its right.
- * Username:** An empty text input field.
- * Password:** An empty text input field.
- Role:** A dropdown menu currently set to 'NORMAL'.
- Save As
- Buttons for 'Login' and 'Cancel'.

5. Log in using the appropriate credentials.

Remember that only common users can log into the root, and that the names of common users begin with `C##` or `c##`. Both common and local users can log into a PDB, depending on their privileges.

11.2.2 Switching to a Different PDB or to the Root

From Oracle Enterprise Manager, you can switch from one PDB to a different PDB, or to the root.

1. At the top left side of the page, find the **database** link.

In the **database** link, the current container name appears. The following example shows that the current database is the CDB itself (CDB\$ROOT), colloquially known as the root.

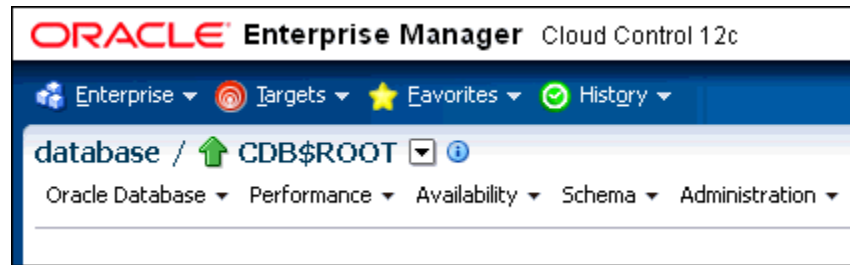

2. Select the menu icon to the right of the container, and from this menu, select the database that you want to access.
If the menu item does not appear, then navigate to a page where it does appear, such as the Database home page.
3. When you decide which activity you want to perform (such as creating users), log in with the appropriate privileges.
If you attempt to perform an activity without first having authenticated with the appropriate privileges, then you will be prompted to log in with the appropriate privilege.

11.3 Managing Common and Local Users in Enterprise Manager

Oracle Enterprise Manager enables you to create, edit, and drop common and local users.

- [Creating a Common User Account in Enterprise Manager](#)
A common user is a user that exists in the root and can access PDBs in the CDB.
- [Editing a Common User Account in Enterprise Manager](#)
You can edit a common user account from the root.
- [Dropping a Common User Account in Enterprise Manager](#)
You can drop a common user from the CDB root.
- [Creating a Local User Account in Enterprise Manager](#)
A local user is a user that exists only in a specific PDB and does not have access to any other PDBs.
- [Editing a Local User Account in Enterprise Manager](#)
You can edit a local user from the PDB in which the local user resides.
- [Dropping a Local User Account in Enterprise Manager](#)
You can drop a local user from the PDB in which the local user resides.

11.3.1 Creating a Common User Account in Enterprise Manager

A common user is a user that exists in the root and can access PDBs in the CDB.

1. From the Enterprise Manager database home page, log in to the root as a common user who has the common `CREATE USER` and `SET CONTAINER` privileges.
2. From the **Administration** menu, select **Security**, then **Users**.
If prompted, enter your login information. Afterward, the Users page appears.
3. Click **Create**.
The Create User page appears.

The screenshot shows the 'Create User' dialog in Oracle Enterprise Manager. The 'General' tab is selected, and the following fields are visible:

- Name:** A text input field with a note: 'Common user name must begin with "C.#".'
- Profile:** A dropdown menu set to 'DEFAULT'.
- Authentication:** A dropdown menu set to 'Password'.
- Enter Password:** A text input field.
- Confirm Password:** A text input field.
- Expire Password now:** An unchecked checkbox.
- Default Tablespace:** A text input field with a search icon.
- Temporary Tablespace:** A text input field with a search icon.
- Status:** Radio buttons for 'Locked' and 'Unlocked'.

A note at the bottom of the dialog reads: 'Note: Created user will be a common user since you are in CDB\$ROOT container.'

4. Select the options to create a common user and grant this user privileges.
Ensure that you preface the user name with C## or c##.
5. Click **OK** or **Apply**.
The common user is created in the root and will appear in the Users page for any associated PDBs.

Related Topics

- [Logging into a Multitenant Environment in Enterprise Manager](#)
You can log in to a CDB or a PDB, and switch from a PDB to a different PDB or to the root.

11.3.2 Editing a Common User Account in Enterprise Manager

You can edit a common user account from the root.

1. From the Enterprise Manager database home page, log in to the root as a common user who has the common `CREATE USER` and `SET CONTAINER` privileges.
 - If you are logging into the root, then ensure that you are a common user who has the common `CREATE USER` and `SET CONTAINER` privileges.
 - If you are logging into a PDB, ensure that you have the `CREATE USER` privilege for that PDB.
2. From the **Administration** menu, select **Security**, then **Users**.
If prompted, enter your login information. Afterward, the Users page appears. In the root, only common users are listed. In the PDB, both common and local users are listed.
3. Select the common user to be edited and then click **Edit**.

The Edit User page appears. For a common user in the root, you can modify all settings for the common user. For a common user in a PDB, you cannot change the user password, default tablespace, and temporary tablespace. The settings that you make apply only to the current PDB. The following screen shows how a common user Edit User page appears in a PDB.

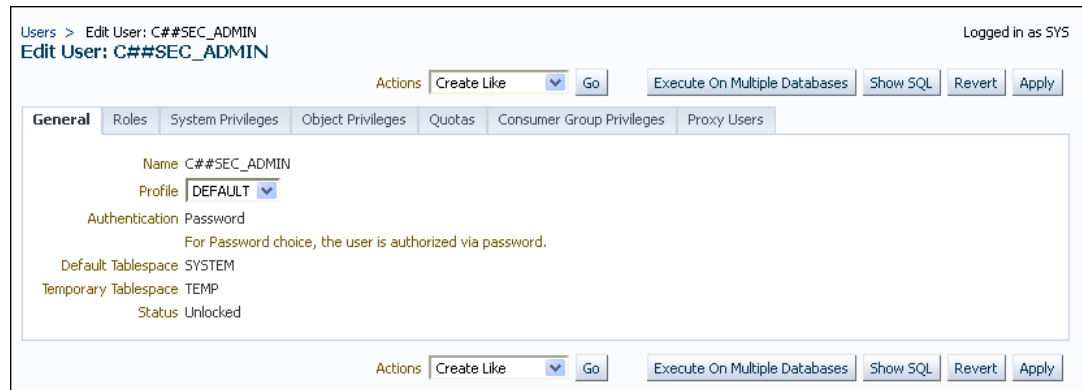

4. Modify the common user as necessary.
5. Click **Apply**.

Related Topics

- [Logging into a Multitenant Environment in Enterprise Manager](#)
You can log in to a CDB or a PDB, and switch from a PDB to a different PDB or to the root.
- [Methods of Altering Common or Local User Accounts](#)
You can use the `ALTER USER` statement or the `PASSWORD` command to alter both common and local user accounts.

11.3.3 Dropping a Common User Account in Enterprise Manager

You can drop a common user from the CDB root.

1. From the Enterprise Manager database home page, log in to the root as a common user who has the common `CREATE USER` and `SET CONTAINER` privileges.

You cannot drop common users from PDBs.

2. From the **Administration** menu, select **Security**, then **Users**.

If prompted, enter your login information. Afterward, the Users page appears, listing only common users.

3. Select the common user that you want to drop and then click **Delete**.
4. Confirm that you want to delete the common user.

Related Topics

- [Logging into a Multitenant Environment in Enterprise Manager](#)
You can log in to a CDB or a PDB, and switch from a PDB to a different PDB or to the root.

11.3.4 Creating a Local User Account in Enterprise Manager

A local user is a user that exists only in a specific PDB and does not have access to any other PDBs.

1. From the Enterprise Manager database home page, log in to the root as a local or common user who has the local `CREATE USER` privilege.

2. From the **Administration** menu, select **Security**, then **Users**.

If prompted, enter your login information. Afterward, the Users page appears, showing only local users for the current PDB.

3. Click **Create**.
The Create User page appears.
4. Select the options that create a local user and grant this user privileges.
Ensure that you do not preface the user name with `C##` or `c##`.
5. Click **OK**.
The local user is created in the current PDB.

Related Topics

- [Logging into a Multitenant Environment in Enterprise Manager](#)
You can log in to a CDB or a PDB, and switch from a PDB to a different PDB or to the root.
- [About Creating Local User Accounts](#)
Be aware of local user account restrictions such as where they can be created, naming conventions, and objects stored in their schemas.

11.3.5 Editing a Local User Account in Enterprise Manager

You can edit a local user from the PDB in which the local user resides.

1. From the Enterprise Manager database home page, log in to the PDB as a local or common user who has the local `CREATE USER` privilege.
2. From the **Administration** menu, select **Security**, then **Users**.
If prompted, enter your login information. Afterward, the Users page appears, showing only local users for the current PDB and common users.
3. Select the local user to be edited and then click **Edit**.
The Edit User page appears.
4. Modify the local user as necessary.
5. Click **Apply**.

Related Topics

- [Logging into a Multitenant Environment in Enterprise Manager](#)
You can log in to a CDB or a PDB, and switch from a PDB to a different PDB or to the root.
- [Methods of Altering Common or Local User Accounts](#)
You can use the `ALTER USER` statement or the `PASSWORD` command to alter both common and local user accounts.

11.3.6 Dropping a Local User Account in Enterprise Manager

You can drop a local user from the PDB in which the local user resides.

1. From the Enterprise Manager database home page, log in to the PDB as a local or common user who has the local `CREATE USER` privilege.
2. From the **Administration** menu, select **Security**, then **Users**.
If prompted, enter your login information. Afterward, the Users page appears, showing only local users for the current PDB and common users. (You cannot drop common users from a PDB.)
3. Select the local user you want to drop and then click **Delete**.
Enterprise Manager prompts you to confirm deletion of the user.

4. Confirm that you want to delete the local user.

Related Topics

- [Logging into a Multitenant Environment in Enterprise Manager](#)
You can log in to a CDB or a PDB, and switch from a PDB to a different PDB or to the root.

11.4 Managing Common and Local Roles and Privileges in Enterprise Manager

You can use Oracle Enterprise Manager to create, edit, drop, and revoke common and local roles.

- [Creating a Common Role in Enterprise Manager](#)
Common roles can be used to assign common privileges to common users.
- [Editing a Common Role in Enterprise Manager](#)
You can edit a common role from the root.
- [Dropping a Common Role in Enterprise Manager](#)
You can drop a common role from the root.
- [Revoking Common Privilege Grants in Enterprise Manager](#)
You can revoke common privilege grants from the root.
- [Creating a Local Role in Enterprise Manager](#)
A common role can be used to assign a local set of privileges to local users later.
- [Editing a Local Role in Enterprise Manager](#)
You can edit a local role in the PDB in which the local role resides.
- [Dropping a Local Role in Enterprise Manager](#)
You can drop local role from the PDB in which the local role resides.
- [Revoking Local Privilege Grants in Enterprise Manager](#)
You can revoke local privileges in the PDB in which the privileges are used.

11.4.1 Creating a Common Role in Enterprise Manager

Common roles can be used to assign common privileges to common users.

These roles are valid across all containers.

1. From the Enterprise Manager database home page, log in to the root as a common user who has the common `CREATE ROLE` and `SET CONTAINER` privileges.
2. From the **Administration** menu, select **Security**, then **Roles**.
If prompted, enter your login information. Afterward, the Create Role page appears.
3. Click **Create**.
The Create Role page appears.

4. Select the options that create a common role and grant this role privileges.

Ensure that you preface the role name with `C##` or `c##`.

5. Click **OK**.

The common role is created in the root.

Related Topics

- [Logging into a Multitenant Environment in Enterprise Manager](#)
You can log in to a CDB or a PDB, and switch from a PDB to a different PDB or to the root.
- [Rules for Creating Common Roles](#)
When you create a common role, you must follow special rules.
- [Granting or Revoking Privileges to Access a PDB](#)
You can grant and revoke privileges for PDB access.

11.4.2 Editing a Common Role in Enterprise Manager

You can edit a common role from the root.

1. From the Enterprise Manager database home page, log in to the root or the PDB. If you are logging into the root, then ensure that you are a common user who has the common `CREATE ROLE` and `SET CONTAINER` privileges. If you are logging into a PDB, ensure that you have the `CREATE ROLE` privilege for that PDB.

2. From the **Administration** menu, select **Security**, then **Roles**.

If prompted, enter your login information. Afterward, the Roles page appears. In the root, only common roles are shown. In the PDB, both common and local roles are shown.

3. Select the common role to be edited and then click **Edit**.

The Edit Role page appears. For a common user in the root, you can modify all settings for the common user.

For a common role in a PDB, you can only change the role's authentication and grant this user different roles, system privileges, object privileges, and consumer group privileges. These settings apply only to the current PDB.

4. Modify the common user as necessary.
5. Click **Apply**.

Related Topics

- [Logging into a Multitenant Environment in Enterprise Manager](#)
You can log in to a CDB or a PDB, and switch from a PDB to a different PDB or to the root.

11.4.3 Dropping a Common Role in Enterprise Manager

You can drop a common role from the root.

1. From the Enterprise Manager database home page, log in to the root as a common user who has the common `CREATE ROLE` and `SET CONTAINER` privileges.

You cannot drop common roles from PDBs.

2. From the **Administration** menu, select **Security**, then **Roles**.

If prompted, enter your login information. Afterward, the Roles page appears, showing only common roles.

3. Select the common role that you want to drop and then click **Delete**.
4. Confirm that you want to delete the common role.

Related Topics

- [Logging into a Multitenant Environment in Enterprise Manager](#)
You can log in to a CDB or a PDB, and switch from a PDB to a different PDB or to the root.

11.4.4 Revoking Common Privilege Grants in Enterprise Manager

You can revoke common privilege grants from the root.

1. From the Enterprise Manager database home page, log in to the root as a common user who has the common `CREATE USER`, `CREATE ROLE`, and `SET CONTAINER` privileges.

2. From the **Administration** menu, select **Security**, then **Users**.

The Users page lists the common users.

3. Select the user whose privileges you want to revoke and then click **Edit**.

The Edit User page appears.

4. Select **Roles** or the appropriate **Privileges** tab.

Enterprise Manager displays a list of roles and privileges assigned to this user.

5. Select **Edit List** and then remove the roles or privileges as necessary.

6. Click the **OK** button.

Related Topics

- [Logging into a Multitenant Environment in Enterprise Manager](#)
You can log in to a CDB or a PDB, and switch from a PDB to a different PDB or to the root.
- [Granting or Revoking Privileges to Access a PDB](#)
You can grant and revoke privileges for PDB access.

11.4.5 Creating a Local Role in Enterprise Manager

A common role can be used to assign a local set of privileges to local users later.

These roles will be valid across PDB containers for whom they are defined.

1. From the Enterprise Manager database home page, log in to the PDB as a user who has the local `CREATE ROLE` privilege.
2. From the **Administration** menu, select **Security**, then **Roles**.

The Roles page appears.

3. Click **Create.**

If prompted, enter your login information. Afterward, the Create Role page appears.

4. Select the options that create a local role and grant this role privileges.

Ensure that you do not preface the role name with `C##` or `c##`.

5. Click **OK.**

The local role is created in the current PDB.

Related Topics

- [Logging into a Multitenant Environment in Enterprise Manager](#)
You can log in to a CDB or a PDB, and switch from a PDB to a different PDB or to the root.
- [Granting or Revoking Privileges to Access a PDB](#)
You can grant and revoke privileges for PDB access.

11.4.6 Editing a Local Role in Enterprise Manager

You can edit a local role in the PDB in which the local role resides.

1. From the Enterprise Manager database home page, log in to the PDB as a user who has the local `CREATE ROLE` privilege.

2. From the **Administration menu, select **Security**, then **Roles**.**

If prompted, enter your login information. Afterward, the Roles page appears, showing only local roles for the current PDB and common roles.

3. Select the local role to be edited and then click **Edit.**

The Edit User page appears.

4. Modify the local user as necessary.

5. Click **Apply.**

Related Topics

- [Logging into a Multitenant Environment in Enterprise Manager](#)
You can log in to a CDB or a PDB, and switch from a PDB to a different PDB or to the root.

11.4.7 Dropping a Local Role in Enterprise Manager

You can drop local role from the PDB in which the local role resides.

1. From the Enterprise Manager database home page, log in to the PDB as a user who has the local `CREATE ROLE` privilege.

2. From the **Administration menu, select **Security**, then **Role**.**

If prompted, enter your login information. Afterward, the Roles page appears, showing only local roles for the current PDB and common roles. (You cannot drop common roles from a PDB.)

3. Select the local role you want to drop and then click **Delete.**

Enterprise Manager prompts you to confirm deletion of the role.

4. Confirm that you want to delete the local role.

Related Topics

- [Logging into a Multitenant Environment in Enterprise Manager](#)
You can log in to a CDB or a PDB, and switch from a PDB to a different PDB or to the root.

11.4.8 Revoking Local Privilege Grants in Enterprise Manager

You can revoke local privileges in the PDB in which the privileges are used.

1. From the Enterprise Manager database home page, log in to the PDB as a common or local user who has the `CREATE USER` and `CREATE ROLE` privileges.
2. From the **Administration** menu, select **Security**, then **Users**.
If prompted, enter your login information. Afterward, the Users page appears. In a PDB, both common and local users are listed.
3. Select the user whose privileges you want to revoke and then click **Edit**.
The Edit User page appears.
4. Select **Roles** or the appropriate **Privileges** tab.
Enterprise Manager displays a list of roles and privileges assigned to this user.
5. Select **Edit List** and then remove the privileges as necessary.
6. Click the **OK** button.

Related Topics

- [Logging into a Multitenant Environment in Enterprise Manager](#)
You can log in to a CDB or a PDB, and switch from a PDB to a different PDB or to the root.
- [Granting or Revoking Privileges to Access a PDB](#)
You can grant and revoke privileges for PDB access.

Part II

Application Development Security

Part II describes how to manage application development security.

- [Managing Security for Application Developers](#)
A security policy for application developers should encompass areas such as password management and securing external procedures and application privileges.

12

Managing Security for Application Developers

A security policy for application developers should encompass areas such as password management and securing external procedures and application privileges.

- [About Application Security Policies](#)
An application security policy is a list of application security requirements and rules that regulate user access to database objects.
- [Considerations for Using Application-Based Security](#)
An application security implementation should consider both application and database users and whether to enforce security in the application or in the database.
- [Use of the DB_DEVELOPER_ROLE Role for Application Developers](#)
The `DB_DEVELOPER_ROLE` role provides most of the system privileges, object privileges, predefined roles, PL/SQL package privileges, and tracing privileges that an application developer needs.
- [Securing Passwords in Application Design](#)
Oracle provides strategies for securely invoking password services, such as from scripts, and for applying these strategies to other sensitive data.
- [Securing External Procedures](#)
An external procedure is stored in a `.dll` or an `.so` file, separately from the database, and can be through a credential authentication.
- [Securing LOBs with LOB Locator Signatures](#)
You can secure large objects (LOB) by regenerating their LOB locator signatures.
- [Managing Application Privileges](#)
Most database applications involve different privileges on different schema objects.
- [Advantages of Using Roles to Manage Application Privileges](#)
Grouping application privileges in a role aids privilege management.
- [Creating Secure Application Roles to Control Access to Applications](#)
A secure application role is only enabled through its associated PL/SQL package or procedure.
- [Association of Privileges with User Database Roles](#)
Ensure that users have only the privileges associated with the current database role.
- [Protecting Database Objects by Using Schemas](#)
A schema is a security domain that can contain database objects. Privileges granted to users and roles control access to these database objects.
- [Object Privileges in an Application](#)
When you design an application, consider the types of users and the level access they need.
- [Parameters for Enhanced Security of Database Communication](#)
Parameters can be used to manage security, such as handling bad packets from protocol errors or configuring the maximum number of authentication errors.

12.1 About Application Security Policies

An application security policy is a list of application security requirements and rules that regulate user access to database objects.

Creating an application security policy is the first step to create a secure database application. You should draft security policies for each database application. For example, each database application should have one or more database roles that provide different levels of security when executing the application. You then can grant the database roles to other roles or directly to specific users.

Applications that can potentially allow unrestricted SQL statement processing (through tools such as SQL*Plus or SQL Developer) also need security policies that prevent malicious access to confidential or important schema objects. In particular, you must ensure that your applications handle passwords in a secure manner.

12.2 Considerations for Using Application-Based Security

An application security implementation should consider both application and database users and whether to enforce security in the application or in the database.

- **Are Application Users Also Database Users?**
Where possible, build applications in which application users are database users, so that you can use the intrinsic security mechanisms of the database.
- **Is Security Better Enforced in the Application or in the Database?**
Oracle recommends that applications use the security enforcement mechanisms of the database as much as possible.

12.2.1 Are Application Users Also Database Users?

Where possible, build applications in which application users are database users, so that you can use the intrinsic security mechanisms of the database.

For many commercial packaged applications, application users are not database users. For these applications, multiple users authenticate themselves to the application, and the application then connects to the database as a single, highly-privileged user. This is called the *One Big Application User* model.

Applications built in this way generally cannot use many of the intrinsic security features of the database, because the identity of the user is not known to the database. However, you can use client identifiers to perform some types of tracking. For example, the `OCI_ATTR_CLIENT_IDENTIFIER` attribute of the Oracle Call Interface method `OCIAttrSet` can be used to enable auditing and monitoring of client connections. Client identifiers can be used to gather audit trail data on individual Web users, apply rules that restrict data access by Web users, and monitor and trace applications that each Web user users.

[Table 12-1](#) describes how the One Big Application User model affects various Oracle Database security features:

Table 12-1 Features Affected by the One Big Application User Model

Oracle Database Feature	Limitations of One Big Application User Model
Auditing	A basic principle of security is accountability through auditing. If One Big Application User performs all actions in the database, then database auditing cannot hold individual users accountable for their actions. The application must implement its own auditing mechanisms to capture individual user actions.
Oracle strong authentication	Strong forms of authentication (such as client authentication over SSL, tokens, and so on) cannot be used if the client authenticating to the database is the application, rather than an individual user.
Roles	Roles are assigned to database users. Enterprise roles are assigned to enterprise users who, though not created in the database, are known to the database. If application users are not database users, then the usefulness of roles is diminished. Applications must then craft their own mechanisms to distinguish between the privileges which various application users need to access data within the application.
Enterprise user management	The Enterprise user management feature enables an Oracle database to use the Oracle Identity Management Infrastructure by securely storing and managing user information and authorizations in an LDAP-based directory such as Oracle Internet Directory. While enterprise users do not need to be created in the database, they do need to be known to the database. The One Big Application User model cannot take advantage of Oracle Identity Management.

12.2.2 Is Security Better Enforced in the Application or in the Database?

Oracle recommends that applications use the security enforcement mechanisms of the database as much as possible.

Applications, whose users are also database users, can either build security into the application, or rely on intrinsic database security mechanisms such as granular privileges, virtual private databases (fine-grained access control with application context), roles, stored procedures, and auditing (including fine-grained auditing).

When security is enforced in the database itself, rather than in the application, it cannot be bypassed. The main shortcoming of application-based security is that security is bypassed if the user bypasses the application to access data. For example, a user who has SQL*Plus access to the database can run queries without going through the Human Resources application. The user, therefore, bypasses all of the security measures in the application.

Applications that use the One Big Application User model must build security enforcement into the application rather than use database security mechanisms. Because it is the application, and not the database, that recognizes users; the application itself must enforce security measures for each user.

This approach means that each application that accesses data must re-implement security. Security becomes expensive, because organizations must implement the same security policies in multiple applications, and each new application requires an expensive reimplementation.

Related Topics

- [Potential Security Problems of Using Ad Hoc Tools](#)
Ad hoc tools can pose problems if malicious users have access to such tools.

12.3 Use of the DB_DEVELOPER_ROLE Role for Application Developers

The `DB_DEVELOPER_ROLE` role provides most of the system privileges, object privileges, predefined roles, PL/SQL package privileges, and tracing privileges that an application developer needs.

An application developer needs a large number of these privileges to design, develop, and deploy applications. Oracle recommends that you grant the application developer the `DB_DEVELOPER_ROLE` role, rather than individually granting these privileges or granting the user the `DBA` role. Granting the application user the `DB_DEVELOPER_ROLE` role not only adheres to least-privilege principles and ensures greater security for the development environment, it facilitates the management of role grants and revokes for application developers. The `DB_DEVELOPER_ROLE` role can be used in either the CDB root or the PDB. Do not modify the `DB_DEVELOPER_ROLE`.

Generating a List of Privileges and Roles Granted by the DB_DEVELOPER_ROLE Role

To generate a full list of the system privileges, object privileges, and roles that are granted by the `DB_DEVELOPER_ROLE`, run the following statement. Ensure that you include the `set serveroutput on format wrapped` command, so that the indentation will be shown properly.

 **Note:**

Be aware that the output will vary, depending on the version or patch release of Oracle Database that you are using.

```
set serveroutput on format wrapped;
DECLARE
  procedure printRolePrivileges(
    p_role          in varchar2,
    p_spaces_to_indent in number) IS
    v_child_roles  DBMS_SQL.VARCHAR2_TABLE;
    v_system_privs DBMS_SQL.VARCHAR2_TABLE;
    v_table_privs  DBMS_SQL.VARCHAR2_TABLE;
    v_indent_spaces varchar2(2048);
  BEGIN
    -- Indentation for nested privileges via granted roles.
    for space in 1..p_spaces_to_indent LOOP
      v_indent_spaces := v_indent_spaces || ' ';
    end LOOP;
    -- Get the system privileges granted to p_role
    select PRIVILEGE bulk collect into v_system_privs
    from DBA_SYS_PRIVS
    where GRANTEE = p_role
    order by PRIVILEGE;
```

```

-- Print the system privileges granted to p_role
for privind in 1..v_system_privs.COUNT LOOP
    DBMS_OUTPUT.PUT_LINE(
        v_indent_spaces || 'System priv: ' || v_system_privs(privind));
END LOOP;

-- Get the object privileges granted to p_role
select PRIVILEGE || ' ' || OWNER || '.' || TABLE_NAME
    bulk collect into v_table_privs
from DBA_TAB_PRIVS
where GRANTEE = p_role
order by TABLE_NAME asc;

-- Print the object privileges granted to p_role
for tabprivind in 1..v_table_privs.COUNT LOOP
    DBMS_OUTPUT.PUT_LINE(
        v_indent_spaces || 'Object priv: ' || v_table_privs(tabprivind));
END LOOP;

-- get all roles granted to p_role
select GRANTED_ROLE bulk collect into v_child_roles
from DBA_ROLE_PRIVS
where GRANTEE = p_role
order by GRANTED_ROLE asc;

-- Print all roles granted to p_role and handle child roles recursively.
for roleind in 1..v_child_roles.COUNT LOOP
    -- Print child role
    DBMS_OUTPUT.PUT_LINE(
        v_indent_spaces || 'Role priv: ' || v_child_roles(roleind));

    -- Print privileges for the child role recursively. Pass 2 additional
    -- spaces to illustrate these privileges belong to a child role.
    printRolePrivileges(v_child_roles(roleind), p_spaces_to_indent + 2);
END LOOP;

EXCEPTION
    when OTHERS then
        DBMS_OUTPUT.PUT_LINE('Got exception: ' || SQLERRM );

END printRolePrivileges;

BEGIN
    printRolePrivileges('DB_DEVELOPER_ROLE', 0);
END;
/

```

Output similar to the following appears:

```

System priv: CREATE ANALYTIC VIEW
System priv: CREATE ATTRIBUTE DIMENSION
System priv: CREATE CUBE
System priv: CREATE CUBE BUILD PROCESS
System priv: CREATE CUBE DIMENSION
System priv: CREATE DIMENSION

```

```

System priv: CREATE DOMAIN
System priv: CREATE HIERARCHY
System priv: CREATE JOB
System priv: CREATE MATERIALIZED VIEW
System priv: CREATE MINING MODEL
System priv: CREATE MLE
System priv: CREATE PROCEDURE
System priv: CREATE SEQUENCE
System priv: CREATE SESSION
System priv: CREATE SYNONYM
System priv: CREATE TABLE
System priv: CREATE TRIGGER
System priv: CREATE TYPE
System priv: CREATE VIEW
System priv: DEBUG CONNECT SESSION
System priv: EXECUTE DYNAMIC MLE
System priv: FORCE TRANSACTION
System priv: ON COMMIT REFRESH
Object priv: SELECT SYS.DBA_PENDING_TRANSACTIONS
Object priv: EXECUTE SYS.JAVASCRIPT
Object priv: READ SYS.V_$PARAMETER
Object priv: READ SYS.V_$STATNAME
Role priv: CTXAPP
  System priv: CREATE SEQUENCE
  Object priv: EXECUTE CTXSYS.CTX_ANL
  Object priv: EXECUTE CTXSYS.CTX_DDL
  Object priv: EXECUTE CTXSYS.CTX_ENTITY
  Object priv: EXECUTE CTXSYS.CTX_OUTPUT
  Object priv: EXECUTE CTXSYS.CTX_THES
  Object priv: EXECUTE CTXSYS.CTX_ULEXER
  Object priv: INSERT CTXSYS.DR$DICTIONARY
  Object priv: DELETE CTXSYS.DR$DICTIONARY
  Object priv: SELECT CTXSYS.DR$DICTIONARY
  Object priv: UPDATE CTXSYS.DR$DICTIONARY
  Object priv: INSERT CTXSYS.DR$THS
  Object priv: INSERT CTXSYS.DR$THS_BT
  Object priv: INSERT CTXSYS.DR$THS_FPHRASE
  Object priv: UPDATE CTXSYS.DR$THS_PHRASE
  Object priv: INSERT CTXSYS.DR$THS_PHRASE
  Object priv: EXECUTE CTXSYS.DRIENTL
  Object priv: EXECUTE CTXSYS.DRITHSL
Role priv: SODA_APP
  Object priv: EXECUTE XDB.DBMS_SODA_ADMIN
  Object priv: EXECUTE XDB.DBMS_SODA_USER_ADMIN
  Object priv: READ XDB.JSON$USER_COLLECTION_METADATA

```

Performing Grants and Revokes of the DB_DEVELOPER_ROLE Role

To grant the DB_DEVELOPER_ROLE to another user or role, use the GRANT statement, as you would with any role grant. For example:

```
GRANT DB_DEVELOPER_ROLE TO pfitch;
```

To check the grant:

```
SELECT GRANTED_ROLE FROM DBA_ROLE_PRIVS WHERE GRANTEE='pfitch';
```

Revoking the DB_DEVELOPER_ROLE is similar:

```
REVOKE DB_DEVELOPER_ROLE FROM pfitch;
```

12.4 Securing Passwords in Application Design

Oracle provides strategies for securely invoking password services, such as from scripts, and for applying these strategies to other sensitive data.

- [General Guidelines for Securing Passwords in Applications](#)
Guidelines for securing passwords in applications cover areas such as platform-specific security threats.
- [Use of an External Password Store to Secure Passwords](#)
You can store password credentials for connecting to a database by using a client-side Oracle wallet.
- [Securing Passwords Using the ORAPWD Utility](#)
SYSDBA or SYSOPER users can use password files to connect to an application over a network.
- [Example: Java Code for Reading Passwords](#)
You can create Java packages that can be used to read passwords.

12.4.1 General Guidelines for Securing Passwords in Applications

Guidelines for securing passwords in applications cover areas such as platform-specific security threats.

- [Platform-Specific Security Threats](#)
You should be aware of potential security threats, which may not be obvious.
- [Guidelines for Designing Applications to Handle Password Input](#)
Oracle provides guidelines for designing applications to handle password input.
- [Guidelines for Configuring Password Formats and Behavior](#)
Oracle Database provides guidelines for configuring password formats and behavior.
- [Guidelines for Handling Passwords in SQL Scripts](#)
Oracle provides guidelines for handling passwords in SQL scripts.

12.4.1.1 Platform-Specific Security Threats

You should be aware of potential security threats, which may not be obvious.

These security threats are as follows:

- **On UNIX and Linux platforms, command parameters are available for viewing by all operating system users on the same host computer.** As a result, passwords entered on the command line could be exposed to other users. However, do not assume that non-UNIX and Linux platforms are safe from this threat.

- **On some UNIX platforms, such as HP Tru64 and IBM AIX, environment variables for all processes are available for viewing by all operating system users.** However, do not assume that non-UNIX and Linux platforms are safe from this threat.
- **On Microsoft Windows, the command recall feature (the Up arrow) remembers user input across command invocations.** For example, if you use the `CONNECT SYSTEM/password` notation in SQL*Plus, exit, and then press the Up arrow to repeat the `CONNECT` command, the command recall feature reveals the connect string and displays the password. In addition, do not assume that non-Microsoft Windows platforms are safe from this threat.

12.4.1.2 Guidelines for Designing Applications to Handle Password Input

Oracle provides guidelines for designing applications to handle password input.

- **Design applications to interactively prompt for passwords.** For command-line utilities, do not force users to expose passwords at a command prompt.

Check the APIs for the programming language you use to design applications (such as Java) for the best way to handle passwords from users.

- **Protect your database against code injection attacks.** Code injection attacks most commonly occur in the client application tool that sends SQL to the database (for example, SQL*Plus, or any Oracle Call Interface (OCI) or JDBC application. This includes database drivers that are built using these tools. A SQL injection attack causes SQL statements to behave in a manner that is not intended by the PL/SQL application. The injection attack takes place before the statement is sent to the database. For example, an intruder can bypass password authentication by setting a `WHERE` clause to `TRUE`.

To address the problem of SQL injection attacks, use bind variable arguments or create validation checks. If you cannot use bind variables, then consider using the `DBMS_ASSERT` PL/SQL package to validate the properties of input values. You also should review any grants to roles such as `PUBLIC`.

Note that client applications users may not always associate SQL injection with PL/SQL, because the injection could occur before the statement is sent to the database.

- **If possible, design your applications to defer authentication.** For example:
 - Use certificates for logins.
 - Authenticate users by using facilities provided by the operating system. For example, applications on Microsoft Windows can use domain authentication.
- **Mask or encrypt passwords.** If you must store passwords, then mask or encrypt them. For example, you can mask passwords in log files and encrypt passwords in recovery files.
- **Authenticate each connection.** For example, if schema A exists in database 1, then do not assume that schema A in database 2 is the same user. Similarly, the local operating system user `psmith` is not necessarily the same person as remote user `psmith`.
- **Do not store clear text passwords in files or repositories.** Storing passwords in files increases the risk of an intruder accessing them.
- **Use a single main password.** For example:
 - You can grant a single database user proxy authentication to act as other database users. In this case, only a single database password is needed.
 - Using the Oracle Database Enterprise User Security Wallet Manager, you can create a password wallet, which can be opened by the main password. The wallet then contains the other passwords.

 **Note:**

Enterprise User Security (EUS) is deprecated with Oracle Database 23ai. Oracle recommends that you migrate to using Centrally Managed Users (CMU). This feature enables you to directly connect with Microsoft Active Directory without an intervening directory service for enterprise user authentication and authorization to the database. If your Oracle Database is in the cloud, you can also choose to move to one of the newer integrations with a cloud identity provider.

Related Topics

- [Example: Java Code for Reading Passwords](#)
You can create Java packages that can be used to read passwords.
- [Oracle Database PL/SQL Language Reference](#)
- [Proxy User Accounts and the Authorization of Users to Connect Through Them](#)
The `CREATE USER` statement enables you to create the several types of user accounts, all of which can be used as proxy accounts.
- [Oracle Database Enterprise User Security Administrator's Guide](#)

12.4.1.3 Guidelines for Configuring Password Formats and Behavior

Oracle Database provides guidelines for configuring password formats and behavior.

- **Limit the lifetime for passwords.** Use the `PASSWORD_LIFE_TIME`, `PASSWORD_GRACE_TIME`, and `PASSWORD_ROLLOVER_TIME` profile parameters to control lifetime of passwords.
- **Limit the ability of users to reuse old passwords.** Forcing users to create new, unique passwords can greatly deter intruders from guessing their passwords. You can control these factors by setting the `PASSWORD_REUSE_TIME`, `PASSWORD_REUSE_MAX`, and `PASSWORD_VERIFY_FUNCTION` parameters.
- **Force users to create strong, secure passwords.** You can customize password requirements for your site by using password complexity verification, which forces users to follow Oracle's guidelines for creating strong passwords.
- **Enable case sensitivity in passwords.** By default, new passwords are case sensitive.

Related Topics

- [About Controlling Password Aging and Expiration](#)
You can specify a password lifetime, after which the password expires.
- [Controlling the User Ability to Reuse Previous Passwords](#)
You can ensure that users do not reuse previous passwords for an amount of time or for a number of password changes.
- [Guidelines for Securing Passwords](#)
Oracle provides guidelines for securing passwords in a variety of situations.
- [About Password Complexity Verification](#)
Complexity verification checks that each password is complex enough to protect against intruders who try to guess user passwords.
- [Managing Password Case Sensitivity](#)
You can manage the password case sensitivity for passwords from user accounts from previous releases.

12.4.1.4 Guidelines for Handling Passwords in SQL Scripts

Oracle provides guidelines for handling passwords in SQL scripts.

- **Do not invoke SQL*Plus with a password on the command line, either in programs or scripts.** If a password is required but omitted, SQL*Plus prompts the user for it and then automatically disables the echo feature so that the password is not displayed.

The following examples are secure because passwords are not exposed on the command line. Oracle Database also automatically encrypts these passwords over the network.

```
$ sqlplus system
Enter password: password
```

```
SQL> CONNECT SYSTEM
Enter password: password
```

The following example exposes the password to other operating system users:

```
sqlplus system/password
```

The next example poses two security risks. First, it exposes the password to other users who may be watching over your shoulder. Second, on some platforms, such as Microsoft Windows, it makes the password vulnerable to a command line recall attack.

```
$ sqlplus /nolog
SQL> CONNECT SYSTEM/password
```

- **For SQL scripts that require passwords or secret keys, for example, to create an account or to log in as an account, do not use positional parameters, such as substitution variables &1, &2, and so on.** Instead, design the script to prompt the user for the value. You should also disable the echo feature, which displays output from a script or if you are using spool mode. To disable the echo feature, use the following setting:

```
SET ECHO OFF
```

A good practice is to ensure that the script makes the purpose of the value clear. For example, it should be clear whether or not the value will establish a new value, such as an account or a certificate, or if the value will authenticate, such as logging in to an existing account.

The following example is secure because it prevents users from invoking the script in a manner that poses security risks: It does not echo the password; it does not record the password in a spool file.

```
SET VERIFY OFF
ACCEPT user CHAR PROMPT 'Enter user to connect to: '
ACCEPT password CHAR PROMPT 'Enter the password for that user: ' HIDE
CONNECT &user/&password
```

In this example:

- `SET VERIFY OFF` prevents the password from being displayed. (`SET VERIFY` lists each line of the script before and after substitution.) Combining the `SET VERIFY OFF` command with the `HIDE` command is a useful technique for hiding passwords and other sensitive input data.
- `ACCEPT password CHAR PROMPT` includes the `HIDE` option for the `ACCEPT password` prompt, which prevents the input password from being echoed.

The next example, which uses positional parameters, poses security risks because a user may invoke the script by passing the password on the command line. If the user does not

enter a password and instead is prompted, the danger lies in that whatever the user types is echoed to the screen and to a spool file if spooling is enabled.

```
CONNECT &1/&2
```

- **Control the log in times for batch scripts.** For batch scripts that require passwords, configure the account so that the script can only log in during the time in which it is supposed to run. For example, suppose you have a batch script that runs for an hour each evening starting at 8 p.m. Set the account so that the script can only log in during this time. If an intruder manages to gain access, then they have less of a chance of exploiting any compromised accounts.
- **Be careful when using DML or DDL SQL statements that prompt for passwords.** In this case, sensitive information is passed in clear text over the network. You can remedy this problem by using Oracle strong authentication.

The following example of altering a password is secure because the password is not exposed:

```
password psmith  
Changing password for psmith  
New password: password  
Retype new password: password
```

This example poses a security risk because the password is exposed both at the command line and on the network:

```
ALTER USER psmith IDENTIFIED BY password
```

12.4.2 Use of an External Password Store to Secure Passwords

You can store password credentials for connecting to a database by using a client-side Oracle wallet.

An Oracle wallet is a secure software container that stores the authentication and signing credentials needed for a user to log in.

Related Topics

- [Managing the Secure External Password Store for Password Credentials](#)
The secure external password store (SEPS) is a client-side wallet that is used to store password credentials.
- *Oracle Database Enterprise User Security Administrator's Guide*

12.4.3 Securing Passwords Using the ORAPWD Utility

SYSDBA or SYSOPER users can use password files to connect to an application over a network.

- To create the password file, use the ORAPWD utility.

Related Topics

- *Oracle Database Administrator's Guide*

12.4.4 Example: Java Code for Reading Passwords

You can create Java packages that can be used to read passwords.

[Example 12-1](#) demonstrates how to create a Java package that can be used to read passwords.

Example 12-1 Java Code for Reading Passwords

```
// Change the following line to a name for your version of this package
package passwords.sysman.emSDK.util.signing;

import java.io.IOException;
import java.io.PrintStream;
import java.io.PushbackInputStream;
import java.util.Arrays;

/**
 * The static readPassword method in this class issues a password prompt
 * on the console output and returns the char array password
 * entered by the user on the console input.
 */
public final class ReadPassword {
    //-----
    /**
     * Test driver for readPassword method.
     * @param args the command line args
     */
    public static void main(String[] args) {
        char[] pass = ReadPassword.readPassword("Enter password: ");
        System.out.println("The password just entered is \""
            + new String(pass) + "\"");
        System.out.println("The password length is " + pass.length);
    }
    * Issues a password prompt on the console output and returns
    * the char array password entered by the user on the console input.
    * The password is not displayed on the console (chars are not echoed).
    * As soon as the returned char array is not needed,
    * it should be erased for security reasons (Arrays.fill(charArr, ' '));
    * A password should never be stored as a java String.
    *
    * Note that Java 6 has a Console class with a readPassword method,
    * but there is no equivalent in Java 5 or Java 1.4.
    * The readPassword method here is based on Sun's suggestions at
    * http://java.sun.com/developer/technicalArticles/Security/pwordmask.
    *
    * @param prompt the password prompt to issue
    * @return new char array containing the password
    * @throws RuntimeException if some error occurs
    */
    public static final char[] readPassword(String prompt)
        throws RuntimeException {
        try {
            StreamMasker masker = new StreamMasker(System.out, prompt);
            Thread threadMasking = new Thread(masker);
            int firstByte = -1;
            PushbackInputStream inStream = null;
            try {
                threadMasking.start();
                inStream = new PushbackInputStream(System.in);
                firstByte = inStream.read();
            } finally {
                masker.stopMasking();
            }
            try {
                threadMasking.join();
            } catch (InterruptedException e) {
                throw new RuntimeException("Interrupt occurred when reading password");
            }
        }
    }
}
```

```
        if (firstByte == -1) {
            throw new RuntimeException("Console input ended unexpectedly");
        }
        if (System.out.checkError()) {
            throw new RuntimeException("Console password prompt output error");
        }
        inStream.unread(firstByte);
        return readLineSecure(inStream);
    }
    catch (IOException e) {
        throw new RuntimeException("I/O error occurred when reading password");
    }
}
//-----
/**
 * Reads one line from an input stream into a char array in a secure way
 * suitable for reading a password.
 * The char array will never contain a '\n' or '\r'.
 *
 * @param inStream the pushback input stream
 * @return line as a char array, not including end-of-line-chars;
 * never null, but may be zero length array
 * @throws RuntimeException if some error occurs
 */
private static final char[] readLineSecure(PushbackInputStream inStream)
throws RuntimeException {
    if (inStream == null) {
        throw new RuntimeException("readLineSecure inStream is null");
    }
    try {
        char[] buffer = null;
        try {
            buffer = new char[128];
            int offset = 0;
            // EOL is '\n' (unix), '\r\n' (windows), '\r' (mac)
            loop:
            while (true) {
                int c = inStream.read();
                switch (c) {
                    case -1:
                    case '\n':
                        break loop;
                    case '\r':
                        int c2 = inStream.read();
                        if ((c2 != '\n') && (c2 != -1))
                            inStream.unread(c2);
                        break loop;
                    default:
                        buffer = checkBuffer(buffer, offset);
                        buffer[offset++] = (char) c;
                        break;
                }
            }
            char[] result = new char[offset];
            System.arraycopy(buffer, 0, result, 0, offset);
            return result;
        }
        finally {
            if (buffer != null)
                Arrays.fill(buffer, ' ');
        }
    }
}
```

```
        catch (IOException e) {
            throw new RuntimeException("I/O error occurred when reading password");
        }
    }
//-----
/**
 * This is a helper method for readLineSecure.
 *
 * @param buffer the current char buffer
 * @param offset the current position in the buffer
 * @return the current buffer if it is not yet full;
 * otherwise return a larger buffer initialized with a copy
 * of the current buffer and then erase the current buffer
 * @throws RuntimeException if some error occurs
 */
private static final char[] checkBuffer(char[] buffer, int offset)
throws RuntimeException
{
    if (buffer == null)
        throw new RuntimeException("checkBuffer buffer is null");
    if (offset < 0)
        throw new RuntimeException("checkBuffer offset is negative");
    if (offset < buffer.length)
        return buffer;
    else {
        try {
            char[] bufferNew = new char[offset + 128];
            System.arraycopy(buffer, 0, bufferNew, 0, buffer.length);
            return bufferNew;
        } finally {
            Arrays.fill(buffer, ' ');
        }
    }
}
//-----
/**
 * This private class prints a one line prompt
 * and erases reply chars echoed to the console.
 */
private static final class StreamMasker
extends Thread {
    private static final String BLANKS = StreamMasker.repeatChars(' ', 10);
    private String m_promptOverwrite;
    private String m_setCursorToStart;
    private PrintStream m_out;
    private volatile boolean m_doMasking;
//-----
/**
 * Constructor.
 * @throws RuntimeException if some error occurs
 */
public StreamMasker(PrintStream outPrint, String prompt)
throws RuntimeException {
    if (outPrint == null)
        throw new RuntimeException("StreamMasker outPrint is null");
    if (prompt == null)
        throw new RuntimeException("StreamMasker prompt is null");
    if (prompt.indexOf('\r') != -1)
        throw new RuntimeException("StreamMasker prompt contains a CR");
    if (prompt.indexOf('\n') != -1)
        throw new RuntimeException("StreamMasker prompt contains a NL");
    m_out = outPrint;
}
```

```
m_setCursorToStart = StreamMasker.repeatChars('\010',
    prompt.length() + BLANKS.length());
m_promptOverwrite = m_setCursorToStart + prompt + BLANKS
    + m_setCursorToStart + prompt;
}
//-----
/**
 * Begin masking until asked to stop.
 * @throws RuntimeException if some error occurs
 */
public void run()
throws RuntimeException {
    int priorityOriginal = Thread.currentThread().getPriority();
    Thread.currentThread().setPriority(Thread.MAX_PRIORITY);
    try {
        m_doMasking = true;
        while (m_doMasking) {
            m_out.print(m_promptOverwrite);
            if (m_out.checkError())
                throw new RuntimeException("Console output error writing prompt");
            try {
                Thread.currentThread().sleep(1);
            } catch (InterruptedException ie) {
                Thread.currentThread().interrupt();
            }
            return;
        }
        m_out.print(m_setCursorToStart);
    } finally {
        Thread.currentThread().setPriority(priorityOriginal);
    }
}
//-----
/**
 * Instructs the thread to stop masking.
 */
public void stopMasking() {
    m_doMasking = false;
}
//-----
/**
 * Returns a repeated char string.
 *
 * @param c the char to repeat
 * @param length the number of times to repeat the char
 * @throws RuntimeException if some error occurs
 */
private static String repeatChars(char c, int length)
throws RuntimeException {
    if (length < 0)
        throw new RuntimeException("repeatChars length is negative");
    StringBuffer sb = new StringBuffer(length);
    for (int i = 0; i < length; i++)
        sb.append(c);
    return sb.toString();
}
}
```

12.5 Securing External Procedures

An external procedure is stored in a `.dll` or an `.so` file, separately from the database, and can be through a credential authentication.

- [About Securing External Procedures](#)
For safety reasons, Oracle external procedures run in a process that is physically separate from the database.
- [General Process for Configuring `extproc` for a Credential Authentication](#)
For better security, you can configure the `extproc` process to be authenticated through a credential.
- [extproc Process Authentication and Impersonation Expected Behaviors](#)
The `extproc` process has a set of behaviors for authentication and impersonation.
- [Configuring Authentication for External Procedures](#)
To configure a credential for `extproc` processes, you can use the `DBMS_CREDENTIAL` PL/SQL package.
- [External Procedures for Legacy Applications](#)
For maximum security, set the `ENFORCE_CREDENTIAL` environment variable to `TRUE`.

12.5.1 About Securing External Procedures

For safety reasons, Oracle external procedures run in a process that is physically separate from the database.

In most cases, you configure this process to run as a user other than the Oracle software account. When your application invokes this external procedure—such as when a library of `.dll` or `.so` files must be accessed—then Oracle Database creates an operating system process called `extproc`. By default, the `extproc` process communicates directly through your server process. In other words, if you do not use a credential, then Oracle Database creates an `extproc` process for you in the default Oracle Database server configuration, and runs `extproc` as the `oracle` software account. Alternatively, it can communicate through the Oracle Database listener.

Related Topics

- [Guideline for Securing External Procedures](#)
The `ENFORCE_CREDENTIAL` environment variable controls how an `extproc` process authenticates user credentials and callout functions.

12.5.2 General Process for Configuring `extproc` for a Credential Authentication

For better security, you can configure the `extproc` process to be authenticated through a credential.

The general process is as follows:

1. You create a credential and then configure your database to use it (that is, configure authentication for an external procedure).

The credential is in an encrypted container. Both public and private synonyms can refer to this credential.

2. You make your initial connection to the database, which you are running in either a dedicated server or a shared server process.
3. Your application makes a call to an external procedure.
If this is the first call, then Oracle Database creates an `extproc` process. Note that if you want to use a credential for `extproc`, then you cannot use the Oracle listener to spawn the `extproc` process.
4. The `extproc` process impersonates (that is, it runs on behalf of your supplied credential), loads the requisite `.dll`, `.so`, `.sl`, or `.a` file, and then sends your data between SQL and C.

Related Topics

- [Configuring Authentication for External Procedures](#)
To configure a credential for `extproc` processes, you can use the `DBMS_CREDENTIAL` PL/SQL package.

12.5.3 extproc Process Authentication and Impersonation Expected Behaviors

The `extproc` process has a set of behaviors for authentication and impersonation.

[Table 12-2](#) describes the expected behaviors of an `extproc` process based on possible authentication and impersonation scenarios.

In this table, `GLOBAL_EXTPROC_CREDENTIAL` is a reserved credential name for the default credential if the credential is not explicitly specified and if the `ENFORCE_CREDENTIAL` environment variable is set to `TRUE`. Therefore, Oracle strongly recommends that you create a credential by the that name if `ENFORCE_CREDENTIAL` is set to `TRUE`.

Table 12-2 Expected Behaviors for extproc Process Authentication and Impersonation Settings

ENFORCE_CREDENTIAL Environment Variable Setting	PL/SQL Library with Credential?	GLOBAL_EXTPROC_CREDENTIAL Credential Existence	Expected Behavior
FALSE	No	No	Uses the pre-release 12c authentication, which authenticates by operating system privilege of the owners of the Oracle listener or Oracle server process.
FALSE	No	Yes	Authenticates and impersonates with the Oracle Database instance-wide supplied <code>GLOBAL_EXTPROC_CREDENTIAL</code> . If only the <code>GLOBAL_EXTPROC_CREDENTIAL</code> credential is in use, then the <code>EXECUTE</code> privilege on this global credential is automatically granted to all users implicitly.
FALSE	Yes	No	Authenticates and impersonates with the credential defined in the PL/SQL library

Table 12-2 (Cont.) Expected Behaviors for extproc Process Authentication and Impersonation Settings

ENFORCE_CREDENTIAL Environment Variable Setting	PL/SQL Library with Credential?	GLOBAL_EXTPROC_CREDENTIAL Credential Existence	Expected Behavior
FALSE	Yes	Yes	Authenticates and impersonates. If both the PL/SQL library and the GLOBAL_EXTPROC_CREDENTIAL settings have credentials defined, then the credential of the PL/SQL library takes precedence.
TRUE	No	No	Returns error ORA-28575: unable to open RPC connection to external procedure agent
TRUE	No	Yes	Authenticates and impersonates with the Oracle system-wide supplied GLOBAL_EXTPROC_CREDENTIAL (footnote 1)
TRUE	Yes	No	Authenticates and impersonates with the credential defined in the PL/SQL library
TRUE	Yes	Yes	Authenticates and impersonates (footnote 2)

12.5.4 Configuring Authentication for External Procedures

To configure a credential for `extproc` processes, you can use the `DBMS_CREDENTIAL` PL/SQL package.

1. Log in to a PDB as a user who has been granted the `CREATE CREDENTIAL` or `CREATE ANY CREDENTIAL` privilege.

In addition, ensure that you also have the `CREATE LIBRARY` or `CREATE ANY LIBRARY` privilege, and the `EXECUTE` object privilege on the library that contains the external calls.

```
sqlplus psmith@hpdb
Enter password: password
Connected.
```

To find the available PDBs in a CDB, log in to the CDB root container and then query the `PDB_NAME` column of the `DBA_PDBS` data dictionary view. To check the current container, run the `show con_name` command.

2. Using the `DBMS_CREDENTIAL` PL/SQL package, create a new credential.

For example:

```
BEGIN
  DBMS_CREDENTIAL.CREATE_CREDENTIAL (
    credential_name => 'smith_credential',
    user_name       => 'tjones',
    password        => 'password')
END;
/
```

In this example:

- `credential_name`: Enter the name of the credential. Optionally, prefix it with the name of a schema (for example, `psmith.smith_credential`). If the `ENFORCE_CREDENTIAL` environment variable is set to `TRUE`, then you should create a credential with `credential_name GLOBAL_EXTPROC_CREDENTIAL`.
- `user_name`: Enter a valid operating system user name to be used to run as the user.
- `password`: Enter the password for the `user_name` user.

3. Associate the credential with a PL/SQL library.

For example:

```
CREATE OR REPLACE LIBRARY ps_lib
AS 'smith_lib.so' IN DLL_LOC
CREDENTIAL smith_credential;
```

In this example, `DLL_LOC` is a directory object that points to the `$ORACLE_HOME/bin` directory. Oracle does not recommend using absolute paths to the DLL.

When the PL/SQL library is loaded by an external procedure call through the `extproc` process, `extproc` now can authenticate and impersonate on behalf of the defined `smith_credential` credential.

4. Register the external procedure by creating a PL/SQL procedure or function that tells PL/SQL how to call the external procedure and what arguments to pass to it.

For example, to create a function that registers an external procedure that was written in C, only use the `AS LANGUAGE C`, `LIBRARY`, and `NAME` clauses of the `CREATE FUNCTION` statement, as follows:

```
CREATE OR REPLACE FUNCTION getInt (x VARCHAR2, y BINARY_INTEGER)
RETURN BINARY_INTEGER
AS LANGUAGE C
LIBRARY ps_lib
NAME "get_int_vals"
PARAMETERS (x STRING, y int);
```

Related Topics

- [Guideline for Securing External Procedures](#)
The `ENFORCE_CREDENTIAL` environment variable controls how an `extproc` process authenticates user credentials and callout functions.
- *Oracle Database PL/SQL Packages and Types Reference*
- *Oracle Call Interface Developer's Guide*
- *Oracle Database Net Services Administrator's Guide*

12.5.5 External Procedures for Legacy Applications

For maximum security, set the `ENFORCE_CREDENTIAL` environment variable to `TRUE`.

However, if you must accommodate backward compatibility, then set `ENFORCE_CREDENTIAL` to `FALSE`. `FALSE` enables the `extproc` process to authenticate, impersonate, and perform user-defined callout functions on behalf of the supplied credential when either of the following occurs:

- The credential is defined with a PL/SQL library.
- The credential is not defined but the `GLOBAL_EXTPROC_CREDENTIAL` credential exists.

If neither of these credential definitions is in place, then setting the `ENFORCE_CREDENTIAL` parameter to `FALSE` sets the `extproc` process to be authenticated by the operating system privilege of the owners of the Oracle listener or Oracle server process.

For legacy applications that run on top of `extproc` processes, ideally you should change the legacy application code to associate all alias libraries with credentials. If you cannot do this, then Oracle Database uses the `GLOBAL_EXTPROC_CREDENTIAL` credential to determine how authentication will be handled. If the `GLOBAL_EXTPROC_CREDENTIAL` credential is not defined, then the `extproc` process is authenticated by the operating system privilege of the owners of the Oracle listener or Oracle server process.

12.6 Securing LOBs with LOB Locator Signatures

You can secure large objects (LOB) by regenerating their LOB locator signatures.

- [About Securing LOBs with LOB Locator Signatures](#)
A LOB locator, which is a pointer to the actual location of a large object (LOB) value, can be assigned a signature, which can be used to secure the LOB.
- [Managing the Encryption of a LOB Locator Signature Key](#)
You can use the `ALTER DATABASE DICTIONARY SQL` statement to encrypt a LOB locator signature key.

12.6.1 About Securing LOBs with LOB Locator Signatures

A LOB locator, which is a pointer to the actual location of a large object (LOB) value, can be assigned a signature, which can be used to secure the LOB.

When you create a LOB, Oracle Database automatically assigns a signature to the LOB locator. Oracle Database verifies the signature matches when it receives a locator from a client to ensure that the locator has not been tampered with. Signature-based security can be used for both persistent and temporary LOB locators. It is also used for distributed CLOBs, BLOBs, and NBLOBs that come from index organized table (IOT) locators.

In an Oracle Real Applications Clusters (Oracle RAC) environment, all instances will share the same signature key, which is persisted in the database. Each pluggable database (PDB) will have its own signature key. If a LOB locator has been tampered with, the signature verification rejects the LOB and raises an `ORA-64219: invalid LOB locator encountered` error.

You can encrypt, rekey, and delete the LOB signature key that was used to generate LOB signature for LOB locators that are sent from a standalone database or PDB to a client. If you plan to encrypt the signature key, then the database (or PDB) in which the key resides must have an open TDE keystore.

To enable the LOB signature feature, you must set the `LOB_SIGNATURE_ENABLE` initialization parameter to `TRUE`. By default, `LOB_SIGNATURE_ENABLE` is set to `FALSE`.

12.6.2 Managing the Encryption of a LOB Locator Signature Key

You can use the `ALTER DATABASE DICTIONARY SQL` statement to encrypt a LOB locator signature key.

1. Log in to the database as a user who has `ALTER DATABASE DICTIONARY` privileges.
2. If necessary, enable the LOB signature key feature by setting the `LOB_SIGNATURE_ENABLE` initialization parameter to `TRUE`.

```
ALTER SYSTEM SET LOB_SIGNATURE_ENABLE = TRUE;
```

Alternatively, you can set the `LOB_SIGNATURE_ENABLE` parameter in the `init.ora` initialization file before a database restart. This enables the LOB signature key feature for all PDBs.

3. If you plan to encrypt the signature key, then ensure that the database or PDB has an open TDE keystore.

You must have the `SYSKM` administrative privilege to create a TDE keystore.

For example, to create and open a software TDE keystore:

```
ADMINISTER KEY MANAGEMENT CREATE KEYSTORE '/etc/ORACLE/WALLETS/orcl' IDENTIFIED BY
password;
ADMINISTER KEY MANAGEMENT SET KEYSTORE OPEN IDENTIFIED BY password;
```

4. Run the `ALTER DATABASE DICTIONARY` statement to set the LOB signature key configuration.
 - To encrypt the LOB locator signature key instead of obfuscating it, run the following statement:

```
ALTER DATABASE DICTIONARY ENCRYPT CREDENTIALS;
```

- To regenerate the LOB locator signature key for LOB locators that will be sent to a client, use the following statement. If the database is in restricted mode, then Oracle Database regenerates a new LOB signature key to encrypt the regenerated signature key. If the database is in non-restricted mode, then a new signature key is not regenerated but instead, Oracle Database uses a new encryption key to encrypt the existing LOB signature key. Oracle recommends that a database administrator or PDB administrator run this statement in restricted mode on a periodic basis, preferably during database down time.

```
ALTER DATABASE DICTIONARY REKEY CREDENTIALS;
```

- To delete the encrypted LOB locator signature key and then regenerate a new LOB signature key in obfuscated form instead of encrypted form, run the following statement:

```
ALTER DATABASE DICTIONARY DELETE CREDENTIALS;
```

Related Topics

- [Configuring Transparent Data Encryption](#)

12.7 Managing Application Privileges

Most database applications involve different privileges on different schema objects.

Keeping track of the privileges that are required for each application can be complex. In addition, authorizing users to run an application can involve many `GRANT` operations. To simplify application privilege management, create a role for each application and grant that role all the privileges a user must run the application. In fact, an application can have several roles, each granted a specific subset of privileges that allow greater or lesser capabilities while running the application. For example, suppose every administrative assistant uses the Vacation application to record the vacation taken by members of the department. To best manage this application, you should do the following:

1. Create a `VACATION` role.
2. Grant all privileges required by the Vacation application to the `VACATION` role.

Useful data dictionary views are `ROLE_TAB_PRIVS`, `ROLE_SYS_PRIVS`, and `DBA_ROLE_PRIVS`.

3. Grant the `VACATION` role to all administrative assistants. Better yet, create a role that defines the privileges the administrative assistants have, and then grant the `VACATION` role to that role.

Related Topics

- [Creating a Role](#)
You can create a role that is authenticated with or without a password. You also can create external or global roles.
- [User Privilege and Role Data Dictionary Views](#)
You can use special queries to find information about various types of privilege and role grants.

12.8 Advantages of Using Roles to Manage Application Privileges

Grouping application privileges in a role aids privilege management.

Consider the following administrative options:

- You can grant the role, rather than many individual privileges, to those users who run the application. Then, as employees change jobs, you need to grant or revoke only one role, rather than many privileges.
- You can change the privileges associated with an application by modifying only the privileges granted to the role, rather than the privileges held by all users of the application.
- You can determine the privileges that are necessary to run a particular application by querying the `ROLE_TAB_PRIVS` and `ROLE_SYS_PRIVS` data dictionary views.
- You can determine which users have privileges on which applications by querying the `DBA_ROLE_PRIVS` data dictionary view.

12.9 Creating Secure Application Roles to Control Access to Applications

A secure application role is only enabled through its associated PL/SQL package or procedure.

- [Step 1: Create the Secure Application Role](#)
The `CREATE ROLE` statement with the `IDENTIFIED USING` clause creates a secure application role.
- [Step 2: Create a PL/SQL Package to Define the Access Policy for the Application](#)
You can create a PL/SQL package that defines the access policy for your application.

12.9.1 Step 1: Create the Secure Application Role

The `CREATE ROLE` statement with the `IDENTIFIED USING` clause creates a secure application role.

You must have the `CREATE ROLE` system privilege to run this statement.

For example, to create a secure application role called `hr_admin` that is associated with the `sec_mgr.hr_admin` package:

1. Create the security application role as follows:

```
CREATE ROLE hr_admin IDENTIFIED USING sec_mgr.hr_admin_role_check;
```

This statement indicates the following:

- The role `hr_admin` to be created is a secure application role.
 - The role can only be enabled by modules defined inside the PL/SQL procedure `sec_mgr.hr_admin_role_check`. At this stage, this procedure does not need to exist.
2. Grant the security application role the privileges you would normally associate with this role.

For example, to grant the `hr_admin` role `SELECT`, `INSERT`, `UPDATE`, and `DELETE` privileges on the `HR.EMPLOYEES` table, you enter the following statement:

```
GRANT SELECT, INSERT, UPDATE, DELETE ON HR.EMPLOYEES TO hr_admin;
```

Do not grant the role directly to the user. The PL/SQL procedure or package does that for you, assuming the user passes its security policies.

12.9.2 Step 2: Create a PL/SQL Package to Define the Access Policy for the Application

You can create a PL/SQL package that defines the access policy for your application.

- [About Creating a PL/SQL Package to Define the Access Policy for an Application](#)
To enable or disable the secure application role, you must create the security policies of the role within a PL/SQL package.
- [Creating a PL/SQL Package or Procedure to Define the Access Policy for an Application](#)
The PL/SQL package or procedure that you create must use invoker's rights to define the access policy.
- [Testing the Secure Application Role](#)
As a user who has been granted the secure application role, try performing an action that requires the privileges the role grants.

12.9.2.1 About Creating a PL/SQL Package to Define the Access Policy for an Application

To enable or disable the secure application role, you must create the security policies of the role within a PL/SQL package.

You also can create an individual procedure to do this, but a package lets you group a set of procedures together. This lets you group a set of policies that, used together, present a solid security strategy to protect your applications. For users (or potential intruders) who fail the security policies, you can add auditing checks to the package to record the failure. Typically, you create this package in the schema of the security administrator.

The package or procedure must accomplish the following:

- **It must use invoker's rights to enable the role.** To create the package using invoker's rights, you must set the `AUTHID` property to `CURRENT_USER`. You cannot create the package by using definer's rights.
- **It must include one or more security checks to validate the user.** One way to validate users is to use the `SYS_CONTEXT` SQL function. To find session information for a user, you can use `SYS_CONTEXT` with an application context.

- **It must issue a SET ROLE SQL statement or DBMS_SESSION.SET_ROLE procedure when the user passes the security checks.** Because you create the package using invoker's rights, you must set the role by issuing the SET ROLE SQL statement or the DBMS_SESSION.SET_ROLE procedure. (However, you cannot use the SET ROLE ALL statement for this type of role enablement.) The PL/SQL embedded SQL syntax does not support the SET ROLE statement, but you can invoke SET ROLE by using dynamic SQL (for example, with EXECUTE IMMEDIATE).

Because of the way that you must create this package or procedure, you cannot use a logon trigger to enable or disable a secure application role. Instead, invoke the package directly from the application when the user logs in, before the user must use the privileges granted by the secure application role.

Related Topics

- [Oracle Database PL/SQL Language Reference](#)
- [Using Application Contexts to Retrieve User Information](#)
An application context stores user identification that can enable or prevent a user from accessing data in the database.
- [Oracle Database PL/SQL Language Reference](#)

12.9.2.2 Creating a PL/SQL Package or Procedure to Define the Access Policy for an Application

The PL/SQL package or procedure that you create must use invoker's rights to define the access policy.

For example, suppose you wanted to restrict anyone using the `hr_admin` role to employees who are on site (that is, using certain terminals) and between the hours of 8 a.m. and 5 p.m. As the system or security administrator, you can create a procedure that defines the access policy for the application.

1. Create the procedure as follows:

```
CREATE OR REPLACE PROCEDURE hr_admin_role_check
AUTHID CURRENT_USER
AS
BEGIN
  IF (SYS_CONTEXT ('userenv','ip_address')
      IN ('192.0.2.10' , '192.0.2.11')
      AND
      TO_CHAR (SYSDATE, 'HH24') BETWEEN 8 AND 17)
  THEN
    EXECUTE IMMEDIATE 'SET ROLE hr_admin';
  END IF;
END;
/
```

In this example:

- `AUTHID CURRENT_USER` sets the AUTHID property to `CURRENT_USER` so that invoker's rights can be used.
- `IF (SYS_CONTEXT ('userenv','ip_address'))` validates the user by using the `SYS_CONTEXT` SQL function to retrieve the user session information.

- `BETWEEN ... TO_CHAR` creates a test to grant or deny access. The test restricts access to users who are on site (that is, using certain terminals) and working between the hours of 8:00 a.m. and 5:00 p.m. If the user passes this check, the `hr_admin` role is granted.
 - `THEN... EXECUTE` grants the role to the user by issuing the `SET ROLE` statement using the `EXECUTE IMMEDIATE` command, assuming the user passes the test.
2. Grant `EXECUTE` permissions for the `hr_admin_role_check` procedure to any user who was assigned it.

For example:

```
GRANT EXECUTE ON hr_admin_role_check TO psmith;
```

12.9.2.3 Testing the Secure Application Role

As a user who has been granted the secure application role, try performing an action that requires the privileges the role grants.

When you log in as a user who has been granted the secure application role, the role is then enabled.

1. As the user who has been granted the role, log in to the PDB where the application role was created.

For example:

```
CONNECT PSMITH@pdb_name
Enter password: password
```

2. Perform an action that requires the privileges the secure application role grants.

For example, if the role grants the `EXECUTE` privilege for a procedure called `sec_admin.hr_admin_role_check`:

```
EXECUTE sec_admin.hr_admin_role_check;
```

12.10 Association of Privileges with User Database Roles

Ensure that users have only the privileges associated with the current database role.

- [Why Users Should Only Have the Privileges of the Current Database Role](#)
A single user can use many applications and associated roles.
- [Use of the SET ROLE Statement to Automatically Enable or Disable Roles](#)
You can use a `SET ROLE` statement at the beginning of each application to automatically enable its associated role and to disable all others.

12.10.1 Why Users Should Only Have the Privileges of the Current Database Role

A single user can use many applications and associated roles.

However, you should ensure that the user has only the privileges associated with the current database role.

Consider the following scenario:

- The `ORDER` role (for an application called Order) contains the `UPDATE` privilege for the `INVENTORY` table.
- The `INVENTORY` role (for an application called Inventory) contains the `SELECT` privilege for the `INVENTORY` table.
- Several order entry clerks were granted both the `ORDER` and `INVENTORY` roles.

In this scenario, an order entry clerk who was granted both roles can use the privileges of the `ORDER` role when running the `INVENTORY` application to update the `INVENTORY` table. The problem is that updating the `INVENTORY` table is not an authorized action for the `INVENTORY` application. It is an authorized action for the `ORDER` application. To avoid this problem, use the `SET ROLE` statement as explained in the following section.

12.10.2 Use of the SET ROLE Statement to Automatically Enable or Disable Roles

You can use a `SET ROLE` statement at the beginning of each application to automatically enable its associated role and to disable all others.

This way, each application dynamically enables particular privileges for a user only when required. The `SET ROLE` statement simplifies privilege management. You control what information users can access and when they can access it. The `SET ROLE` statement also keeps users operating in a well-defined privilege domain. If a user obtains privileges only from roles, then the user cannot combine these privileges to perform unauthorized operations.

Related Topics

- [How Grants and Revokes Work with SET ROLE and Default Role Settings](#)
Privilege grants and the `SET ROLE` statement affect when and how grants and revokes take place.
- [When Grants and Revokes Take Effect](#)
Depending on the privilege that is granted or revoked, a grant or revoke takes effect at different times.

12.11 Protecting Database Objects by Using Schemas

A schema is a security domain that can contain database objects. Privileges granted to users and roles control access to these database objects.

- [Protecting Database Objects in a Unique Schema](#)
Think of most schemas as user names: the accounts that enable users to connect to a database and access the database objects.
- [Protection of Database Objects in a Shared Schema](#)
For many applications, users only need access to an application schema; they do not need their own accounts or schemas in the database.

12.11.1 Protecting Database Objects in a Unique Schema

Think of most schemas as user names: the accounts that enable users to connect to a database and access the database objects.

However, a *unique schema* does not allow connections to the database, but is used to contain a related set of objects. Schemas of this sort are created as typical users, and yet are not granted the `CREATE SESSION` system privilege (either explicitly or through a role).

- To protect the objects, temporarily grant the `CREATE SESSION` and `RESOURCE` privilege to a unique schema if you want to use the `CREATE SCHEMA` statement to create multiple tables and views in a single transaction.

For example, a given schema might own the schema objects for a specific application. If application users have the privileges to do so, then they can connect to the database using typical database user names and use the application and the corresponding objects. However, no user can connect to the database using the schema set up for the application. This configuration prevents access to the associated objects through the schema, and provides another layer of protection for schema objects. In this case, the application could issue an `ALTER SESSION SET CURRENT_SCHEMA` statement to connect the user to the correct application schema.

12.11.2 Protection of Database Objects in a Shared Schema

For many applications, users only need access to an application schema; they do not need their own accounts or schemas in the database.

For example, users John, Firuzeh, and Jane are all users of the Payroll application, and they need access to the `payroll` schema on the `finance` database. None of them need to create their own objects in the database. They need to only access the `payroll` objects. To address this issue, Oracle Database provides the enterprise users, which are schema-independent users.

Enterprise users, users managed in a directory service, do not need to be created as database users because they use a shared database schema. To reduce administration costs, you can create an enterprise user once in the directory, and point the user at a shared schema that many other enterprise users can also access.

Note:

Enterprise User Security (EUS) is deprecated with Oracle Database 23ai. Oracle recommends that you migrate to using Centrally Managed Users (CMU). This feature enables you to directly connect with Microsoft Active Directory without an intervening directory service for enterprise user authentication and authorization to the database. If your Oracle Database is in the cloud, you can also choose to move to one of the newer integrations with a cloud identity provider.

Related Topics

- [Oracle Database Enterprise User Security Administrator's Guide](#)

12.12 Object Privileges in an Application

When you design an application, consider the types of users and the level access they need.

- [What Application Developers Must Know About Object Privileges](#)
Object privileges enable end users to perform actions on objects such as tables, views, sequences, procedures, functions, or packages.
- [SQL Statements Permitted by Object Privileges](#)
As you implement and test your application, you should create each necessary role.

12.12.1 What Application Developers Must Know About Object Privileges

Object privileges enable end users to perform actions on objects such as tables, views, sequences, procedures, functions, or packages.

[Table 12-3](#) summarizes the object privileges available for each type of object.

Table 12-3 How Privileges Relate to Schema Objects

Object Privilege	Applies to Table?	Applies to View?	Applies to Sequence?	Applies to Standalone Stored Procedures, Functions, or Public Package Constructs
ALTER	Yes	No	Yes	No
DELETE	Yes	Yes	No	No
EXECUTE	No	No	No	Yes
INDEX	Yes (privilege that cannot be granted to a role)	No	No	No
INSERT	Yes	Yes	No	No
REFERENCES	Yes (privilege that cannot be granted to a role)	No	No	No
SELECT	Yes	Yes (can also be granted for snapshots)	Yes	No
UPDATE	Yes	Yes	No	No

Related Topics

- [Auditing Object Actions](#)
You can use the `CREATE AUDIT POLICY` statement to audit object actions.

12.12.2 SQL Statements Permitted by Object Privileges

As you implement and test your application, you should create each necessary role.

Test the usage scenario for each role to ensure that the users of your application will have proper access to the database. After completing your tests, coordinate with the administrator of the application to ensure that each user is assigned the proper roles.

[Table 12-4](#) lists the SQL statements permitted by the object privileges shown in [Table 12-3](#).

Table 12-4 SQL Statements Permitted by Database Object Privileges

Object Privilege	SQL Statements Permitted
ALTER	ALTER object (table or sequence) CREATE TRIGGER ON object (tables only)

Table 12-4 (Cont.) SQL Statements Permitted by Database Object Privileges

Object Privilege	SQL Statements Permitted
DELETE	DELETE FROM object (table, view, or synonym)
EXECUTE	EXECUTE object (procedure or function) References to public package variables
INDEX	CREATE INDEX ON object (table, view, or synonym)
INSERT	INSERT INTO object (table, view, or synonym)
REFERENCES	CREATE or ALTER TABLE statement defining a FOREIGN KEY integrity constraint on object (tables only)
SELECT	SELECT...FROM object (table, view, synonym, or snapshot) SQL statements using a sequence

Related Topics

- [About Privileges and Roles](#)
Authorization permits users to access, process, or alter data; it also creates limitations on user access or actions.
- [Auditing Object Actions](#)
You can use the CREATE AUDIT POLICY statement to audit object actions.

12.13 Parameters for Enhanced Security of Database Communication

Parameters can be used to manage security, such as handling bad packets from protocol errors or configuring the maximum number of authentication errors.

- [Bad Packets Received on the Database from Protocol Errors](#)
The SEC_PROTOCOL_ERROR_TRACE_ACTION initialization parameter controls how trace files are managed when protocol errors are generated.
- [Controlling Server Execution After Receiving a Bad Packet](#)
The SEC_PROTOCOL_ERROR_FURTHER_ACTION initialization parameter controls server execution after the server receives a bad packet.
- [Configuration of the Maximum Number of Authentication Attempts](#)
The SEC_MAX_FAILED_LOGIN_ATTEMPTS initialization parameter sets the number of authentication attempts before the database will drop a failed connection.
- [Configuring the Display of the Database Version Banner](#)
The SEC_RETURN_SERVER_RELEASE_BANNER initialization parameter can be used to prevent the display of detailed product information during authentication.
- [Configuring Banners for Unauthorized Access and Auditing User Actions](#)
The SEC_USER_UNAUTHORIZED_ACCESS_BANNER and SEC_USER_AUDIT_ACTION_BANNER initialization parameters control the display of banners for unauthorized access and for auditing users.

12.13.1 Bad Packets Received on the Database from Protocol Errors

The `SEC_PROTOCOL_ERROR_TRACE_ACTION` initialization parameter controls how trace files are managed when protocol errors are generated.

Networking communication utilities such as Oracle Call Interface (OCI) or Two-Task Common (TTC) can generate a large disk file containing the stack trace and heap dump when the server receives a bad packet, out-of-sequence packet, or a private or an unused remote procedure call.

Typically, this disk file can grow quite large. An intruder can potentially cripple a system by repeatedly sending bad packets to the server, which can result in disk flooding and Denial of Service (DOS) attacks. An unauthenticated client can also mount this type of attack.

You can prevent these attacks by setting the `SEC_PROTOCOL_ERROR_TRACE_ACTION` initialization parameter to one of the following values:

- **None:** Configures the server to ignore the bad packets and does not generate any trace files or log messages. Use this setting if the server availability is overwhelmingly more important than knowing that bad packets are being received.

For example:

```
SEC_PROTOCOL_ERROR_TRACE_ACTION = None
```

- **Trace (default setting):** Creates the trace files, but it is useful for debugging purposes, for example, when a network client is sending bad packets as a result of a bug.

For example:

```
SEC_PROTOCOL_ERROR_TRACE_ACTION = Trace
```

- **Log:** Writes a short, one-line message to the server trace file. This choice balances some level of auditing with system availability.

For example:

```
SEC_PROTOCOL_ERROR_TRACE_ACTION = Log
```

- **Alert:** Sends an alert message to a database administrator or monitoring console.

For example:

```
SEC_PROTOCOL_ERROR_TRACE_ACTION = Alert
```

12.13.2 Controlling Server Execution After Receiving a Bad Packet

The `SEC_PROTOCOL_ERROR_FURTHER_ACTION` initialization parameter controls server execution after the server receives a bad packet.

After Oracle Database detects a client or server protocol error, it must continue execution. However, this could subject the server to further bad packets, which could lead to disk flooding or denial-of-service attacks.

- To control the further execution of a server process when it is receiving bad packets from a potentially malicious client, set the `SEC_PROTOCOL_ERROR_FURTHER_ACTION` initialization parameter to one of the following values:

- **Continue:** Continues the server execution. However, be aware that the server may be subject to further attacks.

For example:

```
SEC_PROTOCOL_ERROR_FURTHER_ACTION = Continue
```

- `(Delay, m)`: Delays the client m seconds before the server can accept the next request from the same client connection. This setting prevents malicious clients from excessively using server resources while legitimate clients experience a degradation in performance but can continue to function. When you enter this setting, enclose it in parentheses.

For example:

```
SEC_PROTOCOL_ERROR_FURTHER_ACTION = (Delay,3)
```

If you are setting `SEC_PROTOCOL_ERROR_FURTHER_ACTION` by using the `ALTER SYSTEM` or `ALTER SESSION` SQL statement, then you must enclose the `Delay` setting in either single or double quotation marks.

```
ALTER SYSTEM SEC_PROTOCOL_ERROR_FURTHER_ACTION = '(Delay,3)';
```

- `(Drop, n)`: Forcefully terminates the client connection after n bad packets. This setting enables the server to protect itself at the expense of the client, for example, loss of a transaction. However, the client can still reconnect, and attempt the same operation again. Enclose this setting in parentheses. The default value of `SEC_PROTOCOL_ERROR_FURTHER_ACTION` is `(Drop,3)`.

For example:

```
SEC_PROTOCOL_ERROR_FURTHER_ACTION = (Drop,10)
```

Similar to the `Delay` setting, you must enclose the `Drop` setting in single or double quotation marks if you are using `ALTER SYSTEM` or `ALTER SESSION` to change this setting.

12.13.3 Configuration of the Maximum Number of Authentication Attempts

The `SEC_MAX_FAILED_LOGIN_ATTEMPTS` initialization parameter sets the number of authentication attempts before the database will drop a failed connection.

As part of connection creation, the listener starts the server process and attaches it to the client. Using this physical connection, the client is then able to authenticate the connection. After a server process starts, the client authenticates with this server process. An intruder could start a server process, and then issue an unlimited number of authenticated requests with different user names and passwords in an attempt to gain access to the database.

You can limit the number of failed login attempts for application connections by setting the `SEC_MAX_FAILED_LOGIN_ATTEMPTS` initialization parameter to restrict the number of authentication attempts on a connection. After the specified number of authentication attempts fail, the database process drops the connection and the server process is terminated. By default, `SEC_MAX_FAILED_LOGIN_ATTEMPTS` is set to 3.

Remember that the `SEC_MAX_FAILED_LOGIN_ATTEMPTS` initialization parameter is designed to prevent potential intruders from attacking your applications, as well as valid users who have forgotten their passwords. The `sqlnet.ora` `INBOUND_CONNECT_TIMEOUT` parameter and the `FAILED_LOGIN_ATTEMPTS` profile parameter also restrict failed logins, but the difference is that these two parameters only apply to valid user accounts.

For example, to limit the maximum attempts to 5, set `SEC_MAX_FAILED_LOGIN_ATTEMPTS` as follows in the `initsid.ora` initialization parameter file:

```
SEC_MAX_FAILED_LOGIN_ATTEMPTS = 5
```

12.13.4 Configuring the Display of the Database Version Banner

The `SEC_RETURN_SERVER_RELEASE_BANNER` initialization parameter can be used to prevent the display of detailed product information during authentication.

Detailed product version information should not be accessible before a client connection (including an Oracle Call Interface client) is authenticated. An intruder could use the database version to find information about security vulnerabilities that may be present in the database software.

- To restrict the display of the database version banner to unauthenticated clients, set the `SEC_RETURN_SERVER_RELEASE_BANNER` initialization parameter in the `initsid.ora` initialization parameter file to either `TRUE` or `FALSE`.

By default, `SEC_RETURN_SERVER_RELEASE_BANNER` is set to `FALSE`.

For example, if you set it to `TRUE`, then Oracle Database displays the full correct database version. For example, for Release 19.1.0.0:

```
Oracle Database 19c Enterprise Edition Release 19.1.0.0 - Production
```

If a release number uses point release notation (for example, Oracle Database Release 19.1.0.1), then the banner displays as follows:

```
Oracle Database 19c Enterprise Edition Release 19.1.0.1 - Production
```

However, if in that same release, you set it to `NO`, then Oracle Database restricts the banner to display the following fixed text starting with Release 19.1, which instead of 19.1.0.1 is 19.1.0.0.0:

```
Oracle Database 19c Release 19.1.0.0.0 - Production
```

12.13.5 Configuring Banners for Unauthorized Access and Auditing User Actions

The `SEC_USER_UNAUTHORIZED_ACCESS_BANNER` and `SEC_USER_AUDIT_ACTION_BANNER` initialization parameters control the display of banners for unauthorized access and for auditing users.

You should create and configure banners to warn users against unauthorized access and possible auditing of user actions. The notices are available to the client application when it logs into the database.

- To configure these banners to display, set the following `sqlnet.ora` parameters on the database server side to point to a text file that contains the banner information:
 - `SEC_USER_UNAUTHORIZED_ACCESS_BANNER`. For example:

```
SEC_USER_UNAUTHORIZED_ACCESS_BANNER = /opt/Oracle/12c/dbs/unauthaccess.txt
```
 - `SEC_USER_AUDIT_ACTION_BANNER`. For example:

```
SEC_USER_AUDIT_ACTION_BANNER = /opt/Oracle/12c/dbs/auditactions.txt
```

By default, these parameters are not set. In addition, be aware that there is a 512-byte limitation for the number of characters used for the banner text.

After you set these parameters, the Oracle Call Interface application must use the appropriate OCI APIs to retrieve these banners and present them to the end user.

Part III

Controlling Access to Data

Part III describes how to control access to data.

- [Using Application Contexts to Retrieve User Information](#)
An application context stores user identification that can enable or prevent a user from accessing data in the database.
- [Using Oracle Virtual Private Database to Control Data Access](#)
Oracle Virtual Private Database (VPD) enables you to filter users who access data.
- [Using Transparent Sensitive Data Protection](#)
- [Encryption of Sensitive Credential Data in the Data Dictionary](#)
You can encrypt sensitive credential information, such as passwords that are stored in the data dictionary.
- [Securing and Isolating Resources Using DbNest](#)
You can secure and isolate instance-level and operating system resources by using dbNest.
- [On-Demand Encryption of Data](#)
You can use the `DBMS_CRYPTO` PL/SQL package to perform on-demand encryption of data.

13

Using Application Contexts to Retrieve User Information

An application context stores user identification that can enable or prevent a user from accessing data in the database.

- [About Application Contexts](#)
An application context provides many benefits in controlling the access that a user has to data.
- [Types of Application Contexts](#)
There are three general categories of application contexts.
- [Using Database Session-Based Application Contexts](#)
A database session-based application context enables you to retrieve session-based information about a user.
- [Global Application Contexts](#)
You can use a global application context to access application values across database sessions, including an Oracle Real Application Clusters environment.
- [Using Client Session-Based Application Contexts](#)
A client session-based application context is stored in the User Global Area (UGA).
- [Application Context Data Dictionary Views](#)
Oracle Database provides data dictionary views that provide information about application contexts.

13.1 About Application Contexts

An application context provides many benefits in controlling the access that a user has to data.

- [What Is an Application Context?](#)
An **application context** is a set of name-value pairs that Oracle Database stores in memory.
- [Components of the Application Context](#)
An application context has two components, comprising a name-value pair.
- [Where Are the Application Context Values Stored?](#)
Oracle Database stores the application context values in a secure data cache.
- [Benefits of Using Application Contexts](#)
Most applications contain the kind of information that can be used for application contexts.
- [How Editions Affects Application Context Values](#)
Oracle Database sets the application context in all editions that are affected by the application context package.
- [Application Contexts in a Multitenant Environment](#)
Where you create an application in a multitenant environment determines where you must create the application context.

13.1.1 What Is an Application Context?

An **application context** is a set of name-value pairs that Oracle Database stores in memory.

The context has a label called a **namespace** (for example, `empno_ctx` for an application context that retrieves employee IDs). This context enables Oracle Database to find information about both database and nondatabase users during authentication.

Inside the context are the name-value pairs (an associative array): the name points to a location in memory that holds the value. An application can use the application context to access session information about a user, such as the user ID or other user-specific information, or a client ID, and then securely pass this data to the database.

You can then use this information to either permit or prevent the user from accessing data through the application. You can use application contexts to authenticate both database and non-database users.

Related Topics

- [Extending Unified Auditing to Capture Custom Attributes](#)
You can extend the unified audit trail to capture custom attributes by auditing application context values.

13.1.2 Components of the Application Context

An application context has two components, comprising a name-value pair.

These components are as follows:

- **Name.** Refers to the name of the attribute set that is associated with the value. For example, if the `empno_ctx` application context retrieves an employee ID from the `HR.EMPLOYEES` table, it could have a name such as `employee_id`.
- **Value.** Refers to a value set by the attribute. For example, for the `empno_ctx` application context, if you wanted to retrieve an employee ID from the `HR.EMPLOYEES` table, you could create a value called `emp_id` that sets the value for this ID.

Think of an application context as a global variable that holds information that is accessed during a database session. To set the values for a secure application context, you must create a PL/SQL package procedure that uses the `DBMS_SESSION.SET_CONTEXT` procedure. In fact, this is the only way that you can set application context values if the context is not marked `INITIALIZED EXTERNALLY` or `INITIALIZED GLOBALLY`. You can assign the values to the application context attributes at run time, not when you create the application context. Because the **trusted** procedure, and not the user, assigns the values, it is called secure application context. For client-session based application contexts, another way to set the application context is to use Oracle Call Interface (OCI) calls.

13.1.3 Where Are the Application Context Values Stored?

Oracle Database stores the application context values in a secure data cache.

This cache is available in the User Global Area (UGA) or the System (sometimes called "Shared") Global Area (SGA). This way, the application context values are retrieved during the session. Because the application context stores the values in this data cache, it increases performance for your applications. You can use an application context by itself, with Oracle Virtual Private Databases policies, or with other fine-grained access control policies.

Related Topics

- [Oracle Virtual Private Database Use with an Application Context](#)
You can use application contexts with Oracle Virtual Private Database policies.

13.1.4 Benefits of Using Application Contexts

Most applications contain the kind of information that can be used for application contexts.

For example, in an order entry application that uses a table containing the columns `ORDER_NUMBER` and `CUSTOMER_NUMBER`, you can use the values in these columns as security attributes to restrict access by a customer to their own orders, based on the ID of that customer.

Application contexts are useful for the following purposes:

- Enforcing fine-grained access control (for example, in Oracle Virtual Private Database policies)
- Preserving user identity across multitier environments
- Enforcing stronger security for your applications, because the application context is controlled by a trusted procedure, not the user
- Increasing performance by serving as a secure data cache for attributes needed by an application for fine-grained auditing or for use in PL/SQL conditional statements or loops

This cache saves the repeated overhead of querying the database each time these attributes are needed. Because the application context stores session data in cache rather than forcing your applications to retrieve this data repeatedly from a table, it greatly improves the performance of your applications.

- Serving as a holding area for name-value pairs that an application can define, modify, and access

13.1.5 How Editions Affects Application Context Values

Oracle Database sets the application context in all editions that are affected by the application context package.

The values the application context sets are visible in all editions the application context affects. To find all editions in your database, and whether they are usable, you can query the `ALL_EDITIONS` data dictionary view.

Related Topics

- *Oracle Database Development Guide*

13.1.6 Application Contexts in a Multitenant Environment

Where you create an application in a multitenant environment determines where you must create the application context.

If an application is installed in the application root or CDB root, then it becomes accessible across the application container or system container and associated application PDBs. You will need to create a common application context in this root.

When you create a common application context for use with an application container, note the following:

- You can create application contexts by setting the `CONTAINER` clause in the `CREATE CONTEXT` SQL statement. For example, to create a common application context in the application root, you must run `CREATE CONTEXT` with `CONTAINER` set to `ALL`. To create the application context in a PDB, set `CONTAINER` to `CURRENT`.
- You cannot use the same name for a local application context for a common application context. You can find the names of existing application contexts by running the following query:

```
SELECT OBJECT_NAME FROM DBA_OBJECTS WHERE OBJECT_TYPE = 'CONTEXT';
```

- The PL/SQL package that you create to manage a common application context must be a common PL/SQL package. That is, it must exist in the application root or CDB root. If you create the application context for a specific PDB, then you must store the associated PL/SQL package in that PDB.
- The name-value pairs that you set under a common session application context from an application container or a system container for a common application context are not accessible from other application containers or system containers when a common user accesses a different container.
- The name-value pairs that you set under a common global application context from an application container or a system container, are accessible only within the same container in the same user session.
- An application can retrieve the value of an application context whether it resides in the application root, the CDB root, or a PDB.
- During a plug-in operation of a PDB into a CDB or an application container, if the name of the common application context conflicts with a PDB's local application context, then the PDB must open in restricted mode. A database administrator would then need to correct the conflict before opening the PDB in normal mode.
- During an unplug operation, a common application context retains its common semantics, so that later on, if the PDB is plugged into another CDB where a common application context with the same name exists, it would continue to behave like a common object. If a PDB is plugged into an application container or a system container, where the same common application context does not exist, then it behaves like a local object.

To find if an application context is a local application context or an application common application context, query the `SCOPE` column of the `DBA_CONTEXT` or `ALL_CONTEXT` data dictionary view.

13.2 Types of Application Contexts

There are three general categories of application contexts.

These categories are as follows:

- **Database session-based application contexts.** This type retrieves data that is stored in the database user session (that is, the UGA) cache. There are three categories of database session-based application contexts:
 - **Initialized locally.** Initializes the application context locally, to the session of the user.
 - **Initialized externally.** Initializes the application context from an Oracle Call Interface (OCI) application, a job queue process, or a connected user database link.
 - **Initialized globally.** Uses attributes and values from a centralized location, such as an LDAP directory.

- **Global application contexts.** This type retrieves data that is stored in the System Global Area (SGA) so that it can be used for applications that use a sessionless model, such as middle-tier applications in a three-tiered architecture. A global application context is useful if the session context must be shared across sessions, for example, through connection pool implementations.
- **Client session-based application contexts.** This type uses Oracle Call Interface functions on the client side to set the user session data, and then to perform the necessary security checks to restrict user access.

Table 13-1 summarizes the different types of application contexts.

Table 13-1 Types of Application Contexts

Application Context Type	Stored in UGA	Stored in SGA	Supports Connected User Database Links	Supports Centralized Storage of Users' Application Context	Supports Sessionless Multitier Applications
Database session-based application context initialized locally	Yes	No	No	No	No
Database session-based application context initialized externally	Yes	No	Yes	No	No
Database session-based application context initialized globally	Yes	No	No	Yes	No
Global application context	No	Yes	No	No	Yes
Client session-based application context	Yes	No	Yes	No	Yes

Related Topics

- [Using Database Session-Based Application Contexts](#)
A database session-based application context enables you to retrieve session-based information about a user.
- [Global Application Contexts](#)
You can use a global application context to access application values across database sessions, including an Oracle Real Application Clusters environment.
- [Using Client Session-Based Application Contexts](#)
A client session-based application context is stored in the User Global Area (UGA).

13.3 Using Database Session-Based Application Contexts

A database session-based application context enables you to retrieve session-based information about a user.

- [About Database Session-Based Application Contexts](#)
A database session-based application context retrieves session information for database users.
- [Components of a Database Session-Based Application Context](#)
A database session-based application context retrieves and sets data for the context and then sets this context when a user logs in.

- [Creating Database Session-Based Application Contexts](#)
A database session-based application context is a named object that stores the user's session information.
- [Creating a Package to Set a Database Session-Based Application Context](#)
A PL/SQL package can be used to retrieve the session information and set the name-value attributes of the application context.
- [Logon Triggers to Run a Database Session Application Context Package](#)
Users must run database session application context package after when they log in to the database instance.
- [Example: Creating a Simple Logon Trigger](#)
The `CREATE TRIGGER` statement can create a simple logon trigger.
- [Example: Creating a Logon Trigger for a Production Environment](#)
The `CREATE TRIGGER` statement can create a logon trigger for a production environment.
- [Example: Creating a Logon Trigger for a Development Environment](#)
The `CREATE TRIGGER` statement can create a logon trigger for a development environment.
- [Tutorial: Creating and Using a Database Session-Based Application Context](#)
This tutorial demonstrates how to create an application context that checks the ID of users who try to log in to the database.
- [Initializing Database Session-Based Application Contexts Externally](#)
Initializing database session-based application contexts externally increases performance because the application context is stored in the user global area (UGA).
- [Initializing Database Session-Based Application Contexts Globally](#)
When a database session-based application is stored in a centralized location, it can be used globally from an LDAP directory.
- [Externalized Database Session-Based Application Contexts](#)
Many applications store attributes used for fine-grained access control within a database metadata table.

13.3.1 About Database Session-Based Application Contexts

A database session-based application context retrieves session information for database users.

This type of application context uses a PL/SQL procedure within Oracle Database to retrieve, set, and secure the data it manages.

The database session-based application context is managed entirely within Oracle Database. Oracle Database sets the values, and then when the user exits the session, automatically clears the application context values stored in cache. If the user connection ends abnormally, for example, during a power failure, then the PMON background process cleans up the application context data. You do not need to explicitly clear the application context from cache.

The advantage of having Oracle Database manage the application context is that you can centralize the application context management. Any application that accesses this database will need to use this application context to permit or prevent user access to that application. This provides benefits both in improved performance and stronger security.

**Note:**

If your users are application users, that is, users who are not in your database, consider using a global application context instead.

Related Topics

- [Global Application Contexts](#)
You can use a global application context to access application values across database sessions, including an Oracle Real Application Clusters environment.

13.3.2 Components of a Database Session-Based Application Context

A database session-based application context retrieves and sets data for the context and then sets this context when a user logs in.

You must use three components to create and use a database session-based application context: the application context, a procedure to retrieve the data and set the context, and a way to set the context when the user logs in.

- **The application context.** You use the `CREATE CONTEXT` SQL statement to create an application context. This statement names the application context (namespace) and associates it with a PL/SQL procedure that is designed to retrieve session data and set the application context.
- **A PL/SQL procedure to perform the data retrieval and set the context.** Ideally, create this procedure within a package, so that you can include other procedures if you want (for example, to perform error checking tasks).
- **A way to set the application context when the user logs on.** Users who log on to applications that use the application context must run a PL/SQL package that sets the application context. You can achieve this with either a logon trigger that fires each time the user logs on, or you can embed this functionality in your applications.

In addition, you can initialize session-based application contexts either externally or globally. Either method stores the context information in the user session.

- **External initialization.** This type can come from an OCI interface, a job queue process, or a connected user database link.
- **Global initialization.** This type uses attributes and values from a centralized location, such as an LDAP directory.

Related Topics

- [About the Package That Manages the Database Session-Based Application Context](#)
This defines procedures that manage the session data represented by the application context.
- [Tutorial: Creating and Using a Database Session-Based Application Context](#)
This tutorial demonstrates how to create an application context that checks the ID of users who try to log in to the database.
- [Initializing Database Session-Based Application Contexts Externally](#)
Initializing database session-based application contexts externally increases performance because the application context is stored in the user global area (UGA).

- [Initializing a Database Session-Based Application Context Globally](#)
You can configure and store the initial application context for a user, such as the department name and title, in the LDAP directory.

13.3.3 Creating Database Session-Based Application Contexts

A database session-based application context is a named object that stores the user's session information.

- [About Creating Database Session-Based Application Contexts](#)
A database user session (UGA) stores session-based application context, using a user-created namespace.
- [Creating a Database Session-Based Application Context](#)
The `CREATE CONTEXT` SQL statement can be used to create a database session-based application context.
- [Database Session-Based Application Contexts for Multiple Applications](#)
For each application, you can create an application context that has its own attributes.

13.3.3.1 About Creating Database Session-Based Application Contexts

A database user session (UGA) stores session-based application context, using a user-created namespace.

Each application context must have a unique attribute and belong to a namespace. That is, context names must be unique within the database, not just within a schema.

You must have the `CREATE ANY CONTEXT` system privilege to create an application context, and the `DROP ANY CONTEXT` privilege to use the `DROP CONTEXT` statement if you want to drop the application context.

The ownership of the application context is as follows: Even though a user who has been granted the `CREATE ANY CONTEXT` and `DROP ANY CONTEXT` privileges can create and drop the application context, it is owned by the `SYS` schema. Oracle Database associates the context with the schema account that created it, but if you drop this user, the context still exists in the `SYS` schema. As user `SYS`, you can drop the application context.

You can find the names of existing application contexts by running the following query:

```
SELECT OBJECT_NAME FROM DBA_OBJECTS WHERE OBJECT_TYPE = 'CONTEXT';
```

13.3.3.2 Creating a Database Session-Based Application Context

The `CREATE CONTEXT` SQL statement can be used to create a database session-based application context.

When you create a database session-based application context, you must create a namespace for the application context and then associate it with a PL/SQL package that manages the name-value pair that holds the session information of the user. At the time that you create the context, the PL/SQL package does not need to exist, but it must exist at run time.

- To create a database session-based application context, use the `CREATE CONTEXT` SQL statement.

For example:

```
CREATE CONTEXT empno_ctx USING set_empno_ctx_pkg CONTAINER = CURRENT;
```

In this example:

- `empno_ctx` is the context namespace.
- `set_empno_ctx_pkg` is the package (which does not need to exist when you create the context) that sets attributes for the `empno_ctx` namespace.
- `CONTAINER` creates the application context in the current PDB. To create the application context in the application or CDB root, you must set `CONTAINER` to `ALL`.

Notice that when you create the context, you do not set its name-value attributes in the `CREATE CONTEXT` statement. Instead, you set these in the PL/SQL package that you associate with the application context. The reason you must do this is to prevent a malicious user from changing the context attributes without proper attribute validation. Ensure that this package is in the same container as the application context. For example, if you created the application context in a PDB, then the PL/SQL package must reside in that PDB.

You cannot create a context called `CLIENTCONTEXT`. This word is reserved for use with client session-based application contexts.

Related Topics

- [Step 3: Create a Package to Retrieve Session Data and Set the Application Context](#)
Next, you must create a PL/SQL package that retrieves the session data and then sets the application context.

13.3.3.3 Database Session-Based Application Contexts for Multiple Applications

For each application, you can create an application context that has its own attributes.

Suppose, for example, you have three applications: General Ledger, Order Entry, and Human Resources.

You can specify different attributes for each application:

- For the order entry application context, you could specify the attribute `CUSTOMER_NUMBER`.
- For the general ledger application context, you could specify the attributes `SET_OF_BOOKS` and `TITLE`.
- For the human resources application context, you could specify the attributes `ORGANIZATION_ID`, `POSITION`, and `COUNTRY`.

The data the attributes access is stored in the tables behind the applications. For example, the order entry application uses a table called `OE.CUSTOMERS`, which contains the `CUSTOMER_NUMBER` column, which provides data for the `CUSTOMER_NUMBER` attribute. In each case, you can adapt the application context to your precise security needs.

13.3.4 Creating a Package to Set a Database Session-Based Application Context

A PL/SQL package can be used to retrieve the session information and set the name-value attributes of the application context.

- [About the Package That Manages the Database Session-Based Application Context](#)
This defines procedures that manage the session data represented by the application context.
- [Using the `SYS_CONTEXT` Function to Retrieve Session Information](#)
You can retrieve session information for the application context by using the `SYS_CONTEXT` function.

- [Checking the SYS_CONTEXT Settings](#)
You can check the `SYS_CONTEXT` settings by calling the function in any query
- [Dynamic SQL with SYS_CONTEXT](#)
During a session in which you expect a change in policy between executions of a given query, the query must use dynamic SQL.
- [SYS_CONTEXT in a Parallel Query](#)
If you use `SYS_CONTEXT` inside a SQL function that is embedded in a parallel query, then the function includes the application context.
- [SYS_CONTEXT with Database Links](#)
The `SYS_CONTEXT` function is compatible with the use of database links.
- [DBMS_SESSION.SET_CONTEXT for Setting Session Information](#)
After `SYS_CONTEXT` retrieves the session data of a user, you can set the application context values from the user session.
- [Example: Simple Procedure to Create an Application Context Value](#)
You can use the `DBMS_SESSION.SET_CONTEXT` statement in a procedure to set an application context value.

13.3.4.1 About the Package That Manages the Database Session-Based Application Context

This defines procedures that manage the session data represented by the application context.

This package is usually created in the security administrator schema. The package must perform the following tasks:

- **Retrieve session information.** To retrieve the user session information, you can use the `SYS_CONTEXT` SQL function. The `SYS_CONTEXT` function returns the value of the parameter associated with the context namespace. You can use this function in both SQL and PL/SQL statements. Typically, you will use the built-in `USERENV` namespace to retrieve the session information of a user. You also can use the `SYS_SESSION_ROLES` namespace to indicate whether the specified role is currently enabled for the session.
- **Set the name-value attributes of the application context you created with CREATE CONTEXT.** You can use the `DBMS_SESSION.SET_CONTEXT` procedure to set the name-value attributes of the application context. The name-value attributes can hold information such as the user ID, IP address, authentication mode, the name of the application, and so on. The values of the attributes you set remain either until you reset them, or until the user ends the session. Note the following:
 - If the value of the parameter in the namespace already has been set, then `SET_CONTEXT` overwrites this value.
 - Be aware that any changes in the context value are reflected immediately and subsequent calls to access the value through the `SYS_CONTEXT` function will return the most recent value.
- **Be run by users.** After you create the package, the user will need to run the package when they log on. You can create a logon trigger to run the package automatically when the user logs on, or you can embed this functionality in your applications. Remember that the application context session values are cleared automatically when the user ends the session, so you do not need to manually remove the session data.

It is important to remember that the procedure is a trusted procedure: It is designed to prevent the user from setting their own application context attribute values. The user runs the procedure, but the procedure sets the application context values, not the user.

Related Topics

- [Tutorial: Creating and Using a Database Session-Based Application Context](#)
This tutorial demonstrates how to create an application context that checks the ID of users who try to log in to the database.
- *Oracle Database SQL Language Reference*

13.3.4.2 Using the SYS_CONTEXT Function to Retrieve Session Information

You can retrieve session information for the application context by using the `SYS_CONTEXT` function.

The `SYS_CONTEXT` function provides a default namespace, `USERENV`, which describes the current session of the user logged on. `SYS_CONTEXT` enables you to retrieve different types of session-based information about a user, such as the user host computer ID, host IP address, operating system user name, and so on. Remember that you only use `USERENV` to *retrieve* session data, not set it.

- To use retrieve session information, set the namespace, parameter, and optionally, the length values of the `SYS_CONTEXT` function.

For example:

```
SYS_CONTEXT ('USERENV','HOST')
```

The syntax for the PL/SQL function `SYS_CONTEXT` is as follows:

```
SYS_CONTEXT ('namespace', 'parameter' [, length])
```

In this specification:

- *namespace* is the name of the application context. You can specify either a string or an expression that evaluates to a string. The `SYS_CONTEXT` function returns the value of parameter associated with the context namespace at the current instant. If the value of the parameter in the namespace already has been set, then `SET_CONTEXT` overwrites this value.
- *parameter* is a parameter within the *namespace* application context. This value can be a string or an expression.
- *length* is the default maximum size of the return type, which is 256 bytes, but you can override the length by specifying a value up to 4000 bytes. Enter a value that is a `NUMBER` data type, or a value that can be implicitly converted to `NUMBER`. The data type of the `SYS_CONTEXT` return type is a `VARCHAR2`. This setting is optional.

Note:

The `USERENV` application context namespace replaces the `USERENV` function provided in earlier Oracle Database releases.

Related Topics

- *Oracle Database SQL Language Reference*

13.3.4.3 Checking the SYS_CONTEXT Settings

You can check the `SYS_CONTEXT` settings by calling the function in any query

To check the `SYS_CONTEXT` settings, issue a `SELECT` SQL statement of the function.

For example, to find the host computer on which you are logged, assuming that you are logged on to the `SHOBEEEN_PC` host computer under `EMP_USERS`:

```
SELECT SYS_CONTEXT ('USERENV', 'HOST');

SYS_CONTEXT (USERENV,HOST)
-----
EMP_USERS\SHOBEEEN_PC
```

13.3.4.4 Dynamic SQL with SYS_CONTEXT

During a session in which you expect a change in policy between executions of a given query, the query must use dynamic SQL.

You must use dynamic SQL because static SQL and dynamic SQL parse statements differently:

- Static SQL statements are parsed at compile time. They are not parsed again at execution time for performance reasons.
- Dynamic SQL statements are parsed every time they are run.

Consider a situation in which Policy A is in force when you compile a SQL statement, and then you switch to Policy B and run the statement. With static SQL, Policy A remains in force. Oracle Database parses the statement at compile time, but does not parse it again upon execution. With dynamic SQL, Oracle Database parses the statement upon execution, then the switch to Policy B takes effect.

For example, consider the following policy:

```
EMPLOYEE_NAME = SYS_CONTEXT ('USERENV', 'SESSION_USER')
```

The policy `EMPLOYEE_NAME` matches the database user name. It is represented in the form of a SQL predicate in Oracle Virtual Private Database: the predicate is considered a policy. If the predicate changes, then the statement must be parsed again to produce the correct result.

Related Topics

- [Automatic Reparsing for Fine-Grained Access Control Policies Functions](#)
Queries against objects enabled with fine-grained access control run the policy function so that the most current predicate is used for each policy.

13.3.4.5 SYS_CONTEXT in a Parallel Query

If you use `SYS_CONTEXT` inside a SQL function that is embedded in a parallel query, then the function includes the application context.

Consider a user-defined function within a SQL statement, which sets the user ID to 5:

```
CREATE FUNCTION set_id
RETURN NUMBER IS
BEGIN
  IF SYS_CONTEXT ('hr', 'id') = 5
    THEN RETURN 1; ELSE RETURN 2;
```

```
END IF;
END;
```

Now consider the following statement:

```
SELECT * FROM emp WHERE set_id( ) = 1;
```

When this statement is run as a parallel query, the user session, which contains the application context information, is propagated to the parallel execution servers (query child processes).

13.3.4.6 SYS_CONTEXT with Database Links

The `SYS_CONTEXT` function is compatible with the use of database links.

When SQL statements within a user session involve database links, Oracle Database runs the `SYS_CONTEXT` function at the host computer of the database link, and then captures the context information in the host computer.

If remote PL/SQL procedure calls are run on a database link, then Oracle Database runs any `SYS_CONTEXT` function inside such a procedure at the destination database of the link.

In this case, only externally initialized application contexts are available at the database link destination site. For security reasons, Oracle Database propagates only the externally initialized application context information to the destination site from the initiating database link site.

13.3.4.7 DBMS_SESSION.SET_CONTEXT for Setting Session Information

After `SYS_CONTEXT` retrieves the session data of a user, you can set the application context values from the user session.

To set the context values, you can use the `DBMS_SESSION.SET_CONTEXT` procedure. You must have the `EXECUTE` privilege for the `DBMS_SESSION` PL/SQL package.

The syntax for `DBMS_SESSION.SET_CONTEXT` is as follows:

```
DBMS_SESSION.SET_CONTEXT (
  namespace VARCHAR2,
  attribute  VARCHAR2,
  value     VARCHAR2,
  username  VARCHAR2,
  client_id VARCHAR2);
```

In this specification:

- `namespace` is the namespace of the application context to be set, limited to 30 bytes. For example, if you were using a namespace called `custno_ctx`, you would specify it as follows:

```
namespace => 'custno_ctx',
```
- `attribute` is the attribute of the application context to be set, limited to 30 bytes. For example, to create the `ctx_attrib` attribute for the `custno_ctx` namespace:

```
attribute => 'ctx_attrib',
```
- `value` is the value of the application context to be set, limited to 4000 bytes. Typically, this is the value retrieved by the `SYS_CONTEXT` function and stored in a variable. For example:

```
value => ctx_value,
```

- `username` is the database user name attribute of the application context. The default is `NULL`, which permits any user to access the session. For database session-based application contexts, omit this setting so that it uses the `NULL` default. This setting is optional.

The `username` and `client_id` parameters are used for globally accessed application contexts.

- `client_id` is the application-specific `client_id` attribute of the application context (64-byte maximum). The default is `NULL`, which means that no client ID is specified. For database session-based application contexts, omit this setting so that it uses the `NULL` default.

Related Topics

- [Tutorial: Creating and Using a Database Session-Based Application Context](#)
This tutorial demonstrates how to create an application context that checks the ID of users who try to log in to the database.
- *Oracle Database PL/SQL Packages and Types Reference*

13.3.4.8 Example: Simple Procedure to Create an Application Context Value

You can use the `DBMS_SESSION.SET_CONTEXT` statement in a procedure to set an application context value.

[Example 13-1](#) shows how to create a simple procedure that creates an attribute for the `empno_ctx` application context.

Example 13-1 Simple Procedure to Create an Application Context Value

```
CREATE OR REPLACE PROCEDURE set_empno_ctx_proc (
  emp_value IN VARCHAR2)
IS
BEGIN
  DBMS_SESSION.SET_CONTEXT('empno_ctx', 'empno_attr', emp_value);
END;
/
```

In this example:

- `emp_value IN VARCHAR2` takes `emp_value` as the input parameter. This parameter specifies the value associated with the application context attribute `empno_attr`. The limit is 4000 bytes.
- `DBMS_SESSION.SET_CONTEXT('empno_ctx', 'empno_attr', emp_value)` sets the value of the application context by using the `DBMS_SESSION.SET_CONTEXT` procedure as follows:
 - `'empno_ctx'` refers to the application context namespace. Enclose its name in single quotation marks.
 - `'empno_attr'` creates the attribute associated with the application context namespace.
 - `emp_value` specifies the value for the `empno_attr` attribute. Here, it refers to the `emp_value` parameter.

At this stage, you can run the `set_empno_ctx_proc` procedure to set the application context:

```
EXECUTE set_empno_ctx_proc ('42783');
```

(In a real world scenario, you would set the application context values in the procedure itself, so that it becomes a trusted procedure. This example is only used to show how data can be set for demonstration purposes.)

To check the application context setting, run the following `SELECT` statement:

```
SELECT SYS_CONTEXT ('empno_ctx', 'empno_attrib') empno_attrib FROM DUAL;
```

```
EMPNO_ATTRIB
-----
42783
```

You can also query the `SESSION_CONTEXT` data dictionary view to find all the application context settings in the current session of the database instance. For example:

```
SELECT * FROM SESSION_CONTEXT;
```

```
NAMESPACE          ATTRIBUTE          VALUE
-----
EMPNO_CTX           EMP_ID            42783
```

13.3.5 Logon Triggers to Run a Database Session Application Context Package

Users must run database session application context package after when they log in to the database instance.

You can create a logon trigger that handles this automatically. You do not need to grant the user `EXECUTE` permissions to run the package.

Note the following:

- **If the PL/SQL package procedure called by the logon trigger has any unhandled exceptions or raises any exceptions (because, for example, a security check failed), then the logon trigger fails.** When the logon trigger fails, the logon fails, that is, the user is denied permission to log in to the database.
- **Logon triggers may affect performance.** In addition, test the logon trigger on a sample schema user first before creating it for the database. That way, if there is an error, you can easily correct it.
- **Be aware of situations in which if you have a changing set of books, or if positions change constantly.** In these cases, the new attribute values may not be picked up right away, and you must force a cursor reparse to pick them up.



Note:

A logon trigger can be used because the user context (information such as `EMPNO`, `GROUP`, `MANAGER`) should be set before the user accesses any data.

13.3.6 Example: Creating a Simple Logon Trigger

The `CREATE TRIGGER` statement can create a simple logon trigger.

[Example 13-2](#) shows a simple logon trigger that runs a PL/SQL procedure.

Example 13-2 Creating a Simple Logon Trigger

```
CREATE OR REPLACE TRIGGER set_empno_ctx_trig AFTER LOGON ON DATABASE
BEGIN
  sec_mgr.set_empno_ctx_proc;
END;
```

13.3.7 Example: Creating a Logon Trigger for a Production Environment

The `CREATE TRIGGER` statement can create a logon trigger for a production environment.

[Example 13-3](#) shows how to create a logon trigger that uses a `WHEN OTHERS` exception. Otherwise, if there is an error in the PL/SQL logic that creates an unhandled exception, then all connections to the database are blocked.

This example shows a `WHEN OTHERS` exception that writes errors to a table in the security administrator's schema. In a production environment, this is safer than sending the output to the user session, where it could be vulnerable to security attacks.

Example 13-3 Creating a Logon Trigger for a Production Environment

```
CREATE OR REPLACE TRIGGER set_empno_ctx_trig AFTER LOGON ON DATABASE
BEGIN
  sec_mgr.set_empno_ctx_proc;
EXCEPTION
  WHEN OTHERS THEN
    v_code := SQLCODE;
    v_errm := SUBSTR(SQLERRM, 1, 64);
    -- Invoke another procedure,
    -- declared with PRAGMA AUTONOMOUS_TRANSACTION,
    -- to insert information about errors.
    INSERT INTO sec_mgr.errors VALUES (v_code, v_errm, SYSTIMESTAMP);
END;
/
```

13.3.8 Example: Creating a Logon Trigger for a Development Environment

The `CREATE TRIGGER` statement can create a logon trigger for a development environment.

[Example 13-4](#) shows how to create the same logon trigger for a development environment, in which you may want to output errors the user session for debugging purposes.

Example 13-4 Creating a Logon Trigger for a Development Environment

```
CREATE TRIGGER set_empno_ctx_trig
AFTER LOGON ON DATABASE
BEGIN
  sysadmin_ctx.set_empno_ctx_pkg.set_empno;
EXCEPTION
  WHEN OTHERS THEN
    RAISE_APPLICATION_ERROR(
      -20000, 'Trigger sysadmin_ctx.set_empno_ctx_trig violation. Login denied.');
```

13.3.9 Tutorial: Creating and Using a Database Session-Based Application Context

This tutorial demonstrates how to create an application context that checks the ID of users who try to log in to the database.

- **Step 1: Create User Accounts and Ensure the User SCOTT Is Active**
To begin this tutorial, you must create the necessary database accounts and ensure that the `SCOTT` user account is active.
- **Step 2: Create the Database Session-Based Application Context**
As the `sysadmin_ctx` user, you are ready to create the database session-based application context.
- **Step 3: Create a Package to Retrieve Session Data and Set the Application Context**
Next, you must create a PL/SQL package that retrieves the session data and then sets the application context.
- **Step 4: Create a Logon Trigger for the Package**
The logon trigger will run when the user logs in.
- **Step 5: Test the Application Context**
Now that the components are all in place, you are ready to test the application context.
- **Step 6: Remove the Components of This Tutorial**
If you no longer need the components of this tutorial, then you can remove them.

13.3.9.1 Step 1: Create User Accounts and Ensure the User SCOTT Is Active

To begin this tutorial, you must create the necessary database accounts and ensure that the `SCOTT` user account is active.

1. Log in to a PDB as user `SYS` and connect using the `SYSDBA` administrative privilege.

```
sqlplus sys@pdb_name as sysdba
Enter password: password
```

To find the available PDBs in a CDB, log in to the CDB root container and then query the `PDB_NAME` column of the `DBA_PDBS` data dictionary view. To check the current container, run the `show con_name` command.

2. Create the local user account `sysadmin_ctx`, who will administer the database session-based application context.

```
CREATE USER sysadmin_ctx IDENTIFIED BY password;
GRANT CREATE SESSION, CREATE ANY CONTEXT, CREATE PROCEDURE, CREATE TRIGGER,
ADMINISTER DATABASE TRIGGER TO sysadmin_ctx;
GRANT READ ON HR.EMPLOYEES TO sysadmin_ctx;
GRANT EXECUTE ON DBMS_SESSION TO sysadmin_ctx;
```

Replace `password` with a password that is secure.

3. Create the following user account for Lisa Ozer, who is listed as having `lozer` for their email account in the `HR.EMPLOYEES` table.

```
GRANT CREATE SESSION TO LOZER IDENTIFIED BY password;
```

Replace `password` with a password that is secure.

- The sample user `SCOTT` will also be used in this tutorial, so query the `DBA_USERS` data dictionary view to ensure that the account status for `SCOTT` is `OPEN`.

```
SELECT USERNAME, ACCOUNT_STATUS FROM DBA_USERS WHERE USERNAME = 'SCOTT';
```

If the `DBA_USERS` view lists user `SCOTT` as locked and expired, then enter the following statement to unlock the `SCOTT` account and create a new password for him:

```
ALTER USER SCOTT ACCOUNT UNLOCK IDENTIFIED BY password;
```

Enter a password that is secure. For greater security, do **not** give the `SCOTT` account the same password from previous releases of Oracle Database.

Related Topics

- [Guidelines for Securing Passwords](#)
Oracle provides guidelines for securing passwords in a variety of situations.

13.3.9.2 Step 2: Create the Database Session-Based Application Context

As the `sysadmin_ctx` user, you are ready to create the database session-based application context.

- Connect to the PDB as `sysadmin_ctx`.

```
CONNECT sysadmin_ctx@pdb_name
Enter password: password
```

- Create the application context using the following statement:

```
CREATE CONTEXT empno_ctx USING set_empno_ctx_pkg;
```

Remember that even though user `sysadmin_ctx` has created this application context, the `SYS` schema owns the context.

13.3.9.3 Step 3: Create a Package to Retrieve Session Data and Set the Application Context

Next, you must create a PL/SQL package that retrieves the session data and then sets the application context.

- To create the package, use the `CREATE OR REPLACE PACKAGE` statement.

[Example 13-5](#) shows how to create the package you need to retrieve the session data and set the application context. Before creating the package, ensure that you are still logged on as user `sysadmin_ctx`.

Example 13-5 Package to Retrieve Session Data and Set a Database Session Context

```
CREATE OR REPLACE PACKAGE set_empno_ctx_pkg IS
  PROCEDURE set_empno;
END;
/
CREATE OR REPLACE PACKAGE BODY set_empno_ctx_pkg IS
  PROCEDURE set_empno
  IS
    emp_id HR.EMPLOYEES.EMPLOYEE_ID%TYPE;
  BEGIN
    SELECT EMPLOYEE_ID INTO emp_id FROM HR.EMPLOYEES
```

```

        WHERE email = SYS_CONTEXT('USERENV', 'SESSION_USER');
        DBMS_SESSION.SET_CONTEXT('empno_ctx', 'employee_id', emp_id);
    EXCEPTION
        WHEN NO_DATA_FOUND THEN NULL;
    END;
END;
/

```

This package creates a procedure called `set_empno` that performs the following actions:

- `emp_id HR.EMPLOYEES.EMPLOYEE_ID%TYPE` declares a variable, `emp_id`, to store the employee ID for the user who logs on. It uses the same data type as the `EMPLOYEE_ID` column in `HR.EMPLOYEES`.
- `SELECT EMPLOYEE_ID INTO emp_id FROM HR.EMPLOYEES` performs a `SELECT` statement to copy the employee ID that is stored in the `employee_id` column data from the `HR.EMPLOYEES` table into the `emp_id` variable.
- `WHERE email = SYS_CONTEXT('USERENV', 'SESSION_USER')` uses a `WHERE` clause to find all employee IDs that match the email account for the session user. The `SYS_CONTEXT` function uses the predefined `USERENV` context to retrieve the user session ID, which is the same as the `email` column data. For example, the user ID and email address for Lisa Ozer are both the same: `lozer`.
- `DBMS_SESSION.SET_CONTEXT('empno_ctx', 'employee_id', emp_id)` uses the `DBMS_SESSION.SET_CONTEXT` procedure to set the application context:
 - `'empno_ctx'`: Calls the application context `empno_ctx`. Enclose `empno_ctx` in single quotes.
 - `'employee_id'`: Creates the attribute value of the `empno_ctx` application context name-value pair, by naming it `employee_id`. Enclose `employee_id` in single quotes.
 - `emp_id`: Sets the value for the `employee_id` attribute to the value stored in the `emp_id` variable.

To summarize, the `set_empno_ctx_pkg.set_empno` procedure says, "Get the session ID of the user and then match it with the employee ID and email address of any user listed in the `HR.EMPLOYEES` table."

- `EXCEPTION ... WHEN_NO_DATA_FOUND` adds a `WHEN_NO_DATA_FOUND` system exception to catch any no data found errors that may result from the `SELECT` statement. Without this exception, the package and logon trigger will work fine and set the application context as needed, but then any non-system administrator users other than the users listed in the `HR.EMPLOYEES` table will not be able to log in to the database. Other users should be able to log in to the database, assuming they are valid database users. Once the application context information is set, then you can use this session information as a way to control user access to a particular application.

13.3.9.4 Step 4: Create a Logon Trigger for the Package

The logon trigger will run when the user logs in.

- As user `sysadmin_ctx`, create a logon trigger for `set_empno_ctx_pkg.set_empno` package procedure.

```

CREATE TRIGGER set_empno_ctx_trig AFTER LOGON ON DATABASE
BEGIN
    sysadmin_ctx.set_empno_ctx_pkg.set_empno;

```

```
END;
/
```

13.3.9.5 Step 5: Test the Application Context

Now that the components are all in place, you are ready to test the application context.

1. Connect as user `lozer`.

```
CONNECT lozer@pdb_name
Enter password: password
```

When user `lozer` logs on, the `empno_ctx` application context collects their employee ID. You can check it as follows:

```
SELECT SYS_CONTEXT('empno_ctx', 'employee_id') emp_id FROM DUAL;
```

The following output should appear:

```
EMP_ID
-----
168
```

2. Connect as user `SCOTT`.

```
CONNECT SCOTT@pdb_name
Enter password: password
```

User `SCOTT` is not listed as an employee in the `HR.EMPLOYEES` table, so the `empno_ctx` application context cannot collect an employee ID for him.

```
SELECT SYS_CONTEXT('empno_ctx', 'employee_id') emp_id FROM DUAL;
```

The following output should appear:

```
EMP_ID
-----
```

From here, the application can use the user session information to determine how much access the user can have in the database. You can use Oracle Virtual Private Database to accomplish this. .

Related Topics

- [Using Oracle Virtual Private Database to Control Data Access](#)
Oracle Virtual Private Database (VPD) enables you to filter users who access data.

13.3.9.6 Step 6: Remove the Components of This Tutorial

If you no longer need the components of this tutorial, then you can remove them.

1. Connect as `SYS` with the `SYSDBA` administrative privilege.

```
CONNECT SYS@pdb_name AS SYSDBA
Enter password: password
```

2. Drop the users `sysadmin_ctx` and `lozer`:

```
DROP USER sysadmin_ctx CASCADE;
DROP USER lozer;
```

3. Drop the application context.

```
DROP CONTEXT empno_ctx;
```

Remember that even though `sysadmin_ctx` created the application context, it is owned by the `SYS` schema.

4. If you want, lock and expire `SCOTT`, unless other users want to use this account:

```
ALTER USER SCOTT PASSWORD EXPIRE ACCOUNT LOCK;
```

13.3.10 Initializing Database Session-Based Application Contexts Externally

Initializing database session-based application contexts externally increases performance because the application context is stored in the user global area (UGA).

- [About Initializing Database Session-Based Application Contexts Externally](#)
You must use a special type of namespace to initialize session-based application context externally.
- [Default Values from Users](#)
Oracle Database enables you to capture and use default values from users for your applications.
- [Values from Other External Resources](#)
An application context can accept the initialization of attributes and values through external resources.
- [Example: Creating an Externalized Database Session-based Application Context](#)
The `CREATE CONTEXT SQL` statement can create an externalized database session-based application context.
- [Initialization of Application Context Values from a Middle-Tier Server](#)
Middle-tier servers can initialize application context values on behalf of database users.

13.3.10.1 About Initializing Database Session-Based Application Contexts Externally

You must use a special type of namespace to initialize session-based application context externally.

This namespace must accept the initialization of attribute values from external resources and then stores them in the local user session.

Initializing an application context externally enhances performance because it is stored in the UGA and enables the automatic propagation of attributes from one session to another. Connected user database links are supported only by application contexts initialized from OCI-based external sources.

13.3.10.2 Default Values from Users

Oracle Database enables you to capture and use default values from users for your applications.

Sometimes you need the default values from users. Initially, these default values may be hints or preferences, and then after validation, they become trusted contexts. Similarly, it may be more convenient for clients to initialize some default values, and then rely on a login event trigger or applications to validate the values.

For job queues, the job submission routine records the context being set at the time the job is submitted, and restores it when executing the batched job. To maintain the integrity of the context, job queues cannot bypass the designated PL/SQL package to set the context. Rather, the externally initialized application context accepts initialization of context values from the job queue process.

Automatic propagation of context to a remote session may create security problems. Developers or administrators can effectively handle the context that takes default values from resources other than the designated PL/SQL procedure by using logon triggers to reset the context when users log in.

13.3.10.3 Values from Other External Resources

An application context can accept the initialization of attributes and values through external resources.

Examples include an Oracle Call Interface (OCI) interface, a job queue process, or a database link.

Externally initialized application contexts provide the following features:

- For remote sessions, automatic propagation of context values that are in the externally initialized application context namespace
- For job queues, restoration of context values that are in the externally initialized application context namespace
- For OCI interfaces, a mechanism to initialize context values that are in the externally initialized application context namespace

Although any client program that is using Oracle Call Interface can initialize this type of namespace, you can use login event triggers to verify the values. It is up to the application to interpret and trust the values of the attributes.

13.3.10.4 Example: Creating an Externalized Database Session-based Application Context

The `CREATE CONTEXT` SQL statement can create an externalized database session-based application context.

[Example 13-6](#) shows how to create a database session-based application context that obtains values from an external source.

Example 13-6 Creating an Externalized Database Session-based Application Context

```
CREATE CONTEXT ext_ctx USING ext_ctx_pkg INITIALIZED EXTERNALLY;
```

13.3.10.5 Initialization of Application Context Values from a Middle-Tier Server

Middle-tier servers can initialize application context values on behalf of database users.

In this process, context attributes are propagated for the remote session at initialization time, and the remote database accepts the values if the namespace is externally initialized.

For example, a three-tier application creating lightweight user sessions through OCI or JDBC/OCI can access the `PROXY_USER` attribute in `USERENV`. This attribute enables you to determine if the user session was created by a middle-tier application. You could allow a user to access data only for connections where the user is proxied. If users connect directly to the database, then they would not be able to access any data.

You can use the `PROXY_USER` attribute from the `USERENV` namespace within Oracle Virtual Private Database to ensure that users only access data through a particular middle-tier application. For a different approach, you can develop a secure application role to enforce your policy that users access the database only through a specific proxy.

Related Topics

- [Preserving User Identity in Multitiered Environments](#)
You can use middle tier servers for proxy authentication and client identifiers to identify application users who are not known to the database.
- [Middle Tier Server Use for Proxy Authentication](#)
Oracle Call Interface (OCI), JDBC/OCI, or JDBC Thin Driver supports the middle tier for proxy authentication for database users or enterprise users.
- *Oracle Call Interface Developer's Guide*

13.3.11 Initializing Database Session-Based Application Contexts Globally

When a database session-based application is stored in a centralized location, it can be used globally from an LDAP directory.

- [About Initializing Database Session-Based Application Contexts Globally](#)
You can use a centralized location to store the database session-based application context of the user.
- [Database Session-Based Application Contexts with LDAP](#)
An application context that is initialized globally uses LDAP, a standard, extensible, and efficient directory access protocol.
- [How Globally Initialized Database Session-Based Application Contexts Work](#)
To use a globally initialized secure application, you must first configure Enterprise User Security.
- [Initializing a Database Session-Based Application Context Globally](#)
You can configure and store the initial application context for a user, such as the department name and title, in the LDAP directory.

13.3.11.1 About Initializing Database Session-Based Application Contexts Globally

You can use a centralized location to store the database session-based application context of the user.

A centralized location enables applications to set up a user context during initialization based upon user identity.

In particular, this feature supports Oracle Label Security labels and privileges. Initializing an application context globally makes it easier to manage contexts for large numbers of users and databases.

For example, many organizations want to manage user information centrally, in an LDAP-based directory. Enterprise User Security supports centralized user and authorization management in Oracle Internet Directory. However, there may be additional attributes an application must retrieve from Lightweight Directory Access Protocol (LDAP) to use for Oracle Virtual Private Database enforcement, such as the user title, organization, or physical location. Initializing an application context globally enables you to retrieve these types of attributes.

 **Note:**

Enterprise User Security (EUS) is deprecated with Oracle Database 23ai. Oracle recommends that you migrate to using Centrally Managed Users (CMU). This feature enables you to directly connect with Microsoft Active Directory without an intervening directory service for enterprise user authentication and authorization to the database. If your Oracle Database is in the cloud, you can also choose to move to one of the newer integrations with a cloud identity provider.

13.3.11.2 Database Session-Based Application Contexts with LDAP

An application context that is initialized globally uses LDAP, a standard, extensible, and efficient directory access protocol.

The LDAP directory stores a list of users to which this application is assigned. Oracle Database uses a directory service, typically Oracle Internet Directory, to authenticate and authorize enterprise users.

 **Note:**

You can use third-party directories such as Microsoft Active Directory and Sun Microsystems SunONE as the directory service.

The `orclDBApplicationContext` LDAP object (a subclass of `groupOfUniqueNames`) stores the application context values in the directory. The location of the application context object is described in [Figure 13-1](#), which is based on the Human Resources example.

The LDAP object `inetOrgPerson` enables multiple entries to exist for some attributes. However, be aware that when these entries are loaded into the database and accessed with the `SYS_LDAP_USER_DEFAULT` context namespace, then only the first of these entries is returned. For example, the `inetOrgPerson` object for a user allows multiple entries for `telephoneNumber` (thus allowing a user to have multiple telephone numbers stored). When you use the `SYS_LDAP_USER_DEFAULT` context namespace, only the first telephone number is retrieved. If the list of attributes and values that are provided are not sufficient for your needs, then you can use the `DBMS_LDAP` PL/SQL package to fetch additional values from the directory.

On the LDAP side, an internal C function is required to retrieve the `orclDBApplicationContext` value, which returns a list of application context values to the database. In this example, `HR` is the namespace; `Title` and `Project` are the attributes; and `Manager` and `Promotion` are the values.

Figure 13-1 Location of Application Context in LDAP Directory Information Tree

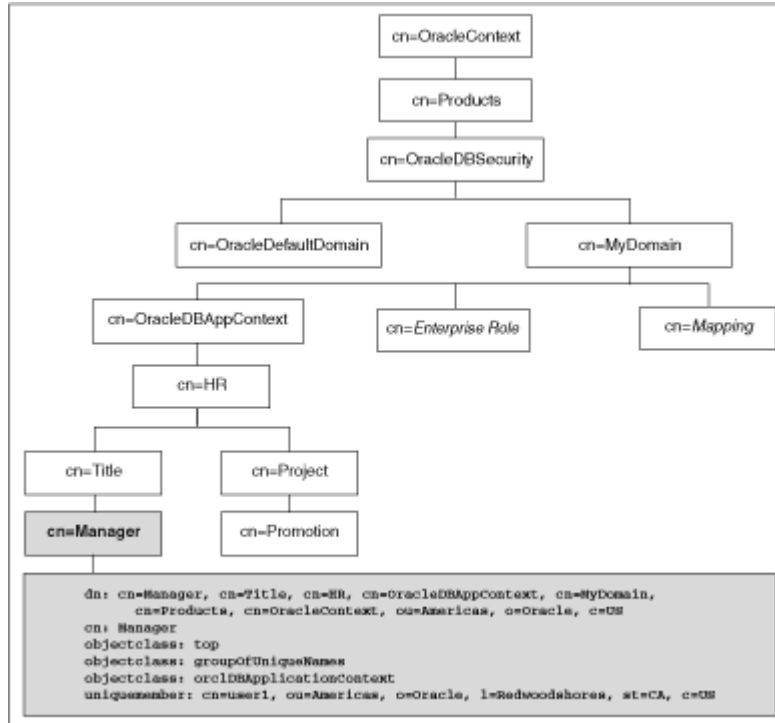

13.3.11.3 How Globally Initialized Database Session-Based Application Contexts Work

To use a globally initialized secure application, you must first configure Enterprise User Security.

 **Note:**

Enterprise User Security (EUS) is deprecated with Oracle Database 23ai. Oracle recommends that you migrate to using Centrally Managed Users (CMU). This feature enables you to directly connect with Microsoft Active Directory without an intervening directory service for enterprise user authentication and authorization to the database. If your Oracle Database is in the cloud, you can also choose to move to one of the newer integrations with a cloud identity provider.

Then, you configure the application context values for the user in the database and the directory.

When a global user (enterprise user) connects to the database, Enterprise User Security verifies the identity of the user connecting to the database. After authentication, the global user roles and application context are retrieved from the directory. When the user logs on to the database, the global roles and initial application context are already set.

Related Topics

- *Oracle Database Enterprise User Security Administrator's Guide*

13.3.11.4 Initializing a Database Session-Based Application Context Globally

You can configure and store the initial application context for a user, such as the department name and title, in the LDAP directory.

The values are retrieved during user login so that the context is set properly. In addition, any information related to the user is retrieved and stored in the `SYS_USER_DEFAULTS` application context namespace.

1. Create the application context in the database.

```
CREATE CONTEXT hr USING hrapps.hr_manage_pkg INITIALIZED GLOBALLY;
```

2. Create and add new entries in the LDAP directory.

An example of the entries added to the LDAP directory follows. These entries create an attribute named `Title` with the attribute value `Manager` for the application (namespace) `HR`, and assign user names `user1` and `user2`. In the following, `cn=example` refers to the name of the domain.

```
dn:
cn=OracleDBAppContext,cn=example,cn=OracleDBSecurity,cn=Products,cn=OracleContext,ou=
Americas,o=oracle,c=US
changetype: add
cn: OracleDBAppContext
objectclass: top
objectclass: orclContainer
```

```
dn:
cn=hr,cn=OracleDBAppContext,cn=example,cn=OracleDBSecurity,cn=Products,cn=OracleConte
xt,ou=Americas,o=oracle,c=US
changetype: add
cn: hr
objectclass: top
objectclass: orclContainer
```

```
dn: cn=Title,cn=hr,
cn=OracleDBAppContext,cn=example,cn=OracleDBSecurity,cn=Products,cn=OracleContext,ou=
Americas,o=oracle,c=US
changetype: add
cn: Title
objectclass: top
objectclass: orclContainer
```

```
dn: cn=Manager,cn=Title,cn=hr,
cn=OracleDBAppContext,cn=example,cn=OracleDBSecurity,cn=Products,cn=OracleContext,ou=
Americas,o=oracle,c=US
cn: Manager
objectclass: top
objectclass: groupofuniquenames
objectclass: orclDBApplicationContext
uniquemember: CN=user1,OU=Americas,O=Oracle,L=Redwoodshores,ST=CA,C=US
uniquemember: CN=user2,OU=Americas,O=Oracle,L=Redwoodshores,ST=CA,C=US
```

3. If an LDAP `inetOrgPerson` object entry exists for the user, then the connection retrieves the attributes from `inetOrgPerson`, and assigns them to the namespace `SYS_LDAP_USER_DEFAULT`. Note that the context is only populated with non-NULL values that are part of the `inetOrgPerson` object class. No other attributes will be populated.

The following is an example of an `inetOrgPerson` entry:

```
dn: cn=user1,ou=Americas,O=oracle,L=redwoodshores,ST=CA,C=US
changetype: add
objectClass: top
objectClass: person
objectClass: organizationalPerson
objectClass: inetOrgPerson
cn: user1
sn: One
givenName: User
initials: UO
title: manager, product development
uid: uone
mail: uone@us.example.com
telephoneNumber: +1 650 555 0105
employeeNumber: 00001
employeeType: full time
```

4. Connect to the database.

When `user1` connects to a database that belongs to the `example` domain, `user1` will have their `Title` set to `Manager`. Any information related to `user1` will be retrieved from the LDAP directory. The value can be obtained using the following syntax:

```
SYS_CONTEXT('namespace','attribute name')
```

For example:

```
DECLARE
  tmpstr1 VARCHAR2(30);
  tmpstr2 VARCHAR2(30);
BEGIN
  tmpstr1 = SYS_CONTEXT('HR','TITLE');
  tmpstr2 = SYS_CONTEXT('SYS_LDAP_USER_DEFAULT','telephoneNumber');
  DBMS_OUTPUT.PUT_LINE('Title is ' || tmpstr1);
  DBMS_OUTPUT.PUT_LINE('Telephone Number is ' || tmpstr2);
END;
```

The output of this example is:

```
Title is Manager
Telephone Number is +1 650 555 0105
```

13.3.12 Externalized Database Session-Based Application Contexts

Many applications store attributes used for fine-grained access control within a database metadata table.

For example, an `employees` table could include cost center, title, signing authority, and other information useful for fine-grained access control. Organizations also centralize user information for user management and access control in LDAP-based directories, such as Oracle Internet Directory. Application context attributes can be stored in Oracle Internet Directory, and assigned to one or more enterprise users. They can also be retrieved automatically upon login for an enterprise user, and then used to initialize an application context.

Related Topics

- [Initializing Database Session-Based Application Contexts Externally](#)
Initializing database session-based application contexts externally increases performance because the application context is stored in the user global area (UGA).

- [Initializing Database Session-Based Application Contexts Globally](#)
When a database session-based application is stored in a centralized location, it can be used globally from an LDAP directory.
- *Oracle Database Enterprise User Security Administrator's Guide*

13.4 Global Application Contexts

You can use a global application context to access application values across database sessions, including an Oracle Real Application Clusters environment.

- [About Global Application Contexts](#)
A global application context enables application context values to be accessible across database sessions, including Oracle RAC instances.
- [Uses for Global Application Contexts](#)
There are three general uses for global application contexts.
- [Components of a Global Application Context](#)
A global application context uses a package to manage its attributes and middle-tier application to manage the client session ID.
- [Global Application Contexts in an Oracle Real Application Clusters Environment](#)
In an Oracle RAC environment, whenever a global application context is loaded or changed, it is visible only to the existing active instances.
- [Creating Global Application Contexts](#)
The `CREATE CONTEXT` SQL statement creates the global application context, which is then located in the `SYS` schema.
- [PL/SQL Package to Manage a Global Application Context](#)
The `DBMS_SESSION` PL/SQL package to manages global application contexts.
- [Embedding Calls in Middle-Tier Applications to Manage the Client Session ID](#)
You can embed calls in middle-tier applications to manage client session IDs.
- [Tutorial: Creating a Global Application Context That Uses a Client Session ID](#)
This tutorial demonstrates how you can create a global application context that uses a client session ID.
- [Global Application Context Processes](#)
A simple global application context uses a database user account create the user session; a global application context is for lightweight users.

13.4.1 About Global Application Contexts

A global application context enables application context values to be accessible across database sessions, including Oracle RAC instances.

Oracle Database stores the global application context information in the System (sometimes called "Shared") Global Area (SGA) so that it can be used for applications that use a sessionless model, such as middle-tier applications in a three-tiered architecture.

These applications cannot use a session-based application context because users authenticate to the application, and then it typically connects to the database as a single identity. Oracle Database initializes the global application context once, rather than for each user session. This improves performance, because connections are reused from a connection pool.

You can clear a global application context value by running the `ALTER SYSTEM FLUSH GLOBAL_CONTEXT SQL` statement.

13.4.2 Uses for Global Application Contexts

There are three general uses for global application contexts.

These uses are as follows:

- **You must share application values globally for all database users.** For example, you may need to disable access to an application based on a specific situation. In this case, the values the application context sets are not user-specific, nor are they based on the private data of a user. The application context defines a situation, for example, to indicate the version of application module that is running.
- **You have database users who must move from one application to another.** In this case, the second application the user is moving to has different access requirements from the first application.
- **You must authenticate nondatabase users, that is, users who are not known to the database.** This type of user, who does not have a database account, typically connects through a Web application by using a connection pool. These types of applications connect users to the database as single user, using the One Big Application User authentication model. To authenticate this type of user, you use the client session ID of the user.

13.4.3 Components of a Global Application Context

A global application context uses a package to manage its attributes and middle-tier application to manage the client session ID.

- **The global application context.** You use the `CREATE CONTEXT SQL` statement to create the global application context, and include the `ACCESSED GLOBALLY` clause in the statement. This statement names the application context and associates it with a PL/SQL procedure that is designed to set the application data context data. The global application context is created and stored in the database schema of the security administrator who creates it.
- **A PL/SQL package to set the attributes.** The package must contain a procedure that uses the `DBMS_SESSION.SET_CONTEXT` procedure to set the global application context. The `SET_CONTEXT` procedure provides parameters that enable you to create a global application context that fits any of the three user situations described in this section. You create, store, and run the PL/SQL package on the database server. Typically, it belongs in the schema of the security administrator who created it.
- **A middle-tier application to get and set the client session ID.** For nondatabase users, which require a client session ID to be authenticated, you can use the Oracle Call Interface (OCI) calls in the middle-tier application to retrieve and set their session data. You can also use the `DBMS_SESSION.SET_IDENTIFIER` procedure to set the client session ID. An advantage of creating a client session ID to store the nondatabase user's name is that you can query the `CLIENT_ID` column of `DBA_AUDIT_TRAIL`, `DBA_FGA_AUDIT_TRAIL`, and `DBA_COMMON_AUDIT_TRAIL` data dictionary views to audit this user's activity.

Note:

Be aware that the `DBMS_APPLICATION_INFO.SET_CLIENT_INFO` setting can overwrite the value.

Related Topics

- [Use of the DBMS_SESSION PL/SQL Package to Set and Clear the Client Identifier](#)
The `DBMS_SESSION` PL/SQL package manages client identifiers on both the middle tier and the database itself.

13.4.4 Global Application Contexts in an Oracle Real Application Clusters Environment

In an Oracle RAC environment, whenever a global application context is loaded or changed, it is visible only to the existing active instances.

Be aware that setting a global application context value in an Oracle RAC environment has performance overhead of propagating the context value consistently to all Oracle RAC instances.

If you flush the global application context (using the `ALTER SYSTEM FLUSH GLOBAL_CONTEXT` SQL statement) in one Oracle RAC instance, then all the global application context is flushed in all other Oracle RAC instances as well.

13.4.5 Creating Global Application Contexts

The `CREATE CONTEXT` SQL statement creates the global application context, which is then located in the `SYS` schema.

- [Ownership of the Global Application Context](#)
A global application context is owned by the `SYS` schema.
- [Creating a Global Application Context](#)
As with local application contexts, the global application context is created and stored in the security administrator's database schema.

13.4.5.1 Ownership of the Global Application Context

A global application context is owned by the `SYS` schema.

The ownership of the global application context is as follows: Even though a user who has been granted the `CREATE ANY CONTEXT` and `DROP ANY CONTEXT` privileges can create and drop the global application context, it is owned by the `SYS` schema.

Oracle Database associates the context with the schema account that created it, but if you drop this user, the context still exists in the `SYS` schema. As user `SYS`, you can drop the application context.

13.4.5.2 Creating a Global Application Context

As with local application contexts, the global application context is created and stored in the security administrator's database schema.

You must have the `CREATE ANY CONTEXT` system privilege before you can create a global application context, and the `DROP ANY CONTEXT` privilege before you can drop the context with the `DROP CONTEXT` statement.

- To create a global application context, use the `CREATE CONTEXT` SQL statement to create the application context and include the `ACCESSED GLOBALLY` clause in the statement.

For example:

```
CREATE OR REPLACE CONTEXT global_hr_ctx USING hr_ctx_pkg ACCESSED GLOBALLY CONTAINER = ALL;
```

13.4.6 PL/SQL Package to Manage a Global Application Context

The `DBMS_SESSION` PL/SQL package to manages global application contexts.

- [About the Package That Manages the Global Application Context](#)
The package that is associated with a global application context uses the `DBMS_SESSION` package to set and clear the global application context values.
- [How Editions Affects the Results of a Global Application Context PL/SQL Package](#)
Global application context packages, Oracle Virtual Private Database packages, and fine-grained audit policies can be used across multiple editions.
- [DBMS_SESSION.SET_CONTEXT username and client_id Parameters](#)
The `DBMS_SESSION.SYS_CONTEXT` procedure provides the `client_id` and `username` parameters, to be used for global application contexts.
- [Sharing Global Application Context Values for All Database Users](#)
You can share global application values for all database users to give them access to data in the database.
- [Example: Package to Manage Global Application Values for All Database Users](#)
The `CREATE PACKAGE` statement can manage global application values for all database users.
- [Global Contexts for Database Users Who Move Between Applications](#)
A global application context can be used for database users who move between application, even when the applications have different access requirements.
- [Global Application Context for Nondatabase Users](#)
When a nondatabase user starts a client session, the application server generates a client session ID.
- [Example: Package to Manage Global Application Context Values for Nondatabase Users](#)
The `CREATE PACKAGE` statement can manage global application context values for nondatabase users.
- [Clearing Session Data When the Session Closes](#)
The application context exists within memory, so when the user exits a session, either by switching to another session or ending the current session, you must clear the `client_identifier` context value.

13.4.6.1 About the Package That Manages the Global Application Context

The package that is associated with a global application context uses the `DBMS_SESSION` package to set and clear the global application context values.

You must have the `EXECUTE` privilege for the `DBMS_SESSION` package before you use its procedures. Typically, you create and store this package in the database schema of a security administrator. The `SYS` schema owns the `DBMS_SESSION` package.

Unlike PL/SQL packages used to set a local application context, you do not include a `SYS_CONTEXT` function to get the user session data. You do not need to include this function because the owner of the session, recorded in the `USERENV` context, is the same for every user who is connecting.

You can run the procedures within the PL/SQL package for a global application context at any time. You do not need to create logon and logoff triggers to run the package procedures

associated with the global application context. A common practice is to run the package procedures from within the database application. Additionally, for nondatabase users, you use middle-tier applications to get and set client session IDs.

Related Topics

- *Oracle Database PL/SQL Packages and Types Reference*

13.4.6.2 How Editions Affects the Results of a Global Application Context PL/SQL Package

Global application context packages, Oracle Virtual Private Database packages, and fine-grained audit policies can be used across multiple editions.

Follow these guidelines:

- **If you want to have the PL/SQL package results be the same across all editions.** To do so, create the package in the schema of a user who has not been editions enabled. To find users who are not editions enabled, you can query the `DBA_USERS` and `USER_USERS` data dictionary views. Remember that `SYS`, `SYSTEM`, and other default Oracle Database administrative accounts that are listed in the `DBA_REGISTRY` data dictionary view are not and cannot be editions enabled.
- **If you want to have the PL/SQL package results depend on the current state of the edition in which the package is run.** Here, the results may be different across all editions to which the package applies. In this case, create the package in the schema of a user who has been editions enabled. If the schema is editions enabled, then it is likely that there will be different actual copies of the package in different editions, where each copy has different behavior. This is useful for the following types of scenarios:
 - The package must use a new application context.
 - The package must encode input values using a different scheme.
 - The package must apply different validation rules for users logging in to the database.

For PL/SQL packages that set a global application context, use a single getter function to wrap the primitive `SYS_CONTEXT` calls that will read the key-value application context pairs. You can put this getter function in the same package as the application context setter procedure. This approach lets you tag the value for the application context key to reflect a relevant concept. For example, the tag can be the edition in which the setter function is actual. Or, it can be the current edition of the session that set the context, which you can find by using `SYS_CONTEXT('USERENV', 'CURRENT_EDITION_NAME')`. This tag can be any specific notion to which the setter function applies.

Related Topics

- *Oracle Database Development Guide*

13.4.6.3 DBMS_SESSION.SET_CONTEXT username and client_id Parameters

The `DBMS_SESSION.SET_CONTEXT` procedure provides the `client_id` and `username` parameters, to be used for global application contexts.

[Table 13-2](#) explains how the combination of these settings controls the type of global application context you can create.

Table 13-2 Setting the DBMS_SESSION.SET_CONTEXT username and client_id Parameters

Combination Settings	Result
username set to NULL client_id set to NULL	This combination enables all database users to share access to the global application context values. These settings are also used for database session-based application contexts.
username set to a value client_id set to NULL	This combination enables a global application context to be accessed by multiple sessions for users who must move between applications, as long as the username setting is the same throughout. Ensure that the user name specified is a valid database user.
username set to NULL client_id set to a value	This combination enables an application to be accessed by multiple user sessions, as long as the client_id parameter is set to the same value throughout. This enables sessions of all users to see the application context values.
username set to a value client_id set to a value	This combination enables the following two scenarios: <ul style="list-style-type: none"> • Lightweight users. If the user does not have a database account, the username specified is a connection pool owner. The client_id setting is then associated with the nondatabase user who is logging in. • Database users. If the user is a database user, this combination can be used for stateless Web sessions. Setting the username parameter in the SET_CONTEXT procedure to USER calls the Oracle Database-supplied USER function. The USER function specifies the session owner from the application context retrieval process and ensures that only the user who set the application context can access the context.

Related Topics

- [Sharing Global Application Context Values for All Database Users](#)
You can share global application values for all database users to give them access to data in the database.
- [Using Database Session-Based Application Contexts](#)
A database session-based application context enables you to retrieve session-based information about a user.
- [Global Contexts for Database Users Who Move Between Applications](#)
A global application context can be used for database users who move between application, even when the applications have different access requirements.
- *Oracle Database SQL Language Reference*

13.4.6.4 Sharing Global Application Context Values for All Database Users

You can share global application values for all database users to give them access to data in the database.

- To share global application values for all database users, set the namespace, attribute, and value parameters in the SET_CONTEXT procedure.

Related Topics

- [Example: Package to Manage Global Application Values for All Database Users](#)
The CREATE PACKAGE statement can manage global application values for all database users.

13.4.6.5 Example: Package to Manage Global Application Values for All Database Users

The `CREATE PACKAGE` statement can manage global application values for all database users.

[Example 13-7](#) shows how to create a package that sets and clears a global application context for all database users.

Example 13-7 Package to Manage Global Application Values for All Database Users

```
CREATE OR REPLACE PACKAGE hr_ctx_pkg
AS
  PROCEDURE set_hr_ctx(sec_level IN VARCHAR2);
  PROCEDURE clear_hr_context;
END;
/
CREATE OR REPLACE PACKAGE BODY hr_ctx_pkg
AS
  PROCEDURE set_hr_ctx(sec_level IN VARCHAR2)
  AS
  BEGIN
    DBMS_SESSION.SET_CONTEXT(
      namespace => 'global_hr_ctx',
      attribute  => 'job_role',
      value      => sec_level);
  END set_hr_ctx;

  PROCEDURE clear_hr_context
  AS
  BEGIN
    DBMS_SESSION.CLEAR_CONTEXT('global_hr_ctx', 'job_role');
  END clear_context;
END;
/
```

In this example:

- `DBMS_SESSION.SET_CONTEXT ... END set_hr_ctx` uses the `DBMS_SESSION.SET_CONTEXT` procedure to set values for the `namespace`, `attribute`, and `value` parameters. The `sec_level` value is specified when the database application runs the `hr_ctx_pkg.set_hr_ctx` procedure.

The `username` and `client_id` values are not set, hence, they are `NULL`. This enables all users (database users) to have access to the values, which is appropriate for server-wide settings.

- `namespace => 'global_hr_ctx'` sets the namespace to `global_hr_ctx`, in the `SET_CONTEXT` procedure.
- `attribute => 'job_role'` creates the `job_role` attribute.
- `value => sec_level` sets the value for the `job_role` attribute to `sec_level`.
- `PROCEDURE clear_hr_context` creates the `clear_hr_context` procedure to clear the context values. See [Clearing Session Data When the Session Closes](#) for more information.

Typically, you run this procedure within a database application. For example, if all users logging in are clerks, and you want to use "clerk" as a security level, you would embed a call within a database application similar to the following:

```
BEGIN
  hr_ctx_pkg.set_hr_ctx('clerk');
END;
/
```

If the procedure successfully completes, then you can check the application context values as follows:

```
SELECT SYS_CONTEXT('global_hr_ctx', 'job_role') job_role FROM DUAL;

JOB_ROLE
-----
clerk
```

You can clear the global application context values for all database users by running the following procedure:

```
BEGIN
  hr_ctx_pkg.clear_hr_context;
END;
/
```

To check that the global context value is really cleared, the following `SELECT` statement should return no values:

```
SELECT SYS_CONTEXT('global_hr_ctx', 'job_role') job_role FROM DUAL;

JOB_ROLE
-----
```

If Oracle Database returns error messages saying that you have insufficient privileges, then ensure that you have correctly created the global application context. You should also query the `DBA_CONTEXT` database view to ensure that your settings are correct, for example, that you are calling the procedure from the schema in which you created it.

If `NULL` is returned, then you may have inadvertently set a client identifier. To clear the client identifier, run the following procedure:

```
EXEC DBMS_SESSION.CLEAR_IDENTIFIER;
```

13.4.6.6 Global Contexts for Database Users Who Move Between Applications

A global application context can be used for database users who move between application, even when the applications have different access requirements.

To do so, you must include the `username` parameter in the `DBMS_SESSION.SET_CONTEXT` procedure.

This parameter specifies that the same schema be used for all sessions.

You can use the following `DBMS_SESSION.SET_CONTEXT` parameters:

- `namespace`
- `attribute`
- `value`
- `username`

Oracle Database matches the `username` value so that the other application can recognize the application context. This enables the user to move between applications.

By omitting the `client_id` setting, its value is `NULL`, the default. This means that values can be seen by multiple sessions if the `username` setting is the same for a database user who maintains the same context in different applications. For example, you can have a suite of applications that control user access with Oracle Virtual Private Database policies, with each user restricted to a job role.

[Example 13-8](#) demonstrates how to set the `username` parameter so that a specific user can move between applications. The use of the `username` parameter is indicated in **bold** typeface.

Example 13-8 Package for Global Application Context Values for Moving Between Applications

```
CREATE OR REPLACE PACKAGE hr_ctx_pkg
AS
    PROCEDURE set_hr_ctx(sec_level IN VARCHAR2, user_name IN VARCHAR2);
    PROCEDURE clear_hr_context;
END;
/
CREATE OR REPLACE PACKAGE BODY hr_ctx_pkg
AS
    PROCEDURE set_hr_ctx(sec_level IN VARCHAR2, user_name IN VARCHAR2)
    AS
        BEGIN
            DBMS_SESSION.SET_CONTEXT(
                namespace => 'global_hr_ctx',
                attribute => 'job_role',
                value      => sec_level,
                username   => user_name);
        END set_hr_ctx;

    PROCEDURE clear_hr_context
    AS
        BEGIN
            DBMS_SESSION.CLEAR_CONTEXT('global_hr_ctx');
        END clear_context;
END;
/
```

Typically, you run this procedure within a database application by embedding a call similar to the following example. Ensure that the value for the `user_name` parameter (`scott` in this case) is a valid database user name.

```
BEGIN
    hr_ctx_pkg.set_hr_ctx('clerk', 'scott');
END;
```

A secure way to manage this type of global application context is within your applications, embed code to grant a secure application role to the user. This code should include `EXECUTE` permissions on the trusted PL/SQL package that sets the application context. In other words, the application, not the user, will set the context for the user.

13.4.6.7 Global Application Context for Nondatabase Users

When a nondatabase user starts a client session, the application server generates a client session ID.

A nondatabase user is a user who is not known to the database, such as a Web application user.

Once this ID is set on the application server, it must be passed to the database server side. You can do this by using the `DBMS_SESSION.SET_IDENTIFIER` procedure to set the client session ID.

To set the context, you can set the `client_id` parameter in the `DBMS_SESSION.SET_CONTEXT` procedure, in a PL/SQL procedure on the server side. This enables you to manage the application context globally, yet each client sees only their assigned application context.

The `client_id` value is the key here to getting and setting the correct attributes for the global application context. Remember that the client identifier is controlled by the middle-tier application, and once set, it remains open until it is cleared.

A typical way to manage this type of application context is to place the `session_id` value (`client_identifier`) in a cookie, and send it to the end user's HTML page so that is returned on the next request. A lookup table in the application should also keep client identifiers so that they are prevented from being reused for other users and to implement an end-user session time out.

For nondatabase users, configure the following `SET_CONTEXT` parameters:

- `namespace`
- `attribute`
- `value`
- `username`
- `client_id`

Related Topics

- [Tutorial: Creating a Global Application Context That Uses a Client Session ID](#)
This tutorial demonstrates how you can create a global application context that uses a client session ID.
- [Step 2: Set the Client Session ID Using a Middle-Tier Application](#)
Next, you are ready to set the client session ID using a middle-tier application.
- [Using Client Identifiers to Identify Application Users Unknown to the Database](#)
Client identifiers preserve user identity in middle tier systems; they also can be used independently of the global application context.

13.4.6.8 Example: Package to Manage Global Application Context Values for Nondatabase Users

The `CREATE PACKAGE` statement can manage global application context values for nondatabase users.

[Example 13-9](#) shows how to create a package that manages this type of global application context.

Example 13-9 Package to Manage Global Application Context Values for Nondatabase Users

```
CREATE OR REPLACE PACKAGE hr_ctx_pkg
AS
  PROCEDURE set_session_id(session_id_p IN NUMBER);
  PROCEDURE set_hr_ctx(sec_level_attr IN VARCHAR2,
    sec_level_val IN VARCHAR2);
  PROCEDURE clear_hr_session(session_id_p IN NUMBER);
  PROCEDURE clear_hr_context;
```

```
END;
/
CREATE OR REPLACE PACKAGE BODY hr_ctx_pkg
AS
    session_id_global NUMBER;
PROCEDURE set_session_id(session_id_p IN NUMBER)
AS
BEGIN
    session_id_global := session_id_p;
    DBMS_SESSION.SET_IDENTIFIER(session_id_p);
END set_session_id;

PROCEDURE set_hr_ctx(sec_level_attr IN VARCHAR2,
                    sec_level_val IN VARCHAR2)
AS
BEGIN
    DBMS_SESSION.SET_CONTEXT(
        namespace => 'global_hr_ctx',
        attribute => sec_level_attr,
        value      => sec_level_val,
        username   => USER,
        client_id  => session_id_global);
END set_hr_ctx;

PROCEDURE clear_hr_session(session_id_p IN NUMBER)
AS
BEGIN
    DBMS_SESSION.SET_IDENTIFIER(session_id_p);
    DBMS_SESSION.CLEAR_IDENTIFIER;
END clear_hr_session;

PROCEDURE clear_hr_context
AS
BEGIN
    DBMS_SESSION.CLEAR_CONTEXT('global_hr_ctx', session_id_global);
END clear_hr_context;
END;
/
```

In this example:

- `session_id_global NUMBER` creates the `session_id_global` variable, which will hold the client session ID. The `session_id_global` variable is referenced throughout the package definition, including the procedure that creates the global application context attributes and assigns them values. This means that the global application context values will always be associated with this particular session ID.
- `PROCEDURE set_session_id ... END set_session_id` creates the `set_session_id` procedure, which writes the client session ID to the `session_id_global` variable.
- `PROCEDURE set_hr_ctx ... END set_hr_ctx` creates the `set_hr_ctx` procedure, which creates global application context attributes and enables you to assign values to these attributes. Within this procedure:
 - `username => USER` specifies the `username` value. This example sets it by calling the Oracle Database-supplied `USER` function, which adds the session owner from the context retrieval process. The `USER` function ensures that only the user who set the application context can access the context.

If you had specified `NULL` (the default for the `username` parameter), then any user can access the context.

Setting both the `username` and `client_id` values enables two scenarios. For lightweight users, set the `username` parameter to a connection pool owner (for example, `APPS_USER`), and then set `client_id` to the client session ID. If you want to use a stateless Web session, set the `user_name` parameter to the same database user who has logged in, and ensure that this user keeps the same client session ID.

- `client_id => session_id_global` specifies `client_id` value. This example sets it to the `session_id_global` variable. This associates the context settings defined here with a specific client session ID, that is, the one that is set when you run the `set_session_id` procedure. If you specify the `client_id` parameter default, `NULL`, then the global application context settings could be used by any session.
- PROCEDURE `clear_hr_session ... END clear_hr_session` creates the `clear_hr_session` procedure to clear the client session identifier. The `AS` clause sets it to ensure that you are clearing the correct session ID, that is, the one stored in variable `session_id_p` defined in the `CREATE OR REPLACE PACKAGE BODY hr_ctx_pkg` procedure.
- PROCEDURE `clear_hr_context ... END clear_hr_context` creates the `clear_hr_context` procedure, so that you can clear the context settings for the current user session, which were defined by the `global_hr_ctx` variable.

Related Topics

- [Oracle Database SQL Language Reference](#)
- [DBMS_SESSION.SET_CONTEXT username and client_id Parameters](#)
The `DBMS_SESSION.SYS_CONTEXT` procedure provides the `client_id` and `username` parameters, to be used for global application contexts.
- [Clearing Session Data When the Session Closes](#)
The application context exists within memory, so when the user exits a session, either by switching to another session or ending the current session, you must clear the `client_identifier` context value.

13.4.6.9 Clearing Session Data When the Session Closes

The application context exists within memory, so when the user exits a session, either by switching to another session or ending the current session, you must clear the `client_identifier` context value.

This releases memory and prevents other users from accidentally using any left over values.

- To clear session data when a user exits a session (by switching or ending), use either of the following methods in the server-side PL/SQL package:
 - **Clearing the client identifier when a user exits a session.** Use the `DBMS_SESSION.CLEAR_IDENTIFIER` procedure. For example:

```
EXEC DBMS_SESSION.CLEAR_IDENTIFIER;
```
 - **Continuing the session but still clearing the context.** If you want the session to continue, but you still need to clear the context, use one of the following procedures:
 - * `DBMS_SESSION.CLEAR_CONTEXT` clears the context for the current user. For example:

```
EXEC DBMS_SESSION.CLEAR_CONTEXT('my_ctx', 'my_client_id', 'my_attribute');
```
 - * `DBMS_SESSION.CLEAR_ALL_CONTEXT` clears the context values for all users, for example, when you need to shut down the application server. For example:

```
EXEC DBMS_SESSION.CLEAR_ALL_CONTEXT('my_ctx');
```

- * `DBMS_SESSION.CLEAR_ALL_LOCAL_CONTEXTS` clears the application contexts that are set across all namespaces that are not accessed globally. You must be granted the `CLEAR ALL LOCAL CONTEXTS` system privilege to run this procedure. For example:

```
EXEC DBMS_SESSION.CLEAR_ALL_LOCAL_CONTEXTS;
```

Global application context values are available until they are cleared, so you should use `DBMS_SESSION.CLEAR_CONTEXT` or `DBMS_SESSION.CLEAR_ALL_CONTEXT` to ensure that other sessions do not have access to these values. Be aware that any changes in the context value are reflected immediately and subsequent calls to access the value through the `SYS_CONTEXT` function will return the most recent value.

13.4.7 Embedding Calls in Middle-Tier Applications to Manage the Client Session ID

You can embed calls in middle-tier applications to manage client session IDs.

- [About Managing Client Session IDs Using a Middle-Tier Application](#)
The application server generates the client session ID.
- [Step 1: Retrieve the Client Session ID Using a Middle-Tier Application](#)
When a user starts a client session, the application server generates a client session ID.
- [Step 2: Set the Client Session ID Using a Middle-Tier Application](#)
Next, you are ready to set the client session ID using a middle-tier application.
- [Step 3: Clear the Session Data Using a Middle-Tier Application](#)
The application context exists entirely within memory.

13.4.7.1 About Managing Client Session IDs Using a Middle-Tier Application

The application server generates the client session ID.

From a middle-tier application, you can get, set, and clear the client session IDs. To do so, you can embed either Oracle Call Interface (OCI) calls or `DBMS_SESSION` PL/SQL package procedures into the middle-tier application code.

The application authenticates the user, sets the client identifier, and sets it in the current session. The PL/SQL package `SET_CONTEXT` sets the `client_identifier` value in the application context.

Related Topics

- [Global Application Context for Nondatabase Users](#)
When a nondatabase user starts a client session, the application server generates a client session ID.

13.4.7.2 Step 1: Retrieve the Client Session ID Using a Middle-Tier Application

When a user starts a client session, the application server generates a client session ID.

You can retrieve this ID for use in authenticating the user's access.

- To retrieve this client ID, use the `OCIStmtExecute` call with any of the following statements:
 - `SELECT SYS_CONTEXT('userenv', 'client_identifier') FROM DUAL;`
 - `SELECT CLIENT_IDENTIFIER from V$SESSION;`

```
– SELECT value FROM session_context WHERE attribute='CLIENT_IDENTIFIER';
```

For example, to use the `OCIStmtExecute` call to retrieve a client session ID value:

```
oratest clientid[31];
OCIDefine *defnp1 = (OCIDefine *) 0;
OCIStmt *statementhndle;
oratest *selcid = (oratest *) "SELECT SYS_CONTEXT('userenv',
    'client_identifier') FROM DUAL";

OCIStmtPrepare(statementhndle, errhp, selcid,
    (ub4) strlen((char *) selcid), (ub4) OCI_NTV_SYNTAX, (ub4) OCI_DEFAULT);

OCIDefineByPos(statementhndle, &defnp1, errhp, 1, (dvoid *)clientid, 31,
    SQLT_STR, (dvoid *) 0, (ub2 *) 0, (ub2 *) 0, OCI_DEFAULT);

OCIStmtExecute(servhndle, statementhndle, errhp, (ub4) 1, (ub4) 0,
    (CONST OCISnapshot *) NULL, (OCISnapshot *) NULL, OCI_DEFAULT);

printf("CLIENT_IDENTIFIER = %s \n", clientid);
```

In this example:

- `oratest`, `OCIDefine`, `OCIStmt`, and `oratest` create variables to store the client session ID, reference call for `OCIDefine`, the statement handle, and the `SELECT` statement to use.
- `OCIStmtPrepare` prepares the statement `selcid` for execution.
- `OCIDefineByPos` defines the output variable `clientid` for client session ID.
- `OCIStmtExecute` executes the statement in the `selcid` variable.
- `printf` prints the formatted output for the retrieved client session ID.

13.4.7.3 Step 2: Set the Client Session ID Using a Middle-Tier Application

Next, you are ready to set the client session ID using a middle-tier application.

- [About Setting the Client Session ID Using a Middle-Tier Application](#)
After you use the `OCIStmtExecute` call to retrieve the client session ID, you are ready to set this ID.
- [Setting the Client Session ID Using a Middle-Tier Application](#)
Oracle Call Interface or the `DBMS_SESSION` PL/SQL package can set the client session ID using a middle-tier application.
- [Checking the Value of the Client Identifier](#)
For both `OCIAttrSet` and `DBMS_SESSION.SET_IDENTIFIER`, you can check the value of the client identifier.

13.4.7.3.1 About Setting the Client Session ID Using a Middle-Tier Application

After you use the `OCIStmtExecute` call to retrieve the client session ID, you are ready to set this ID.

The `DBMS_SESSION.SET_CONTEXT` procedure in the server-side PL/SQL package then sets this session ID and optionally, overwrites the application context values.

You must ensure that the middle-tier application code checks that the client session ID value (for example, the value written to `user_id` in the previous examples) matches the `client_id` setting defined in the server-side `DBMS_SESSION.SET_CONTEXT` procedure. The sequence of calls on the application server side should be as follows:

1. Get the current client session ID. The session should already have this ID, but it is safer to ensure that it truly has the correct value.
2. Clear the current client session ID. This prepares the application to service a request from a different end user.
3. Set the new client session ID or the client session ID that has been assigned to the end user. This ensures that the session is using a different set of global application context values.

13.4.7.3.2 Setting the Client Session ID Using a Middle-Tier Application

Oracle Call Interface or the `DBMS_SESSION` PL/SQL package can set the client session ID using a middle-tier application.

- Use either of the following methods to set the client session ID on the application server side:

- **Oracle Call Interface.** Set the `OCI_ATTR_CLIENT_IDENTIFIER` attribute in an `OCIAttrSet` OCI call. This attribute sets the client identifier in the session handle to track the end user identity.

The following example shows how to use `OCIAttrSet` with the `ATTR_CLIENT_IDENTIFIER` parameter. The `user_id` setting refers to a variable that stores the ID of the user who is logging on.

```
OCIAttrSet((void *)session_handle, (ub4) OCI_HTYPE_SESSION,
           (void *) user_id, (ub4)strlen(user_id),
           OCI_ATTR_CLIENT_IDENTIFIER, error_handle);
```

- **DBMS_SESSION package.** Use the `DBMS_SESSION.SET_IDENTIFIER` procedure to set the client identifier for the global application context. For example, assuming you are storing the ID of the user logging on in a variable called `user_id`, you would enter the following line into the middle-tier application code:

```
DBMS_SESSION.SET_IDENTIFIER(user_id);
```

When the application generates a session ID for use as a `CLIENT_IDENTIFIER`, then the session ID must be suitably random and protected over the network by encryption. If the session ID is not random, then a malicious user could guess the session ID and access the data of another user. If the session ID is not encrypted over the network, then a malicious user could retrieve the session ID and access the connection.

You can encrypt the session ID by using network data encryption and data integrity.

Related Topics

- [Configuring Oracle Database Native Network Encryption and Data Integrity](#)
You can configure native Oracle Net Services data encryption and data integrity for both servers and clients.

13.4.7.3.3 Checking the Value of the Client Identifier

For both `OCIAttrSet` and `DBMS_SESSION.SET_IDENTIFIER`, you can check the value of the client identifier.

- To check the value of the client identifier, use one of the of the following approaches:

- To check it using the `SYS_CONTEXT` function:

```
SELECT SYS_CONTEXT('userenv', 'client_identifier') FROM DUAL;
```

- To check it by querying the `V$SESSION` view:

```
SELECT CLIENT_IDENTIFIER from V$SESSION;
```

13.4.7.4 Step 3: Clear the Session Data Using a Middle-Tier Application

The application context exists entirely within memory.

When the user exits a session, you must clear the context for the `client_identifier` value. This releases memory and prevents other users from accidentally using any left over values

- To clear session data when a user exits a session, use either of the following methods in the middle-tier application code:

- **Clearing the client identifier when a user exits a session.** Use the `DBMS_SESSION.CLEAR_IDENTIFIER` procedure. For example:

```
DBMS_SESSION.CLEAR_IDENTIFIER;
```

- **Continuing the session but still clearing the context.** If you want the session to continue, but you still need to clear the context, use the `DBMS_SESSION.CLEAR_CONTEXT` or the `DBMS_SESSION.CLEAR_ALL_CONTEXT` procedure. For example:

```
DBMS_SESSION.CLEAR_CONTEXT(namespace, client_identifier, attribute);
```

The `CLEAR_CONTEXT` procedure clears the context for the current user. To clear the context values for all users, for example, when you need to shut down the application server, use the `CLEAR_ALL_CONTEXT` procedure.

Global application context values are available until they are cleared, so you should use `CLEAR_CONTEXT` or `CLEAR_ALL_CONTEXT` to ensure that other sessions do not have access to these values.

13.4.8 Tutorial: Creating a Global Application Context That Uses a Client Session ID

This tutorial demonstrates how you can create a global application context that uses a client session ID.

- [About This Tutorial](#)
This tutorial shows how to create a global application context that uses a client session ID for a lightweight user application.
- [Step 1: Create User Accounts](#)
A security administrator will manage the application context and its package, and a user account will own the connection pool.
- [Step 2: Create the Global Application Context](#)
Next, you are ready to create the global application context.
- [Step 3: Create a Package for the Global Application Context](#)
The PL/SQL package will manage the global application context that you created.
- [Step 4: Test the Newly Created Global Application Context](#)
At this stage, you are ready to explore how this global application context and session ID settings work.

- [Step 5: Modify the Session ID and Test the Global Application Context Again](#)
Next, clear and then modify the session ID and test the global application context again.
- [Step 6: Remove the Components of This Tutorial](#)
If you no longer need the components of this tutorial, then you can remove them.

13.4.8.1 About This Tutorial

This tutorial shows how to create a global application context that uses a client session ID for a lightweight user application.

It demonstrates how to control nondatabase user access by using a connection pool. This tutorial applies to the current PDB only.

13.4.8.2 Step 1: Create User Accounts

A security administrator will manage the application context and its package, and a user account will own the connection pool.

1. Log in to a PDB as `SYS` with the `SYSDBA` administrative privilege.

```
sqlplus sys@pdb_name as sysdba  
Enter password: password
```

To find the available PDBs in a CDB, log in to the CDB root container and then query the `PDB_NAME` column of the `DBA_PDBS` data dictionary view. To check the current container, run the `show con_name` command.

2. Create the local user account `sysadmin_ctx`, who will administer the global application context.

```
CREATE USER sysadmin_ctx IDENTIFIED BY password CONTAINER = CURRENT;  
GRANT CREATE SESSION, CREATE ANY CONTEXT, CREATE PROCEDURE TO sysadmin_ctx;  
  
GRANT EXECUTE ON DBMS_SESSION TO sysadmin_ctx;
```

Replace `password` with a password that is secure.

3. Create the local database account `apps_user`, who will own the connection pool.

```
CREATE USER apps_user IDENTIFIED BY password CONTAINER = CURRENT;  
GRANT CREATE SESSION TO apps_user;
```

Replace `password` with a password that is secure.

Related Topics

- [Guidelines for Securing Passwords](#)
Oracle provides guidelines for securing passwords in a variety of situations.

13.4.8.3 Step 2: Create the Global Application Context

Next, you are ready to create the global application context.

1. Connect as the security administrator `sysadmin_ctx`.

```
CONNECT sysadmin_ctx@pdb_name  
Enter password: password
```

2. Create the `cust_ctx` global application context.

```
CREATE CONTEXT global_cust_ctx USING cust_ctx_pkg ACCESSED GLOBALLY;
```

The `cust_ctx` context is created and associated with the schema of the security administrator `sysadmin_ctx`. However, the `SYS` schema owns the application context.

13.4.8.4 Step 3: Create a Package for the Global Application Context

The PL/SQL package will manage the global application context that you created.

1. As `sysadmin_ctx`, create the following PL/SQL package:

```
CREATE OR REPLACE PACKAGE cust_ctx_pkg
AS
    PROCEDURE set_session_id(session_id_p IN NUMBER);
    PROCEDURE set_cust_ctx(sec_level_attr IN VARCHAR2,
        sec_level_val IN VARCHAR2);
    PROCEDURE clear_hr_session(session_id_p IN NUMBER);
    PROCEDURE clear_hr_context;
END;
/
CREATE OR REPLACE PACKAGE BODY cust_ctx_pkg
AS
    session_id_global NUMBER;

    PROCEDURE set_session_id(session_id_p IN NUMBER)
    AS
    BEGIN
        session_id_global := session_id_p;
        DBMS_SESSION.SET_IDENTIFIER(session_id_p);
    END set_session_id;

    PROCEDURE set_cust_ctx(sec_level_attr IN VARCHAR2, sec_level_val IN VARCHAR2)
    AS
    BEGIN
        DBMS_SESSION.SET_CONTEXT(
            namespace => 'global_cust_ctx',
            attribute => sec_level_attr,
            value      => sec_level_val,
            username   => USER, -- Retrieves the session user, in this case, apps_user
            client_id  => session_id_global);
    END set_cust_ctx;

    PROCEDURE clear_hr_session(session_id_p IN NUMBER)
    AS
    BEGIN
        DBMS_SESSION.SET_IDENTIFIER(session_id_p);
        DBMS_SESSION.CLEAR_IDENTIFIER;
    END clear_hr_session;

    PROCEDURE clear_hr_context
    AS
    BEGIN
        DBMS_SESSION.CLEAR_CONTEXT('global_cust_ctx', session_id_global);
    END clear_hr_context;
END;
/
```

For a detailed explanation of how this type of package works, see [Example 13-9](#).

2. Grant `EXECUTE` privileges on the `cust_ctx_pkg` package to the connection pool owner, `apps_user`.

```
GRANT EXECUTE ON cust_ctx_pkg TO apps_user;
```

13.4.8.5 Step 4: Test the Newly Created Global Application Context

At this stage, you are ready to explore how this global application context and session ID settings work.

1. Connect as the connection pool owner, user `apps_user`.

```
CONNECT apps_user@pdb_name
Enter password: password
```

2. When the connection pool user logs on, the application sets the client session identifier as follows:

```
BEGIN
  sysadmin_ctx.cust_ctx_pkg.set_session_id(34256);
END;
/
```

3. Test the value of the client session identifier.

- a. Set the session ID:

```
EXEC sysadmin_ctx.cust_ctx_pkg.set_session_id(34256);
```

- b. Check the session ID:

```
SELECT SYS_CONTEXT('userenv', 'client_identifier') FROM DUAL;
```

The following output should appear:

```
SYS_CONTEXT('USERENV','CLIENT_IDENTIFIER')
-----
34256
```

4. Set the global application context as follows:

```
EXEC sysadmin_ctx.cust_ctx_pkg.set_cust_ctx('Category', 'Gold Partner');
EXEC sysadmin_ctx.cust_ctx_pkg.set_cust_ctx('Benefit Level', 'Highest');
```

(In a real-world scenario, the middle-tier application would set the global application context values, similar to how the client session identifier was set in Step 2.)

5. Enter the following `SELECT SYS_CONTEXT` statement to check that the settings were successful:

```
col category format a13
col benefit_level format a14

SELECT SYS_CONTEXT('global_cust_ctx', 'Category') category,
       SYS_CONTEXT('global_cust_ctx', 'Benefit Level') benefit_level FROM DUAL;
```

The following output should appear:

```
CATEGORY          BENEFIT_LEVEL
-----
Gold Partner      Highest
```

What `apps_user` has done here, within the client session 34256, is set a global application context on behalf of a nondatabase user. This context sets the `Category` and `Benefit Level` `DBMS_SESSION.SET_CONTEXT` attributes to be `Gold Partner` and `Highest`, respectively. The context exists only for user `apps_user` with client ID 34256. When a nondatabase user logs in, behind the scenes, they are really logging on as the connection pool user `apps_user`. Hence, the `Gold Partner` and `Highest` context values are available to the nondatabase user.

Suppose the user had been a database user and could log in without using the intended application. (For example, the user logs in using SQL*Plus.) Because the user has not logged in through the connection pool user `apps_user`, the global application context appears empty to our errant user. This is because the context was created and set under the `apps_user` session. If the user runs the `SELECT SYS_CONTEXT` statement, then the following output appears:

```
CATEGORY          BENEFIT_LEVEL
-----

```

13.4.8.6 Step 5: Modify the Session ID and Test the Global Application Context Again

Next, clear and then modify the session ID and test the global application context again.

1. As user `apps_user`, clear the session ID.

```
EXEC sysadmin_ctx.cust_ctx_pkg.clear_hr_session(34256);
```

2. Check the global application context settings again.

```
SELECT SYS_CONTEXT('global_cust_ctx', 'Category') category,
       SYS_CONTEXT('global_cust_ctx', 'Benefit Level') benefit_level FROM DUAL;
```

```
CATEGORY          BENEFIT_LEVEL
-----

```

Because `apps_user` has cleared the session ID, the global application context settings are no longer available.

3. Restore the session ID to 34256, and then check the context values.

```
EXEC sysadmin_ctx.cust_ctx_pkg.set_session_id(34256);
```

```
SELECT SYS_CONTEXT('global_cust_ctx', 'Category') category,
       SYS_CONTEXT('global_cust_ctx', 'Benefit Level') benefit_level FROM DUAL;
```

The following output should appear:

```
CATEGORY          BENEFIT_LEVEL
-----
Gold Partner      Highest
```

As you can see, resetting the session ID to 34256 brings the application context values back again. To summarize, the global application context must be set only *once* for this user, but the client session ID must be set *each time* the user logs on.

4. Now try clearing and then checking the global application context values.

```
EXEC sysadmin_ctx.cust_ctx_pkg.clear_hr_context;
```

```
SELECT SYS_CONTEXT('global_cust_ctx', 'Category') category,
       SYS_CONTEXT('global_cust_ctx', 'Benefit Level') benefit_level FROM DUAL;
```

The following output should appear:

```
CATEGORY          BENEFIT_LEVEL
-----

```

At this stage, the client session ID, 34256 is still in place, but the application context settings no longer exist. This enables you to continue the session for this user but without using the previously set application context values.

13.4.8.7 Step 6: Remove the Components of This Tutorial

If you no longer need the components of this tutorial, then you can remove them.

1. Connect as SYS with the SYSDBA administrative privilege.

```
CONNECT SYS@pdb_name AS SYSDBA
Enter password: password
```

2. Drop the global application context.

```
DROP CONTEXT global_cust_ctx;
```

Remember that even though `sysadmin_ctx` created the global application context, it is owned by the SYS schema.

3. Drop the two sample users.

```
DROP USER sysadmin_ctx CASCADE;
DROP USER apps_user;
```

13.4.9 Global Application Context Processes

A simple global application context uses a database user account create the user session; a global application context is for lightweight users.

- [Simple Global Application Context Process](#)
In a simple global application context process, the application uses a database user to create a user session.
- [Global Application Context Process for Lightweight Users](#)
You can set a global application contexts for lightweight users.

13.4.9.1 Simple Global Application Context Process

In a simple global application context process, the application uses a database user to create a user session.

The value for the context attribute of a simple global application context process can be retrieved from a `SELECT` statement.

Consider the application server, `AppSvr`, which has assigned the client identifier 12345 to client `SCOTT`. The `AppSvr` application uses the `SCOTT` user to create a session. (In other words, it is not a connection pool.) The value assigned to the context attribute can come from anywhere, for example, from running a `SELECT` statement on a table that holds the responsibility codes for users. When the application context is populated, it is stored in memory. As a result, any action that needs the responsibility code can access it quickly with a `SYS_CONTEXT` call, without the overhead of accessing a table. The only advantage of a global context over a local context in this case is if `SCOTT` were changing applications frequently and used the same context in each application.

The following steps show how the global application context process sets the client identifier for `SCOTT`:

1. The administrator creates a global context namespace by using the following statement:

```
CREATE OR REPLACE CONTEXT hr_ctx USING hr.init ACCESSED GLOBALLY;
```

- The administrator creates a PL/SQL package for the `hr_ctx` application context to indicate that, for this client identifier, there is an application context called `responsibility` with a value of 13 in the HR namespace.:

```
CREATE OR REPLACE PROCEDURE hr.init
AS
BEGIN
  DBMS_SESSION.SET_CONTEXT(
    namespace => 'hr_ctx',
    attribute => 'responsibility',
    value      => '13',
    username  => 'SCOTT',
    client_id => '12345' );
END;
/
```

This PL/SQL procedure is stored in the HR database schema, but typically it is stored in the schema of the security administrator.

- The AppSvr application issues the following command to indicate the connecting client identity each time `scott` uses AppSvr to connect to the database:

```
EXEC DBMS_SESSION.SET_IDENTIFIER('12345');
```

- When there is a `SYS_CONTEXT('hr_ctx','responsibility')` call within the database session, the database matches the client identifier, 12345, to the global context, and then returns the value 13.
- When exiting this database session, AppSvr clears the client identifier by issuing the following procedure:

```
EXEC DBMS_SESSION.CLEAR_IDENTIFIER( );
```

- To release the memory used by the application context, AppSvr issues the following procedure:

```
DBMS_SESSION.CLEAR_CONTEXT('hr_ctx', '12345');
```

`CLEAR_CONTEXT` is needed when the user session is no longer active, either on an explicit logout, timeout, or other conditions determined by the AppSvr application.

Note:

After a client identifier in a session is cleared, it becomes a `NULL` value. This implies that subsequent `SYS_CONTEXT` calls only retrieve application contexts with `NULL` client identifiers, until the client identifier is set again using the `SET_IDENTIFIER` interface.

13.4.9.2 Global Application Context Process for Lightweight Users

You can set a global application contexts for lightweight users.

You can configure this access so that when other users log in, they cannot access the global application context.

The following steps show the global application context process for a lightweight user application. The lightweight user, `robert`, is not known to the database through the application.

- The administrator creates the global context namespace by using the following statement:

```
CREATE CONTEXT hr_ctx USING hr.init ACCESSED GLOBALLY;
```

2. The HR application server, AppSvr, starts and then establishes multiple connections to the HR database as the appsmgr user.
3. User robert logs in to the HR application server.
4. AppSvr authenticates robert to the application.
5. AppSvr assigns a temporary session ID (or uses the application user ID), 12345, for this connection.
6. The session ID is returned to the Web browser used by robert as part of a cookie or is maintained by AppSvr.
7. AppSvr initializes the application context for this client by calling the hr.init package, which issues the following statements:

```
DBMS_SESSION.SET_CONTEXT( 'hr_ctx', 'id', 'robert', 'APPSMGR', 12345 );
DBMS_SESSION.SET_CONTEXT( 'hr_ctx', 'dept', 'sales', 'APPSMGR', 12345 );
```
8. AppSvr assigns a database connection to this session and initializes the session by issuing the following statement:

```
DBMS_SESSION.SET_IDENTIFIER( 12345 );
```
9. All SYS_CONTEXT calls within this database session return application context values that belong only to the client session.
For example, SYS_CONTEXT('hr', 'id') returns the value robert.
10. When finished with the session, AppSvr issues the following statement to clean up the client identity:

```
DBMS_SESSION.CLEAR_IDENTIFIER ( );
```

Even if another user logged in to the database, this user cannot access the global context set by AppSvr, because AppSvr specified that only the application with user APPSMGR logged in can see it. If AppSvr used the following, then any user session with client ID set to 12345 can see the global context:

```
DBMS_SESSION.SET_CONTEXT( 'hr_ctx', 'id', 'robert', NULL , 12345 );
DBMS_SESSION.SET_CONTEXT( 'hr_ctx', 'dept', 'sales', NULL , 12345 );
```

Setting USERNAME to NULL enables different users to share the same context.

Note:

Be aware of the security implication of different settings of the global context. NULL in the user name means that any user can access the global context. A NULL client ID in the global context means that a session with an uninitialized client ID can access the global context. To ensure that only the user who has logged on can access the session, specify USER instead of NULL.

You can query the client identifier set in the session as follows:

```
SELECT SYS_CONTEXT('USERENV', 'CLIENT_IDENTIFIER') FROM DUAL;
```

The following output should appear:

```
SYS_CONTEXT('USERENV','CLIENT_IDENTIFIER')
-----
12345
```

A security administrator can see which sessions have the client identifier set by querying the `V$SESSION` view for the `CLIENT_IDENTIFIER` and `USERNAME`, for example:

```
COL client_identifier format a18
SELECT CLIENT_IDENTIFIER, USERNAME from V$SESSION;
```

The following output should appear:

```
CLIENT_IDENTIFIER  USERNAME
-----
12345                APPSMGR
```

To check the amount of global context area (in bytes) being used, use the following query:

```
SELECT SYS_CONTEXT('USERENV','GLOBAL_CONTEXT_MEMORY') FROM DUAL;
```

The following output should appear:

```
SYS_CONTEXT('USERENV','GLOBAL_CONTEXT_MEMORY')
-----
584
```

Related Topics

- [Use of the CLIENT_IDENTIFIER Attribute to Preserve User Identity](#)
The `CLIENT_IDENTIFIER` predefined attribute of the built-in application context namespace, `USERENV`, captures the application user name for use with a global application context.
- [Oracle Database SQL Language Reference](#)
- [Oracle Call Interface Developer's Guide](#)

13.5 Using Client Session-Based Application Contexts

A client session-based application context is stored in the User Global Area (UGA).

- [About Client Session-Based Application Contexts](#)
Oracle Call Interface (OCI) functions can set and clear the User Global Area (UGA) user session information.
- [Setting a Value in the CLIENTCONTEXT Namespace](#)
Oracle Call Interface (OCI) can set the `CLIENTCONTEXT` namespace.
- [Retrieving the CLIENTCONTEXT Namespace](#)
You can use Oracle Call Interface to retrieve the `CLIENTCONTEXT` namespace.
- [Example: Retrieving a Client Session ID Value for Client Session-Based Contexts](#)
The OCI `OCIStmtExecute` call can retrieve client session ID values for client session-based contexts.
- [Clearing a Setting in the CLIENTCONTEXT Namespace](#)
You can use Oracle Call Interface to clear the `CLIENTCONTEXT` namespace.
- [Clearing All Settings in the CLIENTCONTEXT Namespace](#)
You can use Oracle Call Interface (OCI) to clear the `CLIENTCONTEXT` namespace.

13.5.1 About Client Session-Based Application Contexts

Oracle Call Interface (OCI) functions can set and clear the User Global Area (UGA) user session information.

The advantage of this type of application context in a session-based application context is that an individual application can check for specific nondatabase user session data, rather than having the database perform this task. Another advantage is that the calls to set the application context value are included in the next call to the server, which improves performance.

However, be aware that application context security is compromised with a client session-based application context: any application user can set the client application context, and no check is performed in the database.

You configure the client session-based application context for the client application only. You do not configure any settings on the database server to which the client connects. Any application context settings in the database server do not affect the client session-based application context.

To configure a client session-based application context, use the `OCIAppCtxSet` OCI function. A client session-based application context uses the `CLIENTCONTEXT` namespace, updatable by any OCI client or by the existing `DBMS_SESSION` package for application context. Oracle Database performs no privilege or package security checks for this type.

The `CLIENTCONTEXT` namespace enables a single application transaction to both change the user context information and use the same user session handle to service the new user request. You can set or clear individual values for attributes in the `CLIENTCONTEXT` namespace, or clear all their values.

- An OCI client uses the `OCIAppCtx` function to set variable length data for the namespace, called `OCISessionHandle`. The OCI network single, round-trip transport sends all the information to the server in one round-trip. On the server side, you can query the application context information by using the `SYS_CONTEXT` SQL function on the namespace. For example:
- A JDBC client uses the `oracle.jdbc.internal.OracleConnection` function to achieve the same purposes.

Any user can set, clear, or collect the information in the `CLIENTCONTEXT` namespace, because it is not protected by package-based security.

Related Topics

- *Oracle Call Interface Developer's Guide*

13.5.2 Setting a Value in the CLIENTCONTEXT Namespace

Oracle Call Interface (OCI) can set the `CLIENTCONTEXT` namespace.

- To set a value in the `CLIENTCONTEXT` namespace, use the `OCIAppCTXSet` command, in the following syntax:

```
err = OCIAppCtxSet((void *) session_handle, (dvoid *) "CLIENTCONTEXT", (ub4) 13,
                  (dvoid *) attribute_name, length_of_attribute_name
                  (dvoid *) attribute_value, length_of_attribute_value, errhp,
                  OCI_DEFAULT);
```

In this specification:

- `session_handle` represents the `OCISessionHandle` namespace.
- `attribute_name` is the name of the attribute. For example, `responsibility`, with a length of 14.
- `attribute_value` is the value of the attribute. For example, `manager`, with a length of 7.

Related Topics

- *Oracle Call Interface Developer's Guide*

13.5.3 Retrieving the CLIENTCONTEXT Namespace

You can use Oracle Call Interface to retrieve the `CLIENTCONTEXT` namespace.

- To retrieve the `CLIENTCONTEXT` namespace, use the `OCIStmtExecute` call with either of the following statements:

```

- SELECT SYS_CONTEXT('CLIENTCONTEXT', 'attribute-1') FROM DUAL;
- SELECT VALUE FROM SESSION_CONTEXT WHERE NAMESPACE='CLIENTCONTEXT' AND
  ATTRIBUTE='attribute-1';

```

The `attribute-1` value can be any attribute value that has already been set in the `CLIENTCONTEXT` namespace. Oracle Database only retrieves the set attribute; otherwise, it returns `NULL`. Typically, you set the attribute by using the `OCIAppCtxSet` call. In addition, you can embed a `DBMS_SESSION.SET_CONTEXT` call in the OCI code to set the attribute value.

13.5.4 Example: Retrieving a Client Session ID Value for Client Session-Based Contexts

The OCI `OCIStmtExecute` call can retrieve client session ID values for client session-based contexts.

[Example 13-10](#) shows how to use the `OCIStmtExecute` call to retrieve a client session ID value.

Example 13-10 Retrieving a Client Session ID Value for Client Session-Based Contexts

```

oratest  clientid[31];
OCIDefine *defnp1 = (OCIDefine *) 0;
OCIStmt  *statementhandle;
oratest  *selcid = (oratest *) "SELECT SYS_CONTEXT('CLIENTCONTEXT',
                                attribute) FROM DUAL";

OCIStmtPrepare(statementhandle, errhp, selcid, (ub4) strlen((char *) selcid),
               (ub4) OCI_NTV_SYNTAX, (ub4) OCI_DEFAULT);

OCIDefineByPos(statementhandle, &defnp1, errhp, 1, (dvoid *)clientid, 31,
               SQLT_STR, (dvoid *) 0, (ub2 *) 0, (ub2 *) 0, OCI_DEFAULT);

OCIStmtExecute(servhandle, statementhandle, errhp, (ub4) 1, (ub4) 0,
               (CONST OCISnapshot *) NULL, (OCISnapshot *) NULL, OCI_DEFAULT);

printf("CLIENT_IDENTIFIER = %s \n", clientid);

```

In this example:

- `oratest`, `OCIDefine`, `OCIStmt`, and `oratest` create variables to store the client session ID, reference call for `OCIDefine`, the statement handle, and the `SELECT` statement to use.

- `OCIStmtPrepare` prepares the statement `selcid` for execution.
- `OCIDefineByPos` defines the output variable `clientid` for client session ID.
- `OCIStmtExecute` executes the statement in the `selcid` variable.
- `printf` prints the formatted output for the retrieved client session ID.

13.5.5 Clearing a Setting in the CLIENTCONTEXT Namespace

You can use Oracle Call Interface to clear the `CLIENTCONTEXT` namespace.

- To clear a setting in `CLIENTCONTEXT`, set the value to `NULL` or to an empty string by using one of the following commands:

- The following command sets the empty string to zero:

```
(void) OCIAppCtxSet((void *) session_handle, (dvoid *)"CLIENTCONTEXT", 13,
                   (dvoid *)attribute_name, length_of_attribute_name,
                   (dvoid *)0, 0, errhp,
                   OCI_DEFAULT);
```

- This following command sets the empty string to a blank value:

```
(void) OCIAppCtxSet((void *) session_handle, (dvoid *)"CLIENTCONTEXT", 13,
                   (dvoid *)attribute_name, length_of_attribute_name,
                   (dvoid *)"", 0, errhp,
                   OCI_DEFAULT);
```

13.5.6 Clearing All Settings in the CLIENTCONTEXT Namespace

You can use Oracle Call Interface (OCI) to clear the `CLIENTCONTEXT` namespace.

- To clear the namespace, use the `OCIAppCtxClearAll` command in the following form:

```
err = OCIAppCtxClearAll((void *) session_handle,
                       (dvoid *)"CLIENTCONTEXT", 13,
                       errhp,
                       OCI_DEFAULT);
```

13.6 Application Context Data Dictionary Views

Oracle Database provides data dictionary views that provide information about application contexts.

[Table 13-3](#) lists these data dictionary views.

Table 13-3 Data Dictionary Views That Display Information about Application Contexts

View	Description
<code>ALL_CONTEXT</code>	Describes all context namespaces in the current session for which attributes and values were specified using the <code>DBMS_SESSION.SET_CONTEXT</code> procedure. It lists the namespace and its associated schema and PL/SQL package.
<code>ALL_POLICY_CONTEXTS</code>	Describes the driving contexts defined for the synonyms, tables, and views accessible to the current user. (A driving context is a context used in a Virtual Private Database policy.)

Table 13-3 (Cont.) Data Dictionary Views That Display Information about Application Contexts

View	Description
DBA_CONTEXT	Provides all context namespace information in the database. Its columns are the same as those in the ALL_CONTEXT view, except that it includes the TYPE column. The TYPE column describes how the application context is accessed or initialized.
DBA_OBJECTS	Provides the names of existing application contexts. Query the OBJECT_TYPE column of the DBA_OBJECTS view, as follows: <pre>SELECT OBJECT_NAME FROM DBA_OBJECTS WHERE OBJECT_TYPE = 'CONTEXT';</pre>
DBA_POLICY_CONTEXTS	Describes all driving contexts in the database that were added by the DBMS_RLS.ADD_POLICY_CONTEXT procedure. Its columns are the same as those in ALL_POLICY_CONTEXTS.
SESSION_CONTEXT	Describes the context attributes and their values set for the current session.
USER_POLICY_CONTEXTS	Describes the driving contexts defined for the synonyms, tables, and views owned by the current user. Its columns (except for OBJECT_OWNER) are the same as those in ALL_POLICY_CONTEXTS.
V\$CONTEXT	Lists set attributes in the current PDB session. Users do not have access to this view unless you grant the user the SELECT privilege on it.
V\$SESSION	Lists detailed information about each current PDB session. Users do not have access to this view unless you grant the user the SELECT privilege on it.

 **Tip:**

In addition to these views, check the database trace file if you find errors when running applications that use application contexts. The USER_DUMP_DEST initialization parameter sets the directory location of the trace files. You can find the value of this parameter by issuing SHOW PARAMETER USER_DUMP_DEST in SQL*Plus.

Related Topics

- *Oracle Database Reference*
- *Oracle Database SQL Tuning Guide*

14

Using Oracle Virtual Private Database to Control Data Access

Oracle Virtual Private Database (VPD) enables you to filter users who access data.

- [About Oracle Virtual Private Database](#)
Oracle Virtual Private Database (VPD) provides important benefits for filtering user access to data.
- [Components of an Oracle Virtual Private Database Policy](#)
A VPD policy uses a function to generate the dynamic `WHERE` clause, and a policy to attach the function to objects to protect.
- [Configuration of Oracle Virtual Private Database Policies](#)
The `DBMS_RLS` PL/SQL package can configure Oracle Virtual Private Database (VPD) policies.
- [Tutorials: Creating Oracle Virtual Private Database Policies](#)
These tutorials show how to create a simple and a database session-based Oracle Virtual Private policy, and how to create policy groups.
- [How Oracle Virtual Private Database Works with Other Oracle Features](#)
You should be aware of the impact of using Oracle Virtual Private Database with other Oracle features.
- [Oracle Virtual Private Database Data Dictionary Views](#)
Oracle Database provides data dictionary views that list information about Oracle Virtual Private Database policies.

14.1 About Oracle Virtual Private Database

Oracle Virtual Private Database (VPD) provides important benefits for filtering user access to data.

- [What Is Oracle Virtual Private Database?](#)
Oracle Virtual Private Database (VPD) creates security policies to control database access at the row and column level.
- [Benefits of Using Oracle Virtual Private Database Policies](#)
Oracle Virtual Private Database policies provide the important benefits.
- [Who Can Create Oracle Virtual Private Database Policies?](#)
The `DBMS_RLS` PL/SQL package enables you to create Oracle Virtual Private Database (VPD) policies.
- [Privileges to Run Oracle Virtual Private Database Policy Functions](#)
You should be aware of the correct privileges for running Oracle Virtual Private Database (VPD) policy functions.
- [Oracle Virtual Private Database Use with an Application Context](#)
You can use application contexts with Oracle Virtual Private Database policies.

- [Oracle Virtual Private Database in a Multitenant Environment](#)
You can create Virtual Private Database policies in an application root for use throughout any associated application PDBs.

14.1.1 What Is Oracle Virtual Private Database?

Oracle Virtual Private Database (VPD) creates security policies to control database access at the row and column level.

Essentially, Oracle Virtual Private Database adds a dynamic `WHERE` clause to a SQL statement that is issued against the table, view, or synonym to which an Oracle Virtual Private Database security policy was applied.

Oracle Virtual Private Database enforces security, to a fine level of granularity, directly on database tables, views, or synonyms. Because you attach security policies directly to these database objects, and the policies are automatically applied whenever a user accesses data, there is no way to bypass security.

When a user directly or indirectly accesses a table, view, or synonym that is protected with an Oracle Virtual Private Database policy, Oracle Database dynamically modifies the SQL statement of the user. This modification creates a `WHERE` condition (called a predicate) returned by a function implementing the security policy. Oracle Database modifies the statement dynamically, transparently to the user, using any condition that can be expressed in or returned by a function. You can apply Oracle Virtual Private Database policies to `SELECT`, `INSERT`, `UPDATE`, `INDEX`, and `DELETE` statements.

For example, suppose a user performs the following query:

```
SELECT * FROM OE.ORDERS;
```

The Oracle Virtual Private Database policy dynamically appends the statement with a `WHERE` clause. For example:

```
SELECT * FROM OE.ORDERS  
WHERE SALES_REP_ID = 159;
```

In this example, the user can only view orders by Sales Representative 159.

If you want to filter the user based on the session information of that user, such as the ID of the user, then you can create the `WHERE` clause to use an application context. For example:

```
SELECT * FROM OE.ORDERS  
WHERE SALES_REP_ID = SYS_CONTEXT('USERENV', 'SESSION_USER');
```

Note the following:

- Oracle Database release 12c introduced Real Application Security (RAS) to supersede VPD. Oracle recommends that you use RAS for new projects that require row and column level access controls for their applications.
- Oracle Database does not protect tables and views that have VPD policies against the `SYS` user and against users who have an out-of-the-box database administrator role. The Oracle Database-supplied `DBA` role has privileges that can alter and remove VPD policies, and hence can access table and view data.

- Oracle Virtual Private Database does not support filtering for DDLs, such as `TRUNCATE` or `ALTER TABLE` statements.

Related Topics

- [Auditing of Oracle Virtual Private Database Predicates](#)
The unified audit trail automatically captures the predicates that are used in Oracle Virtual Private Database (VPD) policies.

14.1.2 Benefits of Using Oracle Virtual Private Database Policies

Oracle Virtual Private Database policies provide the important benefits.

- [Security Policies Based on Database Objects Rather Than Applications](#)
Oracle Virtual Private Database provides benefits in security, simplicity, and flexibility.
- [Control Over How Oracle Database Evaluates Policy Functions](#)
Running policy functions multiple times can affect performance.

14.1.2.1 Security Policies Based on Database Objects Rather Than Applications

Oracle Virtual Private Database provides benefits in security, simplicity, and flexibility.

Attaching Oracle Virtual Private Database security policies to database tables, views, or synonyms, rather than implementing access controls in all your applications, provides the following benefits:

- **Security.** Associating a policy with a database table, view, or synonym can solve a potentially serious application security problem. Suppose a user is authorized to use an application, and then drawing on the privileges associated with that application, wrongfully modifies the database by using an ad hoc query tool, such as SQL*Plus. By attaching security policies directly to tables, views, or synonyms, fine-grained access control ensures that the same security is in force, no matter how a user accesses the data.
- **Simplicity.** You add the security policy to a table, view, or synonym only once, rather than repeatedly adding it to each of your table-based, view-based, or synonym-based applications.
- **Flexibility.** You can have one security policy for `SELECT` statements, another for `INSERT` statements, and still others for `UPDATE` and `DELETE` statements. For example, you might want to enable Human Resources clerks to have `SELECT` privileges for all employee records in their division, but to update only salaries for those employees in their division whose last names begin with A through F. Furthermore, you can create multiple policies for each table, view, or synonym.

14.1.2.2 Control Over How Oracle Database Evaluates Policy Functions

Running policy functions multiple times can affect performance.

You can control the performance of policy functions by configuring how Oracle Database caches the Oracle Virtual Private Database predicates.

The following options are available:

- Evaluate the policy once for each query (static policies).
- Evaluate the policy only when an application context within the policy function changes (context-sensitive policies).
- Evaluate the policy each time it is run (dynamic policies).

Related Topics

- [Optimizing Performance by Using Oracle Virtual Private Database Policy Types](#)
You can optimize performance by using the Oracle Virtual Private Database (VPD) the dynamic, static, or shared policy types.

14.1.3 Who Can Create Oracle Virtual Private Database Policies?

The `DBMS_RLS` PL/SQL package enables you to create Oracle Virtual Private Database (VPD) policies.

You must be granted the `EXECUTE` privilege on the `DBMS_RLS` PL/SQL package to create Oracle Virtual Private Database policies. You must also be granted the `ADMINISTER ROW LEVEL SECURITY POLICY` system privilege in one of the following ways:

- Syntax of the `ADMINISTER ROW LEVEL SECURITY POLICY` privilege grant if the VPD policy is to apply to all non-SYS schemas across the database:

```
GRANT ADMINISTER ROW LEVEL SECURITY POLICY TO grantee;
```

- Syntax of the `ADMINISTER ROW LEVEL SECURITY POLICY` privilege grant if the VPD policy is to be restricted to a specific schema:

```
GRANT ADMINISTER ROW LEVEL SECURITY POLICY ON SCHEMA schema TO grantee;
```

As with all privileges, an administrator must only grant these privileges to trusted users. You can find the privileges that a user has been granted by querying the `DBA_SYS_PRIVS` data dictionary view.

14.1.4 Privileges to Run Oracle Virtual Private Database Policy Functions

You should be aware of the correct privileges for running Oracle Virtual Private Database (VPD) policy functions.

For greater security, the Oracle Virtual Private Database policy function runs as if it had been declared with definer's rights.

Do not declare it as invoker's rights because this can confuse yourself and other users who maintain the code.

Related Topics

- [Oracle Database PL/SQL Language Reference](#)

14.1.5 Oracle Virtual Private Database Use with an Application Context

You can use application contexts with Oracle Virtual Private Database policies.

When you create an application context, it securely caches user information. Only the designated application package can set the cached environment. It cannot be changed by the user or outside the package. In addition, because the data is cached, performance is increased.

For example, suppose you want to base access to the `ORDERS_TAB` table on the customer ID number. Rather than querying the customer ID number for a logged-in user each time you need it, you could store the number in the application context. Then, the customer number is available in the session when you need it.

Application contexts are especially helpful if your security policy is based on multiple security attributes. For example, if a policy function bases a `WHERE` predicate on four attributes (such as employee number, cost center, position, spending limit), then multiple subqueries must run to retrieve this information. Instead, if this data is available through an application context, then performance is much faster.

You can use an application context to return the correct security policy, enforced through a predicate. For example, consider an order entry application that enforces the following rules: customers only see their own orders, and clerks see all orders for all customers. These are two different policies. You could define an application context with a `position` attribute, and this attribute could be accessed within the policy function to return the correct predicate, depending on the value of the attribute. Thus, you can enable a user in the `clerk` position to retrieve all orders, but a user in the `customer` position can see only those records associated with that particular user.

To design a fine-grained access control policy that returns a specific predicate for an attribute, you need to access the application context within the function that implements the policy. For example, suppose you want to limit customers to seeing only their own records. The user performs the following query:

```
SELECT * FROM orders_tab
```

Fine-grained access control dynamically modifies this query to include the following `WHERE` predicate:

```
SELECT * FROM orders_tab
  WHERE custno = SYS_CONTEXT ('order_entry', 'cust_num');
```

Continuing with the preceding example, suppose you have 50,000 customers, and you do not want to have a different predicate returned for each customer. Customers all share the same `WHERE` predicate, which prescribes that they can only see their own orders. It is merely their customer numbers that are different.

Using application context, you can return one `WHERE` predicate within a policy function that applies to 50,000 customers. As a result, there is one shared cursor that executes differently for each customer, because the customer number is evaluated at execution time. This value is different for every customer. Use of application context in this case provides optimum performance, and at row-level security.

The `SYS_CONTEXT` function works much like a bind variable; only the `SYS_CONTEXT` arguments are constants.

Related Topics

- [Using Application Contexts to Retrieve User Information](#)
An application context stores user identification that can enable or prevent a user from accessing data in the database.

14.1.6 Oracle Virtual Private Database in a Multitenant Environment

You can create Virtual Private Database policies in an application root for use throughout any associated application PDBs.

The CDB restriction applies to shared context sensitive policies and views related to Virtual Private Database policies as well. You cannot create a Virtual Private Database policy for an entire multitenant environment.

With regard to application containers, you can create Virtual Private Database policies to protect application common objects by applying the common policy to all PDBs that belong to

the application root. In other words, when you install an application in the application root, all the common Virtual Private Database policies that protect the common objects will be applied to and immediately enforced for all PDBs in the application container.

Note the following:

- You can only create the common Virtual Private Database policy and its associated PL/SQL function in the application root and only attach it to application common objects. If the function is not in the same location as the policy, then an error is raised at runtime.
- A Virtual Private Database policy that is applied to common objects is considered a common policy that will be automatically enforced in PDBs that belong to the application container when it accesses the application common objects from application PDBs.
- Application common Virtual Private Database policies can only protect application common objects.
- A Virtual Private Database policy that is applied to application common objects in the application root and is applied to all application PDBs is considered a common Virtual Private Database policy. A policy that is applied to a local database table and enforced in one PDB is considered a local Virtual Private Database policy.

For example, if policy `VPD_P1` is applied to the application common table `T1` in the application root, then it is considered to be a common policy. It will be enforced in each application PDB. If a policy named `VPD_P1` is applied to a local table called `T1` in `PDB1`, then it is considered a local policy, which means that it affects only `PDB1`. If a policy called `VPD_P1` is applied to a local table `T1` in the application root, then it is still considered a local policy because it affects only the application root. This concept applies to other operations, such as enabling, disabling, and removing Virtual Private Database policies.

- Application common Virtual Private Database policies only protect application common objects, while local Virtual Private Database policies only protect local objects.
- If you are using application contexts, then ensure common database session-based application contexts and common global application context objects are used in the common Virtual Private Database configuration.
- Application container Virtual Private Database policies are stored in the application root. PDBs store only local policies. If you plug a PDB into the application container, then the common policies are not converted to local policies. Instead, Oracle Database loads them from the application root and enforces them in the local PDB when the policies access common objects in the local PDB.

14.2 Components of an Oracle Virtual Private Database Policy

A VPD policy uses a function to generate the dynamic `WHERE` clause, and a policy to attach the function to objects to protect.

- [Function to Generate the Dynamic WHERE Clause](#)
The Oracle Virtual Private Database (VPD) function defines the restrictions that you want to enforce.
- [Policies to Attach the Function to the Objects You Want to Protect](#)
The Oracle Virtual Private Database policy associates the VPD function with a table, view, or synonym.

14.2.1 Function to Generate the Dynamic WHERE Clause

The Oracle Virtual Private Database (VPD) function defines the restrictions that you want to enforce.

To generate the Oracle Virtual Private Database (VPD) dynamic `WHERE` clause (predicate), you must create a function (not a procedure) that defines these restrictions. This function is a definer's rights function. Oracle Database generates the predicate with the VPD policy function authorized by the owner but in the same current user session such that the PL/SQL global variables that are defined in the function will be used.

Usually, the security administrator creates this function in their own schema. For more complex behavior, such as including calls to other functions or adding checks to track failed logon attempts, create these functions within a package.

The function must have the following behavior:

- **It must take as arguments a schema name and an object (table, view, or synonym) name as inputs.** Define input parameters to hold this information, but do not specify the schema and object name themselves within the function. The policy that you create to attach the function to the objects that you want to protect, using the `DBMS_RLS` package, provides the names of the schema, and object to which the policy will apply. You must create the parameter for the schema first, followed by the parameter for the object.
- **It must provide a return value for the `WHERE` clause predicate that will be generated.** The return value for the `WHERE` clause is always a `VARCHAR2` data type.
- **It must generate a valid `WHERE` clause.** This code can be as simple in that it applies to every user who logs in the database instance, but in most cases, you may want to design the `WHERE` clause to be different for each user, each group of users, or each application that accesses the objects you want to protect. For example, if a manager logs in, the `WHERE` clause can be specific to the rights of that particular manager. You can do this by incorporating an application context, which accesses user session information, into the `WHERE` clause generation code.

You can create Oracle Virtual Private Database functions that do not use an application context, but an application context creates a much stronger Oracle Virtual Private Database policy, by securely basing user access on the session attributes of that user, such as the user ID.

In addition, you can embed C or Java calls to access operating system information or to return `WHERE` clauses from an operating system file or other source.

- **It must not select from a table within the associated policy function.** Although you can define a policy against a table, you cannot select that table from within the policy that was defined against the table.
- **It must be a pure function.** The VPD function must rely only on the application context and the arguments that are passed to the function to generate the `WHERE` clause. This function must not depend on the package variables.

 **Note:**

If you plan to run the function across different editions, you can control the results of the function: whether the results are uniform across all editions, or specific to the edition in which the function is run.

Related Topics

- [Policies to Attach the Function to the Objects You Want to Protect](#)
The Oracle Virtual Private Database policy associates the VPD function with a table, view, or synonym.

- [Tutorial: Creating a Simple Oracle Virtual Private Database Policy](#)
This tutorial shows how to create a simple Oracle Virtual Private Database policy using the `OE` user account.
- [Tutorial: Implementing a Session-Based Application Context Policy](#)
This tutorial demonstrates how to create an Oracle Virtual Private Database policy that uses a database session-based application context.
- [Using Application Contexts to Retrieve User Information](#)
An application context stores user identification that can enable or prevent a user from accessing data in the database.
- [How Editions Affects the Results of a Global Application Context PL/SQL Package](#)
Global application context packages, Oracle Virtual Private Database packages, and fine-grained audit policies can be used across multiple editions.

14.2.2 Policies to Attach the Function to the Objects You Want to Protect

The Oracle Virtual Private Database policy associates the VPD function with a table, view, or synonym.

You create the policy by using the `DBMS_RLS` package. If you are not `SYS`, then you must be granted `EXECUTE` privileges to use the `DBMS_RLS` package. This package contains procedures that enable you to manage the policy and set fine-grained access control. For example, to attach the policy to a table, you use the `DBMS_RLS.ADD_POLICY` procedure. Within this setting, you set fine-grained access control, such as setting the policy to go into effect when a user issues a `SELECT` or `UPDATE` statement on the table or view.

The combination of creating the function and then applying it to a table or view is referred to as creating the Oracle Virtual Private Database policy.

Related Topics

- [Configuration of Oracle Virtual Private Database Policies](#)
The `DBMS_RLS` PL/SQL package can configure Oracle Virtual Private Database (VPD) policies.
- [Tutorials: Creating Oracle Virtual Private Database Policies](#)
These tutorials show how to create a simple and a database session-based Oracle Virtual Private policy, and how to create policy groups.

14.3 Configuration of Oracle Virtual Private Database Policies

The `DBMS_RLS` PL/SQL package can configure Oracle Virtual Private Database (VPD) policies.

- [About Oracle Virtual Private Database Policies](#)
The Oracle Virtual Private Database policy associates the VPD function with a database table, view, or synonym.
- [Attaching a Policy to a Database Table, View, or Synonym](#)
The `DBMS_RLS` PL/SQL package can attach a policy to a table, view, or synonym.
- [Example: Attaching a Simple Oracle Virtual Private Database Policy to a Table](#)
The `DBMS_RLS.ADD_POLICY` procedure can attach an Oracle Virtual Private Database (VPD) policy to a table, view, or synonym.
- [Enforcing Policies on Specific SQL Statement Types](#)
You can enforce Oracle Virtual Private Database policies for `SELECT`, `INSERT`, `UPDATE`, `INDEX`, and `DELETE` statements.

- [Example: Specifying SQL Statement Types with DBMS_RLS.ADD_POLICY](#)
The `DBMS_RLS.ADD_POLICY` procedure `statement_types` parameter can specify the `SELECT` and `INDEX` statements for a policy.
- [Control of the Display of Column Data with Policies](#)
You can create policies that enforce row-level security when a security-relevant column is referenced in a query.
- [Oracle Virtual Private Database Policy Groups](#)
An Oracle Virtual Private Database policy group is a named collection of VPD policies that can be applied to an application.
- [Optimizing Performance by Using Oracle Virtual Private Database Policy Types](#)
You can optimize performance by using the Oracle Virtual Private Database (VPD) the dynamic, static, or shared policy types.

14.3.1 About Oracle Virtual Private Database Policies

The Oracle Virtual Private Database policy associates the VPD function with a database table, view, or synonym.

This function defines the actions of the Oracle Virtual Private Database `WHERE` clause. You must then associate this function with the database table to which the Oracle Virtual Private Database (VPD) action applies.

You can do this by configuring an Oracle Virtual Private Database policy. The policy is a mechanism for managing the Virtual Private Database function. The policy also enables you to add fine-grained access control, such as specifying the types of SQL statements or particular table columns the policy affects. When a user tries to access the data in this database object, the policy goes into effect automatically.

[Table 14-1](#) lists the procedures in the `DBMS_RLS` package.

Table 14-1 DBMS_RLS Procedures

Procedure	Description
For Handling Individual Policies	
<code>DBMS_RLS.ADD_POLICY</code>	Adds a policy to a table, view, or synonym
<code>DBMS_RLS.ENABLE_POLICY</code>	Enables (or disables) a policy that is previously created on a table, view, or synonym
<code>DBMS_RLS.ALTER_POLICY</code>	Alters an existing policy to associate or disassociate attributes with the policy
<code>DBMS_RLS.REFRESH_POLICY</code>	Invalidates cursors associated with nonstatic policies
<code>DBMS_RLS.DROP_POLICY</code>	To drop a policy from a table, view, or synonym
For Handling Grouped Policies	
<code>DBMS_RLS.CREATE_POLICY_GROUP</code>	Creates a policy group
<code>DBMS_RLS.ALTER_GROUPED_POLICY</code>	Alters a policy group
<code>DBMS_RLS.DELETE_POLICY_GROUP</code>	Drops a policy group
<code>DBMS_RLS.ADD_GROUPED_POLICY</code>	Adds a policy to the specified policy group
<code>DBMS_RLS.ENABLE_GROUPED_POLICY</code>	Enables a policy within a group

Table 14-1 (Cont.) DBMS_RLS Procedures

Procedure	Description
DBMS_RLS.REFRESH_GROUPED_POLICY	Parses again the SQL statements associated with a refreshed policy
DBMS_RLS.DISABLE_GROUPED_POLICY	Disables a policy within a group
DBMS_RLS.DROP_GROUPED_POLICY	Drops a policy that is a member of the specified group
For Handling Application Contexts	
	-
DBMS_RLS.ADD_POLICY_CONTEXT	Adds the application context for the active application
DBMS_RLS.DROP_POLICY_CONTEXT	Drops the context for the application

Related Topics

- [Components of an Oracle Virtual Private Database Policy](#)
A VPD policy uses a function to generate the dynamic WHERE clause, and a policy to attach the function to objects to protect.
- [Using Application Contexts to Retrieve User Information](#)
An application context stores user identification that can enable or prevent a user from accessing data in the database.

14.3.2 Attaching a Policy to a Database Table, View, or Synonym

The DBMS_RLS PL/SQL package can attach a policy to a table, view, or synonym.

- To attach a policy to a database table, view, or synonym, use the DBMS_RLS.ADD_POLICY procedure.

You must specify the table, view, or synonym to which you are adding a policy, and a name for the policy. You can also specify other information, such as the types of statements the policy controls (SELECT, INSERT, UPDATE, DELETE, CREATE INDEX, or ALTER INDEX).

Follow these guidelines:

- If a view has been created as an extended data-linked object, then Oracle recommends that you apply the same VPD policy on this type of view as you would on the underlying objects of the view.

This applies to secondary tables made for use with hybrid vector indexes and Oracle Text indexes. For more information, see the [Guidelines and Restrictions for Hybrid Vector Indexes](#) in the *Oracle Database AI Vector Search User's Guide* and *Oracle Text Application Developer's Guide*, respectively.
- Determine if the base object to which you want to add the VPD policy has dependent objects. If it does have dependent objects, then these objects will become invalid when the VPD policy is added to the base object, and these objects will be recompiled automatically when they are used.

Alternatively, you can proactively recompile them yourself by using an ALTER ... COMPIL statement. Be aware that invalidating dependent objects (by adding a VPD policy on their base object) and causing them to need to be recompiled can decrease performance in the overall system. Oracle recommends that you only add a VPD policy to an object that has dependent objects during off-peak hours or during a scheduled downtime.

- Be aware that the maximum number of policies that can be created for a single object is 255.

14.3.3 Example: Attaching a Simple Oracle Virtual Private Database Policy to a Table

The `DBMS_RLS.ADD_POLICY` procedure can attach an Oracle Virtual Private Database (VPD) policy to a table, view, or synonym.

[Example 14-1](#) shows how to use `DBMS_RLS.ADD_POLICY` to attach an Oracle Virtual Private Database policy called `secure_update` to the `HR.EMPLOYEES` table. The function attached to the policy is `check_updates`.

Example 14-1 Attaching a Simple Oracle Virtual Private Database Policy to a Table

```
BEGIN
  DBMS_RLS.ADD_POLICY(
    object_schema => 'hr',
    object_name   => 'employees',
    policy_name   => 'secure_update',
    policy_function => 'check_updates',
    ...
  )
```

If the function was created inside a package, include the package name. For example:

```
policy_function => 'pkg.check_updates',
...
```

Although you can define a policy against a table, you cannot select that table from within the policy that was defined against the table.

14.3.4 Enforcing Policies on Specific SQL Statement Types

You can enforce Oracle Virtual Private Database policies for `SELECT`, `INSERT`, `UPDATE`, `INDEX`, and `DELETE` statements.

- To specify a SQL statement type for the policy, use the `statement_types` parameter in the `DBMS_RLS.ADD_POLICY` procedure. If you want to specify more than one, separate each with a comma. Enclose the list in a pair of single quotation marks.

If you do not specify a statement type, then by default, Oracle Database specifies `SELECT`, `INSERT`, `UPDATE`, and `DELETE`, but not `INDEX`. You can enter any combination of these statement types.

When you specify the `statement_types` parameter, be aware of the following functionality:

- **The application code affected by the Virtual Private Database policy can include the `MERGE INTO` statement.** However, in the Virtual Private Database policy, you must ensure that the `statement_types` parameter includes all three of the `INSERT`, `UPDATE`, and `DELETE` statements for the policy to succeed. Alternatively, you can omit the `statement_types` parameter.
- **Be aware that a user who has privileges to maintain an index can see all the row data, even if the user does not have full table access under a regular query such as `SELECT`.** For example, a user can create a function-based index that contains a user-defined function with column values as its arguments. During index creation, Oracle Database passes column values of every row into the user function, making the row data available to the user who creates the index. You can enforce Oracle Virtual Private

Database policies on index maintenance operations by specifying `INDEX` with the `statement_types` parameter.

14.3.5 Example: Specifying SQL Statement Types with `DBMS_RLS.ADD_POLICY`

The `DBMS_RLS.ADD_POLICY` procedure `statement_types` parameter can specify the `SELECT` and `INDEX` statements for a policy.

[Example 14-2](#) shows an how this works.

Example 14-2 Specifying SQL Statement Types with `DBMS_RLS.ADD_POLICY`

```
BEGIN
  DBMS_RLS.ADD_POLICY(
    object_schema => 'hr',
    object_name   => 'employees',
    policy_name   => 'secure_update',
    policy_function => 'check_updates',
    statement_types => 'SELECT,INDEX');
END;
/
```

14.3.6 Control of the Display of Column Data with Policies

You can create policies that enforce row-level security when a security-relevant column is referenced in a query.

- [Policies for Column-Level Oracle Virtual Private Database](#)
Column-level policies enforce row-level security when a query references a security-relevant column.
- [Example: Creating a Column-Level Oracle Virtual Private Database Policy](#)
The `CREATE FUNCTION` statement and the `DBMS_RLS.ADD_POLICY` procedure can configure a column-level Oracle Virtual Private Database policy.
- [Display of Only the Column Rows Relevant to the Query](#)
By default, column-level Oracle Virtual Private Database restricts the number of rows a query returns that references columns containing sensitive information.
- [Column Masking to Display Sensitive Columns as NULL Values](#)
If a query references a sensitive column, then by default column-level Oracle Virtual Private Database restricts the number of rows returned.
- [Example: Adding Column Masking to an Oracle Virtual Private Database Policy](#)
The `DBMS_RLS.ADD_POLICY` procedure can configure column-level Oracle Virtual Private Database column masking.

14.3.6.1 Policies for Column-Level Oracle Virtual Private Database

Column-level policies enforce row-level security when a query references a security-relevant column.

You can apply a column-level Oracle Virtual Private Database policy to tables and views, but not to synonyms. To apply the policy to a column, specify the security-relevant column by using the `SEC_RELEVANT_COLS` parameter of the `DBMS_RLS.ADD_POLICY` procedure. This parameter applies the security policy whenever the column is referenced, explicitly or implicitly, in a query.

For example, users who are not in a Human Resources department typically are allowed to view only their own Social Security numbers. A sales clerk initiates the following query:

```
SELECT fname, lname, ssn FROM emp;
```

The function implementing the security policy returns the predicate `ssn='my_ssn'`. Oracle Database rewrites the query and executes the following:

```
SELECT fname, lname, ssn FROM emp
WHERE ssn = 'my_ssn';
```

14.3.6.2 Example: Creating a Column-Level Oracle Virtual Private Database Policy

The `CREATE FUNCTION` statement and the `DBMS_RLS.ADD_POLICY` procedure can configure a column-level Oracle Virtual Private Database policy.

[Example 14-3](#) shows an Oracle Virtual Private Database policy in which sales department users cannot see the salaries of people outside the department (department number 30) of the sales department users. The relevant columns for this policy are `sal` and `comm`. First, the Oracle Virtual Private Database policy function is created, and then it is added by using the `DBMS_RLS` PL/SQL package.

Example 14-3 Creating a Column-Level Oracle Virtual Private Database Policy

```
CREATE OR REPLACE FUNCTION hide_sal_comm (
  v_schema IN VARCHAR2,
  v_objname IN VARCHAR2)

RETURN VARCHAR2 AS
con VARCHAR2 (200);

BEGIN
  con := 'deptno=30';
  RETURN (con);
END hide_sal_comm;
```

Then you configure the policy with the `DBMS_RLS.ADD_POLICY` procedure as follows:

```
BEGIN
  DBMS_RLS.ADD_POLICY (
    object_schema => 'scott',
    object_name   => 'emp',
    policy_name   => 'hide_sal_policy',
    policy_function => 'hide_sal_comm',
    sec_relevant_cols => 'sal,comm');
END;
```

14.3.6.3 Display of Only the Column Rows Relevant to the Query

By default, column-level Oracle Virtual Private Database restricts the number of rows a query returns that references columns containing sensitive information.

You specify these security-relevant columns by using the `SEC_RELEVANT_COLUMNS` parameter of the `DBMS_RLS.ADD_POLICY` procedure.

For example, consider sales department users with the `SELECT` privilege on the `emp` table, which is protected with the column-level Oracle Virtual Private Database policy created earlier that illustrates how to create a column-level Oracle Virtual Private Database policy. The user (for example, user `SCOTT`) runs the following query:

```
SELECT ENAME, d.dname, JOB, SAL, COMM
FROM emp e, dept d
WHERE d.deptno = e.deptno;
```

The database returns the following rows:

ENAME	DNAME	JOB	SAL	COMM
ALLEN	SALES	SALESREP	1600	300
WARD	SALES	SALESREP	1250	500
MARTIN	SALES	SALESREP	1250	1400
BLAKE	SALES	MANAGER	2850	
TURNER	SALES	SALESREP	1500	0
JAMES	SALES	CLERK	950	

6 rows selected.

The only rows that are displayed are those that the user has privileges to access all columns in the row.

Related Topics

- [Example: Creating a Column-Level Oracle Virtual Private Database Policy](#)
The `CREATE FUNCTION` statement and the `DBMS_RLS.ADD_POLICY` procedure can configure a column-level Oracle Virtual Private Database policy.

14.3.6.4 Column Masking to Display Sensitive Columns as NULL Values

If a query references a sensitive column, then by default column-level Oracle Virtual Private Database restricts the number of rows returned.

With column-masking behavior, all rows display, even those that reference sensitive columns. However, the sensitive columns display as `NULL` values. To enable column-masking, set the `SEC_RELEVANT_COLS_opt` parameter of the `DBMS_RLS.ADD_POLICY` procedure.

For example, consider the results of the sales clerk query, described in the previous example. If column-masking is used, then instead of seeing only the row containing the details and Social Security number of the sales clerk, the clerk would see all rows from the `emp` table, but the `ssn` column values would be returned as `NULL`. Note that this behavior is fundamentally different from all other types of Oracle Virtual Private Database policies, which return only a subset of rows.

In contrast to the default action of column-level Oracle Virtual Private Database, column-masking displays all rows, but returns sensitive column values as `NULL`. To include column-masking in your policy, set the `SEC_RELEVANT_COLS_OPT` parameter of the `DBMS_RLS.ADD_POLICY` procedure to `DBMS_RLS.ALL_ROWS`.

The following considerations apply to column masking:

- Column-masking applies only to `SELECT` statements.
- Column-masking conditions generated by the policy function must be simple Boolean expressions, unlike regular Oracle Virtual Private Database predicates.
- For applications that perform calculations, or do not expect `NULL` values, use standard column-level Oracle Virtual Private Database, specifying `SEC_RELEVANT_COLS` rather than the `SEC_RELEVANT_COLS_OPT` column-masking option.
- Do not include columns of the object data type (including the `XMLtype`) in the `sec_relevant_cols` setting. This column type is not supported for the `sec_relevant_cols` setting.

- Column-masking used with UPDATE AS SELECT updates only the columns that users are allowed to see.
- For some queries, column-masking may prevent some rows from displaying. For example:

```
SELECT * FROM emp
WHERE sal = 10;
```

Because the column-masking option was set, this query may not return rows if the salary column returns a NULL value.

14.3.6.5 Example: Adding Column Masking to an Oracle Virtual Private Database Policy

The DBMS_RLS.ADD_POLICY procedure can configure column-level Oracle Virtual Private Database column masking.

Example 14-4 shows column-level Oracle Virtual Private Database column masking. It uses the same VPD policy as the one created earlier that uses a column-level policy, but with sec_relevant_cols_opt specified as DBMS_RLS.ALL_ROWS.

Example 14-4 Adding Column Masking to an Oracle Virtual Private Database Policy

```
BEGIN
  DBMS_RLS.ADD_POLICY(
    object_schema => 'scott',
    object_name   => 'emp',
    policy_name   => 'hide_sal_policy',
    policy_function => 'hide_sal_comm',
    sec_relevant_cols => ' sal,comm',
    sec_relevant_cols_opt => dbms_rls.ALL_ROWS);
END;
```

Assume that a sales department user with SELECT privilege on the emp table (such as user SCOTT) runs the following query:

```
SELECT ENAME, d.dname, job, sal, comm
FROM emp e, dept d
WHERE d.deptno = e.deptno;
```

The database returns all rows specified in the query, but with certain values masked because of the Oracle Virtual Private Database policy:

ENAME	DNAME	JOB	SAL	COMM
CLARK	ACCOUNTING	MANAGER		
KING	ACCOUNTING	PRESIDENT		
MILLER	ACCOUNTING	CLERK		
JONES	RESEARCH	MANAGER		
FORD	RESEARCH	ANALYST		
ADAMS	RESEARCH	CLERK		
SMITH	RESEARCH	CLERK		
SCOTT	RESEARCH	ANALYST		
WARD	SALES	SALESREP	1250	500
TURNER	SALES	SALESREP	1500	0
ALLEN	SALES	SALESREP	1600	300
JAMES	SALES	CLERK	950	
BLAKE	SALES	MANAGER	2850	
MARTIN	SALES	SALESREP	1250	1400

14 rows selected.

The column-masking returned all rows requested by the sales user query, but made the `sal` and `comm` columns `NULL` for employees outside the sales department.

Related Topics

- [Example: Creating a Column-Level Oracle Virtual Private Database Policy](#)
The `CREATE FUNCTION` statement and the `DBMS_RLS.ADD_POLICY` procedure can configure a column-level Oracle Virtual Private Database policy.

14.3.7 Oracle Virtual Private Database Policy Groups

An Oracle Virtual Private Database policy group is a named collection of VPD policies that can be applied to an application.

- [About Oracle Virtual Private Database Policy Groups](#)
You can group multiple security policies together, and apply them to an application.
- [Creation of a New Oracle Virtual Private Database Policy Group](#)
The `DBMS_RLS.ADD_GROUPED_POLICY` procedure adds a VPD policy to a VPD policy group.
- [Default Policy Group with the SYS_DEFAULT Policy Group](#)
Within a group of security policies, you can designate one security policy to be the default security policy.
- [Multiple Policies for Each Table, View, or Synonym](#)
You can establish several policies for the same table, view, or synonym.
- [Validation of the Application Used to Connect to the Database](#)
The package implementing the driving context must correctly validate the application that is being used to connect to the database.

14.3.7.1 About Oracle Virtual Private Database Policy Groups

You can group multiple security policies together, and apply them to an application.

A policy group is a set of security policies that belong to an application. You can designate an application context (known as a *driving context* or *policy context*) to indicate the policy group in effect. Then, when a user accesses the table, view, or synonym column, Oracle Database looks up the driving context to determine the policy group in effect. It enforces all the associated policies that belong to the policy group.

Policy groups are useful for situations where multiple applications with multiple security policies share the same table, view, or synonym. This enables you to identify those policies that should be in effect when the table, view, or synonym is accessed.

For example, in a hosting environment, Company A can host the `BENEFIT` table for Company B and Company C. The table is accessed by two different applications, Human Resources and Finance, with two different security policies. The Human Resources application authorizes users based on ranking in the company, and the Finance application authorizes users based on department. Integrating these two policies into the `BENEFIT` table requires joint development of policies between the two companies, which is not a feasible option. By defining an application context to drive the enforcement of a particular set of policies to the base objects, each application can implement a private set of security policies.

To do this, you organize security policies into groups. By referring to the application context, Oracle Database determines which group of policies should be in effect at run time. The server enforces all the policies that belong to that policy group.

14.3.7.2 Creation of a New Oracle Virtual Private Database Policy Group

The `DBMS_RLS.ADD_GROUPED_POLICY` procedure adds a VPD policy to a VPD policy group.

To specify which policies will be effective, you can add a driving context using the `DBMS_RLS.ADD_POLICY_CONTEXT` procedure. If the driving context returns an unknown policy group, then an error is returned.

If the driving context is not defined, then Oracle Database runs all policies. Likewise, if the driving context is `NULL`, then policies from all policy groups are enforced. An application accessing the data cannot bypass the security setup module (which sets up application context) to avoid any applicable policies.

You can apply multiple driving contexts to the same table, view, or synonym, and each of them will be processed individually. This enables you to configure multiple active sets of policies to be enforced.

Consider, for example, a hosting company that hosts Benefits and Financial applications, which share some database objects. Both applications are striped for hosting using a `SUBSCRIBER` policy in the `SYS_DEFAULT` policy group. Data access is partitioned first by subscriber ID, then by whether the user is accessing the Benefits or Financial applications (determined by a driving context). Suppose that Company A, which uses the hosting services, wants to apply a custom policy that relates only to its own data access. You could add an additional driving context (such as `COMPANY A SPECIAL`) to ensure that the additional, special policy group is applied for data access for Company A only. You would not apply this under the `SUBSCRIBER` policy, because the policy relates only to Company A, and it is more efficient to segregate the basic hosting policy from other policies.

14.3.7.3 Default Policy Group with the `SYS_DEFAULT` Policy Group

Within a group of security policies, you can designate one security policy to be the default security policy.

This is useful in situations where you partition security policies by application, so that they will be always be in effect. Default security policies enable developers to base security enforcement under all conditions, while partitioning security policies by application (using security groups) enables layering of additional, application-specific security on top of default security policies. To implement default security policies, you add the policy to the `SYS_DEFAULT` policy group.

Policies defined in this group for a particular table, view, or synonym are run with the policy group specified by the driving context. As described earlier, a driving context is an application context that indicates the policy group in effect. The `SYS_DEFAULT` policy group may or may not contain policies. You cannot to drop the `SYS_DEFAULT` policy group. If you do, then Oracle Database displays an error.

If, to the `SYS_DEFAULT` policy group, you add policies associated with two or more objects, then each object will have a separate `SYS_DEFAULT` policy group associated with it. For example, the `emp` table in the `scott` schema has one `SYS_DEFAULT` policy group, and the `dept` table in the `scott` schema has a different `SYS_DEFAULT` policy group associated with it. Think of them as being organized in the tree structure as follows:

```
SYS_DEFAULT
- policy1 (scott/emp)
- policy3 (scott/emp)
SYS_DEFAULT
- policy2 (scott/dept)
```

You can create policy groups with identical names. When you select a particular policy group, its associated schema and object name are displayed in the property sheet on the right side of the screen.

14.3.7.4 Multiple Policies for Each Table, View, or Synonym

You can establish several policies for the same table, view, or synonym.

Suppose, for example, you have a base application for Order Entry, and each division of your company has its own rules for data access. You can add a division-specific policy function to a table without having to rewrite the policy function of the base application.

All policies applied to a table are enforced with `AND` syntax. If you have three policies applied to the `CUSTOMERS` table, then each policy is applied to the table. You can use policy groups and an application context to partition fine-grained access control enforcement so that different policies apply, depending upon which application is accessing data. This eliminates the requirement for development groups to collaborate on policies, and simplifies application development. You can also have a default policy group that is always applicable (for example, to enforce data separated by subscriber in a hosting environment).

14.3.7.5 Validation of the Application Used to Connect to the Database

The package implementing the driving context must correctly validate the application that is being used to connect to the database.

Although Oracle Database checks the call stack to ensure that the package implementing the driving context sets context attributes, inadequate validation can still occur within the package. For example, in applications where database users or enterprise users are known to the database, the user needs the `EXECUTE` privilege on the package that sets the driving context. Consider a user who knows that the `BENEFITS` application enables more liberal access than the `HR` application. The `setctx` procedure (which sets the correct policy group within the driving context) does not perform any validation to determine which application is actually connecting. That is, the procedure does not check either the IP address of the incoming connection (for a three-tier system) or the `proxy_user` attribute of the user session.

This user could pass to the driving context package an argument setting the context to the more liberal `BENEFITS` policy group, and then access the `HR` application instead. Because the `setctx` does no further validation of the application, this user bypasses the more restrictive `HR` security policy.

By contrast, if you implement proxy authentication with Oracle Virtual Private Database, then you can determine the identity of the middle tier (and the application) that is connecting to the database on behalf of a user. The correct policy will be applied for each application to mediate data access.

For example, a developer using the proxy authentication feature could determine that the application (the middle tier) connecting to the database is `HRAPPSERVER`. The package that implements the driving context can thus verify whether the `proxy_user` in the user session is `HRAPPSERVER`. If so, then it can set the driving context to use the `HR` policy group. If `proxy_user` is not `HRAPPSERVER`, then it can deny access.

In this case, the following query is executed:

```
SELECT * FROM apps.benefit;
```

Oracle Database picks up policies from the default policy group (`SYS_DEFAULT`) and active namespace `HR`. The query is internally rewritten as follows:

```
SELECT * FROM apps.benefit
WHERE company = SYS_CONTEXT('ID','MY_COMPANY')
AND SYS_CONTEXT('ID','TITLE') = 'MANAGER';
```

14.3.8 Optimizing Performance by Using Oracle Virtual Private Database Policy Types

You can optimize performance by using the Oracle Virtual Private Database (VPD) the dynamic, static, or shared policy types.

- [About Oracle Virtual Private Database Policy Types](#)
Specifying a policy type for your policies can optimize performance each the Oracle Virtual Private Database policy runs.
- [Dynamic Policy Type to Automatically Rerun Policy Functions](#)
The `DYNAMIC` policy type runs the policy function each time a user accesses the Virtual Private Database-protected database objects.
- [Example: Creating a DYNAMIC Policy with DBMS_RLS.ADD_POLICY](#)
The `DBMS_RLS.ADD_POLICY` procedure can create a dynamic Oracle Virtual Private Database policy.
- [Static Policy to Prevent Policy Functions from Rerunning for Each Query](#)
The static policy type enforces the same predicate for all users in the instance.
- [Example: Creating a Static Policy with DBMS_RLS.ADD_POLICY](#)
The `DBMS_RLS.ADD_POLICY` procedure can create a static Oracle Virtual Private Database (VPD) policy.
- [Example: Shared Static Policy to Share a Policy with Multiple Objects](#)
The `DBMS_RLS.ADD_POLICY` procedure can create a shared static Oracle Virtual Private Database policy to share the policy with multiple objects.
- [When to Use Static and Shared Static Policies](#)
Static policies are ideal when every query requires the same predicate and fast performance is essential, such as hosting environments.
- [Context-Sensitive Policy for Application Context Attributes That Change](#)
Context-sensitive policies are useful when different predicates must be applied depending on which user executes the query.
- [Example: Creating a Context-Sensitive Policy with DBMS_RLS.ADD_POLICY](#)
The `DBMS_RLS.ADD_POLICY` procedure can create an Oracle Virtual Private Database context-sensitive policy.
- [Example: Refreshing Cached Statements for a VPD Context-Sensitive Policy](#)
The `DBMS_RLS.REFRESH_POLICY` statement can refresh cached statements for Oracle Virtual Private Database context-sensitive policies.
- [Example: Altering an Existing Context-Sensitive Policy](#)
The `DBMS_RLS.ALTER_POLICY` procedure can modify an Oracle Virtual Private Database policy.
- [Example: Using a Shared Context Sensitive Policy to Share a Policy with Multiple Objects](#)
The `DBMS_RLS.ADD_POLICY` procedure can create a shared context-sensitive Oracle Virtual Private Database to share a policy that has multiple objects.
- [When to Use Context-Sensitive and Shared Context-Sensitive Policies](#)
Use context-sensitive policies when a predicate does not need to change for a user session, but the policy must enforce multiple predicates for different users or groups.

- [Summary of the Five Oracle Virtual Private Database Policy Types](#)
 Oracle Virtual Private Database provides five policy types, based on user needs such as hosting environments.

14.3.8.1 About Oracle Virtual Private Database Policy Types

Specifying a policy type for your policies can optimize performance each the Oracle Virtual Private Database policy runs.

Policy types control how Oracle Database caches Oracle Virtual Private Database policy predicates. Consider setting a policy type for your policies, because the execution of policy functions can use a significant amount of system resources. Minimizing the number of times that a policy function can run optimizes database performance.

You can choose from five policy types: `DYNAMIC`, `STATIC`, `SHARED_STATIC`, `CONTEXT_SENSITIVE`, and `SHARED_CONTEXT_SENSITIVE`. These enable you to precisely specify how often a policy predicate should change. To specify the policy type, set the `policy_type` parameter of the `DBMS_RLS.ADD_POLICY` procedure.

14.3.8.2 Dynamic Policy Type to Automatically Rerun Policy Functions

The `DYNAMIC` policy type runs the policy function each time a user accesses the Virtual Private Database-protected database objects.

If you do not specify a policy type in the `DBMS_RLS.ADD_POLICY` procedure, then, by default, your policy will be dynamic. You can specifically configure a policy to be dynamic by setting the `policy_type` parameter of the `DBMS_RLS.ADD_POLICY` procedure to `DYNAMIC`.

This policy type does not optimize database performance as the static and context sensitive policy types do. However, Oracle recommends that before you set policies as either static or context-sensitive, you should first test them as `DYNAMIC` policy types, which run every time. Testing policy functions as `DYNAMIC` policies first enables you to observe how the policy function affects each query, because nothing is cached. This ensures that the functions work properly before you enable them as static or context-sensitive policy types to optimize performance.

You can use the `DBMS_UTILITY.GET_TIME` function to measure the start and end times for a statement to run. For example:

```
-- 1. Get the start time:
SELECT DBMS_UTILITY.GET_TIME FROM DUAL;

   GET_TIME
-----
  2312721

-- 2. Run the statement:
SELECT COUNT(*) FROM HR.EMPLOYEES;

   COUNT(*)
-----
         107

-- 3. Get the end time:
SELECT DBMS_UTILITY.GET_TIME FROM DUAL;

   GET_TIME
-----
  2314319
```

Related Topics

- [Auditing Functions, Procedures, Packages, and Triggers](#)
You can audit functions, procedures, PL/SQL packages, and triggers.

14.3.8.3 Example: Creating a DYNAMIC Policy with DBMS_RLS.ADD_POLICY

The `DBMS_RLS.ADD_POLICY` procedure can create a dynamic Oracle Virtual Private Database policy.

[Example 14-5](#) shows how to create the `DYNAMIC` policy type.

Example 14-5 Creating a DYNAMIC Policy with DBMS_RLS.ADD_POLICY

```
BEGIN
  DBMS_RLS.ADD_POLICY(
    object_schema => 'hr',
    object_name   => 'employees',
    policy_name   => 'secure_update',
    policy_function => 'hide_fin',
    policy_type   => dbms_ols.DYNAMIC);
END;
/
```

14.3.8.4 Static Policy to Prevent Policy Functions from Rerunning for Each Query

The static policy type enforces the same predicate for all users in the instance.

Oracle Database stores static policy predicates in SGA, so policy functions do not rerun for each query. This results in faster performance.

You can enable static policies by setting the `policy_type` parameter of the `DBMS_RLS.ADD_POLICY` procedure to either `STATIC` or `SHARED_STATIC`, depending on whether or not you want the policy to be shared across multiple objects.

Each execution of the same cursor could produce a different row set for the same predicate, because the predicate may filter the data differently based on attributes such as `SYS_CONTEXT` or `SYSDATE`.

For example, suppose you enable a policy as either a `STATIC` or `SHARED_STATIC` policy type, which appends the following predicate to all queries made against policy protected database objects:

```
WHERE dept = SYS_CONTEXT ('hr_app', 'deptno')
```

Although the predicate does not change for each query, it applies to the query based on session attributes of the `SYS_CONTEXT`. In the case of the preceding example, the predicate returns only those rows where the department number matches the `deptno` attribute of the `SYS_CONTEXT`, which is the department number of the user who is querying the policy-protected database object.

 **Note:**

When using shared static policies, ensure that the policy predicate does not contain attributes that are specific to a particular database object, such as a column name.

Related Topics

- [Auditing Functions, Procedures, Packages, and Triggers](#)
You can audit functions, procedures, PL/SQL packages, and triggers.

14.3.8.5 Example: Creating a Static Policy with DBMS_RLS.ADD_POLICY

The `DBMS_RLS.ADD_POLICY` procedure can create a static Oracle Virtual Private Database (VPD) policy.

[Example 14-6](#) shows how to create the `STATIC` policy type.

Example 14-6 Creating a Static Policy with DBMS_RLS.ADD_POLICY

```
BEGIN
  DBMS_RLS.ADD_POLICY(
    object_schema => 'hr',
    object_name   => 'employees',
    policy_name   => 'secure_update',
    policy_function => 'hide_fin',
    policy_type   => DBMS_RLS.STATIC);
END;
/
```

14.3.8.6 Example: Shared Static Policy to Share a Policy with Multiple Objects

The `DBMS_RLS.ADD_POLICY` procedure can create a shared static Oracle Virtual Private Database policy to share the policy with multiple objects.

If, for example, you wanted to apply the static policy that was created earlier to a second table in the `HR` schema that may contain financial data that you want to hide, you could use the `SHARED_STATIC` setting for both tables.

[Example 14-7](#) shows how to set the `SHARED_STATIC` policy type for two tables that share the same policy.

Example 14-7 Creating a Shared Static Policy to Share a Policy with Multiple Objects

```
-- 1. Create a policy for the first table, employees:
BEGIN
  DBMS_RLS.ADD_POLICY(
    object_schema => 'hr',
    object_name   => 'employees',
    policy_name   => 'secure_update',
    policy_function => 'hide_fin',
    policy_type   => dbms_rls.SHARED_STATIC);
END;
/

-- 2. Create a policy for the second table, fin_data:
BEGIN
  DBMS_RLS.ADD_POLICY(
    object_schema => 'hr',
    object_name   => 'fin_data',
    policy_name   => 'secure_update',
    policy_function => 'hide_fin',
    policy_type   => dbms_rls.SHARED_STATIC);
END;
/
```

Related Topics

- [Example: Creating a Static Policy with DBMS_RLS.ADD_POLICY](#)
The `DBMS_RLS.ADD_POLICY` procedure can create a static Oracle Virtual Private Database (VPD) policy.

14.3.8.7 When to Use Static and Shared Static Policies

Static policies are ideal when every query requires the same predicate and fast performance is essential, such as hosting environments.

For these situations when the policy function appends the same predicate to every query, rerunning the policy function each time adds unnecessary overhead to the system. For example, consider a data warehouse that contains market research data for customer organizations that are competitors. The warehouse must enforce the policy that each organization can see only their own market research, which is expressed by the following predicate:

```
WHERE subscriber_id = SYS_CONTEXT('customer', 'cust_num')
```

Using `SYS_CONTEXT` for the application context enables the database to dynamically change the rows that are returned. You do not need to rerun the function, so the predicate can be cached in the SGA, thus conserving system resources and improving performance.

14.3.8.8 Context-Sensitive Policy for Application Context Attributes That Change

Context-sensitive policies are useful when different predicates must be applied depending on which user executes the query.

For example, consider the case where managers should have the predicate `WHERE group set to managers`, and employees should have the predicate `WHERE empno_ctx set to emp_id`. A context-sensitive policy will enable you to present only the information that the managers must see when the managers log in, and only the information that the employees must see when they log in. The policy uses application contexts to determine which predicate to use.

In contrast to static policies, context-sensitive policies do not always cache the predicate. With context-sensitive policies, the database assumes that the predicate will change after statement parse time. But if there is no change in the local application context, then Oracle Database does not rerun the policy function within the user session. If there is a change in any attribute of any application context during the user session, then by default the database re-executes the policy function to ensure that it captures all changes to the predicate since the initial parsing. This results in unnecessary re-executions of the policy function if none of the associated attributes have changed. You can restrict the evaluation to a specific application context by including both the `namespace` and `attribute` parameters.

If you plan to use the `namespace` and `attribute` parameters in your policy, then follow these guidelines:

- Ensure that you specify both `namespace` and `attribute` parameters, not just one.
- Ensure that your policy has the `policy_type` argument set to `DBMS_RLS.CONTEXT_SENSITIVE` or `SHARED_CONTEXT_SENSITIVE`. You cannot use the `namespace` and `attribute` parameters in static or dynamic policies.

If there are no attributes associated with the Virtual Private Database policy function, then Oracle Database evaluates the context-sensitive function for any application context changes.

Shared context-sensitive policies operate in the same way as regular context-sensitive policies, except they can be shared across multiple database objects. For this policy type, all

objects can share the policy function from the UGA, where the predicate is cached until the local session context changes.

Related Topics

- [Example: Using a Shared Context Sensitive Policy to Share a Policy with Multiple Objects](#)
The `DBMS_RLS.ADD_POLICY` procedure can create a shared context-sensitive Oracle Virtual Private Database to share a policy that has multiple objects.
- [Tutorial: Implementing a Session-Based Application Context Policy](#)
This tutorial demonstrates how to create an Oracle Virtual Private Database policy that uses a database session-based application context.
- [Tutorial: Implementing an Oracle Virtual Private Database Policy Group](#)
This tutorial demonstrates how to create an Oracle Virtual Private Database policy group.

14.3.8.9 Example: Creating a Context-Sensitive Policy with DBMS_RLS.ADD_POLICY

The `DBMS_RLS.ADD_POLICY` procedure can create an Oracle Virtual Private Database context-sensitive policy.

[Example 14-8](#) shows how to create a `CONTEXT_SENSITIVE` policy in which the policy is evaluated only for changes to the `empno_ctx` namespace and `emp_id` attribute.

Example 14-8 Creating a Context-Sensitive Policy with DBMS_RLS.ADD_POLICY

```
BEGIN
  DBMS_RLS.ADD_POLICY(
    object_schema => 'hr',
    object_name   => 'employees',
    policy_name   => 'secure_update',
    policy_function => 'hide_fin',
    policy_type   => dbms_ols.CONTEXT_SENSITIVE,
    namespace    => 'empno_ctx',
    attribute     => 'emp_id');
END;
/
```

14.3.8.10 Example: Refreshing Cached Statements for a VPD Context-Sensitive Policy

The `DBMS_RLS.REFRESH_POLICY` statement can refresh cached statements for Oracle Virtual Private Database context-sensitive policies.

[Example 14-9](#) shows you can manually refresh all the cached statements that are associated with a Virtual Private Database context-sensitive policy by running the `DBMS_RLS.REFRESH_POLICY` procedure.

Example 14-9 Refreshing Cached Statements for a VPD Context-Sensitive Policy

```
BEGIN
  DBMS_RLS.REFRESH_POLICY(
    object_schema => 'hr',
    object_name   => 'employees',
    policy_name   => 'secure_update');
END;
/
```

14.3.8.11 Example: Altering an Existing Context-Sensitive Policy

The `DBMS_RLS.ALTER_POLICY` procedure can modify an Oracle Virtual Private Database policy.

[Example 14-10](#) shows how you can use the `DBMS_RLS.ALTER_POLICY` statement to alter an existing context-sensitive policy so that the `order_update_pol` policy function is executed only if the relevant context attributes change.

Example 14-10 Altering an Existing Context-Sensitive Policy

```
BEGIN
  DBMS_RLS.ALTER_POLICY(
    object_schema => 'oe',
    object_name   => 'orders',
    policy_name   => 'order_update_pol',
    alter_option  => DBMS_RLS.ADD_ATTRIBUTE_ASSOCIATION,
    namespace    => 'empno_ctx',
    attribute     => 'emp_role');
END;
/
```

14.3.8.12 Example: Using a Shared Context Sensitive Policy to Share a Policy with Multiple Objects

The `DBMS_RLS.ADD_POLICY` procedure can create a shared context-sensitive Oracle Virtual Private Database to share a policy that has multiple objects.

[Example 14-11](#) shows how to create two shared context sensitive policies that share a policy with multiple tables, and how to restrict the evaluation only for changes to the `empno_ctx` namespace and `emp_id` attribute.

Example 14-11 Shared Context-Sensitive Policy with DBMS_RLS.ADD_POLICY

```
-- 1. Create a policy for the first table, employees:
BEGIN
  DBMS_RLS.ADD_POLICY(
    object_schema => 'hr',
    object_name   => 'employees',
    policy_name   => 'secure_update',
    policy_function => 'hide_fin',
    policy_type   => dbms_rls.SHARED_CONTEXT_SENSITIVE,
    namespace    => 'empno_ctx',
    attribute     => 'emp_id');
END;
/

--2. Create a policy for the second table, fin_data:
BEGIN
  DBMS_RLS.ADD_POLICY(
    object_schema => 'hr',
    object_name   => 'fin_data',
    policy_name   => 'secure_update',
    policy_function => 'hide_fin',
    policy_type   => dbms_rls.SHARED_CONTEXT_SENSITIVE,
    namespace    => 'empno_ctx',
    attribute     => 'emp_id');
END;
/
```

Note the following:

- When using shared context-sensitive policies, ensure that the policy predicate does not contain attributes that are specific to a particular database object, such as a column name.
- To manually refresh all the cached statements that are associated with a Virtual Private Database shared context-sensitive policy, run the `DBMS_RLS.REFRESH_GROUPED_POLICY` procedure.

14.3.8.13 When to Use Context-Sensitive and Shared Context-Sensitive Policies

Use context-sensitive policies when a predicate does not need to change for a user session, but the policy must enforce multiple predicates for different users or groups.

For example, consider a `sales_history` table with a single policy. This policy states that analysts can see only their own products and regional employees can see only their own region. In this case, the database must rerun the policy function each time the type of user changes. The performance gain is realized when a user can log in and issue several DML statements against the protected object without causing the server to rerun the policy function.



Note:

For session pooling where multiple clients share a database session, the middle tier must reset the context during client switches.

14.3.8.14 Summary of the Five Oracle Virtual Private Database Policy Types

Oracle Virtual Private Database provides five policy types, based on user needs such as hosting environments.

Table 14-2 summarizes the types of policy types available.

Table 14-2 DBMS_RLS.ADD_POLICY Policy Types

Policy Types	When the Policy Function Runs	Usage Example	Shared Across Multiple Objects ?
DYNAMIC	Policy function re-runs every time a policy-protected database object is accessed.	Applications where policy predicates must be generated for each query, such as time-dependent policies where users are denied access to database objects at certain times during the day	No
STATIC	Once, then the predicate is cached in the SGA. Each execution of the same cursor could produce a different row set for the same predicate because the predicate may filter the data differently based on attributes such as <code>SYS_CONTEXT</code> or <code>SYSDATE</code> .	View replacement	No
SHARED_STATIC	Same as <code>STATIC</code>	Hosting environments, such as data warehouses where the same predicate must be applied to multiple database objects	Yes

Table 14-2 (Cont.) DBMS_RLS.ADD_POLICY Policy Types

Policy Types	When the Policy Function Runs	Usage Example	Shared Across Multiple Objects ?
CONTEXT_SENSITIVE	<ul style="list-style-type: none"> At statement parse time At statement execution time when the local application context changed since the last use of the cursor 	Three-tier, session pooling applications where policies enforce two or more predicates for different users or groups	No
SHARED_CONTEXT_SENSITIVE	<p>First time the object is reference in a database session.</p> <p>Predicates are cached in the private session memory UGA so policy functions can be shared among objects.</p>	Same as CONTEXT_SENSITIVE, but multiple objects can share the policy function from the session UGA	Yes

14.4 Tutorials: Creating Oracle Virtual Private Database Policies

These tutorials show how to create a simple and a database session-based Oracle Virtual Private policy, and how to create policy groups.

- [Tutorial: Creating a Simple Oracle Virtual Private Database Policy](#)
This tutorial shows how to create a simple Oracle Virtual Private Database policy using the OE user account.
- [Tutorial: Implementing a Session-Based Application Context Policy](#)
This tutorial demonstrates how to create an Oracle Virtual Private Database policy that uses a database session-based application context.
- [Tutorial: Implementing an Oracle Virtual Private Database Policy Group](#)
This tutorial demonstrates how to create an Oracle Virtual Private Database policy group.

14.4.1 Tutorial: Creating a Simple Oracle Virtual Private Database Policy

This tutorial shows how to create a simple Oracle Virtual Private Database policy using the OE user account.

- [About This Tutorial](#)
This tutorial shows how to create a VPD policy that limits access to orders created by Sales Representative 159 in the OE.ORDERS table.
- [Step 1: Ensure That the OE User Account Is Active](#)
First, you must ensure that OE user account is active.
- [Step 2: Create a Policy Function](#)
Next, you are ready to create a policy function.
- [Step 3: Create the Oracle Virtual Private Database Policy](#)
After you create the policy function, you are ready to associate it with a VPD policy.
- [Step 4: Test the Policy](#)
After you create the Oracle Virtual Private Database policy, it goes into effect immediately.
- [Step 5: Remove the Components of This Tutorial](#)
If you no longer need the components of this tutorial, then you can remove them.

14.4.1.1 About This Tutorial

This tutorial shows how to create a VPD policy that limits access to orders created by Sales Representative 159 in the `OE.ORDERS` table.

In essence, the policy translates the following statement:

```
SELECT * FROM OE.ORDERS;
```

To the following statement:

```
SELECT * FROM OE.ORDERS WHERE SALES_REP_ID = 159;
```

14.4.1.2 Step 1: Ensure That the OE User Account Is Active

First, you must ensure that `OE` user account is active.

1. Log in to a PDB as user `SYS` with the `SYSDBA` administrative privilege.

```
sqlplus sys@pdb_name as sysdba
Enter password: password
```

To find the available PDBs in a CDB, log in to the CDB root container and then query the `PDB_NAME` column of the `DBA_PDBS` data dictionary view. To check the current container, run the `show con_name` command.

2. Query the `DBA_USERS` data dictionary view to find the account status of `OE`.

```
SELECT USERNAME, ACCOUNT_STATUS FROM DBA_USERS WHERE USERNAME = 'OE';
```

The status should be `OPEN`. If the `DBA_USERS` view lists user `OE` as locked and expired, then enter the following statement to unlock the `OE` account and create a new password:

```
ALTER USER OE ACCOUNT UNLOCK IDENTIFIED BY password;
```

Replace `password` with a password that is secure. For greater security, do not reuse the same password that was used in previous releases of Oracle Database.

Related Topics

- [Guidelines for Securing Passwords](#)
Oracle provides guidelines for securing passwords in a variety of situations.

14.4.1.3 Step 2: Create a Policy Function

Next, you are ready to create a policy function.

- As user `SYS`, create the following function, which will append the `WHERE SALES_REP_ID = 159` clause to any `SELECT` statement on the `OE.ORDERS` table.

```
CREATE OR REPLACE FUNCTION auth_orders(
  schema_var IN VARCHAR2,
  table_var  IN VARCHAR2
)
RETURN VARCHAR2
IS
  return_val VARCHAR2 (400);
BEGIN
  return_val := 'SALES_REP_ID = 159';
```

```

    RETURN return_val;
END auth_orders;
/

```

In this example:

- `schema_var` and `table_var` create input parameters to specify to store the schema name, OE, and table name, ORDERS. First, define the parameter for the schema, and then define the parameter for the object, in this case, a table. Always create them in this order. The Virtual Private Database policy you create will need these parameters to specify the OE.ORDERS table.
- `RETURN VARCHAR2` returns the string that will be used for the `WHERE` predicate clause. Remember that return value is always a `VARCHAR2` data type.
- `IS ... RETURN return_val` encompasses the creation of the `WHERE SALES_REP_ID = 159` predicate.

14.4.1.4 Step 3: Create the Oracle Virtual Private Database Policy

After you create the policy function, you are ready to associate it with a VPD policy.

- Create the following policy by using the `ADD_POLICY` procedure in the `DBMS_RLS` package.

```

BEGIN
  DBMS_RLS.ADD_POLICY (
    object_schema => 'oe',
    object_name   => 'orders',
    policy_name   => 'orders_policy',
    function_schema => 'sys',
    policy_function => 'auth_orders',
    statement_types => 'select'
  );
END;
/

```

In this example:

- `object_schema => 'oe'` specifies the schema that you want to protect, that is, OE.
- `object_name => 'orders'` specifies the object within the schema to protect, that is, the ORDERS table.
- `policy_name => 'orders_policy'` names this policy `orders_policy`.
- `function_schema => 'sys'` specifies the schema in which the `auth_orders` function was created. In this example, `auth_orders` was created in the `SYS` schema. But typically, it should be created in the schema of a security administrator.
- `policy_function => 'auth_orders'` specifies a function to enforce the policy. Here, you specify the `auth_orders` function that you created in the preceding step, when you created the policy function.
- `statement_types => 'select'` specifies the operations to which the policy applies. In this example, the policy applies to all `SELECT` statements that the user may perform.

Related Topics

- [Step 2: Create a Policy Function](#)
Next, you are ready to create a policy function.

14.4.1.5 Step 4: Test the Policy

After you create the Oracle Virtual Private Database policy, it goes into effect immediately.

The next time a user, including the owner of the schema, performs a `SELECT` on `OE.ORDERS`, only the orders by Sales Representative 159 will be accessed.

1. Connect as user `OE`.

```
CONNECT oe@pdb_name
Enter password: password
```

2. Enter the following `SELECT` statement:

```
SELECT COUNT(*) FROM ORDERS;
```

The following output should appear:

```
COUNT(*)
-----
          7
```

The policy is in effect for user `OE`: As you can see, only 7 of the 105 rows in the orders table are returned.

But users with administrative privileges still have access to all the rows in the table.

3. Connect as user `SYS` with the `SYSDBA` administrative privilege.

```
CONNECT SYS@pdb_name AS SYSDBA
Enter password: password
```

4. Enter the following `SELECT` statement:

```
SELECT COUNT(*) FROM OE.ORDERS;
```

The following output should appear:

```
COUNT(*)
-----
        105
```

14.4.1.6 Step 5: Remove the Components of This Tutorial

If you no longer need the components of this tutorial, then you can remove them.

1. As user `SYS` in the PDB in which you created the tutorial components, remove the function and policy as follows:

```
DROP FUNCTION auth_orders;
EXEC DBMS_RLS.DROP_POLICY('OE','ORDERS','ORDERS_POLICY');
```

2. If you need to lock and expire the `OE` account, then enter the following statement:

```
ALTER USER OE ACCOUNT LOCK PASSWORD EXPIRE;
```

14.4.2 Tutorial: Implementing a Session-Based Application Context Policy

This tutorial demonstrates how to create an Oracle Virtual Private Database policy that uses a database session-based application context.

- [About This Tutorial](#)
This tutorial shows how to use a database session-based application context to implement a policy in which customers see only their own orders.
- [Step 1: Create User Accounts and Sample Tables](#)
First, create user accounts and the sample tables.
- [Step 2: Create a Database Session-Based Application Context](#)
Next, you are ready to create the database session-based application context.
- [Step 3: Create a PL/SQL Package to Set the Application Context](#)
After you create the application context, you are ready to create a package to set the context.
- [Step 4: Create a Logon Trigger to Run the Application Context PL/SQL Package](#)
The logon trigger runs the PL/SQL package procedure so that the next time a user logs on, the application context is set.
- [Step 5: Test the Logon Trigger](#)
The logon trigger sets the application context for the user when the trigger runs the `sysadmin_vpd.orders_ctx_pkg.set_custnum` procedure.
- [Step 6: Create a PL/SQL Policy Function to Limit User Access to Their Orders](#)
The next step is to create a PL/SQL function to control the display of the user's query.
- [Step 7: Create the New Security Policy](#)
Finally, you are ready to create the VPD security policy.
- [Step 8: Test the New Policy](#)
Now that you have created all the components, you are ready to test the policy.
- [Step 9: Remove the Components of This Tutorial](#)
If you no longer need the components of this tutorial, then you can remove them.

14.4.2.1 About This Tutorial

This tutorial shows how to use a database session-based application context to implement a policy in which customers see only their own orders.

In this tutorial, you create the following layers of security:

1. When a user logs on, a database session-based application context checks whether the user is a customer. If a user is not a customer, the user still can log on, but this user cannot access the orders entry table you will create for this example.
2. If the user is a customer, then they can log on. After the customer has logged on, an Oracle Virtual Private Database policy restricts this user to see only their orders.
3. As a further restriction, the Oracle Virtual Private Database policy prevents users from adding, modifying, or removing orders.

14.4.2.2 Step 1: Create User Accounts and Sample Tables

First, create user accounts and the sample tables.

1. Log in to a PDB as a user who has administrative privileges.

```
sqlplus sys@pdb_name as sysdba
Enter password: password
```

To find the available PDBs in a CDB, log in to the CDB root container and then query the PDB_NAME column of the DBA_PDBS data dictionary view. To check the current container, run the show con_name command.

2. Create the following administrative user, who will administer the Oracle Virtual Private Database policy.

The following SQL statements create this user and then grant the user the necessary privileges for completing this tutorial.

```
CREATE USER sysadmin_vpd IDENTIFIED BY password CONTAINER = CURRENT;
GRANT CREATE SESSION, CREATE ANY CONTEXT, CREATE PROCEDURE, CREATE TRIGGER, ADMINISTER DATABASE
TRIGGER TO sysadmin_vpd;
GRANT EXECUTE ON DBMS_SESSION TO sysadmin_vpd;
GRANT EXECUTE ON DBMS_RLS TO sysadmin_vpd;
GRANT ADMINISTER ROW LEVEL SECURITY POLICY TO sysadmin_vpd;
```

Replace *password* with a password that is secure.

3. Create the following local users:

```
CREATE USER tbrooke IDENTIFIED BY password CONTAINER = CURRENT;
CREATE USER owoods IDENTIFIED BY password CONTAINER = CURRENT;

GRANT CREATE SESSION TO tbrooke, owoods;
```

Replace *password* with a password that is secure.

4. Check the account status of the sample user SCOTT, who you will use for this tutorial:

```
SELECT USERNAME, ACCOUNT_STATUS FROM DBA_USERS WHERE USERNAME = 'SCOTT';
```

The status should be OPEN. If the DBA_USERS view lists user SCOTT as locked and expired, then enter the following statement to unlock the SCOTT account and create a new password for him:

```
ALTER USER SCOTT ACCOUNT UNLOCK IDENTIFIED BY password;
```

Replace *password* with a password that is secure. For greater security, do not reuse the same password that was used in previous releases of Oracle Database.

5. Connect as user SCOTT.

```
CONNECT SCOTT@pdb_name
Enter password: password
```

6. Create and populate the customers table.

```
CREATE TABLE customers (
  cust_no    NUMBER(4),
  cust_email VARCHAR2(20),
  cust_name  VARCHAR2(20));

INSERT INTO customers VALUES (1234, 'TBROOKE', 'Thadeus Brooke');
INSERT INTO customers VALUES (5678, 'OWOODS', 'Oberon Woods');
```

When you enter the user email IDs, enter them in upper-case letters. Later on, when you create the application context PL/SQL package, the SESSION_USER parameter of the SYS_CONTEXT function expects the user names to be in upper case. Otherwise, you will be unable to set the application context for the user.

7. User `sysadmin_vpd` will need `SELECT` privileges for the `customers` table, so as user `SCOTT`, grant him this privilege.

```
GRANT READ ON customers TO sysadmin_vpd;
```

8. Create and populate the `orders_tab` table.

```
CREATE TABLE orders_tab (
  cust_no NUMBER(4),
  order_no NUMBER(4));

INSERT INTO orders_tab VALUES (1234, 9876);
INSERT INTO orders_tab VALUES (5678, 5432);
INSERT INTO orders_tab VALUES (5678, 4592);
```

9. Users `tbrooke` and `owoods` need to query the `orders_tab` table, so grant them the `READ` object privilege.

```
GRANT READ ON orders_tab TO tbrooke, owoods;
```

At this stage, the two sample customers, `tbrooke` and `owoods`, have a record of purchases in the `orders_tab` order entry table, and if they tried right now, they can see all the orders in this table.

Related Topics

- [Guidelines for Securing Passwords](#)
Oracle provides guidelines for securing passwords in a variety of situations.

14.4.2.3 Step 2: Create a Database Session-Based Application Context

Next, you are ready to create the database session-based application context.

1. Connect as user `sysadmin_vpd`.

```
CONNECT sysadmin_vpd@pdb_name
Enter password: password
```

2. Enter the following statement:

```
CREATE OR REPLACE CONTEXT orders_ctx USING orders_ctx_pkg;
```

This statement creates the `orders_ctx` application context. Remember that even though user `sysadmin_vpd` has created this context and it is associated with the `sysadmin_vpd` schema, the `SYS` schema owns the application context.

14.4.2.4 Step 3: Create a PL/SQL Package to Set the Application Context

After you create the application context, you are ready to create a package to set the context.

- As user `sysadmin_vpd`, create the following PL/SQL package, which will set the database session-based application context when the customers `tbrooke` and `owoods` log onto their accounts.

```
CREATE OR REPLACE PACKAGE orders_ctx_pkg IS
  PROCEDURE set_custnum;
END;
/
CREATE OR REPLACE PACKAGE BODY orders_ctx_pkg IS
  PROCEDURE set_custnum
  AS
    custnum NUMBER;
```

```

BEGIN
  SELECT cust_no INTO custnum FROM SCOTT.CUSTOMERS
     WHERE cust_email = SYS_CONTEXT('USERENV', 'SESSION_USER');
  DBMS_SESSION.SET_CONTEXT('orders_ctx', 'cust_no', custnum);
EXCEPTION
  WHEN NO_DATA_FOUND THEN NULL;
END set_custnum;
END;
/

```

In this example:

- `custnum NUMBER` creates the `custnum` variable, which will hold the customer ID.
- `SELECT cust_no INTO custnum` performs a `SELECT` statement to copy the customer ID that is stored in the `cust_no` column data from the `scott.customers` table into the `custnum` variable.
- `WHERE cust_email = SYS_CONTEXT('USERENV', 'SESSION_USER')` uses a `WHERE` clause to find all the customer IDs that match the user name of the user who is logging on.
- `DBMS_SESSION.SET_CONTEXT('orders_ctx', 'cust_no', custnum)` sets the `orders_ctx` application context values by creating the `cust_no` attribute and then setting it to the value stored in the `custnum` variable.
- `EXCEPTION ... WHEN` adds a `WHEN NO_DATA_FOUND` system exception to catch any `no data found` errors that may result from the `SELECT` statement in the `SELECT cust_no INTO custnum ...` statement.

To summarize, the `sysadmin_vpd.set_custnum` procedure identifies whether or not the session user is a registered customer by attempting to select the user's customer ID into the `custnum` variable. If the user is a registered customer, then Oracle Database sets an application context value for this user. The policy function uses the context value to control the access a user has to data in the `orders_tab` table.

14.4.2.5 Step 4: Create a Logon Trigger to Run the Application Context PL/SQL Package

The logon trigger runs the PL/SQL package procedure so that the next time a user logs on, the application context is set.

- As user `sysadmin_vpd`, create the following logon trigger:

```

CREATE TRIGGER set_custno_ctx_trig AFTER LOGON ON DATABASE
BEGIN
  sysadmin_vpd.orders_ctx_pkg.set_custnum;
END;
/

```

Related Topics

- [Logon Triggers to Run a Database Session Application Context Package](#)
Users must run database session application context package after when they log in to the database instance.

14.4.2.6 Step 5: Test the Logon Trigger

The logon trigger sets the application context for the user when the trigger runs the `sysadmin_vpd.orders_ctx_pkg.set_custnum` procedure.

1. Connect as user `tbrooke`.

```
CONNECT tbrooke@pdb_name
Enter password: password
```

2. Run the following query:

```
SELECT SYS_CONTEXT('orders_ctx', 'cust_no') custnum FROM DUAL;
```

The following output should appear:

```
EMP_ID
-----
1234
```

14.4.2.7 Step 6: Create a PL/SQL Policy Function to Limit User Access to Their Orders

The next step is to create a PL/SQL function to control the display of the user's query.

When the user who has logged in performs a `SELECT * FROM SCOTT.ORDERS_TAB` query, the function should cause the output to display only the orders of that user.

1. Connect as user `sysadmin_vpd`.

```
CONNECT sysadmin_vpd@pdb_name
Enter password: password
```

2. Create the following function:

```
CREATE OR REPLACE FUNCTION get_user_orders (
  schema_p  IN VARCHAR2,
  table_p   IN VARCHAR2)
RETURN VARCHAR2
AS
  orders_pred VARCHAR2 (400);
BEGIN
  orders_pred := 'cust_no = SYS_CONTEXT(''orders_ctx'', ''cust_no'')';
RETURN orders_pred;
END;
/
```

This function creates and returns a `WHERE` predicate that translates to "where the orders displayed belong to the user who has logged in." It then appends this `WHERE` predicate to any queries this user may run against the `scott.orders_tab` table. Next, you are ready to create an Oracle Virtual Private Database policy that applies this function to the `orders_tab` table.

14.4.2.8 Step 7: Create the New Security Policy

Finally, you are ready to create the VPD security policy.

- As user `sysadmin_vpd`, use the `DBMS_RLS.ADD_POLICY` procedure to create the policy as follows:

```
BEGIN
  DBMS_RLS.ADD_POLICY (
```

```

object_schema => 'scott',
object_name   => 'orders_tab',
policy_name   => 'orders_policy',
function_schema => 'sysadmin_vpd',
policy_function => 'get_user_orders',
statement_types => 'select',
policy_type   => DBMS_RLS.CONTEXT_SENSITIVE,
namespace    => 'orders_ctx',
attribute     => 'cust_no');
END;
/

```

This statement creates a policy named `orders_policy` and applies it to the `orders_tab` table, which customers will query for their orders, in the `SCOTT` schema. The `get_user_orders` function implements the policy, which is stored in the `sysadmin_vpd` schema. The policy further restricts users to issuing `SELECT` statements only. The `namespace` and `attribute` parameters specify the application context that you created earlier.

14.4.2.9 Step 8: Test the New Policy

Now that you have created all the components, you are ready to test the policy.

1. Connect as user `tbrooke`.

```

CONNECT tbrooke@pdb_name
Enter password: password

```

User `tbrooke` can log on because he has passed the requirements that you defined in the application context.

2. As user `tbrooke`, access your purchases.

```

SELECT * FROM SCOTT.ORDERS_TAB;

```

The following output should appear:

CUST_NO	ORDER_NO
1234	9876

User `tbrooke` has passed the second test. This user can access their own orders in the `scott.orders_tab` table.

3. Connect as user `owoods`, and then access your purchases.

```

CONNECT owoods@pdb_name
Enter password: password

```

```

SELECT * FROM SCOTT.ORDERS_TAB

```

The following output should appear:

CUST_NO	ORDER_NO
5678	5432
5678	4592

As with user `tbrooke`, user `owoods` can log on and see a listing of their own orders.

Note the following:

- You can create several predicates based on the position of a user. For example, a sales representative would be able to see records only for their customers, and an order entry

clerk would be able to see any customer order. You could expand the `custnum_sec` function to return different predicates based on the user position context value.

- The use of an application context in a fine-grained access control package effectively gives you a bind variable in a parsed statement. For example:

```
SELECT * FROM SCOTT.ORDERS_TAB
WHERE cust_no = SYS_CONTEXT('order_entry', 'cust_num');
```

This is fully parsed and optimized, but the evaluation of the `cust_num` attribute value of the user for the `order_entry` context takes place at run-time. This means that you get the benefit of an optimized statement that executes differently for each user who issues the statement.

Note:

You can improve the performance of the function in this tutorial by indexing `cust_no`.

- You can set context attributes based on data from a database table or tables, or from a directory server using Lightweight Directory Access Protocol (LDAP).

Related Topics

- [Oracle Database PL/SQL Language Reference](#)

14.4.2.10 Step 9: Remove the Components of This Tutorial

If you no longer need the components of this tutorial, then you can remove them.

1. Connect as user `SCOTT`.

```
CONNECT SCOTT@pdb_name
Enter password: password
```

2. Remove the `orders_tab` and `customers` tables.

```
DROP TABLE ORDERS_TAB;
DROP TABLE customers;
```

3. Connect as user `SYS`, connecting with `AS SYSDBA`.

```
CONNECT SYS@pdb_name AS SYSDBA
Enter password: password
```

4. Run the following statements to drop the components for this tutorial:

```
DROP CONTEXT orders_ctx;
DROP USER sysadmin_vpd CASCADE;
DROP USER tbrooke;
DROP USER owoods;
```

14.4.3 Tutorial: Implementing an Oracle Virtual Private Database Policy Group

This tutorial demonstrates how to create an Oracle Virtual Private Database policy group.

- [About This Tutorial](#)
This tutorial shows how you can use Oracle Virtual Private Database (VPD) to create a policy group.
- [Step 1: Create User Accounts and Other Components for This Tutorial](#)
First, you must create user accounts and tables for this tutorial, and grant the appropriate privileges.
- [Step 2: Create the Two Policy Groups](#)
Next, you must create a policy group for each of the two nondatabase users, `provider_a` and `provider_b`.
- [Step 3: Create PL/SQL Functions to Control the Policy Groups](#)
A policy group must have a function that defines how the application can control data access for users.
- [Step 4: Create the Driving Application Context](#)
The application context determines which policy the nondatabase user who is the logging on should use.
- [Step 5: Add the PL/SQL Functions to the Policy Groups](#)
Now that you have created the necessary functions, you are ready to associate them with their appropriate policy groups.
- [Step 6: Test the Policy Groups](#)
Now you are ready to test the two policy groups.
- [Step 7: Remove the Components of This Tutorial](#)
If you no longer need the components of this tutorial, then you can remove them.

14.4.3.1 About This Tutorial

This tutorial shows how you can use Oracle Virtual Private Database (VPD) to create a policy group.

A policy group enables you to group a set of policies for use in an application. When a nondatabase user logs onto the application, Oracle Database grants the user access based on the policies defined within the appropriate policy group.

For column-level access control, every column or set of hidden columns is controlled by one policy. In this tutorial, you must hide two sets of columns. So, you must create two policies, one for each set of columns that you want to hide. You only want one policy for each user; the driving application context separates the policies for you.

Related Topics

- [Oracle Virtual Private Database Policy Groups](#)
An Oracle Virtual Private Database policy group is a named collection of VPD policies that can be applied to an application.

14.4.3.2 Step 1: Create User Accounts and Other Components for This Tutorial

First, you must create user accounts and tables for this tutorial, and grant the appropriate privileges.

1. Log on to the appropriate PDB as user `SYS` with the `SYSDBA` administrative privilege.

```
sqlplus sys@pdb_name as sysdba
Enter password: password
```

To find the available PDBs, run the `show pdbs` command. To check the current PDB, run the `show con_name` command.

2. Create the following local users:

```
CREATE USER apps_user IDENTIFIED BY password CONTAINER = CURRENT;
GRANT CREATE SESSION TO apps_user;
CREATE USER sysadmin_pg IDENTIFIED BY password CONTAINER = CURRENT;
GRANT CREATE SESSION, CREATE PROCEDURE, CREATE ANY CONTEXT TO sysadmin_pg;
```

Replace `password` with a password that is secure.

3. Grant the following additional privileges to user `sysadmin_pg`:

```
GRANT EXECUTE ON DBMS_RLS TO sysadmin_pg;
GRANT ADMINISTER ROW LEVEL SECURITY POLICY TO sysadmin_pg;
```

4. Log on as user OE.

```
CONNECT OE@ pdb_name
Enter password: password
```

If the OE account is locked and expired, then reconnect as user SYS with the SYSDBA administrative privilege and enter the following statement to unlock the account and give it a new password:

```
ALTER USER OE ACCOUNT UNLOCK IDENTIFIED BY password;
```

Replace `password` with a password that is secure. For greater security, do not reuse the same password that was used in previous releases of Oracle Database.

5. Create the `product_code_names` table:

```
CREATE TABLE product_code_names(
  group_a      varchar2(32),
  year_a       varchar2(32),
  group_b      varchar2(32),
  year_b       varchar2(32));
```

6. Insert some values into the `product_code_names` table:

```
INSERT INTO product_code_names values('Biffo','2008','Beffo','2004');
INSERT INTO product_code_names values('Hortensia','2008','Bunko','2008');
INSERT INTO product_code_names values('Boppo','2006','Hortensia','2003');

COMMIT;
```

7. Grant the `apps_user` user SELECT privileges on the `product_code_names` table.

```
GRANT SELECT ON product_code_names TO apps_user;
```

Related Topics

- [Guidelines for Securing Passwords](#)
Oracle provides guidelines for securing passwords in a variety of situations.

14.4.3.3 Step 2: Create the Two Policy Groups

Next, you must create a policy group for each of the two nondatabase users, `provider_a` and `provider_b`.

1. Connect as user `sysadmin_pg`.

```
CONNECT sysadmin_pg@ pdb_name
Enter password: password
```

2. Create the `provider_a_group` policy group, to be used by user `provider_a`:

```
BEGIN
  DBMS_RLS.CREATE_POLICY_GROUP(
    object_schema => 'oe',
    object_name   => 'product_code_names',
    policy_group  => 'provider_a_group');
END;
/
```

3. Create the `provider_b_group` policy group, to be used by user `provider_b`:

```
BEGIN
  DBMS_RLS.CREATE_POLICY_GROUP(
    object_schema => 'oe',
    object_name   => 'product_code_names',
    policy_group  => 'provider_b_group');
END;
/
```

14.4.3.4 Step 3: Create PL/SQL Functions to Control the Policy Groups

A policy group must have a function that defines how the application can control data access for users.

The function that you will create for this policy group applies to users `provider_a` and `provider_b`.

1. Create the `vpd_function_provider_a` function, which restricts the data accessed by user `provider_a`.

```
CREATE OR REPLACE FUNCTION vpd_function_provider_a
(schema in varchar2, tab in varchar2) return varchar2 as
  predicate varchar2(8) default NULL;
BEGIN
  IF LOWER(SYS_CONTEXT('USERENV','CLIENT_IDENTIFIER')) = 'provider_a'
    THEN predicate := '1=2';
  ELSE NULL;
  END IF;
  RETURN predicate;
END;
/
```

This function checks that the user logging in is really user `provider_a`. If this is true, then only the data in the `product_code_names` table columns `group_a` and `year_a` will be visible to `provider_a`. Data in columns `group_b` and `year_b` will not appear for `provider_a`. This works as follows: Setting `predicate := '1=2'` hides the relevant columns. In a later step, you will specify these columns in the `SEC_RELEVANT_COLS` parameter.

2. Create the `vpd_function_provider_b`, function, which restricts the data accessed by user `provider_b`.

```
CREATE OR REPLACE FUNCTION vpd_function_provider_b
(schema in varchar2, tab in varchar2) return varchar2 as
  predicate varchar2(8) default NULL;
BEGIN
  IF LOWER(SYS_CONTEXT('USERENV','CLIENT_IDENTIFIER')) = 'provider_b'
    THEN predicate := '1=2';
  ELSE NULL;
  END IF;
  RETURN predicate;
END;
```

```
END;
/
```

Similar to the `vpd_function_provider_a` function, this function checks that the user logging in is really `user_provider_b`. If this is true, then only the data in the columns `group_b` and `year_b` will be visible to `provider_b`, with data in the `group_a` and `year_a` not appearing for `provider_b`. Similar to the `vpd_function_provider_a` function, `predicate := '1=2'` hides the relevant columns that will be specified in the `SEC_RELEVANT_COLS` parameter.

Related Topics

- [Function to Generate the Dynamic WHERE Clause](#)
The Oracle Virtual Private Database (VPD) function defines the restrictions that you want to enforce.

14.4.3.5 Step 4: Create the Driving Application Context

The application context determines which policy the nondatabase user who is the logging on should use.

1. As user `sysadmin_pg`, create the driving application context as follows:

```
CREATE OR REPLACE CONTEXT provider_ctx USING provider_package;
```

2. Create the PL/SQL `provider_package` package for the application context.

```
CREATE OR REPLACE PACKAGE provider_package IS
  PROCEDURE set_provider_context (policy_group varchar2 default NULL);
END;
/
CREATE OR REPLACE PACKAGE BODY provider_package AS
  PROCEDURE set_provider_context (policy_group varchar2 default NULL) IS
  BEGIN
    CASE LOWER(SYS_CONTEXT('USERENV', 'CLIENT_IDENTIFIER'))
      WHEN 'provider_a' THEN
        DBMS_SESSION.SET_CONTEXT('provider_ctx','policy_group','PROVIDER_A_GROUP');
      WHEN 'provider_b' THEN
        DBMS_SESSION.SET_CONTEXT('provider_ctx','policy_group','PROVIDER_B_GROUP');
    END CASE;
  END set_provider_context;
END;
/
```

3. Associate the `provider_ctx` application context with the `product_code_names` table, and then provide a name.

```
BEGIN
  DBMS_RLS.ADD_POLICY_CONTEXT(
    object_schema =>'oe',
    object_name   =>'product_code_names',
    namespace    =>'provider_ctx',
    attribute     =>'policy_group');
END;
/
```

4. Grant the `apps_user` account the `EXECUTE` privilege for the `provider_package` package.

```
GRANT EXECUTE ON provider_package TO apps_user;
```

14.4.3.6 Step 5: Add the PL/SQL Functions to the Policy Groups

Now that you have created the necessary functions, you are ready to associate them with their appropriate policy groups.

1. Add the `vpd_function_provider_a` function to the `provider_a_group` policy group.

```
BEGIN
  DBMS_RLS.ADD_GROUPED_POLICY(
    object_schema      => 'oe',
    object_name        => 'product_code_names',
    policy_group       => 'provider_a_group',
    policy_name        => 'filter_provider_a',
    function_schema    => 'sysadmin_pg',
    policy_function     => 'vpd_function_provider_a',
    statement_types    => 'select',
    policy_type        => DBMS_RLS.CONTEXT_SENSITIVE,
    sec_relevant_cols  => 'group_b,year_b',
    sec_relevant_cols_opt => DBMS_RLS.ALL_ROWS,
    namespace         => 'provider_ctx',
    attribute          => 'provider_group');
END;
/
```

The `group_b` and `year_b` columns specified in the `sec_relevant_cols` parameter are hidden from user `provider_a`.

2. Add the `vpd_function_provider_b` function to the `provider_b_group` policy group.

```
BEGIN
  DBMS_RLS.ADD_GROUPED_POLICY(
    object_schema      => 'oe',
    object_name        => 'product_code_names',
    policy_group       => 'provider_b_group',
    policy_name        => 'filter_provider_b',
    function_schema    => 'sysadmin_pg',
    policy_function     => 'vpd_function_provider_b',
    statement_types    => 'select',
    policy_type        => DBMS_RLS.CONTEXT_SENSITIVE,
    sec_relevant_cols  => 'group_a,year_a',
    sec_relevant_cols_opt => DBMS_RLS.ALL_ROWS,
    namespace         => 'provider_ctx',
    attribute          => 'provider_group');
END;
/
```

The `group_a` and `year_a` columns specified in the `sec_relevant_cols` parameter are hidden from user `provider_b`.

14.4.3.7 Step 6: Test the Policy Groups

Now you are ready to test the two policy groups.

1. Connect as user `apps_user` and then enter the following statements to ensure that the output you will create later on is nicely formatted.

```
CONNECT apps_user@pdb_name
Enter password: password

col group_a format a16
```



```
col group_b format a16;
col year_a format a16;
col year_b format a16;
```

2. Set the session identifier to `provider_a`.

```
EXEC DBMS_SESSION.SET_IDENTIFIER('provider_a');
```

Here, the application sets the identifier. Setting the identifier to `provider_a` sets the `apps_user` user to a user who should only see the products available to products in the `provider_a_group` policy group.

3. Run the `provider_package` to set the policy group based on the context.

```
EXEC sysadmin_pg.provider_package.set_provider_context;
```

At this stage, you can check the application context was set, as follows:

```
SELECT SYS_CONTEXT('USERENV', 'CLIENT_IDENTIFIER') AS END_USER FROM DUAL;
```

The following output should appear:

```
END_USER
-----
provider_a
```

4. Enter the following `SELECT` statement:

```
SELECT * FROM oe.product_code_names;
```

The following output should appear:

GROUP_A	YEAR_A	GROUP_B	YEAR_B
Biffo	2008		
Hortensia	2008		
Boppo	2006		

5. Set the client identifier to `provider_b` and then enter the following statements:

```
EXEC DBMS_SESSION.SET_IDENTIFIER('provider_b');
EXEC sysadmin_pg.provider_package.set_provider_context;
SELECT * FROM oe.product_code_names;
```

The following output should appear:

GROUP_A	YEAR_A	GROUP_B	YEAR_B
		Beffo	2004
		Bunko	2008
		Hortensia	2003

14.4.3.8 Step 7: Remove the Components of This Tutorial

If you no longer need the components of this tutorial, then you can remove them.

1. Connect as user `OE`.

```
CONNECT OE@ pdb_name
Enter password: password
```

2. Drop the `product_code_names` table.

```
DROP TABLE product_code_names;
```

3. Connect as user `SYS` with the `SYSDBA` administrative privilege.

```
CONNECT SYS@pdb_name AS SYSDBA
Enter password: password
```

4. Drop the application context and users for this tutorial.

```
DROP CONTEXT provider_ctx;
DROP USER sysadmin_pg cascade;
DROP USER apps_user;
```

14.5 How Oracle Virtual Private Database Works with Other Oracle Features

You should be aware of the impact of using Oracle Virtual Private Database with other Oracle features.

- [Oracle Virtual Private Database Policies with Editions](#)
You should be aware of how to use Oracle VPD with editions.
- [SELECT FOR UPDATE Statement in User Queries on VPD-Protected Tables](#)
As a general rule, users should not include the `FOR UPDATE` clause when querying Virtual Private Database-protected tables.
- [Oracle Virtual Private Database Policies and Outer or ANSI Joins](#)
Oracle Virtual Private Database rewrites SQL by using dynamic views.
- [Oracle Virtual Private Database Security Policies and Applications](#)
An Oracle Virtual Private Database security policy is applied within the database itself, rather than within an application.
- [Automatic Reparsing for Fine-Grained Access Control Policies Functions](#)
Queries against objects enabled with fine-grained access control run the policy function so that the most current predicate is used for each policy.
- [Oracle Virtual Private Database Policies and Flashback Queries](#)
Operations on the database use the most recently committed data available.
- [Oracle Virtual Private Database and Oracle Label Security](#)
You can use Oracle Virtual Private Database with Oracle Label Security, but be aware of security exceptions.
- [Export of Data Using the EXPDP Utility access_method Parameter](#)
Be aware if you try to export data from objects that have VPD policies defined on them.
- [Oracle Virtual Private Database Policies and Oracle Flashback Time Travel](#)
Oracle Virtual Private Database policies do not automatically work with Oracle Flashback Time Travel.
- [User Models and Oracle Virtual Private Database](#)
You can use Oracle Virtual Private Database in several types of user models.
- [Oracle Virtual Private Database and JSON](#)
You should be aware of how to use Oracle VPD with JSON.

14.5.1 Oracle Virtual Private Database Policies with Editions

You should be aware of how to use Oracle VPD with editions.

If you are preparing an application for edition-based redefinition, and you cover each table that the application uses with an editioning view, then you must move the Virtual Private Database polices that protect these tables to the editioning view.

When an editioned object has a Virtual Private Database policy, then it applies in all editions in which the object is visible. When an editioned object is actualized, any VPD policies that are attached to it are newly attached to the new actual occurrence. When you newly apply a VPD policy to an inherited editioned object, this action will actualize it.

Related Topics

- *Oracle Database Development Guide*

14.5.2 SELECT FOR UPDATE Statement in User Queries on VPD-Protected Tables

As a general rule, users should not include the `FOR UPDATE` clause when querying Virtual Private Database-protected tables.

The Virtual Private Database technology depends on rewriting the user's query against an inline view that includes the VPD predicate generated by the VPD policy function. Because of this, the same limitations on views also apply to VPD-protected tables. If a user's query against a VPD-protected table includes the `FOR UPDATE` clause in a `SELECT` statement, in most cases, the query may not work. However, the user's query may work in some situations if the inline view generated by VPD is sufficiently simple.

Related Topics

- *Oracle Database SQL Language Reference*

14.5.3 Oracle Virtual Private Database Policies and Outer or ANSI Joins

Oracle Virtual Private Database rewrites SQL by using dynamic views.

For SQL that contains outer join or ANSI operations, some views may not merge and some indexes may not be used. This problem is a known optimization limitation. To remedy this problem, rewrite the SQL to not use outer joins or ANSI operations.

14.5.4 Oracle Virtual Private Database Security Policies and Applications

An Oracle Virtual Private Database security policy is applied within the database itself, rather than within an application.

Hence, a user trying to access data by using a different application cannot bypass the Oracle Virtual Private Database security policy. Another advantage of creating the security policy in the database is that you maintain it in one central place, rather than maintaining individual security policies in multiple applications. Oracle Virtual Private Database provides stronger security than application-based security, at a lower cost of ownership.

You may want to enforce different security policies depending on the application that is accessing data. Consider a situation in which two applications, Order Entry and Inventory, both access the `orders` table. You may want to have the Inventory application use a policy that limits access based on type of product. At the same time, you may want to have the Order Entry application use a policy that limits access based on customer number.

In this case, you must partition the use of fine-grained access by application. Otherwise, both policies would be automatically concatenated together, which may not be the result that you want. You can specify two or more policy groups, and a driving application context that determines which policy group is in effect for a given transaction. You can also designate default policies that always apply to data access. In a hosted application, for example, data access should be limited by subscriber ID.

Related Topics

- [Tutorial: Implementing an Oracle Virtual Private Database Policy Group](#)
This tutorial demonstrates how to create an Oracle Virtual Private Database policy group.

14.5.5 Automatic Reparsing for Fine-Grained Access Control Policies Functions

Queries against objects enabled with fine-grained access control run the policy function so that the most current predicate is used for each policy.

For example, in the case of a time-based policy function, in which queries are only allowed between 8:00 a.m. and 5:00 p.m., a cursor execution parsed at noon runs the policy function at that time, ensuring that the policy is consulted again for the query. Even if the cursor was parsed at 9 a.m., when it runs later on (for example, at noon), then the Virtual Private Database policy function runs again to ensure that the execution of the cursor is still permitted at the current time (noon). This ensures that the security check it must perform is the most recent.

Automatic re-execution of the Virtual Private Database policy function does not occur when you set the `DBMS_RLS.ADD_POLICY` setting `STATIC_POLICY` to `TRUE` while adding the policy. This setting causes the policy function to return the same predicate.

14.5.6 Oracle Virtual Private Database Policies and Flashback Queries

Operations on the database use the most recently committed data available.

The flashback query feature enables you to query the database at some point in the past.

To write an application that uses flashback query, you can use the `AS OF` clause in SQL queries to specify either a time or a system change number (SCN), and then query against the committed data from the specified time. You can also use the `DBMS_FLASHBACK` PL/SQL package, which requires more code, but enables you to perform multiple operations, all of which refer to the same point in time.

However, if you use flashback query against a database object that is protected with Oracle Virtual Private Database policies, then the current policies are applied to the old data. Applying the current Oracle Virtual Private Database policies to flashback query data is more secure because it reflects the most current business policy.

Related Topics

- *Oracle Database Development Guide*
- *Oracle Database PL/SQL Packages and Types Reference*

14.5.7 Oracle Virtual Private Database and Oracle Label Security

You can use Oracle Virtual Private Database with Oracle Label Security, but be aware of security exceptions.

- [Using Oracle Virtual Private Database to Enforce Oracle Label Security Policies](#)
Oracle Virtual Private Database policies provide column or row-level access control based on Oracle Label Security user authorizations.
- [Oracle Virtual Private Database and Oracle Label Security Exceptions](#)
Be aware of the security exceptions when you use Oracle Virtual Private Database, Oracle Label Security, and Oracle Real Application Security.

14.5.7.1 Using Oracle Virtual Private Database to Enforce Oracle Label Security Policies

Oracle Virtual Private Database policies provide column or row-level access control based on Oracle Label Security user authorizations.

You must perform the following actions:

1. When you create the Oracle Label Security policy, do not apply the policy to the table that you want to protect. (The Virtual Private Database policy that you create handles this for you.) In the `SA_SYSDBA.CREATE_POLICY` procedure, set the `default_options` parameter to `NO_CONTROL`.
2. Create the Oracle Label Security label components and authorize users as you normally would.
3. When you create the Oracle Virtual Private Database policy, do the following:
 - In the PL/SQL function you create for the policy, use the Oracle Label Security `DOMINATES` function to compare the authorization of the user with the label that you created. The `DOMINATES` function determines if the user authorization is equal to, or if it is more sensitive than, the label used in the comparison. If the user authorization passes, then the user is granted access to the column. Otherwise, the user is denied access.
 - In the Virtual Private Database policy definition, apply this function to the table that you want to protect. In the `DBMS_RLS.ADD_POLICY` procedure, use the sensitive column (`SEC_RELEVANT_COLS` parameter) and column masking (`SEC_RELEVANT_COLS_OPT` parameter) functionality to show or hide columns based on Oracle Label Security user authorizations.

Related Topics

- *Oracle Label Security Administrator's Guide*

14.5.7.2 Oracle Virtual Private Database and Oracle Label Security Exceptions

Be aware of the security exceptions when you use Oracle Virtual Private Database, Oracle Label Security, and Oracle Real Application Security.

These security exceptions are as follows:

- **When you are exporting data, Oracle Virtual Private Database and Oracle Label Security policies are not enforced during a direct path export operation.** In a direct path export operation, Oracle Database reads data from disk into the buffer cache and transfers rows directly to the Export client.
- **You cannot apply Oracle Virtual Private Database policies and Oracle Label Security policies to objects in the SYS schema.** The `SYS` user and users making a DBA-privileged connection to the database (for example, `CONNECT/AS SYSDBA`) do not have Oracle Virtual Private Database or Oracle Label Security policies applied to their actions. The database user `SYS` is thus always exempt from Oracle Virtual Private Database or Oracle Label Security enforcement, regardless of the export mode, application, or utility used to extract data from the database.

However, you can audit `SYSDBA` actions by enabling auditing upon installation and specifying that this audit trail be stored in a secure location in the operating system. You can also closely monitor the `SYS` user by using Oracle Database Vault.

- **Database users who were granted the `EXEMPT ACCESS POLICY` system privilege, either directly or through a database role, are exempt from Oracle Virtual Private Database, Label Security, and Real Application Security policy enforcements.** The system privilege `EXEMPT ACCESS POLICY` allows a user to be exempted from all fine-grained access control policies on any `SELECT` or DML operation (`INSERT`, `UPDATE`, and `DELETE`). This provides ease of use for administrative activities, such as installation and import and export of the database, through a non-`SYS` schema.

However, the following policy enforcement options remain in effect even when `EXEMPT ACCESS POLICY` is granted:

- `INSERT_CONTROL`, `UPDATE_CONTROL`, `DELETE_CONTROL`, `WRITE_CONTROL`, `LABEL_UPDATE`, and `LABEL_DEFAULT`
- If the Oracle Label Security policy specifies the `ALL_CONTROL` option, then all enforcement controls are applied except `READ_CONTROL` and `CHECK_CONTROL`.

Because `EXEMPT ACCESS POLICY` negates the effect of fine-grained access control, you should only grant this privilege to users who have legitimate reasons for bypassing fine-grained access control enforcement. Do not grant this privilege using the `WITH ADMIN OPTION`. If you do, users could pass the `EXEMPT ACCESS POLICY` privilege to other users, and thus propagate the ability to bypass fine-grained access control.

 **Note:**

- The `EXEMPT ACCESS POLICY` system privilege does not affect the enforcement of object privileges such as `SELECT`, `INSERT`, `UPDATE`, and `DELETE`. These privileges are enforced even if a user was granted the `EXEMPT ACCESS POLICY` system privilege.
- The `SYS_CONTEXT` values that Oracle Virtual Private Database uses are not propagated to secondary databases for failover.

Related Topics

- *Oracle Database Utilities*

14.5.8 Export of Data Using the `EXPDP` Utility `access_method` Parameter

Be aware if you try to export data from objects that have VPD policies defined on them.

If you try to use the Oracle Data Pump Export (`EXPDP`) utility with the `access_method` parameter set to `direct_path` to export data from a schema that contains an object that has a Virtual Private Database policy defined on it, then an `ORA-31696` error message may appear and the export operation will fail.

The error message is as follows:

```
ORA-31696: unable to export/import TABLE_DATA:"schema.table" using client specified
DIRECT_PATH method
```

This problem occurs when you perform a schema-level export or a full database export, which requires the `EXP_FULL_DATABASE` role. To perform an export with VPD policies in place using the `access_method=direct_path` parameter, the exporting user must be granted the system privilege `EXEMPT ACCESS POLICY`. `EXEMPT ACCESS POLICY` bypasses Virtual Private Database

policies. Note that the `EXP_FULL_DATABASE` role does **not** include the `EXEMPT ACCESS POLICY` system privilege.

To find the underlying problem, try the `EXPDP` invocation again, but do not set the `access_method` parameter to `direct_path`. Instead, use either `automatic` or `external_table`. The underlying problem could be a permissions problem, for example:

```
ORA-39181: Only partial table data may be exported due to fine grain access control on
"schema_name"."object_name"
```

14.5.9 Oracle Virtual Private Database Policies and Oracle Flashback Time Travel

Oracle Virtual Private Database policies do not automatically work with Oracle Flashback Time Travel.

After you create an Oracle Virtual Private Database (VPD) policy for a table, consider creating an equivalent policy for the Flashback Archive history table. The following example demonstrates how to do so.

Example 14-12 Creating an Equivalent Policy for an Flashback Archive History Table

1. Create a temporary VPD administrative user.

```
CREATE USER sysadmin_vpd IDENTIFIED BY password CONTAINER = CURRENT;
GRANT CREATE SESSION, CREATE ANY CONTEXT, CREATE PROCEDURE TO sysadmin_vpd;
GRANT EXECUTE ON DBMS_SESSION TO sysadmin_vpd;
GRANT EXECUTE ON DBMS_FLASHBACK, DBMS_FLASHBACK_ARCHIVE TO sysadmin_vpd;
GRANT EXECUTE ON DBMS_RLS TO sysadmin_vpd;
GRANT UPDATE ON SCOTT.EMP TO sysadmin_vpd;
```

2. Connect to the PDB as the `sysadmin_vpd` user.

```
connect sysadmin_vpd@pdb_name
Enter password: password
Connected.
```

3. Create the VPD function.

For example, the following function shows only rows with department number (`deptno`) 30 to users other than user `SCOTT`:

```
CREATE OR REPLACE FUNCTION emp_policy_func (
  v_schema IN VARCHAR2,
  v_objname IN VARCHAR2)

RETURN VARCHAR2 AS
condition VARCHAR2 (200);

BEGIN
  condition := 'deptno=30';
  IF sys_context('userenv', 'session_user') IN ('SCOTT') THEN
    RETURN NULL;
  ELSE
    RETURN (condition);
  END IF;
```

```
END emp_policy_func;
/
```

4. Create the following VPD procedure to attach the `emp_policy_func` function to the `SCOTT.EMP` table.

```
BEGIN
  DBMS_RLS.ADD_POLICY (
    object_schema    => 'scott',
    object_name      => 'emp',
    policy_name      => 'emp_policy',
    function_schema  => 'sysadmin_vpd',
    policy_function  => 'emp_policy_func',
    policy_type      => dbms_rls.dynamic);
END;
/
```

5. Create the following `test` user and grant privileges, including those related to Flashback Archive.

```
CREATE USER test IDENTIFIED BY password;
GRANT CREATE SESSION TO test;
GRANT CONNECT, RESOURCE TO test;
GRANT SELECT ON SCOTT.EMP TO test;
GRANT FLASHBACK ARCHIVE ON ftest TO test;
GRANT EXECUTE ON DBMS_FLASHBACK_ARCHIVE TO test;
GRANT EXECUTE ON DBMS_FLASHBACK TO test;
GRANT FLASHBACK ANY TABLE TO PUBLIC;
GRANT EXECUTE ON emp_policy_func TO PUBLIC;
```

6. Enable the `SCOTT.EMP` table for flashback archive, and for transactions

```
ALTER TABLE SCOTT.EMP FLASHBACK ARCHIVE;
```

7. Perform an update to the `SCOTT.EMP` table.

```
UPDATE SCOTT.EMP SET SAL=SAL+1;
COMMIT;
```

8. Put the preceding procedure to sleep for 60 seconds.

```
EXEC DBMS_LOCK.SLEEP(60);
```

9. Connect as user `test`.

```
connect test@pdb_name
Enter password: password
Connected.
```

10. Perform the following query to show only rows that have `deptno=30`, per the VPD policy:

```
SELECT EMPNO,DEPTNO,SAL FROM SCOTT.EMP;
```

The VPD policy is not working because all rows are shown.

```
SELECT EMPNO,DEPTNO,SAL FROM SCOTT.EMP AS OF TIMESTAMP SYSDATE-1;
```

11. Connect as user `sysadmin_vpd`.

```
connect sysadmin_vpd@pdb_name
Enter password: password
Connected.
```

12. Find the object ID for the `EMP` table.

```
SELECT OBJECT_ID FROM DBA_OBJECTS WHERE OBJECT_NAME='EMP';
```

13. Define a similar VPD policy on the `SYS_FBA_HIST_object_id_of_EMP_table` table. This table is internally created by Flashback Archive

```
BEGIN
  DBMS_RLS.ADD_POLICY (
    object_schema => 'scott',
    object_name   => 'sys_fba_hist_object_id_of_EMP_table',
    policy_name   => 'emp_hist_policy',
    function_schema => 'sysadmin_vpd',
    policy_function => 'emp_policy_func',
    policy_type   => dbms_rls.dynamic);
END;
/
```

14. Connect as the test user.

```
connect test@pdb_name
Enter password: password
Connected.
```

15. Test the policy again:

```
SELECT EMPNO,DEPTNO,SAL FROM SCOTT.EMP AS OF TIMESTAMP SYSDATE-1;
```

Now the VPD policy works, because the query only shows rows with `deptno=30`.

16. Connect as a user who can drop user accounts.
For example:

```
connect sec_admin@pdb_name
Enter password: password
Connected.
```

17. Drop the `sysadmin_vpd` user and its objects as follows:

```
DROP USER sysadmin_vpd CASCADE;
```

14.5.10 User Models and Oracle Virtual Private Database

You can use Oracle Virtual Private Database in several types of user models.

These user models are as follows:

- **Application users who are also database users.** Oracle Database enables applications to enforce fine-grained access control for each user, regardless of whether that user is a database user or an application user unknown to the database. When application users are also database users, Oracle Virtual Private Database enforcement works as follows: users connect to the database, and then the application sets up application contexts for each session. (You can use the default `USERENV` application context namespace, which provides many parameters for retrieve different types of user session data.) As each session is initiated under a different user name, it can enforce different fine-grained access control conditions for each user.
- **Proxy authentication using OCI or JDBC/OCI.** Proxy authentication permits different fine-grained access control for each user, because each session (OCI or JDBC/OCI) is a distinct database session with its own application context.
- **Proxy authentication integrated with Enterprise User Security.** If you have integrated proxy authentication by using Enterprise User Security, you can retrieve user roles and other attributes from Oracle Internet Directory to enforce Oracle Virtual Private Database policies. (In addition, globally initialized application context can also be retrieved from the directory.)

 **Note:**

Enterprise User Security (EUS) is deprecated with Oracle Database 23ai. Oracle recommends that you migrate to using Centrally Managed Users (CMU). This feature enables you to directly connect with Microsoft Active Directory without an intervening directory service for enterprise user authentication and authorization to the database. If your Oracle Database is in the cloud, you can also choose to move to one of the newer integrations with a cloud identity provider.

- **Users connecting as One Big Application User.** Applications connecting to the database as a single user on behalf of all users can have fine-grained access control for each user. The user for that single session is often called *One Big Application User*. Within the context of that session, however, an application developer can create a global application context attribute to represent the individual application user (for example, `REALUSER`). Although all database sessions and audit records are created for One Big Application User, the attributes for each session can vary, depending on who the end user is. This model works best for applications with a limited number of users and no reuse of sessions. The scope of roles and database auditing is diminished because each session is created as the same database user.
- **Web-based applications.** Web-based applications typically have hundreds of users. Even when there are persistent connections to the database, supporting data retrieval for many user requests, these connections are not specific to particular Web-based users. Instead, Web-based applications typically set up and reuse connections, to provide scalability, rather than having different sessions for each user. For example, when Web users Jane and Ajit connect to a middle tier application, it may establish a single database session that it uses on behalf of both users. Typically, neither Jane nor Ajit is known to the database.

The application is responsible for switching the user name on the connection, so that, at any given time, it is either Jane or Ajit using the session.

Oracle Virtual Private Database helps with connection pooling by allowing multiple connections to access more than one global application context. This ability makes it unnecessary to establish a separate application context for each distinct user session.

Table 14-3 summarizes how Oracle Virtual Private Database applies to user models.

Table 14-3 Oracle Virtual Private Database in Different User Models

User Model Scenario	Individual Database Connection	Separate Application Context per User	Single Database Connection	Application Must Switch User Name
Application users are also database users	Yes	Yes	No	No
Proxy authentication using OCI or JDBC/OCI	Yes	Yes	No	No
Proxy authentication integrated with Enterprise User Security ¹	No	No	Yes	Yes
One Big Application User	No	No ²	No	Yes ²
Web-based applications	No	No	Yes	Yes

¹ User roles and other attributes, including globally initialized application context, can be retrieved from Oracle Internet Directory to enforce Oracle Virtual Private Database.

² Application developers can create a global application context attribute representing individual application users (for example, REALUSER), which can then be used for controlling each session attributes, or for auditing.

Related Topics

- [Global Application Contexts](#)
You can use a global application context to access application values across database sessions, including an Oracle Real Application Clusters environment.

14.5.11 Oracle Virtual Private Database and JSON

You should be aware of how to use Oracle VPD with JSON.

You cannot create VPD policies on JSON relational duality views. Any attempt to do so results in an `ORA-42623: Virtual Private Database (VPD) cannot be applied on JSON Relational Duality Views` error. However, you can create VPD policies on base tables of JSON relational duality views.

14.6 Oracle Virtual Private Database Data Dictionary Views

Oracle Database provides data dictionary views that list information about Oracle Virtual Private Database policies.

Table 14-4 lists Virtual Private Database-specific views

Table 14-4 Data Dictionary Views That Display Information about VPD Policies

View	Description
ALL_POLICIES	Describes all Oracle Virtual Private Database security policies for objects accessible to the current user.
ALL_POLICY_ATTRIBUTES	Describes all the application context namespaces, attributes, and Virtual Private Database policy associations where the logged in user is the owner of the VPD policy or the VPD policy belongs to PUBLIC.
ALL_POLICY_CONTEXTS	Describes the driving contexts defined for the synonyms, tables, and views accessible to the current user. A driving context is an application context used in an Oracle Virtual Private Database policy.
ALL_POLICY_GROUPS	Describes the Oracle Virtual Private Database policy groups defined for the synonyms, tables, and views accessible to the current user
ALL_SEC_RELEVANT_COLS	Describes the security relevant columns of the security policies for the tables and views accessible to the current user
DBA_POLICIES	Describes all Oracle Virtual Private Database security policies in the database.
DBA_POLICY_ATTRIBUTES	Describes all the application context namespaces, attributes, and Virtual Private Database policy associations for context-sensitive and shared context-sensitive Virtual Private Database policies
DBA_POLICY_GROUPS	Describes all policy groups in the database.
DBA_POLICY_CONTEXTS	Describes all driving contexts in the database. Its columns are the same as those in ALL_POLICY_CONTEXTS.
DBA_SEC_RELEVANT_COLS	Describes the security relevant columns of all security policies in the database
UNIFIED_AUDIT_TRAIL	Captures the VPD predicates in the RLS_INFO column, for unified auditing and fine-grained auditing
USER_POLICIES	Describes all Oracle Virtual Private Database security policies associated with objects owned by the current user. This view does not display the OBJECT_OWNER column.
USER_POLICY_ATTRIBUTES	Describes all the application context namespaces, attributes, and Virtual Private Database policy associations where the owner of the Virtual Private Database policy is the current user
USER_POLICY_CONTEXTS	Describes the driving contexts defined for the synonyms, tables, and views owned by the current user. Its columns (except for OBJECT_OWNER) are the same as those in ALL_POLICY_CONTEXTS.
USER_SEC_RELEVANT_COLS	Describes the security relevant columns of the security policies for the tables and views owned by the current user. Its columns (except for OBJECT_OWNER) are the same as those in ALL_SEC_RELEVANT_COLS.
USER_POLICY_GROUPS	Describes the policy groups defined for the synonyms, tables, and views owned by the current user. This view does not display the OBJECT_OWNER column.
V\$VPD_POLICY	For the current PDB, displays all the fine-grained security policies and predicates associated with the cursors currently in the library cache. This view is useful for finding the policies that were applied to a SQL statement.

 **Tip:**

In addition to these views, check the database trace file if you find errors in application that use Virtual Private Database policies. The `USER_DUMP_DEST` initialization parameter specifies the current location of the trace files. You can find the value of this parameter by issuing `SHOW PARAMETER USER_DUMP_DEST` in SQL*Plus.

Related Topics

- *Oracle Database Reference*
- *Oracle Database SQL Tuning Guide*

Using Transparent Sensitive Data Protection

Transparent sensitive data protection enables you to identify all table columns in a database that hold sensitive data.

- [About Transparent Sensitive Data Protection](#)
Transparent sensitive data protection is a way to identify and label table columns that hold sensitive information.
- [General Steps for Using Transparent Sensitive Data Protection](#)
To use Transparent Sensitive Data Protection (TSDP) with Oracle Data Redaction and Oracle Virtual Private Database, you must follow a set of general steps.
- [Benefits of Transparent Sensitive Data Protection Policies](#)
Transparent sensitive data protection has several benefits.
- [Privileges Required for Using Transparent Sensitive Data Protection](#)
To use transparent sensitive data protection, you must have the `EXECUTE` privilege for several PL/SQL packages.
- [How a Multitenant Environment Affects Transparent Sensitive Data Protection](#)
You can apply Transparent Sensitive Data Protection (TSDP) policies to the current PDB or current application PDB only.
- [Creating Transparent Sensitive Data Protection Policies](#)
You must create a sensitive type, find the sensitive columns to be protected, and then import these columns from Application Dependency Management (ADM) into your database.
- [Altering Transparent Sensitive Data Protection Policies](#)
The `DBMS_TSDP_PROTECT.ALTER_POLICY` procedure can alter a TSDP policy.
- [Disabling Transparent Sensitive Data Protection Policies](#)
The `DBMS_TSDP_PROTECT.DISABLE_PROTECTION_COLUMN` procedure disables one or all TSDP policies.
- [Dropping Transparent Sensitive Data Protection Policies](#)
You can drop an entire TSDP policy or a condition-enable-options combination from the policy.
- [Using the Predefined REDACT_AUDIT Policy for Redaction](#)
The predefined `REDACT_AUDIT` policy masks bind values, which can appear in trace files when an event is set.
- [Transparent Sensitive Data Protection Policies with Data Redaction](#)
Oracle Data Redaction features work with transparent sensitive data protection policies.
- [Using Transparent Sensitive Data Protection Policies with Oracle VPD Policies](#)
You can combine protections from TSDP and Oracle Virtual Private Database into one policy.
- [Using Transparent Sensitive Data Protection Policies with Unified Auditing](#)
The transparent sensitive data protection and unified auditing procedures can combine the protections of these two features.

- [Using Transparent Sensitive Data Protection Policies with Fine-Grained Auditing](#)
The transparent sensitive data protection and fine-grained auditing procedures can combine the protections of these two features.
- [Using Transparent Sensitive Data Protection Policies with TDE Column Encryption](#)
The TSDP procedures and Transparent Data Encryption column encryption statements can combine the protections of these two features.
- [Transparent Sensitive Data Protection Data Dictionary Views](#)
Oracle Database provides data dictionary views that list information about transparent sensitive data protection policies.

15.1 About Transparent Sensitive Data Protection

Transparent sensitive data protection is a way to identify and label table columns that hold sensitive information.

This feature enables you to quickly find the table columns in a database that hold sensitive data, classify this data, and then create a policy that protects this data as a whole for a given class. Examples of this type of sensitive data are credit card numbers or Social Security numbers.

The TSDP policy then protects the sensitive data in these table columns by using either Oracle Data Redaction or Oracle Virtual Private Database settings. The TSDP policy applies at the column level of the table that you want to protect, targeting a specific column data type, such as all `NUMBER` data types of columns that contain credit card information. You can create a uniform TSDP policy for all of the data that you classify, and then modify this policy as necessary, as compliance regulations change. Optionally, you can export the TSDP policies for use in other databases.

The benefits of TSDP policies are that you easily can create and apply TSDP policies throughout a large organization with numerous databases. This helps auditors greatly by enabling them to estimate the protection for the data that the TSDP policies target. TSDP is particularly useful for government environments, in which you may have a lot of data with similar security restrictions and you must apply a policy to all of this data consistently. The policy could be to redact it, encrypt it, control access to it, audit access to it, and mask it in the audit trail. Therefore, TSDP helps you to efficiently and consistently manage security policies across your database.

15.2 General Steps for Using Transparent Sensitive Data Protection

To use Transparent Data Sensitive Data Protection (TSDP) with Oracle Data Redaction and Oracle Virtual Private Database, you must follow a set of general steps.

1. Create a sensitive type to classify the types of columns that you want to protect.

For example, you can create a sensitive type to classify all Social Security numbers or credit card numbers. To create the sensitive type, either use the `DBMS_TSDP_MANAGE.ADD_SENSITIVE_TYPE` PL/SQL procedure or use an Enterprise Manager Cloud Control Application Data Model. To add multiple sensitive types in one operation from an Application Data Model, you can use the `DBMS_TSDP_MANAGE.IMPORT_SENSITIVE_TYPES` procedure.

2. Identify a list of sensitive columns that are associated with the sensitive types.

To determine and generate this list, you can use either of the following methods:

- The `DBMS_TSDP_MANAGE.ADD_SENSITIVE_COLUMN` procedure individually identifies sensitive columns.
 - An Oracle Enterprise Manager Cloud Control Application Data Model enables you to identify a group of sensitive columns. It then prepares this list of sensitive columns in XML format, which you then import into your database.
3. If you used an Application Data Model for Step 2, then import the list of sensitive columns from the Application Data Model into your database by using the `DBMS_TSDP_MANAGE.IMPORT_DISCOVERY_RESULT` procedure.
 4. Create the TSDP policy by using the `DBMS_TSDP_PROTECT.ADD_POLICY` procedure within an anonymous block that defines the Data Redaction or Virtual Private Database settings that you want to use.
 5. Associate the TSDP policy with one or more sensitive types by using the `DBMS_TSDP_PROTECT.ASSOCIATE_POLICY` procedure.
 6. Enable the TSDP policy protections by using the `DBMS_TSDP_PROTECT.ENABLE_PROTECTION_SOURCE`, `DBMS_TSDP_PROTECT.ENABLE_PROTECTION_COLUMN`, or the `DBMS_TSDP_PROTECT.ENABLE_PROTECTION_TYPE` procedure.
 7. Optionally, export the TSDP policy to other databases by using Oracle Data Pump to perform a full database export. (You cannot individually export TSDP policies.)

15.3 Benefits of Transparent Sensitive Data Protection Policies

Transparent sensitive data protection has several benefits.

These benefits are as follows:

- **You configure the sensitive data protection once, and then deploy this protection as necessary.** You can configure transparent sensitive data protection policies to designate how a class of data (for example, credit card columns) must be protected without actually having to specify the target data. In other words, when you create the transparent sensitive data protection policy, you do not need to include references to the actual target columns that you want to protect. The transparent sensitive data protection policy finds these target columns based on a list of sensitive columns in the database and the policy's associations with the specified sensitive types. This can be useful when you add more sensitive data to your databases after you have created the transparent sensitive data protection policies. After you create the policy, you can enable protection for the sensitive data in a single step (for example, enable protection based on the entire source database). The sensitive type of the new data and the sensitive type and policy associations determine how the sensitive data is protected. In this way, as new sensitive data is added, you do not need to configure its protection, as long as the current policy for that data type still meets your data protection policy requirements.
- **You can manage protection of multiple sensitive columns.** You can enable or disable protection for multiple sensitive columns based on a suitable attribute (such as the source database of the identification, the sensitive type itself, or a specific schema, table, or column). This granularity provides a high level of control over data security. The design of this feature enables you to manage data security based on specific compliance needs for large data sets that fall under the purview of these compliance regulations. You can configure data security based on a specific category rather than for each individual column.
- **You can protect the sensitive columns identified using the Oracle Enterprise Manager Cloud Control Application Data Modeling (ADM) feature.** You can use the Cloud Control ADM feature to create sensitive types and discover a list of sensitive columns. Then you can import this list of sensitive columns and their corresponding

sensitive types into your database. From there, you can create and manage transparent sensitive data protection policies using this information.

15.4 Privileges Required for Using Transparent Sensitive Data Protection

To use transparent sensitive data protection, you must have the `EXECUTE` privilege for several PL/SQL packages.

These privileges are as follows:

- `DBMS_TSDP_MANAGE`, which enables you to import and manage sensitive columns and sensitive types into your database. The procedures in this package run with invoker's rights. Typically, an application database administrator will be granted privileges for this package.
- `DBMS_TSDP_PROTECT`, which you use to create the TSDP policy. The procedures in this package run with invoker's rights. Typically, a security database administrator will be granted privileges for this package.
- `DBMS_REDACT` and the `ADMINISTER REDACTION POLICY` privilege, if you plan to create Data Redaction policies. Typically, a security database administrator will be granted privileges for this package.
- `EXECUTE` privilege on the `DBMS_RLS` package and be granted the `ADMINISTER ROW LEVEL SECURITY POLICY` system privilege for administering a RLS policy in another schema than yourself, if you plan to incorporate Oracle Virtual Private Database functionality into your TSDP policies. Typically, a security database administrator will be granted privileges for this package.

For better separation of duty, these packages are designed so that either an application database administrator has control over one area of the TSDP policy creation (as in the case of the `DBMS_TSDP_MANAGE` package) or a security database administrator (for the `DBMS_TSDP_PROTECT`, `DBMS_REDACT`, and `DBMS_RLS` packages).

15.5 How a Multitenant Environment Affects Transparent Sensitive Data Protection

You can apply Transparent Sensitive Data Protection (TSDP) policies to the current PDB or current application PDB only.

If you are using Enterprise Manager Cloud Control Application Data Model, then you can find sensitive columns that belong to both local and common application objects (that is, common objects that are visible and accessible in the current PDB) inside the PDB. This enables you to use a TSDP policy to protect both local objects to the PDB and common objects that are accessible from the PDB.

In an application root:

- For application containers in general:
 - When you create scripts for application install, upgrade, patch, or uninstall operations, you can include SQL statements within the `ALTER PLUGGABLE DATABASE app_name BEGIN INSTALL` and `ALTER PLUGGABLE DATABASE app_name END INSTALL` blocks to perform various operations. If you include TSDP statements within these blocks, then

the TSDP statements will fail. You can, however, include TSDP statements outside these blocks in the script.

- In the application root:
 - You can perform TSDP operations on both application common objects and application root local objects.
 - A TSDP policy that is defined in the application root container behaves as if it is a local policy to the application root. That is, the policy is effective only in the application root container.

In an application PDB:

- The security policies that protect an application PDB apply to TSDP operations that are performed on local application objects.
- The security policies that protect an application PDB apply to TSDP operations that are performed on application common objects that are accessed from the PDB. However, access to the application common object outside the application PDB is not governed by the security policy that protects the application PDB.

You can find a listing of TSDP policies and the security features that are associated with them by querying the `DBA_TSDP_POLICY_FEATURE` data dictionary view. To find all PDBs, query the `DBA_PDBS` view.

Related Topics

- *Oracle Database Reference*

15.6 Creating Transparent Sensitive Data Protection Policies

You must create a sensitive type, find the sensitive columns to be protected, and then import these columns from Application Dependency Management (ADM) into your database.

- **Step 1: Create a Sensitive Type**
The sensitive type is a class of data that you designate as sensitive.
- **Step 2: Identify the Sensitive Columns to Protect**
After you define a sensitive type, you are ready to identify the columns to protect.
- **Step 3: Import the Sensitive Columns List from ADM into Your Database**
Next, you are ready to import the sensitive columns list from ADM into your database.
- **Step 4: Create the Transparent Sensitive Data Protection Policy**
After you have created the list of sensitive columns and imported this list into your database, you can create the transparent sensitive data protection policy.
- **Step 5: Associate the Policy with a Sensitive Type**
The `DBMS_TSDP_PROTECT.ASSOCIATE_POLICY` procedure associates a TSDP policy with a sensitive type.
- **Step 6: Enable the Transparent Sensitive Data Protection Policy**
You can enable the TSDP policy for the current database in a protected source, a specific table column, or a specific column type.
- **Step 7: Optionally, Export the Policy to Other Databases**
You can export or import the policy to or from another database.

15.6.1 Step 1: Create a Sensitive Type

The sensitive type is a class of data that you designate as sensitive.

For example, you can create a `credit_card_num_type` sensitive type for all credit card numbers.

- To create a sensitive type, either create it from an Enterprise Manager Cloud Control Application Data Model or use the `DBMS_TSDP_MANAGE.ADD_SENSITIVE_TYPE` PL/SQL procedure.

For example, to create the sensitive type `credit_card_num_type`:

```
BEGIN
  DBMS_TSDP_MANAGE.ADD_SENSITIVE_TYPE (
    sensitive_type => 'credit_card_num_type',
    user_comment  => 'Type for credit card columns using a number data type');
END;
/
```

In this example:

- `sensitive_type`: Create a name that describes the sensitive type that you want to capture. This value is case sensitive, so when you reference it later on, ensure that you use the case in which you created it. You can find existing sensitive types by querying the `DBA_SENSITIVE_COLUMN_TYPES` data dictionary view.
- `user_comment`: Optionally, enter a description for the sensitive type.

Related Topics

- *Oracle Database PL/SQL Packages and Types Reference*
- *Oracle Database Reference*

15.6.2 Step 2: Identify the Sensitive Columns to Protect

After you define a sensitive type, you are ready to identify the columns to protect.

Oracle Enterprise Manager searches for columns of sensitive data. You can use this procedure if you know which columns are sensitive. To identify the columns to protect, based on the sensitive type that you defined, you either can use an Enterprise Manager Cloud Control Application Data Model to identify sensitive columns manually, or you can use the `DBMS_TSDP_MANAGE.ADD_SENSITIVE_COLUMN` procedure.

To remove the column from the list of sensitive columns for the database, you can use the `DBMS_TSDP_MANAGE.DROP_SENSITIVE_COLUMN` procedure.

1. Find the sensitive type that you want to use.

For example:

```
SELECT NAME FROM DBA_SENSITIVE_COLUMN_TYPES;

NAME
-----
credit_card_num_type
```

2. Run the `DBMS_TSDP_MANAGE.ADD_SENSITIVE_COLUMN` procedure to associate the sensitive type with a table column. Ensure that you enter the `sensitive_type` parameter using the case in which you used to create the sensitive type.

For example:

```
BEGIN
  DBMS_TSDP_MANAGE.ADD_SENSITIVE_COLUMN(
    schema_name      => 'OE',
    table_name       => 'CUST_CC',
    column_name      => 'CREDIT_CARD',
    sensitive_type   => 'credit_card_num_type',
    user_comment     => 'Sensitive column addition of credit_card_num_type');
END;
/
```

15.6.3 Step 3: Import the Sensitive Columns List from ADM into Your Database

Next, you are ready to import the sensitive columns list from ADM into your database.

- If you had used an Application Data Model to create the list of sensitive columns, then import this list into your database by running the `DBMS_TSDP_MANAGE.IMPORT_DISCOVERY_RESULT` procedure.

If you had used the `DBMS_TSDP_MANAGE.ADD_SENSITIVE_COLUMN` procedure to identify these columns, then you can bypass this step.

For example, to import the Cloud Control Application Data Model into the current database:

```
BEGIN
  DBMS_TSDP_MANAGE.IMPORT_DISCOVERY_RESULT (
    discovery_result  => xml_adm_result,
    discovery_source  => 'ADM_Demo');
END;
/
```

In this example:

- `discovery_result` refers to the list of sensitive columns and their associated sensitive types. This list is in XML format.
- `discovery_source` refers to the name of the Application Data Model that contains the list of sensitive columns referred by the `discovery_result` setting. You can find a list of the Application Data Models from the Data Discovery and Modeling page in Enterprise Manager Cloud Control. (To access this page, from the **Enterprise** menu, select **Quality Management**, and then **Data Discovery and Modeling**. You can find a list of the sensitive columns and their associated types in the **Sensitive Columns** tab.)

15.6.4 Step 4: Create the Transparent Sensitive Data Protection Policy

After you have created the list of sensitive columns and imported this list into your database, you can create the transparent sensitive data protection policy.

- [About Creating the Transparent Sensitive Data Protection Policy](#)
The `DBMS_TSDP_PROTECT.ADD_POLICY` procedure creates the transparent sensitive data protection policy.
- [Creating the Transparent Sensitive Data Protection Policy](#)
You can create a transparent sensitive data protection policy that uses a partial number data type-based partial Data Redaction policy.

- [Setting the Oracle Data Redaction or Virtual Private Database Feature Options](#)
 The TSDP feature options describe the Oracle Data Redaction or Virtual Private Database settings to use for the transparent sensitive data protection policy.
- [Setting Conditions for the Transparent Sensitive Data Protection Policy](#)
 Optionally, you can specify conditions for the transparent sensitive data protection policy.
- [Specifying the DBMS_TSDP_PROTECT.ADD_POLICY Procedure](#)
 The `DBMS_TSDP_PROTECT.ADD_POLICY` procedure names the TSDP policy and executes the `FEATURE_OPTIONS` and `POLICY_CONDITIONS` settings.

15.6.4.1 About Creating the Transparent Sensitive Data Protection Policy

The `DBMS_TSDP_PROTECT.ADD_POLICY` procedure creates the transparent sensitive data protection policy.

After you have identified the sensitive columns, and if you had used an Application Data Model to create the list of sensitive columns, and imported this list into your database, you are ready to create the transparent sensitive data protection policy. To create the transparent sensitive data protection policy, you must configure it for the Virtual Private Database or Oracle Data Redaction settings that you want to use, and then apply these settings to a transparent sensitive data protection policy defined by `DBMS_TSDP_PROTECT.ADD_POLICY`.

You can create the policy by defining an anonymous block that has the following components:

- If you are using Oracle Data Redaction for your policy, a specification of the type of Data Redaction that you want to use, such as partial Data Redaction
- If you are using Oracle Virtual Private Database for your policy, a specification of the VPD settings that you want to use
- Conditions to test when the policy is enabled. For example, the data type of the column which should be satisfied before the policy can be enabled.
- A named transparent sensitive data protection policy to tie these components together, by using the `DBMS_TSDP_PROTECT.ADD_POLICY` procedure

After you create the sensitive type, it resides in the `SYS` schema.

Related Topics

- [Tutorial: Creating a TSDP Policy That Uses Virtual Private Database Protection](#)
 This tutorial demonstrates how to incorporate Oracle Virtual Private Database protection with a transparent sensitive data protection policy.

15.6.4.2 Creating the Transparent Sensitive Data Protection Policy

You can create a transparent sensitive data protection policy that uses a partial number data type-based partial Data Redaction policy.

[Example 15-1](#) shows how to create this type of policy.

- To create the policy, use the `DBMS_TSDP_PROTECT.ADD_POLICY` procedure, as shown in [Example 15-1](#).

Example 15-1 Creating a Transparent Sensitive Data Protection Policy

```
DECLARE
  redact_feature_options DBMS_TSDP_PROTECT.FEATURE_OPTIONS;
  policy_conditions DBMS_TSDP_PROTECT.POLICY_CONDITIONS;
BEGIN
```

```

redact_feature_options ('expression') :=
  'SYS_CONTEXT(''USERENV'', ''SESSION_USER'') = ''APPUSER''';
redact_feature_options ('function_type') := 'DBMS_REDACT.PARTIAL';
redact_feature_options ('function_parameters') := '0,1,6';
policy_conditions(DBMS_TSDP_PROTECT.DATATYPE) := 'NUMBER';
policy_conditions(DBMS_TSDP_PROTECT.LENGTH) := '16';
DBMS_TSDP_PROTECT.ADD_POLICY ('redact_partial_cc',
  DBMS_TSDP_PROTECT.REDACT,redact_feature_options,
  policy_conditions);
END;
/

```

In this example:

- `redact_feature_options DBMS_TSDP_PROTECT.FEATURE_OPTIONS` creates the variable `redact_feature_options`, which uses the `FEATURE_OPTIONS` procedure. See [Setting the Oracle Data Redaction or Virtual Private Database Feature Options](#) for more information.
- `policy_conditions DBMS_TSDP_PROTECT.POLICY_CONDITIONS` creates the variable `policy_conditions`, which uses the `POLICY_CONDITIONS` procedure. See [Setting Conditions for the Transparent Sensitive Data Protection Policy](#) for more information.
- `redact_feature_options` lines (3) write the Data Redaction policy settings to the `redact_feature_options` variable. This example applies the Data Redaction policy to the user `APPUSER` and defines the policy as a partial data redaction for number data types. See *Oracle Database Advanced Security Guide* for information about how the `function_parameters` parameter works for this case.
- `policy_conditions` lines (2) write the TSDP policy conditions to the `policy_conditions` variable (that is, the data type and length) for the protected `NUMBER` data type column.
- `DBMS_TSDP_PROTECT.ADD_POLICY` executes the `DBMS_TSDP_PROTECT.ADD_POLICY` procedure, which creates the `redact_partial_cc` TSDP policy. See [Specifying the DBMS_TSDP_PROTECT.ADD_POLICY Procedure](#) for more information.

If you want to see an example of a similar policy for VPD, see [Step 4: Create and Enable a Transparent Sensitive Data Protection Policy](#).

15.6.4.3 Setting the Oracle Data Redaction or Virtual Private Database Feature Options

The TSDP feature options describe the Oracle Data Redaction or Virtual Private Database settings to use for the transparent sensitive data protection policy.

- For Data Redaction, define the feature options by using the name `redact_feature_options` variable and for the type, you must use the type `DBMS_TSDP_PROTECT.FEATURE_OPTIONS`, which is an associative array of the data type `VARCHAR2(TSDP_PARAM_MAX)`. Initialize these options with the parameter-value pairs that correspond with the `DBMS_REDACT.ADD_POLICY` parameters.

For example, to specify a TSDP policy that specifies when Data Redaction should be applied:

```
redact_feature_option ('expression') := 'expression';
```

For a partial Data Redaction policy that uses a number data type for the protected column, the following example specifies the following additional parameter-value pairs:

```
redact_feature_options ('function_type') := 'DBMS_REDACT.PARTIAL';
redact_feature_options ('function_parameters') := 'values';
```

Similarly, for Virtual Private Database, you use the `vpd_feature_options` variable to define the VPD feature options. For example:

```
vpd_feature_options ('statement_types') := 'SELECT, INSERT, UPDATE, DELETE';
```

Related Topics

- [Oracle Database Advanced Security Guide](#)
- [DBMS_RLS.ADD_POLICY Parameters That Are Used for TSDP Policies](#)
 Oracle Database provides a set of parameters for fine-tuning the behavior of TSDP policies.

15.6.4.4 Setting Conditions for the Transparent Sensitive Data Protection Policy

Optionally, you can specify conditions for the transparent sensitive data protection policy.

- Specify the transparent sensitive data protection policy conditions in the following ways:
 - To define the conditions, use the name `policy_conditions` for the variable and for the type, use type `DBMS_TSDP_PROTECT.POLICY_CONDITIONS`, which is an associative array of the data type `VARCHAR2(TSDP_PARAM_MAX)`. The target column's properties should satisfy all the condition properties for the corresponding `DBMS_TSDP_PROTECT.FEATURE_OPTIONS` settings to be applied on the column.
 For example:

```
policy_conditions(DBMS_TSDP_PROTECT.DATATYPE) := 'NUMBER';
policy_conditions(DBMS_TSDP_PROTECT.LENGTH) := '16';
```
 - Optionally, to specify one or more of the following keys for the `POLICY_CONDITIONS` settings:
 - * `DBMS_TSDP_PROTECT.DATATYPE` enables you to specify a data type.
 - * `DBMS_TSDP_PROTECT.LENGTH` enables you to specify a data type length for the `DBMS_TSDP_PROTECT.DATATYPE` key.
 - * `DBMS_TSDP_PROTECT.PARENT_SCHEMA` enables you to restrict the policy to a specific schema. If you omit this setting, then the policy applies to all schemas in the database.
 - * `DBMS_TSDP_PROTECT.PARENT_TABLE` enables you to restrict the policy to a table specified by the `DBMS_TSDP_PROTECT.PARENT_SCHEMA` key. If you omit this setting, then the policy applies to all tables within the specified schema.
 - If you choose to omit conditions, you still must include the following line in the `DECLARE` variables. (In this case, the default value for `policy_conditions` is an empty associative array.)

```
policy_conditions SYS.DBMS_TSDP_PROTECT.POLICY_CONDITIONS;
```

15.6.4.5 Specifying the DBMS_TSDP_PROTECT.ADD_POLICY Procedure

The `DBMS_TSDP_PROTECT.ADD_POLICY` procedure names the TSDP policy and executes the `FEATURE_OPTIONS` and `POLICY_CONDITIONS` settings.

In the policy, the `redact_feature_options` and the `policy_conditions` settings work together: When the policy is enabled (using any of the `DBMS_TSDP_PROTECT.ENABLE_PROTECTION*`

procedures) on the target object, then the `redact_feature_options` settings apply only if the corresponding `policy_condition` settings are satisfied.

- To specify a procedure that names the transparent sensitive data protection policy and executes the necessary settings, include the following parameters:
 - `policy_name` creates a name for the TSDP policy. The name that you enter is stored in the database using the case sensitivity that you used when you created it. For example, if you had entered `redact_partial_cc`, then the database stores it as `redact_partial_cc`, not `redact_partial_cc`.
 - `security_feature` refers to the security feature the TSDP policy will use. Enter `DBMS_TSDP_PROTECT.REDACT` to specify Oracle Data Redaction.
 - `policy_enable_options` refers to the variable that you defined for the `DBMS_TSDP_PROTECT.FEATURE_OPTIONS` type.
 - `policy_apply_condition` refers to the variable that you defined for the `DBMS_TSDP_PROTECT.POLICY_CONDITIONS` type.

For example:

```
DBMS_TSDP_PROTECT.ADD_POLICY('redact_partial_cc', DBMS_TSDP_PROTECT.REDACT,
redact_feature_options, policy_conditions);
```

15.6.5 Step 5: Associate the Policy with a Sensitive Type

The `DBMS_TSDP_PROTECT.ASSOCIATE_POLICY` procedure associates a TSDP policy with a sensitive type.

1. Find the sensitive type that you want to use.

For example, to find a list of all sensitive types:

```
SELECT NAME FROM DBA_SENSITIVE_COLUMN_TYPES ORDER BY NAME;
```

```
NAME
-----
credit_card_num_type
```

2. Run the `DBMS_TSDP_PROTECT.ASSOCIATE_POLICY` procedure to associate the policy with a sensitive column type.

For example:

```
BEGIN
  DBMS_TSDP_PROTECT.ASSOCIATE_POLICY(
    policy_name      => 'redact_partial_cc',
    sensitive_type   => 'credit_card_num_type',
    associate        => true);
END;
/
```

The following query shows that the `credit_card_num_type` is now associated with the `redact_partial_cc` policy.

```
SELECT POLICY_NAME, SENSITIVE_TYPE FROM DBA_TSDP_POLICY_TYPE ORDER BY SENSITIVE_TYPE;
```

```
POLICY_NAME      SENSITIVE_TYPE
-----
redact_partial_cc credit_card_num_type
```

15.6.6 Step 6: Enable the Transparent Sensitive Data Protection Policy

You can enable the TSDP policy for the current database in a protected source, a specific table column, or a specific column type.

- [Enabling Protection for the Current Database in a Protected Source](#)
You can enable transparent sensitive data protection for the current database in a protected source.
- [Enabling Protection for a Specific Table Column](#)
You can enable transparent sensitive data protection for a specific column in a table.
- [Enabling Protection for a Specific Column Type](#)
You can enable transparent sensitive data protection for a specific column type, such as all columns that use the `VARCHAR2` data type.

15.6.6.1 Enabling Protection for the Current Database in a Protected Source

You can enable transparent sensitive data protection for the current database in a protected source.

If you must disable the protection, then you can run the `DBMS_TSDP_PROTECT.DISABLE_PROTECTION_SOURCE` procedure.

- Run the `DBMS_TSDP_PROTECT.ENABLE_PROTECTION_SOURCE` procedure to enable this type of protection.

For example, to enable transparent sensitive data protection policies for the `orders_db` database.

```
BEGIN
  DBMS_TSDP_PROTECT.ENABLE_PROTECTION_SOURCE(
    discovery_source => 'orders_db');
END;
/
```

15.6.6.2 Enabling Protection for a Specific Table Column

You can enable transparent sensitive data protection for a specific column in a table.

Remember that you can enable only one policy per table. If you must disable the protection, then you can run the `DBMS_TSDP_PROTECT.DISABLE_PROTECTION_COLUMN` procedure.

- Run the `DBMS_TSDP_PROTECT.ENABLE_PROTECTION_COLUMN` procedure to enable this type of protection.

For example, to enable the transparent sensitive data protection policy `redact_partial_cc` for a specific table column:

```
BEGIN
  DBMS_TSDP_PROTECT.ENABLE_PROTECTION_COLUMN(
    schema_name      => 'OE',
    table_name       => 'CUST_CC',
    column_name      => 'CREDIT_CARD',
    policy           => 'redact_partial_cc');
END;
/
```

If an ORA-45622: warnings generated during policy enforcement error appears, then check the configuration of the policy. In this example, the `redact_partial_cc` policy is enabled on a column if this column is of the `NUMBER` data type and has a length of 16. Even though the `OE.CUST_CC.CREDIT_CARD` column is associated with the `redact_partial_cc` policy, the policy is not enabled if this column fails to satisfy the conditions (data type and length).

15.6.6.3 Enabling Protection for a Specific Column Type

You can enable transparent sensitive data protection for a specific column type, such as all columns that use the `VARCHAR2` data type.

If you must disable the protection, then you can run the `DBMS_TSDP_PROTECT.DISABLE_PROTECTION_TYPE` procedure.

- Run the `DBMS_TSDP_PROTECT.ENABLE_PROTECTION_TYPE` procedure to enable this type of protection.

For example, to enable transparent sensitive data protection for all columns that use the `credit_card_num_type` sensitive type:

```
BEGIN
  DBMS_TSDP_PROTECT.ENABLE_PROTECTION_TYPE (
    sensitive_type      => 'credit_card_num_type');
END;
/
```

15.6.7 Step 7: Optionally, Export the Policy to Other Databases

You can export or import the policy to or from another database.

- To export or import the TSDP policy to or from another database, use Oracle Data Pump to perform a full export or import of the database that contains the policy.

Remember that the export and import operations apply to the entire database, not just the transparent sensitive data protection policy.

Related Topics

- *Oracle Database Utilities*
- *Using Oracle Database Vault Administrator's Guide*

15.7 Altering Transparent Sensitive Data Protection Policies

The `DBMS_TSDP_PROTECT.ALTER_POLICY` procedure can alter a TSDP policy.

When you alter a transparent data protection policy, you must define how the Data Redaction settings must change, and then apply these changes to the transparent sensitive data protection policy itself. You can find a list of existing policies and their protection definitions by querying the `DBA_TSDP_POLICY_FEATURE` data dictionary view.

- To alter a transparent sensitive data protection policy, use the `DBMS_TSDP_PROTECT.ALTER_POLICY` procedure.

For example, to alter an existing transparent sensitive data protection policy:

```
DECLARE
  redact_feature_options SYS.DBMS_TSDP_PROTECT.FEATURE_OPTIONS;
  policy_conditions SYS.DBMS_TSDP_PROTECT.POLICY_CONDITIONS;
BEGIN
```

```

redact_feature_options ('expression') :=
  'SYS_CONTEXT(''USERENV'', ''SESSION_USER'') = ''APPUSER''';
redact_feature_options ('function_type') := 'DBMS_REDACT.PARTIAL';
redact_feature_options ('function_parameters') := '9,1,6';
policy_conditions(DBMS_TSDP_PROTECT.DATATYPE) := 'NUMBER';
policy_conditions(DBMS_TSDP_PROTECT.LENGTH) := '22';
DBMS_TSDP_PROTECT.ALTER_POLICY ('redact_partial_cc',
  redact_feature_options, policy_conditions);
END;
/

```

In this example:

- `redact_feature_options SYS.DBMS_TSDP_PROTECT.FEATURE_OPTIONS` creates the variable `redact_feature_options`, which uses the `FEATURE_OPTIONS` data type.
- `policy_conditions SYS.DBMS_TSDP_PROTECT.POLICY_CONDITIONS` creates the variable `policy_conditions`, which uses the `POLICY_CONDITIONS` data type.
- `redact_feature_options ... redact_feature_options` writes the Data Redaction policy settings to the `redact_feature_option` variable. This example applies the Data Redaction policy to the user `APPUSER`, defines the policy as a partial data redaction for number data types.
- `policy_conditions ... policy_conditions` writes the TSDP policy conditions to the `policy_conditions` variable (that is, the data type and length) for the protected `NUMBER` data type column.
- `DBMS_TSDP_PROTECT.ALTER_POLICY ...` executes the `DBMS_TSDP_PROTECT.ALTER_POLICY` procedure, which alters the `redact_partial_cc` TSDP policy to use the definitions set in the `redact_feature_options` and `policy_conditions` variables.

15.8 Disabling Transparent Sensitive Data Protection Policies

The `DBMS_TSDP_PROTECT.DISABLE_PROTECTION_COLUMN` procedure disables one or all TSDP policies.

1. Query the `DBA_TSDP_POLICY_PROTECTION` data dictionary view to find the protected columns and their associated transparent sensitive data protection policies.

For example:

```
SELECT COLUMN_NAME, TSDP_POLICY FROM DBA_TSDP_POLICY_PROTECTION WHERE TABLE_NAME =
'CUST_CC';
```

```

COLUMN_NAME    TSDP_POLICY
-----
CREDIT_CARD    redact_partial_cc

```

2. Run the `DBMS_TSDP_PROTECT.DISABLE_PROTECTION_COLUMN` procedure.

For example, to disable the `redact_partial_cc` policy on the `CREDIT_CARD` column of the `CUST_CC` table:

```

BEGIN
DBMS_TSDP_PROTECT.DISABLE_PROTECTION_COLUMN(
  schema_name      => 'OE',
  table_name       => 'CUST_CC',
  column_name      => 'CREDIT_CARD',
  policy           => 'redact_partial_cc');

```

```
END;
/
```

You can use the % wildcard in this procedure to specify multiple items. For example, to disable protection for any columns that begin with CREDIT, you could enter the following:

```
BEGIN
  DBMS_TSDP_PROTECT.DISABLE_PROTECTION_COLUMN(
    schema_name      => 'OE',
    table_name       => 'CUST_CC',
    column_name      => 'CREDIT%',
    policy           => 'redact_partial_cc');
END;
/
```

To disable all transparent sensitive data protection policies for a table, you can omit the policy parameter. For example:

```
BEGIN
  DBMS_TSDP_PROTECT.DISABLE_PROTECTION_COLUMN(
    schema_name      => 'OE',
    table_name       => 'CUST_CC',
    column_name      => '%');
END;
/
```

15.9 Dropping Transparent Sensitive Data Protection Policies

You can drop an entire TSDP policy or a condition-enable-options combination from the policy.

If the policy only has one condition-enable-options combination, then Oracle Database drops the entire policy. You do not need to disable a policy before dropping it, but you do need to drop its associated sensitive column first, then its sensitive type.

1. Query the POLICY_NAME column of the DBA_TSDP_POLICY_FEATURE data dictionary view to find the policy that you want to drop.

```
SELECT POLICY_NAME FROM DBA_TSDP_POLICY_FEATURE;
```

```
POLICY_NAME
-----
redact_partial_cc
```

Remember that you must be granted the SELECT_CATALOG_ROLE role to query the transparent sensitive data protection data dictionary views.

2. Find the sensitive column that is associated with this policy.

For example:

```
SELECT COLUMN_NAME FROM DBA_TSDP_POLICY_PROTECTION WHERE TSDP_POLICY =
'redact_partial_cc';
```

```
COLUMN_NAME
-----
CREDIT_CARD
```

3. Drop this sensitive column.

For example:

```
BEGIN
  DBMS_TSDP_MANAGE.DROP_SENSITIVE_COLUMN (
```

```

    schema_name      => 'OE',
    table_name       => 'CUST_CC',
    column_name      => 'CREDIT_CARD');
END;
/

```

4. Find the sensitive type that is associated with this policy.

For example:

```

SELECT SENSITIVE_TYPE FROM DBA_TSDP_POLICY_TYPE WHERE POLICY_NAME =
'redact_partial_cc';

SENSITIVE_TYPE
-----
credit_card_num_type

```

5. Drop this sensitive type.

For example:

```

BEGIN
  DBMS_TSDP_MANAGE.DROP_SENSITIVE_TYPE ( sensitive_type =>
'credit_card_num_type');END;
/

```

6. Run the DBMS_TSDP_PROTECT.DROP_POLICY procedure to drop the policy.

For example, to completely drop the policy:

```

BEGIN
  DBMS_TSDP_PROTECT.DROP_POLICY(
    policy_name => 'redact_partial_cc');
END;
/

```

To drop the default condition-enable options combination from the policy:

```

DECLARE
  policy_conditions DBMS_TSDP_PROTECT.POLICY_CONDITIONS;
BEGIN
  DBMS_TSDP_PROTECT.DROP_POLICY ('redact_partial_cc', policy_conditions);
END;
/

```

To drop the default condition-enable options combination from the policy based on a specific condition:

```

DECLARE
  policy_conditions DBMS_TSDP_PROTECT.POLICY_CONDITIONS;
BEGIN
  policy_conditions (DBMS_TSDP_PROTECT.DATATYPE) := 'NUMBER';
  DBMS_TSDP_PROTECT.DROP_POLICY ('redact_partial_cc', policy_conditions);
END;
/

```

15.10 Using the Predefined REDACT_AUDIT Policy for Redaction

The predefined REDACT_AUDIT policy masks bind values, which can appear in trace files when an event is set.

- [About the REDACT_AUDIT Policy](#)
The predefined REDACT_AUDIT transparent sensitive data protection policy masks bind values.
- [Variables Associated with Sensitive Columns](#)
Bind variables affect the use of sensitive columns with conditions, SELECT items, and INSERT or UPDATE operations.
- [How Bind Variables on Sensitive Columns Behave with Views](#)
A bind variable that appears in a query on a view is considered sensitive if the view column references a sensitive column.
- [Disabling the REDACT_AUDIT Policy](#)
By default, the REDACT_AUDIT policy is enabled for all sensitive columns.
- [Enabling the REDACT_AUDIT Policy](#)
You can enable the REDACT_AUDIT policy for a specific sensitive column or for all columns in the database.

15.10.1 About the REDACT_AUDIT Policy

The predefined REDACT_AUDIT transparent sensitive data protection policy masks bind values.

The bind values of the bind variables that are used in SQL statements can appear in audit records when auditing is configured. Similarly, bind values can appear in trace files when the appropriate event is set. Bind values can also appear when you query the V\$SQL_BIND_DATA dynamic view.

The REDACT_AUDIT transparent sensitive data protection policy displays the data as an asterisk (*) in audit records, trace files, and in V\$SQL_BIND_DATA view queries. By default the REDACT_AUDIT policy is associated with every sensitive type in the database. When you identify a column as sensitive, by default, the REDACT_AUDIT policy is enabled for it.

You can disable and enable the REDACT_AUDIT policy, but you cannot alter or drop it.

15.10.2 Variables Associated with Sensitive Columns

Bind variables affect the use of sensitive columns with conditions, SELECT items, and INSERT or UPDATE operations.

- [About Variables Associated with Sensitive Columns](#)
You can associate variables with sensitive columns in TSDP policies.
- [Bind Variables and Sensitive Columns in the Expressions of Conditions](#)
You can include sensitive columns in SQL queries that have WHERE clauses.
- [A Bind Variable and a Sensitive Column Appearing in the Same SELECT Item](#)
If a column in a SELECT item is sensitive, then all the binds in the SELECT item are considered sensitive.
- [Bind Variables in Expressions Assigned to Sensitive Columns in INSERT or UPDATE Operations](#)
You can assign multiple bind variables to different columns in one INSERT or UPDATE statement.

15.10.2.1 About Variables Associated with Sensitive Columns

You can associate variables with sensitive columns in TSDP policies.

A bind variable can be considered to be sensitive or "associated" with a sensitive column if the bind variable occurs in the same comparison condition as a sensitive column, if it occurs in a `SELECT` statement alongside a sensitive column, or if it occurs in an `INSERT` or `UPDATE` operation that involves a sensitive column.

15.10.2.2 Bind Variables and Sensitive Columns in the Expressions of Conditions

You can include sensitive columns in SQL queries that have `WHERE` clauses.

A SQL query that contains a `WHERE` clause can include sensitive columns and bind variables for use with comparison operators such as `=`, `IS`, `IS NOT`, `LIKE`, `BETWEEN`, and `IN`, as well as in subqueries.

In the following comparison query, the bind value in `VAR1` is masked because `VAR1` and the sensitive column `SALARY` appear in the expression that is compared using the comparison condition `>`.

```
SELECT EMPLOYEE_ID FROM HR.EMPLOYEES WHERE SALARY > :VAR1;
```

In the next query, the bind values in `VAR1` and `VAR2` are masked because `VAR1`, `VAR2`, and the sensitive column `SALARY` appear in the expression that uses the comparison equality condition `=`.

```
SELECT EMPLOYEE_ID FROM HR.EMPLOYEES WHERE SALARY + :VAR1 = TO_NUMBER(:VAR2, '9G999D99');
```

For floating point conditions, the sensitive column and the bind variable appear in the expression that is evaluated. In the following example, the bind value in `VAR1` is masked because `VAR1` and the sensitive column `SALARY` appear in the expression for the `IS NOT NAN` condition.

```
SELECT COUNT( ) FROM HR.EMPLOYEES WHERE (SALARY * :VAR1) IS NOT NAN;
```

In pattern matching conditions, the sensitive column and the bind variable appear as arguments. In the following example, the bind value in `VAR1` is masked because `VAR1` and the sensitive column `LAST_NAME` are the arguments for the `LIKE` condition.

```
SELECT LAST_NAME FROM HR.EMPLOYEES WHERE LAST_NAME LIKE :VAR1;
```

For `BETWEEN` conditions, the sensitive column and the bind variable appear in the expressions that are arguments. In the following example, bind values in `VAR1` and `VAR2` are masked because `VAR1`, `VAR2`, and `SALARY` appear in expressions that are arguments to the `BETWEEN` condition.

```
SELECT EMPLOYEE_ID FROM HR.EMPLOYEES WHERE SALARY BETWEEN :VAR1 AND :VAR2;
```

In the next example, the sensitive column and the bind variable are the arguments of the `IN` condition. Here, the bind values in `VAR1` and `VAR2` are masked because `VAR1`, `VAR2`, and the sensitive column `SALARY` appear as arguments to the `IN` condition.

```
SELECT COUNT( ) FROM HR.EMPLOYEES WHERE SALARY IN ( :VAR1, :VAR2);
```

When a condition has a nested subquery as an argument, the bind variables and sensitive columns that appear in the nested subquery are not considered to be associated with the condition. In the following query, the sensitive column `SALARY` and the subquery are expressions for the greater-than condition `>`.

```
SELECT EMPLOYEE_ID FROM HR.EMPLOYEES WHERE SALARY > (SELECT SALARY FROM HR.EMPLOYEES WHERE MANAGER_ID = :VAR1);
```

However, variable `VAR1` is associated with column `MANAGER_ID` as variable `VAR1` and `MANAGER_ID` appears in expressions being compared using the condition `=`. Because `MANAGER_ID` is not a sensitive column, variable `VAR1` is not considered sensitive. The variable `VAR1` is not considered to be associated with the sensitive column `SALARY`.

In the case of the logical conditions, model conditions, multiset conditions, XML conditions, compound conditions, `IS OF` type conditions, and `EXISTS` conditions, there can be no cases where a bind variable and a sensitive column are associated with each other. This is due to the structure or the nature of these conditions.

15.10.2.3 A Bind Variable and a Sensitive Column Appearing in the Same SELECT Item

If a column in a `SELECT` item is sensitive, then all the binds in the `SELECT` item are considered sensitive.

For example, assume that `HR.EMPLOYEES.SALARY` and `HR.EMPLOYEES.COMMISSION_PCT` are sensitive columns. In the following query, the bind variable `VAR1` is considered sensitive because it appears in the same `SELECT` item as the sensitive column `SALARY`, so its bind value is masked.

```
SELECT (SALARY * :VAR1) AS BONUS AS FROM HR.EMPLOYEES WHERE EMPLOYEE_ID = :VAR2;
```

In the next example, the bind variable `VAR1` is considered sensitive because it appears in the same `SELECT` item as `SALARY`. `VAR2` is considered sensitive because it appears in the same `SELECT` item as the sensitive column `COMMISSION_PCT`.

```
SELECT (SALARY * :VAR1), (COMMISSION_PCT * :VAR2), (EMPNO + :VAR3) AS BONUS AS FROM PAYROLL.ACCOUNT;
```

15.10.2.4 Bind Variables in Expressions Assigned to Sensitive Columns in INSERT or UPDATE Operations

You can assign multiple bind variables to different columns in one `INSERT` or `UPDATE` statement.

Consider the following `INSERT` statement:

```
INSERT INTO PAYROLL.ACCOUNT (ACCOUNT_NUM, SALARY) VALUES (:VAR1 * :VAR2 , :VAR3);
```

In this `INSERT` statement, the following takes place:

- The bind variables `VAR1` and `VAR2` appear in the expression `(:VAR1 * :VAR2)`, which is assigned to the sensitive column `ACCOUNT_NUM`.
- The bind variable `VAR3` is assigned to sensitive column `SALARY`.

Consider the following `UPDATE` statement:

```
UPDATE PAYROLL.ACCOUNT SET ACCOUNT_NUM = :VAR1, SALARY = :VAR2;
```

In this `UPDATE` statement, the following takes place:

- The bind variable `VAR1` is assigned to sensitive column `ACCOUNT_NUM`.
- The bind variable `VAR2` is assigned to sensitive column `SALARY`.

15.10.3 How Bind Variables on Sensitive Columns Behave with Views

A bind variable that appears in a query on a view is considered sensitive if the view column references a sensitive column.

For example, suppose you identify the `SALARY` column in the `HR.EMPLOYEES` table as sensitive. Then you create the view `EMPLOYEES_VIEW` as follows:

```
CREATE OR REPLACE VIEW HR.EMPLOYEES_VIEW AS SELECT * FROM HR.EMPLOYEES;
```

When a user references the `SALARY` column from this view in a SQL statement, any bind variable that has been associated with the `SALARY` column is considered sensitive and its bind value then masked.

```
SELECT EMPLOYEE_ID FROM HR.EMPLOYEES_VIEW WHERE SALARY = :VAR1;
```

In this case, the bind variable `VAR1` is masked because it is associated with the `HR.EMPLOYEES_VIEW.SALARY` column, which references the sensitive column `HR.EMPLOYEES.SALARY`.

15.10.4 Disabling the REDACT_AUDIT Policy

By default, the `REDACT_AUDIT` policy is enabled for all sensitive columns.

You can disable it for a specific sensitive column or all sensitive columns, and when needed, re-enable it. Remember that you cannot alter or delete the `REDACT_AUDIT` policy.

- To disable the `REDACT_AUDIT` policy, use the `DBMS_TSDP_PROTECT.DISABLE_PROTECTION_COLUMN` procedure.

For example, to disable the `REDACT_AUDIT` policy for the `SALARY` column of `HR.EMPLOYEES`:

```
BEGIN
  DBMS_TSDP_PROTECT.DISABLE_PROTECTION_COLUMN(
    schema_name      => 'HR',
    table_name       => 'EMPLOYEES',
    column_name      => 'SALARY',
    policy           => 'REDACT_AUDIT');
END;
/
```

The following example shows how to disable the `REDACT_AUDIT` policy for all sensitive columns in the current database.

```
BEGIN
  DBMS_TSDP_PROTECT.DISABLE_PROTECTION_COLUMN(
    policy           => 'REDACT_AUDIT');
END;
/
```

15.10.5 Enabling the REDACT_AUDIT Policy

You can enable the `REDACT_AUDIT` policy for a specific sensitive column or for all columns in the database.

- To enable the `REDACT_AUDIT` policy, use the `DBMS_TSDP_PROTECT.ENABLE_PROTECTION_COLUMN` procedure.

For example, to re-enable the `REDACT_AUDIT` policy for the `SALARY` column of `HR.EMPLOYEES`:

```
BEGIN
  DBMS_TSDP_PROTECT.ENABLE_PROTECTION_COLUMN(
    schema_name      => 'HR',
    table_name       => 'EMPLOYEES',
    column_name      => 'SALARY',
    policy           => 'REDACT_AUDIT');
END;
/
```

The following example shows how to enable the `REDACT_AUDIT` policy for all sensitive columns in the current database.

```
BEGIN
  DBMS_TSDP_PROTECT.ENABLE_PROTECTION_COLUMN(
    policy           => 'REDACT_AUDIT');
END;
/
```

15.11 Transparent Sensitive Data Protection Policies with Data Redaction

Oracle Data Redaction features work with transparent sensitive data protection policies.

The Data Redaction function types, function parameters, and expressions can be used in the TSDP policy definition. For example, you can set the enable the TSDP policy to use `FULL` or `PARTIAL` data redaction. This chapter uses Data Redaction for examples of managing TSDP policies.

Related Topics

- [Creating Transparent Sensitive Data Protection Policies](#)
You must create a sensitive type, find the sensitive columns to be protected, and then import these columns from Application Dependency Management (ADM) into your database.
- *Oracle Database Advanced Security Guide*

15.12 Using Transparent Sensitive Data Protection Policies with Oracle VPD Policies

You can combine protections from TSDP and Oracle Virtual Private Database into one policy.

- [About Using TSDP Policies with Oracle Virtual Private Database Policies](#)
To incorporate Oracle Virtual Private Database protection with transparent sensitive data protection policies, you must use the `DBMS_TSDP_PROTECT` and `DBMS_RLS` packages.
- [DBMS_RLS.ADD_POLICY Parameters That Are Used for TSDP Policies](#)
Oracle Database provides a set of parameters for fine-tuning the behavior of TSDP policies.
- [Tutorial: Creating a TSDP Policy That Uses Virtual Private Database Protection](#)
This tutorial demonstrates how to incorporate Oracle Virtual Private Database protection with a transparent sensitive data protection policy.

15.12.1 About Using TSDP Policies with Oracle Virtual Private Database Policies

To incorporate Oracle Virtual Private Database protection with transparent sensitive data protection policies, you must use the `DBMS_TSDP_PROTECT` and `DBMS_RLS` packages.

This feature works as follows:

1. You create a VPD policy function with a suitable predicate. Later on, when you create the TSDP policy, you will refer to this VPD policy function by using the `policy_function` setting of the `DBMS_RLS.ADD_POLICY` procedure for the `feature_options` parameter of the `DBMS_TSDP_PROTECT.ADD_POLICY` procedure.

2. You create a TSDP policy with the necessary VPD settings similar to the VPD policy function.

The TSDP policy uses parameter settings from the `DBMS_RLS.ADD_POLICY` procedure to provide VPD protection. Be aware that parameters from the `DBMS_RLS.ADD_GROUPED_POLICY` policy are not supported.

3. You associate the TSDP policy with the necessary sensitive types by using the `DBMS_TSDP_PROTECT.ASSOCIATE_POLICY` procedure.
4. You then enable TSDP protection by using any of the `DBMS_TSDP_PROTECT.ENABLE_PROTECTION_*` procedures.
5. You enable the TSDP policy. At this point, Oracle Database creates an internal VPD policy that uses the function that you created.

The name of the internal policy begins with `ORA$VPD` followed by an identifier (for example, `ORA$VPD_6J6L3RSJSN2VAN0XF`). You can find this policy by querying the `POLICY_NAME` column of the `DBA_POLICIES` data dictionary view.

6. When users query the table, the output for the column is based on both the VPD protections and the TSDP policy that are now in place.
7. These protections remain in place until you disable the TSDP policy for this column. At that point, Oracle Database automatically drops the internal VPD policy, because it is no longer needed. If you reenables the TSDP policy, then the internal VPD policy is recreated.

Related Topics

- [DBMS_RLS.ADD_POLICY Parameters That Are Used for TSDP Policies](#)
Oracle Database provides a set of parameters for fine-tuning the behavior of TSDP policies.
- [Function to Generate the Dynamic WHERE Clause](#)
The Oracle Virtual Private Database (VPD) function defines the restrictions that you want to enforce.

15.12.2 DBMS_RLS.ADD_POLICY Parameters That Are Used for TSDP Policies

Oracle Database provides a set of parameters for fine-tuning the behavior of TSDP policies.

[Table 15-1](#) describes the `DBMS_RLS.ADD_POLICY` parameters that are permissible in the `FEATURE_OPTIONS` parameter when you use the `DBMS_TSDP_PROTECT.ADD_POLICY` or `DBMS_TSDP_PROTECT.ALTER_POLICY` procedure.

Table 15-1 DBMS_RLS.ADD_POLICY Parameters Used for TSDP Policies

Parameter	Description	Default
function_schema	Schema of the policy function (current default schema, if NULL). If no function_schema is specified, then the current user's schema is assumed.	NULL
policy_function	Name of a function that generates a predicate for the policy. If the function is defined within a package, then you must include the name of the package (for example, my_package.my_function).	NULL
statement_types	Statement types to which the policy applies. It can be any combination of INDEX, SELECT, INSERT, UPDATE, or DELETE. The default is to apply to most of these types except INDEX.	NULL
update_check	Optional argument for INSERT or UPDATE statement types. Setting update_check to TRUE sets Oracle Database to check the policy against the value after an INSERT or UPDATE operation. The check applies only to the security relevant columns that are included in the policy definition. In other words, the INSERT or UPDATE operation will fail only if the security relevant column that is defined in the policy is added or updated in the INSERT or UPDATE statement.	FALSE
static_policy	If you set this value to TRUE, then Oracle Database assumes that the policy function for the static policy produces the same predicate string for anyone accessing the object, except for SYS or the privileged user who has the EXEMPT ACCESS POLICY privilege.	FALSE
policy_type	Default is NULL, which means policy_type is decided by the value of the static_policy parameter. Specifying any of these policy types overrides the value of static_policy.	NULL
long_predicate	Default is FALSE, which means the policy function can return a predicate with a length of up to 4000 bytes. TRUE means the predicate text string length can be up to 32K bytes. Policies existing before the availability of the long_predicate parameter retain a 32K limit.	FALSE
sec_relevant_cols_opt	If you specify this parameter, then transparent sensitive data protection inputs the sensitive column on which the protection is enabled to the sec_relevant_cols parameter of the DBMS_RLS.ADD_POLICY procedure. Allowed values are for sec_relevant_cols_opt are as follows: <ul style="list-style-type: none"> • NULL enables the filtering defined with sec_relevant_cols to take effect. • DBMS_RLS.ALL_ROWS displays all rows, but with sensitive column values, which are filtered by the sec_relevant_cols parameter, they display as NULL. 	NULL

Related Topics

- [Attaching a Policy to a Database Table, View, or Synonym](#)
The `DBMS_RLS` PL/SQL package can attach a policy to a table, view, or synonym.

15.12.3 Tutorial: Creating a TSDP Policy That Uses Virtual Private Database Protection

This tutorial demonstrates how to incorporate Oracle Virtual Private Database protection with a transparent sensitive data protection policy.

- [Step 1: Create the hr_appuser User Account](#)
First, you must create a sample user account and then grant this user the appropriate privileges.
- [Step 2: Identify the Sensitive Columns](#)
As the sample user `tsdp_admin`, you are ready to identify sensitive columns to protect.
- [Step 3: Create an Oracle Virtual Private Database Function](#)
TSDP will associate the Oracle VPD policy function with the VPD policy that is automatically created when the TSDP policy is enabled.
- [Step 4: Create and Enable a Transparent Sensitive Data Protection Policy](#)
After you have created the VPD policy function, you can associate it with a transparent sensitive data protection policy.
- [Step 5: Test the Transparent Sensitive Data Protection Policy](#)
Now, you are ready to test the transparent sensitive data protection policy.
- [Step 6: Remove the Components of This Tutorial](#)
If you no longer need the components of this tutorial, then you can remove them.

15.12.3.1 Step 1: Create the hr_appuser User Account

First, you must create a sample user account and then grant this user the appropriate privileges.

1. Log in to a PDB as user `SYS` with the `SYSDBA` administrative privilege.

```
sqlplus sys@pdb_name as sysdba
Enter password: password
```

To find the available PDBs in a CDB, log in to the CDB root container and then query the `PDB_NAME` column of the `DBA_PDBS` data dictionary view. To check the current container, run the `show con_name` command.

2. Create the following user accounts:

```
GRANT CREATE SESSION TO hr_appuser IDENTIFIED BY password;
GRANT CREATE SESSION TO tsdp_admin IDENTIFIED BY password;
```

Replace `password` with a password that is secure.

3. Grant user `tsdp_admin` the following privileges:

```
GRANT CREATE PROCEDURE TO tsdp_admin;
GRANT EXECUTE ON DBMS_TSDP_MANAGE TO tsdp_admin;
GRANT EXECUTE ON DBMS_TSDP_PROTECT TO tsdp_admin;
GRANT EXECUTE ON DBMS_RLS TO tsdp_admin;
```

4. Connect as user `SCOTT`.

```
CONNECT SCOTT@pdb_name
Enter password: password
```

5. Grant the `hr_appuser` the `READ` object privilege for the `EMP` table.

```
GRANT READ ON EMP TO hr_appuser;
```

Related Topics

- [Guidelines for Securing Passwords](#)
Oracle provides guidelines for securing passwords in a variety of situations.

15.12.3.2 Step 2: Identify the Sensitive Columns

As the sample user `tsdp_admin`, you are ready to identify sensitive columns to protect.

1. Connect as user `tsdp_admin`.

```
CONNECT tsdp_admin@pdb_name
Enter password: password
```

2. Create the `salary_type` sensitive type:

```
BEGIN
  DBMS_TSDP_MANAGE.ADD_SENSITIVE_TYPE (
    sensitive_type => 'salary_type',
    user_comment  => 'Type for SCOTT.EMP column');
END;
/
```

3. Associate the `salary_type` sensitive type with the `SCOTT.EMP` table.

```
BEGIN
  DBMS_TSDP_MANAGE.ADD_SENSITIVE_COLUMN (
    schema_name      => 'SCOTT',
    table_name       => 'EMP',
    column_name      => 'SAL',
    sensitive_type   => 'salary_type',
    user_comment     => 'Sensitive column addition of SALARY_TYPE');
END;
/
```

15.12.3.3 Step 3: Create an Oracle Virtual Private Database Function

TSDP will associate the Oracle VPD policy function with the VPD policy that is automatically created when the TSDP policy is enabled.

- To create the VPD policy function, use the `CREATE OR REPLACE FUNCTION` procedure, as follows:

```
CREATE OR REPLACE FUNCTION vpd_function (
  v_schema IN VARCHAR2,
  v_objname IN VARCHAR2)
  RETURN VARCHAR2 AS
BEGIN
  RETURN 'SYS_CONTEXT(''USERENV'', 'SESSION_USER') = 'HR_APPUSER'';
END vpd_function;
/
```

15.12.3.4 Step 4: Create and Enable a Transparent Sensitive Data Protection Policy

After you have created the VPD policy function, you can associate it with a transparent sensitive data protection policy.

1. Create the Transparent Sensitive Data Protection policy.

```
DECLARE
  vpd_feature_options DBMS_TSDP_PROTECT.FEATURE_OPTIONS;
  policy_conditions DBMS_TSDP_PROTECT.POLICY_CONDITIONS;
BEGIN
  vpd_feature_options ('policy_function') := 'vpd_function';
  vpd_feature_options ('sec_relevant_cols_opt') := 'DBMS_RLS.ALL_ROWS';
  dbms_tsdp_protect.add_policy('tsdp_vpd', DBMS_TSDP_PROTECT.VPD,
  vpd_feature_options, policy_conditions);
END;
/
```

In this example, the `vpd_feature_options` parameter refers to the `sec_relevant_cols_opt` parameter from the `DBMS_RLS.ADD_POLICY` procedure. When the TSDP policy is enabled, the VPD policy that is automatically created will have its `sec_relevant_cols` parameter (of `DBMS_RLS.ADD_POLICY`) set to the name of the sensitive column on which TSDP enables the VPD policy. If you had not used the `sec_relevant_cols_opt` parameter, then TSDP would not have used the `DBMS_RLS.ADD_POLICY sec_relevant_cols_opt` parameter.

2. Associate the `tsdp_vpd1` TSDP policy with the `salary_type` sensitive type.

```
BEGIN
  DBMS_TSDP_PROTECT.ASSOCIATE_POLICY(
    policy_name      => 'tsdp_vpd',
    sensitive_type   => 'salary_type',
    associate        => TRUE);
END;
/
```

3. Enable protection to enforce the Virtual Private Database policy on all columns identified as `SALARY_TYPE`:

```
BEGIN
  DBMS_TSDP_PROTECT.ENABLE_PROTECTION_TYPE(
    sensitive_type   => 'salary_type');
END;
/
```

15.12.3.5 Step 5: Test the Transparent Sensitive Data Protection Policy

Now, you are ready to test the transparent sensitive data protection policy.

1. Connect as user `hr_appuser`.

```
CONNECT hr_appuser@pdb_name
Enter password: password
```

2. Query the `SCOTT.EMP` table as follows:

```
SELECT SAL, COMM, EMPNO FROM SCOTT.EMP;
```

The following output appears:

SAL	COMM	EMPNO
800		7369
1600	300	7499
1250	500	7521
2975		7566
1250	1400	7654
2850		7698

```

2450      7782
3000      7788
5000      7839
1500     0    7844
1100      7876
   950     7900
3000      7902
1300      7934

```

14 rows selected.

The `vpd_function` function enables user `hr_appuser` to see the salaries in the `SAL` column of the `EMP` table.

3. Connect as user `SCOTT` and then perform the same query.

```

CONNECT SCOTT@pdb_name
Enter password: password

SELECT SAL, COMM, EMPNO FROM SCOTT.EMP;

```

The following output appears:

```

      SAL      COMM      EMPNO
-----
          7369
          300     7499
          500     7521
          7566
         1400     7654
          7698
          7782
          7788
          7839
           0     7844
          7876
          7900
          7902
          7934

```

14 rows selected.

Even though `SCOTT` owns the `EMP` table, the `vpd_function` function prevents him from seeing the salaries in the `SAL` column of this table

15.12.3.6 Step 6: Remove the Components of This Tutorial

If you no longer need the components of this tutorial, then you can remove them.

1. Connect as user `tsdp_admin`.

```

CONNECT tsdp_admin@pdb_name
Enter password: password

```

2. Run the following statements in the order shown.

```

BEGIN
  DBMS_TSDP_MANAGE.DROP_SENSITIVE_COLUMN (
    schema_name      => 'SCOTT',
    table_name       => 'EMP',
    column_name      => 'SAL');
END;
/

```



```
BEGIN
  DBMS_TSDP_MANAGE.DROP_SENSITIVE_TYPE (
    sensitive_type => 'salary_type');
END;
/

BEGIN
  DBMS_TSDP_PROTECT.DROP_POLICY (
    policy_name => 'tsdp_vpd');
END;
/
```

3. Connect as user SYSTEM.

```
CONNECT SYSTEM@pdb_name
Enter password: password
```

4. Drop the tsdp_admin and hr_appuser accounts.

```
DROP USER tsdp_admin CASCADE;
DROP USER hr_appuser
```

15.13 Using Transparent Sensitive Data Protection Policies with Unified Auditing

The transparent sensitive data protection and unified auditing procedures can combine the protections of these two features.

- [About Using TSDP Policies with Unified Audit Policies](#)
You can configure transparent sensitive data protection policies to audit object actions using unified auditing.
- [Unified Audit Policy Settings That Are Used with TSDP Policies](#)
Audit policy settings can be used in the `POLICY_ENABLE_OPTIONS` parameter for the `DBMS_TSDP_PROTECT.ADD_POLICY` or `DBMS_TSDP_PROTECT.ALTER_POLICY` procedure.

15.13.1 About Using TSDP Policies with Unified Audit Policies

You can configure transparent sensitive data protection policies to audit object actions using unified auditing.

The `DBMS_TSDP_PROTECT.ADD_POLICY` and `DBMS_TSDP_PROTECT.ALTER_POLICY` procedures enable you to specify settings from the `CREATE AUDIT POLICY`, `ALTER AUDIT POLICY`, `AUDIT POLICY`, and `COMMENT SQL` statements. The TSDP policy enables the creation of action audit-options for object-specific options in the policy, such as `INSERT` or `DELETE` operations. System-wide audit options are not supported. Therefore, the audited object type is always `TABLE`. Only standard actions (such as `INSERT`) are permitted. Component actions, such as creating policies for Oracle Label Security or other Oracle Database features, are not supported.

This feature works as follows:

1. You create a TSDP policy with the necessary unified audit settings.
The TSDP policy uses parameter settings from the `CREATE AUDIT POLICY`, `AUDIT POLICY`, and `COMMENT` statements.
2. You associate the TSDP policy with the necessary sensitive types by using the `DBMS_TSDP_PROTECT.ASSOCIATE_POLICY` procedure.

3. You then enable TSDP protection by using any of the `DBMS_TSDP_PROTECT.ENABLE_PROTECTION_*` procedures.
4. You enable the TSDP policy. As part of the TSDP policy enablement process, Oracle Database internally creates a unified audit policy and then enables it on the list of target users and roles that you specified in the `DBMS_TSDP_PROTECT.ADD_POLICY` procedure.

The name of the internal policy begins with `ORA$UNIFIED_AUDIT_` followed by a random alpha-numeric string (for example, `ORA$UNIFIED_AUDIT_6J6L3RSJSN2VAN0XF`). You can find this policy by querying the `POLICY_NAME` column of the `AUDIT_UNIFIED_POLICIES` data dictionary view. To find the names of the users and roles on which this internally created TSDP unified audit policy is enforced, query the `AUDIT_UNIFIED_ENABLED_POLICIES` view.
5. When users try to perform an action on the table that is being protected by the TSDP policy, then based on the TSDP unified audit policy configuration, a unified audit record is written to the unified audit trail for this object access. You can then query the `UNIFIED_AUDIT_TRAIL` view to see the unified audit record that was created because of the TSDP unified audit policy enforcement.
6. These protections remain in place until you disable the TSDP policy for this column. At that point, Oracle Database automatically disables and then drops the internal policy, because it is no longer necessary. (A unified audit policy must be disabled before it can be dropped.) If you re-enable the TSDP policy, then the internal policy is recreated.

Related Topics

- [Unified Audit Policy Settings That Are Used with TSDP Policies](#)
Audit policy settings can be used in the `POLICY_ENABLE_OPTIONS` parameter for the `DBMS_TSDP_PROTECT.ADD_POLICY` or `DBMS_TSDP_PROTECT.ALTER_POLICY` procedure.

15.13.2 Unified Audit Policy Settings That Are Used with TSDP Policies

Audit policy settings can be used in the `POLICY_ENABLE_OPTIONS` parameter for the `DBMS_TSDP_PROTECT.ADD_POLICY` or `DBMS_TSDP_PROTECT.ALTER_POLICY` procedure.

These audit policy settings are from the `AUDIT`, `CREATE AUDIT POLICY`, and `ALTER AUDIT POLICY` statements.

The following table describes these settings.

Table 15-2 Unified Audit Policy Settings Used for TSDP Policies

Parameter	Description	Default
<code>ACTION_AUDIT_OPTIONS</code>	A string containing a comma-separated list of SQL actions. Valid actions are: ALTER, AUDIT, COMMENT, DELETE, FLASHBACK, GRANT, INDEX, INSERT, LOCK, RENAME, SELECT, UPDATE To configure the policy to audit all of these actions, specify the keyword ALL.	ALL

Table 15-2 (Cont.) Unified Audit Policy Settings Used for TSDP Policies

Parameter	Description	Default
AUDIT_CONDITION	<p><code>SYS_CONTEXT (namespace, attribute) operation value-list</code></p> <p>In this syntax, <i>operation</i> can be any of the following operators: IN, NOT IN, =, <, >, or <></p> <p>If the audit condition contains a single quotation mark, then specify two single quotation marks instead of one, and enclose the <code>SYS_CONTEXT</code> in single quotations. For example:</p> <pre>'SYS_CONTEXT('USERENV', 'CLIENT_IDENTIFIER') = 'myclient''</pre>	NULL
EVALUATE_PER	<p>Can be one of the following:</p> <ul style="list-style-type: none"> STATEMENT SESSION INSTANCE 	STATEMENT
ENTITY_NAME	A string that contains a comma-separated list of users or roles. If you omit this parameter, then the audit policy is enabled for all users.	NULL (that is, all database users)
ENABLE_OPTION	<p>Applies only if the <code>ENTITY_NAME</code> parameter is used. It specifies if the <code>ENTITY_NAME</code> is a BY user list, an EXCEPT user list, or a BY USERS WITH GRANTED ROLES role list. Valid settings are:</p> <ul style="list-style-type: none"> BY EXCEPT BY USERS WITH GRANTED ROLES 	BY
UNIFIED_AUDIT_POLICY_COMMENT	A string that describes the unified audit policy that will be created	NULL

15.14 Using Transparent Sensitive Data Protection Policies with Fine-Grained Auditing

The transparent sensitive data protection and fine-grained auditing procedures can combine the protections of these two features.

- [About Using TSDP Policies with Fine-Grained Auditing](#)
You can configure a Transparent Sensitive Data Protection policy for fine-grained auditing.
- [Fine-Grained Auditing Parameters That Are Used with TSDP Policies](#)
`DBMS_FGA.ADD_POLICY` settings can be used in the `POLICY_ENABLE_OPTIONS` parameter for the `DBMS_TSDP_PROTECT.ADD_POLICY` or `DBMS_TSDP_PROTECT.ALTER_POLICY` procedure.

15.14.1 About Using TSDP Policies with Fine-Grained Auditing

You can configure a Transparent Sensitive Data Protection policy for fine-grained auditing.

The `DBMS_TSDP_PROTECT.ADD_POLICY` and `DBMS_TSDP_PROTECT.ALTER_POLICY` procedures enable you to specify settings from the `DBMS_FGA.ADD_POLICY` procedure.

This feature works as follows:

1. You create a TSDP policy with the necessary fine-grained audit settings.
The TSDP policy uses parameter settings from the `DBMS_FGA.ADD_POLICY` procedure.
2. You associate the TSDP policy with the necessary sensitive types by using the `DBMS_TSDP_PROTECT.ASSOCIATE_POLICY` procedure.
3. You then enable TSDP protection by using any of the `DBMS_TSDP_PROTECT.ENABLE_PROTECTION_*` procedures.
4. You enable the TSDP policy. As part of the TSDP policy enablement process, Oracle Database internally creates a fine-grained audit policy that you specified in the `DBMS_TSDP_PROTECT.ADD_POLICY` procedure.

The name of the internal policy begins with `ORA$FGA_` followed by a random alpha-numeric string (for example, `ORA$FGA_6J6L3RSJSN2VAN0XF`). You can find this policy by querying the `POLICY_NAME` column of the `DBA_POLICIES` data dictionary view.

5. When users try to perform an action on the table that is being protected by the TSDP policies, then based on the policy configuration, a fine-grained audit record is generated in the `DBA_FGA_AUDIT_TRAIL` data dictionary view for this object access.
6. These protections remain in place until you disable the TSDP policy for this column. At that point, Oracle Database automatically drops the internal policy, because it is no longer needed. If you reenables the TSDP policy, then the internal policy is recreated.

Related Topics

- [Fine-Grained Auditing Parameters That Are Used with TSDP Policies](#)
`DBMS_FGA.ADD_POLICY` settings can be used in the `POLICY_ENABLE_OPTIONS` parameter for the `DBMS_TSDP_PROTECT.ADD_POLICY` or `DBMS_TSDP_PROTECT.ALTER_POLICY` procedure.

15.14.2 Fine-Grained Auditing Parameters That Are Used with TSDP Policies

`DBMS_FGA.ADD_POLICY` settings can be used in the `POLICY_ENABLE_OPTIONS` parameter for the `DBMS_TSDP_PROTECT.ADD_POLICY` or `DBMS_TSDP_PROTECT.ALTER_POLICY` procedure.

The following table describes these settings.

Table 15-3 Fine-Grained Audit Policy Settings Used for TSDP Policies

Parameter	Description	Default
<code>audit_condition</code>	Specifies a Boolean value to indicate a monitoring condition, using the following syntax: <i>operator value</i> For example: <code>< 1000</code>	NULL
<code>handler_schema</code>	Schema that contains the event handler. The default, NULL, enables the current schema to be used.	NULL

Table 15-3 (Cont.) Fine-Grained Audit Policy Settings Used for TSDP Policies

Parameter	Description	Default
handler_module	Function name of the event handler. Include the package name if necessary. This function is invoked only after the first row that matches the audit condition in the query is processed. If the procedure fails with an exception, then the user's SQL statement fails as well.	NULL
statement_types	You can specify one of the following statement types: INSERT, UPDATE, SELECT, or DELETE.	SELECT
audit_trail	If you have not yet migrated the database to full unified auditing, then use this setting to set the destination of the audit records: DB for the database or XML for XML records. This setting also specifies whether to populate the LSQTEXT and LSQBIND columns in the FGA_LOG\$ system table. If full unified auditing is enabled, then Oracle Database ignores this parameter and writes the audit records to the unified audit trail.	NULL
object_schema	The schema that corresponds to the sensitive column	Schema that contains the sensitive column
object_name	The table that contains the sensitive column	The object (table or view) that contains the sensitive column
policy_name	A system-generated name for the internal fine-grained audit policy	Internal fine-grained audit policy system-generated name
audit_column	The sensitive column	The sensitive column
audit_column_opts	Determines whether to audit all or specific columns	DBMS_FGA.ANY_COLUMN
enable	Enable status for the TSDP policy; can be either TRUE or FALSE	TRUE
policy_owner	User who invokes the DBMS_TSDP_PROTECT.ENABLE_PROTECTION_* procedure	Current user

15.15 Using Transparent Sensitive Data Protection Policies with TDE Column Encryption

The TSDP procedures and Transparent Data Encryption column encryption statements can combine the protections of these two features.

- [About Using TSDP Policies with TDE Column Encryption](#)
A TSDP policy can enable the encryption of columns that use Transparent Data Encryption.

- **TDE Column Encryption ENCRYPT Clause Settings Used with TSDP Policies**
The `CREATE TABLE` and `ALTER TABLE` statement `ENCRYPT` clause settings can be used in the `POLICY_ENABLE_OPTIONS` parameter for the `DBMS_TSDP_PROTECT.ADD_POLICY` or `DBMS_TSDP_PROTECT.ALTER_POLICY` procedure.

15.15.1 About Using TSDP Policies with TDE Column Encryption

A TSDP policy can enable the encryption of columns that use Transparent Data Encryption.

The `DBMS_TSDP_PROTECT.ADD_POLICY` and `DBMS_TSDP_PROTECT.ALTER_POLICY` procedures enable you to specify the `ENCRYPT` clause settings from the `CREATE TABLE` or `ALTER TABLE` statement.

This feature works as follows:

1. You can create a TSDP policy by using the `DBMS_TSDP_PROTECT.ADD_POLICY` procedure. In the `ADD_POLICY` procedure, you can configure the policy for column encryption by setting the `SECURITY_FEATURE` parameter to `DBMS_TSDP_PROTECT.COLUMN_ENCRYPTION`. This setting enables encryption on the sensitive column when the TSDP policy is enabled on the object.
2. You create a TSDP policy with the necessary table encryption settings.
The TSDP policy uses TDE column encryption `ENCRYPT` clause parameter settings from the `CREATE TABLE` or `ALTER TABLE SQL` statement.
3. You associate the TSDP policy with the necessary sensitive types by using the `DBMS_TSDP_PROTECT.ASSOCIATE_POLICY` procedure.
4. You then enable TSDP protection by using any of the `DBMS_TSDP_PROTECT.ENABLE_PROTECTION_*` procedures.
5. You enable the TSDP policy. At this point, Oracle Database creates an internal TSDP policy that uses the encrypted table settings that you created earlier in this procedure.
The name of the internal policy begins with `ORA$TDECE_` followed by a random alphanumeric string (for example, `ORA#TDECE_6J6L3RSJSN2VAN0XF`). You can find this policy by querying the `TSDP_POLICY` column of `DBA_TSDP_POLICY_PROTECTION` view.
6. When users try to perform an action on the table that is being protected by the policies, the output for the column is based on both the TDE column protections and the TSDP policy that are now in place. You can check if the column has been encrypted after you enabled the TSDP policy by querying the `ENCRYPTION_ALG` column of the `DBA_ENCRYPTED_COLUMNS` view.
7. These protections remain in place until you disable the TSDP policy for this column. At that point, Oracle Database internally issues an `ALTER TABLE` statement on the table that contains the sensitive column, so that the sensitive column is decrypted. If you reenables the TSDP policy, then TSDP internally executes the `ALTER TABLE` statement with the `ENCRYPT` clause for the column.

Note:

It is possible to create two policies on the same column with each policy specifying a different encryption algorithm. In this case, the stronger of the two algorithms is enforced on the sensitive column.

Related Topics

- [TDE Column Encryption ENCRYPT Clause Settings Used with TSDP Policies](#)
The `CREATE TABLE` and `ALTER TABLE` statement `ENCRYPT` clause settings can be used in the `POLICY_ENABLE_OPTIONS` parameter for the `DBMS_TSDP_PROTECT.ADD_POLICY` or `DBMS_TSDP_PROTECT.ALTER_POLICY` procedure.

15.15.2 TDE Column Encryption ENCRYPT Clause Settings Used with TSDP Policies

The `CREATE TABLE` and `ALTER TABLE` statement `ENCRYPT` clause settings can be used in the `POLICY_ENABLE_OPTIONS` parameter for the `DBMS_TSDP_PROTECT.ADD_POLICY` or `DBMS_TSDP_PROTECT.ALTER_POLICY` procedure.

The following table describes these settings.

Table 15-4 TDE Column Encryption ENCRYPT Settings Used for TSDP Policies

Parameter	Description	Default
<code>encrypt_algorithm</code>	Available values <ul style="list-style-type: none"> • 3DES168 • AES128 • AES192 • AES256 (default if none specified) • ARIA128 • ARIA192 • ARIA256 	AES256
<code>salt</code>	Available values: <ul style="list-style-type: none"> • SALT • NO SALT 	SALT
<code>integrity_algorithm</code>	Available values: <ul style="list-style-type: none"> • SHA-1 • NOMAC 	SHA-1

 **Note:**

Starting with Oracle Database 23ai, the Transparent Data Encryption (TDE) decryption libraries for the GOST and SEED algorithms are deprecated, and encryption to GOST and SEED are desupported. Starting with Oracle Database 23ai, the Transparent Data Encryption (TDE) encryption libraries for the GOST and SEED algorithms are desupported and removed. The GOST and SEED decryption libraries are deprecated. Both are removed on HP Itanium platforms.

GOST 28147-89 has been deprecated by the Russian government, and SEED has been deprecated by the South Korean government. If you need South Korean government-approved TDE cryptography, then use ARIA instead. If you are using GOST 28147-89, then you must decrypt and encrypt with another supported TDE algorithm. The decryption algorithms for GOST 28147-89 and SEED are included with Oracle Database 23ai, but are deprecated, and the GOST encryption algorithm is desupported with Oracle Database 23ai. If you are using GOST or SEED for TDE encryption, then Oracle recommends that you perform an online rekey operation before upgrading to Oracle Database 23ai. However, with the exception of the HP Itanium platform, the GOST and SEED decryption libraries are available with Oracle Database 23ai, so you can also decrypt after upgrading.

15.16 Transparent Sensitive Data Protection Data Dictionary Views

Oracle Database provides data dictionary views that list information about transparent sensitive data protection policies.

[Table 15-5](#) describes these views. Before you can use these views, you must be granted the `SELECT_CATALOG_ROLE` role.

Table 15-5 Transparent Sensitive Data Protection Views

View	Description
<code>DBA_DISCOVERY_SOURCE</code>	Describes discovery import information with regard to transparent sensitive data protection policies
<code>DBA_SENSITIVE_COLUMN_TYPES</code>	Describes the sensitive column types that have been defined for the current database
<code>DBA_SENSITIVE_DATA</code>	Describes the sensitive columns in the database
<code>DBA_TSDP_IMPORT_ERRORS</code>	Shows information regarding the errors encountered during import of discovery result. It shows information with regard to the error code, schema name, table name, column name, and sensitive type.
<code>DBA_TSDP_POLICY_CONDITION</code>	Describes the transparent sensitive data protection policy and condition mapping. This view also lists the property-value pairs for the condition.
<code>DBA_TSDP_POLICY_FEATURE</code>	Shows the transparent sensitive data protection policy security feature mapping. (At this time, only Oracle Data Redaction and Oracle Virtual Private Database are supported.)
<code>DBA_TSDP_POLICY_PARAMETER</code>	Describes the parameters of transparent sensitive data protection policies

Table 15-5 (Cont.) Transparent Sensitive Data Protection Views

View	Description
DBA_TSDP_POLICY_PROTECTION	Shows the list of columns that have been protected through transparent sensitive data protection
DBA_TSDP_POLICY_TYPE	Shows the policy to sensitive column type mapping

Related Topics

- *Oracle Database Reference*

16

Encryption of Sensitive Credential Data in the Data Dictionary

You can encrypt sensitive credential information, such as passwords that are stored in the data dictionary.

- [About Encrypting Sensitive Credential Data in the Data Dictionary](#)
The data dictionary `SYS.LINK$` and `SYS.SCHEDULER$_CREDENTIAL` system tables store sensitive credential data, such as user passwords.
- [How the Multitenant Option Affects the Encryption of Sensitive Data](#)
You can encrypt sensitive data dictionary information from the application root, as well as within individual pluggable databases (PDBs).
- [Encrypting Sensitive Credential Data in System Tables](#)
The `ALTER DATABASE DICTIONARY` statement can encrypt sensitive credential data in the `SYS.LINK$` and `SYS.SCHEDULER$_CREDENTIAL` system tables.
- [Rekeying Sensitive Credential Data in the SYS.LINK\\$ System Table](#)
You can use the `ALTER DATABASE DICTIONARY` statement to rekey sensitive credential data in the data dictionary `SYS.LINK$` and `SYS.SCHEDULER$_CREDENTIAL` system tables.
- [Deleting Sensitive Credential Data in System Tables](#)
The `ALTER DATABASE DICTIONARY` statement can invalidate existing credentials in `SYS.LINK$` and `SYS.SCHEDULER$_CREDENTIAL` and obfuscate future credential entries to those tables.
- [Restoring the Functioning of Database Links After a Lost Keystore](#)
Database links can be adversely affected if the TDE keystore and its master encryption key is inadvertently lost.
- [Data Dictionary Views for Encrypted Data Dictionary Credentials](#)
Oracle Database provides a set of data dictionary views that provide information about the encryption of sensitive credential data in the data dictionary.

16.1 About Encrypting Sensitive Credential Data in the Data Dictionary

The data dictionary `SYS.LINK$` and `SYS.SCHEDULER$_CREDENTIAL` system tables store sensitive credential data, such as user passwords.

The `SYS.LINK$` table stores information about database links. `SYS.SCHEDULER$_CREDENTIAL` stores information about Oracle Scheduler events. By default, the sensitive credential data stored in these tables is obfuscated.

You can manually encrypt the data that is stored in the `SYS.LINK$` and `SYS.SCHEDULER$_CREDENTIAL` tables by using the `ALTER DATABASE DICTIONARY` statement. Though this feature makes use of Transparent Data Encryption (TDE), you do not need to have an Advanced Security Option license to perform the encryption, but you must have the `SYSKM` administrative privilege. TDE performs the encryption by using the AES256 (Advanced

Encryption Standard) algorithm. The encryption follows the same behavior as other data that is encrypted using TDE.

As a best security practice, Oracle recommends that you encrypt this sensitive credential data. To check the status the data dictionary credentials, you can query the `DICTIONARY_CREDENTIALS_ENCRYPT` data dictionary view.

16.2 How the Multitenant Option Affects the Encryption of Sensitive Data

You can encrypt sensitive data dictionary information from the application root, as well as within individual pluggable databases (PDBs).

When you encrypt, rekey, or decrypt sensitive credential data in the `SYS.LINK$` and `SYS.SCHEDULER$_CREDENTIAL` system tables, you must synchronize the affected PDBs after you complete the process. The instructions for doing so are in the procedures that cover these topics.

16.3 Encrypting Sensitive Credential Data in System Tables

The `ALTER DATABASE DICTIONARY` statement can encrypt sensitive credential data in the `SYS.LINK$` and `SYS.SCHEDULER$_CREDENTIAL` system tables.

The database must have an open keystore and an encryption key before you run the `ALTER DATABASE DICTIONARY` statement with the `ENCRYPT CREDENTIALS` clause to encrypt `SYS.LINK$` and `SYS.SCHEDULER$_CREDENTIAL`. The credential data encryption process de-obfuscates the obfuscated passwords and then encrypts them. The encryption applies to any future password changes that users may make after you complete this process.

1. Connect to either the application root or to a pluggable database (PDB) as a user who has been granted the `SYSKM` administrative privilege.

For example:

```
CONNECT hr_admin@pdb_name AS SYSKM
Enter password: password
```

To find the available PDBs in a CDB, log in to the CDB root container and then query the `PDB_NAME` column of the `DBA_PDBS` data dictionary view. To check the current container, run the `show con_name` command.

2. If necessary, create and open a keystore and then set an encryption key.

You can query the `V$ENCRYPTION_WALLET` dynamic view to find the status of a keystore.

Use the `ADMINISTER KEY MANAGEMENT` statement to perform these three tasks. For example:

```
ADMINISTER KEY MANAGEMENT CREATE KEYSTORE '/etc/ORACLE/WALLETS/orcl' IDENTIFIED BY
password;
ADMINISTER KEY MANAGEMENT SET KEYSTORE OPEN IDENTIFIED BY "password";
ADMINISTER KEY MANAGEMENT SET ENCRYPTION KEY IDENTIFIED BY "password" WITH BACKUP;
```

Include the `CONTAINER = ALL` clause if you are in the application root. This applies the keystore operation for PDBs that are in united mode. For PDBs that are in isolated mode, run the statement from within the PDB.

3. Run the `ALTER DATABASE DICTIONARY` statement to encrypt the data.

For example:

```
ALTER DATABASE DICTIONARY ENCRYPT CREDENTIALS;
```

In an application root, to apply the encryption to the associated PDBs, include the `CONTAINER = ALL` clause.

```
ALTER DATABASE DICTIONARY ENCRYPT CREDENTIALS CONTAINER = ALL;
```

4. If you performed the encryption from the application root, then synchronize the associated PDBs.

```
ALTER PLUGGABLE DATABASE APPLICATION APP$CDB$SYSTEM SYNC;
```

16.4 Rekeying Sensitive Credential Data in the SYS.LINK\$ System Table

You can use the `ALTER DATABASE DICTIONARY` statement to rekey sensitive credential data in the data dictionary `SYS.LINK$` and `SYS.SCHEDULER$_CREDENTIAL` system tables.

To rekey this sensitive credential data, you must run the `ALTER DATABASE DICTIONARY` statement with the `REKEY CREDENTIALS` clause. The rekey operation, which uses column encryption, does not affect other TDE master encryption keys.

1. Connect to either the application root or to a pluggable database (PDB) as a user who has been granted the `SYSKM` administrative privilege.

For example, to connect to a PDB:

```
CONNECT hr_admin@pdb_name AS SYSKM
Enter password: password
```

2. If necessary, create and open a keystore and then set an encryption key.

You can query the `V$ENCRYPTION_WALLET` dynamic view to find the status of a keystore.

Use the `ADMINISTER KEY MANAGEMENT` statement to perform these three tasks. For example:

```
ADMINISTER KEY MANAGEMENT CREATE KEYSTORE '/etc/ORACLE/WALLETS/orcl' IDENTIFIED BY
password;
ADMINISTER KEY MANAGEMENT SET KEYSTORE OPEN IDENTIFIED BY "password";
ADMINISTER KEY MANAGEMENT SET ENCRYPTION KEY IDENTIFIED BY "password" WITH BACKUP;
```

Include the `CONTAINER = ALL` clause if you are in the application root.

3. Run the `ALTER DATABASE DICTIONARY` statement to rekey the data.

For example:

```
ALTER DATABASE DICTIONARY REKEY CREDENTIALS;
```

In an application root, to apply the encryption to the associated PDBs, include the `CONTAINER = ALL` clause.

```
ALTER DATABASE DICTIONARY REKEY CREDENTIALS CONTAINER = ALL;
```

4. If you performed the rekey operation from the application root, then synchronize the associated PDBs.

```
ALTER PLUGGABLE DATABASE APPLICATION APP$CDB$SYSTEM SYNC;
```

16.5 Deleting Sensitive Credential Data in System Tables

The `ALTER DATABASE DICTIONARY` statement can invalidate existing credentials in `SYS.LINK$` and `SYS.SCHEDULER$_CREDENTIAL` and obfuscate future credential entries to those tables.

To delete this credential data, you must run the `ALTER DATABASE DICTIONARY` statement with the `DELETE CREDENTIALS` clause. This statement is mainly used in cases where you must recover the database link from the loss of a Transparent Data Encryption (TDE) keystore.

1. Connect to either the application root or a pluggable database (PDB) as a user who has been granted the `SYSKM` administrative privilege.

For example:

```
CONNECT hr_admin@pdb_name AS SYSKM
Enter password: password
```

2. If necessary, create and open a keystore and then set an encryption key.

You can query the `V$ENCRYPTION_WALLET` dynamic view to find the status of a keystore.

Use the `ADMINISTER KEY MANAGEMENT` statement to perform these three tasks. For example:

```
ADMINISTER KEY MANAGEMENT CREATE KEYSTORE '/etc/ORACLE/WALLETS/orcl' IDENTIFIED BY
password;
ADMINISTER KEY MANAGEMENT SET KEYSTORE OPEN IDENTIFIED BY "password";
ADMINISTER KEY MANAGEMENT SET ENCRYPTION KEY IDENTIFIED BY "password" WITH BACKUP;
```

Include the `CONTAINER = ALL` clause if you are in the application root.

3. Run the `ALTER DATABASE DICTIONARY` statement to delete the password credential.

For example:

```
ALTER DATABASE DICTIONARY DELETE CREDENTIALS KEY;
```

In an application root, to delete the `SYS.LINK$` and `SYS.SCHEDULER$_CREDENTIAL` password credentials in the associated PDBs, include the `CONTAINER = ALL` clause.

```
ALTER DATABASE DICTIONARY DELETE CREDENTIALS CONTAINER = ALL;
```

4. If you performed the credential deletion from the application root, then synchronize the associated PDBs.

```
ALTER PLUGGABLE DATABASE APPLICATION APP$CDB$SYSTEM SYNC;
```

Related Topics

- [Restoring the Functioning of Database Links After a Lost Keystore](#)
Database links can be adversely affected if the TDE keystore and its master encryption key is inadvertently lost.

16.6 Restoring the Functioning of Database Links After a Lost Keystore

Database links can be adversely affected if the TDE keystore and its master encryption key is inadvertently lost.

When a TDE keystore and master encryption key are lost, existing database links that are authenticated with encrypted passwords become unusable.

1. Connect to either the application root or a pluggable database (PDB) as a user who has been granted the `SYSKM` administrative privilege and who has the `ALTER DATABASE LINK` system privilege.

For example:

```
CONNECT hr_admin@pdb_name AS SYSKM
Enter password: password
```

2. Delete the encrypted credentials from the `SYS.LINK$` system table.

```
ALTER DATABASE DICTIONARY DELETE CREDENTIALS KEY;
```

If you are performing the deletion from the application root, then include the `CONTAINER = ALL` clause.

```
ALTER DATABASE DICTIONARY DELETE CREDENTIALS CONTAINER = ALL;
```

3. Create and open a keystore and then set an encryption key.

For example:

```
ADMINISTER KEY MANAGEMENT CREATE KEYSTORE '/etc/ORACLE/WALLETS/orcl' IDENTIFIED BY
password;
ADMINISTER KEY MANAGEMENT SET KEYSTORE OPEN IDENTIFIED BY "password";
ADMINISTER KEY MANAGEMENT SET ENCRYPTION KEY IDENTIFIED BY "password" WITH BACKUP;
```

Include the `CONTAINER = ALL` clause if you are in the application root.

4. Encrypt the password credentials in `SYS.LINK$` and `SYS.SCHEDULER$_CREDENTIAL`.

```
ALTER DATABASE DICTIONARY ENCRYPT CREDENTIALS;
```

If you are performing the encryption from the application root, then include the `CONTAINER = ALL` clause.

```
ALTER DATABASE DICTIONARY ENCRYPT CREDENTIALS CONTAINER = ALL;
```

5. Using the password of the user who is associated with the database link, reset the database link passwords that were affected by the `ALTER DATABASE DICTIONARY DELETE CREDENTIALS KEY` statement.

For example:

```
ALTER DATABASE LINK database_link_name CONNECT TO user_id IDENTIFIED BY password
CONTAINER = ALL;
```

To find existing database links and their owners, query the `DBA_DB_LINKS` data dictionary view.

6. If you performed the credential deletion from the application root, then synchronize the associated PDBs.

```
ALTER PLUGGABLE DATABASE APPLICATION APP$CDB$SYSTEM SYNC;
```

16.7 Data Dictionary Views for Encrypted Data Dictionary Credentials

Oracle Database provides a set of data dictionary views that provide information about the encryption of sensitive credential data in the data dictionary.

[Table 16-1](#) lists the data dictionary views.

Table 16-1 Data Dictionary Views for Encrypted Data Dictionary Credentials

View	Description
ALL_DB_LINKS	Describes database links that are accessible to the current user. A value of YES in the VALID column indicates that the database link is usable.
DBA_DB_LINKS	Describes describes all database links in the database. A value of YES in the VALID column indicates that the database link is usable. (This view is available to administrative users only, such as SYS or users who have been granted the DBA role.)
DICTIONARY_CREDENTIALS_ENCRYPT	Describes the status of dictionary credentials. The ENFORCEMENT column lists ENABLED if the credentials are encrypted and DISABLED if the credentials are not encrypted.
USER_DB_LINKS	Describes the database links that are owned by the current user. A value of YES in the VALID column indicates that the database link is usable.

Related Topics

- [Oracle Database Reference](#)

17

Securing and Isolating Resources Using DbNest

You can secure and isolate instance-level and operating system resources by using dbNest.

- [About DbNest](#)
DbNest provides hierarchical, isolated run-time environments at the CDB and PDB level.
- [How DbNest Works](#)
DbNest achieves isolation and file system access controls using Linux namespaces.
- [Enabling DbNest](#)
When you enable dbNest, the CDB nest is created as a resource-only nest, and the CDB child PDBs are created as full nests.
- [Configuring File System Isolation for a Database Nest](#)
You can configure a file system to be mounted within or excluded from a nest.

17.1 About DbNest

DbNest provides hierarchical, isolated run-time environments at the CDB and PDB level.

These run-time environments provide file system isolation, process ID number space isolation, and secure computing for PDBs and CDBs. To protect the multitenant environment from security breaches, dbNest uses the latest Linux resource isolation, namespace, and control group features.

17.2 How DbNest Works

DbNest achieves isolation and file system access controls using Linux namespaces.

- [Purpose of DbNest](#)
DbNest isolates a database instance from other databases and applications running on the same host, and also isolates PDBs from each other and from the CDB.
- [Linux Namespaces](#)
A Linux namespace wraps a global system resource in an abstraction that makes it appear to processes within the namespace that they have their own isolated instance of the global resource.
- [DbNest Properties](#)
A nest is a runtime environment that Oracle Database creates for every CDB, PDB, or application container.
- [DbNest Architecture](#)
The dbNest library is integrated with Oracle Database binaries, forming a single virtual environment.
- [User Interface for DbNest](#)
By default, dbNest is disabled. You can enable and configure it using initialization parameters.

- [How Oracle Database Manages a Nest](#)
When the `DBNEST_ENABLE` initialization parameter is set to any value other than `NONE`, Oracle Database automatically creates, manages, and deletes nests. These operations are transparent to the user.

17.2.1 Purpose of DbNest

DbNest isolates a database instance from other databases and applications running on the same host, and also isolates PDBs from each other and from the CDB.

Sharing instance-level and operating system resources can lead to security and isolation constraints, especially in large-scale cloud deployments. Vulnerabilities can be external, such as compromised applications, unauthorized access of resources, and shared resources. An example of an internal vulnerability is a compromised Oracle process.

Ideally, a database instance protects all resources from unauthorized access from all methods. For database instance and PDB protection, the requirements are as follows:

- The database instance and its resources must not be accessed by the `oracle` operating system user or a high-privileged operating system user.
- Another database instance or application, whether in the same Oracle home or a different Oracle home, must not have access to the database instance.
- Processes from one PDB must not access resources belonging to either the CDB or another PDB.

DbNest is the Oracle solution for database instance and PDB protection. This infrastructure enables a database instance to run in a protected, virtualized environment.

The infrastructure is implemented as a Linux-specific package that provides hierarchical containers, called **nests**. A CDB resides within a single parent nest, while PDBs reside within the individual child nests created within the parent. Linux processes in a PDB nest have their own process ID (PID) number spaces and cannot access PIDs in other nests. Process isolation provides a last level of defense in a security breach if a malicious user compromises a process.

17.2.2 Linux Namespaces

A Linux namespace wraps a global system resource in an abstraction that makes it appear to processes within the namespace that they have their own isolated instance of the global resource.

Important types of namespaces are:

- **Process namespace**
A namespace has an independent set of process IDs. The first process initializes the namespace. Every process inside the namespace receives a process ID, starting with 1. Each process can only see the processes inside the namespace.
- **User ID namespace**
A user namespace maps user IDs between the namespace and the operating system. The `oracle` user can create a namespace without the need for system-wide root privileges. Configured properly, the `oracle` is effectively a root user inside this namespace, but this privilege is restricted to the namespace.
- **Mount namespace**

Mount namespaces control mount points. A mount point within a child namespace is not visible to its parent. However, any mount operations within the parent namespace are visible to the child.

Linux namespaces provide the operating system infrastructure for dbNest, enabling different nests to function as independent virtual environments.

17.2.3 DbNest Properties

A nest is a runtime environment that Oracle Database creates for every CDB, PDB, or application container.

Each nest corresponds to exactly one container. The nest hierarchy exactly mirrors the container hierarchy. Because a CDB can contain one or more PDBs, a parent CDB nest can have one or more child nests. Each child nest corresponds to the PDB that can be contained in the nest.

A **database nest instance** is the collection of all nests and metadata associated with a CDB. For example, assume that a parent nest contains a CDB, and each of its 99 PDBs is in a separate child nest. In this case, the database nest instance for this CDB contains 100 nests. A database nest instance can contain a maximum of 4000 nests. If a host contains x number of CDBs, then $4000x$ nests are supported on this host, up to a maximum of 8142.

A nest has the following properties:

- Operating system isolation

A nest isolates operating system resources such as the process ID, user, and mount by providing a virtualized environment in which an application runs. The hierarchical structure provides visibility for the parent nest to access the child nests. A process belonging to one PDB is not visible to other PDBs or the CDB root.

- File system isolation

Within a nest, you can control the visibility for file system entities, so that critical or unrelated entities are hidden from other nests. For example, within `hrpdb`, you might make only the following file system entities visible within the nest: `/lib`, `$ORACLE_HOME/lib`, the data file path, the trace file path, and the ETL staging area. The shell, device files, and mount configuration are not accessible to PDBs in other nests.

A **pivot root** in Linux namespaces is equivalent to `chroot`: an operation that changes what the current running process sees as the root directory. A **bind mount** enables the contents of one directory to be accessible in a different directory. The two directories are independent. Using bind mounts, the same files can be located in multiple `chroot` environments without copying the contents.

- Resource management

You can control and monitor the resources of a nest, including CPU and memory. The resources available for a nest are based on the availability of the same resources from parent nest.

- Secure computing mode (`seccomp`)

DbNest uses `seccomp` to filter out system calls that could be unnecessary or malicious. Internally, `seccomp` uses Berkeley Packet Filters (BPF).

When you enable dbNest, the CDB is created as a resource-only (or partial) nest. Each PDB within the CDB is created as a full nest, which includes both isolation and resource management.

17.2.4 DbNest Architecture

The dbNest library is integrated with Oracle Database binaries, forming a single virtual environment.

The dbNest interface layer manages the Linux namespaces, resources, file system, and so on. This interface layer interacts with the CDB, which maintains a table that maps PDBs to nests.

The following figure illustrates the basic architecture of dbNest for a CDB that contains two PDBs.

Figure 17-1 Architecture of a CDB Nest

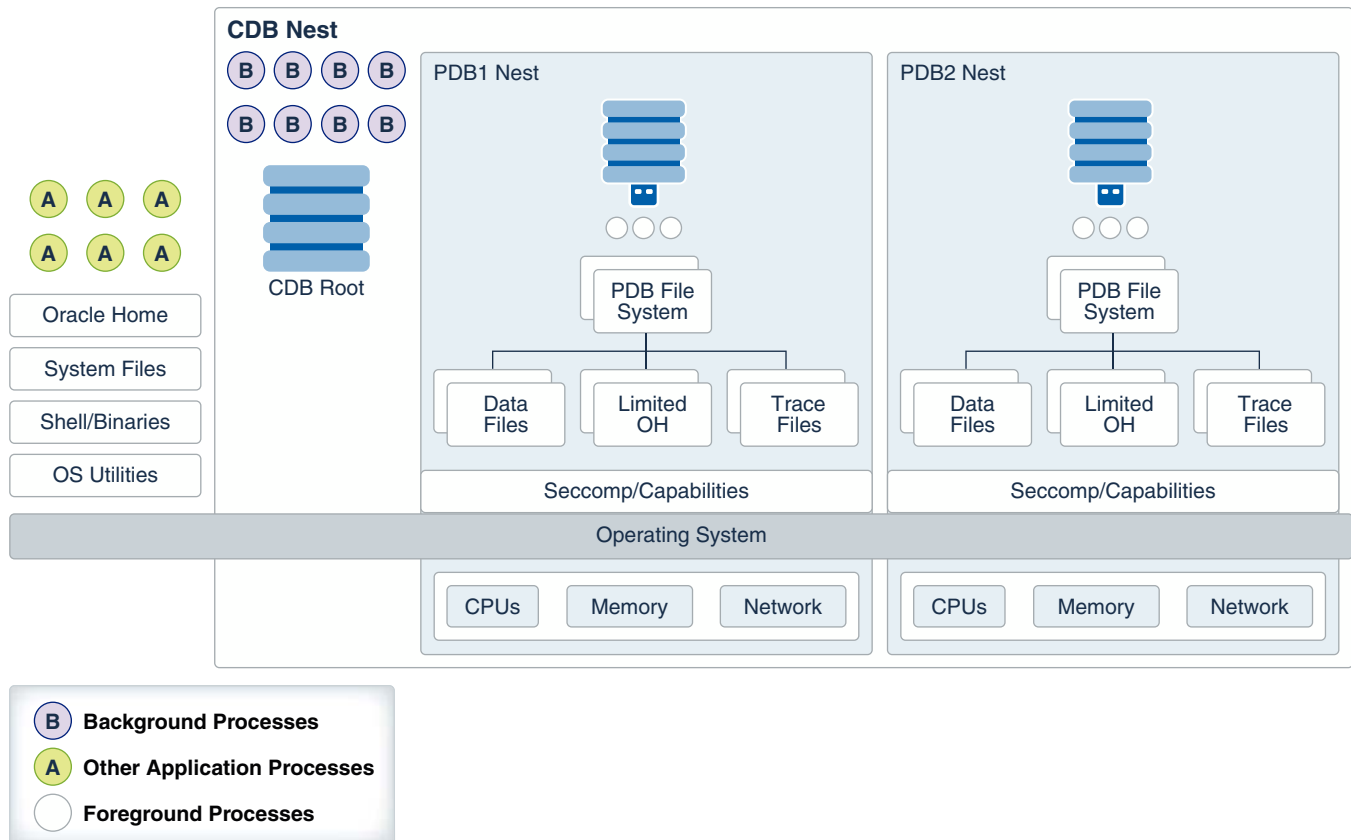

The graphic shows one nest hierarchy. The parent nest contains the CDB root, including the database background processes. If Oracle Automatic Storage Management (Oracle ASM) is used for storage, then the storage security model is provided by Oracle ASM.

The parent nest has two child nests: one containing PDB1 and its foreground processes, and one containing PDB2 and its foreground processes. Each PDB only has access to the relevant file system, trace files, and Oracle home files within its own nest. Each nest manages its own CPU, memory, and network resources.

In the preceding diagram, the CDB nest hierarchy has no access to operating system processes and files. For example, PDB1 cannot access a Linux shell, system files, or application processes.

17.2.5 User Interface for DbNest

By default, dbNest is disabled. You can enable and configure it using initialization parameters.

- [DbNest Initialization Parameters](#)
You can manually enable and configure DbNest by using initialization parameters.
- [DbNest Configuration File](#)
The configuration file, which applies to the whole CDB, lists paths to be mounted inside the CDB. These paths are in addition to the default paths.

17.2.5.1 DbNest Initialization Parameters

You can manually enable and configure DbNest by using initialization parameters.

To set the following initialization parameters using the `ALTER SYSTEM` statement, the instance must have been started with a server parameter file, and you must set `SCOPE=SPFILE` in `ALTER SYSTEM`.

Table 17-1 Initialization Parameters for DbNest

Parameter	Description
DBNEST_ENABLE	Enables or disables dbNest. Set this parameter in the CDB root. DBNEST_ENABLE accepts the following values: <ul style="list-style-type: none"> • NONE Disables dbNest . This is the default value. • CDB_RESOURCE_PDB_ALL Enables full nest for PDBs and a resource-only nest for the CDB. To set this parameter, a dedicated broker must have been configured.
DBNEST_PDB_FS_CONF	Specifies the location of an optional file system configuration file. Set this parameter in the CDB root.

17.2.5.2 DbNest Configuration File

The configuration file, which applies to the whole CDB, lists paths to be mounted inside the CDB. These paths are in addition to the default paths.

Syntax for the Configuration File

Whitelisting is the default option for file system configuration. If a configuration file is specified, then the list of directory paths is mounted inside the nest along with default paths. A path specification has the following syntax:

```
source [destination [options]]
```

The first two placeholders are defined as follows:

- *source*
Specifies the source directory in which to mount. If you specify the source as `dev`, then the file system mounts a special directory that contains only the following files: `zero`, `random`, `urandom`, `shm`. The file `shm` can be mounted if required.
- *destination*

Specifies an optional destination directory. If no directory is specified, then the database uses *source* as the destination.

 **Note:**

Both *source* and *destination* can be environment variables.

- *options*

Options require *destination* to be set. Options can be any of the following:

- *ro* specifies read-only mount.
- *nosetuid* specifies no *setuid* execution through files in this directory.
- *noexec* specifies no execution of any binaries in this directory.
- *optional* specifies that this directory will be mounted only if the source is available.

Tokens for the Source and Destination Directories

The source and destination can have tokens in the form `$TOKEN` or `${TOKEN}`. You can provide the token either as an environment variable or through options in the dbNest library call. The library call uses the format `name[array], value[array]`. A user-provided name-value pair takes precedence.

DbNest supports the following tokens:

- `$PDB`
- `$PDBID` (the container ID shown in `V$PDBS.CON_ID`)
- `$ORACLE_HOME`
- `$ORACLE_BASE`
- `$ORACLE_BASE_HOME`
- `$ORACLE_BASE_CONFIG`

Directives in the Configuration File

By default, a configuration file is an allowlist. If `DBNEST_NO_DEFAULT` is the first line in the configuration file, then the database ignores internal default paths. The following configuration file allowlists `/home/oracle/MYCDB/$PDB` and ignores internal default paths:

```
DBNEST_NO_DEFAULT
/home/oracle/MYCDB/$PDB
```

If `DBNEST_NO_FS_ROOT_MODE` is specified, then the directories following this line are blocked, creating a blocklist. DbNest assumes that any specified directories exist. Assume that the directories `/usr/local/bin` and `/bin/usr/bin` exist. The following configuration file blocklists these directories:

```
DBNEST_NO_FS_ROOT_MODE
/usr/local/bin
/bin/usr/bin
```

**Note:**

Do *not* place `$ORACLE_HOME/bin` on the blocklist because this directory is necessary for the `oracle` binary to be spawned.

17.2.6 How Oracle Database Manages a Nest

When the `DBNEST_ENABLE` initialization parameter is set to any value other than `NONE`, Oracle Database automatically creates, manages, and deletes nests. These operations are transparent to the user.

Specifically, Oracle Database performs the following operations:

- **Creating a nest**

At instance startup, Oracle Database creates a parent nest for the CDB root, and one child nest for each mounted PDB. Also, a `CREATE PLUGGABLE DATABASE` command automatically triggers the creation of a child nest for the created PDB.
- **Opening a nest**

When you first log in to a PDB, the CDB opens the child nest for the PDB. Logging in to the CDB root and opening a PDB also opens the child nest for this PDB.
- **Updating a nest**

Resources such as CPU count may change while the CDB is running. In this case, Resource Manager updates the nest configuration automatically.
- **Closing a nest**

The CDB closes a PDB child nest when you close a PDB by using the connection either inside the PDB or from the CDB root. A background processes closes the nest.
- **Deleting a nest**

The CDB removes a PDB child nest when the PDB is deleted or unplugged. When the database instance is shut down, the CDB parent nest is removed.

17.3 Enabling DbNest

When you enable `dbNest`, the CDB nest is created as a resource-only nest, and the CDB child PDBs are created as full nests.

1. Ensure that the CDB and its PDBs are registered with a local listener.

This listener must be configured to route all connections through a dedicated broker. When a client connects to the database, the listener hands the connection off to the broker, which then passes the client connection to a dedicated server process. Unlike the listener, the broker is part of the database instance. The CDB and PDB services should be registered with the listener to redirect the connection to the broker.

The `listener.ora` file must the following setting:

```
dedicated_through_broker_listenername=on
```

2. Connect to the CDB root as a user who has administrative privileges.

For example:

```
CONNECT c##sec_admin
Enter password: password
```

3. Ensure that the `USE_DEDICATED_BROKER` initialization parameter is set to `TRUE`.

```
SHOW PARAMETER DEDICATED_BROKER
```

The following output should appear:

NAME	TYPE	VALUE
use_dedicated_broker	boolean	TRUE

4. Set the `DBNEST_ENABLE` initialization parameter to `CDB_RESOURCE_PDB_ALL` and the scope to `SPFILE`:

```
ALTER SYSTEM SET DBNEST_ENABLE=CDB_RESOURCE_PDB_ALL SCOPE=SPFILE;
```

5. Restart the CDB so that the server parameter file will use the setting from the `ALTER SYSTEM SET DBNEST_ENABLE` statement.

```
SHUTDOWN IMMEDIATE
STARTUP
```

The CDB instance and all PDBs show now be running within a database nest.

6. Optionally, check the alert log to ensure that the dbNest was correctly configured. Search for `nest` or `DB Nest`. A line similar to the following appears:

```
Instance running inside DB Nest (dbNest_name)
```

17.4 Configuring File System Isolation for a Database Nest

You can configure a file system to be mounted within or excluded from a nest.

By default, dbNest mounts necessary file systems. For security reasons, you may choose to hide and reveal selected sets of directories or mount points from other nests. The following procedure assumes that the CDB and its PDBs are in a single nest. Before you can perform this procedure, a nest must be currently enabled for the CDB or PDB.

1. On the Linux host, create a text file named `nest_blocklist.txt` (or any arbitrary file name) with the following contents:

```
DBNEST_NO_FS_ROOT_MODE
list_of_file_systems_to_exclude
```

For example, if you want to exclude the `/bin` and `/usr/bin`:

```
DBNEST_NO_FS_ROOT_MODE
/bin
/usr/bin
```

2. Check the alert log for the CDB to ensure that it has been configured to use a nest.

Search for `nest` or `DB Nest`. A line similar to the following appears:

```
Instance running inside DB Nest (dbNest_name)
```

3. Connect to the CDB root as a user who has administrative privileges.

For example:

```
CONNECT c##sec_admin
Enter password: password
```

4. Set the `DBNEST_PDB_FS_CONF` initialization parameter to the name of the configuration file, and set the scope to `SPFILE`.

For example:

```
ALTER SYSTEM SET DBNEST_PDB_FS_CONF='/dsk1/nest_blocklist.txt'
SCOPE=SPFILE;
```

5. Restart the CDB so that the server parameter file will use the setting from the `ALTER SYSTEM SET DBNEST_PDB_FS_CONF` statement.

```
SHUTDOWN IMMEDIATE
STARTUP
```

On-Demand Encryption of Data

You can use the `DBMS_CRYPT` PL/SQL package to perform on-demand encryption of data.

- [About On-Demand Encryption of Data](#)
To perform on-demand encryption of data, you use the `DBMS_CRYPT` PL/SQL package.
- [Security Problems That Encryption Does Not Solve](#)
While there are many good reasons to encrypt data, there are many reasons not to encrypt data.
- [Data Encryption Challenges](#)
In cases where encryption can provide additional security, there are some associated technical challenges.
- [Data Encryption Storage with the `DBMS_CRYPT` Package](#)
The `DBMS_CRYPT` package enables you to perform on-demand encryption and decryption of stored data.
- [Asymmetric Key Operations with the `DBMS_CRYPT` Package](#)
The `DBMS_CRYPT` package provides four functions that enable you to perform asymmetric key operations for encryption, decryption, signing, and verification.
- [Examples of Using the Data Encryption API](#)
Examples of using the data encryption API include using the `DBMS_CRYPT.SQL` procedure, encrypting AES 256-bit data, and encrypting BLOB data.

18.1 About On-Demand Encryption of Data

To perform on-demand encryption of data, you use the `DBMS_CRYPT` PL/SQL package.

This package enables you to encrypt and decrypt stored data. You can use the `DBMS_CRYPT` functions and procedures with PL/SQL programs that run network communications. This package supports industry-standard encryption and hashing algorithms, including the Advanced Encryption Standard (AES) encryption algorithm. AES has been approved by the National Institute of Standards and Technology (NIST) to replace the Data Encryption Standard (DES).

In most cases, you should use TDE to encrypt data. If you want to encrypt data at rest, then you should use TDE.

There are several use cases for the manual encryption of data, using the `DBMS_CRYPT` PL/SQL package:

- Manual encryption enables you to encrypt data at the point of data collection, and then keep this data encrypted in all other layers in the database.
- Manual encryption is useful in cases where your database may retrieve information that had already been encrypted in another source outside the database. The `DBMS_CRYPT` can use the encryption key to decrypt the data and then present it in an unencrypted format.
- Manual encryption is also useful for scenarios in which you must hash passwords, protect extremely sensitive data, and use data signatures.

Disadvantages to performing on-demand encryption of data include the following:

- Indexes will be irrelevant or can have performance issues.
- Decrypting each row can result in a performance overhead.

Related Topics

- *Oracle Database PL/SQL Packages and Types Reference*

18.2 Security Problems That Encryption Does Not Solve

While there are many good reasons to encrypt data, there are many reasons not to encrypt data.

- [Principle 1: Encryption Does Not Solve Access Control Problems](#)
When you encrypt data, you should be aware that encryption must not interfere with how you configure access control.
- [Principle 2: Encryption Does Not Protect Against a Malicious Administrator](#)
You can protect your databases against malicious database administrators by using other Oracle features, such as Oracle Database Vault.
- [Principle 3: Encrypting Everything Does Not Make Data Secure](#)
A common error is to think that if encrypting some data strengthens security, then encrypting everything makes all data secure.

18.2.1 Principle 1: Encryption Does Not Solve Access Control Problems

When you encrypt data, you should be aware that encryption must not interfere with how you configure access control.

Most organizations must limit data access to users who need to see this data. For example, a human resources system may limit employees to viewing only their own employment records, while allowing managers of employees to see the employment records of subordinates. Human resource specialists may also need to see employee records for multiple employees.

Typically, you can use access control mechanisms to address security policies that limit data access to those with a need to see it. Oracle Database has provided strong, independently evaluated access control mechanisms for many years. It enables access control enforcement to a fine level of granularity through Virtual Private Database.

Because human resource records are considered sensitive information, it is tempting to think that all information should be encrypted for better security. However, encryption cannot enforce granular access control, and it may hinder data access. For example, an employee, the employee's manager, and a human resources clerk may all need to access an employee record. If all employee data is encrypted, then all three must be able to access the data in unencrypted form. Therefore, the employee, the manager and the human resources clerk would have to share the same encryption key to decrypt the data. Encryption would, therefore, not provide any additional security in the sense of better access control, and the encryption might hinder the proper or efficient functioning of the application. An additional issue is that it is difficult to securely transmit and share encryption keys among multiple users of a system.

A basic principle behind encrypting stored data is that it must not interfere with access control. For example, a user who has the `SELECT` privilege on `emp` should not be limited by the encryption mechanism from seeing all the data they are otherwise allowed to see. Similarly, there is little benefit to encrypting part of a table with one key and part of a table with another key if users need to see all encrypted data in the table. In this case, encryption adds to the overhead of decrypting the data before users can read it. If access controls are implemented well, then encryption adds little additional security within the database itself. A user who has

privileges to access data within the database has no more nor any less privileges as a result of encryption. Therefore, you should never use encryption to solve access control problems.

18.2.2 Principle 2: Encryption Does Not Protect Against a Malicious Administrator

You can protect your databases against malicious database administrators by using other Oracle features, such as Oracle Database Vault.

Some organizations, concerned that a malicious user might gain elevated (database administrator) privileges by guessing a password, like the idea of encrypting stored data to protect against this threat.

However, the correct solution to this problem is to protect the database administrator account, and to change default passwords for other privileged accounts. The easiest way to break into a database is by using a default password for a privileged account that an administrator allowed to remain unchanged. One example is `SYS/CHANGE_ON_INSTALL`.

While there are many destructive things a malicious user can do to a database after gaining the `DBA` privilege, encryption will not protect against many of them. Examples include corrupting or deleting data, exporting user data to the file system to email the data back to himself to run a password cracker on it, and so on.

Some organizations are concerned that database administrators, typically having all privileges, are able to see all data in the database. These organizations feel that the database administrators should administer the database, but should not be able to see the data that the database contains. Some organizations are also concerned about concentrating so much privilege in one person, and would prefer to partition the `DBA` function, or enforce two-person access rules.

It is tempting to think that encrypting all data (or significant amounts of data) will solve these problems, but there are better ways to protect against these threats. For example, Oracle Database supports limited partitioning of `DBA` privileges. Oracle Database provides native support for `SYSDBA` and `SYSOPER` users. `SYSDBA` has all privileges, but `SYSOPER` has a limited privilege set (such as startup and shutdown of the database).

Furthermore, you can create smaller roles encompassing several system privileges. A `jr_dba` role might not include all system privileges, but only those appropriate to a junior database administrator (such as `CREATE TABLE`, `CREATE USER`, and so on).

Oracle Database also enables auditing the actions taken by `SYS` (or `SYS`-privileged users) and storing that audit trail in a secure operating system location. Using this model, a separate auditor who has root privileges on the operating system can audit all actions by `SYS`, enabling the auditor to hold all database administrators accountable for their actions.

You can also fine-tune the access and control that database administrators have by using Oracle Database Vault.

The database administrator function is a trusted position. Even organizations with the most sensitive data, such as intelligence agencies, do not typically partition the database administrator function. Instead, they manage their database administrators strongly, because it is a position of trust. Periodic auditing can help to uncover inappropriate activities.

Encryption of stored data must not interfere with the administration of the database, because otherwise, larger security issues can result. For example, if by encrypting data you corrupt the data, then you create a security problem, the data itself cannot be interpreted, and it may not be recoverable.

You can use encryption to limit the ability of a database administrator or other privileged user to see data in the database. However, it is not a substitute for managing the database administrator privileges properly, or for controlling the use of powerful system privileges. If untrustworthy users have significant privileges, then they can pose multiple threats to an organization, some of them far more significant than viewing unencrypted credit card numbers.

Related Topics

- *Oracle Database Vault Administrator's Guide*

18.2.3 Principle 3: Encrypting Everything Does Not Make Data Secure

A common error is to think that if encrypting some data strengthens security, then encrypting everything makes all data secure.

As the discussion of the previous two principles illustrates, encryption does not address access control issues well, and it is important that encryption not interfere with normal access controls. Furthermore, encrypting an entire production database means that all data must be decrypted to be read, updated, or deleted. Encryption is inherently a performance-intensive operation; encrypting all data will significantly affect performance.

Availability is a key aspect of security. If encrypting data makes data unavailable, or adversely affects availability by reducing performance, then encrypting everything will create a new security problem. Availability is also adversely affected by the database being inaccessible when encryption keys are changed, as good security practices require on a regular basis. When the keys are to be changed, the database is inaccessible while data is decrypted and reencrypted with a new key or keys.

18.3 Data Encryption Challenges

In cases where encryption can provide additional security, there are some associated technical challenges.

- [Encrypted Indexed Data](#)
Special difficulties arise when encrypted data is indexed.
- [Generated Encryption Keys](#)
Encrypted data is only as secure as the key used for encrypting it.
- [Transmitted Encryption Keys](#)
If the encryption key is to be passed by the application to the database, then you must encrypt it.
- [Storing Encryption Keys](#)
You can store encryption keys in the database or on an operating system.
- [Importance of Changing Encryption Keys](#)
Prudent security practice dictates that you periodically change encryption keys.
- [Encryption of Binary Large Objects](#)
Certain data types require more work to encrypt.

18.3.1 Encrypted Indexed Data

Special difficulties arise when encrypted data is indexed.

For example, suppose a company uses a national identity number, such as the U.S. Social Security number (SSN), as the employee number for its employees. The company considers employee numbers to be sensitive data, and, therefore, wants to encrypt data in the

`employee_number` column of the `employees` table. Because `employee_number` contains unique values, the database designers want to have an index on it for better performance.

However, if `DBMS_CRYPTO` (or another mechanism) is used to encrypt data in a column, then an index on that column will also contain encrypted values. Although an index can be used for equality checking (for example, `SELECT * FROM emp WHERE employee_number = '987654321'`), if the index on that column contains encrypted values, then the index is essentially unusable for any other purpose. You should not perform on-demand encryption of indexed data.

Oracle recommends that you do not use national identity numbers as unique IDs. Instead, use the `CREATE SEQUENCE` statement to generate unique identity numbers. Reasons to avoid using national identity numbers are as follows:

- There are privacy issues associated with overuse of national identity numbers (for example, identity theft).
- Sometimes national identity numbers can have duplicates, as with U.S. Social Security numbers.

18.3.2 Generated Encryption Keys

Encrypted data is only as secure as the key used for encrypting it.

An encryption key must be securely generated using secure cryptographic key generation. Oracle Database provides support for secure random number generation, with the `RANDOMBYTES` function of `DBMS_CRYPTO`. `DBMS_CRYPTO` calls the secure random number generator (RNG) previously certified by RSA Security.

Note:

Do not use the `DBMS_RANDOM` package. The `DBMS_RANDOM` package generates pseudo-random numbers, which, as Randomness Recommendations for Security (RFC-1750) states that using pseudo-random processes to generate secret quantities can result in pseudo-security.

Be sure to provide the correct number of bytes when you encrypt a key value. For example, you must provide a 16-byte key for the `ENCRYPT_AES128` encryption algorithm.

18.3.3 Transmitted Encryption Keys

If the encryption key is to be passed by the application to the database, then you must encrypt it.

Otherwise, an intruder could get access to the key as it is being transmitted. Network data encryption protects all data in transit from modification or interception, including cryptographic keys.

Related Topics

- [Configuring Oracle Database Native Network Encryption and Data Integrity](#)
You can configure native Oracle Net Services data encryption and data integrity for both servers and clients.

18.3.4 Storing Encryption Keys

You can store encryption keys in the database or on an operating system.

- [About Storing Encryption Keys](#)
Storing encryption keys is one of the most important, yet difficult, aspects of encryption.
- [Storage of Encryption Keys in the Database](#)
Storing encryption keys in the database does not always prevent a database administrator from accessing encrypted data.
- [Storage of Encryption Keys in the Operating System](#)
When you store encryption keys in an operating system flat file, you can make callouts from PL/SQL to retrieve these encryption keys.
- [Users Managing Their Own Encryption Keys](#)
Having the user supply the key assumes the user will be responsible with the key.
- [Manual Encryption with Transparent Database Encryption and Tablespace Encryption](#)
Transparent database encryption and tablespace encryption provide secure encryption with automatic key management for the encrypted tables and tablespaces.

18.3.4.1 About Storing Encryption Keys

Storing encryption keys is one of the most important, yet difficult, aspects of encryption.

To recover data encrypted with a symmetric key, the key must be accessible to an authorized application or user seeking to decrypt the data. At the same time, the key must be inaccessible to someone who is maliciously trying to access encrypted data that the malicious person is not supposed to see.

18.3.4.2 Storage of Encryption Keys in the Database

Storing encryption keys in the database does not always prevent a database administrator from accessing encrypted data.

An all-privileged database administrator could still access tables containing encryption keys. However, it can often provide good security against the casual curious user or against someone compromising the database file on the operating system.

As a trivial example, suppose you create a table (`EMP`) that contains employee data. You want to encrypt the employee Social Security number (SSN) stored in one of the columns. You could encrypt employee SSN using a key that is stored in a separate column. However, anyone with `SELECT` access on the entire table could retrieve the encryption key and decrypt the matching SSN.

While this encryption scheme seems easily defeated, with a little more effort you can create a solution that is much harder to break. For example, you could encrypt the SSN using a technique that performs some additional data transformation on the `employee_number` before using it to encrypt the SSN. This technique might be as simple as using an `XOR` operation on the `employee_number` and the birth date of the employee to determine the validity of the values.

As additional protection, PL/SQL source code performing encryption can be wrapped, (using the `WRAP` utility) which obfuscates (scrambles) the code. The `WRAP` utility processes an input SQL file and obfuscates the PL/SQL units in it. For example, the following command uses the `keymanage.sql` file as the input:

```
wrap iname=/mydir/keymanage.sql
```

A developer can subsequently have a function in the package call the `DBMS_CRYPTO` package calls with the key contained in the wrapped package.

Oracle Database enables you to obfuscate dynamically generated PL/SQL code. The `DBMS_DDL` package contains two subprograms that allow you to obfuscate dynamically generated PL/SQL program units. For example, the following block uses the `DBMS_DDL.CREATE_WRAPPED` procedure to wrap dynamically generated PL/SQL code.

```
BEGIN
.....
SYS.DBMS_DDL.CREATE_WRAPPED(function_returning_PLSQL_code());
.....
END;
```

While wrapping is not unbreakable, it makes it harder for an intruder to get access to the encryption key. Even in cases where a different key is supplied for each encrypted data value, you should not embed the key value within a package. Instead, wrap the package that performs the key management (that is, data transformation or padding).

An alternative to wrapping the data is to have a separate table in which to store the encryption key and to envelope the call to the keys table with a procedure. The key table can be joined to the data table using a primary key to foreign key relationship. For example, `employee_number` is the primary key in the `employees` table that stores employee information and the encrypted SSN. The `employee_number` column is a foreign key to the `ssn_keys` table that stores the encryption keys for the employee SSN. The key stored in the `ssn_keys` table can also be transformed before use (by using an `XOR` operation), so the key itself is not stored unencrypted. If you wrap the procedure, then that can hide the way in which the keys are transformed before use.

The strengths of this approach are:

- Users who have direct table access cannot see the sensitive data unencrypted, nor can they retrieve the keys to decrypt the data.
- Access to decrypted data can be controlled through a procedure that selects the encrypted data, retrieves the decryption key from the key table, and transforms it before it can be used to decrypt the data.
- The data transformation algorithm is hidden from casual snooping by wrapping the procedure, which obfuscates the procedure code.
- `SELECT` access to both the data table and the keys table does not guarantee that the user with this access can decrypt the data, because the key is transformed before use.

The weakness to this approach is that a user who has `SELECT` access to both the key table and the data table, and who can derive the key transformation algorithm, can break the encryption scheme.

The preceding approach is not infallible, but it is adequate to protect against easy retrieval of sensitive information stored in clear text.

Related Topics

- *Oracle Database PL/SQL Language Reference*

18.3.4.3 Storage of Encryption Keys in the Operating System

When you store encryption keys in an operating system flat file, you can make callouts from PL/SQL to retrieve these encryption keys.

However, if you store keys in the operating system and make callouts to it, then your data is only as secure as the protection on the operating system.

If your primary security concern is that the database can be broken into from the operating system, then storing the keys in the operating system makes it easier for an intruder to retrieve encrypted data than storing the keys in the database itself.

18.3.4.4 Users Managing Their Own Encryption Keys

Having the user supply the key assumes the user will be responsible with the key.

Considering that 40 percent of help desk calls are from users who have forgotten their passwords, you can see the risks of having users manage encryption keys. In all likelihood, users will either forget an encryption key, or write the key down, which then creates a security weakness. If a user forgets an encryption key or leaves the company, then your data is not recoverable.

If you do decide to have user-supplied or user-managed keys, then you need to ensure you are using native network encryption so that the key is not passed from the client to the server in the clear. You also must develop key archive mechanisms, which is also a difficult security problem. Key archives and backdoors create the security weaknesses that encryption is attempting to solve.

18.3.4.5 Manual Encryption with Transparent Database Encryption and Tablespace Encryption

Transparent database encryption and tablespace encryption provide secure encryption with automatic key management for the encrypted tables and tablespaces.

If the application requires protection of sensitive column data stored on the media, then these two types of encryption are a simple and fast way of achieving this.

Related Topics

- *Oracle Database Advanced Security Guide*

18.3.5 Importance of Changing Encryption Keys

Prudent security practice dictates that you periodically change encryption keys.

For stored data, this requires periodically unencrypting the data, and then reencrypting it with another well-chosen key.

You would most likely change the encryption key while the data is not being accessed, which creates another challenge. This is especially true for a Web-based application encrypting credit card numbers, because you do not want to shut down the entire application while you switch encryption keys.

18.3.6 Encryption of Binary Large Objects

Certain data types require more work to encrypt.

For example, Oracle Database supports storage of binary large objects (BLOBs), which stores very large objects (for example, multiple gigabytes) in the database. A BLOB can be either stored internally as a column, or stored in an external file.

Related Topics

- [Example: Encryption and Decryption Procedures for BLOB Data](#)
You can encrypt BLOB data.

18.4 Data Encryption Storage with the DBMS_CRYPT0 Package

The `DBMS_CRYPT0` package enables you to perform on-demand encryption and decryption of stored data.

While encryption is not the ideal solution for addressing several security threats, it is clear that selectively encrypting sensitive data before storage in the database does improve security. Examples of such data could include credit card numbers and national identity numbers.

The `DBMS_CRYPT0` package enables encryption and decryption for common Oracle Database data types, including `RAW` and large objects (LOBs), such as images and sound. Specifically, it supports BLOBs and CLOBs. In addition, it provides Globalization Support for encrypting data across different database character sets.

The following cryptographic algorithms are supported:

- AES, DES (deprecated), 3DES (deprecated), PBE_MD5DES (deprecated), 3DES_2KEY (deprecated), RC4 (deprecated), SM4
- Cryptographic hash algorithms MD5(deprecated), SHA1(deprecated), SHA2, SHA3, SM3, SHAKE
- Keyed hash (MAC) algorithms MD5 (deprecated), SHA1 (deprecated), SHA2, SHA3
- Public Key Encryption Algorithm RSA_PKCS1_OAEP, RSA_PKCS1_OAEP_SHA2, SM2
- Sign and verify algorithms SHA1-RSA, SHA2-RSA, SHA3-RSA, SHA2-ECDSA, SHA3-ECDSA, SM3-SM2

Block cipher modifiers are also provided with `DBMS_CRYPT0`. You can choose from several padding options, including Public Key Cryptographic Standard (PKCS) #5, and from four block cipher chaining modes, including Galois/Counter Mode (GCM). Padding must be done in multiples of eight bytes.

 **Note:**

- DES is no longer recommended by the National Institute of Standards and Technology (NIST).
- Usage of SHA-1 is more secure than MD5. (MD5 has been deprecated starting in Oracle Database 21c.)

Starting with Oracle Database 21c, older encryption and hashing algorithms are deprecated. Deprecated algorithms include MD4, MD5, DES, 3DES, and RC4-related algorithms. Removing older, less secure cryptography algorithms prevents accidental use of these APIs. To meet your security requirements, Oracle recommends that you use more modern cryptography algorithms such as AES.

Starting with Oracle Database 21c, older encryption and hashing algorithms are deprecated.

As a consequence of this deprecation, Oracle recommends that you review your network encryption configuration to see if you have specified use of any of the deprecated algorithms. If any are found, then switch to using a more modern cipher, such as AES. See [Configuring Oracle Database Native Network Encryption and Data Integrity](#) for more information.

- Usage of SHA-2 is more secure than SHA-1.
- Keyed MD5 is not vulnerable.

The following table summarizes the DBMS_CRYPT0 package features.

Table 18-1 DBMS_CRYPT0 Package Feature Summary

Feature	DBMS_CRYPT0 Supported Functionality
HASH	DBMS_CRYPT0 supported algorithms
HMAC	MD5 (deprecated), SHA1 (deprecated), SHA2, SHA3, SM3, SHAKE
KMACXOF	KMAC
ENCRYPT	AES, DES (deprecated), 3DES (deprecated), PBE_MD5DES (deprecated), 3DES_2KEY (deprecated), RC4 (deprecated), SM4
ENCRYPT algorithm chaining modifiers	CBC, CFB, ECB, OFB, GCM, CCM, XTS
ENCRYPT algorithm padding modifiers	PAD_PKCS5, PAD_NONE, PAD_ZERO, PAD_ORCL
Public key encryption	SHA-1, SHA-2, SM2
Public key types	RSA, ECDSA, SM2
Signature algorithms	SHA1-RSA, SHA2-RSA, SHA3-RSA, SHA2-ECDSA, SHA3-ECDSA, SM3-SM2

The following table shows supported hash functions.

Table 18-2 Hash Algorithms

Hash Algorithm	Description
HASH_MD5 (deprecated)	MD5 hash
HASH_SH1 (deprecated)	SHA-1 hash
HASH_SH256	256-bit SHA-2 hash
HASH_SH384	384-bit SHA-2 hash
HASH_SH512	512-bit SHA-2 hash
HASH_SHA3_224	224-bit SHA-3 hash
HASH_SM3	SM3 hash
HASH_SHA3_256	256-bit SHA-3 hash
HASH_SHA3_384	384-bit SHA-3 hash
HASH_SHA3_512	512-bit SHA-3 hash
HASH_SHAKE128	128-bit SHAKE hash
HASH_SHAKE256	256-bit SHAKE hash

The following table shows supported HMAC algorithms.

Table 18-3 HMAC Algorithms

Algorithm	Description
HMAC_MD5 (deprecated)	MD5 HMAC
HMAC_SH1 (deprecated)	SHA-1 HMAC
HMAC_SH256	256-bit SHA-2 HMAC
HMAC_SH384	384-bit SHA-2 HMAC
HMAC_SH512	512-bit SHA-2 HMAC
HMAC_SHA3_224	224-bit SHA-3 HMAC
HMAC_SHA3_256	256-bit SHA-3 HMAC
HMAC_SHA3_384	384-bit SHA-3 HMAC
HMAC_SHA3_512	512-bit SHA-3 HMAC

The following table shows KMACXOF algorithms.

Table 18-4 KMACXOF Algorithms

Algorithm	Description
KMACXOF_128	128-bit KMAC
KMACXOF_256	256-bit KMAC

The following table shows ENCRYPT algorithms.

Table 18-5 ENCRYPT Algorithms

Algorithm	Description
ENCRYPT_RC4 (deprecated)	RC4 encrypt
ENCRYPT_DES (deprecated)	DES encrypt
ENCRYPT_3DES_2KEY (deprecated)	3DES_2KEY encrypt
ENCRYPT_3DES (deprecated)	3DES encrypt
ENCRYPT_PBE_MD5DES (deprecated)	PBE_MD5DES encrypt
ENCRYPT_AES	AES encrypt
ENCRYPT_AES128	128-bit AES encrypt
ENCRYPT_AES192	192-bit AES encrypt
ENCRYPT_AES256	256-bit AES encrypt
ENCRYPT_SM4	SM4 Encrypt

The following table shows ENCRYPT algorithm chaining modifiers.

Table 18-6 ENCRYPT Algorithm Chaining Modifiers

Algorithm	Description
CHAIN_CBC	CBC Chain mode
CHAIN_CFB	CFB Chain mode
CHAIN_ECB	ECB Chain mode
CHAIN_OFB	OFB Chain mode
CHAIN_GCM	GCM Chain mode
CHAIN_CCM	CCM Chain mode
CHAIN_XTS	XTS Chain mode

The following table shows ENCRYPT algorithm padding modifiers.

Table 18-7 ENCRYPT Algorithm Padding Modifiers

ENCRYPT Algorithm Padding Modifier	Description
PAD_PKCS5	PKCS#5 padding
PAD_NONE	No padding
PAD_ZERO	Zero padding
PAD_ORCL	ORCL padding

The following table shows convenience constants for block ciphers.

Table 18-8 Convenience Constants for Block Ciphers

Convenience Constant for Block Ciphers	Description
DES_CBC_PKCS5 (deprecated)	DES Encrypt with CBC Chain mode and PKCS#5 padding
DES3_CBC_PKCS5 (deprecated)	3DES Encrypt with CBC Chain mode and PKCS#5 padding
AES_CBC_PKCS5	AES Encrypt with CBC Chain mode and PKCS#5 padding
AES_GCM_NONE	AES Encrypt with GCM Chain mode and no padding
AES_CCM_NONE	AES Encrypt with CCM Chain mode and no padding
AES_XTS_NONE	AES Encrypt with XTS Chain mode and no padding
SM4_CFB_NONE	SM4 Encrypt with CFB Chain mode and no padding
SM4_OFB_NONE	SM4 Encrypt with OFB Chain mode and no padding

The following table shows public key encryption algorithms.

Table 18-9 Public Key Encryption Algorithms

Public Key Encryption Algorithm	Description
PKENCRYPT_RSA_PKCS1_OAEP (deprecated)	RSA with OAEP
PKENCRYPT_RSA_PKCS1_OAEP_SHA2	RSA with SHA-2 and OAEP
PKENCRYPT_SM2	SM2 encrypt

The following table shows public key types.

Table 18-10 Public Key Types

Public Key Type	Description
KEY_TYPE_RSA	RSA key type
KEY_TYPE_ECDSA	ECDSA key type
KEY_TYPE_SM2	SM2 key type

The following table shows SIGN algorithms.

Table 18-11 Signature Algorithms

Algorithm	Description
SIGN_SHA224_RSA	224-bit SHA-2 hash function with RSA
SIGN_SHA256_RSA	256-bit SHA-2 hash function with RSA
SIGN_SHA256_RSA_X9	256-bit SHA-2 hash function with RSA and X931 padding

Table 18-11 (Cont.) Signature Algorithms

Algorithm	Description
SIGN_SHA384_RSA	384-bit SHA-2 hash function with RSA
SIGN_SHA384_RSA_X931	384-bit SHA-2 hash function with RSA and X931 padding
SIGN_SHA512_RSA	512-bit SHA-2 hash function with RSA
SIGN_SHA512_RSA_X931	512-bit SHA-2 hash function with RSA and X931 padding
SIGN_SHA1 (deprecated)	SHA-1 hash function with RSA
SIGN_SHA1_RSA_X931 (deprecated)	SHA-1 hash function with RSA and X931 padding
SIGN_SHA224_ECDSA	224-bit SHA-2 hash function with ECDSA
SIGN_SHA256_ECDSA	256-bit SHA-2 hash function with ECDSA
SIGN_SHA384_ECDSA	384-bit SHA-2 hash function with ECDSA
SIGN_SHA512_ECDSA	512-bit SHA-2 hash function with ECDSA
SIGN_ECDSA	Elliptic Curve Digital Signature Algorithm
SIGN_SM3_SM2	SM3 hash function with SM2 Signature Algorithm
SIGN_SHA3_224_RSA	224-bit SHA-3 hash function with RSA
SIGN_SHA3_256_RSA	256-bit SHA-3 hash function with RSA
SIGN_SHA3_384_RSA	384-bit SHA-3 hash function with RSA
SIGN_SHA3_512_RSA	512-bit SHA-3 hash function with RSA
SIGN_SHA3_224_ECDSA	224-bit SHA-3 hash function with ECDSA
SIGN_SHA3_256_ECDSA	256-bit SHA-3 hash function with ECDSA
SIGN_SHA3_384_ECDSA	384-bit SHA-3 hash function with ECDSA
SIGN_SHA3_512_ECDSA	512-bit SHA-3 hash function with ECDSA

DBMS_CRYPTO supports a range of algorithms that accommodate both new and existing systems. Although 3DES_2KEY and MD4 are provided for backward compatibility, you achieve better security using 3DES, AES, or SHA-1. Therefore, 3DES_2KEY is not recommended.

The DBMS_CRYPTO package includes cryptographic checksum capabilities (MD5), which are useful for comparisons, and the ability to generate a secure random number (the RANDOMBYTES function). Secure random number generation is an important part of cryptography; predictable keys are easily guessed keys; and easily guessed keys may lead to easy decryption of data. Most cryptanalysis is done by finding weak keys or poorly stored keys, rather than through brute force analysis (cycling through all possible keys).

**Note:**

Do not use `DBMS_RANDOM`, because it is unsuitable for cryptographic key generation.

Key management is programmatic. That is, the application (or caller of the function) must supply the encryption key. This means that the application developer must find a way of storing and retrieving keys securely. The relative strengths and weaknesses of various key management techniques are discussed in the sections that follow. The DES algorithm itself has an effective key length of 56-bits.

18.5 Asymmetric Key Operations with the DBMS_CRYPT0 Package

The `DBMS_CRYPT0` package provides four functions that enable you to perform asymmetric key operations for encryption, decryption, signing, and verification.

Asymmetric key operations (also called public key cryptography) use a public key and private key to encrypt and decrypt a message in order to protect it from unauthorized access.

The asymmetric key operation functions are as follows:

- `PKDECRYPT` decrypts `RAW` data using a private key assisted with key algorithm and encryption algorithm.
- `PKENCRYPT` encrypts `RAW` data using a public key assisted with key algorithm and encryption algorithm.
- `SIGN` signs `RAW` data using a private key assisted with key algorithm and sign algorithm
- `VERIFY` verifies `RAW` data using signature, public key assisted with key algorithm and sign algorithm.

Related Topics

- *Oracle Database PL/SQL Packages and Types Reference*

18.6 Examples of Using the Data Encryption API

Examples of using the data encryption API include using the `DBMS_CRYPT0.SQL` procedure, encrypting AES 256-bit data, and encrypting BLOB data.

- [Example: Data Encryption Procedure](#)
The `DBMS_CRYPT0.SQL` PL/SQL program can be used to encrypt data.
- [Example: AES 256-Bit Data Encryption and Decryption Procedures](#)
You can use a PL/SQL block to encrypt and decrypt a predefined variable.
- [Example: Encryption and Decryption Procedures for BLOB Data](#)
You can encrypt BLOB data.
- [Example: Encrypting or Decrypting a Number String](#)
You can use the `DBMS_CRYPT0` PL/SQL package to create functions that will perform the on-demand encryption or decryption of a number string.

18.6.1 Example: Data Encryption Procedure

The `DBMS_CRYPTO.SQL` PL/SQL program can be used to encrypt data.

This example code performs the following actions:

- Encrypts a string (`VARCHAR2` type) using DES after first converting it into the `RAW` data type. This step is necessary because encrypt and decrypt functions and procedures in `DBMS_CRYPTO` package work on the `RAW` data type only.
- Shows how to create a 160-bit hash using SHA-1 algorithm.
- Demonstrates how MAC, a key-dependent one-way hash, can be computed using the MD5 algorithm. (Starting in Oracle Database release 21c, the MD5 algorithm has been deprecated.)

The `DBMS_CRYPTO.SQL` procedure follows:

```

DECLARE
    input_string    VARCHAR2(16) := 'tigertigertigert';
    raw_input       RAW(128) :=
UTL_RAW.CAST_TO_RAW(CONVERT(input_string,'AL32UTF8','US7ASCII'));
    key_string      VARCHAR2(16) := 'scottscoscottscot';
    raw_key         RAW(128) :=
UTL_RAW.CAST_TO_RAW(CONVERT(key_string,'AL32UTF8','US7ASCII'));
    encrypted_raw   RAW(2048);
    encrypted_string VARCHAR2(2048);
    decrypted_raw   RAW(2048);
    decrypted_string VARCHAR2(2048);
-- Begin testing Encryption:
BEGIN
    dbms_output.put_line('> Input String           : ' ||
CONVERT(UTL_RAW.CAST_TO_VARCHAR2(raw_input),'US7ASCII','AL32UTF8'));
    dbms_output.put_line('> ===== BEGIN TEST Encrypt =====');
    encrypted_raw := dbms_crypto.Encrypt(
        src => raw_input,
        typ => DBMS_CRYPTO.AES_CBC_PKCS5,
        key => raw_key);
    dbms_output.put_line('> Encrypted hex value       : ' ||
rawtohex(UTL_RAW.CAST_TO_RAW(encrypted_raw)));
    decrypted_raw := dbms_crypto.Decrypt(
        src => encrypted_raw,
        typ => DBMS_CRYPTO.AES_CBC_PKCS5,
        key => raw_key);
    decrypted_string :=
CONVERT(UTL_RAW.CAST_TO_VARCHAR2(decrypted_raw),'US7ASCII','AL32UTF8');
    dbms_output.put_line('> Decrypted string output    : ' ||
decrypted_string);
    if input_string = decrypted_string THEN
        dbms_output.put_line('> String DES Encryption and Decryption successful');
    END if;
    dbms_output.put_line('');
    dbms_output.put_line('> ===== BEGIN TEST Hash =====');
    encrypted_raw := dbms_crypto.Hash(
        src => raw_input,
        typ => DBMS_CRYPTO.HASH_SH1);
    dbms_output.put_line('> Hash value of input string      : ' ||
rawtohex(UTL_RAW.CAST_TO_RAW(encrypted_raw)));
    dbms_output.put_line('> ===== BEGIN TEST Mac =====');
    encrypted_raw := dbms_crypto.Mac(
        src => raw_input,

```



```

        typ => DBMS_CRYPTO.HMAC_MD5,
        key => raw_key);
dbms_output.put_line('> Message Authentication Code      : ' ||
        rawtohex(UTL_RAW.CAST_TO_RAW(encrypted_raw)));
dbms_output.put_line('');
dbms_output.put_line('> End of DBMS_CRYPTO tests  ');
END;
/

```

18.6.2 Example: AES 256-Bit Data Encryption and Decryption Procedures

You can use a PL/SQL block to encrypt and decrypt a predefined variable.

For the following example, the predefined variable is named `input_string` and it uses the AES 256-bit algorithm with Cipher Block Chaining and PKCS #5 padding:

```

declare
    input_string      VARCHAR2 (200) := 'Secret Message';
    output_string     VARCHAR2 (200);
    encrypted_raw     RAW (2000);           -- stores encrypted binary text
    decrypted_raw     RAW (2000);           -- stores decrypted binary text
    num_key_bytes     NUMBER := 256/8;     -- key length 256 bits (32 bytes)
    key_bytes_raw     RAW (32);            -- stores 256-bit encryption key
    encryption_type   PLS_INTEGER :=
        DBMS_CRYPTO.ENCRYPT_AES256
        + DBMS_CRYPTO.CHAIN_CBC
        + DBMS_CRYPTO.PAD_PKCS5;
begin
    DBMS_OUTPUT.PUT_LINE ('Original string: ' || input_string);
    key_bytes_raw := DBMS_CRYPTO.RANDOMBYTES (num_key_bytes);
    encrypted_raw := DBMS_CRYPTO.ENCRYPT
        (
            src => UTL_I18N.STRING_TO_RAW (input_string, 'AL32UTF8'),
            typ => encryption_type,
            key => key_bytes_raw
        );
    -- The encrypted value in the encrypted_raw variable can be used here:
    decrypted_raw := DBMS_CRYPTO.DECRYPT
        (
            src => encrypted_raw,
            typ => encryption_type,
            key => key_bytes_raw
        );
    output_string := UTL_I18N.RAW_TO_CHAR (decrypted_raw, 'AL32UTF8');
    DBMS_OUTPUT.PUT_LINE ('Decrypted string: ' || output_string);
end;

```

18.6.3 Example: Encryption and Decryption Procedures for BLOB Data

You can encrypt BLOB data.

The following sample PL/SQL program (`blob_test.sql`) shows how to encrypt and decrypt BLOB data. This example code does the following, and prints out its progress (or problems) at each step:

- Creates a table for the BLOB column
- Inserts the raw values into that table
- Encrypts the raw data
- Decrypts the encrypted data

The blob_test.sql procedure follows:

```
-- 1. Create a table for BLOB column:
create table table_lob (id number, loc blob);

-- 2. Insert 3 empty lobes for src/enc/dec:
insert into table_lob values (1, EMPTY_BLOB());
insert into table_lob values (2, EMPTY_BLOB());
insert into table_lob values (3, EMPTY_BLOB());

set echo on
set serveroutput on

declare
  srcdata    RAW(1000);
  srcblob    BLOB;
  encryblob  BLOB;
  encrypraw  RAW(1000);
  encrawlen  BINARY_INTEGER;
  decryblob  BLOB;
  decrypraw  RAW(1000);
  decrawlen  BINARY_INTEGER;

  leng      INTEGER;

begin

  -- RAW input data 16 bytes
  srcdata := hextoraw('6D6D6D6D6D6D6D6D6D6D6D6D6D6D6D');

  dbms_output.put_line('---');
  dbms_output.put_line('input is ' || srcdata);
  dbms_output.put_line('---');

  -- select empty lob locators for src/enc/dec
  select loc into srcblob from table_lob where id = 1;
  select loc into encryblob from table_lob where id = 2;
  select loc into decryblob from table_lob where id = 3;

  dbms_output.put_line('Created Empty LOBS');
  dbms_output.put_line('---');

  leng := DBMS_LOB.GETLENGTH(srcblob);
  IF leng IS NULL THEN
    dbms_output.put_line('Source BLOB Len NULL ');
  ELSE
    dbms_output.put_line('Source BLOB Len ' || leng);
  END IF;

  leng := DBMS_LOB.GETLENGTH(encryblob);
  IF leng IS NULL THEN
    dbms_output.put_line('Encrypt BLOB Len NULL ');
  ELSE
    dbms_output.put_line('Encrypt BLOB Len ' || leng);
  END IF;

  leng := DBMS_LOB.GETLENGTH(decryblob);
  IF leng IS NULL THEN
    dbms_output.put_line('Decrypt BLOB Len NULL ');
  ELSE
    dbms_output.put_line('Decrypt BLOB Len ' || leng);
  END IF;
```

```
-- 3. Write source raw data into blob:
DBMS_LOB.OPEN (srcblob, DBMS_LOB.lob_readwrite);
DBMS_LOB.WRITEAPPEND (srcblob, 16, srcdata);
DBMS_LOB.CLOSE (srcblob);

dbms_output.put_line('Source raw data written to source blob');
dbms_output.put_line('---');

leng := DBMS_LOB.GETLENGTH(srcblob);
IF leng IS NULL THEN
    dbms_output.put_line('source BLOB Len NULL ');
ELSE
    dbms_output.put_line('Source BLOB Len ' || leng);
END IF;

/*
* Procedure Encrypt
* Arguments: srcblob -> Source BLOB
*            encryptblob -> Output BLOB for encrypted data
*            DBMS_CRYPTO.AES_CBC_PKCS5 -> Algo : AES
*                                           Chaining : CBC
*                                           Padding : PKCS5
*            256 bit key for AES passed as RAW
*            ->
hextoraw('000102030405060708090A0B0C0D0E0F101112131415161718191A1B1C1D1E1F')
*            IV (Initialization Vector) for AES algo passed as RAW
*            -> hextoraw('00000000000000000000000000000000')
*/

DBMS_CRYPTO.Encrypt(encryptblob,
                    srcblob,
                    DBMS_CRYPTO.AES_CBC_PKCS5,
                    hextoraw
('000102030405060708090A0B0C0D0E0F101112131415161718191A1B1C1D1E1F'),
                    hextoraw('00000000000000000000000000000000'));

dbms_output.put_line('Encryption Done');
dbms_output.put_line('---');

leng := DBMS_LOB.GETLENGTH(encryptblob);
IF leng IS NULL THEN
    dbms_output.put_line('Encrypt BLOB Len NULL');
ELSE
    dbms_output.put_line('Encrypt BLOB Len ' || leng);
END IF;

-- 4. Read encryptblob to a raw:
encrawlen := 999;

DBMS_LOB.OPEN (encryptblob, DBMS_LOB.lob_readwrite);
DBMS_LOB.READ (encryptblob, encrawlen, 1, encrypraw);
DBMS_LOB.CLOSE (encryptblob);

dbms_output.put_line('Read encrypt blob to a raw');
dbms_output.put_line('---');

dbms_output.put_line('Encrypted data is (256 bit key) ' || encrypraw);
dbms_output.put_line('---');

/*
```

```

* Procedure Decrypt
* Arguments: encryptblob -> Encrypted BLOB to decrypt
*           decryptblob -> Output BLOB for decrypted data in RAW
*           DBMS_CRYPTO.AES_CBC_PKCS5 -> Algo : AES
*                                           Chaining : CBC
*                                           Padding : PKCS5
*           256 bit key for AES passed as RAW (same as used during Encrypt)
*           ->
hextoraw('000102030405060708090A0B0C0D0E0F101112131415161718191A1B1C1D1E1F')
*           IV (Initialization Vector) for AES also passed as RAW (same as
*           used during Encrypt)
*           -> hextoraw('00000000000000000000000000000000')
*/

DBMS_CRYPTO.Decrypt(decryptblob,
                    encryptblob,
                    DBMS_CRYPTO.AES_CBC_PKCS5,
                    hextoraw
                    ('000102030405060708090A0B0C0D0E0F101112131415161718191A1B1C1D1E1F'),
                    hextoraw('00000000000000000000000000000000'));

leng := DBMS_LOB.GETLENGTH(decryptblob);
IF leng IS NULL THEN
    dbms_output.put_line('Decrypt BLOB Len NULL');
ELSE
    dbms_output.put_line('Decrypt BLOB Len ' || leng);
END IF;

-- Read decryptblob to a raw
decrawlen := 999;

DBMS_LOB.OPEN (decryptblob, DBMS_LOB.lob_readwrite);
DBMS_LOB.READ (decryptblob, decrawlen, 1, decryptraw);
DBMS_LOB.CLOSE (decryptblob);

dbms_output.put_line('Decrypted data is (256 bit key) ' || decryptraw);
dbms_output.put_line('---');

DBMS_LOB.OPEN (srcblob, DBMS_LOB.lob_readwrite);
DBMS_LOB.TRIM (srcblob, 0);
DBMS_LOB.CLOSE (srcblob);

DBMS_LOB.OPEN (encryptblob, DBMS_LOB.lob_readwrite);
DBMS_LOB.TRIM (encryptblob, 0);
DBMS_LOB.CLOSE (encryptblob);

DBMS_LOB.OPEN (decryptblob, DBMS_LOB.lob_readwrite);
DBMS_LOB.TRIM (decryptblob, 0);
DBMS_LOB.CLOSE (decryptblob);

end;
/

truncate table table_lob;
drop table table_lob;

```

18.6.4 Example: Encrypting or Decrypting a Number String

You can use the `DBMS_CRYPTO` PL/SQL package to create functions that will perform the on-demand encryption or decryption of a number string.

The following procedure provides an example of how you can create and use functions to encrypt and decrypt number strings. It also provides an example of testing how the functions work by inserting a converted number string into a table.

1. Create a function that will encrypt a number string.

The following example function, `f_encrypt_number`, uses the input value `number_in`, the return value as the raw type, and `DES_CBC_PKCS5` as the encryption algorithm.

```
CREATE OR REPLACE FUNCTION f_encrypt_number(number_in IN NUMBER)
RETURN RAW IS
  number_in_raw RAW(128):=UTL_I18N.STRING_TO_RAW(number_in,'AL32UTF8');
  key_number number(32):=32432432343243279898;
  key_raw RAW(128):=UTL_RAW.cast_from_number(key_number);
  encrypted_raw RAW(128);
BEGIN

  encrypted_raw:=DBMS_CRYPTO.ENCRYPT(src=>number_in_raw,typ=>DBMS_CRYPTO.DES_
  CBC_PKCS5,key=>key_raw);
  RETURN encrypted_raw;
END;
/
```

2. Run the function `f_encrypt_number` to encrypt the number string 2.

```
SELECT f_encrypt_number('2') FROM DUAL;
```

The result in this example is 84A8B8D7D8925582:

```
F_ENCRYPT_NUMBER('2')
-----
-----
84A8B8D7D8925582
```

3. Create a function to decrypt a number string.

The following example function, `f_decrypt_number`, can decrypt an encrypted raw value `encrypted_raw`. The input is `encrypted_raw`. It uses `DES_CBC_PKCS5` as the decryption algorithm

```
CREATE OR REPLACE FUNCTION f_decrypt_number (encrypted_raw IN RAW)
RETURN NUMBER IS
  decrypted_raw raw(48);
  key_number number(32):=32432432343243279898;
  key_raw RAW(128):=UTL_RAW.cast_from_number(key_number);
BEGIN
  decrypted_raw := DBMS_CRYPTO.DECRYPT
  (
    src => encrypted_raw,
    typ => DBMS_CRYPTO.DES_CBC_PKCS5,
```

```

        key => key_raw
    );
RETURN  UTL_I18N.RAW_TO_CHAR (decrypted_raw, 'AL32UTF8');
END;
/

```

4. Run the function `f_decrypt_number` to decrypt 84A8B8D7D8925582.

```

:

SELECT f_decrypt_number('84A8B8D7D8925582') FROM DUAL;

```

The result is 2:

```

F_DECRYPT_NUMBER('84A8B8D7D8925582')
-----
2

```

5. Test the encrypted number string.

In this test, you run `f_encrypt_number` to encrypt number 2. (The result should be 84A8B8D7D8925582). Then you insert (`f_encrypt_number('2'), username`) into table `test_dbms_crypto`. You will be able to see 84A8B8D7D8925582 username inserted to the table. When you run `f_encrypt_number` to decrypt the ID 84A8B8D7D8925582, the result is 2.

- a. Insert the encrypted number string into the `test_dbms_crypto` table.

```

INSERT INTO test_dbms_crypto VALUES (f_encrypt_number('2'),'username');
1 row created.
COMMIT;
Commit complete.

```

- b. Select from the `test_dbms_crypto` table.

```

SELECT * FROM test_dbms_crypto;

```

The following output should appear:

```

ID                                NAME
-----
84A8B8D7D8925582                username

```

- c. Select from the `test_dbms_crypto` table.

```

SELECT f_decrypt_number(id), NAME FROM test_dbms_crypto ;

```

The following output should appear:

```

F_DECRYPT_NUMBER(ID) NAME
-----
2 username

```

Part IV

Securing Data on the Network

Part IV describes how to secure data on the network.

- [Securing Data for Oracle Database Connections](#)
You can configure the industry standard Transport Layer Security (TLS) or Oracle proprietary Native Network Encryption (NNE) to secure your connection to the Oracle Database.
- [Configuring Oracle Database Native Network Encryption and Data Integrity](#)
You can configure native Oracle Net Services data encryption and data integrity for both servers and clients.
- [Configuring Transport Layer Security Encryption](#)
Use Transport Layer Security (TLS), a secure and standard protocol, to encrypt your database client and server connections.

Securing Data for Oracle Database Connections

You can configure the industry standard Transport Layer Security (TLS) or Oracle proprietary Native Network Encryption (NNE) to secure your connection to the Oracle Database.

Data in transit runs into unique risks that are not quite the same as those related to data at rest. Some of these risks stem from unsecure public networks, the dynamic nature of the network traffic, and the fuzzy lines of ownership between the client and the server.

To safeguard data while it is in transit, the following security mechanisms are relevant to the discussion:

- Confidentiality through encryption: The process of encryption converts data into an unreadable format that can only be deciphered with a decryption key.
- Authentication through certificate signature verification: Authentication verifies the sender's and recipient's identities.
- Integrity through checksum validation: Checksum validation is the process of verifying the integrity to ensure that there has been no tampering or modification in any way.

Network encryption protects data moving over communications networks. Oracle database provides two choices for network encryption:

- Native Network Encryption (NNE): [Configuring Oracle Database Native Network Encryption and Data Integrity](#)
- Transport Layer Security (TLS) Encryption: [Configuring Transport Layer Security Encryption](#)
 TLS (transport layer security) is the default form of network data protection for Internet communications. Security-savvy organizations go a step beyond their Internet traffic and also protect their internal networks, corporate network infrastructure, and virtual private networks with network-level encryption.

The transition from NNE to TLS is a critical initiative to support the contemporary network landscape's heterogeneous ecosystem. In addition to TLS having a stronger security posture and the ability to go undetected by port scanner tools, TLS also supports PKI certificate-based authentication.

TLS is a standard that is omnipresent in global deployments.



Tip:

Oracle's recommendation is for customers to adopt TLS.

Table 19-1 Native Network Encryption vs. Transport Layer Security

Security mechanism	Native Network Encryption	Transparent Layer Security
Confidentiality through encryption	Yes	Yes

Table 19-1 (Cont.) Native Network Encryption vs. Transport Layer Security

Security mechanism	Native Network Encryption	Transparent Layer Security
Authentication through certificate signature verification	No	Yes
Integrity through checksum validation	Yes	Yes

Configuring Oracle Database Native Network Encryption and Data Integrity

You can configure native Oracle Net Services data encryption and data integrity for both servers and clients.

- [About Oracle Database Native Network Encryption and Data Integrity](#)
Oracle Database enables you to encrypt data that is sent over a network.
- [Oracle Database Native Network Encryption Data Integrity](#)
Encrypting network data provides data privacy so that unauthorized parties cannot view plaintext data as it passes over the network.
- [Data Encryption and Integrity sqlnet.ora Parameters](#)
Oracle provides many parameters that you can set in the `sqlnet.ora` file for data encryption and integrity.
- [Data Integrity Algorithms Support](#)
Data integrity algorithms protect against third-party attacks and message replay attacks. Oracle recommends SHA-2, but maintains SHA-1 (deprecated) for backward compatibility.
- [Diffie-Hellman Based Key Negotiation](#)
You can use the Diffie-Hellman key negotiation algorithm to secure data in a multiuser environment.
- [Configuration of Data Encryption and Integrity](#)
Oracle Database native Oracle Net Services encryption and integrity presumes the prior installation of Oracle Net Services.
- [Troubleshooting the Native Network Encryption Configuration](#)
Oracle provides guidance for common native network encryption configuration problems.

20.1 About Oracle Database Native Network Encryption and Data Integrity

Oracle Database enables you to encrypt data that is sent over a network.

- [How Oracle Database Native Network Encryption and Integrity Works](#)
Oracle Database provides native data network encryption and integrity to ensure that data is secure as it travels across the network.
- [Advanced Encryption Standard](#)
Oracle Database supports the Federal Information Processing Standard (FIPS) encryption algorithm, Advanced Encryption Standard (AES).
- [Choosing Between Native Network Encryption and Transport Layer Security](#)
Oracle offers two ways to encrypt data over the network, native network encryption and Transport Layer Security (TLS).

20.1.1 How Oracle Database Native Network Encryption and Integrity Works

Oracle Database provides native data network encryption and integrity to ensure that data is secure as it travels across the network.

The purpose of a secure cryptosystem is to convert plaintext data (text that has not been encrypted) into unintelligible ciphertext (text that has been encrypted) based on a key, in such a way that it is very hard (computationally infeasible) to convert ciphertext back into its corresponding plaintext without knowledge of the correct key.

In a symmetric cryptosystem, the same key is used both for encryption and decryption of the same data. Oracle Database provides the Advanced Encryption Standard (AES) symmetric cryptosystem for protecting the confidentiality of Oracle Net Services traffic.

20.1.2 Advanced Encryption Standard

Oracle Database supports the Federal Information Processing Standard (FIPS) encryption algorithm, Advanced Encryption Standard (AES).

AES can be used by all U.S. government organizations and businesses to protect sensitive data over a network. This encryption algorithm defines three standard key lengths, which are 128-bit, 192-bit, and 256-bit. All versions operate in outer Cipher Block Chaining (CBC) mode. CBC mode is an encryption method that protects against block replay attacks by making the encryption of a cipher block dependent on all blocks that precede it; it is designed to make unauthorized decryption incrementally more difficult. Oracle Database employs outer cipher block chaining because it is more secure than inner cipher block chaining, with no material performance penalty.



Note:

The AES algorithms have been improved. To transition your Oracle Database environment to use stronger algorithms, download and install the patch described in My Oracle Support note [2118136.2](#).

20.1.3 Choosing Between Native Network Encryption and Transport Layer Security

Oracle offers two ways to encrypt data over the network, native network encryption and Transport Layer Security (TLS).

There are advantages and disadvantages to both methods.

Table 20-1 Comparison of Native Network Encryption and Transport Layer Security

-	Native Network Encryption	Transport Layer Security
Advantages	<ul style="list-style-type: none"> • It is configured with parameters in the <code>sqlnet.ora</code> configuration file. • In most cases, no client configuration changes are required. • No certificates are required. • Clients that do not support native network encryption can fall back to unencrypted connections while incompatibility is mitigated. 	<ul style="list-style-type: none"> • It is an industry standard for encrypting data in motion. • It provides non-repudiation for server connections to prevent third-party attacks. • It can be used for database user authentication.
Disadvantages	<ul style="list-style-type: none"> • It uses a non-standard, Oracle proprietary implementation. • It provides no non-repudiation of the server connection (that is, no protection against a third-party attack). 	<ul style="list-style-type: none"> • It requires client and server changes. • Certificates are required for server and are optional for the client. However, the client must have the trusted root certificate for the certificate authority that issued the server's certificate. • Certificates eventually expire.

20.2 Oracle Database Native Network Encryption Data Integrity

Encrypting network data provides data privacy so that unauthorized parties cannot view plaintext data as it passes over the network.

Oracle Database also provides protection against two forms of active attacks.

[Table 20-2](#) provides information about these attacks.

Table 20-2 Two Forms of Network Attacks

Type of Attack	Explanation
Data modification attack	An unauthorized party intercepting data in transit, altering it, and retransmitting it is a data modification attack. For example, intercepting a \$100 bank deposit, changing the amount to \$10,000, and retransmitting the higher amount is a data modification attack.
Replay attack	Repetitively retransmitting an entire set of valid data is a replay attack, such as intercepting a \$100 bank withdrawal and retransmitting it ten times, thereby receiving \$1,000.

20.3 Data Encryption and Integrity `sqlnet.ora` Parameters

Oracle provides many parameters that you can set in the `sqlnet.ora` file for data encryption and integrity.

- [About the Data Encryption and Integrity Parameters](#)
The data encryption and integrity parameters control the type of encryption algorithm you are using.

- [Sample sqlnet.ora File](#)
The sample `sqlnet.ora` configuration file is based on a set of clients with similar characteristics and a set of servers with similar characteristics.

20.3.1 About the Data Encryption and Integrity Parameters

The data encryption and integrity parameters control the type of encryption algorithm you are using.

The `sqlnet.ora` file, which is where you set these parameters, is generated when you perform the network configuration. Also provided in this process are encryption and data integrity parameters. You can use the default parameter settings as a guideline for configuring data encryption and integrity.

The following table lists the data encryption and integrity parameters.

Table 20-3 Data Encryption and Integrity Parameters

Parameter	Description
<code>SQLNET.CRYPTO_CHECKSUM_CLIENT</code>	Specifies the checksum behavior for the client
<code>SQLNET.CRYPTO_CHECKSUM_SERVER</code>	Specifies the checksum behavior for the server
<code>SQLNET.CRYPTO_CHECKSUM_TYPES_CLIENT</code>	Specifies a list of crypto-checksum algorithms for the client to use
<code>SQLNET.CRYPTO_CHECKSUM_TYPES_SERVER</code>	Specifies a list of crypto-checksum algorithms for the server to use
<code>SQLNET.ENCRYPTION_CLIENT</code>	Enables encryption for the client
<code>SQLNET.ENCRYPTION_SERVER</code>	Enables encryption for the server
<code>SQLNET.ENCRYPTION_TYPES_CLIENT</code>	Lists encryption algorithms the client to use
<code>SQLNET.ENCRYPTION_TYPES_SERVER</code>	Lists encryption algorithms the server to use

If you do not specify any values for Server Encryption, Client Encryption, Server Checksum, or Client Checksum, the corresponding configuration parameters do not appear in the `sqlnet.ora` file. However, the defaults are `ACCEPTED`.

For both data encryption and integrity algorithms, the server selects the first algorithm listed in its `sqlnet.ora` file that matches an algorithm listed in the client `sqlnet.ora` file, or in the client installed list if the client lists no algorithms in its `sqlnet.ora` file. If there are no entries in the server `sqlnet.ora` file, the server sequentially searches its installed list to match an item on the client side—either in the client `sqlnet.ora` file or in the client installed list. *If no match can be made and one side of the connection REQUIRED the algorithm type (data encryption or integrity), then the connection fails.* Otherwise, the connection succeeds with the algorithm type inactive.

Data encryption and integrity algorithms are selected independently of each other. Encryption can be activated without integrity, and integrity can be activated without encryption, as shown by [Table 20-4](#):

Table 20-4 Algorithm Type Selection

Encryption Selected?	Integrity Selected?
Yes	No

Table 20-4 (Cont.) Algorithm Type Selection

Encryption Selected?	Integrity Selected?
Yes	Yes
No	Yes
No	No

Related Topics

- [Oracle Database Net Services Reference](#)
- [Configuring Oracle Database Native Network Encryption and Data Integrity](#)
You can configure native Oracle Net Services data encryption and data integrity for both servers and clients.
- [About Activating Encryption and Integrity](#)
In any network connection, both the client and server can support multiple encryption algorithms and integrity algorithms.

20.3.2 Sample sqlnet.ora File

The sample `sqlnet.ora` configuration file is based on a set of clients with similar characteristics and a set of servers with similar characteristics.

The file includes examples of Oracle Database encryption and data integrity parameters.

By default, the `sqlnet.ora` file is located in the `ORACLE_HOME/network/admin` directory or in the location set by the `TNS_ADMIN` environment variable. Ensure that you have properly set the `TNS_ADMIN` variable to point to the correct `sqlnet.ora` file.

Trace File Setup

```
#Trace file setup
trace_level_server=16
trace_level_client=16
trace_directory_server=/orant/network/trace
trace_directory_client=/orant/network/trace
trace_file_client=cli
trace_file_server=srv
trace_unique_client=true
```

Oracle Database Native Network Encryption

```
sqlnet.encryption_server=accepted
sqlnet.encryption_client=requested
sqlnet.encryption_types_server=(AES256)
sqlnet.encryption_types_client=(AES256)
```

 **Note:**

The RC4_40 algorithm is deprecated in this release. To transition your Oracle Database environment to use stronger algorithms, download and install the patch described in My Oracle Support note [2118136.2](#).

Oracle Database Network Data Integrity

```
#ASO Checksum
sqlnet.crypto_checksum_server=requested
sqlnet.crypto_checksum_client=requested
sqlnet.crypto_checksum_types_server = (SHA256)
sqlnet.crypto_checksum_types_client = (SHA256)
```

Transport Layer Security

```
#SSL
WALLET_LOCATION = (SOURCE=
                    (METHOD = FILE)
                    (METHOD_DATA =
                     DIRECTORY=/wallet)

SSL_CIPHER_SUITES=(TLS_AES_128_CCM_SHA256)
SSL_VERSION= TLSv1.3
SSL_CLIENT_AUTHENTICATION=FALSE
```

Common

```
#Common
automatic_ipc = off
sqlnet.authentication_services = (beq)
names.directory_path = (TNSNAMES)
```

Kerberos

```
#Kerberos
sqlnet.authentication_services = (beq, kerberos5)
sqlnet.authentication_kerberos5_service = oracle
sqlnet.kerberos5_conf= /krb5/krb.conf
sqlnet.kerberos5_keytab= /krb5/v5srvtab
sqlnet.kerberos5_realms= /krb5/krb.realm
sqlnet.kerberos5_cc_name = /krb5/krb5.cc
sqlnet.kerberos5_clockskew=900
sqlnet.kerberos5_conf_mit=false
```

RADIUS

```
#Radius
sqlnet.authentication_services = (beq, RADIUS )
sqlnet.radius_authentication_timeout = (10)
sqlnet.radius_authentication_retries = (2)
sqlnet.radius_authentication_port = (1645)
sqlnet.radius_send_accounting = OFF
sqlnet.radius_secret = /orant/network/admin/radius.key
sqlnet.radius_authentication = radius.us.example.com
sqlnet.radius_challenge_response = OFF
sqlnet.radius_challenge_keyword = challenge
sqlnet.radius_challenge_interface =
oracle/net/radius/DefaultRadiusInterface
sqlnet.radius_classpath = /jre1.1/
```

20.4 Data Integrity Algorithms Support

Data integrity algorithms protect against third-party attacks and message replay attacks. Oracle recommends SHA-2, but maintains SHA-1 (deprecated) for backward compatibility.

These hashing algorithms create a checksum that changes if the data is altered in any way. This protection operates independently from the encryption process so you can enable data integrity with or without enabling encryption.

Related Topics

- [Configuring Integrity on the Client and the Server](#)
You can use Oracle Net Manager to configure network integrity on both the client and the server.

20.5 Diffie-Hellman Based Key Negotiation

You can use the Diffie-Hellman key negotiation algorithm to secure data in a multiuser environment.

Secure key distribution is difficult in a multiuser environment. Oracle Database uses the well known Diffie-Hellman key negotiation algorithm to perform secure key distribution for both encryption and data integrity.

When encryption is used to protect the security of encrypted data, keys must be changed frequently to minimize the effects of a compromised key. Accordingly, the Oracle Database key management function changes the session key with every session.

The Diffie-Hellman key negotiation algorithm is a method that lets two parties communicating over an insecure channel to agree upon a random number known only to them. Oracle Database uses the Diffie-Hellman key negotiation algorithm to generate session keys.

The client and the server begin communicating using the session key generated by Diffie-Hellman. When the client authenticates to the server, they establish a shared secret that is only known to both parties. Oracle Database combines the shared secret and the Diffie-Hellman session key to generate a stronger session key designed to defeat a person-in-the-middle attack.

Note:

The use of the anonymous RC4 cipher suite for non-authenticated TLS connections was desupported in Oracle Database 21c (`SSL_DH_anon_WITH_RC4_128_MD5`). Oracle recommends that you use the more secure authenticated connections available with Oracle Database. If you use anonymous Diffie-Hellman with RC4 for connecting to Oracle Internet Directory for Oracle Enterprise User Security, then you must migrate to use a different algorithm connection. Oracle recommends that you use either TLS one-way, or mutual authentication using certificates. Note that Oracle Enterprise User Security has been deprecated starting with Oracle Database 23ae.

20.6 Configuration of Data Encryption and Integrity

Oracle Database native Oracle Net Services encryption and integrity presumes the prior installation of Oracle Net Services.

- [About Activating Encryption and Integrity](#)
In any network connection, both the client and server can support multiple encryption algorithms and integrity algorithms.

- [About Negotiating Encryption and Integrity](#)
The `sqlnet.ora` file on systems using data encryption and integrity must contain some or all the `REJECTED`, `ACCEPTED`, `REQUESTED`, and `REQUIRED` parameters.
- [Configuring Encryption and Integrity Parameters Using Oracle Net Manager](#)
You can set up or change encryption and integrity parameter settings using Oracle Net Manager.

20.6.1 About Activating Encryption and Integrity

In any network connection, both the client and server can support multiple encryption algorithms and integrity algorithms.

When a connection is made, the server selects which algorithm to use, if any, from those algorithms specified in the `sqlnet.ora` files. The server searches for a match between the algorithms available on both the client and the server, and picks the first algorithm in its own list that also appears in the client list. If one side of the connection does not specify an algorithm list, all the algorithms installed on that side are acceptable. The connection fails with error message `ORA-12650` if either side specifies an algorithm that is not installed.

Encryption and integrity parameters are defined by modifying a `sqlnet.ora` file on the clients and the servers on the network.

You can choose to configure any or all of the available encryption algorithms, and either or both of the available integrity algorithms. Only one encryption algorithm and one integrity algorithm are used for each connect session.

Note:

Oracle Database selects the first encryption algorithm and the first integrity algorithm enabled on the client and the server. Oracle recommends that you select algorithms and key lengths in the order in which you prefer negotiation, choosing the strongest key length first.

Related Topics

- [Data Encryption and Integrity sqlnet.ora Parameters](#)
Oracle provides many parameters that you can set in the `sqlnet.ora` file for data encryption and integrity.
- *Oracle Database Advanced Security Guide*

20.6.2 About Negotiating Encryption and Integrity

The `sqlnet.ora` file on systems using data encryption and integrity must contain some or all the `REJECTED`, `ACCEPTED`, `REQUESTED`, and `REQUIRED` parameters.

- [About the Values for Negotiating Encryption and Integrity](#)
Oracle Net Manager can be used to specify four possible values for the encryption and integrity configuration parameters.
- [REJECTED Configuration Parameter](#)
The `REJECTED` value disables the security service, even if the other side requires this service.

- **ACCEPTED Configuration Parameter**
The `ACCEPTED` value enables the security service if the other side requires or requests the service.
- **REQUESTED Configuration Parameter**
The `REQUESTED` value enables the security service if the other side permits this service.
- **REQUIRED Configuration Parameter**
The `REQUIRED` value enables the security service or preclude the connection.

20.6.2.1 About the Values for Negotiating Encryption and Integrity

Oracle Net Manager can be used to specify four possible values for the encryption and integrity configuration parameters.

The following four values are listed in the order of increasing security, and they must be used in the profile file (`sqlnet.ora`) for the client and server of the systems that are using encryption and integrity.

The value `REJECTED` provides the *minimum* amount of security between client and server communications, and the value `REQUIRED` provides the *maximum* amount of network security:

- `REJECTED`
- `ACCEPTED`
- `REQUESTED`
- `REQUIRED`

The default value for each of the parameters is `ACCEPTED`.

Oracle Database servers and clients are set to `ACCEPT` encrypted connections out of the box. This means that you can enable the desired encryption and integrity settings for a connection pair by configuring just one side of the connection, server-side or client-side.

So, for example, if there are many Oracle clients connecting to an Oracle database, you can configure the required encryption and integrity settings for all these connections by making the appropriate `sqlnet.ora` changes at the server end. You do not need to implement configuration changes for each client separately.

[Table 20-5](#) shows whether the security service is enabled, based on a combination of client and server configuration parameters. If either the server or client has specified `REQUIRED`, the lack of a common algorithm *causes the connection to fail*. Otherwise, if the service is enabled, lack of a common service algorithm results in the service being *disabled*.

Table 20-5 Encryption and Data Integrity Negotiations

Client Setting	Server Setting	Encryption and Data Negotiation
REJECTED	REJECTED	OFF
ACCEPTED	REJECTED	OFF
REQUESTED	REJECTED	OFF
REQUIRED	REJECTED	Connection fails
REJECTED	ACCEPTED	OFF
ACCEPTED	ACCEPTED	OFF ¹
REQUESTED	ACCEPTED	ON

Table 20-5 (Cont.) Encryption and Data Integrity Negotiations

Client Setting	Server Setting	Encryption and Data Negotiation
REQUIRED	ACCEPTED	ON
REJECTED	REQUESTED	OFF
ACCEPTED	REQUESTED	ON
REQUESTED	REQUESTED	ON
REQUIRED	REQUESTED	ON
REJECTED	REQUIRED	Connection fails
ACCEPTED	REQUIRED	ON
REQUESTED	REQUIRED	ON
REQUIRED	REQUIRED	ON

¹ This value defaults to OFF. Cryptography and data integrity are not enabled until the user changes this parameter by using Oracle Net Manager or by modifying the `sqlnet.ora` file.

20.6.2.2 REJECTED Configuration Parameter

The `REJECTED` value disables the security service, even if the other side requires this service.

In this scenario, this side of the connection specifies that the security service is not permitted. If the other side is set to `REQUIRED`, the connection *terminates* with error message `ORA-12650`. If the other side is set to `REQUESTED`, `ACCEPTED`, or `REJECTED`, the connection continues without error and without the security service enabled.

20.6.2.3 ACCEPTED Configuration Parameter

The `ACCEPTED` value enables the security service if the other side requires or requests the service.

In this scenario, this side of the connection does not require the security service, but it is enabled if the other side is set to `REQUIRED` or `REQUESTED`. If the other side is set to `REQUIRED` or `REQUESTED`, and an encryption or integrity algorithm match is found, the connection continues without error and with the security service enabled. If the other side is set to `REQUIRED` and no algorithm match is found, the connection terminates with error message `ORA-12650`.

If the other side is set to `REQUESTED` and no algorithm match is found, or if the other side is set to `ACCEPTED` or `REJECTED`, the connection continues without error and without the security service enabled.

20.6.2.4 REQUESTED Configuration Parameter

The `REQUESTED` value enables the security service if the other side permits this service.

In this scenario, this side of the connection specifies that the security service is desired but not required. The security service is enabled if the other side specifies `ACCEPTED`, `REQUESTED`, or `REQUIRED`. There must be a matching algorithm available on the other side, otherwise the service is not enabled. If the other side specifies `REQUIRED` and there is no matching algorithm, *the connection fails*.

20.6.2.5 REQUIRED Configuration Parameter

The `REQUIRED` value enables the security service or preclude the connection.

In this scenario, this side of the connection specifies that the security service *must be enabled*. The connection *fails* if the other side specifies `REJECTED` or if there is no compatible algorithm on the other side.

20.6.3 Configuring Encryption and Integrity Parameters Using Oracle Net Manager

You can set up or change encryption and integrity parameter settings using Oracle Net Manager.

- [Configuring Encryption on the Client and the Server](#)
Use Oracle Net Manager to configure encryption on the client and on the server.
- [Configuring Integrity on the Client and the Server](#)
You can use Oracle Net Manager to configure network integrity on both the client and the server.
- [Enabling Both Oracle Native Encryption and SSL Authentication for Different Users Concurrently](#)
Depending on the `SQLNET.ENCRYPTION_CLIENT` and `SQLNET.ENCRYPTION_SERVER` settings, you can configure Oracle Database to allow both Oracle native encryption and SSL authentication for different users concurrently.

20.6.3.1 Configuring Encryption on the Client and the Server

Use Oracle Net Manager to configure encryption on the client and on the server.

1. Start Oracle Net Manager.
 - (UNIX) From `$ORACLE_HOME/bin`, enter the following command at the command line:

```
netmgr
```
 - (Windows) Select **Start, Programs, Oracle - HOME_NAME, Configuration and Migration Tools**, then **Net Manager**.
2. Expand **Oracle Net Configuration**, and from **Local**, select **Profile**.
3. From the **Naming** list, select **Network Security**.
The Network Security tabbed window appears.
4. Select the **Encryption** tab.

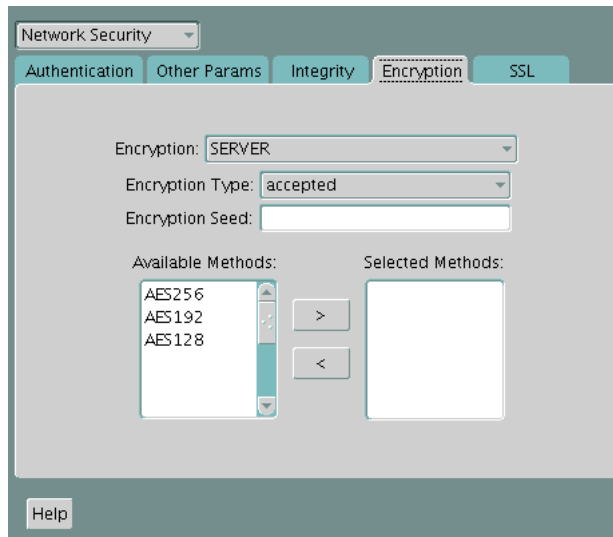

5. Select **CLIENT** or **SERVER** option from the **Encryption** box.
6. From the Encryption Type list, select one of the following:
 - **REQUESTED**
 - **REQUIRED**
 - **ACCEPTED**
 - **REJECTED**
7. (Optional) In the **Encryption Seed** field, enter between 10 and 70 random characters. The encryption seed for the client should not be the same as that for the server.
8. Select an encryption algorithm in the **Available Methods** list. Move it to the **Selected Methods** list by choosing the right arrow (>). Repeat for each additional method you want to use.
9. Select **File, Save Network Configuration**. The `sqlnet.ora` file is updated.
10. Repeat this procedure to configure encryption on the other system. The `sqlnet.ora` file on the two systems should contain the following entries:

- On the server:

```
SQLNET.ENCRYPTION_SERVER = [accepted | rejected | requested | required]
SQLNET.ENCRYPTION_TYPES_SERVER = (valid_encryption_algorithm
[,valid_encryption_algorithm])
```

- On the client:

```
SQLNET.ENCRYPTION_CLIENT = [accepted | rejected | requested | required]
SQLNET.ENCRYPTION_TYPES_CLIENT = (valid_encryption_algorithm
[,valid_encryption_algorithm])
```

Table 20-6 lists valid encryption algorithms and their associated legal values.

Table 20-6 Valid Encryption Algorithms

Algorithm Name	Legal Value
AES 256-bit key	AES256
AES 192-bit key	AES192

Table 20-6 (Cont.) Valid Encryption Algorithms

Algorithm Name	Legal Value
AES 128-bit key	AES128

20.6.3.2 Configuring Integrity on the Client and the Server

You can use Oracle Net Manager to configure network integrity on both the client and the server.

1. Start Oracle Net Manager.
 - (UNIX) From `$ORACLE_HOME/bin`, enter the following command at the command line:

```
netmgr
```
 - (Windows) Select **Start, Programs, Oracle - HOME_NAME, Configuration and Migration Tools**, then **Net Manager**.
2. Expand **Oracle Net Configuration**, and from **Local**, select **Profile**.
3. From the **Naming** list, select **Network Security**.
 The Network Security tabbed window appears.
4. Select the **Integrity** tab.

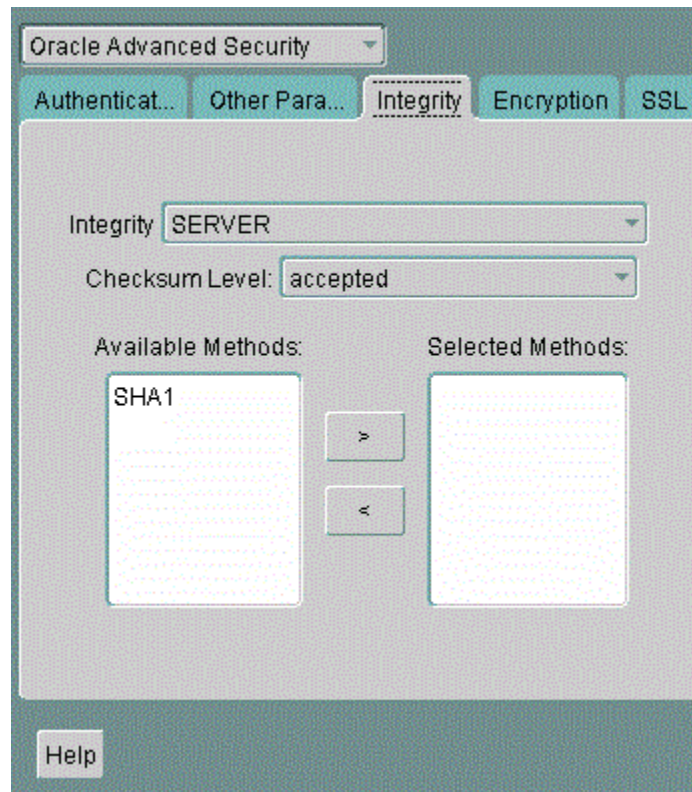

5. Depending upon which system you are configuring, select the **Server** or **Client** from the **Integrity** box.
6. From the **Checksum Level** list, select one of the following checksum level values:

- **REQUESTED**
 - **REQUIRED**
 - **ACCEPTED**
 - **REJECTED**
7. Select an integrity algorithm in the **Available Methods** list. Move it to the **Selected Methods** list by choosing the right arrow (>). Repeat for each additional method you want to use.
 8. Select **File, Save Network Configuration**.

The `sqlnet.ora` file is updated.

9. Repeat this procedure to configure integrity on the other system.

The `sqlnet.ora` file on the two systems should contain the following entries:

- On the server:

```
SQLNET.CRYPTO_CHECKSUM_SERVER = [accepted | rejected | requested | required]
SQLNET.CRYPTO_CHECKSUM_TYPES_SERVER = (valid_crypto_checksum_algorithm
[,valid_crypto_checksum_algorithm])
```

- On the client:

```
SQLNET.CRYPTO_CHECKSUM_CLIENT = [accepted | rejected | requested | required]
SQLNET.CRYPTO_CHECKSUM_TYPES_CLIENT = (valid_crypto_checksum_algorithm
[,valid_crypto_checksum_algorithm])
```

Valid integrity/checksum algorithms that you can use are as follows:

- SHA1
- SHA256
- SHA384
- SHA512

Related Topics

- *Oracle Database Advanced Security Guide*

20.6.3.3 Enabling Both Oracle Native Encryption and SSL Authentication for Different Users Concurrently

Depending on the `SQLNET.ENCRYPTION_CLIENT` and `SQLNET.ENCRYPTION_SERVER` settings, you can configure Oracle Database to allow both Oracle native encryption and SSL authentication for different users concurrently.

- [About Enabling Both Oracle Native Encryption and SSL Authentication for Different Users Concurrently](#)
By default, Oracle Database does not allow both Oracle native encryption and Transport Layer Security (SSL) authentication for different users concurrently.
- [Configuring Both Oracle Native Encryption and SSL Authentication for Different Users Concurrently](#)
Use the `IGNORE_ANO_ENCRYPTION_FOR_TCPS` parameter to enable the concurrent use of both Oracle native encryption and Transport Layer Security (SSL) authentication.

20.6.3.3.1 About Enabling Both Oracle Native Encryption and SSL Authentication for Different Users Concurrently

By default, Oracle Database does not allow both Oracle native encryption and Transport Layer Security (SSL) authentication for different users concurrently.

The use of both Oracle native encryption (also called Advanced Networking Option (ANO) encryption) and TLS authentication together is called double encryption.

There are cases in which both a TCP and TCPS listener must be configured, so that some users can connect to the server using a user name and password, and others can validate to the server by using a TLS certificate. In these situations, you must configure both password-based authentication and TLS authentication. A workaround in previous releases was to set the `SQLNET.ENCRYPTION_SERVER` parameter to `requested`. If your requirements are that `SQLNET.ENCRYPTION_SERVER` be set to `required`, then you can set the `IGNORE_ANO_ENCRYPTION_FOR_TCPS` parameter in both `SQLNET.ENCRYPTION_CLIENT` and `SQLNET.ENCRYPTION_SERVER` to `TRUE`. By default, it is set to `FALSE`.

Setting `IGNORE_ANO_ENCRYPTION_FOR_TCPS` to `TRUE` forces the client to ignore the value that is set for the `SQLNET.ENCRYPTION_CLIENT` parameter for all outgoing TCPS connections. This parameter allows the database to ignore the `SQLNET.ENCRYPTION_CLIENT` or `SQLNET.ENCRYPTION_SERVER` setting when there is a conflict between the use of a TCPS client and when these two parameters are set to `required`.

20.6.3.3.2 Configuring Both Oracle Native Encryption and SSL Authentication for Different Users Concurrently

Use the `IGNORE_ANO_ENCRYPTION_FOR_TCPS` parameter to enable the concurrent use of both Oracle native encryption and Transport Layer Security (SSL) authentication.

On the server, you must set `IGNORE_ANO_ENCRYPTION_FOR_TCPS` in the `sqlnet.ora` file, and on the client, you can set it in either the `sqlnet.ora` file or the `tnsnames.ora` file.

1. Log in to the database server
2. Go to the location of the `sqlnet.ora` file.

By default, `sqlnet.ora` is in the `ORACLE_BASE/network/admin` directory. The `sqlnet.ora` file can also be stored in the directory specified by the `TNS_ADMIN` environment variable.

3. In `sqlnet.ora`, check if the current `SQLNET.ENCRYPTION_SERVER` setting is `required` or `requested`.
4. If `SQLNET.ENCRYPTION_SERVER` is set to `required`, then add the `SQLNET.IGNORE_ANO_ENCRYPTION_FOR_TCPS` to `sqlnet.ora` and then set it to `TRUE`.

```
IGNORE_ANO_ENCRYPTION_FOR_TCPS=TRUE
```

5. Save and exit `sqlnet.ora`.
6. Log in to the client.

For the client, you can set the value in either the `sqlnet.ora` file or the `tnsnames.ora` file.

- Setting the value in `sqlnet.ora`: Check if the `SQLNET.ENCRYPTION_CLIENT` parameter is set to `required`. If `SQLNET.ENCRYPTION_CLIENT`, then edit the `sqlnet.ora` file to have the following setting:

```
IGNORE_ANO_ENCRYPTION_FOR_TCPS=TRUE
```

- **Setting the value in tnsnames.ora:** By default, tnsnames.ora is in the same location as sqlnet.ora. If SQLNET.ENCRYPTION_CLIENT is set to required in sqlnet.ora, then in the SECURITY portion of the TNS_ALIAS setting, set IGNORE_ANO_ENCRYPTION_FOR_TCPS=TRUE. For example:

```
test_tls=
  (DESCRIPTION =
    (ADDRESS=(PROTOCOL=tcps) (HOST=) (PORT=1750))
    (CONNECT_DATA=(SID=^ORACLE_SID^))
    (SECURITY=(IGNORE_ANO_ENCRYPTION_FOR_TCPS=TRUE))
  )
```

20.7 Troubleshooting the Native Network Encryption Configuration

Oracle provides guidance for common native network encryption configuration problems.

- [Checking if Native Network Encryption Is Enabled in the Current Session](#)
Depending on how the encryption parameters are set in the server and client sqlnet.ora file, you can check if native network encryption is enabled if the current session.
- [ORA-12650 and ORA-12660 Errors in the Native Network Encryption Configuration](#)
Oracle provides several solutions for ORA-12650 and ORA-12660 errors that can occur in a native network encryption configuration.

20.7.1 Checking if Native Network Encryption Is Enabled in the Current Session

Depending on how the encryption parameters are set in the server and client sqlnet.ora file, you can check if native network encryption is enabled if the current session.

1. On the server, check ENCRYPTION_SERVER and ENCRYPTION_TYPES_SERVER parameters.

For example:

```
sqlnet.encryption_server = required
sqlnet.encryption_types_server = AES256
```

By default, sqlnet.ora is located in the \$ORACLE_HOME/network/admin directory, for both the server and the client.

2. On the client, check the ENCRYPTION_SERVER and ENCRYPTION_TYPES_CLIENT parameters.

For example:

```
sqlnet.encryption_server = required
sqlnet.encryption_types_client = AES256
```

3. From a client that has been configured with native network encryption for database connections, query the V\$SESSION_CONNECT_INFO dynamic view.

For example:

```
set line 1000
col NETWORK_SERVICE_BANNER for a100
```

```
SELECT NETWORK_SERVICE_BANNER FROM V$SESSION_CONNECT_INFO WHERE
SID=(SELECT SID FROM V$MYSTAT WHERE ROWNUM<2);
```

If the connection is unencrypted, then output similar to the following appears:

```
NETWORK_SERVICE_BANNER
-----
-----
TCP/IP NT Protocol Adapter for Linux: Version version_number - Production
Authentication service for Linux: Version version_number - Production
KERBEROS5PRE Authentication service adapter for Linux: Version
version_number - Production
Encryption service for Linux: Version version_number - Production
Crypto-checksumming service for Linux: Version version_number - Production
```

However, if the connection is encrypted, then output similar to the following appears. The additional line in bold (AES256 Encryption service adapter for Linux) indicates that the connection is encrypted.

```
NETWORK_SERVICE_BANNER
-----
-----
TCP/IP NT Protocol Adapter for Linux: Version version_number - Production
Authentication service for Linux: Version version_number - Production
KERBEROS5PRE Authentication service adapter for Linux: Version
version_number - Production
Encryption service for Linux: Version version_number - Production
AES256 Encryption service adapter for Linux: Version version_number -
Production
Crypto-checksumming service for Linux: Version version_number - Production
```

20.7.2 ORA-12650 and ORA-12660 Errors in the Native Network Encryption Configuration

Oracle provides several solutions for ORA-12650 and ORA-12660 errors that can occur in a native network encryption configuration.

The ORA-12650: No common encryption or data integrity algorithm and ORA-12660: Encryption or crypto-checksumming parameters incompatible errors are caused only when you set `SQLNET.ENCRYPTION_CLIENT` and `SQLNET.ENCRYPTION_SERVER` to rejected on each side (client and server). They can also occur if there is a misconfiguration in the `sqlnet.ora` file.

To remedy this problem, do the following

- Check the settings in the `sqlnet.ora` file on both the client and the server.
- If the `sqlnet.ora` settings look correct, then check the `PATH` and `TNS_ADMIN` environment variables.
- Look for any additional `sqlnet.ora` files that may be in the client and server directory tree.
- If the settings of `sqlnet.ora` and the actual behavior are different, and if you cannot find any specific incongruities in the `sqlnet.ora` file, then perform a net trace level 16 both in server side and client side.

21

Configuring Transport Layer Security Encryption

Use Transport Layer Security (TLS), a secure and standard protocol, to encrypt your database client and server connections.

- [Transport Layer Security \(TLS\) and the Oracle Database](#)
TLS secures connections between the Oracle Database client and server. The database server can also connect to other databases and other services using TLS version 1.3 (the default) or 1.2. This chapter will primarily focus on configuring TLS between the Oracle Database client and server.
- [Configuring TLS for the Oracle Database and Client](#)
This topic describes the three most common TLS configurations. More advanced and optional configurations are described later in this chapter.
- [Advanced and Optional Configurations](#)
Oracle Database 23ai ensures that the default Transport Layer Security configuration is secure and versatile. However, Oracle provides parameters to customize and control this configuration.
- [TLS and Other Oracle Products](#)
Transport Layer Security (TLS) can be configured when using other Oracle Database products.
- [Troubleshooting the Transport Layer Security Configuration](#)
Common errors may occur while you use the Oracle Database Transport Layer Security.
- [Migrating to and Configuring Transport Layer Security Version 1.3](#)
Version 1.3 of Transport Layer Security (TLS) provides stronger security and faster TLS handshakes, when compared to previous versions of TLS.

21.1 Transport Layer Security (TLS) and the Oracle Database

TLS secures connections between the Oracle Database client and server. The database server can also connect to other databases and other services using TLS version 1.3 (the default) or 1.2. This chapter will primarily focus on configuring TLS between the Oracle Database client and server.

The database client and server can be configured to use TLS depending on your requirements. There are several options to consider which are mentioned below. The primary use cases are discussed in the following topic. Advanced considerations are discussed in [Advanced and Optional Configurations](#).

Configuring a client-server TLS connection requires the database server to have a wallet. The server wallet includes the private key, the signed user certificate, the root of trust certificate and any intermediate certificates for the database server user certificate.

The TLS wallet on the database server must be stored under the `WALLET_ROOT` location. (The parameter `WALLET_LOCATION` is deprecated for use with Oracle Database 23ai for the Oracle Database server. It is not deprecated for use with the Oracle Database client or listener.) Create a directory for TLS under `WALLET_ROOT`, so it looks like `WALLET_ROOT/<PDB GUID>/`

tls. Each container (including CDB root) will have its own TLS wallet, there's no configuration to have a single wallet work for more than one or all containers when using `WALLET_ROOT`.

When configuring TLS between the database client and server there are several options to consider:

- [Self-signed Certificate vs Public Certificate Authority \(CA\) Signed Certificate](#)
Determine whether a self-signed certificate or a public certificate authority signed certificate is appropriate for your database configuration.
- [One-way TLS vs Mutual TLS](#)
Determine if one-way TLS or Mutual TLS (mTLS) is appropriate for your database configuration.
- [TLS With or Without a Client Wallet](#)
Determine if using a client wallet is appropriate for your database configuration.
- [Certificate DN Matching](#)
Determine if certificate DN matching is appropriate for your database configuration.

21.1.1 Self-signed Certificate vs Public Certificate Authority (CA) Signed Certificate

Determine whether a self-signed certificate or a public certificate authority signed certificate is appropriate for your database configuration.

Self-signed certificate: Having a self-signed root certificate is a common practice for internally facing IT resources since you can create these yourself and it's free. The resource (in our case, the database server) will use a self-signed root certificate to sign its own database server certificate. The server certificate and self-signed root certificate are stored in the database server wallet. For the database client to be able to trust the database server certificate, a copy of the self-signed root certificate will also be needed by the client. This self-signed root certificate can be stored in a client-side wallet or installed in the client system default certificate store. The system certificate store locations for all OS are mentioned in [Oracle Wallet Search Order](#).

Before the session is established, the database client will check if the server certificate has been signed by the same root certificate installed on the client. Storing root trust certificate in the client system default certificate store is helpful since it can also be used by other applications and browsers in the client machine. If your company uses self-signed certificates, the root trust certificate may already be installed in all the client default trust stores.

Public certificate authority (CA): A CA-signed certificate is signed by a third-party, publicly trusted certificate authority (CA). Some examples of public certificate authorities are Symantec, DigiCert, Thawte, GeoTrust, GlobalSign, GoDaddy, and Entrust. These entities are responsible for validating the person or organization that requests each certificate.

Using a public root of trust certificate authority has some advantages in that the root trust certificate is most likely already stored in the client system default certificate store. There is no extra step for the client to store the root trust certificate if it is from a public certificate authority. The disadvantage is that this normally has a payment to a third party certificate authority.

21.1.2 One-way TLS vs Mutual TLS

Determine if one-way TLS or Mutual TLS (mTLS) is appropriate for your database configuration.

One-way TLS: One-way TLS is a server-verified encrypted channel using the TLS protocol. In the standard TLS session, only the server provides a certificate to the client to authenticate itself. The client doesn't need to have a separate client certificate to authenticate itself to the server (similar to how HTTPS sessions are established). While the database server requires a wallet to store the server user certificate and private key, the database client only needs to access the trusted CA root certificate to validate the server user certificate is signed by a trusted CA root certificate. Depending on the OS platform and the database client, the trusted CA root certificate could be in the local default certificate system store or in a client wallet. One-way TLS is the most common TLS configuration and detailed configuration steps can be found in [Configuring TLS Using a Public Certificate Authority Root of Trust for the Database Server Certificate](#).

Two-way TLS (also called Mutual TLS, mTLS): In mTLS, both the client and server present their user certificates to each other. In most cases, the same CA root certificate will have signed both of these certificates so the same root CA certificate can be used with the database server and client to authenticate the other certificate. mTLS when used in this manner is used to encrypt the link between the database and the client, and also validate both the database and the client's certificate. Database user authentication is done separately, for example, using a database username and password to authenticate the user in addition to establishing the mTLS encrypted link. A principal (human or application) can also use the client side user certificate as it's authentication mechanism. This is called PKI certificate authentication and is covered in [Configuring PKI Certificate Authentication](#). In this case, the user certificate does double duty - establish the mTLS connection and PKI certificate authentication to the database. For detailed configuration steps for mTLS see [Mutual Transport Layer Security \(mTLS\)](#).

21.1.3 TLS With or Without a Client Wallet

Determine if using a client wallet is appropriate for your database configuration.

Client with a wallet: When using mTLS, a client certificate is required. The client certificate must be stored in the client wallet or Microsoft Certificate Store (MCS) in Windows. The wallet must also store the trusted CA root certificate along with the required intermediate certificates.

Client without a wallet: Clients can be configured without a wallet when using TLS under these conditions:

1. One-way TLS is being configured where the client does not have its own certificate.
2. The root certificate that signed the database server certificate is stored in the system default certificate store. If the server certificate is signed by a public certificate authority, the root certificate will most likely already be there. If a self-signed certificate was used to sign the server certificate, this self-signed certificate would need to be installed in the system default certificate store to avoid using a client wallet.
3. This is only applicable to Linux and Windows clients. This works natively with Windows MCS and the native Linux keystore. On non-Windows and non-Linux OS clients, the OCI-C client will look for a PEM file stored in several locations described in [Oracle Wallet Search Order](#).

21.1.4 Certificate DN Matching

Determine if certificate DN matching is appropriate for your database configuration.

 **Tip:**

Oracle recommends using this option when configuring a TLS session.

The DN certificate match parameters are only used by the database client. When DN certificate match is enabled, the client checks information on the server certificate (common name (CN), distinguished name (DN), subject alternate names (SAN)) and compares it with the information in the connect string or `sqlnet.ora`. If there's a match, it means that the database server is the expected server that the client wanted to connect with. If there's no match, the client rejects the connection attempt since the server is not the intended server. Configuring TLS without checking for a partial or full DN match checks that the server certificate has not expired and has been signed by a known certificate authority. DN certificate match takes it one step further and makes sure the client is talking to the expected server. There are 2 sub-options for DN certificate match: Partial DN match and Full DN match.

- **Partial DN match:** In `SQLNET.ora` or in the connect string, specify `SSL_SERVER_DN_MATCH=YES`. Partial DN match will check the `HOST` parameter in the connect string to see if there's a match with the CN, DN, or SAN names. There has to be a match for the connection to be successful.
- **Full DN match:** In addition to setting `SSL_SERVER_DN_MATCH=YES`, you must also set `SSL_SERVER_CERT_DN=<certificate DN>` to force a full DN match. This allows you to continue to use DN certificate match when your `HOST` value needs to be an IP address or something other than the names available in the certificate.

21.2 Configuring TLS for the Oracle Database and Client

This topic describes the three most common TLS configurations. More advanced and optional configurations are described later in this chapter.

- [About Configuring TLS for the Oracle Database](#)
The three most common TLS configurations are described in detail in this topic.
- [Configuring TLS Using a Public Certificate Authority Root of Trust for the Database Server Certificate](#)
Before you can configure TLS without using client wallets, you must first create the server wallet and ensure that the database and listener are properly configured.
- [Configuring TLS with a Self-Signed Root Certificate](#)
Using a self-signed root certificate is very similar to the above use case, except you must create a root wallet and sign the database certificate with the self-signed root certificate.
- [Configuring TLS Connection With a Client Wallet](#)
A client wallet is sometimes required when configuring TLS with a public or self-signed CA trust certificate.
- [Enabling Distinguished Name \(DN\) Matching](#)
DN matching allows a connection to the Oracle Database server when the server certificate name or DN matches what the client expects.

21.2.1 About Configuring TLS for the Oracle Database

The three most common TLS configurations are described in detail in this topic.

The first decision is to use a self-signed certificate root of trust or a public CA root of trust. Once you make that decision, Oracle recommends using TLS without a wallet if your

environment supports this and is allowed by your security policies. This greatly simplifies managing database clients. Start your configurations with the minimum set of mandatory parameters. And then once you are successful, add the recommended parameters and any optional parameters one by one.

The following parameters are used in the following configurations in this topic.

Table 21-1 Mandatory and Recommended parameters to configure one-way TLS

Parameter	Description	Server (Defined in sqlnet. ora)	Listener (Defined in listene r.ora)	Static Client (Defined in sqlnet. ora)	Dynamic Client (Defined in the connect string)
WALLET_ROOT	Database server system parameter (replaces WALLET_LOCATION)	Required	No	No	No
WALLET_LOCATION	Specifies wallet location if required	No	Required	Optional	Optional
Protocol=tcps	Enables TLS connection	No	Required	No	Required
SSL_CLIENT_AUTHENTICATION	Disable to allow 1-way TLS	Required	Required	Optional	Optional
SSL_SERVER_DN_MATCH	Enables partial or full DN matching	No	No	Recommended	Recommended
SSL_SERVER_CERT_DN	Use if full DN matching is required	No	No	No	Optional

WALLET_ROOT and WALLET_LOCATION Parameters

For Oracle Database server, Oracle recommends that you use the `WALLET_ROOT` system parameter instead of using `WALLET_LOCATION`.

The parameter `WALLET_LOCATION` is deprecated for use with Oracle Database 23ai for the Oracle Database server. It is not deprecated for use with the Oracle Database client or listener. The TLS wallet location for a PDB is `WALLET_ROOT/<PDB_GUID>/tls`.

`WALLET_LOCATION` must be used by the listener to find its wallet. Oracle recommends using the same wallet for the listener and the server for DN matching. DN matching is used by the client to verify that it is connecting to the expected server, and the client checks both the listener and the server certificates.

Protocol Parameter

The `Protocol` must be set to `tcps` with the client and listener. The listener sets this as part of the service connect string. The client sets this in the connect string.

SSL_CLIENT_AUTHENTICATION Parameter

`SSL_CLIENT_AUTHENTICATION` must be set to `FALSE` for the database server and the listener to allow TLS traffic (vs mTLS) to connect to the listener and the server. This is optional for the client and depends if the client already has a wallet with a client-side user certificate that is used for other connections.

DN Matching

Oracle recommends using DN matching. However, add these settings once you have successfully confirmed a TLS connection.

The most common TLS configurations for the Oracle Database are:

- [Configuring TLS Using a Public Certificate Authority Root of Trust for the Database Server Certificate](#)
- [Configuring TLS with a Self-Signed Root Certificate](#)
- [Configuring TLS Connection With a Client Wallet](#)

21.2.2 Configuring TLS Using a Public Certificate Authority Root of Trust for the Database Server Certificate

Before you can configure TLS without using client wallets, you must first create the server wallet and ensure that the database and listener are properly configured.

Create the Server and Listener Wallet

To get a certificate signed by a publicly signed certificate authority, you must create the database server and listener wallet and export a certificate signing request (CSR).

1. Login to the host where the database is installed.
2. Create the wallet.

```
orapki wallet create -wallet <wallet location> -pwd <wallet password> -  
auto_login
```

3. Add the trusted root certificate to the wallet (get this from your certificate administrator).

```
orapki wallet add -wallet <wallet location> -trusted_cert -cert <trusted  
root certificate location>/rootCA.crt -pwd <wallet password>
```

4. Create a private key and certificate request in the wallet.

```
orapki wallet add -wallet <wallet location> -keysize 2048 -dn  
<certificate_dn> -pwd <wallet password>
```

5. Export the certificate request to get it signed.

```
orapki wallet export -wallet <wallet location> -dn <certificate_dn> -  
request <certificate signing request location>/<file_name>.csr -pwd  
<wallet password>
```

6. Display the contents of the wallet.

```
orapki wallet display -wallet <wallet_location>
```

There will be an entry under Requested Certificates.

7. View the contents of the CSR (certificate signing request) file.

```
cat <certificate_signing_request_location>/<file_name>.csr
```

8. Send the CSR file to your certificate administrator to have it signed by the root certificate authority (CA) or an intermediate CA.
9. Import the signed database server user certificate into the database wallet.

```
orapki wallet add -wallet <wallet_location> -user_cert -cert <signed_certificate_location>/<file_name_signed>.crt -pwd <wallet_password>
```

10. Display the contents of the wallet:

```
orapki wallet display -wallet <wallet_location>
```

11. Ensure that the database server user certificate is now displayed under User Certificates.

The wallet you will use for the database server and listener is now ready to be deployed for use.

Set `WALLET_ROOT` and deploy the database server wallet

1. Create a variable, `WALLET_DIR`, for the wallet directory location:

```
export WALLET_DIR = <wallet_root_directory>
```

2. Create `WALLET_ROOT`, a system parameter. Run the following SQL command:

```
alter system set wallet_root = '${WALLET_DIR}' scope= spfile;
```

3. Reboot the database.
4. Show the modified `wallet_root` parameter. Run the following SQL command:

```
show parameter wallet_root;
```

5. Create a directory for TLS under your `WALLET_ROOT` PDB directory in the operating system.

```
mkdir -p -v $WALLET_DIR/<PDB_GUID>/tls
```

You can find the PDB GUID for your PDB by running the following SQL command:

```
select guid from v\containers;
```

6. Change ownership of the directory.

```
sudo chown oracle:oinstall -R -v WALLET_ROOT/<PDB_GUID>/tls
```

7. Copy the database server `ewallet.p12` and the `cwallet.sso` files to this new `tls` directory.

Perform this command from the same directory where the wallets were created:

```
cp ./ewallet.p12 ./cwallet.sso $WALLET_DIR/<PDB_GUID>/tls
```

Database server configuration for TLS

1. Log in to the server where the Oracle database resides.
2. Check that `SSL_CLIENT_AUTHENTICATION` in the `sqlnet.ora` file is set to `FALSE` as this enables one-way TLS:

By default, the `sqlnet.ora` file is located in the `$ORACLE_HOME/dbs` directory or in the location set by the `TNS_ADMIN` environment variable.

```
SSL_CLIENT_AUTHENTICATION=FALSE
```

You may set this to `OPTIONAL` instead which enables both TLS and mTLS and is dependent on whether the client sends the client user certificate.

Listener configuration for TLS

1. Check the `PROTOCOL` parameter in the `listener.ora` file to ensure TLS is specified. By default, `listener.ora` is located in the `$ORACLE_HOME/network/admin` directory.

The parameter `PROTOCOL=tcps` tells the listener to only use TLS (or mTLS) for database connections.

For example:

```
LISTENER = (ADDRESS=(PROTOCOL=tcps) (HOST=<host_name>) (PORT=1522))
```

2. Ensure that the listener wallet exists in the location of the `WALLET_LOCATION` parameter in the `listener.ora` file. Use the same wallet as you did for the database server.

```
WALLET_LOCATION=
  (SOURCE=
    (METHOD=file)
    (METHOD_DATA=
      (DIRECTORY=$WALLET_DIR/<pdb_guid>/tls)))
```

If the listener is on the same server as the database server and the server TLS wallet is in the default location, set the listener `WALLET_LOCATION` to the same location. Alternatively, the server wallet can be copied to a different location for the listener.

If you set the `SSL_SERVER_DN_MATCH` parameter to `TRUE` for DN matching (partial or full DN match), then the hostname or DN check will happen against both the listener certificate and the server certificate. They don't have to be the same certificate, but matching will be done with both certificates.

3. Ensure the `SSL_CLIENT_AUTHENTICATION` parameter is set to `FALSE` in `listener.ora` file to disable mutual TLS.

```
SSL_CLIENT_AUTHENTICATION=FALSE
```

 **Note:**

If the listener supports multiple databases, some with one-way TLS and some with mTLS, then set `SSL_CLIENT_AUTHENTICATION=OPTIONAL`.

Client Configuration for TLS

Configure Client Connect String for TLS

Add the parameter `protocol=tcps` in the connect string to enforce TLS from the client. The connection will use TLS from the client to the listener.

 **Note:**

This parameter is not available in `sqlnet.ora`.

```
(description=
  (address=
    (protocol=tcps)
    (port=1521)
    (host=example.com))
  (connect_data=
    (service_name=dbservicename.example.com)))
```

(Optional) Set `SSL_CLIENT_AUTHENTICATION` for the Client

- If you have a client-side user certificate, but don't want to use it for mTLS, then you must complete this step.
 - If you don't have a client-side user certificate, you can skip this step as the client will go ahead and make a one-way TLS connection regardless of this parameter setting.
1. Log in to the client for the Oracle database.
 2. Set `SSL_CLIENT_AUTHENTICATION` in the `sqlnet.ora` file to `FALSE`.

```
SSL_CLIENT_AUTHENTICATION=FALSE
```

Setting this parameter in `sqlnet.ora` to `FALSE`, will block sending a client side user certificate for all the connections. You can override this for a particular connection by setting `SSL_CLIENT_AUTHENTICATION=TRUE` in the connection string in `tnsnames.ora` so that connection will use the client-side user certificate.

The connection string parameter will take precedence over the `sqlnet.ora` parameter setting. This setting is optional and only required if you have a client-side user certificate and you don't want to use it for an mTLS connection.

3. In order to preserve existing mTLS connections that use the client-side wallet and user certificate and also to establish one-way TLS connection without using the user certificate, set `SSL_CLIENT_AUTHENTICATION=TRUE`, which is the default setting, in `sqlnet.ora`. Then for every connection that you want to use without a client-side user wallet, add `SSL_CLIENT_AUTHENTICATION=FALSE` in the connect string.

Connect to the database

Connect to the database using the connection name with the tcps protocol.

```
sqlplus <user_name>@<PDB_name>
```

Verify the connection

1. Run the following command:

```
select sys_context ('userenv','NETWORK_PROTOCOL') from dual;
```

This will show 'tcps' if TLS is enabled and 'tcp' if TLS is not enabled.

2. Run the following command:

```
select sys_context ('userenv','TLS_VERSION') from dual;
```

This will show the TLS protocol for the connection ending at the database server.

3. Run the following command:

```
select sys_context ('userenv','TLS_CIPHERSUITE') from dual;
```

This will show the TLS ciphersuite for the connection ending at the database server.

21.2.3 Configuring TLS with a Self-Signed Root Certificate

Using a self-signed root certificate is very similar to the above use case, except you must create a root wallet and sign the database certificate with the self-signed root certificate.

Create the Root Wallet

1. Create the root wallet:

```
orapki wallet create -wallet <root wallet directory> -pwd <root wallet password> -auto_login
```

2. View the contents of the wallet, it should be empty:

```
orapki wallet display -wallet <root wallet directory>
```

3. Create the self-signed certificate for the root CA wallet:

```
orapki wallet add -wallet <root wallet directory> -dn <certificate_DN> -keysize 2048 -sign_alg sha256 -self_signed -validity 365 -pwd <root wallet password>
```

4. The directory should now have cwallet.sso and ewallet.p12 files:

```
ls -l <root wallet directory>
```

5. View the contents of the wallet, it should have a user and a trusted certificate:

```
orapki wallet display -wallet <root wallet directory>
```

6. Export the root CA trusted certificate for use in creating the DB wallet:

```
orapki wallet export -wallet <root wallet directory> -dn <certificate_DN> -  
cert <root wallet directory>/rootCA.crt -pwd <root wallet password>
```

7. View the contents of the rootCA.crt file:

```
cat <root wallet directory>/rootCA.crt
```

Create the Server and Listener Wallet

To get a certificate signed by the self-signed root certificate, follow the same steps as in the prior use case, where you create the wallets and export a certificate signing request (CSR).

1. Login to the host where the database is installed.
2. Create the wallet.

```
orapki wallet create -wallet <wallet location> -pwd <wallet password> -  
auto_login
```

3. Add the trusted root certificate to the wallet (get this from your certificate administrator).

```
orapki wallet add -wallet <wallet location> -trusted_cert -cert <trusted  
root certificate location>/rootCA.crt -pwd <wallet password>
```

4. Create a private key and certificate request in the wallet.

```
orapki wallet add -wallet <wallet location> -keysize 2048 -dn  
<certificate_dn> -pwd <wallet password>
```

5. Export the certificate request to get it signed.

```
orapki wallet export -wallet <wallet location> -dn <certificate_dn> -  
request <certificate signing request location>/<file_name>.csr -pwd  
<wallet password>
```

6. Display the contents of the wallet.

```
orapki wallet display -wallet <wallet_location>
```

There will be an entry under Requested Certificates.

7. View the contents of the CSR (certificate signing request) file.

```
cat <certificate_signing_request_location>/<file_name>.csr
```

Sign the database server certificate signing request (CSR) file

1. Sign the CSR using the self-signed root wallet:

```
orapki cert create -wallet <root wallet directory> -request <CSR
directory>/example.csr -cert <wallet location>/example-signed.crt -
validity 365 -sign_alg sha256 -pwd <root wallet password>
```

2. View the signed server user certificate:

```
cat <wallet location>/example-signed.crt
```

3. Import the signed database server user certificate into the database wallet.

```
orapki wallet add -wallet <wallet location> -user_cert -cert <signed
certificate location>/<file_name_signed>.crt -pwd <wallet password>
```

4. Display the contents of the wallet:

```
orapki wallet display -wallet <wallet location>
```

5. Ensure that the database server user certificate is now displayed under User Certificates.

The wallet you will use for the database server and listener is now ready to be deployed for use.

Set `WALLET_ROOT` and deploy the database server wallet

1. Create a variable, `WALLET_DIR`, for the wallet directory location:

```
export WALLET_DIR = <wallet_root_directory>
```

2. Create `WALLET_ROOT`, a system parameter. Run the following SQL command:

```
alter system set wallet_root = '${WALLET_DIR}' scope= spfile;
```

3. Reboot the database.

4. Show the modified `wallet_root` parameter. Run the following SQL command:

```
show parameter wallet_root;
```

5. Create a directory for TLS under your `WALLET_ROOT` PDB directory in the operating system.

```
mkdir -p -v $WALLET_DIR/<PDB GUID>/tls
```

You can find the PDB GUID for your PDB by running the following SQL command:

```
select guid from v\containers;
```

6. Change ownership of the directory.

```
sudo chown oracle:oinstall -R -v WALLET_ROOT/<PDB GUID>/tls
```

7. Copy the database server ewallet.p12 and the cwallet.sso files to this new tls directory.
Perform this command from the same directory where the wallets were created:

```
cp ./ewallet.p12 ./cwallet.sso $WALLET_DIR/<PDB GUID>/tls
```

Database server configuration for TLS

1. Log in to the server where the Oracle database resides.
2. Check that `SSL_CLIENT_AUTHENTICATION` in the `sqlnet.ora` file is set to `FALSE` as this enables one-way TLS:

By default, the `sqlnet.ora` file is located in the `$ORACLE_HOME/dbs` directory or in the location set by the `TNS_ADMIN` environment variable.

```
SSL_CLIENT_AUTHENTICATION=FALSE
```

You may set this to `OPTIONAL` instead which enables both TLS and mTLS and is dependent on whether the client sends the client user certificate.

Listener configuration for TLS

1. Check the `PROTOCOL` parameter in the `listener.ora` file to ensure TLS is specified.

By default, `listener.ora` is located in the `$ORACLE_HOME/network/admin` directory.

The parameter `PROTOCOL=tcps` tells the listener to only use TLS (or mTLS) for database connections.

For example:

```
LISTENER = (ADDRESS=(PROTOCOL=tcps) (HOST=<host_name>) (PORT=1522))
```

2. Ensure that the listener wallet exists in the location of the `WALLET_LOCATION` parameter in the `listener.ora` file. Use the same wallet as you did for the database server.

```
WALLET_LOCATION=
(SOURCE=
(METHOD=file)
(METHOD_DATA=
(DIRECTORY=$WALLET_DIR/<pdb_guid>/tls)))
```

If the listener is on the same server as the database server and the server TLS wallet is in the default location, set the listener `WALLET_LOCATION` to the same location. Alternatively, the server wallet can be copied to a different location for the listener.

If you set the `SSL_SERVER_DN_MATCH` parameter to `TRUE` for DN matching (partial or full DN match), then the hostname or DN check will happen against both the listener certificate and the server certificate. They don't have to be the same certificate, but matching will be done with both certificates.

3. Ensure the `SSL_CLIENT_AUTHENTICATION` parameter is set to `FALSE` in `listener.ora` file to disable mutual TLS.

```
SSL_CLIENT_AUTHENTICATION=FALSE
```

 **Note:**

If the listener supports multiple databases, some with one-way TLS and some with mTLS, then set `SSL_CLIENT_AUTHENTICATION=OPTIONAL`.

Client Configuration for TLS

Add the self-signed trusted root certificate to the client system default keystore

On the database client operating systems, you need to add the self-signed trusted root certificate to the client system's default keystore. If your company is using a corporate self-signed trusted root certificate, this may already be done for you. The Oracle Database thick clients (OCI-C) work natively with the Windows and Linux system default stores. On other operating systems, the Oracle Database client will search the directory locations listed below for a PEM file. If your PEM file for your OS is in a different location, you can either copy the PEM file to one of the searched locations or create a symlink to a searched location. Follow the directions for your OS to add the new trust certificate to your system certificate store (PEM file). We include the directions for doing that for Microsoft Windows and RHEL/Oracle Linux.

1. Export the root CA trusted certificate from the root wallet.

```
orapki wallet export -wallet <root wallet location> -dn <certificate_DN> -cert <root wallet location>/rootCA.crt -pwd <root wallet password>
```

2. Append the exported database trust certificate to the system's default certificate store.
 - For Windows, use the Microsoft Management Console (mmc) to import the trusted root certificate to the Microsoft Certificate Store (MCS)
 - For RHEL/Oracle Linux, the default system store is at `/etc/pki/tls/cert.pem`. To import the new root certificate to this PEM file, do the following:

- a. Add your new certificate to: `/etc/pki/ca-trust/source/anchors/`

- b. Run the following:

```
sudo update-ca-trust extract
```

- c. Delete the standalone root certificate:

```
rm -v <root wallet location>/rootCA.crt
```

- For the remaining Linux operating systems, the PEM file can be found at:
 - RHEL/Oracle Linux: `/etc/pki/tls/cert.pem`
 - Debian/Ubuntu/Gentoo: `/etc/ssl/certs/ca-certificates.crt`
 - Fedora/RHEL: `/etc/pki/tls/certs/ca-bundle.crt`
 - OpenSUSE: `/etc/ssl/ca-bundle.pem`

- OpenELEC: /etc/pki/tls/cacert.pem
- CentOS/RHEL7: /etc/pki/ca-trust/extracted/pem/tls-ca-bundle.pem
- Alpine Linux: /etc/ssl/cert.pem

Follow your OS instructions for adding a new certificate to your existing PEM file.

- For non-Linux and non-Windows systems, if the PEM file is not in one of the locations listed above for Linux systems, then you must either copy the PEM file to one of these default Linux locations or create a symlink from the PEM file to one of these locations. The file must be a PEM file.

 **Note:**

You cannot change the default location of the certificate store.

Configure Client Connect String for TLS

Add the parameter `protocol=tcps` in the connect string to enforce TLS from the client. The connection will use TLS from the client to the listener.

 **Note:**

This parameter is not available in `sqlnet.ora`.

```
(description=
  (address=
    (protocol=tcps)
    (port=1521)
    (host=example.com))
  (connect_data=
    (service_name=dbservicename.example.com)))
```

(Optional) Set `SSL_CLIENT_AUTHENTICATION` for the Client

- If you have a client-side user certificate, but don't want to use it for mTLS, then you must complete this step.
 - If you don't have a client-side user certificate, you can skip this step as the client will go ahead and make a one-way TLS connection regardless of this parameter setting.
1. Log in to the client for the Oracle database.
 2. Set `SSL_CLIENT_AUTHENTICATION` in the `sqlnet.ora` file to `FALSE`.

```
SSL_CLIENT_AUTHENTICATION=FALSE
```

Setting this parameter in `sqlnet.ora` to `FALSE`, will block sending a client side user certificate for all the connections. You can override this for a particular connection by setting `SSL_CLIENT_AUTHENTICATION=TRUE` in the connection string in `tnsnames.ora` so that connection will use the client-side user certificate.

The connection string parameter will take precedence over the `sqlnet.ora` parameter setting. This setting is optional and only required if you have a client-side user certificate and you don't want to use it for an mTLS connection.

3. In order to preserve existing mTLS connections that use the client-side wallet and user certificate and also to establish one-way TLS connection without using the user certificate, set `SSL_CLIENT_AUTHENTICATION=TRUE`, which is the default setting, in `sqlnet.ora`. Then for every connection that you want to use without a client-side user wallet, add `SSL_CLIENT_AUTHENTICATION=FALSE` in the connect string.

Connect to the database

Connect to the database using the connection name with the `tcps` protocol.

```
sqlplus <user_name>@<PDB_name>
```

Verify the connection

1. Run the following command:

```
select sys_context ('userenv','NETWORK_PROTOCOL') from dual;
```

This will show 'tcps' if TLS is enabled and 'tcp' if TLS is not enabled.

2. Run the following command:

```
select sys_context ('userenv','TLS_VERSION') from dual;
```

This will show the TLS protocol for the connection ending at the database server.

3. Run the following command:

```
select sys_context ('userenv','TLS_CIPHERSUITE') from dual;
```

This will show the TLS ciphersuite for the connection ending at the database server.

21.2.4 Configuring TLS Connection With a Client Wallet

A client wallet is sometimes required when configuring TLS with a public or self-signed CA trust certificate.

A client wallet for a TLS connection includes the trust certificate for the certificate authority that signed the database server certificate. Only the root of trust certificate is required. Intermediate certificates are not required.

Using a client wallet is required if you cannot use the system's default certificate store.

1. Create the client wallet.

```
orapki wallet create -wallet <wallet_location> -pwd <wallet_password> -  
auto_login
```

2. Get the CA trusted certificate. This may already be available in a file or you may need to export it from the root certificate wallet or a database server wallet.

```
orapki wallet export -wallet <wallet_location> -dn <certificate_dn> -cert  
<certificate_filename>
```

For more information see [orapki Utility Commands Summary](#).

3. Add the CA trusted certificate into the client wallet.

```
orapki wallet add -wallet <wallet_location> -trusted_cert -cert  
<certificate_filename>
```

4. Move or copy the client wallet to the desired location.
5. Update `sqlnet.ora` to add `WALLET_LOCATION` for the client wallet.

This will be used by all client connections unless this is overridden by the connect string parameter `WALLET_LOCATION`. When `WALLET_LOCATION` is not set in `sqlnet.ora` or the connect string, then the client will check the system's default certificate store.

```
WALLET_LOCATION=  
  (SOURCE=  
    (METHOD=file)  
    (METHOD_DATA=  
      (DIRECTORY=/etc/oracle/wallets/databases)))
```

See [WALLET_LOCATION](#) in the *Oracle Database Net Services Reference* guide for more information.

(Optional) Set `SSL_CLIENT_AUTHENTICATON` for the Client

- If you have a client-side user certificate, but don't want to use it for mTLS, then you must complete this step.
 - If you don't have a client-side user certificate, you can skip this step as the client will go ahead and make a one-way TLS connection regardless of this parameter setting.
1. Log in to the client for the Oracle database.
 2. Set `SSL_CLIENT_AUTHENTICATION` in the `sqlnet.ora` file to `FALSE`.

```
SSL_CLIENT_AUTHENTICATION=FALSE
```

Setting this parameter in `sqlnet.ora` to `FALSE`, will block sending a client side user certificate for all the connections. You can override this for a particular connection by setting `SSL_CLIENT_AUTHENTICATION=TRUE` in the connection string in `tnsnames.ora` so that connection will use the client-side user certificate.

The connection string parameter will take precedence over the `sqlnet.ora` parameter setting. This setting is optional and only required if you have a client-side user certificate and you don't want to use it for an mTLS connection.

3. In order to preserve existing mTLS connections that use the client-side wallet and user certificate and also to establish one-way TLS connection without using the user certificate, set `SSL_CLIENT_AUTHENTICATION=TRUE`, which is the default setting, in `sqlnet.ora`. Then

for every connection that you want to use without a client-side user wallet, add `SSL_CLIENT_AUTHENTICATION=FALSE` in the connect string.

Connect to the database

Connect to the database using the connection name with the `tcps` protocol.

```
sqlplus <user_name>@<PDB_name>
```

Verify the connection

1. Run the following command:

```
select sys_context ('userenv','NETWORK_PROTOCOL') from dual;
```

This will show `'tcps'` if TLS is enabled and `'tcp'` if TLS is not enabled.

2. Run the following command:

```
select sys_context ('userenv','TLS_VERSION') from dual;
```

This will show the TLS protocol for the connection ending at the database server.

3. Run the following command:

```
select sys_context ('userenv','TLS_CIPHERSUITE') from dual;
```

This will show the TLS ciphersuite for the connection ending at the database server.

21.2.5 Enabling Distinguished Name (DN) Matching

DN matching allows a connection to the Oracle Database server when the server certificate name or DN matches what the client expects.

Tip:

Oracle strongly recommends using either partial or full DN matching so the client connects to the correct host.

When DN matching is enabled, the listener certificate and the database server certificate will both be checked against the certificate expected by the client. Without using DN matching, any server certificate signed by the same or valid public CA will be accepted by the client to establish the TLS session.

It is recommended to first successfully configure TLS in a test environment prior to setting up DN matching. See [Configuring TLS Using a Public Certificate Authority Root of Trust for the Database Server Certificate](#).

To enable DN Matching:

1. Set the `SSL_SERVER_DN_MATCH` parameter to `TRUE` in the `sqlnet.ora` file:

```
SSL_SERVER_DN_MATCH = TRUE
```

The `sqlnet.ora` file will look similar to:

```
SSL_CLIENT_AUTHENTICATION = FALSE
WALLET_LOCATION =
  (SOURCE=
   (METHOD=File)
   (METHOD_DATA=
    (DIRECTORY=wallet_location)))
SSL_SERVER_DN_MATCH = TRUE
```

 **Note:**

Only completing this step will result in partial DN matching. Perform step three to establish full DN matching.

Partial DN matching will check the host parameter value in the connect string against the certificate's common name (CN). If a match isn't found, the client will then compare the host parameter value against the entries in the certificate's Subject Alternate Name (SAN) field. If there are no matches, the connection will be refused.

2. Check the host name parameter in the connect string in `tnsnames.ora` against the common name (CN) of the certificate DN string and the hostnames listed in the Subject Alternate Name (SAN) field. The connect string host name needs to match for partial DN match to succeed.
The `tnsnames.ora` file can be located on the client or in the LDAP directory. The `tnsnames.ora` file is typically located in the setting specified by the `TNS_ADMIN` environment variable. If `TNS_ADMIN` is not set, then `tnsnames.ora` resides in the following directory locations:

- Linux:

```
$ORACLE_HOME/network/admin/
```

- Windows:

```
ORACLE_BASE\ORACLE_HOME\network\admin\
```

3. If you can't use partial DN matching, then configure full DN matching by setting the `SSL_SERVER_CERT_DN` parameter connection string in the `tnsnames.ora` file:

 **Note:**

If you can't set the host value in `tnsnames.ora` or `sqlnet.ora` to the value of the certificate common name (CN) or one of the entries in the SAN field, then consider using full DN matching.

Both the listener and server certificate will be checked with both partial and full DN matching. When using full DN matching, while the server and listener certificate can be different, their DN must be the same for the connection to succeed.

The `tnsnames.ora` file will look similar to:

```
finance=
(DESCRIPTION=
  (ADDRESS_LIST=
    (ADDRESS=(PROTOCOL = tcps)(HOST = finance)
      (PORT = 1575)))
  (CONNECT_DATA=
    (SERVICE_NAME= finance.us.example.com))
  (SECURITY=
    (SSL_SERVER_DN_MATCH = TRUE)
    (SSL_SERVER_CERT_DN="cn=finance,cn=OracleContext,c=us,o=example")))
```

21.3 Advanced and Optional Configurations

Oracle Database 23ai ensures that the default Transport Layer Security configuration is secure and versatile. However, Oracle provides parameters to customize and control this configuration.

 **Note:**

To ensure secure configuration, Oracle recommends that only mandatory and recommended parameters are configured in your environment. When the Oracle Database client and server are configuring a connection, the most secure protocol and cipher suite that is common to both the server and client are selected. Selecting a TLS protocol or cipher suite will block clients that are unable to use that protocol or cipher suite. These configurations need to be checked during database updates and upgrades to make sure the selected values are supported after the database upgrade or update.

- [Optional Parameters for Transport Layer Security](#)
The server-side TLS configuration is applicable to all connections serviced by the server. These are specified in the server-side configuration files `sqlnet.ora` for the Database server and `listener.ora` for the Database listener.
- [Mutual Transport Layer Security \(mTLS\)](#)
In traditional Transport Layer Security (TLS), only the server authenticates to the client by presenting its certificate. With mutual Transport Layer Security (mTLS), both the server and the client present their certificates so that they are mutually authenticated.

- **Oracle Wallet Location**
Certificates used for TLS are stored in the Oracle wallet. There are several default locations where the wallet can be placed. The location of the wallet can also be configured with the wallet location parameters on the client and listener. The `WALLET_ROOT` system parameter should be used for the database server wallet location.
- **Enable Weak DN Matching**
The `SSL_ALLOW_WEAK_DN_MATCH` parameter control reverts the DN matching behavior to prior database versions.
- **Private Key/Certificate Selection**
You can have multiple private key/certificate pairs stored in either the Oracle wallet or a system certificate store to use for certificates. This is sometimes necessary when different databases will assign different client credentials for mTLS, such as for Autonomous Database.
- **Transport Layer Security Encryption Combined with Authentication Methods**
You can configure Oracle Database to use TLS concurrently with database user names and passwords, RADIUS, and Kerberos.
- **Specifying TLS Protocol and TLS Cipher Suites**
Oracle Database 23ai supports TLS protocol versions 1.2 and 1.3 and their associated cipher suites for Transport Layer Security (TLS).
- **Certificate Validation with Certificate Revocation Lists**
Oracle provides tools that enable you to validate certificates using certificate revocation lists.

21.3.1 Optional Parameters for Transport Layer Security

The server-side TLS configuration is applicable to all connections serviced by the server. These are specified in the server-side configuration files `sqlnet.ora` for the Database server and `listener.ora` for the Database listener.

The client-side TLS configuration can be connection-specific or applied to all connections via `sqlnet.ora`. There are two ways to configure a Transport Layer Security (TLS) parameter for clients.

- **Static:** these are parameters specified in the configuration file `sqlnet.ora` and uniformly applied to all connections made by the client.
- **Dynamic:** If desired, certain TLS parameters may be specified directly in the TNS connect string to override the same or similar parameter in `sqlnet.ora`.

Table 21-2 General TLS Parameters

Parameter	Description	Server	Listener	Static Client	Dynamic Client
<code>HTTPS_CLIENT_AUTHENTICATION</code>	Specifies whether a client is authenticated using TLS for HTTPS connections	Yes	Yes	Yes	Yes
<code>SSL_CLIENT_AUTHENTICATION</code>	Specifies whether a client is authenticated using TLS or mTLS	Yes	Yes	Yes	Yes
<code>WALLET_LOCATION</code>	Specify the TLS wallet location.	Yes*	Yes	Yes	Yes

*The parameter `WALLET_LOCATION` is deprecated for use with Oracle Database 23ai for the Oracle Database server. It is not deprecated for use with the Oracle Database client or listener.

For Oracle Database server, Oracle recommends that you use the `WALLET_ROOT` system parameter instead of using `WALLET_LOCATION`.

Table 21-3 TLS Parameters For Selecting User Certificate

Parameter	Description	Server	Listener	Static Client	Dynamic Client
<code>SSL_CERTIFICATE_ALIAS</code>	Specifies the certificate based on its alias.	Yes	Yes	Yes	Yes
<code>SSL_EXTENDED_KEY_USAGE</code>	Specifies the certificate based on its key usage value.	Yes	Yes	Yes	Yes
<code>SSL_CERTIFICATE_THUMBPRINT</code>	Specifies the certificate based on its thumbprint.	Yes	Yes	Yes	Yes



Note:

Selecting a client-side user certificate is only applicable when working with user certificates in Windows MCS and in Oracle wallets.

Table 21-4 TLS Certificate DN Matching Parameters

Parameter	Description	Server	Listener	Static Client	Dynamic Client
<code>SSL_ALLOW_WEAK_DN_MATCH</code>	Allows the earlier weaker distinguished name (DN) matching behavior during server-side certificate validation	No	No	Yes	Yes
<code>SSL_SERVER_CERT_DN</code>	Specifies the distinguished name (DN) of the database server	No	No	No	Yes
<code>SSL_SERVER_DN_MATCH</code>	Enforces client-side validation of server through distinguished name (DN) matching	No	No	Yes	Yes

Table 21-5 TLS Protocol and Cipher Suite Selection Parameters

Parameter	Description	Server	Listener	Static Client	Dynamic Client
<code>SSL_CIPHER_SUITES</code>	Specifies the TLS cipher suites allowed for TLS connections	Yes	Yes	Yes	Yes
<code>SSL_ENABLE_WEAK_CIPHERS</code>	Enables deprecated TLS cipher suites	Yes	Yes	Yes	Yes
<code>SSL_VERSION</code>	Specifies the TLS protocol to use in a connection	Yes	Yes	Yes	Yes

21.3.2 Mutual Transport Layer Security (mTLS)

In traditional Transport Layer Security (TLS), only the server authenticates to the client by presenting its certificate. With mutual Transport Layer Security (mTLS), both the server and the client present their certificates so that they are mutually authenticated.

The `SSL_CLIENT_AUTHENTICATION` parameter controls whether the client certificate needs to be authenticated. This doesn't authenticate or authorize the end user. It authenticates that the certificates used by both the server and client are valid and signed by a known certificate authority (CA). [Configuring PKI Certificate Authentication](#) goes into detail about end-user authentication using PKI certificates.

The default for `SSL_CLIENT_AUTHENTICATION` is `TRUE` for the database server, listener, and client, which will require mTLS (mutual TLS requiring a client certificate in a client wallet). Settings are as follows:

- `OFF/FALSE` disables mTLS, which enables one-way TLS.
- `ON/TRUE` enables mTLS. If it is set to `On/TRUE` on the server, one-way TLS will be disabled. If it is set to `On/TRUE` on the client, the client will try to establish mTLS; however, one-way TLS is still allowed if the server is configured with one-way TLS.
- `OPTIONAL`, server-only configuration value, enables the server to behave as follows:
 - If the client sends a certificate, the connection will be completed as an mTLS connection after the client certificate is authenticated.
 - If the client does not send a certificate, then the connection will be completed as a one-way TLS connection.
- [Server Certificate DN Matching](#)
Oracle recommends using Server certificate DN matching, similar to using server DN matching with one-way TLS, to ensure the client is connecting to the intended server.

Create the Server and Listener Wallet

To get a certificate signed by a publicly signed certificate authority, you must create the database server and listener wallet and export a certificate signing request (CSR).

1. Login to the host where the database is installed.
2. Create the wallet.

```
orapki wallet create -wallet <wallet location> -pwd <wallet password> -  
auto_login
```

3. Add the trusted root certificate to the wallet (get this from your certificate administrator).

```
orapki wallet add -wallet <wallet location> -trusted_cert -cert <trusted  
root certificate location>/rootCA.crt -pwd <wallet password>
```

4. Create a private key and certificate request in the wallet.

```
orapki wallet add -wallet <wallet location> -keysize 2048 -dn  
<certificate_dn> -pwd <wallet password>
```

5. Export the certificate request to get it signed.

```
orapki wallet export -wallet <wallet_location> -dn <certificate_dn> -  
request <certificate_signing_request_location>/<file_name>.csr -pwd  
<wallet_password>
```

6. Display the contents of the wallet.

```
orapki wallet display -wallet <wallet_location>
```

There will be an entry under Requested Certificates.

7. View the contents of the CSR (certificate signing request) file.

```
cat <certificate_signing_request_location>/<file_name>.csr
```

8. Send the CSR file to your certificate administrator to have it signed by the root certificate authority (CA) or an intermediate CA.

9. Import the signed database server user certificate into the database wallet.

```
orapki wallet add -wallet <wallet_location> -user_cert -cert <signed  
certificate_location>/<file_name_signed>.crt -pwd <wallet_password>
```

10. Display the contents of the wallet:

```
orapki wallet display -wallet <wallet_location>
```

11. Ensure that the database server user certificate is now displayed under User Certificates.

The wallet you will use for the database server and listener is now ready to be deployed for use.

Set `WALLET_ROOT` and deploy the database server wallet

1. Create a variable, `WALLET_DIR`, for the wallet directory location:

```
export WALLET_DIR = <wallet_root_directory>
```

2. Create `WALLET_ROOT`, a system parameter. Run the following SQL command:

```
alter system set wallet_root = '${WALLET_DIR}' scope= spfile;
```

3. Reboot the database.

4. Show the modified `wallet_root` parameter. Run the following SQL command:

```
show parameter wallet_root;
```

5. Create a directory for TLS under your `WALLET_ROOT` PDB directory in the operating system.

```
mkdir -p -v $WALLET_DIR/<PDB_GUID>/tls
```

You can find the PDB GUID for your PDB by running the following SQL command:

```
select guid from v\containers;
```

6. Change ownership of the directory.

```
sudo chown oracle:oinstall -R -v WALLET_ROOT/<PDB GUID>/tls
```

7. Copy the database server ewallet.p12 and the cwallet.sso files to this new tls directory.
Perform this command from the same directory where the wallets were created:

```
cp ./ewallet.p12 ./cwallet.sso $WALLET_DIR/<PDB GUID>/tls
```

Database server configuration for mTLS

1. Log in to the server where the Oracle database resides.
2. Check that `SSL_CLIENT_AUTHENTICATION` in the `sqlnet.ora` file is set to `TRUE` as this enables mTLS:

By default, the `sqlnet.ora` file is located in the `$ORACLE_HOME/dbs` directory or in the location set by the `TNS_ADMIN` environment variable.

```
SSL_CLIENT_AUTHENTICATION=TRUE
```

You may set this to `OPTIONAL` instead which enables both TLS and mTLS and is dependent on whether the client sends the client user certificate.

Listener configuration for mTLS

1. Check the `PROTOCOL` parameter in the `listener.ora` file to ensure TLS is specified.
By default, `listener.ora` is located in the `$ORACLE_HOME/network/admin` directory.
The parameter `PROTOCOL=tcps` tells the listener to only use TLS (or mTLS) for database connections.

For example:

```
LISTENER = (ADDRESS=(PROTOCOL=tcps) (HOST=<host_name>) (PORT=1522))
```

2. Ensure that the listener wallet exists in the location of the `WALLET_LOCATION` parameter in the `listener.ora` file. Use the same wallet as you did for the database server.

```
WALLET_LOCATION=
  (SOURCE=
    (METHOD=file)
    (METHOD_DATA=
      (DIRECTORY=$WALLET_DIR/<pdb guid>/tls)))
```

If the listener is on the same server as the database server and the server TLS wallet is in the default location, set the listener `WALLET_LOCATION` to the same location. Alternatively, the server wallet can be copied to a different location for the listener.

If you set the `SSL_SERVER_DN_MATCH` parameter to `TRUE` for DN matching (partial or full DN match), then the hostname or DN check will happen against both the listener certificate and the server certificate. They don't have to be the same certificate, but matching will be done with both certificates.

3. Ensure the `SSL_CLIENT_AUTHENTICATION` parameter is set to `TRUE` in `listener.ora` file to enable mutual TLS.

```
SSL_CLIENT_AUTHENTICATION=TRUE
```

Client Configuration for mTLS

1. Log in to the client for the Oracle database.
2. Set `SSL_CLIENT_AUTHENTICATION` in the `sqlnet.ora` and `tnsnames.ora` files to `TRUE`.

A setting of `TRUE`, will send a client side user certificate to the server. Because this applies to every connection, you can change the `SSL_CLIENT_AUTHENTICATION` parameter in the `tnsnames.ora` connection string using the same parameter setting which will take precedence over the `sqlnet.ora` setting.

```
SSL_CLIENT_AUTHENTICATION=TRUE
```

Tip:

While the default value for this parameter is true, setting it explicitly to true will make troubleshooting connection problems easier.

3. If you connect to multiple databases and some require mTLS and the other TLS connections don't need a wallet, then you have two options for setting different connections depending if you have a common wallet to connect with the different databases or if each mTLS connection requires a different wallet:

- [With a Common Client Wallet](#)
- [Without a Common Client Wallet](#)

With a Common Client Wallet

- a. Specify a common mTLS client wallet by setting `WALLET_LOCATION` in `sqlnet.ora`. This will result in every mTLS connection using the same client wallet to connect with their database.
- b. In the connection string for one-way TLS connections,
 - i. Set `SSL_CLIENT_AUTHENTICATION = FALSE` to override the mTLS client wallet setting.
 - ii. Set `WALLET_LOCATION = SYSTEM` to specify the system default certificate store.

Without a Common Client Wallet

This can be used if you need to use a different client wallet for each database connection.

- a. Set `WALLET_LOCATION = SYSTEM` in `sqlnet.ora` to allow the TLS connections to connect without using a wallet.
- b. Set the `WALLET_LOCATION` for every mTLS connection to specify the unique wallet location for each connection.

Related Topics

- [Oracle Wallet Location](#)
Certificates used for TLS are stored in the Oracle wallet. There are several default locations where the wallet can be placed. The location of the wallet can also be configured with the wallet location parameters on the client and listener. The `WALLET_ROOT` system parameter should be used for the database server wallet location.

Connect to the database

Connect to the database using the connection name with the `tcps` protocol.

```
sqlplus <user_name>@<PDB_name>
```

21.3.2.1 Server Certificate DN Matching

Oracle recommends using Server certificate DN matching, similar to using server DN matching with one-way TLS, to ensure the client is connecting to the intended server.

Configure full DN matching by setting the `SSL_SERVER_CERT_DN` parameter connection string in the `tnsnames.ora` file:

 **Note:**

If you can't set the host value in `tnsnames.ora` or `sqlnet.ora` to the value of the certificate common name (CN) or one of the entries in the SAN field, then consider using full DN matching.

Both the listener and server certificate will be checked with both partial and full DN matching. When using full DN matching, while the server and listener certificate can be different, their DN must be the same for the connection to succeed.

The `tnsnames.ora` file will look similar to:

```
finance=
(DESCRIPTION=
  (ADDRESS_LIST=
    (ADDRESS=(PROTOCOL = tcps)(HOST = finance)
    (PORT = 1575)))
  (CONNECT_DATA=
    (SERVICE_NAME= finance.us.example.com))
  (SECURITY=
    (SSL_SERVER_DN_MATCH = TRUE)
    (SSL_SERVER_CERT_DN="cn=finance,cn=OracleContext,c=us,o=example")))
```

21.3.3 Oracle Wallet Location

Certificates used for TLS are stored in the Oracle wallet. There are several default locations where the wallet can be placed. The location of the wallet can also be configured with the wallet location parameters on the client and listener. The `WALLET_ROOT` system parameter should be used for the database server wallet location.

- [Configuring Wallet Location for the Client](#)
The client's wallet location can be configured using the parameter `WALLET_LOCATION`. When the `WALLET_LOCATION` parameter is configured in `sqlnet.ora`, it applies to all connections. If a connection-specific wallet is needed, `WALLET_LOCATION` for the connection can be configured in the connect string, which overrides `WALLET_LOCATION` in `sqlnet.ora`.
- [Configuring Wallet Location for the Listener](#)
Wallet location for the listener can be configured using the `WALLET_LOCATION` parameter in `listener.ora`.
- [Configuring PDB Wallet Location for server](#)
The multi-tenant architecture enables an Oracle database to function as a multi-tenant container database (CDB) that includes zero, one, or many customer-created pluggable databases (PDBs).
- [Oracle Wallet Search Order](#)
Oracle Database provides several routes for finding the wallet on a server in a Transport Layer Security (TLS) environment.

21.3.3.1 Configuring Wallet Location for the Client

The client's wallet location can be configured using the parameter `WALLET_LOCATION`. When the `WALLET_LOCATION` parameter is configured in `sqlnet.ora`, it applies to all connections. If a connection-specific wallet is needed, `WALLET_LOCATION` for the connection can be configured in the connect string, which overrides `WALLET_LOCATION` in `sqlnet.ora`.

On certain platforms, a wallet is not required when setting up a client for one-way TLS authentication, and the wallet location is not required in the configuration. Oracle Database can utilize Trusted CA certificates installed on the system to support one-way TLS. Refer to the earlier topic, "Transport Layer Security Connections without a Client Wallet," for more details and a list of supported platforms.

Static configuration example (`sqlnet.ora`)

```
WALLET_LOCATION =
(SOURCE=
  (METHOD=File)
  (METHOD_DATA=
    (DIRECTORY=your_wallet_dir)
  )
)
```

Dynamic (pre-connection) configuration example (`tnsnames.ora`)

```
svc_name=(DESCRIPTION=
  (ADDRESS=(...))
  (CONNECT_DATA=(...))
```

```
(SECURITY=  
    (WALLET_LOCATION=your_wallet_dir)  
)  
)
```

21.3.3.2 Configuring Wallet Location for the Listener

Wallet location for the listener can be configured using the `WALLET_LOCATION` parameter in `listener.ora`.

`WALLET_LOCATION` can be specified for each listener in `listener.ora`.

For example,

```
LISTENER =  
    (DESCRIPTION=  
        (ADDRESS=  
            (PROTOCOL=tcps)  
            (HOST=)  
            (PORT=5678))  
        (SECURITY=  
            (WALLET_LOCATION=dir1)))  
  
LISTENER2 =  
    (DESCRIPTION=  
        (ADDRESS=  
            (PROTOCOL=tcps)  
            (HOST=)  
            (PORT=5679))  
        (SECURITY=  
            (WALLET_LOCATION=dir2)))
```

21.3.3.3 Configuring PDB Wallet Location for server

The multi-tenant architecture enables an Oracle database to function as a multi-tenant container database (CDB) that includes zero, one, or many customer-created pluggable databases (PDBs).

`CDB$ROOT` and each PDB can have its own local wallet which can be configured with the `WALLET_ROOT` system parameter defined in the `init.ora` file.

For example, for the CDB root container (this does not apply to all containers in the CDB):

```
WALLET_ROOT/tls
```

For example, for the PDB:

```
WALLET_ROOT/<pdb_GUID>/tls
```

 **Note:**

The parameter `WALLET_LOCATION` is deprecated for use with Oracle Database 23ai for the Oracle Database server. It is not deprecated for use with the Oracle Database client or listener.

For Oracle Database server, Oracle recommends that you use the `WALLET_ROOT` system parameter instead of using `WALLET_LOCATION`.

21.3.3.4 Oracle Wallet Search Order

Oracle Database provides several routes for finding the wallet on a server in a Transport Layer Security (TLS) environment.

How the Oracle Database Server locates wallets for use in TLS

The Oracle Database server locates the wallet by searching in the following locations in the specified order. If the database has one or more pluggable databases (PDB), the value for `pdb_GUID` must be replaced with the global identifier (GUID) of the PDB.

1. Location defined by the `WALLET_ROOT` system parameter in the `init.ora` file:
 - `WALLET_ROOT/<pdb_ID>/tls` for PDB
 - `WALLET_ROOT/tls` for the CDB root container, `CDB$ROOT`
2. Location defined by the `WALLET_LOCATION` in the `sqlnet.ora` file:
 - `WALLET_LOCATION`

 **Note:**

The parameter `WALLET_LOCATION` is deprecated for use with Oracle Database 23ai for the Oracle Database server. It is not deprecated for use with the Oracle Database client or listener.

For Oracle Database server, Oracle recommends that you use the `WALLET_ROOT` system parameter instead of using `WALLET_LOCATION`.

3. Location defined by the `$TNS_ADMIN` environment variable. This is the only directory location that will be checked, not any sub-directory underneath this location.
4. Default wallet location:
 - **Linux:** `/etc/ORACLE/WALLETS/user_name`
This is the only directory location that will be checked, not any sub-directory underneath this location.
 - **Windows:** `C:\Users\user_name\ORACLE\WALLETS`
This is the only directory location that will be checked, not any sub-directory underneath this location.
5. If a single wallet is needed for some or all of the CDB container databases, then place the wallet in `TNS_ADMIN` or the default wallet location. Then the PDB will default to that location when it can't find a wallet under `WALLET_ROOT`.

How the Oracle Database Listener locates wallets for use in TLS

The Oracle Database Listener locates the wallet location by searching in these locations, in the specified order:

1. Location defined by the `WALLET_LOCATION` parameter in the `listener.ora` file
2. Location defined by the `$TNS_ADMIN` environment variable
3. Default wallet location:
 - Linux: `/etc/ORACLE/WALLETS/user_name`
 - Windows: `C:\Users\user_name\ORACLE\WALLETS`

How the Oracle Database Client locates wallets for use in TLS

Oracle Database Client locates the wallet by searching in these locations, in the specified order:

1. Location defined by the `WALLET_LOCATION` parameter in the connection string
2. Location defined by the `WALLET_LOCATION` parameter in the `sqlnet.ora` file
3. Location defined by the `$TNS_ADMIN` environment variable
4. Default wallet location:
 - Linux: `/etc/ORACLE/WALLETS/user_name`
 - Windows: `C:\Users\user_name\ORACLE\WALLETS`
5. System certificate store
When one-way TLS authentication is desired, Oracle Database Client can use the trusted CA certificates present in the system certificate store. If the client has a need to support client authentication on the connections, it must setup a wallet containing its own certificate along with required trusted CA certificates.

The default certificate store location depends on the platform. At present, Oracle Database supports this method natively on Microsoft Windows and Linux.

For Windows, it is in the Microsoft Certificate Store for Microsoft Windows.

For Linux, its locations are as follows:

- RHEL/Oracle Linux: `/etc/pki/tls/cert.pem`
- Debian/Ubuntu/Gentoo: `/etc/ssl/certs/ca-certificates.crt`
- Fedora/RHEL: `/etc/pki/tls/certs/ca-bundle.crt`
- OpenSUSE: `/etc/ssl/ca-bundle.pem`
- OpenELEC: `/etc/pki/tls/cacert.pem`
- CentOS/RHEL7: `/etc/pki/ca-trust/extracted/pem/tls-ca-bundle.pem`
- Alpine Linux: `/etc/ssl/cert.pem`

For non-Linux and non-Windows systems, if the PEM file is not in one of the locations listed above for Linux systems, then you must either copy the PEM file to one of these default Linux locations or create a symlink from the PEM file to one of these locations. The file must be a PEM file.

**Note:**

You cannot change the default location of the certificate store.

21.3.4 Enable Weak DN Matching

The `SSL_ALLOW_WEAK_DN_MATCH` parameter control reverts the DN matching behavior to prior database versions.

Starting in Oracle Database 23ai, the behavior of the `SSL_SERVER_DN_MATCH` parameter has changed.

Server-side certificate verification through distinguished name (DN) is changed as follows: Both the listener certificate and the database server certificate are checked. In earlier Oracle Database releases, only the database server certificate was checked. In most production cases, the same certificate is used by the listener and the database. In cases where different certificates are used, DN matching can require new certificates to allow partial DN matching on SAN or hostname certificate information. In addition to checking the listener certificate, when using partial DN matching is used, the `SERVICE_NAME` parameter will be ignored. Only the hostname connect string parameter will be checked against the certificate common name (CN) and subject alternate name (SAN) fields. To revert to the behavior in earlier releases (using the service name in addition to hostname, and only checking the database server certificate), set the new parameter: `SSL_ALLOW_WEAK_DN_MATCH=TRUE`. The default is `FALSE`.

You can set `SSL_ALLOW_WEAK_DN_MATCH` as follows:

- `TRUE` enables `SSL_SERVER_DN_MATCH` to check the database server certificate (but not the listener) and enable the service name to be used for partial DN matching. The search order on the client side is as follows: first, the client `sqlnet.ora` or connect string host name value is compared against the certificate CN, then the list of names in the subject alternative name (SAN) field. Then the client `sqlnet.ora` or connect string `service_name` value is compared against the CN and the list of names in the SAN.
- `FALSE` (the default) disables `SSL_SERVER_DN_MATCH` from checking service name matching. Instead, matching on the client side is based on a search for the `HOST` value in the certificate DN, and if that is not available, then in the subject alternative name (SAN) field (but not the service name). The DN check is performed on the listener and the server certificates.

If you used the service name for partial DN matching previously, then you must either get a new certificate or set `SSL_ALLOW_WEAK_DN_MATCH` to `TRUE` to revert to the pre-release 23ai behavior. You are most likely using the same certificate for both the database server and listener, but if you are not, then you will either need to do one of the following:

- Get a new certificate (use the `orapki wallet add` command for self-signed certificates).
- Change or remove the DN matching strategy.
- Set the `SSL_ALLOW_WEAK_DN_MATCH` parameter to `TRUE` to revert `SSL_SERVER_DN_MATCH` to its older behavior.

When you set `SSL_ALLOW_WEAK_DN_MATCH` to `TRUE`, note the following:

- When the client performs a full DN match (`SSL_SERVER_MATCH=TRUE`, `SSL_SERVER_CERT_DN="certificate_DN"`), then only the database server certificate DN will need to match the `SSL_SERVER_CERT_DN` value.

- When the client performs a partial DN match (`SSL_SERVER_MATCH=TRUE`, `SSL_SERVER_CERT_DN` is not set), then Oracle Database will compare the connect string parameter `HOST` to the common name (CN) of the database server certificate DN and the certificate subject alternate names field (SAN). If there is no partial match, then Oracle Database will continue and check the `SERVICE_NAME` parameter with the CN.

21.3.5 Private Key/Certificate Selection

You can have multiple private key/certificate pairs stored in either the Oracle wallet or a system certificate store to use for certificates. This is sometimes necessary when different databases will assign different client credentials for mTLS, such as for Autonomous Database.

You can only specify the private key/certificate to be used with Windows MCS and Oracle Wallets.

You will need to specify the correct private key/certificate to use for a database connection. By setting the certificate selection parameters for client authentication on Windows, the MSCAPI certificate selection box will not appear, and the matching certificate is automatically used for Transport Layer Security.

While it is more likely that the client will need to select a specific private key/certificate from MCS or the wallet, the server and listener may also need to select a specific certificate for use if there is more than one in the wallet.

- [Setting the `SSL_CERTIFICATE_ALIAS` Parameter](#)
You can use the `SSL_CERTIFICATE_ALIAS` parameter to specify the alias of the client certificate.
- [Setting the `SSL_CERTIFICATE_THUMBPRINT` Parameter](#)
You can use the `SSL_CERTIFICATE_THUMBPRINT` to specify the thumbprint of the client certificate.
- [Setting the `SSL_EXTENDED_KEY_USAGE` Parameter](#)
You can use the `SSL_EXTENDED_KEY_USAGE` parameter to specify the extended key usage of the client certificate.

21.3.5.1 Setting the `SSL_CERTIFICATE_ALIAS` Parameter

You can use the `SSL_CERTIFICATE_ALIAS` parameter to specify the alias of the client certificate.

1. To get the alias name value, run the following `orapki` command:

```
orapki wallet display -wallet wallet_directory -pwd wallet_password -complete
```

The output will look similar to the following. See the `Alias` field.

```
User Certificates:
Alias: sslClient
Subject: CN=ssl
ClientIssuer: CN=sslRoot,C=US
Not Before: Thu Jul 18 22:29:17 UTC 2024
Not After: Sun Jul 16 22:29:17 UTC 2034
Serial Number: 01
Key Length: 2048
MD5 digest: 06:DD:79:AF:E6:D6:70:CE:C3:98:DE:8C:D7:FC:7E:C2
SHA-256 digest:
09:B2:EC:FE:A1:B8:C3:F3:F5:A7:DC:C6:00:26:86:BE:39:54:16:93:B6:A8:42:CC:69:
```

```
24:0F:B5:59:43:3F:AA
SHA-1 digest: 51:25:6F:45:F8:64:E5:CB:9E:56:D2:F2:0C:5C:A6:D5:61:DA:DB:FE
```

2. Set the Alias value using the `SSL_CERTIFICATE_ALIAS` parameter. For example, for `tnsnames.ora`:

```
net_service_name=
  (DESCRIPTION=
    (ADDRESS=(PROTOCOL=tcps) (HOST=sales-svr) (PORT=1521))
    (SECURITY=(SSL_CERTIFICATE_ALIAS=sslClient))
  )
```

This example shows how to set `SSL_CERTIFICATE_ALIAS` in the `sqlnet.ora` file:

```
SSL_CERTIFICATE_ALIAS=sslClient
```

Related Topics

- [Oracle Database Net Services Reference](#)

21.3.5.2 Setting the `SSL_CERTIFICATE_THUMBPRINT` Parameter

You can use the `SSL_CERTIFICATE_THUMBPRINT` to specify the thumbprint of the client certificate.

The value of the parameter is the SHA-1 or SHA-256 thumbprint of the client certificate, in the `algorithm:hash` format

1. To get the thumbprint value, run the following `orapki` command:

```
orapki wallet display -wallet wallet_directory -pwd wallet_password -complete
```

The output will look similar to the following. See the SHA-1 digest or SHA-256 digest field for the thumbprint value.

```
User Certificates:
Alias: sslClient
Subject: CN=ssl
ClientIssuer: CN=sslRoot,C=US
Not Before: Thu Jul 18 22:29:17 UTC 2024
Not After: Sun Jul 16 22:29:17 UTC 2034
Serial Number: 01
Key Length: 2048
MD5 digest: 06:DD:79:AF:E6:D6:70:CE:C3:98:DE:8C:D7:FC:7E:C2
SHA-256 digest:
09:B2:EC:FE:A1:B8:C3:F3:F5:A7:DC:C6:00:26:86:BE:39:54:16:93:B6:A8:42:CC:69:
24:0F:B5:59:43:3F:AA
SHA-1 digest: 51:25:6F:45:F8:64:E5:CB:9E:56:D2:F2:0C:5C:A6:D5:61:DA:DB:FE
```

2. Set this value using the `SSL_CERTIFICATE_THUMBPRINT` parameter. The following example shows how to set it in the `tnsnames.ora` file. For example, in the `tnsname.ora` file:

```
net_service_name=
  (DESCRIPTION=
    (ADDRESS=(PROTOCOL=tcps) (HOST=sales-svr) (PORT=1521))
```

```
(SECURITY=(SSL_CERTIFICATE_THUMBPRINT=SHA1:1B:11:01:5A:B1:2C:20:B2:12:34:3E:04:7B:83:47:DE:70:2E:4E:11))  
)
```

This example shows how to set `SSL_CERTIFICATE_THUMBPRINT` in the `sqlnet.ora` file:

```
SSL_CERTIFICATE_THUMBPRINT=SHA256:B38A5B1A036383922B5DE15361EE03940A56B456417E4124419B88EBC61E1123
```

Related Topics

- *Oracle Database Net Services Reference*

21.3.5.3 Setting the `SSL_EXTENDED_KEY_USAGE` Parameter

You can use the `SSL_EXTENDED_KEY_USAGE` parameter to specify the extended key usage of the client certificate.

You should set the `SQLNET.SSL_EXTENDED_KEY_USAGE` parameter if you have multiple certificates in the security module, but there is only one certificate with extended key usage field of client authentication, and this certificate is the one you want to use to authenticate to the database.

- For example, in the `sqlnet.ora` file:

```
SSL_EXTENDED_KEY_USAGE = "client authentication"
```

You can find the Extended Key Usage from the certificate using `orapki`:

```
orapki cert display -cert <certificate> -complete
```

Related Topics

- *Oracle Database Net Services Reference*

21.3.6 Transport Layer Security Encryption Combined with Authentication Methods

You can configure Oracle Database to use TLS concurrently with database user names and passwords, RADIUS, and Kerberos.

Architecture: Oracle Database and Transport Layer Security

The Oracle Net Services with Authentication Adapters diagram, displays the Oracle Database implementation of Transport Layer Security architecture, shows that Oracle Databases operates at the session layer on top of TLS and uses TCP/IP at the transport layer. The session layer is a network layer that provides the services needed by the presentation layer entities that enable them to organize and synchronize their dialogue and manage their data exchange. This layer establishes, manages, and terminates network sessions between the client and server. The transport layer is a networking layer that maintains end-to-end reliability through data flow control and error recovery methods.

This separation of functionality lets you employ TLS concurrently with other supported protocols.

Figure 21-1 Oracle Net Services with Authentication Adapters

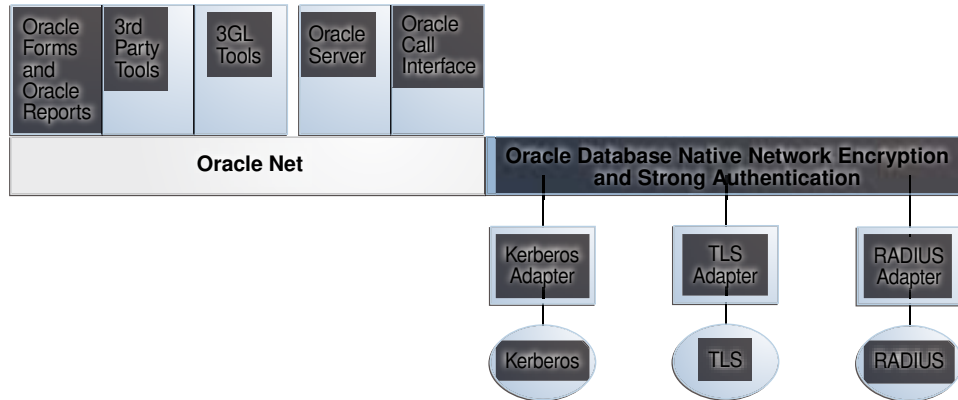

How Transport Layer Security Works with Other Authentication Methods

Transport Layer Security can be used with other authentication methods that Oracle Database supports.

[#unique_1275/unique_1275_Connect_42_CIHHEJJB](#) illustrates a configuration in which Transport Layer Security is used in combination with another authentication method.

Figure 21-2 Transport Layer Security in Relation to Other Authentication Methods

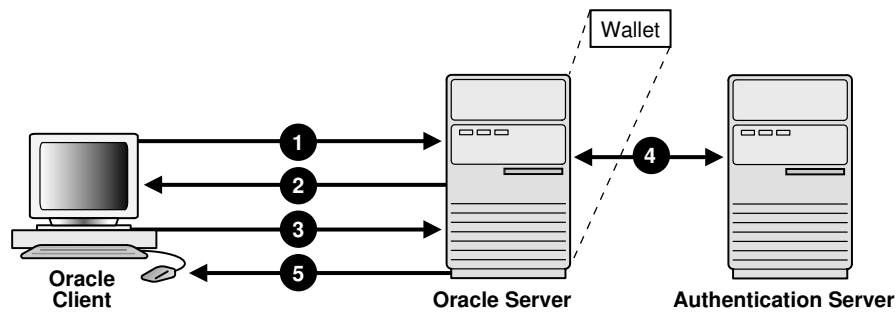

In this example, Transport Layer Security is used to establish an encrypted network connection between the client and server, and an alternative authentication method is used to authenticate the client into the database. The process is as follows:

1. The client seeks to connect to the Oracle database server.
2. Transport Layer Security performs a handshake during which the server authenticates itself to the client and both the client and server establish which cipher suite to use.
3. Once the Transport Layer Security handshake is successfully completed, the user seeks access to the database.
4. The Oracle database server authenticates the user with the authentication server using a non-TLS authentication method such as a password, Kerberos, RADIUS, or a cloud identity token (Oracle Cloud Infrastructure (OCI) Identity and Access Management (IAM), Microsoft Azure AD).
5. Upon validation by the authentication method, the Oracle database server grants access and authorization to the user, and then the user can access the database securely by using TLS.

Related Topics

- *Oracle Database Net Services Administrator's Guide*

21.3.7 Specifying TLS Protocol and TLS Cipher Suites

Oracle Database 23ai supports TLS protocol versions 1.2 and 1.3 and their associated cipher suites for Transport Layer Security (TLS).

Oracle provides the configuration parameters `SSL_VERSION`, and `SSL_CIPHER_SUITE` to configure the specific protocol version and cipher suites. However, Oracle recommends that you do not specify these parameters unless required. Omitting these values facilitate auto-detection of the strongest common TLS version (which ensures that the highest available version is selected) and their associated cipher suites. Oracle Database uses the `TLS_AES_256_GCM_SHA384` cipher suite as the default.

- [Configuring TLS Protocol Versions](#)
The `SSL_VERSION` parameter defines the protocol version of TLS that is enforced at the end point of the component where it is specified.
- [Configuring TLS Cipher Suites](#)
A cipher suite is a set of authentication, encryption, and data integrity algorithms used for exchanging messages between network entities.
- [Allowing Certificates from Earlier Algorithms](#)
You can use certificates that were associated with earlier deprecated (and weaker) algorithms by setting the `ALLOWED_WEAK_CERT_ALGORITHMS` `sqlnet.ora` or `listener.ora` parameter.

21.3.7.1 Configuring TLS Protocol Versions

The `SSL_VERSION` parameter defines the protocol version of TLS that is enforced at the end point of the component where it is specified.

`SSL_VERSION` can be specified with the database server, the listener, the client, or a combination of these components. If the TLS protocol version is specified in more than one of these locations, then at least one version must be common across all of the components. Otherwise, the connection will be rejected. Also, if a TLS protocol version is specified that is not supported by another component, then the connection request will also be rejected.

You can set the `SSL_VERSION` parameter in the client or server `sqlnet.ora` or the `listener.ora` file.

In the server `sqlnet.ora` file, set the `SSL_VERSION` parameter to indicate the supported TLS versions on the server.

Valid values are `undetermined` (the default), `TLSv1.2`, and `TLSv1.3`. Separate multiple entries with a comma. For example:

```
SSL_VERSION=(TLSv1.2,TLSv1.3)
```

If `SSL_VERSION` is not set, or is set to `undetermined`, all supported TLS versions are enabled.

 **Tip:**

Oracle recommends that you do not specify these parameters so that the highest version is auto-detected between server and client.

For environments where you want to enforce TLSv1.3 explicitly, you may specify the protocol version as follows:

```
SSL_VERSION = TLSv1.3
```

21.3.7.2 Configuring TLS Cipher Suites

A cipher suite is a set of authentication, encryption, and data integrity algorithms used for exchanging messages between network entities.

During a Transport Layer Security handshake, two entities negotiate to select a cipher suite they will use when transmitting messages to each other through the network.

When you install Oracle Database, the Transport Layer Security cipher suites are set for you by default and negotiated in the order they are listed from the strongest cipher suite. You can override the default order by setting the `SSL_CIPHER_SUITES` parameter. Ensure that you enclose the `SSL_CIPHER_SUITES` parameter setting in parentheses (for example, `SSL_CIPHER_SUITES=(TLS_AES_256_GCM_SHA384)`). Otherwise, the cipher suite setting will not parse correctly.

You can prioritize the cipher suites. When the client negotiates with servers to determine which cipher suite to use, it follows the prioritization you set. When you prioritize the cipher suites, consider the following:

- **Compatibility:** The server and client must be configured to use compatible cipher suites for a successful connection.
- **Cipher priority and strength:** Prioritize cipher suites starting with the strongest and moving to the weakest to ensure the highest level of security possible.
- **The level of security you want to use:** Use this to prevent older clients with weaker cipher suites from connecting to the database
- **Strong TLS Cipher Suites**
Oracle provides strong Transport Layer Security (TLS) cipher suites by default. Starting with Oracle Database 23ai, however, Oracle only supports TLSv1.2 and above. The default ciphers supported by Oracle are shown in the table below.
- **Deprecated TLS Cipher Suites**
To accommodate legacy products, Oracle provides TLS cipher suites which are considered less secure. Those ciphers are deprecated and disabled by default. The deprecated ciphers supported by Oracle are shown in the table below.
- **Enabling Weak Cipher Suites**
You can enable deprecated cipher suites by setting the `SSL_ENABLE_WEAK_CIPHERS` parameter. For the connections to be successful with the weak cipher suites, all three components (client, listener, and server) need to have the weak cipher suites enabled.

21.3.7.2.1 Strong TLS Cipher Suites

Oracle provides strong Transport Layer Security (TLS) cipher suites by default. Starting with Oracle Database 23ai, however, Oracle only supports TLSv1.2 and above. The default ciphers supported by Oracle are shown in the table below.

Table 21-6 Approved TLS Cipher Suites

Cipher Suite	Authentication	Encryption	Data Integrity	TLS Compatibility
TLS_AES_128_CC M_SHA256	ECDHE_RSA, DHE_RSA, ECDHE_ECDSA	AES 128 CCM	SHA256 (SHA 2)	TLS 1.3
TLS_AES_128_GC M_SHA256	ECDHE_RSA, DHE_RSA, ECDHE_ECDSA	AES 128 GCM	SHA256 (SHA-2)	TLS 1.3
TLS_AES_256_GC M_SHA384	ECDHE_RSA, DHE_RSA, ECDHE_ECDSA	AES 256 GCM	SHA384 (SHA-2)	TLS 1.3
TLS_CHACHA20_ POLY1305_SHA25 6 (non-FIPS only)	ECDHE_RSA, DHE_RSA, ECDHE_ECDSA	CHACHA20 POLY1305	SHA256 (SHA-2)	TLS 1.3
TLS_DHE_RSA_W ITH_AES_128_GC M_SHA256	DHE_RSA	AES 128 GCM	SHA256 (SHA-2)	TLS 1.2
TLS_DHE_RSA_W ITH_AES_256_GC M_SHA384	DHE_RSA	AES 256 GCM	SHA384 (SHA-2)	TLS 1.2
TLS_ECDHE_ECD SA_WITH_AES_12 8_GCM_SHA256	ECDHE_ECDSA	AES 128 GCM	SHA256 (SHA-2)	TLS 1.2
TLS_ECDHE_ECD SA_WITH_AES_25 6_GCM_SHA384	ECDHE_ECDSA	AES 256 GCM	SHA384 (SHA-2)	TLS 1.2
TLS_ECDHE_RSA _WITH_AES_128_ GCM_SHA256	ECDHE_RSA	AES 128 GCM	SHA256 (SHA-2)	TLS 1.2
TLS_ECDHE_RSA _WITH_AES_256_ GCM_SHA384	ECDHE_RSA	AES 256 GCM	SHA384 (SHA-2)	TLS 1.2

21.3.7.2.2 Deprecated TLS Cipher Suites

To accommodate legacy products, Oracle provides TLS cipher suites which are considered less secure. Those ciphers are deprecated and disabled by default. The deprecated ciphers supported by Oracle are shown in the table below.

Table 21-7 Deprecated TLS Cipher Suites

Cipher Suite	Authentication	Encryption	Data Integrity	TLS Compatibility
TLS_DHE_RSA_W ITH_AES_128_CB C_SHA256	DHE_RSA	AES 128 CBC	SHA256 (SHA-2)	TLS 1.2

Table 21-7 (Cont.) Deprecated TLS Cipher Suites

Cipher Suite	Authentication	Encryption	Data Integrity	TLS Compatibility
TLS_DHE_RSA_WITH_AES_256_CBC_SHA	DHE_RSA	AES 256 CBC	SHA (SHA-1)	TLS 1.2
TLS_DHE_RSA_WITH_AES_256_CBC_SHA256	DHE_RSA	AES 256 CBC	SHA256 (SHA-2)	TLS 1.2
TLS_ECDHE_ECDSA_WITH_AES_128_CBC_SHA	ECDHE_ECDSA	AES 128 CBC	SHA (SHA-1)	TLS 1.2
TLS_ECDHE_ECDSA_WITH_AES_128_CBC_SHA	ECDHE_ECDSA	AES 128 CBC	SHA (SHA-1)	TLS 1.2
TLS_ECDHE_ECDSA_WITH_AES_128_CBC_SHA256	ECDHE_ECDSA	AES 128 CBC	SHA256 (SHA-2)	TLS 1.2
TLS_ECDHE_ECDSA_WITH_AES_256_CBC_SHA	ECDHE_ECDSA	AES 256 CBC	SHA (SHA-1)	TLS 1.2
TLS_ECDHE_ECDSA_WITH_AES_256_CBC_SHA384	ECDHE_ECDSA	AES 256 CBC	SHA384 (SHA-2)	TLS 1.2
TLS_ECDHE_RSA_WITH_AES_128_CBC_SHA	ECDHE_RSA	AES 128 CBC	SHA (SHA-1)	TLS 1.2
TLS_ECDHE_RSA_WITH_AES_128_CBC_SHA256	ECDHE_RSA	AES 128 CBC	SHA256 (SHA-2)	TLS 1.2
TLS_ECDHE_RSA_WITH_AES_256_CBC_SHA	ECDHE_RSA	AES 256 CBC	SHA (SHA-1)	TLS 1.2
TLS_ECDHE_RSA_WITH_AES_256_CBC_SHA384	ECDHE_RSA	AES 256 CBC	SHA384 (SHA-2)	TLS 1.2
TLS_RSA_WITH_AES_128_CBC_SHA	RSA	AES 128 CBC	SHA (SHA-1)	TLS 1.2
TLS_RSA_WITH_AES_128_CBC_SHA256	RSA	AES 128 CBC	SHA256 (SHA-2)	TLS 1.2
TLS_RSA_WITH_AES_128_GCM_SHA256	RSA	AES 128 GCM	SHA256 (SHA-2)	TLS 1.2
TLS_RSA_WITH_AES_256_CBC_SHA	RSA	AES 256 CBC	SHA (SHA-1)	TLS 1.2
TLS_RSA_WITH_AES_256_CBC_SHA256	RSA	AES 256 CBC	SHA256 (SHA-2)	TLS 1.2

Table 21-7 (Cont.) Deprecated TLS Cipher Suites

Cipher Suite	Authentication	Encryption	Data Integrity	TLS Compatibility
TLS_RSA_WITH_AES_256_GCM_SHA384	RSA	AES 256 GCM	SHA384 (SHA-2)	TLS 1.2

21.3.7.2.3 Enabling Weak Cipher Suites

You can enable deprecated cipher suites by setting the `SSL_ENABLE_WEAK_CIPHERS` parameter. For the connections to be successful with the weak cipher suites, all three components (client, listener, and server) need to have the weak cipher suites enabled.

In this specification, `value` can be one of the following:

- `FALSE` (or `OFF`, `NO`, `0`) disables the weak ciphers. The setting is the default. If you try to use a weak cipher, then depending on where you are, the following errors appear:
 - In the database server: `ORA-28860: Fatal SSL error`
 - In the database client: `ORA-29039: There are no matching cipher suites.`
- `TRUE` (or `ON`, `YES`, `1`) enables the weak ciphers.

For example, to enable the deprecated cipher suites,

```
SSL_ENABLE_WEAK_CIPHERS=TRUE
```

21.3.7.3 Allowing Certificates from Earlier Algorithms

You can use certificates that were associated with earlier deprecated (and weaker) algorithms by setting the `ALLOWED_WEAK_CERT_ALGORITHMS` `sqlnet.ora` or `listener.ora` parameter.

The `ALLOWED_WEAK_CERT_ALGORITHMS` allows you to explicitly enable earlier algorithms. However, be aware that earlier algorithms are less secure than newer algorithms. This parameter replaces the `ALLOW_MD5_CERTS` and `ALLOW_SHA1_CERTS` parameters, which are deprecated starting in Oracle Database release 23ai.

1. Log in to the database server or the client server.
2. Edit the `sqlnet.ora` or `listener.ora` parameter file to include the `ALLOWED_WEAK_CERT_ALGORITHMS` parameter.

MD5 is disabled by default and SHA1 is enabled by default. The default location of the `sqlnet.ora` file is in the `$ORACLE_HOME/network/admin` directory.

You can specify MD5 or SHA1. If you want to specify both, then separate them with a comma. For example:

```
ALLOWED_WEAK_CERT_ALGORITHMS = (MD5,SHA1)
```

21.3.8 Certificate Validation with Certificate Revocation Lists

Oracle provides tools that enable you to validate certificates using certificate revocation lists.

- [About Certificate Validation with Certificate Revocation Lists](#)
The process of determining whether a given certificate can be used in a given context is referred to as certificate validation.
- [What CRLs Should You Use?](#)
You should have CRLs for all of the trust points that you honor.
- [How CRL Checking Works](#)
Oracle Database checks the certificate revocation status against CRLs.
- [Configuring Certificate Validation with Certificate Revocation Lists](#)
You can edit the `sqlnet.ora` file to configure certificate validation with certificate revocation lists.
- [Certificate Revocation List Management](#)
Certificate revocation list management entails ensuring that the CRLs are the correct format before you enable certificate revocation checking.
- [Troubleshooting CRL Certificate Validation](#)
To determine whether certificates are being validated against CRLs, you can enable Oracle Net tracing.
- [Oracle Net Tracing File Error Messages Associated with Certificate Validation](#)
Oracle generates trace messages that are relevant to certificate validation.

21.3.8.1 About Certificate Validation with Certificate Revocation Lists

The process of determining whether a given certificate can be used in a given context is referred to as certificate validation.

Certificate validation includes determining that the following takes place:

- A trusted certificate authority (CA) has digitally signed the certificate
- The certificate's digital signature corresponds to the independently-calculated hash value of the certificate itself and the certificate signer's (CA's) public key
- The certificate has not expired
- The certificate has not been revoked

The Transport Layer Security network layer automatically performs the first three validation checks, but you must configure certificate revocation list (CRL) checking to ensure that certificates have not been revoked. CRLs are signed data structures that contain a list of revoked certificates. They are usually issued and signed by the same entity who issued the original certificate.

21.3.8.2 What CRLs Should You Use?

You should have CRLs for all of the trust points that you honor.

The trust points are the trusted certificates from a third party identity that is qualified with a level of trust.

Typically, the certificate authorities you trust are called trust points.

21.3.8.3 How CRL Checking Works

Oracle Database checks the certificate revocation status against CRLs.

These CRLs are located in file system directories, Oracle Internet Directory, or downloaded from the location specified in the CRL Distribution Point (CRL DP) extension on the certificate.

Typically, CRL definitions are valid for a few days. If you store your CRLs on the local file system or in the directory, then you must update them regularly. If you use a CRL Distribution Point (CRL DP), then CRLs are downloaded each time a certificate is used, so there is no need to regularly refresh the CRLs.

The server searches for CRLs in the following locations in the order listed. When the system finds a CRL that matches the certificate CA's DN, it stops searching.

1. Local file system

The server checks the `sqlnet.ora` file for the `SSL_CRL_FILE` parameter first, followed by the `SSL_CRL_PATH` parameter. If these two parameters are not specified, then the server checks the wallet location for any CRLs.

 **Note:**

If you store CRLs on your local file system, then you must use the `orapki` utility to periodically update them (for example, renaming CRLs with a hash value for certificate validation).

2. Oracle Internet Directory

If the server cannot locate the CRL on the local file system and directory connection information has been configured in an `ldap.ora` file, then the server searches in the directory. It searches the CRL subtree by using the CA's distinguished name (DN) and the DN of the CRL subtree.

The server must have a properly configured `ldap.ora` file to search for CRLs in the directory. It cannot use the Domain Name System (DNS) discovery feature of Oracle Internet Directory. Also note that if you store CRLs in the directory, then you must use the `orapki` utility to periodically update them.

3. CRL DP

If the CA specifies a location in the CRL DP X.509, version 3, certificate extension when the certificate is issued, then the appropriate CRL that contains revocation information for that certificate is downloaded. Currently, Oracle Database supports downloading CRLs over LDAP.

Note the following:

- For performance reasons, only user certificates are checked.
- Oracle recommends that you store CRLs in the directory rather than the local file system.

Related Topics

- [Uploading CRLs to Oracle Internet Directory](#)
Publishing CRLs in the directory enables CRL validation throughout your enterprise, eliminating the need for individual applications to configure their own CRLs.
- [Renaming CRLs with a Hash Value for Certificate Validation](#)
When the system validates a certificate, it must locate the CRL issued by the CA who created the certificate.

21.3.8.4 Configuring Certificate Validation with Certificate Revocation Lists

You can edit the `sqlnet.ora` file to configure certificate validation with certificate revocation lists.

- [About Configuring Certificate Validation with Certificate Revocation Lists](#)
The `SSL_CERT_REVOCATION` parameter must be set to `REQUIRED` or `REQUESTED` in the `sqlnet.ora` file to enable certificate revocation status checking.
- [Enabling Certificate Revocation Status Checking for the Client or Server](#)
You can enable certificate revocation status checking for a client or a server.
- [Disabling Certificate Revocation Status Checking](#)
You can disable certificate revocation status checking.

21.3.8.4.1 About Configuring Certificate Validation with Certificate Revocation Lists

The `SSL_CERT_REVOCATION` parameter must be set to `REQUIRED` or `REQUESTED` in the `sqlnet.ora` file to enable certificate revocation status checking.

By default this parameter is set to `NONE` indicating that certificate revocation status checking is turned off.

Note:

If you want to store CRLs on your local file system or in Oracle Internet Directory, then you must use the command line utility, `orapki`, to rename CRLs in your file system or upload them to the directory.

Related Topics

- [Certificate Revocation List Management](#)
Certificate revocation list management entails ensuring that the CRLs are the correct format before you enable certificate revocation checking.

21.3.8.4.2 Enabling Certificate Revocation Status Checking for the Client or Server

You can enable certificate revocation status checking for a client or a server.

1. Log in to the Oracle Database server.
2. Modify the `SSL_CERT_REVOCATION` parameter in the `sqlnet.ora` file.

```
SSL_CERT_REVOCATION=value
```

In this specification, *value* can be either of the following settings:

- `required` requires certificate revocation status checking. The TLS connection is rejected if a certificate is revoked or no CRL is found. TLS connections are accepted only if it can be verified that the certificate has not been revoked.
- `requested` performs certificate revocation status checking if a CRL is available. The TLS connection is rejected if a certificate is revoked. TLS connections are accepted if no CRL is found or if the certificate has not been revoked. For performance reasons, only user certificates are checked for revocation.

3. If CRLs are stored on your local file system, then set one or both of the following `sqlnet.ora` parameters that specify where they are stored.
 - `SSL_CRL_PATH` sets the path to the directory where CRLs are stored. If you omit this setting, then the default is the wallet directory. Both DER-encoded (binary format) and PEM-encoded (BASE64) CRLs are supported. If you want to store CRLs in a local file system directory, then you must use the `orapki` utility to rename them so the system can locate them.
 - `SSL_CRL_FILE` sets the path to a comprehensive CRL file (where PEM-encoded (BASE64) CRLs are concatenated in order of preference in one file). Ensure that the file is present in the specified location, or else the application will not be able to start.

4. If you want to fetch CRLs from Oracle Internet Directory, then edit the `ldap.ora` file to include the directory server and port information.

When configuring your `ldap.ora` file, you should specify only a non-TLS port for the directory. CRL download is done as part of the TLS protocol, and making a TLS connection within a TLS connection is not supported.

Oracle Database CRL functionality will not work if the Oracle Internet Directory non-TLS port is disabled.

5. Repeat these steps for the Oracle Database client `sqlnet.ora` file.

Related Topics

- [Renaming CRLs with a Hash Value for Certificate Validation](#)
When the system validates a certificate, it must locate the CRL issued by the CA who created the certificate.

21.3.8.4.3 Disabling Certificate Revocation Status Checking

You can disable certificate revocation status checking.

1. Log in to the Oracle Database server.
2. Modify the `SSL_CERT_REVOCATION` parameter in the `sqlnet.ora` file as follows:

```
SSL_CERT_REVOCATION=NONE
```

3. Repeat this step for the Oracle Database client.

Related Topics

- [Troubleshooting CRL Certificate Validation](#)
To determine whether certificates are being validated against CRLs, you can enable Oracle Net tracing.

21.3.8.5 Certificate Revocation List Management

Certificate revocation list management entails ensuring that the CRLs are the correct format before you enable certificate revocation checking.

- [About Certificate Revocation List Management](#)
Oracle Database provides a command-line utility, `orapki`, that you can use to manage certificate revocation lists (CRL).
- [Displaying orapki Help for Commands That Manage CRLs](#)
You can display all the `orapki` commands that are available for managing CRLs.

- [Renaming CRLs with a Hash Value for Certificate Validation](#)
When the system validates a certificate, it must locate the CRL issued by the CA who created the certificate.
- [Uploading CRLs to Oracle Internet Directory](#)
Publishing CRLs in the directory enables CRL validation throughout your enterprise, eliminating the need for individual applications to configure their own CRLs.
- [Listing CRLs Stored in Oracle Internet Directory](#)
You can display a list of all CRLs stored in the directory with `orapki`, which is useful for browsing to locate a particular CRL to view or download to your local computer.
- [Viewing CRLs in Oracle Internet Directory](#)
Oracle Internet Directory CRLs are available in a summarized format; you also can request a listing of revoked certificates for a CRL.
- [Deleting CRLs from Oracle Internet Directory](#)
The user who deletes CRLs from the directory by using `orapki` must be a member of the directory group `CRLAdmins`.

21.3.8.5.1 About Certificate Revocation List Management

Oracle Database provides a command-line utility, `orapki`, that you can use to manage certificate revocation lists (CRL).

Before you can enable certificate revocation status checking, you must ensure that the CRLs you receive from the CAs you use are in a form (renamed with a hash value) or in a location (uploaded to the directory) where your computer can use them.

You can also use LDAP command-line tools to manage CRLs in Oracle Internet Directory.

 **Note:**

CRLs must be updated at regular intervals (before they expire) for successful validation. You can automate this task by using `orapki` commands in a script

21.3.8.5.2 Displaying `orapki` Help for Commands That Manage CRLs

You can display all the `orapki` commands that are available for managing CRLs.

- To display all the `orapki` available CRL management commands and their options, enter the following at the command line:

```
orapki crl help
```

 **Note:**

Using the `-summary`, `-complete`, or `-wallet` command options is always optional. A command will still run if these command options are not specified.

21.3.8.5.3 Renaming CRLs with a Hash Value for Certificate Validation

When the system validates a certificate, it must locate the CRL issued by the CA who created the certificate.

The system locates the appropriate CRL by matching the issuer name in the certificate with the issuer name in the CRL.

When you specify a CRL storage location for the **Certificate Revocation Lists Path** field in Oracle Net Manager, which sets the `SSL_CRL_PATH` parameter in the `sqlnet.ora` file, use the `orapki` utility to rename CRLs with a hash value that represents the issuer's name. Creating the hash value enables the server to load the CRLs.

On UNIX operating systems, `orapki` creates a symbolic link to the CRL. On Windows operating systems, it creates a copy of the CRL file. In either case, the symbolic link or the copy created by `orapki` are named with a hash value of the issuer's name. Then when the system validates a certificate, the same hash function is used to calculate the link (or copy) name so the appropriate CRL can be loaded.

- Depending on the operating system, enter one of the following commands to rename CRLs stored in the file system:

- To rename CRLs stored in UNIX file systems:

```
orapki crl hash -crl crl_filename [-wallet wallet_location] -symlink  
crl_directory [-summary]
```

- To rename CRLs stored in Windows file systems:

```
orapki crl hash -crl crl_filename [-wallet wallet_location] -copy crl_directory  
[-summary]
```

In this specification, `crl_filename` is the name of the CRL file, `wallet_location` is the location of a wallet that contains the certificate of the CA that issued the CRL, and `crl_directory` is the directory where the CRL is located.

Using `-wallet` and `-summary` are optional. Specifying `-wallet` causes the tool to verify the validity of the CRL against the CA's certificate prior to renaming the CRL. Specifying the `-summary` option causes the tool to display the CRL issuer's name.

21.3.8.5.4 Uploading CRLs to Oracle Internet Directory

Publishing CRLs in the directory enables CRL validation throughout your enterprise, eliminating the need for individual applications to configure their own CRLs.

All applications can use the CRLs stored in the directory where they can be centrally managed, greatly reducing the administrative overhead of CRL management and use. The user who uploads CRLs to the directory by using `orapki` must be a member of the directory group `CRLAdmins (cn=CRLAdmins,cn=groups,%s_OracleContextDN%)`. This is a privileged operation because these CRLs are accessible to the entire enterprise. Contact your directory administrator to get added to this administrative directory group.

- To upload CRLs to the directory, enter the following at the command line:

```
orapki crl upload -crl crl_location -ldap hostname:ssl_port -user username [-wallet  
wallet_location] [-summary]
```

In this specification, `crl_location` is the file name or URL where the CRL is located, `hostname` and `ssl_port` (TLS port with no authentication) are for the system on which your directory is installed, `username` is the directory user who has permission to add CRLs to the

CRL subtree, and `wallet_location` is the location of a wallet that contains the certificate of the CA that issued the CRL.

Using `-wallet` and `-summary` are optional. Specifying `-wallet` causes the tool to verify the validity of the CRL against the CA's certificate prior to uploading it to the directory. Specifying the `-summary` option causes the tool to print the CRL issuer's name and the LDAP entry where the CRL is stored in the directory.

The following example illustrates uploading a CRL with the `orapki` utility:

```
orapki crl upload -crl /home/user1/wallet/crl_dir/crl.txt -ldap host1.example.com:3533 -  
user cn=orcladmin
```

 **Note:**

- The `orapki` utility will prompt you for the directory password when you perform this operation.
- Ensure that you specify the directory SSL port on which the Diffie-Hellman-based TLS server is running. This is the TLS port that does not perform authentication. Neither the server authentication nor the mutual authentication TLS ports are supported by the `orapki` utility.

21.3.8.5.5 Listing CRLs Stored in Oracle Internet Directory

You can display a list of all CRLs stored in the directory with `orapki`, which is useful for browsing to locate a particular CRL to view or download to your local computer.

This command displays the CA who issued the CRL (Issuer) and its location (DN) in the CRL subtree of your directory.

- To list CRLs in Oracle Internet Directory, enter the following at the command line:

```
orapki crl list -ldap hostname:ssl_port
```

where the `hostname` and `ssl_port` are for the system on which your directory is installed.

 **Note:**

This is the directory SSL port with no authentication as described in the preceding section. [Uploading CRLs to Oracle Internet Directory](#)

21.3.8.5.6 Viewing CRLs in Oracle Internet Directory

Oracle Internet Directory CRLs are available in a summarized format; you also can request a listing of revoked certificates for a CRL.

You can view CRLs stored in Oracle Internet Directory in a summarized format or you can request a complete listing of revoked certificates for a CRL. A summary listing provides the CRL issuer's name and its validity period. A complete listing provides a list of all revoked certificates contained in the CRL.

- To view a summary listing of a CRL in Oracle Internet Directory, enter the following at the command line:

```
orapki crl display -crl crl_location [-wallet wallet_location] -summary
```

In this specification, *crl_location* is the location of the CRL in the directory. It is convenient to paste the CRL location from the list that displays when you use the `orapki crl list` command.

To view a list of all revoked certificates contained in a specified CRL, which is stored in Oracle Internet Directory, you can enter the following at the command line:

```
orapki crl display -crl crl_location [-wallet wallet_location] -complete
```

For example, the following `orapki` command:

```
orapki crl display -crl $T_WORK/pki/wlt_crl/nzcrl.txt -wallet $T_WORK/pki/wlt_crl -complete
```

produces the following output, which lists the CRL issuer's DN, its publication date, date of its next update, and the revoked certificates it contains:

```
issuer = CN=root,C=us, thisUpdate = Sun Nov 16 10:56:58 PST 2003, nextUpdate = Mon
Sep 30 11:56:58 PDT 2013, revokedCertificates = {(serialNo =
153328337133459399575438325845117876415, revocationDate - Sun Nov 16 10:56:58 PST
2003)}
CRL is valid
```

Using the `-wallet` option causes the `orapki crl display` command to validate the CRL against the CA's certificate.

Depending on the size of your CRL, choosing the `-complete` option may take a long time to display.

You can also use Oracle Directory Manager, a graphical user interface tool that is provided with Oracle Internet Directory, to view CRLs in the directory. CRLs are stored in the following directory location:

```
cn=CRLValidation,cn=Validation,cn=PKI,cn=Products,cn=OracleContext
```

Related Topics

- [Listing CRLs Stored in Oracle Internet Directory](#)
You can display a list of all CRLs stored in the directory with `orapki`, which is useful for browsing to locate a particular CRL to view or download to your local computer.

21.3.8.5.7 Deleting CRLs from Oracle Internet Directory

The user who deletes CRLs from the directory by using `orapki` must be a member of the directory group `CRLAdmins`.

- To delete CRLs from the directory, enter the following at the command line:

```
orapki crl delete -issuer issuer_name -ldap host:ssl_port -user username [-summary]
```

In this specification, *issuer_name* is the name of the CA who issued the CRL, the *hostname* and *ssl_port* are for the system on which your directory is installed, and *username* is the directory user who has permission to delete CRLs from the CRL subtree. Ensure that this must be a directory SSL port with no authentication.

Using the `-summary` option causes the tool to print the CRL LDAP entry that was deleted.

For example, the following `orapki` command:

```
orapki crl delete -issuer "CN=root,C=us" -ldap machine1:3500 -user cn=orcladmin -summary
```

produces the following output, which lists the location of the deleted CRL in the directory:

```
Deleted CRL at cn=root  
cd45860c.rN,cn=CRLValidation,cn=Validation,cn=PKI,cn=Products,cn=OracleContext
```

Related Topics

- [Uploading CRLs to Oracle Internet Directory](#)
Publishing CRLs in the directory enables CRL validation throughout your enterprise, eliminating the need for individual applications to configure their own CRLs.

21.3.8.6 Troubleshooting CRL Certificate Validation

To determine whether certificates are being validated against CRLs, you can enable Oracle Net tracing.

When a revoked certificate is validated by using CRLs, then you will see the following entries in the Oracle Net tracing file without error messages logged between `entry` and `exit`:

```
nzcrLVCS_VerifyCRLSignature: entry  
nzcrLVCS_VerifyCRLSignature: exit  
  
nzcrLVCD_VerifyCRLDate: entry  
nzcrLVCD_VerifyCRLDate: exit  
  
nzcrLCCS_CheckCertStatus: entry  
nzcrLCCS_CheckCertStatus: Certificate is listed in CRL  
nzcrLCCS_CheckCertStatus: exit
```



Note:

Note that when certificate validation fails, the peer in the SSL handshake sees an ORA-29024: Certificate Validation Failure.

Related Topics

- [Oracle Net Tracing File Error Messages Associated with Certificate Validation](#)
Oracle generates trace messages that are relevant to certificate validation.
- *Oracle Database Net Services Administrator's Guide*

21.3.8.7 Oracle Net Tracing File Error Messages Associated with Certificate Validation

Oracle generates trace messages that are relevant to certificate validation.

These trace messages may be logged between the `entry` and `exit` entries in the Oracle Net tracing file. Oracle SSL looks for CRLs in multiple locations, so there may be multiple errors in the trace.

You can check the following list of possible error messages for information about how to resolve them.

CRL signature verification failed

Cause: The CRL signature cannot be verified.

Action: Ensure that the downloaded CRL is issued by the peer's CA and that the CRL was not corrupted when it was downloaded. Note that the `orapki` utility verifies the CRL before renaming it with a hash value or before uploading it to the directory. See [Certificate Revocation List Management](#) for information about using `orapki` for CRL management.

CRL date verification failed

Cause: The current time is later than the time listed in the next update field. You should not see this error if CRL DP is used. The system searches for the CRL in the following order:

1. File system
2. Oracle Internet Directory
3. CRL DP

The first CRL found in this search may not be the latest.

Action: Update the CRL with the most recent copy.

CRL could not be found

Cause: The CRL could not be found at the configured locations. This will return error ORA-29024 if the configuration specifies that certificate validation is required.

Action: Ensure that the CRL locations specified in the configuration are correct by performing the following steps:

1. Use Oracle Net Manager to check if the correct CRL location is configured. Refer to [Configuring Certificate Validation with Certificate Revocation Lists](#)
2. If necessary, use the `orapki` utility to configure CRLs for system use as follows:
 - For CRLs stored on your local file system, refer to [Renaming CRLs with a Hash Value for Certificate Validation](#)
 - CRLs stored in the directory, refer to [Uploading CRLs to Oracle Internet Directory](#)

Oracle Internet Directory host name or port number not set

Cause: Oracle Internet Directory connection information is not set. Note that this is not an irrecoverable error. The search continues with CRL DP.

Action: If you want to store the CRLs in Oracle Internet Directory, then use Oracle Net Configuration Assistant to create and configure an `ldap.ora` file for your Oracle home.

Fetch CRL from CRL DP: No CRLs found

Cause: The CRL could not be fetched by using the CRL Distribution Point (CRL DP). This happens if the certificate does not have a location specified in its CRL DP extension, or if the URL specified in the CRL DP extension is incorrect.

Action: Ensure that your certificate authority publishes the CRL to the URL that is specified in the certificate's CRL DP extension.

Manually download the CRL. Then depending on whether you want to store it on your local file system or in Oracle Internet Directory, perform the following steps:

If you want to store the CRL on your local file system:

1. Use Oracle Net Manager to specify the path to the CRL directory or file. Refer to [Configuring Certificate Validation with Certificate Revocation Lists](#)
2. Use the `orapki` utility to configure the CRL for system use. Refer to [Renaming CRLs with a Hash Value for Certificate Validation](#)

If you want to store the CRL in Oracle Internet Directory:

1. Use Oracle Net Configuration Assistant to create and configure an `ldap.ora` file with directory connection information.
2. Use the `orapki` utility to upload the CRL to the directory. Refer to [Uploading CRLs to Oracle Internet Directory](#)

21.4 TLS and Other Oracle Products

Transport Layer Security (TLS) can be configured when using other Oracle Database products.

- [Transport Layer Security Connections in an Oracle Real Application Clusters Environment](#)
You can configure Transport Layer Security (TLS) connections in an Oracle Real Application Clusters (Oracle RAC) environment by using Oracle RAC tools and modifying Oracle Database configuration files.

21.4.1 Transport Layer Security Connections in an Oracle Real Application Clusters Environment

You can configure Transport Layer Security (TLS) connections in an Oracle Real Application Clusters (Oracle RAC) environment by using Oracle RAC tools and modifying Oracle Database configuration files.

- [Step 1: Configure TCPS Protocol Endpoints](#)
In Oracle Real Application Clusters (Oracle RAC), clients access one of three scan listeners and are then routed to database listeners. To support Transport Layer Security (TLS), all of these listeners must have TCPS protocol endpoints.
- [Step 2: Ensure That the LOCAL_LISTENER Parameter Is Correctly Set on Each Node](#)
The Oracle Agent automatically sets the `LOCAL_LISTENER` parameter on each node, but you should double-check to ensure that it is correct.
- [Step 3: Create Transport Layer Security Wallets and Certificates](#)
You must create Transport Layer Security (TLS) wallets and certificates for the cluster and also for clients that will connect to the cluster over TLS.
- [Step 4: Create a Wallet in Each Node of the Oracle RAC Cluster](#)
After you have created the cluster wallet, you can copy it to each node of the Oracle Real Applications (Oracle RAC) cluster.
- [Step 5: Define Wallet Locations in the listener.ora and sqlnet.ora Files](#)
To enable the database server and listeners to access the wallets, you must define the wallet locations in the `listener.ora` and `sqlnet.ora` files.
- [Step 6: Restart the Database Instances and Listeners](#)
With the wallets in place and the `*.ora` files edited, you must restart the database server and listener processes so that they pick up the new settings.
- [Step 7: Test the Cluster Node Configuration](#)
To test the cluster node configuration, you can create a connect descriptor for the node and then try to connect to this node.
- [Step 8: Test the Remote Client Configuration](#)
After you have tested the wallet on the Oracle Real Applications (Oracle RAC) cluster nodes, you are ready to test the remote client configuration.

21.4.1.1 Step 1: Configure TCPS Protocol Endpoints

In Oracle Real Application Clusters (Oracle RAC), clients access one of three scan listeners and are then routed to database listeners. To support Transport Layer Security (TLS), all of these listeners must have TCPS protocol endpoints.

1. Log in to the cluster that hosts the Oracle RAC database.
2. Check the listener resources to find if they support TCP endpoints.

For example:

```
$ srvctl config listener -h
```

Output similar to the following appears:

```
Name: LISTENER
Subnet: 192.0.2.195
Type: type
Owner: pfitch
Home: Grid_home
End points: TCP:1521
```

The following command displays information about the scan listener:

```
$ srvctl config scan_listener -h
```

Output similar to the following appears:

```
SCAN Listener LISTENER_SCAN1 exists. Port: TCP:1529
Registration invited nodes:
Registration invited subnets:
SCAN Listener is enabled.
SCAN Listener is individually enabled on nodes:
SCAN Listener is individually disabled on nodes:
```

3. Add TCPS endpoints to the database listeners.

For example:

```
$ srvctl modify listener -endpoints "TCP:port_1/TCPS:port_2"
```

4. Check the listener configuration.

For example:

```
$ srvctl config listener

Name: LISTENER
Network: 1, Owner: oracle
Home: CRS_home
End points: TCP:port_1/TCPS:port_2

$ lsnrctl status
```

```
Listening Endpoints Summary...
(DESCRIPTION=(ADDRESS=(PROTOCOL=ipc) (KEY=LISTENER)))
(DESCRIPTION=(ADDRESS=(PROTOCOL=tcps) (HOST=IP_address) (PORT=port_2)))
(DESCRIPTION=(ADDRESS=(PROTOCOL=tcp) (HOST=IP_address) (PORT=port_1)))
```

5. Add TCPS endpoints to the scan listeners.

For example:

```
$ srvctl modify scan_listener -endpoints "TCP:port_1/TCPS:port_2"
```

6. Check the scan listener configuration.

For example:

```
$ srvctl config scan_listener

SCAN Listener LISTENER_SCAN1 exists. Port: TCP:port_1/TCPS:port_2
SCAN Listener LISTENER_SCAN2 exists. Port: TCP:port_1/TCPS:port_2
SCAN Listener LISTENER_SCAN3 exists. Port: TCP:port_1/TCPS:port_2

$ lsnrctl status listener_scan3

Listening Endpoints Summary...
(DESCRIPTION=(ADDRESS=(PROTOCOL=ipc) (KEY=LISTENER_SCAN3)))
(DESCRIPTION=(ADDRESS=(PROTOCOL=tcp) (HOST=IP_address) (PORT=port_1)))
(DESCRIPTION=(ADDRESS=(PROTOCOL=tcps) (HOST=IP_address) (PORT=port_2)))
```

21.4.1.2 Step 2: Ensure That the LOCAL_LISTENER Parameter Is Correctly Set on Each Node

The Oracle Agent automatically sets the LOCAL_LISTENER parameter on each node, but you should double-check to ensure that it is correct.

1. Log in any Oracle Real Application Clusters (Oracle RAC) node.
2. In SQL*Plus, as a user with the SYSDBA administrative privilege, check the LOCAL_LISTENER parameter.

```
show parameter local_listener;
```

Output similar to the following appears:

NAME	TYPE	VALUE
local_listener	string	(ADDRESS=(PROTOCOL=TCPS)
(DESCRIPTION=(ADDRESS_LIST=		(HOST=IP_address)
		(PORT=port_2)))

3. If the output is not what you want, then restart each Oracle RAC instance.

21.4.1.3 Step 3: Create Transport Layer Security Wallets and Certificates

You must create Transport Layer Security (TLS) wallets and certificates for the cluster and also for clients that will connect to the cluster over TLS.

- [Oracle Real Application Clusters Components That Need Certificates](#)
Specific components in Oracle Real Application Clusters (Oracle RAC) need certificates when you configure Transport Layer Security (TLS) connections.
- [Creating Transport Layer Security Wallets and Certificates](#)
To create the Transport Layer Security wallets and certificates, you first need to create the root CA certificate, followed by the cluster and client wallets.

21.4.1.3.1 Oracle Real Application Clusters Components That Need Certificates

Specific components in Oracle Real Application Clusters (Oracle RAC) need certificates when you configure Transport Layer Security (TLS) connections.

- Each cluster node (server) and listener must have a wallet with the user certificate and CA certificates.
- The client only needs CA certificates of the listeners and servers (either in wallet or system's certificate store) if one-way TLS is configured.
- The client needs a wallet with its user certificate and CA certificates of the listeners and servers if mTLS is configured.

21.4.1.3.2 Creating Transport Layer Security Wallets and Certificates

To create the Transport Layer Security wallets and certificates, you first need to create the root CA certificate, followed by the cluster and client wallets.

1. Create the root CA certificate.
 - a. Log in to any Oracle Real Application Clusters (Oracle RAC) cluster node.
 - b. Use the `orapki` utility to create the CA wallet in a directory for the CA.

```
$ orapki wallet create -wallet <CA__wallet_directory>
```

- c. Create a self-signed root certificate for the CA wallet.

```
$ orapki wallet add -wallet <CA__wallet_directory> -self_signed -dn  
"CN=test CA,O=test,C=c" -keysize 2048 -validity 3650 -sign_alg sha256
```

- d. Extract the root CA certificate from the wallet.

This root certificate will be used as the trusted CA certificate in cluster and client wallets and can be distributed or published for users who are managing the PKCS#12 wallets.

```
$ orapki wallet export -wallet <CA__wallet_directory> -dn "CN=test  
CA,O=test,C=c" -cert testCARoot.cer
```

To check the configuration:

```
$ orapki wallet display -wallet <CA__wallet_directory>
```

Output similar to the following appears:

```
Requested Certificates:
User Certificates:
Subject:          CN=test CA,O=test,C=c
Trusted Certificates:
Subject:          CN=test CA,O=test,C=c
```

2. Create the cluster wallet.

Follow the remaining steps in this procedure to sign the user certificate requests and provide authorized digital user certificates to different entities and processes in your environments. Repeat this process for each entity in the test environment that participates in the public key infrastructure functionality. A valid wallet consists of a root CA certificate and the signed user certificate.

- a. Create a wallet that is in a different location from the from the CA home directory.

```
$ orapki wallet create -wallet <cluster_wallet_directory>
```

- b. Create a user identity (user dn) and then export the certificate request.

```
$ orapki wallet add -wallet <cluster_wallet_directory> -dn
"CN=testuser" -keysize 2048
```

```
$ orapki wallet export -wallet <cluster_wallet_directory> -dn
"CN=testuser" -request <cluster_wallet_directory>/testuser.req
```

At this stage, the `<cluster_wallet_directory>` directory will contain the wallet (ewallet.p12) and the certificate request (testuser.req). The certificate request can be signed by the CA generated above.

```
$ orapki cert create -wallet <CA_wallet_directory> -request
<CA_wallet_directory>/testuser.req -cert <cluster_wallet_directory>/
testuser.cer -validity 3650 -sign_alg sha256
```

The `<cluster_wallet_directory>` directory now has the testuser.cer certificate request file.

- c. Import the root certificate (testCAroot.cer) and the signed user certificate (testuser.cer) into the user wallet.

```
$ orapki wallet add -wallet <cluster_wallet_directory> -trusted_cert -
cert <CA_wallet_directory>/testCAroot.cer -pwd
$ orapki wallet add -wallet <cluster_wallet_directory> -user_cert -cert
<cluster_wallet_directory>/testuser.cer
```

- d. Check the finished cluster wallet.

```
$ orapki wallet display -wallet <cluster_wallet_directory>
```

```
Requested Certificates:
User Certificates:
```

```
Subject:          CN=testuser
Trusted Certificates:
Subject:          CN=test CA,O=test,C=c
```

At this point, you are ready to copy the finished cluster wallet to each node of the cluster.

3. Create the client wallet.

a. Create a client wallet with the root certificate (`testCAroot.cer`).

To make a successful TLS connection, the client only requires the CA certificate of the server's certificate.

```
$ orapki wallet create -wallet client_wallet_file_directory -auto_login
$ orapki wallet add -wallet client_wallet_file_directory -trusted_cert -
cert <CA_wallet_directory>/testCAroot.cer
```

b. Display the contents of the client wallet.

```
$ orapki wallet display -wallet client_wallet_file_directory

Requested Certificates:
User Certificates:
Trusted Certificates:
Subject:          CN=test CA,O=test,C=c
```

21.4.1.4 Step 4: Create a Wallet in Each Node of the Oracle RAC Cluster

After you have created the cluster wallet, you can copy it to each node of the Oracle Real Applications (Oracle RAC) cluster.

Ensure that each node is accessible by both the Oracle Real Application Clusters (Oracle RAC) database server (process monitor) and by the scan and local listeners that normally run from the GI home.

1. Copy the PKCS#12 wallet (`ewallet.p12`) file that you created in the previous section to each node in the cluster.
2. In each node, create an auto-login wallet (`cwallet.sso`).

The `cwallet.sso` file is an obfuscated mirror copy of the `ewallet.p12` and is the file that the database server and its listeners accesses. If you create the `cwallet.sso` on the Oracle RAC cluster, then you can copy it along with the `ewallet.p12` file to the wallet directory on each node. You can also create the `cwallet.sso` file on each node separately if `ewallet.p12` file is already in place. Run the following command in the same location as the `ewallet.p12` file:

```
$ orapki wallet create -wallet wallet_file_location -auto_login
Enter wallet password: ewallet_password
```

Related Topics

- [Oracle Real Application Clusters Components That Need Certificates](#)
Specific components in Oracle Real Application Clusters (Oracle RAC) need certificates when you configure Transport Layer Security (TLS) connections.

21.4.1.5 Step 5: Define Wallet Locations in the listener.ora and sqlnet.ora Files

To enable the database server and listeners to access the wallets, you must define the wallet locations in the `listener.ora` and `sqlnet.ora` files.

1. Modify the `listener.ora` file in the Grid home of every node.

```
SSL_CLIENT_AUTHENTICATION = FALSE

WALLET_LOCATION =
  (SOURCE =
    (METHOD = FILE)
    (METHOD_DATA =
      (DIRECTORY = wallet_file_location)
```

2. In the `sqlnet.ora` file in the Oracle Database home, and the Grid home, of each cluster node, add the following information:

```
SQLNET.AUTHENTICATION_SERVICES = (BEQ, TCP, TCPS)

SSL_CLIENT_AUTHENTICATION = FALSE

WALLET_LOCATION =
  (SOURCE =
    (METHOD = FILE)
    (METHOD_DATA =
      (DIRECTORY = wallet_file_location)
    )
  )
```

21.4.1.6 Step 6: Restart the Database Instances and Listeners

With the wallets in place and the `*.ora` files edited, you must restart the database server and listener processes so that they pick up the new settings.

The restart process will also enable the Oracle Real Application Clusters (Oracle RAC) instances where you set the `LOCAL_LISTENER` parameter earlier.

- In any cluster node, use the `srvctl` utility to restart the database server and listener processes.

For example:

```
$ srvctl stop listener
$ srvctl start listener

$ srvctl stop scan_listener
$ srvctl start scan_listener

$ srvctl stop database -d db_name
$ srvctl start database -d db_name
```

21.4.1.7 Step 7: Test the Cluster Node Configuration

To test the cluster node configuration, you can create a connect descriptor for the node and then try to connect to this node.

1. In any cluster node, create a connect descriptor in the `tnsnames.ora` file that uses the scan listener TCPS endpoint.

For example, for a TCPS endpoint called `dbssl`:

```
DBSSL =
  (DESCRIPTION =
    (ADDRESS = (PROTOCOL = TCPS) (HOST = scan_name) (PORT = port_2))
    (CONNECT_DATA =
      (SERVER = DEDICATED)
      (SERVICE_NAME = service_name)
    )
  )
```

2. Use SQL*Plus to try to connect to this TCPS endpoint.

For example:

```
sqlplus user_name/@dbssl
Enter password: password
```

21.4.1.8 Step 8: Test the Remote Client Configuration

After you have tested the wallet on the Oracle Real Applications (Oracle RAC) cluster nodes, you are ready to test the remote client configuration.

1. In every remote client `sqlnet.ora` file on the cluster node, define a wallet directory.

```
WALLET_LOCATION =
  (SOURCE =
    (METHOD = FILE)
    (METHOD_DATA =
      (DIRECTORY = wallet_file_location)
    )
  )
```

2. Move the client wallet, that you created during the setup of SSL wallets and certificates, to the client wallet directory. The wallet directory should have an `ewallet.p12` file and a `cwallet.sso` file.

Display the contents of the wallet to ensure that the wallet directory is setup correctly.

```
$ orapki wallet display -wallet <wallet_file_location>
```

3. In the `tnsnames.ora` file, create a connect descriptor that uses the scan listener TCPS endpoint.

For example:

```
DBSSL =
  (DESCRIPTION =
```

```
(ADDRESS = (PROTOCOL = TCPS) (HOST = scan_name) (PORT = port_2))
(CONNECT_DATA =
  (SERVER = DEDICATED)
  (SERVICE_NAME = service_name)
)
)
```

4. Use SQL*Plus to try to connect to this TCPS endpoint. Enter the password when prompted.

For example:

```
sqlplus user_name/@dbssl
```

21.5 Troubleshooting the Transport Layer Security Configuration

Common errors may occur while you use the Oracle Database Transport Layer Security.

It may be necessary to enable Oracle Net tracing to determine the cause of an error. For information about setting tracing parameters to enable Oracle Net tracing, refer to [Tracing Error Information for Oracle Net Services](#) in the *Oracle Database Net Services Administrator's Guide*.

ORA-28759: Failure to Open File

Cause: The system could not open the specified file. Typically, this error occurs because the wallet cannot be found.

Action: Check the following:

- Ensure that the correct wallet location is specified in the `sqlnet.ora` file. This should be the same directory location where you saved the wallet.
- Enable Oracle Net tracing to determine the name of the file that cannot be opened and the reason.
- Ensure that auto-login was enabled when you saved the wallet, using `orapki` or `mkstore`. The `mkstore` wallet management command line tool is deprecated with Oracle Database 23ai, and can be removed in a future release.

ORA-28786: Decryption of Encrypted Private Key Failure

Cause: An incorrect password was used to decrypt an encrypted private key. Frequently, this happens because an auto-login wallet is not being used.

Action: Use `orapki` to turn the auto-login feature on for the wallet. Then save the wallet again. For example:

```
orapki wallet create -wallet wallet_file_location -auto_login
```

If the auto-login feature is not being used, then enter the correct password.

ORA-28858: SSL Protocol Error

Cause: This is a generic error that can occur during TLS handshake negotiation between two processes.

Action: Enable Oracle Net tracing and attempt the connection again to produce trace output. Then contact Oracle customer support with the trace output.

ORA-28859 SSL Negotiation Failure

Cause: An error occurred during the negotiation between two processes as part of the TLS protocol. This error can occur when two sides of the connection do not support a common cipher suite.

Action: Check the following:

- Check the `sqlnet.ora` file to ensure that the TLS versions on both the client and the server match, or are compatible. For example, if the server accepts only TLS 1.3 and the client accepts only TLS 1.2, then the TLS connection will fail.
- Check what cipher suites are configured on the client and the server, and ensure that compatible cipher suites are set on both.

If the error still persists, then enable tracing and attempt the connection again. Contact Oracle Support with the trace output.

 **See Also:**

[Specifying TLS Protocol and TLS Cipher Suites](#) for details about setting compatible cipher suites on the client and the server

 **Note:**

If you do not configure any cipher suites, then all available cipher suites are enabled.

ORA-28862: SSL Connection Failed

Cause: This error occurred because the peer closed the connection.

Action: Check the following:

- Ensure that the correct wallet location is specified in the `sqlnet.ora` file so the system can find the wallet.
- Ensure that cipher suites are set correctly in the `sqlnet.ora` file. Sometimes this error occurs because the `sqlnet.ora` has been manually edited and the cipher suite names are misspelled. Ensure that case sensitive string matching is used with cipher suite names.
- Ensure that the TLS versions on both the client and the server match or are compatible. Sometimes this error occurs because the TLS version specified on the server and client do not match. For example, if the server accepts only TLS 1.3 and the client accepts only TLS 1.2, then the TLS connection will fail.
- For more diagnostic information, enable Oracle Net tracing on the peer.

ORA-28865: SSL Connection Closed

Cause: The TLS connection closed because of an error in the underlying transport layer, or because the peer process quit unexpectedly.

Action: Check the following:

- Ensure that the TLS versions on both the client and the server match, or are compatible. Sometimes this error occurs because the TLS version specified on the server and client do not match. For example, if the server accepts only TLS 1.3 and the client accepts only TLS 1.2, then the TLS connection will fail.
- Enable Oracle Net tracing and check the trace output for network errors.

ORA-28868: Peer Certificate Chain Check Failed

Cause: When the peer presented the certificate chain, it was checked and that check failed. This failure can be caused by a number of problems, including:

- One of the certificates in the chain has expired.
- A certificate authority for one of the certificates in the chain is not recognized as a [trust point](#).
- The signature in one of the certificates cannot be verified.

Action: Open your wallet and check the following:

- Ensure that all of the certificates installed in your wallet are current (not expired).
- Ensure that a certificate authority's certificate from your peer's certificate chain is added as a trusted certificate in your wallet.

ORA-28885: No certificate with the required key usage found.

Cause: Your certificate was not created with the appropriate X.509 version 3 key usage extension.

Action: Create the certificate with the appropriate X.509 version 3 key usage extension. For example:

```
orapki wallet add -wallet user_wallet -asym_alg ECC -eccurve p384 -sign_alg
ecdsasha384 -dn 'cn=user_ecc,c=us' -pwd welcome1 -addext_ku digitalSignature
```

You may add more key usages than just `digitalSignature`, for example:

```
-addext_ku
digitalSignature,nonRepudiation,keyEncipherment,dataEncipherment,keyAgreement,
keyCertSign,cRLSign,encipherOnly,decipherOnly
```

ORA-29019: The Protocol Version is incorrect

Cause: There is a protocol version mismatch between the two peers.

Action: Specify the correct protocol version or unset `SSL_VERSION` in the product's configuration file.

The error code is shown in the trace: `[DATE_AND_TIME] ntzdosecneg: SSL handshake failed with error 29019.`

ORA-29024: Certificate Validation Failure

Cause: The certificate sent by the other side could not be validated. This may occur if the certificate has expired, has been revoked, or is invalid for any other reason.

Action: Check the following:

- Check the certificate to determine whether it is valid. If necessary, get a new certificate, inform the sender that their certificate has failed, or resend.

- Check to ensure that the server's wallet has the appropriate trust points to validate the client's certificate. If it does not, then use `orapki` to import the appropriate trust point into the wallet.
- Ensure that the certificate has not been revoked and that certificate revocation list (CRL) checking is turned on. For details, refer to [Configuring Certificate Validation with Certificate Revocation Lists](#)

ORA-29223: Cannot Create Certificate Chain

Cause: A certificate chain cannot be created with the existing trust points for the certificate being installed. Typically, this error is returned when the peer does not give the complete chain and you do not have the appropriate trust points to complete it.

Action: Use `orapki` to install the trust points that are required to complete the chain.

21.6 Migrating to and Configuring Transport Layer Security Version 1.3

Version 1.3 of Transport Layer Security (TLS) provides stronger security and faster TLS handshakes, when compared to previous versions of TLS.

TLS version 1.3 is supported and enabled by default with 23ai when both the database server and client are version 23ai.

If your environment does not specify the `SSL_VERSION` parameter in the configuration files, then TLS version 1.3 is enabled by default. If the `SSL_CIPHER_SUITES` parameter is not explicitly configured, TLS 1.3 cipher suites get automatically picked. The product is designed to pick the strongest TLS version and the strongest available cipher in that version.

The enhancements in Transport Layer Security (TLS) version 1.3 may affect current TLS configurations if one or both of the following parameters are specified.

- `SSL_VERSION`: Remove this parameter from the configuration files to enable all supported TLS versions, or include the string "TLSv1.3" in the value specified
For example,

```
SSL_VERSION = (TLSv1.3, TLSv1.2)
```

- `SSL_CIPHER_SUITES`: Remove this parameter from the configuration files to enable all supported TLS cipher suites, or include one or more of the TLS version 1.3 cipher suites
For example,

```
SSL_CIPHER_SUITES = (TLS_AES_256_GCM_SHA384, TLS_AES_128_GCM_SHA256,  
TLS_AES_128_CCM_SHA256)
```

Related Topics

- [Troubleshooting Transport Layer Security Errors](#)
Oracle provides several troubleshooting tasks if you have problems with the Transport Layer Security (TLS) configuration, such as connection or authentication errors.
- [Allowing Certificates from Earlier Algorithms](#)
You can use certificates that were associated with earlier deprecated (and weaker) algorithms by setting the `ALLOWED_WEAK_CERT_ALGORITHMS` `sqlnet.ora` or `listener.ora` parameter.

Part V

Managing Strong Authentication

Part V describes how to manage strong authentication.

- [Introduction to Strong Authentication](#)
Strong authentication supports tools such as Transport Layer Security (TLS) to verify the identities of users who log in to the database.
- [Strong Authentication Administration Tools](#)
You can use a set of strong authentication administration tools for native network encryption and public key infrastructure credentials.
- [Configuring Kerberos Authentication](#)
Kerberos is a trusted third-party authentication system that relies on shared secrets and presumes that the third party is secure.
- [Configuring PKI Certificate Authentication](#)
You can configure Oracle Database to use PKI certificates for end-user authentication.
- [Configuring RADIUS Authentication](#)
RADIUS is a client/server security protocol widely used to enable remote authentication and access.
- [Customizing the Use of Strong Authentication](#)
You can configure multiple authentication methods under Oracle Database native network encryption and strong authentication.

Introduction to Strong Authentication

Strong authentication supports tools such as Transport Layer Security (TLS) to verify the identities of users who log in to the database.

- [What Is Strong Authentication?](#)
You use authentication to prove the identities of users who are attempting to log into the database.
- [Centralized Authentication and Single Sign-On](#)
Single sign-on enables users to access multiple accounts and applications with a single password.
- [How Centralized Network Authentication Works](#)
A centralized network authentication system works with an Oracle server, an authentication server, and users who connect to the Oracle server.
- [Supported Strong Authentication Methods](#)
Oracle Database supports industry-standard authentication methods.
- [Oracle Database Native Network Encryption/Strong Authentication Architecture](#)
The Oracle Database native network encryption and strong authentication architecture complements an Oracle database server or client installations.
- [System Requirements for Strong Authentication](#)
Kerberos, RADIUS, and Transport Layer Security (TLS) have a set of system requirements for strong authentication.
- [Oracle Database Native Network Encryption and Strong Authentication Restrictions](#)
Oracle applications support Oracle Database native network encryption and strong authentication.

22.1 What Is Strong Authentication?

You use authentication to prove the identities of users who are attempting to log into the database.

Authenticating user identity is imperative in distributed environments, without which there can be little confidence in network security. Passwords are the most common means of authentication. Oracle Database enables strong authentication with Oracle authentication adapters that support various third-party authentication services, including TLS with digital certificates.

[Figure 22-1](#) shows user authentication with an Oracle database instance configured to use a third-party authentication server. Having a central facility to authenticate all members of the network (clients to servers, servers to servers, users to both clients and servers) is one effective way to address the threat of network nodes falsifying their identities.

Figure 22-1 Strong Authentication with Oracle Authentication Adapters

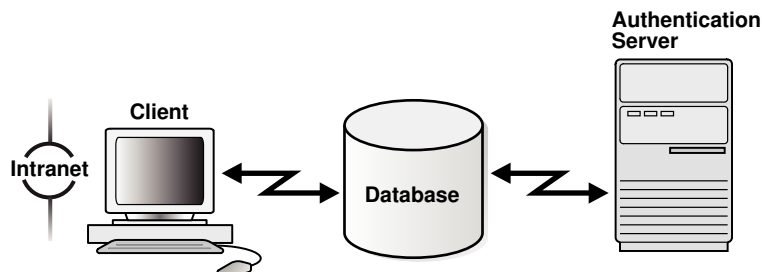

22.2 Centralized Authentication and Single Sign-On

Single sign-on enables users to access multiple accounts and applications with a single password.

Centralized authentication also provides the benefit of single sign-on (SSO) for users. This is the ability of a user to authenticate once, combined with strong authentication occurring transparently in subsequent connections to other databases or applications. Single sign-on lets a user access multiple accounts and applications with a single password, entered during a single connection. Single password, single authentication. Oracle Database supports Kerberos and SSL-based single sign-on.

In single sign-on, a user only needs to login once and can then automatically connect to any other service without having to give the user name and password again. Single sign-on eliminates the need for the user to remember and administer multiple passwords, reducing the time spent logging into multiple services.

22.3 How Centralized Network Authentication Works

A centralized network authentication system works with an Oracle server, an authentication server, and users who connect to the Oracle server.

The following diagram shows how a centralized network authentication service typically operates.

Figure 22-2 How a Network Authentication Service Authenticates a User

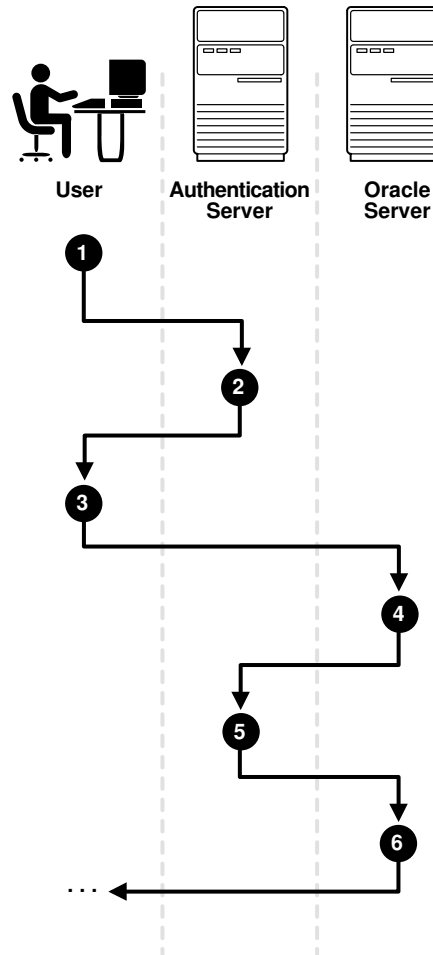

The following steps describe how centralized Network Authentication Process works.

1. A user (client) requests authentication services and provides identifying information, such as a token or password.
2. The authentication server validates the user's identity and passes a ticket or credentials back to the client, which may include an expiration time.
3. The client passes these credentials to the Oracle server concurrent with a service request, such as connection to a database.
4. The server sends the credentials back to the authentication server for authentication.
5. The authentication server checks the credentials and notifies the Oracle server.
6. If the credentials were accepted by the authentication server, then the Oracle server authenticates the user. If the authentication server rejected the credentials, then authentication fails, and the service request is denied.

22.4 Supported Strong Authentication Methods

Oracle Database supports industry-standard authentication methods.

- [About Kerberos](#)
Oracle Database support for Kerberos provides the benefits of single sign-on and centralized authentication of Oracle users.
- [About Remote Authentication Dial-In User Service \(RADIUS\)](#)
RADIUS is a client/server security protocol that is most widely known for enabling remote authentication and access.
- [About Transport Layer Security](#)
Transport Layer Security (TLS) is an industry standard protocol for securing network connections.

22.4.1 About Kerberos

Oracle Database support for Kerberos provides the benefits of single sign-on and centralized authentication of Oracle users.

Kerberos is a trusted third-party authentication system that relies on shared secrets. It presumes that the third party is secure, and provides single sign-on capabilities, centralized password storage, database link authentication, and enhanced PC security. It does this through a Kerberos authentication server.

Note:

Oracle authentication for Kerberos provides database link authentication (also called proxy authentication). Kerberos is also an authentication method that is supported with Enterprise User Security.

Enterprise User Security (EUS) is deprecated with Oracle Database 23ai. Oracle recommends that you migrate to using Centrally Managed Users (CMU). This feature enables you to directly connect with Microsoft Active Directory without an intervening directory service for enterprise user authentication and authorization to the database. If your Oracle Database is in the cloud, you can also choose to move to one of the newer integrations with a cloud identity provider.

Related Topics

- [Configuring Kerberos Authentication](#)
Kerberos is a trusted third-party authentication system that relies on shared secrets and presumes that the third party is secure.

22.4.2 About Remote Authentication Dial-In User Service (RADIUS)

RADIUS is a client/server security protocol that is most widely known for enabling remote authentication and access.

Oracle Database uses this standard in a client/server network environment to enable use of any authentication method that supports the RADIUS protocol. RADIUS can be used with a variety of authentication mechanisms, including token cards and smart cards.

- **Smart Cards.** A RADIUS-compliant smart card is a credit card-like hardware device which has memory and a processor. It is read by a smart card reader located at the client workstation.
- **Token Cards.** Token cards (Secure ID or RADIUS-compliant) can improve ease of use through several different mechanisms. Some token cards dynamically display one-time

passwords that are synchronized with an authentication service. The server can verify the password provided by the token card at any given time by contacting the authentication service. Other token cards have a keypad and operate on a challenge-response basis. In this case, the server offers a challenge (a number) that the user enters into a token card. The token card provides a response (another number cryptographically derived from the challenge) that the user enters and sends to the server.

You can use SecurID tokens through the RADIUS adapter.

Related Topics

- [Configuring RADIUS Authentication](#)
RADIUS is a client/server security protocol widely used to enable remote authentication and access.

22.4.3 About Transport Layer Security

Transport Layer Security (TLS) is an industry standard protocol for securing network connections.

TLS provides authentication, data encryption, and data integrity.

The TLS protocol is the foundation of a public key infrastructure (PKI). For authentication, TLS uses digital certificates that comply with the X.509v3 standard and a public and private key pair.

With a public and a private key pair, a set of two numbers are used for encryption and decryption, where one is called the private key and the other is called the public key. Public keys are typically made widely available, while private keys are held by their respective owners. Though mathematically related, it is generally viewed as computationally infeasible to derive the private key from the public key. Public and private keys are used only with asymmetric encryption algorithms, also called public-key encryption algorithms, or public-key cryptosystems. Data encrypted with either a public key or a private key from a key pair can be decrypted with its associated key from the key-pair. However, data encrypted with a public key cannot be decrypted with the same public key, and data encrypted with a private key cannot be decrypted with the same private key.

Oracle Database TLS can be used to secure communications between any client and any server. You can configure TLS to provide authentication for the server only, the client only, or both client and server. You can also configure TLS features in combination with other authentication methods supported by Oracle Database (database user names and passwords, RADIUS, and Kerberos).

To support your PKI implementation, Oracle Database includes the following features in addition to TLS:

- Oracle wallets, where you can store PKI credentials
- The `orapki` and `mkstore` (deprecated) utilities, which you can use to manage your Oracle wallets.
- Certificate validation with certificate revocation lists (CRLs)
- Hardware security module support

Related Topics

- [Configuring PKI Certificate Authentication](#)
You can configure Oracle Database to use PKI certificates for end-user authentication.

- [Customizing the Use of Strong Authentication](#)
You can configure multiple authentication methods under Oracle Database native network encryption and strong authentication.

22.5 Oracle Database Native Network Encryption/Strong Authentication Architecture

The Oracle Database native network encryption and strong authentication architecture complements an Oracle database server or client installations.

The following diagram shows the this architecture within an Oracle networking environment.

Figure 22-3 Oracle Native Network Encryption and Strong Authentication Architecture

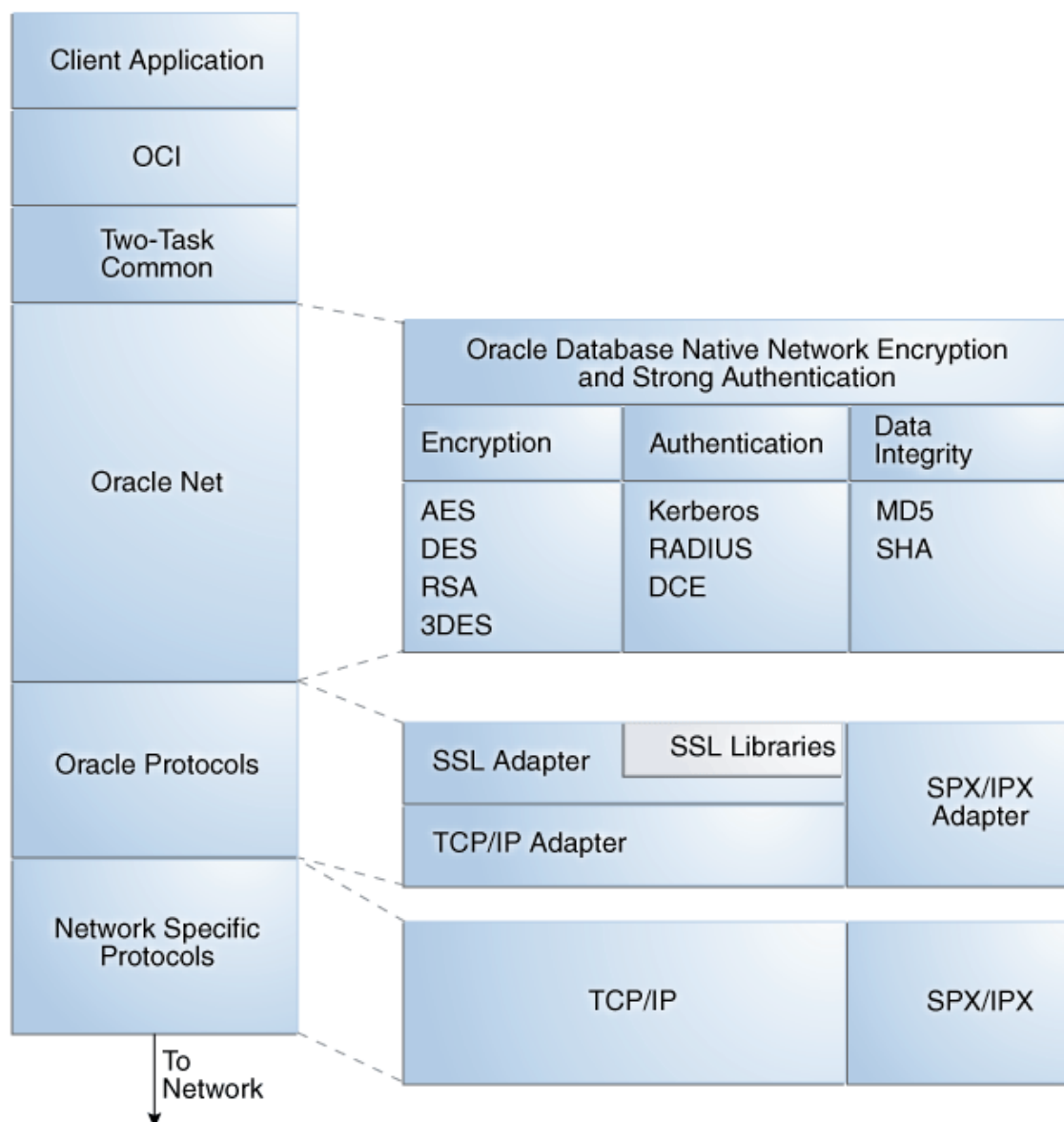

Oracle Database supports authentication through adapters that are similar to the existing Oracle protocol adapters. As shown in [Figure 22-4](#), authentication adapters integrate the

Oracle Net interface, and allow existing applications to take advantage of new authentication systems transparently, without any changes to the application.

Figure 22-4 Oracle Net Services with Authentication Adapters

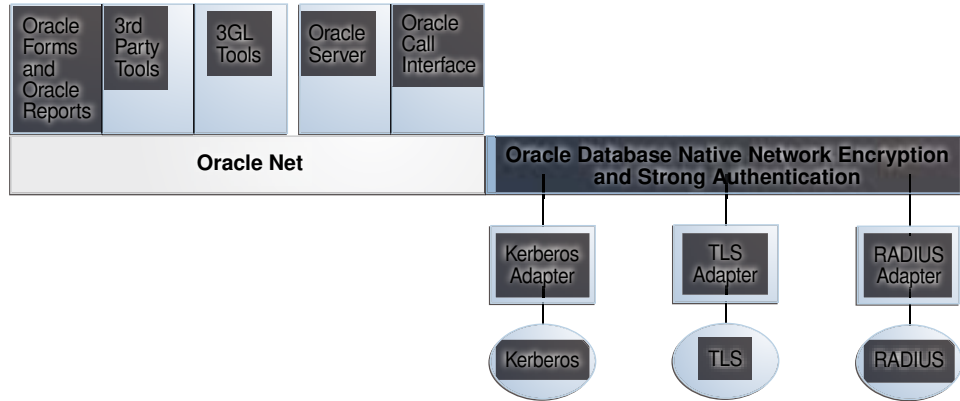

See Also:

Oracle Database Net Services Administrator's Guide for more information about stack communications in an Oracle networking environment

22.6 System Requirements for Strong Authentication

Kerberos, RADIUS, and Transport Layer Security (TLS) have a set of system requirements for strong authentication.

Table 22-1 lists the TLS system requirements for strong authentication.

Table 22-1 Authentication Methods and System Requirements

Authentication Method	System Requirements
Kerberos	<ul style="list-style-type: none"> MIT Kerberos Version 5, release 1.8 or above. The Kerberos authentication server must be installed on a physically secure system.
RADIUS	<ul style="list-style-type: none"> A RADIUS server that is compliant with the standards in the Internet Engineering Task Force (IETF) RFC #2138, <i>Remote Authentication Dial In User Service (RADIUS)</i> and RFC #2139 <i>RADIUS Accounting</i>. To enable challenge-response authentication, you must run RADIUS on an operating system that supports the Java Native Interface as specified in release 1.1 of the Java Development Kit from JavaSoft.
TLS	<ul style="list-style-type: none"> A wallet that is compatible with the Oracle Database 10g and later versions of the <code>orapki</code> and <code>mkstore</code> (deprecated) utilities.

22.7 Oracle Database Native Network Encryption and Strong Authentication Restrictions

Oracle applications support Oracle Database native network encryption and strong authentication.

However, because Oracle Database native network encryption and strong authentication requires Oracle Net Services to transmit data securely, these external authentication features are not supported by some parts of Oracle Financial, Human Resource, and Manufacturing Applications when they are running on Microsoft Windows.

The portions of these products that use Oracle Display Manager (ODM) do not take advantage of Oracle Database native network encryption and strong authentication, because ODM does not use Oracle Net Services.

Strong Authentication Administration Tools

You can use a set of strong authentication administration tools for native network encryption and public key infrastructure credentials.

- [About the Configuration and Administration Tools](#)
The configuration and administration tools manage the encryption, integrity (checksumming), and strong authentication methods for Oracle Net Services.
- [Native Network Encryption and Strong Authentication Configuration Tools](#)
Oracle Net Services can encrypt data using standard encryption algorithms, and for strong authentication methods, such as Kerberos, RADIUS, and SSL.
- [orapki Utility for Public Key Infrastructure Credentials Management](#)
The `orapki` utility manages certificate revocation lists (CRLs), creates and manages Oracle wallets, and creates signed certificates.
- [Duties of Strong Authentication Administrators](#)
Most of the tasks of a security administrator involve ensuring that the connections to and from Oracle databases are secure.

23.1 About the Configuration and Administration Tools

The configuration and administration tools manage the encryption, integrity (checksumming), and strong authentication methods for Oracle Net Services.

Strong authentication method configuration can include third-party software, as is the case for Kerberos or RADIUS, or it may entail configuring and managing a public key infrastructure for using digital certificates with Transport Layer Security (TLS).

23.2 Native Network Encryption and Strong Authentication Configuration Tools

Oracle Net Services can encrypt data using standard encryption algorithms, and for strong authentication methods, such as Kerberos, RADIUS, and SSL.

- [About Oracle Net Manager](#)
Oracle Net Manager configures Oracle Net Services for an Oracle home on a local client or server host.
- [Kerberos Adapter Command-Line Utilities](#)
The Kerberos adapter provides command-line utilities that obtain, cache, display, and remove Kerberos credentials.

23.2.1 About Oracle Net Manager

Oracle Net Manager configures Oracle Net Services for an Oracle home on a local client or server host.

Although you can use Oracle Net Manager, a graphical user interface tool, to configure Oracle Net Services, such as naming, listeners, and general network settings, it also enables you to configure the following features, which use the Oracle Net protocol:

- Strong authentication (Kerberos, RADIUS, and Transport Layer Security)
- Native network encryption (RC4, DES, 3DES, and AES)
- Checksumming for data integrity (MD5, SHA-1, SHA-2)

 **Note:**

The DES, 3DES112, 3DES168, MD5, and RC4 algorithms are deprecated in this release. To transition your Oracle Database environment to use stronger algorithms, download and install the patch described in My Oracle Support note [2118136.2](#).

23.2.2 Kerberos Adapter Command-Line Utilities

The Kerberos adapter provides command-line utilities that obtain, cache, display, and remove Kerberos credentials.

The following table briefly describes these utilities.

Table 23-1 Kerberos Adapter Command-Line Utilities

Utility Name	Description
okinit	Obtains Kerberos tickets from the Key Distribution Center (KDC) and caches them in the user's credential cache
oklist	Displays a list of Kerberos tickets in the specified credential cache
okdstry	Removes Kerberos credentials from the specified credential cache
okcreate	Automates the creation of keytabs from either the KDC or a service endpoint

 **Note:**

The Cybersafe adapter is not supported beginning with this release. You should use Oracle's Kerberos adapter in its place. Kerberos authentication with the Cybersafe KDC (Trust Broker) continues to be supported when using the Kerberos adapter.

Related Topics

- [Utilities for the Kerberos Authentication Adapter](#)
The Oracle Kerberos authentication adapter utilities are designed for an Oracle client with Oracle Kerberos authentication support installed.

23.3 orapki Utility for Public Key Infrastructure Credentials Management

The `orapki` utility manages certificate revocation lists (CRLs), creates and manages Oracle wallets, and creates signed certificates.

The basic syntax for this command-line utility is as follows:

```
orapki module command -option_1 argument ... -option_n argument
```

For example, the following command lists all certificate revocation lists (CRLs) in the CRL subtree in an instance of Oracle Internet Directory that is installed on `machine1.us.example.com` and that uses port 389:

```
orapki crl list -ldap machine1.us.example.com:389
```



Note:

The use of `orapki` to configure Transparent Data Encryption has been deprecated. Instead, use the `ADMINISTER KEY MANAGEMENT SQL` statement.

Related Topics

- [Certificate Revocation List Management](#)
 Certificate revocation list management entails ensuring that the CRLs are the correct format before you enable certificate revocation checking.
- [Managing Oracle Database Wallets and Certificates](#)
 You can use the `orapki` command line utility and `sqlnet.ora` parameters to manage public key infrastructure (PKI) elements.

23.4 Duties of Strong Authentication Administrators

Most of the tasks of a security administrator involve ensuring that the connections to and from Oracle databases are secure.

The following table describes the primary tasks of security administrators who are responsible for strong authentication, the tools used to perform the tasks, and links to where the tasks are documented.

Table 23-2 Common Security Administrator/DBA Configuration and Administrative Tasks

Task	Tools Used	See Also
Configure encrypted Oracle Net connections between database servers and clients	<code>sql.net</code> parameters or Oracle Net Manager	Configuring Encryption on the Client and the Server
Configure checksumming on Oracle Net connections between database servers and clients	<code>sql.net</code> parameters or Oracle Net Manager	Configuring Integrity on the Client and the Server
Configure database clients to accept RADIUS authentication	<code>sql.net</code> parameters or Oracle Net Manager	Step 1A: Configure RADIUS on the Oracle Client

Table 23-2 (Cont.) Common Security Administrator/DBA Configuration and Administrative Tasks

Task	Tools Used	See Also
Configure a database to accept RADIUS authentication	sql.net parameters or Oracle Net Manager	Step 1B: Configure RADIUS on the Oracle Database Server
Create a RADIUS user and grant them access to a database session	SQL*Plus	Step 2: Create a User and Grant Access
Configure Kerberos authentication on a database client and server	sql.net parameters or Oracle Net Manager	Step 6: Configure Kerberos Authentication
Create a Kerberos database user	<ul style="list-style-type: none"> kadmin.local Oracle Net Manager 	<ul style="list-style-type: none"> Step 7: Create a Kerberos User Step 8: Create an Externally Authenticated Oracle User
Manage Kerberos credentials in the credential cache	<ul style="list-style-type: none"> okinit oklist okdstry okcreate 	<ul style="list-style-type: none"> okinit Utility Options for Obtaining the Initial Ticket oklist Utility Options for Displaying Credentials okdstry Utility Options for Removing Credentials from the Cache File
Create a wallet for a database client or server	orapki utility	Creating a New Oracle Wallet in the Oracle Database Enterprise User Security Administrator's Guide
Request a user certificate from a certificate authority (CA) for SSL authentication	orapki utility	<ul style="list-style-type: none"> Adding a Certificate Request in the Oracle Database Enterprise User Security Administrator's Guide to add a certificate request 6.5.2.3 Importing the User Certificate into an Oracle Wallet in the Oracle Database Enterprise User Security Administrator's Guide to import a user certificate into an Oracle wallet
Import a user certificate and its associated trusted certificate (CA certificate) into a wallet	orapki utility	<ul style="list-style-type: none"> Importing a Trusted Certificate in the Oracle Database Enterprise User Security Administrator's Guide to import a trusted certificate Importing the User Certificate into an Oracle Wallet in the Oracle Database Enterprise User Security Administrator's Guide to import a user certificate into an Oracle wallet
Configuring SSL connections for a database client	orapki utility	Configuring TLS Connection With a Client Wallet
Configuring SSL connections for a database server	orapki utility	Configuring TLS Using a Public Certificate Authority Root of Trust for the Database Server Certificate
Enabling certificate validation with a certificate revocation list (CRL)	sql.net parameters or Oracle Net Manager	Configuring Certificate Validation with Certificate Revocation Lists

24

Configuring Kerberos Authentication

Kerberos is a trusted third-party authentication system that relies on shared secrets and presumes that the third party is secure.

- [Introduction to Kerberos on Oracle Database](#)
Kerberos is a networked authentication system that Oracle uses to authenticate Oracle Database users.
- [Enabling Kerberos Authentication](#)
To enable Kerberos authentication for Oracle Database, you must first install it, and then follow a set of configuration steps.
- [Utilities for the Kerberos Authentication Adapter](#)
The Oracle Kerberos authentication adapter utilities are designed for an Oracle client with Oracle Kerberos authentication support installed.
- [Connecting to an Oracle Database Server Authenticated by Kerberos](#)
After Kerberos is configured, you can connect to an Oracle database server without using a user name or password.
- [Configuring Interoperability with Microsoft Windows Server Domain Controller KDC](#)
You can configure Oracle Database to interoperate with a Microsoft Windows Server domain controller key distribution center (KDC).
- [Configuring Kerberos Authentication Fallback Behavior](#)
You can configure fallback behavior (password-based authentication) in case the Kerberos authentication fails.
- [Troubleshooting the Oracle Kerberos Authentication Configuration](#)
Oracle provides guidance for common Kerberos configuration problems.

24.1 Introduction to Kerberos on Oracle Database

Kerberos is a networked authentication system that Oracle uses to authenticate Oracle Database users.

- [Kerberos Components in a Typical Oracle Database Configuration](#)
The components in a typical Kerberos-authenticated configuration include the client, the Key Distribution Center (KDC), and an Oracle Database server.
- [Tickets Used in the Kerberos Configuration](#)
Oracle Database uses both the Kerberos client ticket granting ticket (TGT) and the client service ticket.
- [Kerberos Server Key Distribution Center](#)
The server key distribution center (KDC) coordinates the Kerberos components that work with an Oracle database.
- [How Oracle Database Works with Kerberos](#)
To configure an Oracle database to work with Kerberos, you must set the `userPrincipalName` and `servicePrincipalName` attributes for the Oracle database in the Kerberos server.

- [Oracle Database Parameters Used in a Kerberos Configuration](#)
Oracle Database provides client and server parameters for using Kerberos authentication.
- [How Authentication Works in an Oracle Database Kerberos Configuration](#)
The Kerberos authentication flow relies on the Kerberos-specific parameters that you set in the `sqlnet.ora` file and the `krb5.conf` file settings.

24.1.1 Kerberos Components in a Typical Oracle Database Configuration

The components in a typical Kerberos-authenticated configuration include the client, the Key Distribution Center (KDC), and an Oracle Database server.

- The client connects to the Oracle Database server.
- The KDC maintains a database of users and services (which are called principals in Kerberos). It provides authentication services and service tickets. Each unique Kerberos service requires its own service ticket. It should be on a separate system from the Oracle Database server.
- The Oracle Database server is presented with the client's Kerberos credentials.

The major configuration files are as follows:

- `krb5.conf`, used on the client, tells the client where to find the Kerberos server. Supported algorithms for `default_tkt_enctypes` and `default_tgs_enctypes` are as follows:
 - `aes128-cts-hmac-sha1-96`: `alias` - `aes128-cts`
 - `aes256-cts-hmac-sha1-96`: `aliases` - `aes256-cts`, `aes`
- `v5srvtab`, used on the Oracle Database server, is the configuration file for the application (in this case, an Oracle database). This file is a Kerberos keytab file, which contains the service keys (service principals) for the services offered by that host.
- `sqlnet.ora`, used on both the client and Oracle Database server, tells both the client and the database where to find their respective configuration files.

24.1.2 Tickets Used in the Kerberos Configuration

Oracle Database uses both the Kerberos client ticket granting ticket (TGT) and the client service ticket.

- [Kerberos Client Ticket Granting Ticket](#)
The client ticket granting ticket (TGT) describes the authorization to request services for the Kerberos connection.
- [Kerberos Client Service Ticket](#)
The client service ticket is generated after the user has successfully connected to the Oracle database.

24.1.2.1 Kerberos Client Ticket Granting Ticket

The client ticket granting ticket (TGT) describes the authorization to request services for the Kerberos connection.

The client reads the `krb5.conf` file to find the Kerberos server so that it can receive this TGT (`krbtgt`). The TGT that is sent to the client enables the client to access the appropriate services in the Kerberos Realm without having to re-authenticate each time the user wants to access a different service in that realm.

For example, in a Windows Active Directory domain, the Kerberos Realm is the same as the user's Windows domain. After the user has logged into Active Directory, the user's Windows credentials (Active Directory Kerberos tickets) can allow the user to access services in that Active Directory domain, if those services permit it.

The following `oklist` output shows an example of the tickets, which are automatically granted when a user first logs on as an Active Directory authenticated Windows user:

```
oklist
Kerberos Utilities for 32-bit Windows: Version 23.0.0.0.0 - Production on 15-
MAY-2023 11:50:39
Copyright (c) 1996, 2023 Oracle Corporation. All rights reserved.
Ticket cache: win2kcc
Default principal: user_name@host_name
Valid Starting Expires Principal
22-Oct-2004 12:10:05 15-MAY-2023 22:10:05 krbtgt /host_name@realm_name renew
until 29-Oct-2004 12:10:05
22-Oct-2004 12:10:05 15-MAY-2023 22:10:05 ldap/Active_Directory_host_name/
host_name@realm_name renew until 29-Oct-2004 12:10:05

22-Oct-2004 12:10:05 15-MAY-2023 22:10:05 host/
Active_Directory_host_name@host_name renew until 29-Oct-2004 12:10:05
```

This is similar to the Oracle Application Server single sign-on (SSO) application in that when the user receives SSO authentication, the user can access all applications in the SSO server's "realm" (that is, those external and partner applications that have been registered with the SSO server) without having to authenticate. In the preceding example, the Active Directory TGT for `realm_name` was automatically populated by Active Directory in the Windows Ticket cache when the user logged into Domain controller `realm_name`.

When Active Directory issues a ticket, there are two places where Oracle Database can retrieve the Kerberos credential on a Windows client. You can specify which location to use by setting the `KERBEROS5_CC_NAME` parameter in the `sqlnet.ora` file. If you want them placed in a file called `krb5.cc` in your `temp` directory, then set `KERBEROS5_CC_NAME` as follows:

```
SQLNET.KERBEROS5_CC_NAME = temp
```

If you specify the cache location to be a directory, then you must manually populate it with the `okinit` utility, an Oracle-supplied Kerberos utility.

If you wanted to use the Windows Native credential cache (the one that is automatically populated with the `krbtgt` when you log on) you would use the following setting:

```
SQLNET.KERBEROS5_CC_NAME=OSMSFT://
```

Because this is a native cache, automatically populated with the user's credentials when they log in to a Windows AD domain, the user does not need to use `okinit`. This location is normally fixed in an Active Directory environment.

You can use the Oracle-supplied utility `okinit` to populate the cache. To see the contents of the cache populated by `okinit`, run `oklist` utility. For example:

```
C:\> okinit user_name
Kerberos Utilities for 32-bit Windows: Version 23.0.0.0.0 - Production on 15-
MAY-2023 12:32:53
```

```
Copyright (c) 1996, 2023 Oracle Corporation. All rights reserved.  
Password for mailto:user_name@Realm : realm_name
```

```
C:\> oklist  
Kerberos Utilities for 32-bit Windows: Version 23.0.0.0.0 - Production on 15-  
MAY-2023 12:33:02  
Copyright (c) 1996, 2023 Oracle Corporation. All rights reserved.
```

```
Ticket cache: CC_path  
Default principal: user_name@host_name  
Valid Starting Expires Principal  
15-MAY-2023 12:32:57 15-MAY-2023 20:32:54 krbtgt/host_name@realm_name
```

This output shows that the directory cache now has the TGT.

24.1.2.2 Kerberos Client Service Ticket

The client service ticket is generated after the user has successfully connected to the Oracle database.

From the client configuration side the configuration is complete. All the user needs to do is connect to the database using the following syntax (assuming the user has a TNS alias defined in the `tnsnames.ora` file):

```
sqlplus /@tns_alias
```

In this case the `/` slash does not mean an external operating system authentication, but an external Kerberos authentication.

To view the client service ticket, run the `oklist` command. For example:

```
oklist  
....  
Valid Starting Expires Principal  
  
22-Oct-2022 12:32:57 22-Oct-2022 20:32:54 krbtgt/host_name@realm_name  
22-Oct-2022 12:43:19 22-Oct-2022 20:32:54 server_principal/  
Active_Directory_host_name@realm_name
```

24.1.3 Kerberos Server Key Distribution Center

The server key distribution center (KDC) coordinates the Kerberos components that work with an Oracle database.

The KDC is comprised of a database that stores all the system's principals and their associated encryption keys, a server to handle authentication, and the ticket granting server. With regard to Oracle Database, the KDC enables the following actions to take place:

- Active Directory verifying that the Active Directory user is a valid user from the Oracle database. You can do check with by running an `okinit Active_Directory_user` command.
- Active Directory granting a TGT to `Active_Directory_user` for the Active Directory domain `krbtgt/host_name@realm_name` connection.

- Active Directory granting to `Active_directory_user` a service ticket for the Oracle database so that the database login could occur (`sqlplus /@tns_alias`).

24.1.4 How Oracle Database Works with Kerberos

To configure an Oracle database to work with Kerberos, you must set the `userPrincipalName` and `servicePrincipalName` attributes for the Oracle database in the Kerberos server.

- The `userPrincipalName` attribute stores the name of a user who wants to log in to the Oracle database through Kerberos. When the client successfully initializes (using either `okinit` or another method, such as Active Directory), the password that the user enters is matched with the password that is stored for the user. If the passwords match, then the user is logged in, and is then granted a target granting ticket (TGT), which is stored either in a directory or native Windows cache.
- The `servicePrincipalName` attribute stores the service name, in this case, the server on which the Oracle database resides.

On Windows, the `userPrincipalName` and `servicePrincipalName` are created by the `ktpass` utility; on Linux, they are created by the `kadmin` utility. These utilities create a keytab file (`v5srvtab`), which Oracle Database uses to authenticate the user. This file also stores the service name. When the client connects, it uses the `SQLNET.AUTHENTICATION_KERBEROS5_SERVICE` parameter to request the service name (which for Oracle Database, is `oracle`), and the `SQLNET.KERBEROS5_KEYTAB` parameter to find the keytab file. Oracle provides a set of `sqlnet.ora` parameters that you can use to configure an Oracle database to authenticate with Kerberos using the Kerberos attributes.

You can check the contents of the keytab file by running the following command:

```
oklist -k
```

Output similar to the following appears:

```
Kerberos Utilities for 32-bit Windows: Version 23.0.0.0.0 - Production on 15-
MAY-2023 13:25:32
Copyright (c) 1996, 2023 Oracle Corporation. All rights reserved.
Service Key Table: <Keytab file with oath>
Ver Timestamp Principal

15-MAY-2023 16:00:00 server_principal/Active_Directory_host@host_name
```

Related Topics

- [Oracle Database Parameters Used in a Kerberos Configuration](#)
Oracle Database provides client and server parameters for using Kerberos authentication.

24.1.5 Oracle Database Parameters Used in a Kerberos Configuration

Oracle Database provides client and server parameters for using Kerberos authentication.

[Table 24-1](#) lists parameters to insert into the configuration files for clients and servers using Kerberos.

Table 24-1 Kerberos Authentication Parameters

File Name	Configuration Parameters
sqlnet.ora	<ul style="list-style-type: none"> • <code>SQLNET.AUTHENTICATION_SERVICES=(KERBEROS5)</code>: Set on both client and server. • <code>SQLNET.AUTHENTICATION_KERBEROS5_SERVICE=oracle</code>: Set on both client and server. • <code>SQLNET.KERBEROS5_CC_NAME=/usr/tmp/DCE-CC</code>: Not normally required on the server. If your client is on Microsoft Windows and is part of a domain, you may want to consider using the in-memory ticket cache and set this parameter to <code>OSMSFT://</code> or <code>MSLSA:.</code> • <code>SQLNET.KERBEROS5_CLOCKSKEW=1200</code>: Set on both client and server. • <code>SQLNET.KERBEROS5_CONF=/krb5/krb.conf</code>: Set on both client and server. (Normally, this path in the client is different from the path in the server.) • <code>SQLNET.KERBEROS5_CONF_MIT=(TRUE)</code>: Set this to <code>TRUE</code> on both the client and the server. • <code>SQLNET.KERBEROS5_REALMS=/krb5/krb.realms</code>: This setting is not usually required for the client or the server. • <code>SQLNET.KERBEROS5_KEYTAB=/krb5/v5srvtab</code>: Only set this parameter on the server, not the client. • <code>SQLNET.FALLBACK_AUTHENTICATION=FALSE</code>: Set on both client and server.
initialization parameter file	<ul style="list-style-type: none"> • <code>OS_AUTHENT_PREFIX=""</code>: Set this parameter only on the server, not the client.

Related Topics

- [Step 6C: Set sqlnet.ora Parameters \(Optional\)](#)
You can set optional `sqlnet.ora` parameters, in addition to the required parameters, for better security.

24.1.6 How Authentication Works in an Oracle Database Kerberos Configuration

The Kerberos authentication flow relies on the Kerberos-specific parameters that you set in the `sqlnet.ora` file and the `krb5.conf` file settings.

Authentication Flow

1. The user logs in to the client, which then obtains a ticket granting ticket (TGT).
 - If the Oracle database is using the native windows cache, then the TGT is automatically obtained when the user logs in. The `sqlnet.ora` file must have the following setting so that the TGT can be obtained:

```
SQLNET.KERBEROS5_CC_NAME=OSMSFT://
```

Alternatively, you can set it to `MSLSA:.`

- If the Oracle database is using a directory cache, then the `sqlnet.ora` file must have the following parameter set so that the database can find the location of the Kerberos server:

```
SQLNET.KERBEROS5_CC_NAME=CC_file_name_path
```

In addition, you must use the `okinit` utility to populate the cache with the TGT. The `oklist` utility will display the contents of the cache, `okdstry` will clear it, and the `sqlnet.ora` parameter (`TRACE_LEVEL_OKINIT=16`) will allow you to trace problems with an `sqlnet.ora` trace.

However, this type is not normally used on the server. If your client is on Microsoft Windows and is part of a domain, you may want to consider using the in-memory ticket cache and set the `SQLNET.KERBEROS5_CC_NAME` parameter to `OSMSFT://` or `MSLSA:.`

2. The client connects to the database:

```
sqlplus /@tns_alias
```

The Oracle database then performs the following actions:

- Retrieves the TGT from the location specified by the `SQLNET.KERBEROS5_CC_NAME` parameter
 - Reads the Kerberos service name from the `SQLNET.AUTHENTICATION_KERBEROS5_SERVICE` parameter
 - Packages the information from these parameters and sends it to the Kerberos server key distribution center (KDC), which will send back to the client a service ticket that is encrypted with the Oracle database's key
3. The client writes the encrypted service ticket to the credential cache and sends it to the Oracle database, which will decrypt the message by using a key from the keytab file.
 4. The Oracle database receives the client request, and performs the following actions.
 - Decodes the service ticket, extracting the following information: the requesting user's principal, the service principal, the list of IP addresses, the date and time when the service ticket was issued
 - Matches the service principal with the principal that is stored in the stored in the keytab file
 - Searches the user name table in the database for the user name that was extracted from the TGT. If the user exists and there is an authentication match, then the user is granted access.
 5. If the preceding steps are successful, then the client connects.

Client Configuration Files Used to Complete the Connection

`krb5.conf` file settings:

```
#  
  
[libdefaults]  
default_realm = realm name  
kdc = KDC_host:port  
}
```

```
realm name = {
kdc = KDC_host:port
}
```

```
[domain_realm]
.domain = host_name
```

Client `sqlnet.ora` file settings:

```
NAMES.DIRECTORY_PATH= (TNSNAMES)
NAMES.DEFAULT_DOMAIN = default_domain
trace_level_server=16
trace_level_client=16
trace_file_client=client_prefix
trace_directory_client=directory_path
trace_unique_client=true
trace_level_okinit=16
SQLNET.KERBEROS5_CONF=krb5.conf_path
SQLNET.KERBEROS5_CONF_MIT=TRUE
SQLNET.AUTHENTICATION_KERBEROS5_SERVICE=server_principal
SQLNET.AUTHENTICATION_SERVICES=(KERBEROS5)
SQLNET.KERBEROS5_CC_NAME=CC_filename_path
# SQLNET.KERBEROS5_CC_NAME=OSMSFT://
trace_level_okinit=16
```

Server Parameter Configuration

`sqlnet.ora` file settings on the Oracle Database server:

```
NAMES.DIRECTORY_PATH= (TNSNAMES)
NAMES.DEFAULT_DOMAIN = default_domain
trace_level_server=16
trace_level_client=16
trace_file_client=file_name_prefix
trace_directory_client=directory_path
trace_unique_client=true
SQLNET.KERBEROS5_CONF=krb5.conf_path
SQLNET.KERBEROS5_KEYTAB=keytab_file_path
SQLNET.KERBEROS5_CONF_MIT=TRUE
SQLNET.AUTHENTICATION_KERBEROS5_SERVICE=server_principal
SQLNET.AUTHENTICATION_SERVICES=(KERBEROS5)
SQLNET.KERBEROS5_CC_NAME=CC_file_name_path
# SQLNET.KERBEROS5_CC_NAME=OSMSFT://
```

24.2 Enabling Kerberos Authentication

To enable Kerberos authentication for Oracle Database, you must first install it, and then follow a set of configuration steps.

- [Step 1: Install Kerberos](#)
You should install Kerberos Version 5.

- [Step 2: Configure a Service Principal for an Oracle Database Server](#)
You must create a service principal for Oracle Database before the server can validate the identity of clients that authenticate themselves using Kerberos.
- [Step 3: Extract a Service Key Table from Kerberos](#)
Next, you are ready to extract the service key table from Kerberos and copy it to the Oracle database server/Kerberos client system.
- [Step 4: Install an Oracle Database Server and an Oracle Client](#)
After you extract a service key table from Kerberos, you are ready to install the Oracle Database server and an Oracle client.
- [Step 5: Configure Oracle Net Services and Oracle Database](#)
After you install the Oracle Database server and client, you can configure Oracle Net Services on the server and client.
- [Step 6: Configure Kerberos Authentication](#)
You must set the required parameters in the Oracle database server and client `sqlnet.ora` files.
- [Step 7: Create a Kerberos User](#)
You must create the Kerberos user on the Kerberos authentication server where the administration tools are installed.
- [Step 8: Create an Externally Authenticated Oracle User](#)
Next, you are ready to create an externally authenticated Oracle user.
- [Step 9: Get an Initial Ticket for the Kerberos/Oracle User](#)
Before you can connect to the database, you must ask the Key Distribution Center (KDC) for an initial ticket.

24.2.1 Step 1: Install Kerberos

You should install Kerberos Version 5.

The source distribution for notes about building and installing Kerberos provide details. After you install Kerberos, if you are using IBM AIX on POWER systems (64-bit), you should ensure that Kerberos 5 is the preferred authentication method.

1. Install Kerberos on the system that functions as the authentication server.

Note:

After upgrading from a 32-bit version of Oracle Database, the first use of the Kerberos authentication adapter causes an error message: `ORA-01637: Packet receive failed`.

Workaround: After upgrading to the 64-bit version of the database and before using Kerberos external authentication method, check for a file named `/usr/tmp/oracle_service_name.RC` on your computer, and remove it.

2. For IBM AIX on POWER systems (64-bit), check the authentication method.

For example:

```
/usr/bin/lsauthent
```

Output similar to the following may appear:

```
Standard Aix
```

3. Configure Kerberos 5 as the preferred method.

For example:

```
/usr/bin/chauthent -k5 -std
```

This command sets Kerberos 5 as the preferred authentication method (`k5`) and Standard AIX as the second (`std`).

4. To ensure that Kerberos 5 is now the preferred method, check the new configuration.

```
/usr/bin/lsauthent
```

```
Kerberos 5
Standard Aix
```

24.2.2 Step 2: Configure a Service Principal for an Oracle Database Server

You must create a service principal for Oracle Database before the server can validate the identity of clients that authenticate themselves using Kerberos.

1. Decide on a name for the service principal, using the following format:

```
kservice/kinstance@REALM
```

Each of the fields in the service principal specify the following values:

Service Principal Field	Description
<code>kservice</code>	A case-sensitive string that represents the Oracle service. This can be the same as the database service name.
<code>kinstance</code>	Typically the fully qualified DNS name of the system on which Oracle Database is running.
<code>REALM</code>	The name of the Kerberos realm with which the service principal is registered. <code>REALM</code> must always be uppercase and is typically the DNS domain name.

The utility names in this section are executable programs. However, the Kerberos user name `krbuser` and the realm `EXAMPLE.COM` are examples only.

For example, suppose `kservice` is `oracle`, the fully qualified name of the system on which Oracle Database is running is `dbserver.example.com` and the realm is `EXAMPLE.COM`. The principal name then is:

```
oracle/dbserver.example.com@EXAMPLE.COM
```

2. Run `kadmin.local` to create the service principal. On UNIX, run this command as the root user.

The service principal is a string that uniquely identifies a client or server to which a set of Kerberos credentials is assigned. It generally has three parts: `kservice/kinstance@REALM`. In the case of a user, `kservice` is the user name. Use the following syntax to create the principal:

```
# cd /kerberos-install-directory/sbin
# ./kadmin.local
```

For example, to add a principal named `oracle/dbserver.example.com@EXAMPLE.COM` to the list of server principals known by Kerberos, you can enter the following:

```
kadmin.local: addprinc -randkey oracle/dbserver.example.com@EXAMPLE.COM
```

24.2.3 Step 3: Extract a Service Key Table from Kerberos

Next, you are ready to extract the service key table from Kerberos and copy it to the Oracle database server/Kerberos client system.

For example, to extract a service key table for `dbserver.example.com`:

1. Ensure that you have domain administrative privileges.
2. Enter the following to extract the service key table:

```
kadmin.local: ktadd -k /tmp/keytab oracle/dbserver.example.com  
Entry for principal oracle/dbserver.example.com with kvno 2,  
encryption type AES-256 CTS mode with 96-bit SHA-1 HMAC added to keytab WRFILE:  
WRFILE:/tmp/keytab
```

```
kadmin.local: exit
```

3. To check the service key table, enter the following command:

```
oklist -k -t /tmp/keytab
```

4. After the service key table has been extracted, verify that the new entries are in the table in addition to the old ones.

If they are not, or you need to add more, use `kadmin.local` to append to them.

If you do not enter a realm when using `ktadd`, it uses the default realm of the Kerberos server. `kadmin.local` is connected to the Kerberos server running on the `localhost`.

5. If the Kerberos service key table is on the same system as the Kerberos client, you can move it. If the service key table is on a different system from the Kerberos client, you must transfer the file with a program such as FTP. If using FTP, transfer the file in binary mode.

The following example shows how to move the service key table on a UNIX platform:

```
# mv /tmp/keytab /etc/v5srvtab
```

The default name of the service file is `/etc/v5srvtab`.

6. Verify that the owner of the Oracle database server executable can read the service key table (`/etc/v5srvtab` in the previous example).

To do so, set the file owner to the Oracle user, or make the file readable by the group to which Oracle belongs.

Do not make the file readable to all users. This can cause a security breach.

24.2.4 Step 4: Install an Oracle Database Server and an Oracle Client

After you extract a service key table from Kerberos, you are ready to install the Oracle Database server and an Oracle client.

- See the Oracle Database operating system-specific installation documentation for instructions on installing the Oracle database server and client software.

24.2.5 Step 5: Configure Oracle Net Services and Oracle Database

After you install the Oracle Database server and client, you can configure Oracle Net Services on the server and client.

- See the following documentation for information on configuring Oracle Net Services on the Oracle database server and client.
 - Oracle Database operating system-specific installation documentation
 - *Oracle Database Net Services Administrator's Guide*

24.2.6 Step 6: Configure Kerberos Authentication

You must set the required parameters in the Oracle database server and client `sqlnet.ora` files.

Note:

The settings in the `sqlnet.ora` file apply to all pluggable databases (PDBs). However, this does not mean that all PDBs must authenticate with one KDC if you are using Kerberos; the settings in the `sqlnet.ora` file and Kerberos configuration files can support multiple KDCs.

- [Step 6A: Configure Kerberos on the Client and on the Database Server](#)
First, you must configure Kerberos authentication service parameters on the client and on the database server.
- [Step 6B: Set the Initialization Parameters](#)
Next, you are ready to set the `OS_AUTHENT_PREFIX` initialization parameter.
- [Step 6C: Set sqlnet.ora Parameters \(Optional\)](#)
You can set optional `sqlnet.ora` parameters, in addition to the required parameters, for better security.
- [Step 6D: Configure Kerberos to Use TCP or UDP \(Optional\)](#)
By default, Oracle Database uses TCP for Kerberos connections.

24.2.6.1 Step 6A: Configure Kerberos on the Client and on the Database Server

First, you must configure Kerberos authentication service parameters on the client and on the database server.

1. Log in to the server where the Oracle database resides.
2. At a minimum, modify the following `sqlnet.ora` parameters to these values:

```
SQLNET.AUTHENTICATION_SERVICES=(KERBEROS5)
SQLNET.AUTHENTICATION_KERBEROS5_SERVICE=kservice
```

In this specification:

- `SQLNET.AUTHENTICATION_SERVICES` specifies that the Oracle database will use Kerberos. Be aware that cross-realm Kerberos authentication is not supported using constraint delegation with the `KERBEROS5` or `KERKBEROS5PRE` adapter.

- `SQLNET.AUTHENTICATION_KERBEROS5_SERVICE` defines the name of the service Oracle Database uses to obtain a Kerberos service ticket. A service ticket is trusted information used to authenticate the client, to a specific service or server, for a predetermined period of time. It is obtained from the KDC using the initial ticket. When you provide the value for this field, the other fields are enabled.
3. Optionally, modify the following additional Kerberos parameters:

```
SQLNET.KERBEROS5_CC_NAME=path_to_Kerberos_credentials_cache_file
SQLNET.KERBEROS5_CLOCKSKEW=time_in_seconds
SQLNET.KERBEROS5_CONF=path_to_Kerberos_configuration_file_with_realm
SQLNET.KERBEROS5_CONF_LOCATION=path_to_Kerberos_configuration_file
SQLNET.KERBEROS5_KEYTAB=Kerberos_principal_secret_path
SQLNET.KERBEROS5_REALMS=path_to_Kerberos_realm_translation_file
SQLNET.KERBEROS5_REPLAY_CACHE=OS_MEMORY
```

In this specification:

- `SQLNET.KERBEROS5_CC_NAME` specifies the complete path to the Kerberos credentials cache file.
- `SQLNET.KERBEROS5_CLOCKSKEW` specifies how much time in seconds elapses before a Kerberos credential is considered out-of-date. The default is 300.
- `SQLNET.KERBEROS5_CONF` specifies the path name to the Kerberos configuration file that contains the realm for the default Key Distribution Center (KDC) and that maps realms to KDC hosts.
- `SQLNET.KERBEROS5_CONF_LOCATION` specifies the directory for the Kerberos configuration file. This parameter also specifies that the file is created by the system, and not by the client.
- `SQLNET.KERBEROS5_KEYTAB` specifies the path name to the Kerberos principal or, secret, key mapping file that extracts keys and decrypts incoming authentication information. The default paths are as follows:
 - **Linux and UNIX:** `/etc/v5srvtab`
 - **Microsoft Windows:** `c:\krb5\v5srvtab`
- `SQLNET.KERBEROS5_REALMS` specifies the complete path name to the Kerberos realm translation file that maps a host name or domain name to a realm.
- `SQLNET.KERBEROS5_REPLAY_CACHE` specifies that the replay cache is stored in operating system-managed memory on the server, and that file-based replay cache is not used.

24.2.6.2 Step 6B: Set the Initialization Parameters

Next, you are ready to set the `OS_AUTHENT_PREFIX` initialization parameter.

1. Locate the `init.ora` file.

By default, the `init.ora` file is located in the `ORACLE_HOME/dbs` directory (or the same location of the data files) on Linux and UNIX systems, and in the `ORACLE_HOME\database` directory on Windows.

2. In the `init.ora` file, set the value of `OS_AUTHENT_PREFIX` to null in the `init.ora` initialization parameter file.

For example:

```
OS_AUTHENT_PREFIX=""
```

Set this value to null because Kerberos user names can be long, and Oracle user names are limited to 30 bytes. Setting this parameter to null overrides the default value of `OPSS$`.

 **Note:**

You can create externally authenticated database users that have Kerberos user names of more than 30 bytes.

Related Topics

- [Step 8: Create an Externally Authenticated Oracle User](#)
Next, you are ready to create an externally authenticated Oracle user.

24.2.6.3 Step 6C: Set sqlnet.ora Parameters (Optional)

You can set optional `sqlnet.ora` parameters, in addition to the required parameters, for better security.

- Optionally, set the parameters listed in the following table on both the client and the Oracle database server.

Table 24-2 Kerberos-Specific sqlnet.ora Parameters

Parameter	Description
<code>SQLNET.KERBEROS5_CC_NAME=pathname_t o_credentials_cache_file OS_MEMORY</code>	<p>Specifies the complete path name to the Kerberos credentials cache (CC) file. This parameter can be used to configure multiple principals for the storage of credentials that are returned by Kerberos in encrypted format. The default value is operating system-dependent. For UNIX, it is <code>/tmp/krb5cc_userid</code>.</p> <p>Using the <code>OS_MEMORY</code> option indicates that an OS-managed memory credential cache is used for the credential cache file. This option is supported in all platforms.</p> <p>You can use the following formats to specify a value for <code>SQLNET.KERBEROS5_CC_NAME</code>:</p> <ul style="list-style-type: none"> • <code>SQLNET.KERBEROS5_CC_NAME=complete_path_to_cc_file</code> For example: <code>SQLNET.KERBEROS5_CC_NAME=/tmp/kcache</code> <code>SQLNET.KERBEROS5_CC_NAME=D:\tmp\kcache</code> • <code>SQLNET.KERBEROS5_CC_NAME=FILE:complete_path_to_cc_file</code> For example: <code>SQLNET.KERBEROS5_CC_NAME=FILE:/tmp/kcache</code> • <code>SQLNET.KERBEROS5_CC_NAME=OSMSFT://</code> Use this value if you are running Windows and using a Microsoft KDC. You can also set this parameter by using the <code>KRB5CCNAME</code> environment variable, but the value set in the <code>sqlnet.ora</code> file takes precedence over the value set in <code>KRB5CCNAME</code>. For example: <code>SQLNET.KERBEROS5_CC_NAME=/usr/tmp/krbcache</code>

Table 24-2 (Cont.) Kerberos-Specific sqlnet.ora Parameters

Parameter	Description
<code>SQLNET.KERBEROS5_CLOCKSKEW=number_of_seconds_accepted_as_network_delay</code>	<p>This parameter specifies how many seconds can pass before a Kerberos credential is considered out-of-date. It is used when a credential is actually received by either a client or a database server. An Oracle database server also uses it to decide if a credential needs to be stored to protect against a replay attack. The default is 300 seconds.</p> <p>For example:</p> <pre>SQLNET.KERBEROS5_CLOCKSKEW=1200</pre>
<code>SQLNET.KERBEROS5_CONF=pathname_to_Kerberos_configuration_file AUTO_DISCOVER</code>	<p>This parameter specifies the complete path name to the Kerberos configuration file. The configuration file contains the realm for the default KDC (key distribution center) and maps realms to KDC hosts. The default is operating system-dependent. For UNIX, it is <code>/krb5/krb.conf</code>.</p> <p>Using the <code>AUTO_DISCOVER</code> option in place of the configuration file enables Kerberos clients to auto-discover the KDC.</p> <p>For example:</p> <pre>SQLNET.KERBEROS5_CONF=/krb/krb.conf SQLNET.KERBEROS5_CONF=AUTO_DISCOVER</pre>
<code>SQLNET.KERBEROS5_CONF_LOCATION=path_to_Kerberos_configuration_directory</code>	<p>This parameter indicates that the Kerberos configuration file is created by the system, and does not need to be specified by the client. The configuration file uses DNS lookup to obtain the realm for the default KDC, and maps realms to KDC hosts.</p> <p>For example:</p> <pre>SQLNET.KERBEROS5_CONF_LOCATION=/krb</pre>
<code>SQLNET.KERBEROS5_KEYTAB=path_to_Kerberos_principal/key_table</code>	<p>This parameter specifies the complete path name to the Kerberos principal/secret key mapping file. It is used by the Oracle database server to extract its key and decrypt the incoming authentication information from the client. The default is operating system-dependent. For UNIX, it is <code>/etc/v5srvtab</code>.</p> <p>For example:</p> <pre>SQLNET.KERBEROS5_KEYTAB=/etc/v5srvtab</pre>
<code>SQLNET.KERBEROS5_REALMS=path_to_Kerberos_realm_translation_file</code>	<p>This parameter specifies the complete path name to the Kerberos realm translation file. The translation file provides a mapping from a host name or domain name to a realm. The default is operating system-dependent. For UNIX, it is <code>/etc/krb.realms</code>.</p> <p>For example:</p> <pre>SQLNET.KERBEROS5_REALMS=/krb5/krb.realms</pre>

24.2.6.4 Step 6D: Configure Kerberos to Use TCP or UDP (Optional)

By default, Oracle Database uses TCP for Kerberos connections.

- To control whether an Oracle databases uses TCP or UDP, set the `forcetcp` parameter, located in the `libdefaults` section of the `krb5.conf` file, as follows:

- To use TCP connections:

```
forcetcp = 1
```

- To use UDP connections:

```
forcetcp = 0
```

24.2.7 Step 7: Create a Kerberos User

You must create the Kerberos user on the Kerberos authentication server where the administration tools are installed.

The realm must already exist.

Note:

The utility names in this section are executable programs. However, the Kerberos user name `krbuser` and realm `EXAMPLE.COM` are examples only. They can vary among systems.

- Run `/krb5/admin/kadmin.local` as root to create a new Kerberos user, such as `krbuser`.

For example, to create a Kerberos user is UNIX-specific:

```
# /krb5/admin/kadmin.local
kadmin.local: addprinc krbuser
Enter password for principal: "krbuser@example.com": (password does not display)
Re-enter password for principal: "krbuser@example.com": (password does not display)
kadmin.local: exit
```

24.2.8 Step 8: Create an Externally Authenticated Oracle User

Next, you are ready to create an externally authenticated Oracle user.

1. Log in to a PDB as a user who has the `CREATE USER` privilege.

```
sqlplus sec_admin@pdb_name
Enter password: password
```

To find the available PDBs in a CDB, log in to the CDB root container and then query the `PDB_NAME` column of the `DBA_PDBS` data dictionary view. To check the current container, run the `show con_name` command.

2. Ensure that the `OS_AUTHENT_PREFIX` is set to null (`''`).
3. Create an Oracle Database user account that corresponds to the Kerberos user. Enter the Oracle user name in uppercase and enclose it in double quotation marks.

For example:

```
CREATE USER krbuser IDENTIFIED EXTERNALLY AS 'krbuser@example.com';
GRANT CREATE SESSION TO krbuser;
```

 **Note:**

The database administrator should ensure that multiple database users are not identified externally by the same Kerberos principal name.

24.2.9 Step 9: Get an Initial Ticket for the Kerberos/Oracle User

Before you can connect to the database, you must ask the Key Distribution Center (KDC) for an initial ticket.

An initial ticket or ticket granting ticket (TGT) identifies the user as having the right to ask for additional service tickets. No tickets can be obtained without an initial ticket. An initial ticket is retrieved by running the `okinit` program and providing a password.

If more than one Kerberos principal will use this client to authenticate, then each Kerberos principal must get an initial ticket and store it in a credential cache in its own directory. Additional Kerberos users and the credential cache location (other than the one described in the `sqlnet.ora` file) can be specified either in the connect string or in `tnsnames.ora`.

- To request an initial ticket, run the following command on the client:

```
% okinit username
```

If you want to enable credentials that can be used across database links, then include the `-f` option and provide the Kerberos password when prompted.

```
% services/okinit -f
Password for krbuser@EXAMPLE.COM: (password does not display)
```

 **Note:**

The following check is only required when using the `KERBEROS5PRE` adapter. It is not required for the `KERBEROS5` adapter. The use of the `KERBEROS5PRE` adapter is deprecated with Oracle Database 21c. Oracle recommends that you use the `KERBEROS5` adapter instead.

If you encounter an error such as `okinit: Cannot contact any KDC for requested realm`, then check the `/etc/services` file if there are the `kerberos5` entries. For example:

```
kerberos      88/tcp        kerberos5 krb5 # Kerberos v5
kerberos      88/udp        kerberos5 krb5 # Kerberos v5
```

Related Topics

- [Oracle Database Net Services Administrator's Guide](#)
- [Oracle Database Net Services Reference](#)

24.3 Utilities for the Kerberos Authentication Adapter

The Oracle Kerberos authentication adapter utilities are designed for an Oracle client with Oracle Kerberos authentication support installed.

- [okinit Utility Options for Obtaining the Initial Ticket](#)
The `okinit` utility obtains and caches Kerberos tickets.
- [oklist Utility Options for Displaying Credentials](#)
The `oklist` utility displays the list of tickets held.
- [okdstry Utility Options for Removing Credentials from the Cache File](#)
The `okdstry` (`okdestroy`) utility removes credentials from the cache file.
- [okcreate Utility Options for Automatic Keytab Creation](#)
The `okcreate` utility automates the creation of keytabs from either the KDC or a service endpoint.

24.3.1 okinit Utility Options for Obtaining the Initial Ticket

The `okinit` utility obtains and caches Kerberos tickets.

This utility is typically used to obtain the ticket-granting ticket, using a password entered by the user to decrypt the credential from the key distribution center (KDC). The ticket-granting ticket is then stored in the user's credential cache.

The following table lists the options available with `okinit`. To use the functionality that is described in this table, you must set the `sqlnet.ora` `SQLNET.KERBEROS5_CONF_MIT` parameter to `TRUE`. (Note that `SQLNET.KERBEROS5_CONF_MIT` is deprecated, but is retained for backward compatibility for `okinit`.)

Table 24-3 Options for the okinit Utility

Option	Description
<code>-f -F</code>	Requests forwardable or non-forwardable tickets. This option is necessary to follow database links.
<code>-l lifetime</code>	Specifies the lifetime of the ticket-granting ticket and all subsequent tickets. By default, the ticket-granting ticket is good for eight (8) hours, but shorter or longer-lived credentials may be desired. The KDC can ignore this option or put site-configured limits on what can be specified. The lifetime value is a string that consists of a number qualified by <code>w</code> (weeks), <code>d</code> (days), <code>h</code> (hours), <code>m</code> (minutes), or <code>s</code> (seconds), as in the following example: <pre>okinit -l 2w1d6h20m30s</pre> The example requests a ticket-granting ticket that has a lifetime of 2 weeks, 1 day, 6 hours, 20 minutes, and 30 seconds.
<code>-s start_time</code>	Specifies the duration of the delay before the ticket can become valid. Tickets are issued with the invalid flag set.
<code>-r renewable_life</code>	Requests renewable tickets with a total lifetime of <code>renewable_life</code>
<code>-p -P</code>	Requests proxiable or non-proxiable tickets
<code>-a</code>	Requests tickets that are restricted to the local address of the host
<code>-A</code>	Requests tickets not restricted by address
<code>-E</code>	Treats the principal name as an enterprise name
<code>-v</code>	Requests that the ticket-granting ticket in the cache be passed to the KDC for validation. If the ticket is within the requested time range, then the cache is replaced with the validated ticket.
<code>-R</code>	Requests renewal of the ticket-granting ticket
<code>-k [-t keytab_file]</code>	Requests a ticket, which is obtained from a key in the local host's keytab

Table 24-3 (Cont.) Options for the okinit Utility

Option	Description
-n	Requests anonymous processing
-C	Requests canonicalization of the principal name, and enables the KDC to reply with a different client principal from the one that was requested
-c <i>cache_name</i>	Specifies the name of a cache as a cache location. You can specify an encrypted cache file if the file-based cache was specified through the <code>KERBEROS5_CC_NAME sqlnet.ora</code> parameter. You can also specify an alternate credential cache by setting <code>SQLNET.KERBEROS5_CC_NAME</code> in <code>sqlnet.ora</code> . For UNIX, the default is <code>/tmp/krb5cc_uid</code> .
-I <i>input_cache</i>	Specifies the name of a credential cache that already contains a ticket. When it obtains that ticket, if the information about how the ticket was obtained is stored in cache, then the same information will be used to affect how new credentials are obtained.
-T <i>armor_cache</i>	If supported by the KDC, this cache is used to armor the request, preventing offline dictionary attacks and enabling the use of additional pre-authentication mechanisms.
-X <i>attribute[=value]</i>	Specifies a pre-authentication attribute and value. Specifies one of the following values: <ul style="list-style-type: none"> <code>X509_user_identity=value</code> specifies where to find the user's X509 identity information <code>X509_anchors=value</code> specifies where to find trusted X509 anchor information <code>flag_RSA_PROTOCOL[=yes]</code> specifies the use of RSA rather than the default Diffie-Hellman protocol
-?	List command line options.

24.3.2 oklist Utility Options for Displaying Credentials

The `oklist` utility displays the list of tickets held.

The following table lists the available `oklist` options. To use the functionality that is described in this table, you must set the `sqlnet.ora SQLNET.KERBEROS5_CONF_MIT` parameter to `TRUE`. (Note that `SQLNET.KERBEROS5_CONF_MIT` is deprecated, but is retained for backward compatibility for `oklist`.)

Table 24-4 Options for the oklist Utility

Option	Description
-f	Show flags with credentials. Relevant flags are: <ul style="list-style-type: none"> I, credential is a ticket-granting ticket F, credential is forwardable f, credential is forwarded.
-c	Specify an alternative credential cache. The alternate credential cache, including encrypted cache files, can also be specified by using the <code>SQLNET.KERBEROS5_CC_NAME</code> parameter in the <code>sqlnet.ora</code> file. In UNIX, the default is <code>/tmp/krb5cc_uid</code> .

Table 24-4 (Cont.) Options for the oklist Utility

Option	Description
-k	List the entries in the service table (default <code>/etc/v5srvtab</code>) on UNIX. The alternate service table can also be specified by using the <code>SQLNET.KERBEROS5_KEYTAB</code> parameter in the <code>sqlnet.ora</code> file.
-e	Displays the encryption types of the session key and the ticket for each credential in the credential cache, or each key in the keytab file.
-l	If a cache collection is available, displays a table summarizing the caches present in the collection.
-A	If a cache collection is available, displays the contents of all of the caches in the collection
-s	Runs utility without producing output. Utility will exit with status 1 if the cache cannot be read or is expired, else with status 0
-a	Displays a list of addresses in the credential
-n	Shows numeric addresses instead of reverse-resolving addresses
-C	Lists configuration data that has been stored in the credentials cache when <code>klist</code> encounters it. By default, configuration data is not listed.
-t	Displays the time entry timestamps for each keytab entry in the keytab file
-K	Displays the value of the encryption key in each keytab entry in the keytab file
-V	Displays the Kerberos version number and exit.

The show flag option (`-f`) displays additional information, as shown in the following example:

```
% oklist -f
06/09/23 22:32:23 06/10/23 22:32:23
krbtgt/EXAMPLE.COM@EXAMPLE.COM
```

24.3.3 okdstry Utility Options for Removing Credentials from the Cache File

The `okdstry` (`okdestroy`) utility removes credentials from the cache file.

The following table lists the available `okdstry` options. To use the functionality that is described in this table, you must set the `sqlnet.ora` `SQLNET.KERBEROS5_CONF_MIT` parameter to `TRUE`. (Note that `SQLNET.KERBEROS5_CONF_MIT` is deprecated, but is retained for backward compatibility for `okdstry`.)

Table 24-5 Options for the okdstry Utility

Option	Description
-A	Destroys all caches in the collection, if a cache collection is available
-q	Runs quietly. Normally <code>okdstry</code> beeps if it fails to destroy the user's tickets. This flag suppresses this behavior.
-c <i>cache_name</i>	Uses <i>cache_name</i> as the credentials (ticket) cache name and location, including encrypted cache files if the file-based cache was specified through the <code>KERBEROS5_CC_NAME</code> <code>sqlnet.ora</code> parameter. For UNIX, the default is <code>/tmp/krb5cc_uid</code> .

24.3.4 okcreate Utility Options for Automatic Keytab Creation

The `okcreate` utility automates the creation of keytabs from either the KDC or a service endpoint.

The following table lists the available `okcreate` options.

Table 24-6 okcreate Utility Options for Automatic Keytab Creation

Option	Description
<code>-name service_name</code>	Specifies the service name of the kerberized service for which to get a keytab. The default is <code>oracle</code> .
<code>-hosts path-to_hosts_list</code>	Specifies either a comma-separated list of hosts for which to get the keytab, or the path to a text file that contains a list of the hosts. The default is <code>none</code> .
<code>-out path_to_output</code>	Specifies the output path to store the resulting keytabs. The default is the current directory. Ensure that this directory is readable only by the root user. Never send keytabs over the network in clear text.
<code>-k</code>	For use if the operation is performed on the KDC. Do not use this option if you are using <code>-s</code> .
<code>-s</code>	For use if the operation is performed on a Kerberized service. Do not use this option if you are using <code>-k</code> .
<code>-u KDC_username</code>	Specifies the user name for the KDC. Only use this setting on a Kerberized service endpoint. If you specify the <code>-s</code> and omit this setting, then <code>okcreate</code> prompts for the <code>KDCuser@KDCmachine</code> .
<code>-r</code>	Specifies the Kerberos realm
<code>-p</code>	Specifies the Kerberos principal
<code>-q</code>	Specifies the Kerberos query
<code>-d</code>	Specifies the KDC database name
<code>-e</code>	Specifies the salt list to be used for any new keys that are created
<code>-m</code>	Specifies to prompt for the KDC main password

24.4 Connecting to an Oracle Database Server Authenticated by Kerberos

After Kerberos is configured, you can connect to an Oracle database server without using a user name or password.

- Use the following syntax to connect to the database without using a user name or password:

```
$ sqlplus /@net_service_name
```

In this specification, `net_service_name` is an Oracle Net Services service name. For example:

```
$ sqlplus /@oracle_dbname
```

24.5 Configuring Interoperability with Microsoft Windows Server Domain Controller KDC

You can configure Oracle Database to interoperate with a Microsoft Windows Server domain controller key distribution center (KDC).

- [About Configuring Interoperability with a Microsoft Windows Server Domain Controller KDC](#)
Oracle Database complies with MIT Kerberos.
- [Step 1: Configure Oracle Kerberos Client for Microsoft Windows Server Domain Controller](#)
You can configure the Oracle Kerberos client to interoperate with a Microsoft Windows Server Domain Controller KDC.
- [Step 2: Configure a Microsoft Windows Server Domain Controller KDC for the Oracle Client](#)
Next, you are ready to configure a Microsoft Windows Server Domain Controller KDC to interoperate with an Oracle Client.
- [Step 3: Configure Oracle Database for a Microsoft Windows Server Domain Controller KDC](#)
You must configure the Oracle database for the domain controller on the host computer where the Oracle database is installed.
- [Step 4: Obtain an Initial Ticket for the Kerberos/Oracle User](#)
Before a client can connect to the database, the client must request an initial ticket.

24.5.1 About Configuring Interoperability with a Microsoft Windows Server Domain Controller KDC

Oracle Database complies with MIT Kerberos.

This enables Oracle Database to interoperate with tickets that are issued by a Kerberos Key Distribution Center (KDC) on a Microsoft Windows Server domain controller. This process enables Kerberos authentication with an Oracle database.

24.5.2 Step 1: Configure Oracle Kerberos Client for Microsoft Windows Server Domain Controller

You can configure the Oracle Kerberos client to interoperate with a Microsoft Windows Server Domain Controller KDC.

- [Step 1A: Create the Client Kerberos Configuration Files](#)
You must configure a set of client Kerberos configuration files that refer to the Windows 2008 domain controller as the Kerberos KDC.
- [Step 1B: Specify the Oracle Configuration Parameters in the sqlnet.ora File](#)
Configuring an Oracle client to interoperate with a Microsoft Windows Server Domain Controller Kerberos Key Distribution Center (KDC) uses the same `sqlnet.ora` file parameters that are used for configuring Kerberos on the client and on the database server.
- [Step 1C: Optionally, Specify Additional Kerberos Principals Using tnsnames.ora](#)
You can configure additional Kerberos principal users to connect from an Oracle Database client.

- **Step 1D: Specify the Listening Port Number**
The Microsoft Windows Server domain controller KDC listens on UDP/TCP port 88.

24.5.2.1 Step 1A: Create the Client Kerberos Configuration Files

You must configure a set of client Kerberos configuration files that refer to the Windows 2008 domain controller as the Kerberos KDC.

- **Create the `krb.conf` and `krb5.realms` files.** Oracle Database provides a default `krb5.conf` file, which you must modify for your site.

The `krb5.conf` file is located in the location indicated by the `SQLNET.KERBEROS_CONF` parameter.

For example, assuming that the Windows 2008 domain controller is running on a node named `sales3854.us.example.com`:

– **`krb.conf` file**

For example:

```
SALES3854.US.EXAMPLE.COM
SALES3854.US.EXAMPLE.COM
sales3854.us.example.com admin server
```

– **`krb5.conf` file**

For example:

```
[libdefaults]
default_realm=SALES.US.EXAMPLE.COM
[realms]
SALES.US.EXAMPLE.COM= { kdc=sales3854.us.example.com:88 }
[domain_realm]
.us.example.com=SALES.US.EXAMPLE.COM
```

– **`krb5.realms` file**

For example:

```
us.example.com SALES.US.EXAMPLE.COM
```

24.5.2.2 Step 1B: Specify the Oracle Configuration Parameters in the `sqlnet.ora` File

Configuring an Oracle client to interoperate with a Microsoft Windows Server Domain Controller Kerberos Key Distribution Center (KDC) uses the same `sqlnet.ora` file parameters that are used for configuring Kerberos on the client and on the database server.

- **Set the following parameters in the `sqlnet.ora` file on the client:**

```
SQLNET.KERBEROS5_CONF=pathname_to_Kerberos_configuration_file
SQLNET.KERBEROS5_CONF_MIT=TRUE
SQLNET.AUTHENTICATION_KERBEROS5_SERVICE=Kerberos_service_name
SQLNET.AUTHENTICATION_SERVICES=(BEQ,KERBEROS5)
```

Note the following:

- The `SQLNET.KERBEROS5_CONF_MIT` parameter has been deprecated, but is retained for backward compatibility for the `okint`, `oklist`, and `okdstry` utilities.
- Ensure that the `SQLNET.KERBEROS5_CONF_MIT` parameter is set to `TRUE` because the Windows Server operating system is designed to interoperate only with security services that are based on MIT Kerberos version 5.

- If you want to use multiple Kerberos principal users, then you can specify them as part of a connect string or in `tnsnames.ora`.

Related Topics

- [Step 6A: Configure Kerberos on the Client and on the Database Server](#)
First, you must configure Kerberos authentication service parameters on the client and on the database server.
- [Step 1C: Optionally, Specify Additional Kerberos Principals Using `tnsnames.ora`](#)
You can configure additional Kerberos principal users to connect from an Oracle Database client.

24.5.2.3 Step 1C: Optionally, Specify Additional Kerberos Principals Using `tnsnames.ora`

You can configure additional Kerberos principal users to connect from an Oracle Database client.

- Add the `KERBEROS5_CC_NAME` and `KERBEROS5_PRINCIPAL` settings to the `tnsnames.ora` connect string.

`KERBEROS5_CC_NAME` is mandatory for all additional Kerberos users and principals, but the `KERBEROS5_PRINCIPAL` setting is optional. `KERBEROS5_CC_NAME` supports multiple principals and the storage of credentials that are returned by the Key Distribution Center (KDC) in encrypted form. `KERBEROS5_PRINCIPAL` can be specified in the `sqlnet.ora` file as well as `tnsnames.ora`. Oracle Database checks `KERBEROS5_PRINCIPAL` against the value that is retrieved from the credential cache. If the two values do not match, then the user is not authenticated.

For example:

```
krbuser1 =
(DESCRIPTION=(ADDRESS=(PROTOCOL=tcp)(HOST=hostname)(PORT=port_number))
(CONNECT_DATA=(SERVICE_NAME=db.example.com))
(SEcurity=(KERBEROS5_CC_NAME = /tmp/krbuser1/krb.cc)
(KERBEROS5_PRINCIPAL = krbprinc1@example.com)))
krbuser2 =
(DESCRIPTION=(ADDRESS=(PROTOCOL=tcp)(HOST=hostname)(PORT=port_number))
(CONNECT_DATA=(SERVICE_NAME=db.example.com))
(SEcurity=(KERBEROS5_CC_NAME = /tmp/krbuser2/krb.cc)
(KERBEROS5_PRINCIPAL = krbprinc2@example.com)))
```

Related Topics

- [Oracle Database Net Services Reference](#)

24.5.2.4 Step 1D: Specify the Listening Port Number

The Microsoft Windows Server domain controller KDC listens on UDP/TCP port 88.

1. Ensure that the system file entry for `kerberos5` is set to UDP/TCP port 88.

2.  Note:

This step is only required when using the `KERBEROS5PRE` adapter. This step can be skipped when using the `KERBEROS5` adapter.
The use of the `KERBEROS5PRE` adapter is deprecated with Oracle Database 21c. Oracle recommends that you use the `KERBEROS5` adapter instead.

For the UNIX environment, ensure that the first `kerberos5` entry in the `/etc/services` file is set to 88.

24.5.3 Step 2: Configure a Microsoft Windows Server Domain Controller KDC for the Oracle Client

Next, you are ready to configure a Microsoft Windows Server Domain Controller KDC to interoperate with an Oracle Client.

- [Step 2A: Create the User Account](#)
You must create a user account for the Microsoft Windows Server Domain Controller KDC.
- [Step 2B: Create the Oracle Database Principal User Account and Keytab](#)
After you create the user account, you are ready to create the Oracle Database principal user account.

 See Also:

Microsoft documentation for information about how to create users in Active Directory.

24.5.3.1 Step 2A: Create the User Account

You must create a user account for the Microsoft Windows Server Domain Controller KDC.

- On the Microsoft Windows Server domain controller, create a new user account for the Oracle client in Microsoft Active Directory.

24.5.3.2 Step 2B: Create the Oracle Database Principal User Account and Keytab

After you create the user account, you are ready to create the Oracle Database principal user account.

After you create this account on the Windows Server domain controller, you must use the `okcreate` utility to register it with the principal keytab. You can run this utility on the same KDC to create all the service keytabs rather than creating them individually, or you can run `okcreate` from a service endpoint that connects to the KDC, run the necessary commands, and then copy the resulting keytab back to the service endpoint.

1. Create a new user account for the Oracle database in Microsoft Active Directory.

For example, if the Oracle database runs on the host `sales3854.us.example.com`, then use Active Directory to create a user with the user name `sales3854.us.example.com`.

Do not create a user as `host/hostname.dns.com`, such as `oracle/sales3854.us.example.com`, in Active Directory. Microsoft's KDC does not support multipart names like an MIT KDC does. An MIT KDC allows multipart names to be used for service principals because it treats all principals as user names. However, Microsoft's KDC does not.

2. Run the `okcreate` command to create a keytab that will use this user account. The syntax is as follows:

```
okcreate (-s [-u KDCuser@KDCmachine] | -k)
        [-name service_name] [-hosts path_to_host_list]
        [-out path_to_output] [-r realm] [-p principal]
        [-q query] [-d dbname] [-e enc:salt...] [-m]
        [-x db_args]
```

For example:

```
okcreate -s -u kdcuser1@kdcmachine1 -name oracle
        -hosts sales3854.us.example.com
        -out /OSsecured/keytablocation
```

3. Copy the extracted keytab file to the host computer where the Oracle database is installed.

For example, the keytab that was created in the previous step can be copied to `/krb5/v5svrtab`.

24.5.4 Step 3: Configure Oracle Database for a Microsoft Windows Server Domain Controller KDC

You must configure the Oracle database for the domain controller on the host computer where the Oracle database is installed.

- [Step 3A: Set Configuration Parameters in the sqlnet.ora File](#)
You must first set configuration parameters for the database.
- [Step 3B: Create an Externally Authenticated Oracle User](#)
After you set the configuration parameters, you are ready to create an externally authenticated Oracle user.

24.5.4.1 Step 3A: Set Configuration Parameters in the sqlnet.ora File

You must first set configuration parameters for the database.

- Specify values for the following parameters in the `sqlnet.ora` file for the database server:

```
SQLNET.KERBEROS5_CONF=pathname_to_Kerberos_configuration_file
SQLNET.KERBEROS5_KEYTAB=pathname_to_Kerberos_principal/key_table
SQLNET.KERBEROS5_CONF_MIT=TRUE
SQLNET.AUTHENTICATION_KERBEROS5_SERVICE=Kerberos_service_name
SQLNET.AUTHENTICATION_SERVICES=(BEQ,KERBEROS5)
```

 **Note:**

- The `SQLNET.KERBEROS5_CONF_MIT` parameter has been deprecated, but is retained for backward compatibility for the `okint`, `oklist`, and `okdstry` utilities.
- Ensure that the `SQLNET.KERBEROS5_CONF_MIT` parameter is set to `TRUE` because the Windows Server operating system is designed to interoperate only with security services that are based on MIT Kerberos version 5.
- Be aware that the settings in the `sqlnet.ora` file apply to all PDBs. However, this does not mean that all PDBs must authenticate with one KDC if using Kerberos; the settings in the `sqlnet.ora` file and Kerberos configuration files can support multiple KDCs.

24.5.4.2 Step 3B: Create an Externally Authenticated Oracle User

After you set the configuration parameters, you are ready to create an externally authenticated Oracle user.

- Follow the procedure under [Step 8: Create an Externally Authenticated Oracle User](#) to create an externally authenticated Oracle user.

Ensure that you create the username in all uppercase characters (for example, `ORAKRB@SALES.US.EXAMPLE.COM`).

 **See Also:**

[Step 6: Configure Kerberos Authentication](#) for information about setting the `sqlnet.ora` file parameters.

24.5.5 Step 4: Obtain an Initial Ticket for the Kerberos/Oracle User

Before a client can connect to the database, the client must request an initial ticket.

1. To request an initial ticket, follow the task information for [Step 9: Get an Initial Ticket for the Kerberos/Oracle User](#).

The user does not need to explicitly request for an initial ticket, using the `okinit` command, when using the Windows native cache.

If the Oracle client is running on Microsoft Windows Server or later, then the Kerberos ticket is automatically retrieved when the user logs in to Windows.

See also the Microsoft documentation for details about the `Kerbtray.exe` utility, which can be used to display Kerberos ticket information for a system.

2. For each Kerberos principal user that you have added to `tnsnames.ora`, run the `okinit` command in the client.

For example:

```
okinit krbprincl@example.com
```

24.6 Configuring Kerberos Authentication Fallback Behavior

You can configure fallback behavior (password-based authentication) in case the Kerberos authentication fails.

After you have configured Kerberos authentication for Oracle clients to use Kerberos authentication to authenticate to an Oracle database, there are cases where you may want to fall back to password-based authentication. An example would be if you have fixed user database links in the Oracle database.

- To enable Kerberos authentication to fall back to password-based authentication, set the `SQLNET.FALLBACK_AUTHENTICATION` parameter to `TRUE` in the `sqlnet.ora` files on both the client and server.

The default of this parameter is `FALSE`. This means that by default, the connection fails when Kerberos authentication fails.

Related Topics

- *Oracle Database Net Services Reference*

24.7 Troubleshooting the Oracle Kerberos Authentication Configuration

Oracle provides guidance for common Kerberos configuration problems.

- [Common Kerberos Configuration Problems](#)
Oracle provides guidance for common Kerberos configuration problems.
- [ORA-12631 Errors in the Kerberos Configuration](#)
The `ORA-12631: username retrieval failed` error can result from the wrong or incorrectly formatted principal being used for the Kerberos authentication
- [ORA-28575 Errors in the Kerberos Configuration](#)
The `ORA-28575: unable to open RPC connection to external procedure agent` error can occur when the client is remote and the `EXTPROC` process is spawned.
- [ORA-01017 Errors in the Kerberos Configuration](#)
The `ORA-01017: invalid username/password; logon denied` error can result if `okinit` fails and there is no valid ticket in the `SQL*Plus` connection.
- [Enabling Tracing for Kerberos okinit Operations](#)
The `KRB5_TRACE` environment variable enables you to trace Kerberos `okinit` operations.

24.7.1 Common Kerberos Configuration Problems

Oracle provides guidance for common Kerberos configuration problems.

Common problems are as follows:

- If you cannot get your ticket-granting ticket using `okinit`:
 - Ensure that the default realm is correct by examining the `krb.conf` file.
 - Ensure that the KDC is running on the host specified for the realm.
 - Ensure that the KDC has an entry for the user principal and that the passwords match.
 - Ensure that the `krb.conf` and `krb.realms` files are readable by Oracle.

- Ensure that the `TNS_ADMIN` environment variable is pointing to the directory containing the `sqlnet.ora` configuration file.
- If you have an initial ticket but still cannot connect, try the following:
 - After trying to connect, check for a service ticket.
 - Check that the `sqlnet.ora` file on the database server side has a service name that corresponds to a service known by Kerberos.
 - Check that the clocks on all systems involved are set to times that are within a few minutes of each other or change the `SQLNET.KERBEROS5_CLOCKSKEW` parameter in the `sqlnet.ora` file.
- If you have a service ticket and you still cannot connect:
 - Check the clocks on the client and database server.
 - Check that the `v5srvtab` file exists in the correct location and is readable by Oracle. Remember to set the `sqlnet.ora` parameters.
 - Check that the `v5srvtab` file has been generated for the service named in the `sqlnet.ora` file on the database server side.
- If everything seems to work well, but then you issue another query and it fails, then try the following:
 - Check that the initial ticket is forwardable. You must have obtained the initial ticket by running the `okinit` utility.
 - Check the expiration date on the credentials. If the credentials have expired, then close the connection and run `okinit` to get a new initial ticket.

24.7.2 ORA-12631 Errors in the Kerberos Configuration

The ORA-12631: `username retrieval failed` error can result from the wrong or incorrectly formatted principal being used for the Kerberos authentication

Check the `sqlnet` server trace files for `Wrong principal in request` in the output.

To remedy this problem, edit the `krb5.conf` file and check the `[domain_realm]` settings. These settings are case sensitive, so even if the `domain_realm` name is correct, it will fail to parse correctly if it is lower case. Ensure that this setting is upper case. For example:

```
[domain_realm]
.country.<DOMAIN_NAME> = SECWIN.LOCAL
country.<DOMAIN_NAME> = SECWIN.LOCAL
```

24.7.3 ORA-28575 Errors in the Kerberos Configuration

The ORA-28575: `unable to open RPC connection to external procedure agent` error can occur when the client is remote and the `EXTPROC` process is spawned.

There is no need to have Kerberos authentication with an external procedure call. To remedy this problem, add `BEQ` in front of the `KERBEROS5` and `KERBEROS5PRE` parameters in the `sqlnet.ora` file.

24.7.4 ORA-01017 Errors in the Kerberos Configuration

The ORA-01017: invalid username/password; logon denied error can result if `okinit` fails and there is no valid ticket in the SQL*Plus connection.

The `okinit` trace file will show the following errors:

```
nauk5l_sendto_kdc: entry
snauk5l_sendto_kdc: exit
snauk5l_sendto_kdc: exit
nauk5la_get_in_tkt: Returning 25: Additional pre-authentication required
.
snauk5l_sendto_kdc: exit
snauk5l_sendto_kdc: exit
nauk5la_get_in_tkt: Returning 24: Preauthentication failed
.
nauk5la_get_in_tkt: exit
nauk5zi_kinit: Getting TGT failed: Preauthentication failed
.
nauk5fq_free_principal: entry
nauk5fq_free_principal: exit
nauk5fq_free_principal: entry
nauk5fq_free_principal: exit
nauk5zi_kinit: Returning 24: Preauthentication failed
.
nauk5zi_kinit: exit
```

To remedy this problem:

1. Set the `default_tkt_enctypes` parameter in the `krb5.conf` file. This enables you to control the encryption types that are requested from the client. For example:

```
default_tgs_enctypes = aes256-cts-hmac-sha1-96
default_tkt_enctypes = aes256-cts-hmac-sha1-96
```

2. Test `okinit` with the following option:

```
okinit user_name
```

If DES encryption algorithm is not implemented in an Active Directory server, the `okinit` fails:

```
okinit user_name
```

```
Kerberos Utilities for Solaris: Version 23.0.0.0.0 - Production on 15-
MAY-2023 11:50:39
Copyright (c) 1996, 2023 Oracle. All rights reserved.
Password for user_name@domain:
okinit: KDC has no support for encryption type
```

```
okinit user_name
```

```
Kerberos Utilities for Solaris: Version 23.0.0.0.0 - Production on 15-
MAY-2023 11:50:39
```

```
Copyright (c) 1996, 2023 Oracle. All rights reserved.
Password for user_name@domain:
okinit: Preauthentication failed
```

However, the following succeeds:

```
okinit user_name
Kerberos Utilities for Solaris: Version 23.0.0.0.0 - Production on 15-
MAY-2023 11:50:39
Copyright (c) 1996, 2023 Oracle. All rights reserved.
Password for user_name@domain:
```

The `oklist` utility lists the user principal from the ticket and as long as a valid ticket is present one can connect in the usual way. After `okinit` has completed successfully, you can connect to an Oracle Database server without using a user name or password, as follows:

```
% sqlplus /@service_name
```

24.7.5 Enabling Tracing for Kerberos okinit Operations

The `KRB5_TRACE` environment variable enables you to trace Kerberos `okinit` operations.

You can use this method verifying any encryption type that has been set using the `default_tkt_enctypes` setting in the `krb.conf`.

1. Run the `export` command on the `KRB5_TRACE` environment variable.

For example, for a trace file named `krb5.trc`:

```
export KRB5_TRACE="/oracle/work/krb5.trc"
```

2. Run the `okinit` command as follows:

```
okinit user_name
```

Output similar to the following appears:

```
Kerberos Utilities for Linux: Version 23.0.0.0.0 - Development on 15-
MAY-2023 21:37:39
Copyright (c) 1996, 2023 Oracle. All rights reserved.
Configuration file : /oracle/work/krb/krb.conf.
Password for user_name@US.EXAMPLE.COM:
pfitch@sales_us:/oracle/work/
```

3. Use the `grep` command to find the `default_tkt_enctype` setting in the trace file.

For example:

```
/oracle/work/fgrep aes256-cts krb5.trc
[4072148] 1683321391.149999: Selected etype info: etype aes256-cts, salt
"US.EXAMPLE.COMoratst", params ""
[4072148] 1683321393.375503: AS key obtained from gak_fct: aes256-cts/95C0
[4072148] 1683321393.375504: Decrypted AS reply; session key is: aes256-
```

```
cts/40F6
[4072182] 1683321415.915360: Selected etype info: etype aes256-cts, salt
"US.EXAMPLE.COMoratst", params ""
[4072182] 1683321417.701784: AS key obtained from gak_fct: aes256-cts/95C0
[4072182] 1683321417.701785: Decrypted AS reply; session key is: aes256-
cts/859E
[4075441] 1683322653.162464: Selected etype info: etype aes256-cts, salt
"US.EXAMPLE.COMoratst", params ""
[4075441] 1683322656.084028: AS key obtained from gak_fct: aes256-cts/1938
[4075455] 1683322659.360899: Selected etype info: etype aes256-cts, salt
"US.EXAMPLE.COMoratst", params ""
[4075455] 1683322661.242404: AS key obtained from gak_fct: aes256-cts/95C0
[4075455] 1683322661.242405: Decrypted AS reply; session key is: aes256-
cts/3580
```

Configuring PKI Certificate Authentication

You can configure Oracle Database to use PKI certificates for end-user authentication.

- [How Oracle Database Uses Transport Layer Security for Authentication](#)
Transport Layer Security works with the core Oracle Database features such as encryption and data access controls.
- [Enabling Oracle Internet Directory to Use Transport Layer Security Authentication](#)
To enable Oracle Internet Directory (OID) to use Transport Layer Security (TLS), create a wallet and certificates, and modify `tnsnames.ora` and `sqlnet.ora`.
- [Configuring User Authentication with Transport Layer Security](#)
Both the client and server side can authenticate administrative users with Transport Layer Security (TLS).
- [Configuring Transport Layer Security for Client Authentication and Encryption with X.509 Certificates](#)
You must perform this type of configuration on the server first, then the client.
- [Configuring Email over Transport Layer Security with an Oracle Wallet](#)
You can use an Oracle wallet, PL/SQL packages, and security access control lists (ACLs) to configure email over a Transport Layer Security (TLS) connection.
- [Troubleshooting Transport Layer Security Errors](#)
Oracle provides several troubleshooting tasks if you have problems with the Transport Layer Security (TLS) configuration, such as connection or authentication errors.

25.1 How Oracle Database Uses Transport Layer Security for Authentication

Transport Layer Security works with the core Oracle Database features such as encryption and data access controls.

By using Oracle Database TLS functionality to secure communications between clients and servers, you can

- Use TLS to encrypt the connection between clients and servers
- Authenticate any client or server, such as Oracle Application Server 10g, to any Oracle database server that is configured to communicate over TLS

You can use TLS features by themselves or in combination with other authentication methods supported by Oracle Database. For example, you can use the encryption provided by TLS in combination with the authentication provided by Kerberos. TLS supports any of the following authentication modes:

- Only the server authenticates itself to the client
- Both client and server authenticate themselves to each other

25.2 Enabling Oracle Internet Directory to Use Transport Layer Security Authentication

To enable Oracle Internet Directory (OID) to use Transport Layer Security (TLS), create a wallet and certificates, and modify `tnsnames.ora` and `sqlnet.ora`.

1. Log in to the database client server that has Oracle Internet Directory (OID) installed.
2. Go to the `$ORACLE_HOME/ldap/lib` directory
3. Run the following command:

```
make -f ins_ldap.mk install
```

4. Go to the directory where the OID `tnsnames.ora` file is located.

By default, this directory is `$ORACLE_HOME/network/admin`.

5. Edit the `tnsnames.ora` file to include the following OID settings, which will specify the TCPS port.

For example:

```
OIDD= (DESCRIPTION= (ADDRESS= (PROTOCOL=TCPS)
  (HOST=sales_db.us.example.com) (PORT=5500))
  (CONNECT_DATA= (SERVER=DEDICATED) (SERVICE_NAME=orcl.us.example.com)))
  (SECURITY= (SSL_SERVER_CERT_DN="CN=Server,O=Example,ST=California,C=US"))
```

In this example, `SSL_SERVER_CERT_DN` points to the DN of the database server certificate.

6. Configure the wallet location in the `sqlnet.ora` file.

For example:

```
ENCRYPTION_WALLET_LOCATION=
  (SOURCE=
    (METHOD=FILE)
    (METHOD_DATA=
      (DIRECTORY=/etc/ORACLE/WALLETS/$ORACLE_SID/)))
```

7. Ensure that the `sqlnet.ora` file has the following settings:

```
SSL_CLIENT_AUTHENTICATION = FALSE
SSL_SERVER_DN_MATCH=OFF
```

8. Use the `orapki` utility to create a new wallet and add database certificates to it.

For example:

```
orapki wallet create -wallet /etc/ORACLE/WALLETS/$ORACLE_SID/oid_wallet
-auto_login -pwd wallet_password
orapki wallet add -wallet /etc/ORACLE/WALLETS/$ORACLE_SID/oid_wallet
-trusted_cert -cert /etc/ORACLE/certificates/dbssl/root/b64certificate.txt
-pwd wallet_password
./orapki wallet add -wallet /etc/ORACLE/WALLETS/$ORACLE_SID/oid_gwallet
-trusted_cert -cert /etc/ORACLE/certificates/dbssl/netadmin/cert.txt -pwd
wallet_password
```

25.3 Configuring User Authentication with Transport Layer Security

Both the client and server side can authenticate administrative users with Transport Layer Security (TLS).

1. The client needs to specify use of the PKI certificate to authenticate the end-user. If all the client connections will use this authentication method, then set `AUTHENTICATION_SERVICES=(tcps)`.

Alternatively, you can set it separately for each connection by using `AUTHENTICATION_SERVICE=tcps` in the connect string.

 **Note:**

The connection string parameter is singular, while the `sqlnet.ora` parameter is plural.

2. For both the client and the server, ensure that the wallet has Certificate Authority (CA) certificates for user's certificate and the server's certificates. These CA certificates can be different on the client and server.
3. Configure the client to use TLS:
 - a. Add the signed user certificate to the client wallet. The CA root trust certificate should already be in the client wallet. Ensure that any intermediate certificates that are required for the user certificate are added to the wallet before you add the user certificate.

You can use `orapki` to configure the client wallet and user certificate.
 - b. Set TLS as an authentication service in the `sqlnet.ora` file.

`SSL_CLIENT_AUTHENTICATION=TRUE`
 - c. Optionally, for better security, set the client to use full or partial DN matching.

When DN matching is enabled, the client will check the server certificate to ensure that host names will match what the client is configured to match. You perform this step when you enable Oracle Internet Directory to use TLS.

 **Note:**

The database client and server will use the strongest TLS protocol and cipher suite to establish a connection. Therefore, you do not need to specify the TLS version and cipher suites unless you have specific security requirements that require it. Be aware that if you set specific TLS versions and cipher suites, you will need to update the configuration when the older versions are no longer used.

4. Configure the listener for TLS.
 - a. Create a separate listener entry for TLS connections using the secure database port 1522.

For example:

```
LISTENER =
  (DESCRIPTION_LIST =
    (DESCRIPTION =
      (ADDRESS = (PROTOCOL = TCP) (HOST = example.com) (PORT = 1521))
      (ADDRESS = (PROTOCOL = TCPS) (HOST = example.com) (PORT = 1522))
    )
  )
```

- b. Comment out the non-TLS listener entry (for example, the line with `PROTOCOL = TCP`) or leave it in for non-TLS required connections.

The same wallet that the server uses can be used by the listener, along with the same server certificate. The listener will look for the wallet using the standard Oracle Database wallet search order. Alternatively, you can specify the wallet location in the listener by setting the `WALLET_LOCATION` parameter. (You cannot use the `WALLET_ROOT` parameter for this purpose, because the listener cannot use it.)

5. Configure the server to use TLS:

- a. For the TLS server wallet, do the following:

- Set the `WALLET_ROOT` parameter to a location for the TLS server.
- Create the `tls` directory under `WALLET_ROOT/pdb_guid`.
- Move the TLS server wallet to the `WALLET_ROOT/pdb_guid/tls` directory.

- b. In the `sqlnet.ora` file, add the following parameter:

```
SSL_CLIENT_AUTHENTICATION=TRUE
```

If you want to restrict authentication to only TCPS, then set `AUTHENTICATION_SERVICES` to TCPS.

6. Create a new schema or alter an existing schema to map to the user.

```
CREATE USER user_name IDENTIFIED EXTERNALLY AS 'user DN on certificate';
```

7. Grant the database schema to appropriate administrative privileges, such as SYSDBA, SYSOPER, and so on.

Administrative users with TLS authentication can authenticate with TLS. To enable these users, grant the appropriate administrative privilege to the user schema. The administrative user must log in using this administrative privilege. For example, for a user who was granted the SYSOPER administrative privilege:

```
CONNECT /@pdb_name AS SYSOPER
```

Afterward, this user can log in by including the net service name in the `CONNECT` statement in SQL*Plus. For example, to log on as SYSDBA if the net service name is `orcl`:

```
CONNECT /@orcl AS SYSDBA
```

Related Topics

- [Managing Oracle Database Certificates](#)

After you create a wallet, you can associate certificates with it to validate the identities of entities that are associated with the wallet.

- [Enabling Oracle Internet Directory to Use Transport Layer Security Authentication](#)
To enable Oracle Internet Directory (OID) to use Transport Layer Security (TLS), create a wallet and certificates, and modify `tnsnames.ora` and `sqlnet.ora`.
- [Oracle Database Wallet Search Order](#)
The search order that Oracle Database uses to find wallets depends on the feature for which the wallet was created, such as Transparent Data Encryption (TDE).

25.4 Configuring Transport Layer Security for Client Authentication and Encryption with X.509 Certificates

You must perform this type of configuration on the server first, then the client.

- [About Configuring TLS for Client Authentication and Encryption with X.509 Certificates](#)
You can enable Public Key Infrastructure (PKI) authentication between Oracle Database clients and an Oracle database with X.509 certificates.
- [Configuring the Server for Authentication and Encryption with X.509 Certificates](#)
You must configure the server's `listener.ora`, `sqlnet.ora`, and initialization files and create a database user account for authentication and encryption with X.509 certificates.
- [Configuring the Client for Authentication and Encryption with X.509 Certificates](#)
You must configure the client's `sqlnet.ora`, `tnsnames.ora`, and `listener.ora` files, and configure the Microsoft Certificate Store (MCS) for authentication and encryption with X.509 certificates.

25.4.1 About Configuring TLS for Client Authentication and Encryption with X.509 Certificates

You can enable Public Key Infrastructure (PKI) authentication between Oracle Database clients and an Oracle database with X.509 certificates.

The configuration entails having to enable Public Key Infrastructure (PKI) authentication between Oracle Database clients and an Oracle database. It can be used with U.S. Federal Government Personal Identity Verification (PIV) and Department of Defense Common Access Card (CAC) cards as external keystores with the Microsoft Certificate Store (MCS) on the Windows operating system. In addition, the configuration enables Java-based Oracle Database clients to authenticate against the Oracle Database through use of client certificates stored in an Oracle wallet.

Before you begin the configuration process, note the following:

- TLS communications must run on a separate network port from normal database connections. This may affect requirements for firewall exceptions.
- TLS connections can take a longer time to establish than connections with native encryption or without any encryption, because the key exchange process introduces additional overhead.

25.4.2 Configuring the Server for Authentication and Encryption with X.509 Certificates

You must configure the server's `listener.ora`, `sqlnet.ora`, and initialization files and create a database user account for authentication and encryption with X.509 certificates.

- **Step 1: Create and Configure the Server Wallet for the X.509 Certificate**
You can use the `orapki` utility to perform this configuration.
- **Step 2: Shut Down the Oracle Listener on the Server**
You use different methods to shut down the Oracle listener on the server.
- **Step 3: Configure the `sqlnet.ora` File on the Server**
You must add or modify several `sqlnet.ora` parameters on the server.
- **Step 4: For Logical Volume Management, Configure the Server `listener.ora` File**
A logical volume management environment requires special settings for the `listener.ora` file on the server.
- **Step 5: For Grid Infrastructure, Configure the Server Listener Process**
A Grid Infrastructure environment requires special settings for the `listener.ora` file on the server.
- **Step 6: Set Initialization Parameters on the Server**
To avoid problems with prefixed user names, you may need to set some Oracle database initialization parameters on the server.
- **Step 7: Create an External Database User on the Server**
You must create the database user by specifying the distinguished name (DN) of the user's client certificate.
- **Step 8: Restart and Check the Listener Process on the Server**
If the Oracle database does not use Grid Infrastructure, then you must restart the listener on the server and check its process.

25.4.2.1 Step 1: Create and Configure the Server Wallet for the X.509 Certificate

You can use the `orapki` utility to perform this configuration.

1. Connect to the server as the `oracle` user.
2. Create a directory in which to put the server's wallet if this directory does not exist, and then `cd` to this directory.
3. Use `orapki` to create the initial wallet and give it a strong password.

```
orapki wallet create -wallet wallet_file_directory -auto_login -pwd
password
```

4. Generate the certificate signing request (CSR) for your server.

Use the fully qualified domain name of the server for `host_address` (for example, `hostname.af.mil`). Ensure that you include the additional `O` and `C` attributes in the distinguished name as appropriate. If you do not, then the final certificate created by Federal Agency PKI will not match the request and you will not be able to import the certificate into your wallet.

```
orapki wallet add -wallet wallet_file_directory -dn
"CN=host_address,other_attributes" -asym_alg RSA -keysize 4096 -pwd
password
```

5. Export the CSR so that you can submit the request to your certificate authority (CA) to generate the unique server certificate and the certificate trust chain.

```
orapki wallet export -wallet wallet_file_directory -dn
"CN=host_address,other_attributes" -request ~/host_name.csr -pwd password
```

If you are using Oracle Real Application Clusters (Oracle RAC), then set [HOST_ADDRESS] to the SCAN DNSname.

6. Submit the CSR (that is, *host_name.csr*) to the appropriate CA.
7. Download the appropriate root and intermediate CA certificates for your organization, any user X509 cards (CAC and PIV), and any certificates issued to non-person entities (NPEs) or service accounts.
8. Import these certificates and cards into your server wallet to establish the necessary trust chain for your server certificate and all client certificates.

```
orapki wallet add -wallet wallet_file_directory -trusted_cert -cert
cert_file_path -pwd password
```

On Linux, you can import all the certificates in a single command:

```
find cert_file_path -name "*.txt" -exec orapki wallet add -wallet
wallet_file_directory -trusted_cert -cert {} -pwd password \;
```

9. When the signed server certificate is received, import the base64 certificate as a user certificate on the Oracle wallet on the server.

```
orapki wallet add -wallet wallet_file_directory -user_cert -cert
base64_cert_file_path -pwd password
```

10. As your site adds more root and intermediate CAs, update the Oracle wallet with their certificates similar to Steps 7 and 8.
11. Confirm that the server, root CA, and intermediate CA certificates are present in the Oracle wallet.

```
wallet display -wallet wallet_file_directory -pwd password
```

Check the Requested Certificates section of the output for a listing of the certificates.

If the Oracle database uses Grid Infrastructure, then configure the Oracle wallet directory and files located at *wallet_file_directory* to be readable by the grid user. Additionally, if it is an Oracle RAC database, then make the Oracle wallet available in a similar manner on all supporting database nodes.

25.4.2.2 Step 2: Shut Down the Oracle Listener on the Server

You use different methods to shut down the Oracle listener on the server.

Depending on your environment, use one of the following commands to stop the listener:

- If the Oracle database does not use Oracle Real Applications (Oracle RAC) or Oracle Grid Infrastructure Storage Management, then as the `oracle` user, use the following `lsnrctl` command:

```
lsnrctl stop
```

- If the Oracle database uses Oracle Grid Infrastructure Storage Management, then as the grid user, use the following `lsnrctl` command:

```
srvctl stop listener
```

- If the Oracle database is an Oracle RAC database, as the grid user, then use the following `srvctl` command:

```
srvctl stop scan_listener
```

25.4.2.3 Step 3: Configure the `sqlnet.ora` File on the Server

You must add or modify several `sqlnet.ora` parameters on the server.

1. Back up the `sqlnet.ora` file, which is typically located in the `ORACLE_HOME/network/admin` directory.
2. Edit the `sqlnet.ora` file to include the following parameters.

In the following settings, the `SSL_VERSION` and `SSL_CIPHER_SUITES` parameters are optional and depend on your site's requirements.

```
###Begin required parameters to be Added or Modified
SQLNET.AUTHENTICATION_SERVICES = (beq, tcps)
SSL_VERSION = 1.2
SSL_CIPHER_SUITES = (TLS_ECDHE_ECDSA_WITH_AES_256_GCM_SHA384,
TLS_ECDHE_ECDSA_WITH_AES_128_GCM_SHA256,
TLS_ECDHE_RSA_WITH_AES_256_GCM_SHA384,
TLS_ECDHE_RSA_WITH_AES_128_GCM_SHA256)
SSL_CLIENT_AUTHENTICATION = TRUE
WALLET_LOCATION = (SOURCE = (METHOD = FILE) (METHOD_DATA = (DIRECTORY =
wallet_file_directory)))
#Added when NATIVE Encryption is also configured
SQLNET.IGNORE_ANO_ENCRYPTION_FOR_TCPS = TRUE
###End required parameters to be Added or Modified

###Begin optional parameters to be Added or Modified
#SSL_CERT_REVOCATION = #set to none, requested, or required
#SSL_CRL_PATH = #set to directory containing CRLs
#SSL_CRL_FILE = #set to file containing CRLs
#SSL_EXTENDED_KEY_USAGE = #set to extended key the client cert is to
present
###End optional parameters
```

25.4.2.4 Step 4: For Logical Volume Management, Configure the Server `listener.ora` File

A logical volume management environment requires special settings for the `listener.ora` file on the server.

This procedure assumes that you will modify an existing `listener.ora` file. However, it is also possible to configure a newly created listener by using Net Manager (`netmgr`) as well. Oracle recommends that you use a standard TCPS port setting of 2484, but you can still use another port number. Your firewalls, security lists, and network security groups must be configured to allow traffic from your clients to the TCPS port that you specify.

1. As the `oracle` user, back up the `listener.ora` file.
2. Edit the `listener.ora` file to include the following parameters:

Ensure that you add the `ADDRESS` parameters in the order shown. Note that the `SSL_VERSION` parameter is optional and depends on your site's requirements.

```
###Modify the LISTENER parameter to add the following ADDRESS parameter
LISTENER =
  (DESCRIPTION_LIST =
    (DESCRIPTION =
      (ADDRESS = (PROTOCOL = TCP) (HOST = host_address) (PORT = 1521))
      (ADDRESS = (PROTOCOL = TCPS) (HOST = host_address) (PORT = 2484))
      (ADDRESS = (PROTOCOL = IPC) (KEY = EXTPROC1521))
    )
  )

###Begin required parameters to be Added or Modified
SSL_VERSION = 1.2
SSL_CLIENT_AUTHENTICATION = TRUE

WALLET_LOCATION = (SOURCE = (METHOD = FILE) (METHOD_DATA = (DIRECTORY =
wallet_file_directory)))
###End required parameters to be Added or Modified
```

25.4.2.5 Step 5: For Grid Infrastructure, Configure the Server Listener Process

A Grid Infrastructure environment requires special settings for the `listener.ora` file on the server.

You must perform this procedure as the `grid` user on all nodes that are associated with the Oracle database.

1. As the `grid` user, back up the `listener.ora` file.
2. Edit the `listener.ora` file to include the following parameters:

Ensure that you add the `ADDRESS` parameters in the order shown.

```
###Begin required parameters to be Added or Modified
SSL_VERSION = 1.2
SSL_CLIENT_AUTHENTICATION = TRUE
WALLET_LOCATION = (SOURCE = (METHOD = FILE) (METHOD_DATA = (DIRECTORY =
wallet_file_directory)))
###End required parameters to be Added or Modified
```

3. Add TCPS services to the listener.

```
srvctl modify listener -endpoints "TCP:1521/TCPS:2484"
```

4. If this is an Oracle Real Applications Clusters (Oracle RAC) database, then run the following command:

```
srvctl modify scan_listener -endpoints "TCP:1521/TCPS:2484"
```

25.4.2.6 Step 6: Set Initialization Parameters on the Server

To avoid problems with prefixed user names, you may need to set some Oracle database initialization parameters on the server.

1. Connect to the database as a user who has the `ALTER SYSTEM` system privilege.
2. Set the following parameters:

```
ALTER SYSTEM SET OS_AUTHENT_PREFIX='' SCOPE=SPFILE;
```

3. Restart the database instance.

25.4.2.7 Step 7: Create an External Database User on the Server

You must create the database user by specifying the distinguished name (DN) of the user's client certificate.

Though users that are identified externally can be granted proxy privileges to connect through to other schemas (as in the case of developers accessing an application schema in a test environment), they cannot be granted privileges such as `SYSDBA` that require credentials to be stored in the database password file.

1. Connect to the database as a user who has the `CREATE USER` system privilege.
2. Create the external user as follows:

For example, to create the external user `pfitch`:

```
CREATE USER pfitch IDENTIFIED EXTERNALLY AS  
'CN=FITCH.PETER.I.1234567890,other_attributes';
```

3. At minimum, grant this user the `CREATE SESSION` privilege so that the user can connect to the `other_attributes` database.

```
GRANT CREATE SESSION TO pfitch;
```

25.4.2.8 Step 8: Restart and Check the Listener Process on the Server

If the Oracle database does not use Grid Infrastructure, then you must restart the listener on the server and check its process.

Depending on your environment, use one of the following commands to restart and check the listener:

- If the Oracle database does not use Oracle Real Applications (Oracle RAC) or Oracle Grid Infrastructure Storage Management, then as the `oracle` user, use the following `lsnrctl` commands:

```
lsnrctl start  
lsnrctl status
```

- If the Oracle database uses Oracle Grid Infrastructure Storage Management, then as the grid user, use the following `lsnrctl` commands:

```
srvctl start listener
srvctl status listener
```

- If the Oracle database is an Oracle RAC database, as the grid user, then use the following `srvctl` commands:

```
srvctl start scan_listener
srvctl status scan_listener
```

25.4.3 Configuring the Client for Authentication and Encryption with X.509 Certificates

You must configure the client's `sqlnet.ora`, `tnsnames.ora`, `listener.ora` files, and configure the Microsoft Certificate Store (MCS) for authentication and encryption with X.509 certificates.

- [Step 1: Configure the `sqlnet.ora` File on the Client](#)
You must add or modify several `sqlnet.ora` parameters on the client.
- [Step 2: Configure the `tnsnames.ora` File on the Client](#)
You must modify the `tnsnames.ora` file on the client.
- [Step 3: Configure Microsoft Certificate Store on the Client](#)
The Microsoft Certificate Store (MCS), which enables you to store and manage certificates locally, can be configured on an Oracle Database Windows client.

25.4.3.1 Step 1: Configure the `sqlnet.ora` File on the Client

You must add or modify several `sqlnet.ora` parameters on the client.

This configuration will enable you to use the Microsoft Certificate Store (MCS) to store and manage certificates.

1. Back up the `sqlnet.ora` file, which is typically located in the `ORACLE_HOME/network/admin` directory.
2. Edit the `sqlnet.ora` file to include the following parameters.

The `SSL_VERSION` parameter setting depends on your site's requirements.

```
###Begin required parameters to be Added or Modified
SQLNET.AUTHENTICATION_SERVICES = (nts, tcps)

SSL_VERSION = 1.2

SSL_SERVER_DN_MATCH = TRUE

WALLET_LOCATION = (SOURCE = (METHOD = MCS))

###Begin optional parameters to be Added or Modified
#SSL_CIPHER_SUITES = algorithms to be used for TLS encryption
###End optional parameters
```

25.4.3.2 Step 2: Configure the tnsnames.ora File on the Client

You must modify the `tnsnames.ora` file on the client.

1. Back up the `tnsnames.ora` file, which is typically located in the `ORACLE_HOME/network/admin` directory.
2. Edit the `tnsnames.ora` file to include the following parameters:

```

service_alias =
  (DESCRIPTION =
    (ADDRESS =
      (PROTOCOL = TCPS)
      (HOST = host_ip_address)
      (PORT = 2484)
    )
    (CONNECT_DATA =
      (SERVICE_NAME = database_service_name)
    )
    (SECURITY =
      (SSL_SERVER_CERT_DN = "CN=host_ip_address,other_attributes)
    )
  )

```

25.4.3.3 Step 3: Configure Microsoft Certificate Store on the Client

The Microsoft Certificate Store (MCS), which enables you to store and manage certificates locally, can be configured on an Oracle Database Windows client.

- [About Configuring Microsoft Certificate Store on the Client](#)
Before you configure Microsoft Certificate Store (MCS) on the client, you should ensure that your client environment is properly set up.
- [Setting the TNS_ADMIN Environment Variable](#)
The `TNS_ADMIN` environment variable must be set in a special way to facilitate the MCS operation.
- [Configuring Microsoft Certificate Store on the Client](#)
For the mTLS configuration to work, the certificates for the root and intermediate CAs that signed the certificate that the database server used must be added to the MCS.
- [Testing the Microsoft Certificate Store Configuration Using tnsping](#)
The `tnsping` utility determines whether an Oracle service can be successfully reached.
- [Testing the Microsoft Certificate Store Configuration Using SQL*Plus](#)
SQL*Plus is the most basic Oracle Database utility commonly used by users, administrators, and programmers that can be used to confirm mTLS and user authentication to the database.

25.4.3.3.1 About Configuring Microsoft Certificate Store on the Client

Before you configure Microsoft Certificate Store (MCS) on the client, you should ensure that your client environment is properly set up.

These instructions assume the following:

- The Oracle Database client has been installed and configured to communicate with the Oracle Database server.
- All clients have the latest patches installed.
- You have installed the appropriate hardware and software to enable MCS to read the certificates from the X509 smart cards (Common Access Card (CAC), Personal Identity Verification (PIV))

You can also configure MCS to work on the client with SQL Developer and with Java using JDBC Type 4 Drivers. See My Oracle Support note [2959952.1](#).

The following diagram illustrates a smart card and MCS in an Oracle Database environment.

Figure 25-1 Smart Card and MCS in an Oracle Database Environment

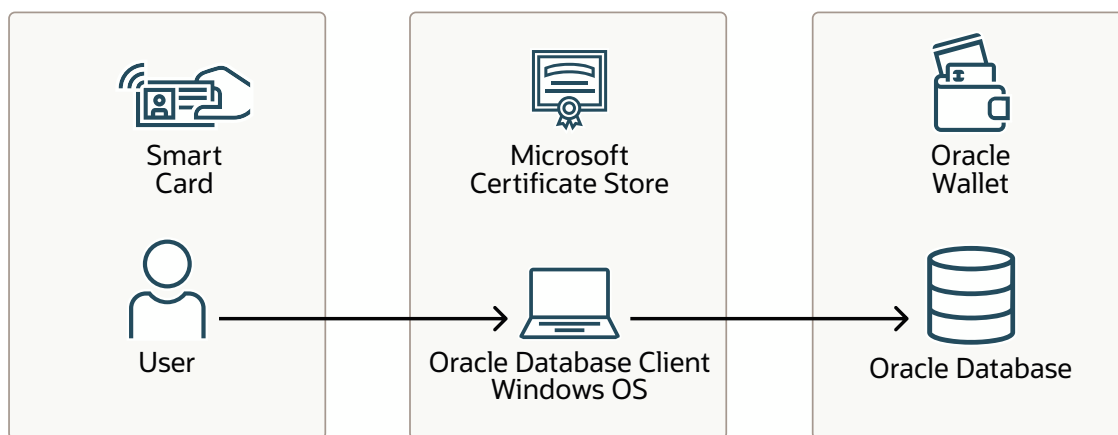

In this diagram:

1. A user logs in to the Oracle database. The user's user certificate, private key, and other necessary certificates are on the smart card.
2. The database connection from the client is configured to use MCS.
3. The wallet in the Oracle database is a PKCS11 wallet with a private key and a certificate. The Oracle Database wallet holds the server private key and the trusted root certificate.

25.4.3.3.2 Setting the TNS_ADMIN Environment Variable

The `TNS_ADMIN` environment variable must be set in a special way to facilitate the MCS operation.

The following setting enables a user to place all necessary `*.ora` files within their own user profile where they have ownership and control. It also allows each user of a system to have individual, personalized configurations.

1. Open the System Properties window on Windows. (Search for Advanced System Settings.)
2. Select the **Advanced** tab.
3. Click **Environment Variables**.
4. In the Environment Variables window, if `TNS_ADMIN` is not listed, then click **New**. If it is listed, then click **Edit**.

5. In the New (or Edit) User Variable dialog box, enter the following value in the **Variable value** field:

```
%USERPROFILE%\Oracle\admin
```

6. Click **OK**.

25.4.3.3.3 Configuring Microsoft Certificate Store on the Client

For the mTLS configuration to work, the certificates for the root and intermediate CAs that signed the certificate that the database server used must be added to the MCS.

1. Download the certificates for the root and intermediate CAs that were used to sign the database server certificate when you created and configured the server wallet.
2. Start the MCS Certificate Import wizard.
3. In the Welcome to the Certificate Import Wizard page, select the **Current User** option, and then click **Next**.
4. On the Certificate Store page, select the **Automatically select the certificate store based on the type of certificate** option, and then click **Next**.
5. In the Completing the Certificate Import Wizard page, check the settings that you made, and then click **Finish**. Click **OK** in the Certificate Import Wizard confirmation window.
6. Confirm that the CAs have successfully been loaded into MCS.
 - a. In the Console Root tree on the left, under Certificates - Current User, expand the Trusted Root Certificates folder.
 - b. Select the Certificates folder to display the Certificate window.
 - c. Check the contents. The window will describe the purpose of the certificate, who it was issued to, who issued it, and the dates the certificate will be valid for. Click **OK** to dismiss the window.

Related Topics

- [Step 1: Create and Configure the Server Wallet for the X.509 Certificate](#)
You can use the `orapki` utility to perform this configuration.

25.4.3.3.4 Testing the Microsoft Certificate Store Configuration Using `tnsping`

The `tnsping` utility determines whether an Oracle service can be successfully reached.

1. On the client, confirm that there is TCP/IP connectivity to the TLS port (that is, 2484) configured from the client to the database using your utility of choice.

If there does not appear to be connectivity, work with your network and system administrators to confirm that the appropriate firewall, security list, network security groups, and so on are configured to allow the communication.

2. Run the `tnsping` command (by default in the `ORACLE_HOME/bin` directory) against the service alias that you defined in the `tnsnames.ora` file.

```
tnsping service_alias
```

3. When prompted, select the certificate that you associated with the external Oracle Database user account that you created earlier.

After you provide the Personal Identification Number (PIN) for the certificate, output similar to the following appears:

Used parameter files:

```
[ORACLE_HOME]\network\admin\sqlnet.ora
```

Used TNSNAMES adapter to resolve the alias

```
Attempting to contact (DESCRIPTION = (ADDRESS = (PROTOCOL = TCPS) (HOST =
host_address) (PORT = 2484)) (CONNECT_DATA = (SERVICE_NAME =
database_service_name)))
(SEcurity = (SSL_SERVER_CERT_DN = CN=host_address,other_attributes))
```

OK (4920 msec)

The response time may seem large. The elapsed time shown includes the amount of time it takes the user to react to the prompt and select a certificate, so it will always be several seconds.

Related Topics

- [Step 2: Configure the tnsnames.ora File on the Client](#)
You must modify the `tnsnames.ora` file on the client.

25.4.3.3.5 Testing the Microsoft Certificate Store Configuration Using SQL*Plus

SQL*Plus is the most basic Oracle Database utility commonly used by users, administrators, and programmers that can be used to confirm mTLS and user authentication to the database.

1. On the client, run SQL*Plus against the service alias you defined earlier in the client `tnsnames.ora` file.

```
sqlplus /@service_alias
```

2. When prompted, select the certificate that you associated with the external Oracle Database user account that you created earlier.

After you provide the Personal Identification Number (PIN) for the certificate, output similar to the following appears:

```
SQL*Plus: Release release - Production on Mon May 23 14:03:10 2022
```

```
Version release
```

```
Copyright (c) 1982, 2019, 2023 Oracle. All rights reserved.
```

```
Last Successful login time: Wed Oct 18 2023 16:47:43 +00:00
```

```
Connected to:
```

```
Oracle Database release - Production
```

```
Version release
```

3. Confirm that you are connected as the user associated with the client certificate you used.

```
show user;
```

4. Confirm that the TCPS protocol is being used.

```
SELECT SYS_CONTEXT('USERENV','NETWORK_PROTOCOL') FROM DUAL;
```

Output similar to the following should appear:

```
SYS_CONTEXT('USERENV','NETWORK_PROTOCOL')
-----
tcps
```

Related Topics

- [Step 2: Configure the tnsnames.ora File on the Client](#)
You must modify the `tnsnames.ora` file on the client.

25.5 Configuring Email over Transport Layer Security with an Oracle Wallet

You can use an Oracle wallet, PL/SQL packages, and security access control lists (ACLs) to configure email over a Transport Layer Security (TLS) connection.

1. Use `openssl` to get the URL certificates from the mail server.

You can perform this step with `email server`, to dump the certificate chain to a standard output (`stdout`). Typically, this command dumps the server certificate (`cert 0`) and the intermediate trusted certificate (`cert 1...n`). For example:

```
$ openssl s_client -showcerts -connect office365.com:443
```

Output similar to the following appears:

```
depth=2 C = US, O = DigiCert Inc, CN = DigiCert Global Root CA
verify return:1
depth=1 C = US, O = DigiCert Inc, CN = DigiCert Cloud Services CA-1
verify return:1
depth=0 C = US, ST = Washington, L = Redmond, O = Microsoft Corporation,
CN = outlook.com
verify return:1
---
Certificate chain
0 s:/C=US/ST=Washington/L=Redmond/O=Microsoft Corporation/CN=outlook.com
i:/C=US/O=DigiCert Inc/CN=DigiCert Cloud Services CA-1
-----BEGIN CERTIFICATE-----
...
-----END CERTIFICATE-----
...
DONE
```

2. Copy and paste the certificates in this output to text files with the extension `.cer`.

You must copy the text that appears after -----BEGIN CERTIFICATE ----- and before -----END CERTIFICATE-----. Example files are as follows:

- file_root.cer
- file_trusted.cer
- file_user.cer

3. Check the CA issuer and the CA subject of each certificate that you copied to a certificate file.

The CA issuer is the company that created the certificate and the subject indicates the information that had been provided when the certificate was created.

- To check the root certificate:

```
openssl x509 -in file_root.cer -text | grep -i issuer
Issuer: C=US, O=DigiCert Inc, CN=DigiCert Global Root CA
```

```
openssl x509 -in file_root.cer -text | grep -i subject
Subject: C=US, O=DigiCert Inc, CN=DigiCert Global Root CA
```

- To check the trusted certificate:

```
openssl x509 -in file_trusted.cer -text | grep -i issuer
Issuer: C=US, O=DigiCert Inc, CN=DigiCert Global Root CA
```

```
openssl x509 -in file_trusted.cer -text | grep -i subject
Subject: C=US, O=DigiCert Inc, CN=DigiCert SHA2 Secure Server CA
```

- To check the user certificate:

```
openssl x509 -in file_user.cer -text | grep -i issuer
Issuer: C=US, O=DigiCert Inc, CN=DigiCert Global Root CA
```

```
openssl x509 -in file_user.cer -text | grep -i subject
Subject: C=US, O=DigiCert Inc, CN=DigiCert SHA2 Secure Server CA
```

4. Create a folder location.

For example:

```
mkdir app/oracle/product/network/admin/email
```

5. Create the wallet and add its certificates to this wallet.

- a. Create an empty wallet.

For example:

```
orapki wallet create -wallet wallet_file_directory -auto_login [-pwd wallet_password]
```

If you omit the `pwd` prompt, then a password prompt appears. For better security, enter the password at the prompt instead of entering it at the command line.

- b. Put the certificate into the wallet. For example:

```
orapki wallet add -wallet wallet_file_directory -trusted_cert -cert
trusted.cer
[-pwd wallet_password]
```

6. Prepare the email SQL code.

For example:

```
#####
###
##
DECLARE
k_host CONSTANT VARCHAR2(100) := 'us.example.com';
k_port CONSTANT INTEGER := 587;
k_wallet_path CONSTANT VARCHAR2(100) :=
'file:app/oracle/product/network/admin/email';
k_wallet_password CONSTANT VARCHAR2(100) := 'wallet_password';
k_domain CONSTANT VARCHAR2(100) := 'localhost';
k_username CONSTANT VARCHAR2(100) := 'email_account';
k_password CONSTANT VARCHAR2(100) := 'email_account_password';
k_sender CONSTANT VARCHAR2(100) := 'email_account';
k_recipient CONSTANT VARCHAR2(100) := 'email_account_sending_too';
k_subject CONSTANT VARCHAR2(100) := 'Test TLS mail';
k_body CONSTANT VARCHAR2(100) := 'We Love Database Security';

l_conn utl_smtp.connection;
l_reply utl_smtp.reply;
l_replies utl_smtp.replies;
BEGIN
dbms_output.put_line('utl_smtp.open_connection');

l_reply := utl_smtp.open_connection
( host => k_host
, port => k_port
, c => l_conn
, wallet_path => k_wallet_path
, wallet_password => k_wallet_password
, secure_connection_before_smtp => FALSE
);

IF l_reply.code != 220
THEN
raise_application_error(-20000, 'utl_smtp.open_connection: '||
l_reply.code||'
- '||l_reply.text);
END IF;

dbms_output.put_line('utl_smtp.ehlo');

l_replies := utl_smtp.ehlo(l_conn, k_domain);

FOR ri IN 1..l_replies.COUNT
LOOP
dbms_output.put_line(l_replies(ri).code||' - '||l_replies(ri).text);
```



```

END LOOP;

dbms_output.put_line('utl_smtp.starttls');

l_reply := utl_smtp.starttls(l_conn);

IF l_reply.code != 220
THEN
raise_application_error(-20000, 'utl_smtp.starttls: '||l_reply.code||' -
' ||l_reply.text);
END IF;

dbms_output.put_line('utl_smtp.ehlo');

l_replies := utl_smtp.ehlo(l_conn, k_domain);

FOR ri IN 1..l_replies.COUNT
LOOP
dbms_output.put_line(l_replies(ri).code||' - ' ||l_replies(ri).text);
END LOOP;

dbms_output.put_line('utl_smtp.auth');

l_reply := utl_smtp.auth(l_conn, k_username, k_password,
utl_smtp.all_schemes);

IF l_reply.code != 235
THEN
raise_application_error(-20000, 'utl_smtp.auth: '||l_reply.code||' -
' ||l_reply.text);
END IF;

dbms_output.put_line('utl_smtp.mail');

l_reply := utl_smtp.mail(l_conn, k_sender);

IF l_reply.code != 250
THEN
raise_application_error(-20000, 'utl_smtp.mail: '||l_reply.code||' -
' ||l_reply.text);
END IF;

dbms_output.put_line('utl_smtp.rcpt');

l_reply := utl_smtp.rcpt(l_conn, k_recipient);

IF l_reply.code NOT IN (250, 251)
THEN
raise_application_error(-20000, 'utl_smtp.rcpt: '||l_reply.code||' -
' ||l_reply.text);
END IF;

dbms_output.put_line('utl_smtp.open_data');

l_reply := utl_smtp.open_data(l_conn);

```

```

IF l_reply.code != 354
THEN
raise_application_error(-20000, 'utl_smtp.open_data: '||l_reply.code||' -
' ||l_reply.text);
END IF;

dbms_output.put_line('utl_smtp.write_data');

utl_smtp.write_data(l_conn, 'From: '||k_sender||utl_tcp.crlf);
utl_smtp.write_data(l_conn, 'To: '||k_recipient||utl_tcp.crlf);
utl_smtp.write_data(l_conn, 'Subject: '||k_subject||utl_tcp.crlf);
utl_smtp.write_data(l_conn, utl_tcp.crlf||k_body);

dbms_output.put_line('utl_smtp.close_data');

l_reply := utl_smtp.close_data(l_conn);

IF l_reply.code != 250
THEN
raise_application_error(-20000, 'utl_smtp.close_data: '||l_reply.code||' -
' ||l_reply.text);
END IF;

dbms_output.put_line('utl_smtp.quit');

l_reply := utl_smtp.quit(l_conn);

IF l_reply.code != 221
THEN
raise_application_error(-20000, 'utl_smtp.quit: '||l_reply.code||' -
' ||l_reply.text);
END IF;

EXCEPTION
WHEN utl_smtp.transient_error
OR utl_smtp.permanent_error
THEN
BEGIN
utl_smtp.quit(l_conn);
EXCEPTION
WHEN utl_smtp.transient_error
OR utl_smtp.permanent_error
THEN
NULL;
END;

raise_application_error(-20000, 'Failed to send mail due to the following
error: '||SQLERRM);

END;
/

```

Ensure that you set the `secure_connection_before_smtp` parameter to `FALSE`. This translates to "do not use TLS before the email is sent". Setting it to `TRUE` generates the following error if we only want to send the email over TLS:

```
ERROR at line 1:
ORA-29019: The protocol version is incorrect.
ORA-06512: at "SYS.UTL_TCP", line 63
ORA-06512: at "SYS.UTL_TCP", line 314
ORA-06512: at "SYS.UTL_SMTP", line 177
ORA-06512: at line 20
```

7. Create the user who will send emails.

For example:

```
CREATE USER user_name IDENTIFIED BY password;
GRANT CREATE SESSION TO user_name;
```

8. Append the host and wallet access control entries (ACE) to the default access control list (ACL).

a. Append the host access control entry (ACE).

```
BEGIN
DBMS_NETWORK_ACL_ADMIN.APPEND_HOST_ACE (
host => 'us.example.com',
lower_port => 587,
upper_port => 587,
ace => xs$ace_type(privilege_list => xs$name_list('http'),
principal_name => 'user_name',
principal_type => xs_acl.ptype_db));
END;
/
```

```
BEGIN
DBMS_NETWORK_ACL_ADMIN.APPEND_HOST_ACE (
host => 'us.example.com',
lower_port => 587,
upper_port => 587,
ace => xs$ace_type(privilege_list => xs$name_list('connect'),
principal_name => 'user_name',
principal_type => xs_acl.ptype_db));
END;
/
```

```
BEGIN
DBMS_NETWORK_ACL_ADMIN.APPEND_HOST_ACE (
host => 'us.example.com',
lower_port => null,
upper_port => null,
ace => xs$ace_type(privilege_list => xs$name_list('resolve'),
principal_name => 'user_name',
principal_type => xs_acl.ptype_db));
END;
/
```

b. Append the wallet ACE.

```

BEGIN
DBMS_NETWORK_ACL_ADMIN.APPEND_WALLET_ACE (
wallet_path =>
'file:/u01/64bit/app/oracle/product/network/admin/email',
ace => xs$ace_type(privilege_list =>
xs$name_list('use_client_certificates',
'use_passwords'),
principal_name => 'user_name',
principal_type => xs_acl.ptype_db));
END;
/

```

25.6 Troubleshooting Transport Layer Security Errors

Oracle provides several troubleshooting tasks if you have problems with the Transport Layer Security (TLS) configuration, such as connection or authentication errors.

- **Step 1: Check the TLS Connection with the `tnsping` Utility**
A successful connection using the `tnsping` utility shows that the database service has been registered to the listener on the TCPS endpoint.
- **Step 2: Check the `SSL_VERSION` Parameter**
An incorrectly set `SSL_VERSION` parameter can cause Transport Layer Security (TLS) problems.
- **Step 3: Check the Wallet File Permissions**
The Transport Layer Security (TLS) connection requires the database and listener to have access to the auto-login wallet file (`cwallet.sso`).
- **Step 4: Check the Wallet Settings in the `sqlnet.ora` and `listener.ora` Files**
Transparent Layer Security (TLS) problems can arise from wallet and certificate configuration errors in the `sqlnet.ora` and `listener.ora` files.
- **Step 5: Enable Tracing for the SQL*Net and Listener Connections**
In the `sqlnet.ora` file, you can enable tracing for SQL*Net and listener connections.

25.6.1 Step 1: Check the TLS Connection with the `tnsping` Utility

A successful connection using the `tnsping` utility shows that the database service has been registered to the listener on the TCPS endpoint.

- On the server on which the Oracle database is installed, run the `tnsping` command at the command line using the following syntax:

```
tnsping net_service_name [count]
```

For example:

```
tnsping sales count
```

In this specification:

- `net_service_name` (`sales`) is the service name that is specified in the `tnsnames.ora` file, or it can be the name service that is in use, such as NIS.

- `count`, which is optional, determines how many times the program attempts to reach the server.

Output similar to the following appears:

```
TNS Ping Utility for Linux: Version 23.0.0.0.0 - Production on 26-APR-2023  
18:21:47
```

```
Copyright (c) 1997, 2023, Oracle. All rights reserved.
```

```
Used parameter files:  
$ORACLE_HOME/network/admin/sqlnet.ora
```

```
Used TNSNAMES adapter to resolve the alias  
Attempting to contact (DESCRIPTION = (ADDRESS = (PROTOCOL = TCPS) (HOST =  
host_name) (PORT = port)) (CONNECT_DATA = (SERVER = DEDICATED)  
(SERVICE_NAME = sales)))  
OK (30 msec)
```

If the test fails with an `TNS-12560: NS:protocol adapter error` error, then ensure that the lines in the `sqlnet.ora` and `listener.ora` files do not have leading spaces. If the connection still has errors, then you must investigate further, such as checking the permissions of wallet files or other settings.

See *Oracle Database Net Services Administrator's Guide* for detailed information about using the `tnsping` utility.

25.6.2 Step 2: Check the `SSL_VERSION` Parameter

An incorrectly set `SSL_VERSION` parameter can cause Transport Layer Security (TLS) problems.

You should ensure that the `SSL_VERSION` parameter in the server and client `sqlnet.ora` file is set to the correct version of TLS, so that connections can be established. For example:

```
SSL_VERSION= TLSv1.3
```

By default, Oracle Database uses the most secure protocol that is available when `SSL_VERSION` is not set.

See *Oracle Database Net Services Reference* to learn more about how to set the `SSL_VERSION` parameter for the correct version of TLS.

25.6.3 Step 3: Check the Wallet File Permissions

The Transport Layer Security (TLS) connection requires the database and listener to have access to the auto-login wallet file (`cwallet.sso`).

In the case of an Oracle Real Application Clusters (Oracle RAC) database, both the Grid Infrastructure Oracle Home owner and the Database Oracle Home owner must have access to the contents of a `cwallet.sso` file containing the correct certificates. Quite often the configuration implies the usage of the same `cwallet.sso` file for both environments, in which case the permissions should be set appropriately so that both users can have access to the file no matter who is the owner of the file.

By default, the wallet permissions are as follows:

```
$ ls -ltr
-rw-----. 1 ewallet.p12
-rw-----. 1 cwallet.sso
```

If the `cwallet.sso` file will be used by the Grid Infrastructure Oracle Home owner (usually `grid`) then user `grid` must be a member of the `oinstall` group. You can change the permissions as follows:

```
$ chmod 640 cwallet.sso
$ ls -ltr
-rw-----. 1 oracle oinstall 75 Mar 6 10:47 ewallet.p12
-rw-r-----. 1 oracle oinstall 120 Mar 6 10:47 cwallet.sso
```

25.6.4 Step 4: Check the Wallet Settings in the `sqlnet.ora` and `listener.ora` Files

Transparent Layer Security (TLS) problems can arise from wallet and certificate configuration errors in the `sqlnet.ora` and `listener.ora` files.

These settings enable you to encrypt the connections between the database and its clients. (Another way to handle this encryption is with the external network services PL/SQL packages, `UTL_SMTP`, `UTL_HTTP`, and `UTL_TCP`.)

Note the following:

- **For the server:** Set the `WALLET_ROOT` parameter. (The `WALLET_LOCATION` parameter can still be used.) Both trusted certificate and server certificate are required.
- **For the client:** Set the `WALLET_LOCATION` in `sqlnet.ora`. Only trusted certificates are required if one-way TLS is configured. If mTLS is configured, then both trusted certificate and server certificate are required.
- **For the listener:** Set the `WALLET_LOCATION` parameter in the `listener.ora` file. Both trusted certificate and server certificate are required.

An example `WALLET_LOCATION` parameter setting is as follows:

```
WALLET_LOCATION =
  (SOURCE =
    (METHOD = FILE)
    (METHOD_DATA =
      (DIRECTORY = wallet_location)
    )
  )
```

The certificates can be self-signed or they can be signed by a third-party authority.

You can use the `orapki wallet display -wallet` command to view the contents of a wallet to find if it has self-signed certificates. For example:

```
$ orapki wallet display -wallet .
```

```
Requested Certificates:  
User Certificates:  
Subject: C=US,CN=MYROOT  
Trusted Certificates:  
Subject: C=US,CN=MYROOT
```

The following example shows the output for a wallet that has certificates that were provided by a third-party authority:

```
Requested Certificates:  
User Certificates:  
Subject: CN=*.us.example.com,O=Example Corporation,L=Redwood  
City,ST=California,C=US  
Trusted Certificates:  
Subject: CN=DigiCert Global Root CA,O=DigiCert Inc,C=US  
Subject: CN=DigiCert TLS RSA SHA256 2020 CA1,O=DigiCert Inc,C=US
```

25.6.5 Step 5: Enable Tracing for the SQL*Net and Listener Connections

In the `sqlnet.ora` file, you can enable tracing for SQL*Net and listener connections.

For example, to enabling tracing for SQL*Net:

```
TRACE_LEVEL_CLIENT=SUPPORT  
TRACE_DIRECTORY_CLIENT=trace_dir  
TRACE_LEVEL_SERVER=SUPPORT  
TRACE_DIRECTORY_SERVER=trace_dir  
DIAG_ADR_ENABLED=OFF
```

For the listener, you can set the following tracing parameters:

```
TRACE_FILE_LISTENER = LISTENER.TRC  
TRACE_DIRECTORY_LISTENER = trace_dir  
TRACE_LEVEL_LISTENER = SUPPORT  
TRACE_FILELEN_LISTENER = 10240  
TRACE_FILENO_LISTENER=10
```

The following output indicates that the TLS connection failed because the wrong TLS protocol was used. To find how to address these errors, see My Oracle Support note [244527.1](#).

```
[<DATE AND TIME>] ntzdosecneg: entry  
[<DATE AND TIME>] nttrd: entry  
[<DATE AND TIME>] nttrd: socket 13 had bytes read=11  
[<DATE AND TIME>] nttrd: exit  
[<DATE AND TIME>] ntzdosecneg: SSL handshake failed with error 29019.  
[<DATE AND TIME>] ntzdosecneg: exit  
[<DATE AND TIME>] ntzcontrol: failed with error 542  
[<DATE AND TIME>] ntzcontrol: exit
```

```
[<DATE AND TIME>] nserror: entry  
[<DATE AND TIME>] nserror: nsres: id=0, op=79, ns=12561, ns2=0; nt[0]=0,  
nt[1]=0, nt[2]=0; ora[0]=0, ora[1]=0, ora[2]=0  
[<DATE AND TIME>] nsclose: entry  
[<DATE AND TIME>] nsvntx_dei: entry  
[<DATE AND TIME>] nsvntx_dei: exit
```

See [Troubleshooting the Transport Layer Security Configuration](#) for information about common error codes.

See also *Oracle Database Net Services Administrator's Guide* for more information about using trace settings to track connections.

Configuring RADIUS Authentication

RADIUS is a client/server security protocol widely used to enable remote authentication and access.

- [About Configuring RADIUS Authentication](#)
Oracle Database supports the RADIUS standard for user authentication.
- [RADIUS Components](#)
RADIUS has a set of authentication components that enable you to manage configuration settings.
- [RADIUS Authentication Modes](#)
The RADIUS server can authenticate users using technologies such as FIDO and text message authentication codes. In addition, Oracle Database supports synchronous and challenge-response (*async*) authentication modes.
- [RADIUS Parameters](#)
Oracle provides a set of RADIUS-specific parameters.
- [Enabling RADIUS Authentication, Authorization, and Accounting](#)
You can enable RADIUS authentication, authorization, and accounting from the command line.
- [Using RADIUS to Log in to a Database](#)
You can use RADIUS to log into a database by using either synchronous authentication mode or challenge-response mode.
- [Integrating Authentication Devices Using RADIUS](#)
The RADIUS challenge-response user interface further enhances authentication in a RADIUS configuration.

26.1 About Configuring RADIUS Authentication

Oracle Database supports the RADIUS standard for user authentication.

Note:

Starting with Oracle Database 23ai, the older RADIUS API that is based on Request for Comments (RFC) 2138 is deprecated.

Oracle Database 23ai introduces an updated RADIUS API based on RFC 6613 and RFC 6614. Oracle recommends that you start planning on migrating to use the new RADIUS API as soon as possible. The new API is enabled by default. These parameters associated with the older RADIUS API are also deprecated:

`SQLNET.RADIUS_ALTERNATE`, `SQLNET.RADIUS_ALTERNATE_PORT`,
`SQLNET.RADIUS_AUTHENTICATION`, and `SQLNET.RADIUS_AUTHENTICATION_PORT`. Refer to the Radius API documentation for information on changing the default to use the older RADIUS API.

RADIUS is frequently used for multi-factor authentication (MFA) when it is used to access an Oracle database. The specific MFA technologies (such as smart cards or biometric cards) depend on the RADIUS server. The database server and client support asynchronous and synchronous challenges for MFA.

The Oracle Database RADIUS implementation uses the TLS/TCPs standards that are described in RFC 6013 and 6014 and is enabled by default by the Oracle database. If you want to use the older implementation (before Oracle Database release 23ai) using an older RADIUS standard, then you must enable one or both of the `SQLNET.RADIUS_ALLOW_WEAK_CLIENTS` and `SQLNET.RADIUS_ALLOW_WEAK_PROTOCOL` parameters to use the older RADIUS implementation.

From an end user's perspective, the entire authentication process is transparent. When the user seeks access to an Oracle database server, the Oracle database server, acting as the RADIUS client, notifies the RADIUS server. The RADIUS server then:

- Looks up the user's security information
- Passes authentication and authorization information between the appropriate authentication server or servers and the Oracle database server
- Grants the user access to the Oracle database server
- Logs session information, including when, how often, and for how long the user was connected to the Oracle database server

 **Note:**

Oracle Database does not support RADIUS authentication over database links. To configure Oracle Database to use RADIUS, you will modify parameters in the `sqlnet.ora` file. The settings in `sqlnet.ora` apply to all pluggable databases (PDBs).

Figure 26-1 illustrates the Oracle Database-RADIUS environment.

Figure 26-1 RADIUS in an Oracle Environment

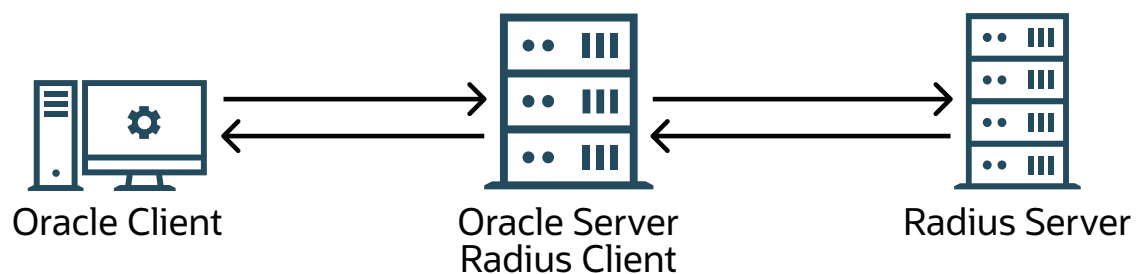

The Oracle Database server acts as the RADIUS client, passing information between the Oracle client and the RADIUS server. Similarly, the RADIUS server passes information between the Oracle database server and the appropriate authentication servers.

A RADIUS server vendor is often the authentication server vendor as well. In this case authentication can be processed on the RADIUS server.

Related Topics

- [Oracle Database Net Services Reference](#)

26.2 RADIUS Components

RADIUS has a set of authentication components that enable you to manage configuration settings.

[Table 26-1](#) lists the authentication components.

Table 26-1 RADIUS Authentication Components

Component	Stored Information
Oracle client	Configuration setting for communicating through RADIUS.
Oracle database server/ RADIUS client	Configuration settings for passing information between the Oracle client and the RADIUS server. The secret key file.
RADIUS server	Authentication and authorization information for all users. Each client's name or IP address. Each client's shared secret.
Authentication server or servers	User authentication information such as pass codes and PINs, depending on the authentication method in use. Note: The RADIUS server can also be the authentication server.

26.3 RADIUS Authentication Modes

The RADIUS server can authenticate users using technologies such as FIDO and text message authentication codes. In addition, Oracle Database supports synchronous and challenge-response (`async`) authentication modes.

- [Synchronous Authentication Mode](#)
In the synchronous mode, the user enters both the password and the second factor in the password field at the same time. This method is preferable when you use a command line interface when a GUI challenge window cannot be opened.
- [Challenge-Response \(Asynchronous\) Authentication Mode](#)
When the system uses the asynchronous mode, the user does not need to enter a user name and password at the SQL*Plus CONNECT string.

26.3.1 Synchronous Authentication Mode

In the synchronous mode, the user enters both the password and the second factor in the password field at the same time. This method is preferable when you use a command line interface when a GUI challenge window cannot be opened.

- [Sequence for Synchronous Authentication Mode](#)
The sequence of synchronous authentication mode is comprised of six steps.
- [Example: Synchronous Authentication with Tokens](#)
With token authentication, each user has a token card that displays a dynamic number that changes every sixty seconds.

26.3.1.1 Sequence for Synchronous Authentication Mode

The sequence of synchronous authentication mode is comprised of six steps.

Figure 26-2 shows the sequence in which synchronous authentication occurs.

Figure 26-2 Synchronous Authentication Sequence

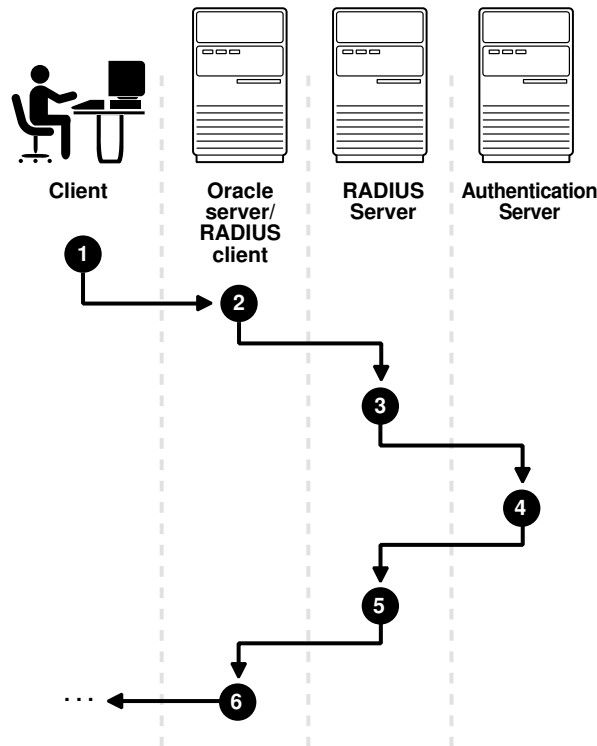

The following steps describe the synchronous authentication sequence:

1. A user logs in by entering a connect string, pass code, or other value. The client system passes this data to the Oracle database server. The pass code is frequently the password followed by the numbers in a token or text. Both credential factors are sent at the same time.
2. The Oracle database server, acting as the RADIUS client, passes the data from the Oracle client to the RADIUS server.
3. The RADIUS server passes the data to the appropriate authentication server.
4. The authentication server sends either an Access Accept or an Access Reject message back to the RADIUS server.
5. The RADIUS server passes this response to the Oracle database server/RADIUS client.
6. The Oracle database server/RADIUS client passes the response back to the Oracle client.

26.3.1.2 Example: Synchronous Authentication with Tokens

With token authentication, each user has a token card that displays a dynamic number that changes every sixty seconds.

To gain access to the Oracle database server/RADIUS client, the user enters a valid pass code that includes both a personal identification number (PIN) and the dynamic number currently displayed on the user's token. The Oracle database server passes this authentication information from the Oracle client to the RADIUS server, which in this case is the authentication server for validation. After the authentication server (RSA ACE/Server) validates the user, it sends an *accept* packet to the Oracle database server, which, in turn, passes it to the Oracle client. The user is now authenticated and able to access the appropriate tables and applications.

 **See Also:**

Documentation provided by RSA Security, Inc.

26.3.2 Challenge-Response (Asynchronous) Authentication Mode

When the system uses the asynchronous mode, the user does not need to enter a user name and password at the SQL*Plus CONNECT string.

- [Sequence for Challenge-Response \(Asynchronous\) Authentication Mode](#)
The sequence for challenge-response (asynchronous) authentication mode is comprised of 12 steps.
- [Example: Asynchronous Authentication with Tokens](#)
One type of token that is used with asynchronous authentication has a keypad and display.

26.3.2.1 Sequence for Challenge-Response (Asynchronous) Authentication Mode

The sequence for challenge-response (asynchronous) authentication mode is comprised of 12 steps.

 **Note:**

Challenge-response (Asynchronous) authentication mode is not supported on database servers that run on the Microsoft Windows platform, regardless of the client connection to the database server.

[Figure 26-3](#) shows the sequence in which challenge-response (asynchronous) authentication occurs. If the RADIUS server is the authentication server, then Steps 3, 4, and 5, and Steps 9, 10, and 11 are combined.

Figure 26-3 Asynchronous Authentication Sequence

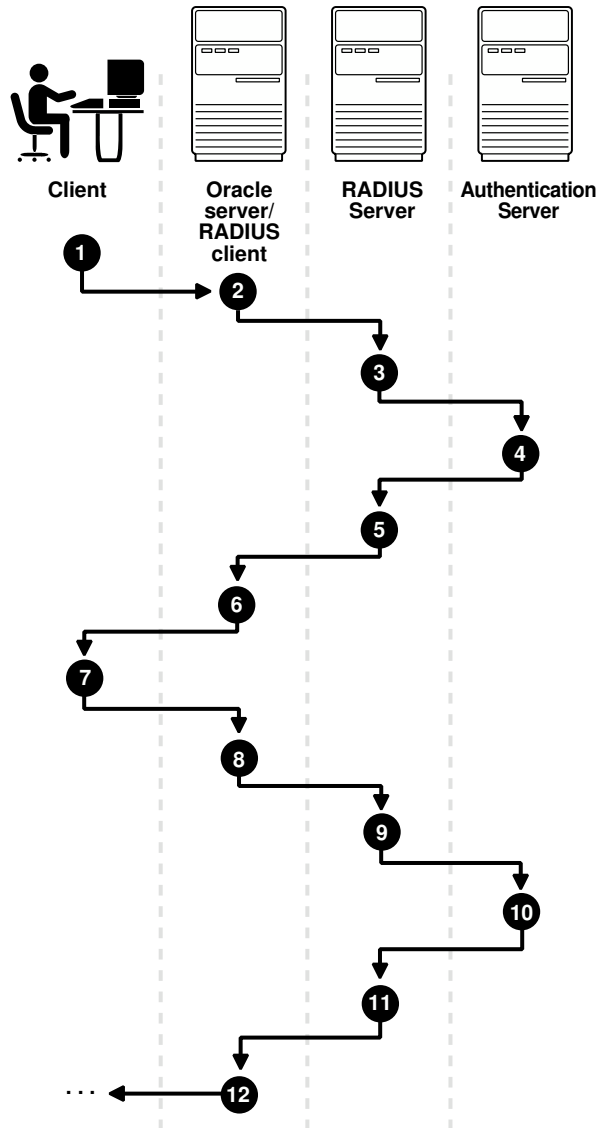

The following steps describe the asynchronous authentication sequence:

1. A user initiates a connection to an Oracle database server. The client system passes the data to the Oracle database server.
2. The Oracle database server checks that TCPS (Transparent Layer Security (TLS)) authentication is configured.
3. The Oracle database server, acting as the RADIUS client, passes the data from the Oracle client to the RADIUS server.
4. The RADIUS server passes the data to the appropriate authentication server, such as a Smart Card, SecurID ACE, or token card server.
5. The authentication server sends a challenge, such as a random number, to the RADIUS server.
6. The RADIUS server passes the challenge to the Oracle database server/RADIUS client.

7. The Oracle database server/RADIUS client, in turn, passes it to the Oracle client. A graphical user interface presents the challenge to the user. Oracle provides a JAVA GUI code example that you can modify for your use to present the challenge. See the `netradius.jar` and `netradius8.jar` files in the `$ORACLE_HOME/network/jlib` directory. (The `netradius8.jar` file is the latest.)
8. The user provides a response to the challenge. To formulate a response, the user can, for example, enter the received challenge into the token card. The token card provides a dynamic password that is entered into the graphical user interface. The Oracle client passes the user's response to the Oracle database server/RADIUS client.
9. The Oracle database server/RADIUS client sends the user's response to the RADIUS server.
10. The RADIUS server passes the user's response to the appropriate authentication server for validation.
11. The authentication server sends either an Access Accept or an Access Reject message back to the RADIUS server.
12. The RADIUS server passes the response to the Oracle database server/RADIUS client.
13. The Oracle database server/RADIUS client passes the response to the Oracle client.

26.3.2.2 Example: Asynchronous Authentication with Tokens

One type of token that is used with asynchronous authentication has a keypad and display.

When the user seeks access to an Oracle database server by entering a password, the information is passed to the appropriate authentication server by way of the Oracle database server/RADIUS client and the RADIUS server. The authentication server sends back a challenge to the client, by way of the RADIUS server and the Oracle database server. The user types that challenge into the token, and the token displays a number for the user to send in response.

The Oracle client then sends the user's response to the authentication server by way of the Oracle database server and the RADIUS server. If the user has typed a valid number, the authentication server sends an *accept* packet back to the Oracle client by way of the RADIUS server and the Oracle database server. The user is now authenticated and authorized to access the appropriate tables and applications. If the user has entered an incorrect response, the authentication server sends back a message rejecting the user's access.

26.4 RADIUS Parameters

Oracle provides a set of RADIUS-specific parameters.

- [RADIUS Parameters for Clients and Servers](#)
Oracle Database provides client and server parameters for using RADIUS authentication.
- [Minimum RADIUS Parameters](#)
At minimum, you should use the `SQLNET.AUTHENTICATION_SERVICES` and `SQLNET.RADIUS.AUTHENTICATION` parameters.
- [Initialization File Parameter for RADIUS](#)
For RADIUS, you should set the `OS_AUTHENT_PREFIX` initialization parameter.

26.4.1 RADIUS Parameters for Clients and Servers

Oracle Database provides client and server parameters for using RADIUS authentication.

The following table lists parameters to insert into the configuration files for clients and servers using RADIUS.

Table 26-2 RADIUS Authentication Parameters

Parameter	Description
<code>SQLNET.AUTHENTICATION_SERVICES</code>	Enables one or more authentication services
<code>SQLNET.RADIUS_ALTERNATE</code>	Specifies an alternate RADIUS server if the primary server is unavailable
<code>SQLNET.RADIUS_ALTERNATE_PORT</code>	Specifies the listening port of the alternate RADIUS server
<code>SQLNET.RADIUS_ALTERNATE_RETRIES</code>	Specifies the number of times that the database resends messages to alternate RADIUS servers
<code>SQLNET.RADIUS_ALTERNATE_TIMEOUT</code>	Sets the time for an alternate RADIUS server to wait for a response
<code>SQLNET.RADIUS_AUTHENTICATION</code>	Specifies a primary RADIUS server location, either by its host name or its IP address
<code>SQLNET.RADIUS_AUTHENTICATION_INTERFACE</code>	Specifies the class that contains the user interface for interacting with users
<code>SQLNET.RADIUS_AUTHENTICATION_PORT</code>	Specifies the listening port of a primary RADIUS server
<code>SQLNET.RADIUS_AUTHENTICATION_RETRIES</code>	Specifies the number of times the database should resend messages to a primary RADIUS server
<code>SQLNET.RADIUS_AUTHENTICATION_TIMEOUT</code>	Specifies the amount of time that the database should wait for a response from a primary RADIUS server
<code>SQLNET.RADIUS_CHALLENGE_KEYWORD</code>	Sets the keyword to request a challenge from the RADIUS server
<code>SQLNET.RADIUS_CHALLENGE_RESPONSE</code>	Enables or disables challenge responses
<code>SQLNET.RADIUS_CLASSPATH</code>	Sets the path for Java classes and the JDK Java libraries
<code>SQLNET.RADIUS_SECRET</code>	Specifies the location of a RADIUS secret key
<code>SQLNET.RADIUS_SEND_ACCOUNTING</code>	Enable and disables accounting

Related Topics

- [Oracle Database Net Services Reference](#)

26.4.2 Minimum RADIUS Parameters

At minimum, you should use the `SQLNET.AUTHENTICATION_SERVICES` and `SQLNET.RADIUS.AUTHENTICATION` parameters.

Use the following settings:

```
sqlnet.authentication_services = (radius)
sqlnet.radius.authentication    = IP-address-of-RADIUS-server
```

26.4.3 Initialization File Parameter for RADIUS

For RADIUS, you should set the `OS_AUTHENT_PREFIX` initialization parameter.

For example:

```
OS_AUTHENT_PREFIX=""
```

26.5 Enabling RADIUS Authentication, Authorization, and Accounting

You can enable RADIUS authentication, authorization, and accounting from the command line.

- **Step 1: Configure RADIUS Authentication**
To configure RADIUS authentication, you must first configure it on the Oracle client, then the server. Afterward, you can configure additional RADIUS features.
- **Step 2: Create a User and Grant Access**
After you complete the RADIUS authentication, you must create an Oracle Database user who is responsible for the RADIUS configuration.
- **Step 3: Configure External RADIUS Authorization (Optional)**
You must configure the Oracle server, the Oracle client, and the RADIUS server to RADIUS users who must connect to an Oracle database.
- **Step 4: Configure RADIUS Accounting**
RADIUS accounting logs information about access to the Oracle database server and stores it in a file on the RADIUS accounting server.
- **Step 5: Add the RADIUS Client Name to the RADIUS Server Database**
The RADIUS server that you select must comply with RADIUS standards.
- **Step 6: Configure the Authentication Server for Use with RADIUS**
After you add the RADIUS client name to the RADIUS server database, you can configure the authentication server to use the RADIUS.
- **Step 7: Configure the RADIUS Server for Use with the Authentication Server**
After you configure the authentication server for use with RADIUS, you can configure the RADIUS server to use the authentication server.
- **Step 8: Configure Mapping Roles**
If the RADIUS server supports vendor type attributes, then you can manage roles by storing them in the RADIUS server.

26.5.1 Step 1: Configure RADIUS Authentication

To configure RADIUS authentication, you must first configure it on the Oracle client, then the server. Afterward, you can configure additional RADIUS features.

- **Step 1A: Configure RADIUS on the Oracle Client**
You can use `sqlnet.ora` to configure RADIUS on the Oracle client.
- **Step 1B: Configure RADIUS on the Oracle Database Server**
You must create a file to hold the RADIUS key and store this file on the Oracle database server. Then you must configure the appropriate parameters in the `sqlnet.ora` file.
- **Step 1C: Configure Additional RADIUS Features**
You can change the default settings, configure the challenge-response mode, and set parameters for an alternate RADIUS server.

26.5.1.1 Step 1A: Configure RADIUS on the Oracle Client

You can use `sqlnet.ora` to configure RADIUS on the Oracle client.

1. Log in to the Oracle Database client that will use RADIUS.
2. Modify the `SQLNET.AUTHENTICATION_SERVICES` parameter in the `sqlnet.ora` file as follows:

```
SQLNET.AUTHENTICATION_SERVICES=(radius)
```

26.5.1.2 Step 1B: Configure RADIUS on the Oracle Database Server

You must create a file to hold the RADIUS key and store this file on the Oracle database server. Then you must configure the appropriate parameters in the `sqlnet.ora` file.

- [Step 1B \(1\): Create the RADIUS Secret Key File on the Oracle Database Server](#)
First, you must create the RADIUS secret key file.
- [Step 1B \(2\): Configure RADIUS Parameters on the Server \(sqlnet.ora file\)](#)
After you create RADIUS secret key file, you are ready to configure the appropriate parameters in the `sqlnet.ora` file.
- [Step 1B \(3\): Set Oracle Database Server Initialization Parameters](#)
After you configure the `sqlnet.ora` file, you must configure the `init.ora` initialization file.

26.5.1.2.1 Step 1B (1): Create the RADIUS Secret Key File on the Oracle Database Server

First, you must create the RADIUS secret key file.

1. Obtain the RADIUS secret key from the RADIUS server.
For each RADIUS client, the administrator of the RADIUS server creates a shared secret key, which must be less than or equal to 16 characters.
2. On the Oracle database server, create a directory:
 - (UNIX) `$ORACLE_HOME/network/security`
 - (Windows) `ORACLE_BASE\ORACLE_HOME\network\security`
3. Create the file `radius.key` to hold the shared secret copied from the RADIUS server. Place the file in the directory you created earlier in this procedure.
4. Copy the shared secret key and paste it (and nothing else) into the `radius.key` file created on the Oracle database server.
5. For security purposes, change the file permission of `radius.key` to read only, accessible only by the Oracle owner.

Oracle relies on the file system to keep this file secret.

See Also:

The RADIUS server administration documentation, for information about obtaining the secret key

26.5.1.2.2 Step 1B (2): Configure RADIUS Parameters on the Server (sqlnet.ora file)

After you create RADIUS secret key file, you are ready to configure the appropriate parameters in the `sqlnet.ora` file.

Note:

- Starting with Oracle Database 23ai, users authenticating to the database using the legacy RADIUS API no longer are granted administrative privileges. In previous releases, users authenticating with RADIUS API could be granted administrative privileges such as `SYSDBA` or `SYSBACKUP`. In Oracle Database 23ai, Oracle introduces a new RADIUS API that uses the latest standards. To grant administrative privileges to users, ensure the database connection to the database uses the new RADIUS API, and that you are using the Oracle Database 23ai client to connect to the Oracle Database 23ai server.
- Starting with Oracle Database 23ai, the older RADIUS API that is based on Request for Comments (RFC) 2138 is deprecated. Oracle Database 23ai introduces an updated RADIUS API based on RFC 6613 and RFC 6614. Oracle recommends that you start planning on migrating to use the new RADIUS API as soon as possible. The new API is enabled by default. These parameters associated with the older RADIUS API are also deprecated: `SQLNET.RADIUS_ALTERNATE`, `SQLNET.RADIUS_ALTERNATE_PORT`, `SQLNET.RADIUS_AUTHENTICATION`, and `SQLNET.RADIUS_AUTHENTICATION_PORT`. Refer to the Radius API documentation for information on changing the default to use the older RADIUS API.

1. Log in to the Oracle Database server that will use RADIUS.
2. Modify the following parameters in the `sqlnet.ora` file:

```
SQLNET.AUTHENTICATION_SERVICES=radius
SQLNET.RADIUS_TRANSPORT_PROTOCOL=[tls|udp]
SQLNET.RADIUS_AUTHENTICATION_TLS_HOST=RADIUS_host_name
SQLNET.RADIUS_AUTHENTICATION_TLS_PORT=Oracle_Database_server_port
```

In this specification:

- `SQLNET.AUTHENTICATION_SERVICES` sets the authentication service to be for RADIUS.
- `SQLNET.RADIUS_TRANSPORT_PROTOCOL` sets either Transport Layer Security (TLS) or User Datagram Protocol (UDP) as the protocol that the RADIUS server uses. If you omit this value, then TLS is used. If you must use UDP, then you must set the `SQLNET.RADIUS_ALLOW_WEAK_CLIENTS` and `SQLNET.RADIUS_ALLOW_WEAK_PROTOCOL` parameters. Note the following:
 - For database clients to connect to an Oracle Database 23ai or later server using the older protocol: set the `SQLNET.RADIUS_ALLOW_WEAK_CLIENTS` parameter.
 - For an Oracle Database 23ai or later server to connect to a RADIUS server using the older protocol: set the `SQLNET.RADIUS_ALLOW_WEAK_PROTOCOL` parameter.
- `SQLNET.RADIUS_AUTHENTICATION_TLS_HOST` sets the host name of the RADIUS server. This value is mandatory.

- `SQLNET.RADIUS_AUTHENTICATION_TLS_PORT` sets the port of the Oracle Database server. The default port is 2083. If the server uses a different port, then specify that value here.

If you need to use the earlier, deprecated RADIUS API parameters, then set the `SQLNET.RADIUS_ALLOW_WEAK_CLIENTS` and `SQLNET.RADIUS_ALLOW_WEAK_PROTOCOL` parameters to `TRUE`. The deprecated parameters are:

- `SQLNET.RADIUS_ALTERNATE`
- `SQLNET.RADIUS_AUTHENTICATION=RADIUS_SERVER_[host_name|IP_address]`
- `SQLNET.RADIUS_ALTERNATE_PORT`
- `SQLNET.RADIUS_AUTHENTICATION_PORT`

In this specification:

- `SQLNET.RADIUS_ALTERNATE` specifies an alternate RADIUS server if the primary server is unavailable.
- `SQLNET.RADIUS_AUTHENTICATION` specifies the host name or IP address of the RADIUS server. The *IP_address* can either be an Internet Protocol Version 4 (IPv4) or Internet Protocol Version 6 (IPv6) address. The RADIUS adapter supports both IPv4 and IPv6 based servers.
- `SQLNET.RADIUS_ALTERNATE_PORT` specifies the listening port of the alternate RADIUS server.
- `SQLNET.RADIUS_AUTHENTICATION` specifies a primary RADIUS server location, either by its host name or its IP address.
- `SQLNET.RADIUS_AUTHENTICATION_PORT` specifies the listening port of a primary RADIUS server.

This procedure does not configure the Transport Layer Security (TLS) connection between the Oracle Database server and client; additional configuration is required.

Related Topics

- [Configuring PKI Certificate Authentication](#)
You can configure Oracle Database to use PKI certificates for end-user authentication.

26.5.1.2.3 Step 1B (3): Set Oracle Database Server Initialization Parameters

After you configure the `sqlnet.ora` file, you must configure the `init.ora` initialization file.

1. Add the following setting to the `init.ora` file.

```
OS_AUTHENT_PREFIX=""
```

By default, the `init.ora` file is located in the `ORACLE_HOME/dbs` directory (or the same location of the data files) on Linux and UNIX systems, and in the `ORACLE_HOME\database` directory on Windows.

2. Restart the database.

For example:

```
SQL> SHUTDOWN  
SQL> STARTUP
```

Related Topics

- [Oracle Database Reference](#)

26.5.1.3 Step 1C: Configure Additional RADIUS Features

You can change the default settings, configure the challenge-response mode, and set parameters for an alternate RADIUS server.

- [Step 1C\(1\): Change Default Settings](#)
You can edit the `sqlnet.ora` file to change the default RADIUS settings.
- [Step 1C\(2\): Configure Challenge-Response Mode](#)
To configure challenge-response mode, you must specify information such as a dynamic password that you obtain from a token card.
- [Step 1C\(3\): Set Parameters for an Alternate RADIUS Server](#)
If you are using an alternate RADIUS server, then you must set additional parameters.
- [Step 1C\(4\): Enable Access by Non-TCPS Protocols or Older Clients](#)
If you need to have clients that do not use the TCPS protocol, then you must set additional `sqlnet.ora` RADIUS parameters.

26.5.1.3.1 Step 1C(1): Change Default Settings

You can edit the `sqlnet.ora` file to change the default RADIUS settings.

1. Log in to the Oracle Database server that will use RADIUS.
2. Modify the following `sqlnet.ora` parameters:

```
SQLNET.RADIUS_AUTHENTICATION_PORT=(port)
SQLNET.RADIUS_AUTHENTICATION_TIMEOUT=(number_of_seconds_to_wait_for_response)
SQLNET.RADIUS_AUTHENTICATION_RETRIES=(number_of_times_to_re-send_to_radius_server)
SQLNET.RADIUS_SECRET=(path/.radius.key)
```

In this specification:

- `SQLNET.RADIUS_AUTHENTICATION_PORT` specifies the listening port of a primary RADIUS server. The default is 1645.
- `SQLNET.RADIUS_AUTHENTICATION_TIMEOUT` specifies the amount of time in seconds that the database should wait for a response from a primary RADIUS server. The default is 5.
- `SQLNET.RADIUS_AUTHENTICATION_RETRIES` specifies the number of times that the database should resend messages to a primary RADIUS server. The default is 3.
- `SQLNET.RADIUS_SECRET` specifies the location of a file that contains the RADIUS secret key, which is a shared secret between a RADIUS client and server. The default is `radsec`, which points to `ORACLE_HOME/network/security/radius.key`. If you set a different RADIUS secret key file, then ensure that you set `SQLNET.RADIUS_SECRET` on the client as well as the database server. If the RADIUS server uses TLS as the protocol, then you can omit this parameter. For a RADIUS implementation that uses the User Datagram Protocol (UDP), the default parameter value cannot be used. The default value of `radsec` can only be used if you are using RADIUS with TLS over TCP.

Related Topics

- [Step 4: Configure RADIUS Accounting](#)
RADIUS accounting logs information about access to the Oracle database server and stores it in a file on the RADIUS accounting server.
- [Step 1B \(1\): Create the RADIUS Secret Key File on the Oracle Database Server](#)
First, you must create the RADIUS secret key file.

26.5.1.3.2 Step 1C(2): Configure Challenge-Response Mode

To configure challenge-response mode, you must specify information such as a dynamic password that you obtain from a token card.

With the RADIUS adapter, this interface is Java-based to provide optimal platform independence. Note that third-party vendors of authentication devices must customize this graphical user interface to fit their particular device. For example, a smart card vendor would customize the Java interface so that the Oracle client reads data, such as a dynamic password, from the smart card. When the smart card receives a challenge, it responds by prompting the user for more information, such as a PIN.

1. Log in to the Oracle Database server that will use RADIUS.
2. If you are using JDK 1.1.7 or JRE 1.1.7, then set the `JAVA_HOME` environment variable to the JRE or JDK location on the system where the Oracle client is run:
 - On UNIX, enter this command at the prompt:

```
% setenv JAVA_HOME /usr/local/packages/jre1.1.7B
```

- On Windows, select **Start, Settings, Control Panel, System, Environment**, and set the `JAVA_HOME` variable as follows:

```
c:\java\jre1.1.7B
```

This step is not required for any other JDK/JRE version.

3. Modify the following `sqlnet.ora` parameters:

```
SQLNET.RADIUS_CHALLENGE_RESPONSE=([on | off])
SQLNET.RADIUS_CHALLENGE_KEYWORD=(keyword)
SQLNET.RADIUS_AUTHENTICATION_INTERFACE=(default_RADIUS_interface)
```

In this specification:

- `SQLNET.RADIUS_CHALLENGE_RESPONSE` enables or disables the challenge responses. To enable, enter `on`; to disable, enter `off`. The default is `off`.
- `SQLNET.RADIUS_CHALLENGE_KEYWORD` enables you to set challenge keyword. The default is `keyword`. The keyword feature is supported by some but not all RADIUS servers. You can use this feature only if the RADIUS server supports it. By setting a keyword, you let the user avoid using a password to verify identity. If the user does *not* enter a password, the keyword you set here is passed to the RADIUS server which responds with a challenge requesting, for example, a driver's license number or birth date. If the user *does* enter a password, the RADIUS server may or may not respond with a challenge, depending upon the configuration of the RADIUS server.
- `SQLNET.RADIUS_AUTHENTICATION_INTERFACE` specifies the class that contains the user interface for interacting with users. Enter the name of interface including the package name delimited by the character `/` for the `.` character. If other than the default RADIUS interface is used, then you also must edit the `sqlnet.ora` file to enter `SQLNET.RADIUS_CLASSPATH=(location)`, where `location` is the complete path name of the jar file. It defaults to `$ORACLE_HOME/network/jlib/netradius.jar`: `$ORACLE_HOME/JRE/lib/vt.jar`

Related Topics

- [Integrating Authentication Devices Using RADIUS](#)
The RADIUS challenge-response user interface further enhances authentication in a RADIUS configuration.

26.5.1.3.3 Step 1C(3): Set Parameters for an Alternate RADIUS Server

If you are using an alternate RADIUS server, then you must set additional parameters.

- Set the following parameters in the `sqlnet.ora` file:

```
SQLNET.RADIUS_ALTERNATE=(hostname_or_IP_address_of_alternate_RADIUS_server)
SQLNET.RADIUS_ALTERNATE_PORT=(1812)
SQLNET.RADIUS_ALTERNATE_TIMEOUT=(number_of_seconds_to_wait_for_response)
SQLNET.RADIUS_ALTERNATE_RETRIES=(number_of_times_to_re-send_to_RADIUS_server)
SQLNET.RADIUS_ALTERNATE_TLS_HOST=(TLS_host)
SQLNET.RADIUS_ALTERNATE_TLS_PORT=(TLS_port)
```

Note:

Starting with Oracle Database 23ai, the `SQLNET.RADIUS_ALTERNATE` and `SQLNET.RADIUS_ALTERNATE_PORT` parameters are deprecated.

26.5.1.3.4 Step 1C(4): Enable Access by Non-TCPS Protocols or Older Clients

If you need to have clients that do not use the TCPS protocol, then you must set additional `sqlnet.ora` RADIUS parameters.

1. Log in to the Oracle Database client that will use RADIUS.
2. Modify the `RADIUS_ALLOW_WEAK_PROTOCOL` parameter in the `sqlnet.ora` file.

```
SQLNET.RADIUS_ALLOW_WEAK_PROTOCOL=[TRUE|FALSE]
```

When set to `TRUE`, this parameter enables Oracle Database clients that use non-TCPS protocols to communicate with the upgraded Oracle Database server. The default is `FALSE` so that only strong clients can use RADIUS.

3. Log in to the Oracle Database server that will use RADIUS.
4. Modify the `RADIUS_ALLOW_WEAK_CLIENTS` in the `sqlnet.ora` file.

```
SQLNET.RADIUS_ALLOW_WEAK_CLIENTS=[TRUE|FALSE]
```

When set to `TRUE`, this parameter enables older Oracle Database clients to communicate with the upgraded Oracle Database server. The default is `TRUE`.

26.5.2 Step 2: Create a User and Grant Access

After you complete the RADIUS authentication, you must create an Oracle Database user who is responsible for the RADIUS configuration.

1. Connect to the CDB root or to the PDB in which RADIUS is implemented.

For example:

```
CONNECT system@pdb_name;
Enter password: password
```

2. Create the user as a common user if you connected to the CDB root, or as a local user if you connected to a PDB..

```
CREATE USER username IDENTIFIED EXTERNALLY;
GRANT CREATE SESSION TO USER user_name;
```

3. Enter the user `username` in the RADIUS server's users file.



See Also:

Administration documentation for the RADIUS server

26.5.3 Step 3: Configure External RADIUS Authorization (Optional)

You must configure the Oracle server, the Oracle client, and the RADIUS server to RADIUS users who must connect to an Oracle database.

- [Step 3A: Configure the Oracle Server \(RADIUS Client\)](#)
You can edit the `init.ora` file to configure an Oracle server for a RADIUS client.
- [Step 3B: Configure the Oracle Client Where Users Log In](#)
Next, you must configure the Oracle client where users log in.
- [Step 3C: Configure the RADIUS Server](#)
To configure the RADIUS server, you must modify the RADIUS server attribute configuration file.

26.5.3.1 Step 3A: Configure the Oracle Server (RADIUS Client)

You can edit the `init.ora` file to configure an Oracle server for a RADIUS client.

To do so, you must modify the `init.ora` file, restart the database, and set the RADIUS challenge-response mode.

1. Set the RADIUS challenge-response mode to `ON` for the server if you have not already done so.
2. Add externally identified users and roles.

Related Topics

- [Step 1C\(2\): Configure Challenge-Response Mode](#)
To configure challenge-response mode, you must specify information such as a dynamic password that you obtain from a token card.

26.5.3.2 Step 3B: Configure the Oracle Client Where Users Log In

Next, you must configure the Oracle client where users log in.

- Set the RADIUS challenge-response mode to `ON` for the client if you have not already done so.

Related Topics

- [Step 1C\(2\): Configure Challenge-Response Mode](#)
To configure challenge-response mode, you must specify information such as a dynamic password that you obtain from a token card.

26.5.3.3 Step 3C: Configure the RADIUS Server

To configure the RADIUS server, you must modify the RADIUS server attribute configuration file.

1. Add the following attributes to the RADIUS server attribute configuration file:

ATTRIBUTE NAME	CODE	TYPE
VENDOR_SPECIFIC	26	Integer
ORACLE_ROLE	1	String

2. Assign a Vendor ID for Oracle in the RADIUS server attribute configuration file that includes the SMI Network Management Private Enterprise Code of 111.

For example, enter the following in the RADIUS server attribute configuration file:

```
VALUE      VENDOR_SPECIFIC      ORACLE      111
```

3. Using the following syntax, add the `ORACLE_ROLE` attribute to the user profile of the users who will use external RADIUS authorization:

```
ORA_databaseSID_rolename
```

In this specification.:

- `ORA` designates that this role is used for Oracle purposes
- `databaseSID` is the Oracle system identifier that is configured in the database `init.ora` file.
By default, the `init.ora` file is located in the `ORACLE_HOME/dbs` directory (or the same location of the data files) on Linux and UNIX systems, and in the `ORACLE_HOME\database` directory on Windows.
- `rolename` is the name of role as it is defined in the data dictionary after you remove the `SYS` prefix.

Ensure that RADIUS groups that map to Oracle roles adhere to the `ORACLE_ROLE` syntax.

For example:

```
USERNAME      USERPASSWORD="user_password",
              SERVICE_TYPE=login_user,
              VENDOR_SPECIFIC=ORACLE,
              ORACLE_ROLE=ORA_oradb_dba
```

See Also:

The RADIUS server administration documentation for information about configuring the server.

26.5.4 Step 4: Configure RADIUS Accounting

RADIUS accounting logs information about access to the Oracle database server and stores it in a file on the RADIUS accounting server.

Use this feature only if both the RADIUS server and authentication server support it.

- [Step 4A: Set RADIUS Accounting on the Oracle Database Server](#)
You can use `sqlnet.ora` to enable RADIUS accounting on the server.

- **Step 4B: Configure the RADIUS Accounting Server**
RADIUS Accounting Server resides on the same host as the RADIUS authentication server or on a separate host.

26.5.4.1 Step 4A: Set RADIUS Accounting on the Oracle Database Server

You can use `sqlnet.ora` to enable RADIUS accounting on the server.

1. Log in to the Oracle Database server that will use RADIUS.
2. Modify the `SQLNET.RADIUS_SEND_ACCOUNTING` parameter in the `sqlnet.ora` file as follows:

```
SQLNET.RADIUS_SEND_ACCOUNTING=on
```

When you enable accounting, packets are sent to the active RADIUS server at the listening port number's value plus one.

26.5.4.2 Step 4B: Configure the RADIUS Accounting Server

RADIUS Accounting Server resides on the same host as the RADIUS authentication server or on a separate host.

- See the administration documentation for the RADIUS server, for information about configuring RADIUS accounting.

26.5.5 Step 5: Add the RADIUS Client Name to the RADIUS Server Database

The RADIUS server that you select must comply with RADIUS standards.

You can use any RADIUS server that complies with the Internet Engineering Task Force (IETF) RFC #2138, *Remote Authentication Dial In User Service (RADIUS)*, and RFC #2139 *RADIUS Accounting* standards. Because RADIUS servers vary, consult the documentation for your particular RADIUS server for any unique interoperability requirements.

1. Open the clients file, which is located in `/etc/raddb/clients`.

The following text and table appear:

```
@ (#) clients 1.1 2/21/96 Copyright 1991 Livingston Enterprises Inc
This file contains a list of clients which are allowed to make authentication
requests and
their encryption key. The first field is a valid hostname. The second field
(separated by
blanks or tabs) is the encryption key.
Client Name                               Key
```

2. In the `CLIENT NAME` column, enter the host name or IP address of the host on which the Oracle database server is running.

In the `KEY` column, type the shared secret. The value you enter in the `CLIENT NAME` column, whether it is the client's name or IP address, depends on the RADIUS server.

3. Save and close the clients file.

**See Also:**

Administration documentation for the RADIUS server

26.5.6 Step 6: Configure the Authentication Server for Use with RADIUS

After you add the RADIUS client name to the RADIUS server database, you can configure the authentication server to use the RADIUS.

- Refer to the authentication server documentation for instructions about configuring the authentication servers.

26.5.7 Step 7: Configure the RADIUS Server for Use with the Authentication Server

After you configure the authentication server for use with RADIUS, you can configure the RADIUS server to use the authentication server.

- Refer to the RADIUS server documentation for instructions about configuring the RADIUS server for use with the authentication server.

26.5.8 Step 8: Configure Mapping Roles

If the RADIUS server supports vendor type attributes, then you can manage roles by storing them in the RADIUS server.

The Oracle database server downloads the roles when there is a `CONNECT` request using RADIUS. To use this feature, you must configure roles on both the Oracle database server and the RADIUS server.

1. Use a text editor to set the `OS_ROLES` parameter in the initialization parameters file on the Oracle database server.

By default, the `init.ora` file is located in the `ORACLE_HOME/dbs` directory (or the same location of the data files) on Linux and UNIX systems, and in the `ORACLE_HOME\database` directory on Windows.

2. Stop and restart the Oracle database server.

For example:

```
SHUTDOWN
STARTUP
```

3. Create each role that the RADIUS server will manage on the Oracle database server with the value `IDENTIFIED EXTERNALLY`.

To configure roles on the RADIUS server, use the following syntax:

```
ORA_ DatabaseName.DatabaseDomainName_RoleName
```

In this specification:

- `DatabaseName` is the name of the Oracle database server for which the role is being created. This is the same as the value of the `DB_NAME` initialization parameter.

- `DatabaseDomainName` is the name of the domain to which the Oracle database server belongs. The value is the same as the value of the `DB_DOMAIN` initialization parameter.
- `RoleName` is name of the role created in the Oracle database server.

For example:

```
ORA_USERDB.US.EXAMPLE.COM_MANAGER
```

4. Configure RADIUS challenge-response mode.

Related Topics

- [Challenge-Response \(Asynchronous\) Authentication Mode](#)
When the system uses the asynchronous mode, the user does not need to enter a user name and password at the SQL*Plus CONNECT string.
- [Step 1C\(2\): Configure Challenge-Response Mode](#)
To configure challenge-response mode, you must specify information such as a dynamic password that you obtain from a token card.

26.6 Using RADIUS to Log in to a Database

You can use RADIUS to log into a database by using either synchronous authentication mode or challenge-response mode.

- Start SQL*Plus and use one of the following ways to log in to the database:
 - If you are using the synchronous authentication mode, first ensure that challenge-response mode is not turned to `ON`, and then enter the following command:

```
CONNECT username@database_alias  
Enter password: password
```

- If you are using the challenge-response mode, ensure that challenge-response mode is set to `ON` and then enter the following command:

```
CONNECT /@database_alias
```

The challenge-response mode can be configured for all login cases.

26.7 Integrating Authentication Devices Using RADIUS

The RADIUS challenge-response user interface further enhances authentication in a RADIUS configuration.

- [About the RADIUS Challenge-Response User Interface](#)
You can use third-party authentication vendors to customize the RADIUS challenge-response user interface to fit a particular device.
- [Customizing the RADIUS Challenge-Response User Interface](#)
You can customize `OracleRadiusInterface` interface by creating your own class.
- [Example: Using the OracleRadiusInterface Interface](#)
You can use the `OracleRadiusInterface` interface to retrieve a user name and password.

26.7.1 About the RADIUS Challenge-Response User Interface

You can use third-party authentication vendors to customize the RADIUS challenge-response user interface to fit a particular device.

You can set up any authentication device that supports the RADIUS standard to authenticate Oracle users. When your authentication device uses the challenge-response mode, a graphical interface prompts the end user first for a password and then for additional information (for example, a dynamic password that the user obtains from a token card). This interface is Java-based to provide optimal platform independence.

Third-party vendors of authentication devices must customize this graphical user interface to fit their particular device. For example, a smart card vendor customizes the Oracle client to issue the challenge to the smart card reader. Then, when the smart card receives a challenge, it responds by prompting the user for more information, such as a PIN.

Related Topics

- [Configuring RADIUS Authentication](#)
RADIUS is a client/server security protocol widely used to enable remote authentication and access.

26.7.2 Customizing the RADIUS Challenge-Response User Interface

You can customize `OracleRadiusInterface` interface by creating your own class.

1. Open the `sqlnet.ora` file.

By default, the `sqlnet.ora` file is located in the `ORACLE_HOME/network/admin` directory or in the location set by the `TNS_ADMIN` environment variable. Ensure that you have properly set the `TNS_ADMIN` variable to point to the correct `sqlnet.ora` file.

2. Locate the `SQLNET.RADIUS_AUTHENTICATION_INTERFACE` parameter, and replace the name of the class listed there (`DefaultRadiusInterface`), with the name of the new class that you have created.

When you make this change in the `sqlnet.ora` file, the class is loaded on the Oracle client in order to handle the authentication process.

3. Save and exit the `sqlnet.ora` file

The third party must implement the `OracleRadiusInterface` interface, which is located in the `ORACLE.NET.RADIUS` package.

26.7.3 Example: Using the OracleRadiusInterface Interface

You can use the `OracleRadiusInterface` interface to retrieve a user name and password.

[Example 26-1](#) shows how to use the `OracleRadiusInterface` interface.

Example 26-1 Using the OracleRadiusInterface Interface

```
public interface OracleRadiusInterface {
    public void radiusRequest();
    public void radiusChallenge(String challenge);
    public String getUserName();
    public String getPassword();
}
```

In this specification:

- `radiusRequest` prompts the end user for a user name and password, which will later be retrieved through `getUserName` and `getPassword`.

- `getUserName` extracts the user name the user enters. If this method returns an empty string, it is assumed that the user wants to cancel the operation. The user then receives a message indicating that the authentication attempt failed.
- `getPassword` extracts the password the user enters. If `getUserName` returns a valid string, but `getPassword` returns an empty string, the challenge keyword is replaced as the password by the database. If the user enters a valid password, a challenge may or may not be returned by the RADIUS server.
- `radiusChallenge` presents a request sent from the RADIUS server for the user to respond to the server's challenge.
- `getResponse` extracts the response the user enters. If this method returns a valid response, then that information populates the `User-Password` attribute in the new `Access-Request` packet. If an empty string is returned, the operation is canceled from both sides by returning the corresponding value.

Customizing the Use of Strong Authentication

You can configure multiple authentication methods under Oracle Database native network encryption and strong authentication.

- [Connecting to a Database Using Strong Authentication](#)
You can use password authentication to connect to a database that is configured to use strong authentication.
- [Disabling Strong Authentication and Native Network Encryption](#)
You can use Oracle Net Manager to disable strong authentication and native network encryption.
- [Configuring Multiple Authentication Methods](#)
Many networks use more than one authentication method on a single security server.
- [Configuring Oracle Database for External Authentication](#)
You can use parameters to configure Oracle Database for network authentication.

27.1 Connecting to a Database Using Strong Authentication

You can use password authentication to connect to a database that is configured to use strong authentication.

1. To connect to an Oracle database server using a user name and password when an Oracle network and strong authentication method has been configured, disable the external authentication.

You must first disable strong authentication by disabling the external authentication before you can connect to an Oracle Database server using a user name and password when an Oracle network and strong authentication method has been configured.

2. With the external authentication disabled, connect to the database using the following format:

```
% sqlplus username@net_service_name
Enter password: password
```

For example:

```
% sqlplus hr@emp
Enter password: password
```

You can configure multiple authentication methods, including both externally authenticated users and password authenticated users, on a single database.

Related Topics

- [Disabling Strong Authentication and Native Network Encryption](#)
You can use Oracle Net Manager to disable strong authentication and native network encryption.

27.2 Disabling Strong Authentication and Native Network Encryption

You can use Oracle Net Manager to disable strong authentication and native network encryption.

1. Start Oracle Net Manager.
 - (UNIX) From `$ORACLE_HOME/bin`, enter the following command at the command line:

```
netmgr
```
 - (Windows) Select **Start, Programs, Oracle - HOME_NAME, Configuration and Migration Tools**, then **Net Manager**.
2. Expand **Oracle Net Configuration**, and from **Local**, select **Profile**.
3. From the **Naming** list, select **Network Security**.
The Network Security tabbed window appears.
4. Select the **Authentication** tab (which is selected by default).
5. Sequentially move all authentication methods from the Selected Method list to the Available Methods list by selecting a method and choosing the left arrow [**<**].

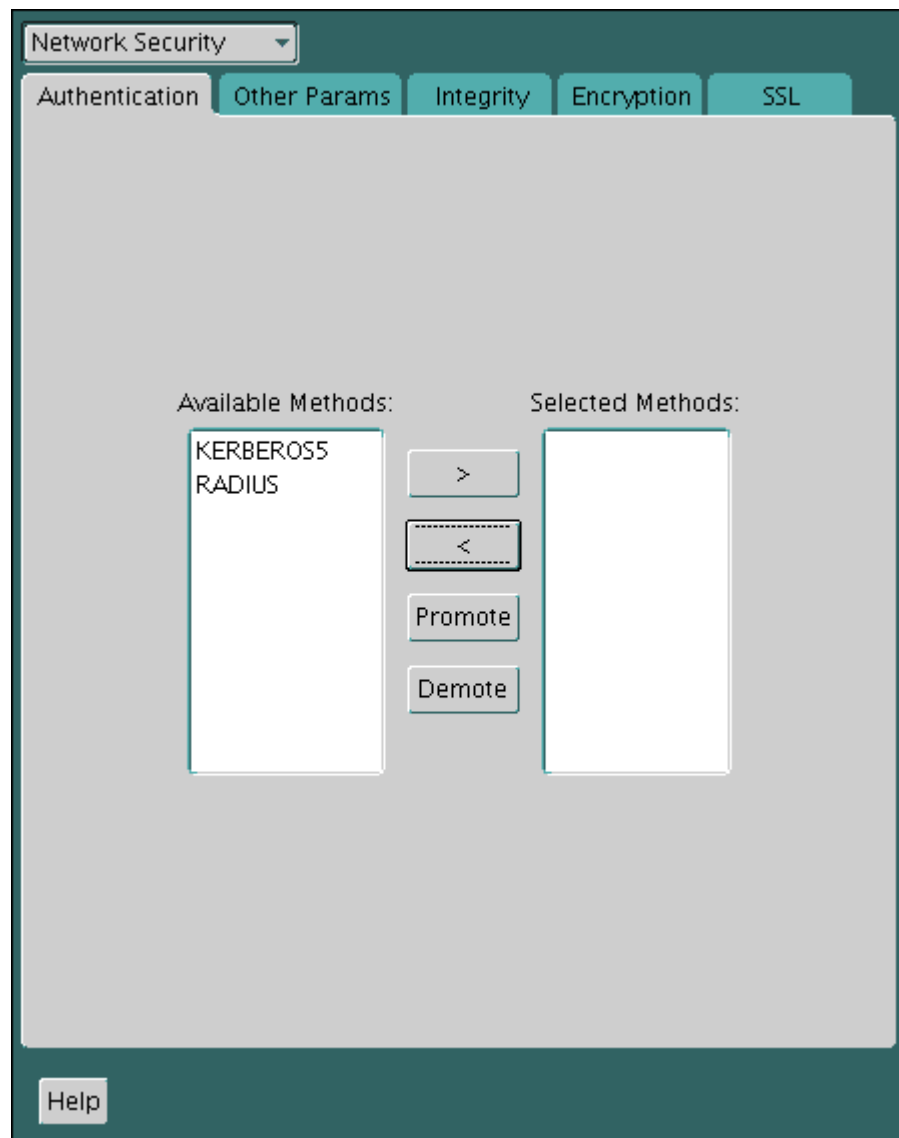

6. Select the **Encryption** tab.
7. Do the following:
 - From the **Encryption** menu, select **SERVER**.
 - Set **Encryption Type** to **rejected**.
 - In the **Encryption Seed** field, enter a valid encryption seed if an encryption seed was used.
 - Under **Select Methods**, move any methods to the **Available Methods** field.
8. Repeat these steps to disable native network encryption for the client, by selecting **CLIENT** from the **Encryption** menu.
9. From the **File** menu, select **Save Network Configuration**.

The `sqlnet.ora` file is updated with the following entries to indicate that strong authentication and native network encryption are disabled:

Strong authentication:

```
SQLNET.AUTHENTICATION_SERVICES = (NONE)
```

If you are using local database password authentication, then you can also set `SQLNET.AUTHENTICATION_SERVICES=(NONE)` in the client. This setting improves client performance.

For native network encryption, you can set it individually, for the server side and for the client side. The following examples show native network encryption being disabled for both the server and the client:

```
SQLNET.ENCRYPTION_SERVER = REJECTED
SQLNET.ENCRYPTION_CLIENT = REJECTED
```

Be aware that the settings in the `sqlnet.ora` file apply to all pluggable databases (PDBs).

Related Topics

- [About the Values for Negotiating Encryption and Integrity](#)
Oracle Net Manager can be used to specify four possible values for the encryption and integrity configuration parameters.

27.3 Configuring Multiple Authentication Methods

Many networks use more than one authentication method on a single security server.

Accordingly, Oracle Database lets you configure your network so that Oracle clients can use a specific authentication method, and Oracle database servers can accept any method specified.

You can set up multiple authentication methods on both client and server systems either by using Oracle Net Manager, or by using any text editor to modify the `sqlnet.ora` file. Use Oracle Net Manager to add authentication methods to both clients and servers.

1. Start Oracle Net Manager.
 - (UNIX) From `$ORACLE_HOME/bin`, enter the following command at the command line:

```
netmgr
```

- (Windows) Select **Start, Programs, Oracle - HOME_NAME, Configuration and Migration Tools**, then **Net Manager**.

2. Expand **Oracle Net Configuration**, and from **Local**, select **Profile**.
3. From the **Naming** list, select **Network Security**.

The Network Security tabbed window appears.

4. Select the **Authentication** tab.
5. Select a method listed in the Available Methods list.
6. Sequentially move selected methods to the Selected Methods list by clicking the right arrow (>).
7. Arrange the selected methods in order of desired use.

To do this, select a method in the Selected Methods list, and select **Promote** or **Demote** to position it in the list.

8. From the **File** menu, select **Save Network Configuration**.

The `sqlnet.ora` file is updated with the following entry, listing the selected authentication methods:

```
SQLNET.AUTHENTICATION_SERVICES = (KERBEROS5, RADIUS)
```



Note:

SecurID functionality is available through RADIUS; RADIUS support is built into the RSA ACE/Server.

Related Topics

- [Configuring RADIUS Authentication](#)
RADIUS is a client/server security protocol widely used to enable remote authentication and access.

27.4 Configuring Oracle Database for External Authentication

You can use parameters to configure Oracle Database for network authentication.

- [Setting the SQLNET.AUTHENTICATION_SERVICES Parameter in sqlnet.ora](#)
The `SQLNET.AUTHENTICATION_SERVICES` parameter defines the authentication method and version to be used.
- [Setting OS_AUTHENT_PREFIX to a Null Value](#)
The `OS_AUTHENT_PREFIX` parameter specifies a prefix that Oracle Database uses to authenticate users who attempt to connect to the server.

27.4.1 Setting the SQLNET.AUTHENTICATION_SERVICES Parameter in sqlnet.ora

The `SQLNET.AUTHENTICATION_SERVICES` parameter defines the authentication method and version to be used.

You must set the `SQLNET.AUTHENTICATION_SERVICES` parameter in the `sqlnet.ora` file for all clients and servers to enable each to use a supported authentication method.

- Set the `SQLNET.AUTHENTICATION_SERVICES` parameter using the following syntax:

```
SQLNET.AUTHENTICATION_SERVICES=(oracle_authentication_method)
```

For example, for all clients and servers using Kerberos authentication:

```
SQLNET.AUTHENTICATION_SERVICES=(KERBEROS5)
```

By default, the `sqlnet.ora` file is located in the `ORACLE_HOME/network/admin` directory or in the location set by the `TNS_ADMIN` environment variable. Ensure that you have properly set the `TNS_ADMIN` variable to point to the correct `sqlnet.ora` file.

If you are only using local database password authentication, then set the `SQLNET.AUTHENTICATION_SERVICES` as follows for better client performance:

```
SQLNET.AUTHENTICATION_SERVICES=(NONE)
```

Related Topics

- [SQL*Plus User's Guide and Reference](#)

27.4.2 Setting OS_AUTHENT_PREFIX to a Null Value

The `OS_AUTHENT_PREFIX` parameter specifies a prefix that Oracle Database uses to authenticate users who attempt to connect to the server.

Authentication service-based user names can be long, and Oracle user names are limited to 128 bytes. Oracle strongly recommends that you set the `OS_AUTHENT_PREFIX` parameter to a null value.

- In the initialization file for the database instance, set `OS_AUTHENT_PREFIX` as follows:

```
OS_AUTHENT_PREFIX=""
```

Note the following:

- The default value for `OS_AUTHENT_PREFIX` is `OPS$`; however, you can set it to any string.
- If a database already has the `OS_AUTHENT_PREFIX` set to a value other than `NULL ("")`, then *do not change it*, because it can inhibit previously created, externally identified users from connecting to the Oracle server.

After you have set `OS_AUTHENT_PREFIX` to null, then you can create external users by using the following syntax:

```
CREATE USER os_authent_prefix_username IDENTIFIED EXTERNALLY;
```

For example, to create the user `king`:

```
CREATE USER king IDENTIFIED EXTERNALLY;
```

The advantage of creating a user in this way is that you no longer need to maintain different user names for externally identified users. This is true for all supported authentication methods.

Part VI

Monitoring Database Activity with Auditing

Part VI describes how to monitor database activity with auditing.

- [Introduction to Auditing](#)
Oracle Database provides the industry's most comprehensive auditing capability, enabling the capture of detailed information relating to who, what, when the action was performed, and the associated context with the activity which generated the audit record.
- [Provisioning Audit Policies](#)
Oracle Database provides a variety of ways for you to audit activities.
- [Creating Custom Unified Audit Policies](#)
Oracle Database provides the flexibility to create and manage custom unified audit policies for your specialized needs.
- [Value-Based Auditing with Fine-Grained Audit Policies](#)
Fine-grained auditing enables you to perform value-based auditing to audit access to certain rows based on values in specific columns.
- [Administering the Audit Trail](#)
Properly managing the audit trail on your databases ensures efficient performance and optimum use of the disk space. Users granted the `AUDIT_ADMIN` role can manage, archive, and purge audit trail.

Introduction to Auditing

Oracle Database provides the industry's most comprehensive auditing capability, enabling the capture of detailed information relating to who, what, when the action was performed, and the associated context with the activity which generated the audit record.

- [What Is Auditing?](#)
Database auditing is the most accurate record of any database activity. Auditing tracks the use of privileges, activities of highly privileged users, access to sensitive data, actions performed on database objects and modifications made to database settings.
- [Why Is Auditing Used?](#)
You typically use auditing to monitor user activity.
- [Best Practices for Auditing](#)
You should follow best practices guidelines for auditing.
- [Unified Auditing and Its Benefits](#)
Unified auditing was introduced in Oracle Database 12c with significant enhancements to auditing functionality.
- [Who Can Perform Auditing?](#)
Oracle provides two roles for users who perform auditing: `AUDIT_ADMIN` and `AUDIT_VIEWER`, to enable separation of duties.
- [Handling the Desupport of Traditional Auditing](#)
Traditional auditing is desupported, starting in Oracle Database 23ai. Oracle recommends that you use unified auditing instead.
- [Unified Auditing in a Multitenant Environment](#)
You can apply audit settings to individual PDBs or to the CDB, depending on the type of policy.
- [Auditing in a Distributed Database](#)
Auditing is site autonomous in that a database instance audits only the statements issued by directly connected users.

Related Topics

- [Guidelines for Auditing](#)
Oracle provides guidelines for auditing.

28.1 What Is Auditing?

Database auditing is the most accurate record of any database activity. Auditing tracks the use of privileges, activities of highly privileged users, access to sensitive data, actions performed on database objects and modifications made to database settings.

Database auditing has steadily increased in both capability and popularity over the past decade, and today is mandatory in most organizations. They need to audit not only to detect any unauthorized use, but also to ensure that they comply with different regulations, such as General Data Protection Regulation (GDPR), Payment Card Industry (PCI), California Consumer Privacy Act (CCPA), and other privacy regulations across the globe.

Database auditing is typically used for the following **use cases**:

- Monitoring activities of privileged database administrators
- Detecting unauthorized activity on sensitive assets
- Assisting with investigations of data breaches or other suspicious activity
- Providing proof of monitoring critical assets to auditors
- Providing reports on changes to the database environment to auditors

Database auditing is the most accurate record of any database activity, not just from connections happening over the wire but also through direct local logins, recursive SQLs, dynamic SQLs, and stored procedures. .

An audit record gives you full execution context including details of the operation, type of SQL statement executed, use of powerful system privileges, operation performed, database object involved in the operation, and other session details that are useful for forensic analysis.

You can configure auditing for both successful and failed operations, and include or exclude specific users from the audit. Auditing is independent of external connection factors like the network encryption, the access path, or the user, and is always available as a reliable source of actual events that have happened.

You can audit individual actions of the pluggable database (PDB) or individual actions in the entire multitenant container database (CDB). In addition to auditing the standard activities the database provides, auditing can include activities from Oracle Database Real Application Security, Oracle Automatic Storage Management, Oracle Recovery Manager, Oracle Data Pump, Oracle Machine Learning for SQL, Oracle Database Vault, Oracle Label Security, and Oracle SQL*Loader direct path events.

Oracle Database auditing has been enhanced with each successive release of the database. Traditional auditing was the historical database auditing approach in releases earlier than Oracle Database 12c. Unified auditing was introduced subsequently in Oracle Database 12c, where auditing functionality was significantly enhanced to provide a robust and highly customizable framework that can be fine-tuned to address specific security requirements. **Traditional auditing** is desupported in Oracle Database 23ai and Oracle recommends that you use **unified auditing**.

Oracle Database auditing (unified auditing) is enabled by default. Follow the below set of guidelines to ensure your database auditing requirements meet the most common security and compliance needs:

1. **Make the most of the *always-on mandatory audits*.** Certain security-sensitive database activities are mandatorily audited in the Oracle Database and cannot be disabled. Do not duplicate them.
2. **Use the *predefined unified audit policies*.** Oracle Database provides predefined unified audit policies that encompass the standard audit settings that most regulatory agencies require.
 - a. The `ORA_SECURECONFIG` and `ORA_LOGIN_LOGOUT` pre-defined unified audit policies are automatically enabled in most deployments. Ensure to enable them if you have not done so already.
 - b. Autonomous databases provides numerous predefined audit policies that are enabled by default.
 - c. If you are using Oracle Data Safe or Oracle Audit Vault and Database Firewall (AVDF) to monitor the database activity across your enterprise, these products also offer a number of predefined audit policies to provision with a single click.

3. **Create *custom audit policies* for specialized use cases.** Oracle Database provides the flexibility to create and enable custom audit policies for your specific needs. You can either define unified audit policies or fine-grained audit policies for specialized needs.

Database auditing is frequently augmented with Database Activity Monitoring (DAM) solutions that collect and store the audit data for alert generation, analysis, and reporting. Oracle Database security products that offer DAM solutions include Oracle Data Safe, and Oracle Audit Vault and Database Firewall (AVDF).

Related Topics

- [Activities That Are Mandatorily Audited](#)
Certain security sensitive database activities are always audited and such audit configurations cannot be disabled.
- [Auditing Activities with the Predefined Unified Audit Policies](#)
Oracle Database provides predefined unified audit policies that cover commonly used security-relevant audit settings.
- [Creating Custom Unified Audit Policies](#)
Oracle Database provides the flexibility to create and manage custom unified audit policies for your specialized needs.
- [Value-Based Auditing with Fine-Grained Audit Policies](#)
Fine-grained auditing enables you to perform value-based auditing to audit access to certain rows based on values in specific columns.
- [Oracle Database PL/SQL Packages and Types Reference](#)
- [Handling the Desupport of Traditional Auditing](#)
Traditional auditing is desupported, starting in Oracle Database 23ai. Oracle recommends that you use unified auditing instead.

28.2 Why Is Auditing Used?

You typically use auditing to monitor user activity.

Auditing can be used to accomplish the following:

- **Enable accountability for actions.** These include actions taken in a particular schema, table, or row, or affecting specific content.
- **Deter users (or others, such as intruders) from inappropriate actions based on their accountability.**
- **Investigate suspicious activity.** For example, if a user is deleting data from tables, then a security administrator can audit all connections to the database and all successful and unsuccessful deletions of rows from all tables in the database.
- **Notify an auditor of the actions of an unauthorized user.** For example, an unauthorized user could be changing or deleting data, or the user has more privileges than expected, which can lead to reassessing user authorizations.
- **Support post-incident investigations.**
- **Monitor and gather data about specific database activities.** For example, the database administrator can gather statistics about which tables are being updated, how many logical I/Os are performed, or how many concurrent users connect at peak times.
- **Detect problems with an authorization or access control implementation.** For example, you can create audit policies that you expect will never generate an audit record because the data is protected in other ways. However, if these policies generate audit records, then you will know the other security controls are not properly implemented.

- **Address auditing requirements for compliance.** Regulations such as the following have common auditing-related requirements:
 - Sarbanes-Oxley Act
 - Health Insurance Portability and Accountability Act (HIPAA)
 - International Convergence of Capital Measurement and Capital Standards: a Revised Framework (Basel II)
 - Japan Privacy Law
 - European Union Directive on Privacy and Electronic Communications

Oracle recommends that you audit your databases. Auditing is an effective method of enforcing strong internal controls so that your site can meet its regulatory compliance requirements. This enables you to monitor business operations, and find abnormal access patterns.

Auditing can not only monitor the database activity of database users, but also nondatabase users. "Nondatabase users" refers to the typical application service accounts and they are identified in the database using the `CLIENT_IDENTIFIER` attribute. To audit this type of user, you can use either unified audit or fine-grained audit policy, or Oracle Database Real Application Security.

28.3 Best Practices for Auditing

You should follow best practices guidelines for auditing.

- **As a general rule, design your auditing strategy to collect the amount of information that you need to meet compliance requirements, but focus on activities that cause the greatest security concerns.** For example, auditing every table in the database is not practical, but auditing tables with columns that contain sensitive data, such as salaries, is. With both unified and fine-grained auditing, there are mechanisms you can use to design audit policies that focus on specific activities to audit.
- **Periodically archive and purge the audit trail data.** You can use the `DBMS_AUDIT_MGMT` package to purge audit records in several different ways. You should regularly review the collected audit records and establish a system for collecting and retaining audit records based on your site's retention policies. In addition to `DBMS_AUDIT_MGMT`, Oracle Data Safe and Oracle Audit Vault and Database Firewall provide features that enable you manage the archiving and purging of audit trail data.
- **Oracle recommends that you configure a different tablespace for the unified audit trail.** You can use the `DBMS_AUDIT_MGMT.SET_AUDIT_TRAIL_LOCATION` procedure. Take note of the fact that for Oracle Database Standard Edition and Express Edition, you can only associate the tablespace for unified auditing once. You should perform this association before you generate any audit records for the unified audit trail. After you have associated the tablespace, you cannot modify it because partitioning is only supported on Oracle Database Enterprise Edition. This limitation does not exist for Enterprise Edition.

Related Topics

- [Guidelines for Auditing](#)
Oracle provides guidelines for auditing.
- [Purging Audit Trail Records](#)
The `DBMS_AUDIT_MGMT` PL/SQL package can schedule automatic purge jobs, manually purge audit records, and perform other audit trail operations.
- [Oracle Database PL/SQL Packages and Types Reference](#)

28.4 Unified Auditing and Its Benefits

Unified auditing was introduced in Oracle Database 12c with significant enhancements to auditing functionality.

Unified auditing enables you to capture audit records from the following sources, and writes the audit records into a **single consolidated unified audit trail**:

- Audit records (including `SYS` audit records) from unified audit policies and `AUDIT` settings
- Fine-grained audit records from the `DBMS_FGA` PL/SQL package
- Oracle Database Real Application Security audit records
- Oracle Recovery Manager audit records
- Oracle Database Vault audit records
- Oracle Label Security audit records
- Oracle Machine Learning for SQL records
- Oracle Data Pump
- Oracle SQL*Loader Direct Load
- Oracle XML DB HTTP and FTP protocol messages

The unified audit trail, which resides in a read-only table in the `AUDSYS` schema in the `SYSAUX` tablespace, makes this information available in a uniform format in the `UNIFIED_AUDIT_TRAIL` data dictionary view, and is available in both multitenant and Oracle Database Real Application Clusters environments. The unified audit trail also normalizes the audit record format, using standardized column names and data types across all audit sources. The consolidated, normalized unified audit trail simplifies collection, analysis, and management of audit records generated by different audit sources. Consistent formatting simplifies reporting and analysis of the audit data.

Unified auditing offers a **high degree of integrity of audit trail** by not allowing users to tamper with the audit trail. The unified audit trail is stored in the `AUDSYS` schema and no one is allowed to log in to that schema in the database. `AUD$UNIFIED` is a specialized table which allows only `INSERT` activity. Any attempt to directly truncate, delete or update contents of the `AUD$UNIFIED` table fail, and will generate audit records. You can use the built-in audit data management `DBMS_AUDIT_MGMT` package to manage audit data. Additionally, you can encrypt the audit tablespace with Transparent Data Encryption (TDE). You can protect the unified audit table with an Oracle Database Vault realm.

With unified auditing, **audit configuration is much simpler and focused for your needs**. You can create named audit policies once and enforce them in multiple dimensions (for example, on users and roles), giving you a lot more flexibility and simplicity. You can selectively audit to capture relevant activity with unified audit. Audit conditions can be based on application contexts, session contexts, and built-in functions. The `ONLY TOPLEVEL` clause of the `CREATE AUDIT POLICY` statement helps audit only the SQL statements that are directly issued by an end user, thus focusing only on end-user-initiated actions on sensitive tables. Such configuration flexibility in unified audit helps fine-tune audit policies to collect audit data that is targeted to your needs.

Unified auditing provides different roles for separation of duties to manage and view the audit data: `AUDIT_ADMIN` and `AUDIT_VIEWER`.

For typical use cases of auditing privileged users or auditing key database operations with unified auditing, **the performance impact is so low** that it cannot even be measured due to

low audit volume spread throughout the week. You could begin to see performance impact of 1 percent when the audit load increases to a few hundred audit events per second. For most use cases, you are not going to see overhead beyond this, but for cases where organizations want to audit application usage, it is best to tune the audit policies. Internal performance tests using a TPC-C mixed application workload show that with unified audit, you may see a CPU overhead in mid-single digit when auditing up to 360,000 audit records/hour. For extreme audit loads up to 1,800,000 audit records per hour, the additional overhead is still in a single digit.

 **Note:**

1. When the database is writeable, audit records are written to the unified audit trail. If the database is not writable (typically occurs when the database is closed or is read-only as in Oracle Data Guard ADG), the Oracle Database writes audit records to external operating system spillover `.BIN` files in the `$ORACLE_BASE/audit/$ORACLE_SID` directory. The audit data present in the `.BIN` files is also surfaced in the `UNIFIED_AUDIT_TRAIL` data dictionary view.

Related Topics

- [Oracle Database Reference](#)

28.5 Who Can Perform Auditing?

Oracle provides two roles for users who perform auditing: `AUDIT_ADMIN` and `AUDIT_VIEWER`, to enable separation of duties.

The privileges that these roles provide are as follows:

- **AUDIT_ADMIN role.** This role enables you to create unified and fine-grained audit policies; enable, disable or drop the created unified audit and fine-grained audit policies; view audit data; and manage the audit trail administration. This role also enables you to change audit policies or modify the audit trail (including purging old audit data). Grant this role only to trusted users. Note that user `SYS` has this role.

The list of privileges `AUDIT_ADMIN` provides is as follows:

- `NOAUDIT` statement *
- `AUDIT POLICY` statement
- `NOAUDIT POLICY` statements
- `CREATE AUDIT POLICY` statement
- `ALTER AUDIT POLICY` statement
- `DROP AUDIT POLICY` statement
- `DBMS_FGA` PL/SQL package execution
- `DBMS_AUDIT_MGMT` PL/SQL package execution
- Selecting the following audit trail tables and views:
 - * `SYS.AUD$` table *
 - * `SYS.USER_AUDIT_TRAIL` data dictionary view *
 - * `SYS.CDB_AUDIT_TRAIL` data dictionary view *

- * SYS.FGA_LOG\$ table *
- * SYS.DBA_FGA_AUDIT_TRAIL data dictionary view *
- * SYS.CDB_FGA_AUDIT_TRAIL data dictionary view *
- * SYS.DBA_COMMON_AUDIT_TRAIL data dictionary view *
- * SYS.CDB_COMMON_AUDIT_TRAIL data dictionary view *
- * SYS.X\$UNIFIED_AUDIT_TRAIL dynamic performance view
- * SYS.V\$UNIFIED_AUDIT_TRAIL dynamic performance view
- * SYS.GV\$UNIFIED_AUDIT_TAIL dynamic performance view
- * AUDSYS.AUD\$UNIFIED
- * AUDSYS.UNIFIED_AUDIT_TRAIL data dictionary view
- * AUDSYS.CDB_UNFLIED_AUDIT_TRAIL data dictionary view
- Ability to change the following system parameters by using the ALTER SYSTEM statement:
 - * AUDIT_FILE_DEST *
 - * AUDIT_TRAIL *
 - * AUDIT_SYS_OPERATIONS *
 - * AUDIT_SYSLOG_LEVEL *
 - * UNIFIED_AUDIT_SYSTEMLOG
 - * UNIFIED_AUDIT_COMMON_SYSTEMLOG
- Ability to change audit policies or modify the audit trail (including purging old audit data)
- **AUDIT_VIEWER role.** This role enables users to view and analyze audit data. It provides the EXECUTE privilege on the DBMS_AUDIT_UTIL PL/SQL package. The kind of user who needs this role is typically an external auditor. An auditor can view audit data after being granted the AUDIT_VIEWER role. If your users only need to query the views but not create audit policies, then grant them the AUDIT_VIEWER role. Note that user SYS has this role.

The list of privileges AUDIT_VIEWER provides is as follows:

- SYS.AUD\$ table *
- SYS.USER_AUDIT_TRAIL data dictionary view *
- SYS.CDB_AUDIT_TRAIL data dictionary view *
- SYS.FGA_LOG\$ table *
- SYS.DBA_FGA_AUDIT_TRAIL data dictionary view *
- SYS.CDB_FGA_AUDIT_TRAIL data dictionary view *
- SYS.DBA_COMMON_AUDIT_TRAIL data dictionary view *
- SYS.CDB_COMMON_AUDIT_TRAIL data dictionary view *
- SYS.X\$UNIFIED_AUDIT_TRAIL dynamic performance view
- SYS.V\$UNIFIED_AUDIT_TRAIL dynamic performance view
- SYS.GV\$UNIFIED_AUDIT_TAIL dynamic performance view

- AUDSYS.AUD\$UNIFIED
- AUDSYS.UNIFIED_AUDIT_TRAIL data dictionary view
- AUDSYS.CDB_UNIFIED_AUDIT_TRAIL data dictionary view

* Deprecated; used in traditional auditing. Traditional auditing is desupported starting in Oracle Database 23ai, but if you still have traditional audit settings, they are accessible.

Related Topics

- [Handling the Desupport of Traditional Auditing](#)
Traditional auditing is desupported, starting in Oracle Database 23ai. Oracle recommends that you use unified auditing instead.

28.6 Handling the Desupport of Traditional Auditing

Traditional auditing is desupported, starting in Oracle Database 23ai. Oracle recommends that you use unified auditing instead.

If you used traditional auditing in previous releases, when you upgrade to Oracle Database 23ai, the existing traditional audit settings will continue to be honored and audit records will continue to be generated into their respective audit trails. However, you cannot create new traditional audit settings or update existing traditional audit settings. You can only delete the existing traditional audit settings.

Oracle strongly recommends that you transition from traditional audit configurations to unified audit policies as soon as possible. In most cases, the transition is simple. Oracle Database has always-on mandatory audits to ensure security-sensitive database activities are always audited. Oracle Database also provides a set of predefined unified audit policies to help you get started. If you have upgraded your Oracle database installation from release 11g, then at a minimum, you should enable the following predefined policies, which address the most common security and compliance needs

- Secure configuration audit options (ORA_SECURECONFIG), such as audits of the ALTER ANY TABLE system privilege
- Logon and logoff failures (ORA_LOGIN_LOGOUT)

All new Oracle databases, created from release 12.2 and later, have the ORA_SECURECONFIG pre-defined unified audit policy enabled by default. Starting in release 23ai, the ORA_LOGIN_LOGOUT pre-defined unified audit policy is available and enabled by default. During database upgrades, these predefined unified audit policies are not enabled.

If you have highly customized traditional audit settings, then you have the following choices to transition them to unified audit policies:

- Create custom unified audit policies by using the rich features of unified audit to make your audit policies more conditional, selective, and focused. For example, you can create policies that audit actions on tables or databases, audit application context values, and filter the audit results to show only top level activities. You can create conditions to further filter the unified audit results. You can also create policies that are specific to many other Oracle features, such as SQL Firewall, Oracle Database Vault, Oracle Label Security, and so on.
- If you are unfamiliar with the syntax that is involved in creating unified audit policies, then use the syntax converter script that is available in My Oracle Support note [2909718.1](#). This creates .sql scripts to convert your current traditional audit configuration settings into syntactically correct unified audit policies. After you have completed the conversion, Oracle strongly recommends that you examine the policies and incorporate the various features of

unified auditing, such as creating conditions or auditing application context values, before you enable your policies.

After you have completed converting your traditional audit settings to unified audit policies, then carefully examine this generated script before you execute it to enable the unified audit policies and remove the existing traditional audit configurations.

For additional information about unified audit best practices, see the Oracle technical report [Oracle Database Unified Audit: Best Practice Guidelines](#).

 **Note:**

Unified auditing does not depend on the initialization parameters that were used by traditional auditing. See the Feature column in [Considerations for Transitioning from Traditional to Unified Auditing](#) for a list of these initialization parameters.

Related Topics

- [Auditing Activities with the Predefined Unified Audit Policies](#)
Oracle Database provides predefined unified audit policies that cover commonly used security-relevant audit settings.
- [Creating Custom Unified Audit Policies](#)
Oracle Database provides the flexibility to create and manage custom unified audit policies for your specialized needs.
- [Syntax for Creating a Custom Unified Audit Policy](#)
To create a custom unified audit policy, you must use the `CREATE AUDIT POLICY` statement.
- [Syntax for Creating a Custom Unified Audit Policy](#)
To create a custom unified audit policy, you must use the `CREATE AUDIT POLICY` statement.

28.7 Unified Auditing in a Multitenant Environment

You can apply audit settings to individual PDBs or to the CDB, depending on the type of policy.

Each PDB, including the root, has its own unified audit trail.

- **Unified audit policies created with the `CREATE AUDIT POLICY` and `AUDIT` statements:** You can create policies for both the root and individual PDBs.
- **Audit records written to the syslog:** On UNIX platforms, you can set the `UNIFIED_AUDIT_COMMON_SYSTEMLOG` initialization parameter in the CDB root to enable certain unified audit trail columns to be written to SYSLOG. On both Windows and UNIX, you can set the `UNIFIED_AUDIT_SYSTEMLOG` parameter in both the root and PDB level.
- **Fine-grained audit policies:** You can create policies for individual PDBs only, not the root.
- **Purging the audit trail:** You can perform purge operations for both the root and individual PDBs.

Related Topics

- [Auditing in a Multitenant Deployment](#)
You can create unified audit policies for individual PDBs and in the root.
- [Enabling SYSLOG and Windows Event Viewer Captures for the Unified Audit Trail](#)
You can write a subset of unified audit trail records to the UNIX SYSLOG or to the Windows Event Viewer.

- [Creating Fine-Grained Audit Policies](#)
The `DBMS_FGA.ADD_POLICY` procedure creates a fine-grained audit policy.
- [Purging Audit Trail Records](#)
The `DBMS_AUDIT_MGMT` PL/SQL package can schedule automatic purge jobs, manually purge audit records, and perform other audit trail operations.

28.8 Auditing in a Distributed Database

Auditing is site autonomous in that a database instance audits only the statements issued by directly connected users.

A local Oracle Database node cannot audit actions that take place in a remote database.

Provisioning Audit Policies

Oracle Database provides a variety of ways for you to audit activities.

- [Getting Started with Auditing](#)
Effective auditing requires that audit policies be selective and focused. This ensures that the audit records generated are what is needed to support forensic analysis, and compliance, without generating unnecessary audit records.
- [About Audit Policies](#)
An audit policy is a named group of audit settings that enable you to audit a particular aspect of user behavior in the database.
- [Activities That Are Mandatorily Audited](#)
Certain security sensitive database activities are always audited and such audit configurations cannot be disabled.
- [Auditing Activities with the Predefined Unified Audit Policies](#)
Oracle Database provides predefined unified audit policies that cover commonly used security-relevant audit settings.
- [Steps to Provision Unified Audit Policies](#)
Apart from mandatorily audited activities and predefined unified audit policies enabled by default in the Oracle database, you may need to provision additional unified audit policies based on your security and compliance needs.
- [Common Audit Configurations Across All PDBs](#)
A common audit configuration is visible and enforced across all PDBs.
- [General Audit Data Dictionary Views](#)
Oracle Database provides different types of data dictionary and dynamic views for use with unified auditing.

29.1 Getting Started with Auditing

Effective auditing requires that audit policies be selective and focused. This ensures that the audit records generated are what is needed to support forensic analysis, and compliance, without generating unnecessary audit records.

The most common activities to audit includes but are not limited to the following

- Failed logins
- Any login from outside of the application or monitoring tools
- Data Definition Language – creating, dropping, or changing database objects
- Data Control Language – especially create user, alter user, privilege and role grants
- Oracle Data Pump import operations
- Any Oracle Database Vault activity or rule violation
- Any `SYSDBA` or database administrator activity

The top three tips to get started on auditing activities with Oracle Database with unified auditing are as follows:

1. Do not duplicate mandatory audit configurations which are always on in the Oracle database.
2. Use the predefined unified audit policies provided in Oracle Database, Oracle Data Safe, or Oracle Audit Vault and Database Firewall (AVDF).
3. Create custom audit policies (unified audit or fine-grained) for specialized needs.

You can fine-tune unified audit policies with conditions and enforced on specific users to reduce audit volume. You may want to use conditional enablement features for use cases, such as the following:

- Monitor access to sensitive data outside the trusted application path to focus only on the activity that matters.
- Monitor any activity from ad-hoc or power users who typically have access to query the data outside the trusted application paths.

Related Topics

- [Guidelines for Auditing](#)
Oracle provides guidelines for auditing.

29.2 About Audit Policies

An audit policy is a named group of audit settings that enable you to audit a particular aspect of user behavior in the database.

You can create audit policies that monitor a wide range of activities, such as the following:

- User accounts (including administrative users who log in with the `SYSDBA` administrative privilege), roles, and privileges
- Object actions, such as dropping a table or a running a procedure
- Application context values
- Activities from other Oracle Database products, such as Oracle Database Real Application Security, Oracle Recovery Manager, or Oracle Data Pump.

Oracle Database provides three ways for you to create audit policies:

- **Use predefined unified audit policies for auditing the most common security relevant activities.** The predefined audit policies enable you to follow certain industry standards, such as the Center for Internet Security Recommendations or the Security Technical Implementation Guide standards. Predefined policies are also available for common audit tasks such as failed logins, and for other Oracle products, such as Oracle Database Real Application Security and Oracle Database Vault. The predefined audit policies should be sufficient for most auditing needs, but if they are not, then you can create custom audit policies or fine-grained audit policies.
- **Create custom unified audit policies for more specific activities.** Custom unified audit policies enable you to audit a wide range of activities, such as auditing the use of roles or actions performed on objects like tables. You use the `CREATE AUDIT POLICY` statement to create the unified audit policy, and the `AUDIT` statement to enable it. The `CREATE AUDIT POLICY` syntax is flexible enough for you to build in conditions, for example, or audit application context values.
- **Create fine-grained audit policies for more granular audit needs.** Fine-grained audit policies are not unified audit policies; you use the `DBMS_FGA` PL/SQL package to create a fine-grained audit policy. Fine-grained audit policies enable you to include conditions and event handlers. For example, you can send alerts to an administrator if a user violates the

audit policy. You can also audit specific rows of a table based on the value in a certain column with fine-grained audit.

29.3 Activities That Are Mandatorily Audited

Certain security sensitive database activities are always audited and such audit configurations cannot be disabled.

Activities that are always audited include but are not limited to the following:

- Activities of administrative users such as `SYSDBA`, `SYSBACKUP`, and `SYSKM` when the database is down is always audited.
- Any DDL or DML attempts on `UNIFIED_AUDIT_TRAIL` or the underlying dictionary tables in `AUDSYS` schema is always audited. These operations are not permitted by design. The unified audit trail resides in a read-only table in the `AUDSYS` schema.

Mandatorily audited activities will have audit policy by name `ORA$MANDATORY` in the `UNIFIED_AUDIT_POLICIES` column of the `UNIFIED_AUDIT_TRAIL` data dictionary view. The `ORA$MANDATORY` is always listed first in this column, if there are other unified audit policies that are tracking mandatorily audited activities. The `SYSTEM_PRIVILEGE_USED` column shows the type of administrative privilege that was used for the activity.

The following activities are mandatorily audited in Oracle Database:

Non-Audit-Related Activities

- SQL Firewall administrative actions
- `ORADEBUG` utility

Audit-Related Activities

- `CREATE AUDIT POLICY`
- `ALTER AUDIT POLICY`
- `DROP AUDIT POLICY`
- `AUDIT`
- `NOAUDIT`
- `EXECUTE` of the `DBMS_FGA` PL/SQL package
- `EXECUTE` of the `DBMS_AUDIT_MGMT` PL/SQL package
- `ALTER TABLE` attempts on the `AUDSYS` audit trail table (remember that this table cannot be altered)
- Top level statements by the administrative users `SYS`, `SYSDBA`, `SYSOPER`, `SYSASM`, `SYSBACKUP`, `SYSDBG`, and `SYSKM`, until the database opens.
- All user-issued DML statements on the `SYS.AUD$` and `SYS.FGA_LOG$` dictionary tables
- Any attempts to modify the data or metadata of the unified audit internal table. `SELECT` statements on this table are not audited by default or mandatorily.
- All configuration changes that are made to Oracle Database Vault

Mandatorily Audited Access to Sensitive Columns in the Oracle Optimizer Dictionary Tables

Be aware that internal access to these table columns by the `DBMS_STATS` package does not generate mandatory audit records. You can use the `ORA$DICTIONARY_SENS_COL_ACCESS` predefined audit policy to audit these tables. The optimizer dictionary tables are as follows:

Optimizer Dictionary Table	Columns
<code>SYS.HIST_HEAD\$</code>	minimum, maximum, lowval, hival
<code>SYS.HISTGRM\$</code>	endpoint, epvalue_raw
<code>SYS.WRI\$OPSTAT_HISTGRM_HISTORY</code>	endpoint, epvalue_raw
<code>SYS.WRI\$OPTSTAT_HISTHEAD_HISTORY</code>	minimum, maximum, lowval, hival

Mandatorily Audited Operations on Blockchain and Immutable Tables

- `CREATE TABLE`
- `DROP TABLE`
- Failed `ALTER TABLE` operations
- Failed `DELETE` operations
- Failed `FLASHBACK TABLE` operations
- Failed `RENAME` operations
- Failed `TRUNCATE TABLE` operations
- Failed `UPDATE` operations

Related Topics

- [Auditing Administrative Users](#)
You can create unified audit policies to capture the actions of administrative user accounts, such as `SYS`.
- [ORA_DICTIONARY Sensitive Column Queries Predefined Unified Audit Policy](#)
The `ORA$DICTIONARY_SENS_COL_ACCESS` predefined audit policy audits the sensitive columns in the Oracle Optimizer dictionary tables.

29.4 Auditing Activities with the Predefined Unified Audit Policies

Oracle Database provides predefined unified audit policies that cover commonly used security-relevant audit settings.

- [About Auditing Activities with the Predefined Unified Audit Policies](#)
Oracle Database has a set of predefined unified audit policies that address most auditing needs.
- [Secure Options Predefined Unified Audit Policy](#)
The `ORA_SECURECONFIG` unified audit policy provides audit options using Oracle Database security best practices.
- [Oracle Database Parameter Changes Predefined Unified Audit Policy](#)
The `ORA_DATABASE_PARAMETER` policy audits commonly used Oracle Database parameter modification commands.

- [User Account and Privilege Management Predefined Unified Audit Policy](#)
The `ORA_ACCOUNT_MGMT` policy audits commonly used user account and privilege settings.
- [Center for Internet Security Recommendations Predefined Unified Audit Policy](#)
The `ORA_CIS_RECOMMENDATIONS` policy performs audits that the Center for Internet Security (CIS) recommends.
- [Security Technical Implementation Guide Predefined Unified Audit Policies](#)
You can use predefined unified audit policies to implement Security Technical Implementation Guide (STIG) audit requirements.
- [ORA_DICTIONARY Sensitive Column Queries Predefined Unified Audit Policy](#)
The `ORA$DICTIONARY_SENS_COL_ACCESS` predefined audit policy audits the sensitive columns in the Oracle Optimizer dictionary tables.
- [Oracle Database Real Application Security Predefined Audit Policies](#)
You can use predefined unified audit policies for Oracle Database Real Application Security events.
- [Oracle Database Vault Predefined Unified Audit Policy for DVSYS and LBACSYS Schemas](#)
The `ORA_DV_SCHEMA_CHANGES` (previously called `ORA_DV_AUDPOL`) predefined unified audit policy audits Oracle Database Vault `DVSYS` and `LBACSYS` schema objects.
- [Oracle Database Vault Predefined Unified Audit Policy for Default Realms and Command Rules](#)
The `ORA_DV_DEFAULT_PROTECTION` (previously called `ORA_DV_AUDPOL2`) predefined unified audit policy audits the Oracle Database Vault default realms and command rules.
- [Oracle Label Security Predefined Unified Audit Policy for LBACSYS Objects](#)
The `ORA_OLS_SCHEMA_CHANGES` predefined unified audit policy audits objects that are owned by the Oracle Label Security `LBACSYS` user.

Related Topics

- [Auditing Most Commonly Used Security-Relevant Activities](#)
Oracle Database provides a set of predefined unified audit policies that you can choose from for the most common security-relevant activities.

29.4.1 About Auditing Activities with the Predefined Unified Audit Policies

Oracle Database has a set of predefined unified audit policies that address most auditing needs.

These audit policies address common scenarios such as capturing login failures and secure options and requirements by the Security Internet Implementation Guide and the Center for Internet Security Recommendations.

You might see certain predefined audit policies that have already been enabled by default in your database. You can see the list of enabled audit policies by querying the `AUDIT_UNIFIED_ENABLED_POLICIES` data dictionary view. You can enable predefined audit policies by using the `AUDIT PL/SQL` statement.

To find the latest list of Oracle-supplied predefined unified audit policies, query the `AUDIT_UNIFIED_POLICIES` data dictionary view as follows:

```
SELECT DISTINCT POLICY_NAME FROM AUDIT_UNIFIED_POLICIES WHERE ORACLE_SUPPLIED = 'YES';
```

If you are using Oracle Data Safe or Oracle Audit Vault and Database Firewall (AVDF) to monitor the database activity across your enterprise, these products also offer a number of predefined audit policies in addition to the ones provided in the Oracle Database. You can provision these policies with a single click.

Related Topics

- [Enabling and Applying Unified Audit Policies to Users and Roles](#)
You can use the `AUDIT POLICY` statement to enable and apply unified audit policies to users and roles.
- [Creating Custom Unified Audit Policies](#)
Oracle Database provides the flexibility to create and manage custom unified audit policies for your specialized needs.
- [Value-Based Auditing with Fine-Grained Audit Policies](#)
Fine-grained auditing enables you to perform value-based auditing to audit access to certain rows based on values in specific columns.
- [Oracle Data Safe](#)
- [Oracle Audit Vault and Database Firewall](#)

29.4.2 Secure Options Predefined Unified Audit Policy

The `ORA_SECURECONFIG` unified audit policy provides audit options using Oracle Database security best practices.

For new databases, this policy is enabled by default for both pure unified auditing and mixed-mode auditing environments. This policy is not enabled for databases that were upgraded from earlier versions, except if you have created a new database from the previous release and then upgrade it to the current release.



Note:

Only user `SYS` can alter or drop this predefined policy.

The following statement shows the `ORA_SECURECONFIG` unified audit policy definition.

```
PRIVILEGES ALTER ANY TABLE, CREATE ANY TABLE, DROP ANY TABLE,
          CREATE ANY PROCEDURE, DROP ANY PROCEDURE, ALTER ANY PROCEDURE,
          GRANT ANY PRIVILEGE, GRANT ANY OBJECT PRIVILEGE, GRANT ANY ROLE,
          AUDIT SYSTEM, CREATE EXTERNAL JOB, CREATE ANY JOB,
          CREATE ANY LIBRARY,
          EXEMPT ACCESS POLICY,
          CREATE USER, DROP USER,
          ALTER DATABASE, ALTER SYSTEM,
          CREATE PUBLIC SYNONYM, DROP PUBLIC SYNONYM,
          CREATE SQL TRANSLATION PROFILE, CREATE ANY SQL TRANSLATION
PROFILE,
          DROP ANY SQL TRANSLATION PROFILE, ALTER ANY SQL TRANSLATION
PROFILE,
          TRANSLATE ANY SQL,
          EXEMPT REDACTION POLICY,
          PURGE DBA_RECYCLEBIN, LOGMINING,
          ADMINISTER KEY MANAGEMENT, BECOME USER,
```

```

ADMINISTER FINE GRAINED AUDIT POLICY,
ADMINISTER REDACTION POLICY,
ADMINISTER ROW LEVEL SECURITY POLICY,
GRANT ANY SCHEMA PRIVILEGE,
CREATE ANY DOMAIN, ALTER ANY DOMAIN,
DROP ANY DOMAIN,
CREATE ANY MLE, ALTER ANY MLE, DROP ANY MLE,
ADMINISTER SQL FIREWALL
ACTIONS ALTER USER, CREATE ROLE, ALTER ROLE, DROP ROLE,
SET ROLE, CREATE PROFILE, ALTER PROFILE,
DROP PROFILE, CREATE DATABASE LINK,
ALTER DATABASE LINK, DROP DATABASE LINK,
CREATE DIRECTORY, DROP DIRECTORY,
CREATE PLUGGABLE DATABASE,
DROP PLUGGABLE DATABASE,
ALTER PLUGGABLE DATABASE,
ALTER DATABASE DICTIONARY,
EXECUTE ON REMOTE_SCHEDULER_AGENT.ADD_AGENT_CERTIFICATE;

```

To enable `ORA_SECURECONFIG` audit policy, run the following:

```
AUDIT POLICY ORA_SECURECONFIG;
```

29.4.3 Oracle Database Parameter Changes Predefined Unified Audit Policy

The `ORA_DATABASE_PARAMETER` policy audits commonly used Oracle Database parameter modification commands.



Note:

Only user `SYS` can alter or drop this predefined policy.

The following statement shows the `ORA_DATABASE_PARAMETER` unified audit policy definition. By default, this policy is not enabled.

```
ACTIONS ALTER DATABASE, ALTER SYSTEM, CREATE SPFILE;
```

To enable `ORA_DATABASE_PARAMETER`, run the following command:

```
AUDIT POLICY ORA_DATABASE_PARAMETER;
```

29.4.4 User Account and Privilege Management Predefined Unified Audit Policy

The `ORA_ACCOUNT_MGMT` policy audits commonly used user account and privilege settings.

**Note:**

Only user SYS can alter or drop this predefined policy.

The following statement shows the `ORA_ACCOUNT_MGMT` unified audit policy definition. By default, this policy is not enabled.

```
ACTIONS CREATE USER, ALTER USER, DROP USER, CREATE ROLE, DROP ROLE,  
ALTER ROLE, SET ROLE, GRANT, REVOKE;
```

To enable `ORA_ACCOUNT_MGMT`, run the following command:

```
AUDIT POLICY ORA_ACCOUNT_MGMT;
```

29.4.5 Center for Internet Security Recommendations Predefined Unified Audit Policy

The `ORA_CIS_RECOMMENDATIONS` policy performs audits that the Center for Internet Security (CIS) recommends.

**Note:**

Only user SYS can alter or drop this predefined policy.

The following statement shows the `ORA_CIS_RECOMMENDATIONS` unified audit policy definition. By default, this policy is not enabled.

```
PRIVILEGES SELECT ANY DICTIONARY, ALTER SYSTEM  
ACTIONS CREATE USER, ALTER USER, DROP USER,  
CREATE ROLE, DROP ROLE, ALTER ROLE,  
GRANT, REVOKE, CREATE DATABASE LINK,  
ALTER DATABASE LINK, DROP DATABASE LINK,  
CREATE PROFILE, ALTER PROFILE, DROP PROFILE,  
CREATE SYNONYM, DROP SYNONYM,  
CREATE PROCEDURE, DROP PROCEDURE,  
ALTER PROCEDURE, ALTER SYNONYM, CREATE FUNCTION,  
CREATE PACKAGE, CREATE PACKAGE BODY,  
ALTER FUNCTION, ALTER PACKAGE, ALTER SYSTEM,  
ALTER PACKAGE BODY, DROP FUNCTION,  
DROP PACKAGE, DROP PACKAGE BODY,  
CREATE TRIGGER, ALTER TRIGGER,  
DROP TRIGGER;
```

To enable `ORA_CIS_RECOMMENDATIONS`, run the following command:

```
AUDIT POLICY ORA_CIS_RECOMMENDATIONS;
```

Related Topics

- [Logon and Logout Predefined Unified Audit Policy](#)
The `ORA_LOGIN_LOGOUT` policy (previously called `ORA_LOGON_FAILURES`) tracks logon and logoff operations.

29.4.6 Security Technical Implementation Guide Predefined Unified Audit Policies

You can use predefined unified audit policies to implement Security Technical Implementation Guide (STIG) audit requirements.

- [STIG Recommendations Predefined Unified Audit Policy](#)
The `ORA_STIG_RECOMMENDATIONS` policy performs audits that the Security Technical Implementation Guide (STIG) recommends.
- [All Top Level Actions Predefined Unified Audit Policy](#)
The `ORA_ALL_TOPLEVEL_ACTIONS` policy performs audits of all top level actions of privileged users.
- [Logon and Logout Predefined Unified Audit Policy](#)
The `ORA_LOGIN_LOGOUT` policy (previously called `ORA_LOGON_FAILURES`) tracks logon and logoff operations.

29.4.6.1 STIG Recommendations Predefined Unified Audit Policy

The `ORA_STIG_RECOMMENDATIONS` policy performs audits that the Security Technical Implementation Guide (STIG) recommends.



Note:

Only user `SYS` can alter or drop this predefined policy.

The following statement shows the `ORA_STIG_RECOMMENDATIONS` unified audit policy definition. By default, this policy is not enabled.

```
PRIVILEGES ALTER SESSION
ACTIONS CREATE FUNCTION, ALTER FUNCTION, DROP FUNCTION,
        CREATE PACKAGE, ALTER PACKAGE, DROP PACKAGE,
        CREATE PROCEDURE, ALTER PROCEDURE, DROP PROCEDURE,
        CREATE TRIGGER, ALTER TRIGGER, DROP TRIGGER,
        CREATE PACKAGE BODY, ALTER PACKAGE BODY,
        DROP PACKAGE BODY,
        CREATE TYPE, ALTER TYPE, DROP TYPE,
        CREATE TYPE BODY, ALTER TYPE BODY, DROP TYPE BODY,
        CREATE LIBRARY, ALTER LIBRARY, DROP LIBRARY,
        CREATE JAVA, ALTER JAVA, DROP JAVA,
        CREATE OPERATOR, ALTER OPERATOR, DROP OPERATOR,
        CREATE TABLE, ALTER TABLE, DROP TABLE,
        CREATE VIEW, ALTER VIEW, DROP VIEW,
        CREATE MATERIALIZED VIEW, ALTER MATERIALIZED VIEW,
        DROP MATERIALIZED VIEW,
```



```

CREATE ASSEMBLY, ALTER ASSEMBLY, DROP ASSEMBLY,
CREATE SYNONYM, ALTER SYNONYM, DROP SYNONYM,
CREATE USER, ALTER USER, DROP USER,
GRANT, REVOKE,
CREATE ROLE, ALTER ROLE, DROP ROLE, SET ROLE,
CREATE PROFILE, ALTER PROFILE, DROP PROFILE,
CREATE LOCKDOWN PROFILE, ALTER LOCKDOWN PROFILE,
DROP LOCKDOWN PROFILE,
ALTER SYSTEM, ALTER DATABASE, ALTER PLUGGABLE DATABASE,
CREATE SPFILE, ALTER DATABASE DICTIONARY,
ADMINISTER KEY MANAGEMENT,
EXECUTE ON DBMS_JOB, EXECUTE ON DBMS_RLS,
EXECUTE ON DBMS_REDACT, EXECUTE ON DBMS_TSDP_MANAGE,
EXECUTE ON DBMS_TSDP_PROTECT,
EXECUTE ON DBMS_NETWORK_ACL_ADMIN,
EXECUTE ON DBMS_SCHEDULER
ACTIONS COMPONENT = OLS ALL';

```

For STIG compliance, enable the `ORA_STIG_RECOMMENDATIONS` unified audit policy for all users.

```
AUDIT POLICY ORA_STIG_RECOMMENDATIONS;
```

29.4.6.2 All Top Level Actions Predefined Unified Audit Policy

The `ORA_ALL_TOPLEVEL_ACTIONS` policy performs audits of all top level actions of privileged users.



Note:

Only user `SYS` can alter or drop this predefined policy.

The following statement shows the `ORA_ALL_TOPLEVEL_ACTIONS` unified audit policy definition. By default, this policy is not enabled.

```
ACTIONS ALL ONLY TOPLEVEL;
```

For STIG compliance, enable the `ORA_ALL_TOPLEVEL_ACTIONS` unified audit policy for all Oracle-defined and site specific privileged users. For example, the following statement audits the Oracle-defined privileged user `SYS` and site defined privileged user `SITEADMIN`:

```
AUDIT POLICY ORA_ALL_TOPLEVEL_ACTIONS BY SYS, SITEADMIN;
```

29.4.6.3 Logon and Logout Predefined Unified Audit Policy

The `ORA_LOGIN_LOGOUT` policy (previously called `ORA_LOGON_FAILURES`) tracks logon and logoff operations.

This policy is required for both the Center for Internet Security (CIS) and Security for Technical Implementation Guides (STIG) requirements. For CIS and STIG compliance, you must ensure that the `ORA_LOGIN_LOGOUT` unified audit policy is enabled for all users.

For new databases, this policy is enabled by default. This policy is not enabled for databases that were upgraded from earlier versions. Note that if you have configured a unified audit policy for LOGON statements, then audit records for both direct logins as well as ALTER SESSION and SET CONTAINER statements are generated.

The following statement shows the ORA_LOGIN_LOGOUT unified audit policy definition.

```
ACTIONS LOGON, LOGOFF;
```



Note:

Only user SYS can alter or drop this predefined policy.

```
AUDIT POLICY ORA_LOGIN_LOGOUT WHENEVER NOT SUCCESSFUL;
```

29.4.7 ORA_DICTIONARY Sensitive Column Queries Predefined Unified Audit Policy

The ORA\$DICTIONARY_SENS_COL_ACCESS predefined audit policy audits the sensitive columns in the Oracle Optimizer dictionary tables.

This predefined policy monitors and audits access to sensitive columns in the Oracle Optimizer dictionary tables. When enabled, this policy writes an audit record whenever the sensitive columns in oracle optimizer dictionary tables gets accessed. If disabled, then this policy does not audit access to these tables. If these tables are frequently accessed, then auditing actions can create too many audit records, which causes performance problems.

These tables are as follows:

Optimizer Dictionary Table	Columns
SYS.HIST_HEAD\$	minimum, maximum, lowval, hival
SYS.HISTGRM\$	endpoint, epvalue_raw
SYS.WRI\$_OPTSTAT_HISTHEAD_HISTORY	minimum, maximum, lowval, hival
SYS.WRI\$_OPSTAT_HISTGRM_HISTORY	endpoint, epvalue_raw

This policy cannot be dropped; it can only be enabled or disabled. By default, it is enabled.

29.4.8 Oracle Database Real Application Security Predefined Audit Policies

You can use predefined unified audit policies for Oracle Database Real Application Security events.

- [System Administrator Operations Predefined Unified Audit Policy](#)
 The ORA_RAS_POLICY_MGMT predefined unified audit policy audits policies for all Oracle Real Application Security administrative actions on application users, roles, and policies.
- [Session Operations Predefined Unified Audit Policy](#)
 The ORA_RAS_SESSION_MGMT predefined unified audit policy audits policies for all run-time Oracle Real Application Security session actions and namespace actions.

Related Topics

- [Auditing Oracle Database Real Application Security Events](#)
You can use `CREATE AUDIT POLICY` statement to audit Oracle Database Real Application Security events.

29.4.8.1 System Administrator Operations Predefined Unified Audit Policy

The `ORA_RAS_POLICY_MGMT` predefined unified audit policy audits policies for all Oracle Real Application Security administrative actions on application users, roles, and policies.



Note:

Only user `SYS` can alter or drop this predefined policy.

The following statement describes the `ORA_RAS_POLICY_MGMT` audit policy. By default, this policy is not enabled.

```
ACTIONS COMPONENT=XS
  CREATE USER, UPDATE USER, DELETE USER,
  CREATE ROLE, UPDATE ROLE, DELETE ROLE, GRANT ROLE, REVOKE ROLE,
  ADD PROXY, REMOVE PROXY,
  SET USER PASSWORD, SET USER VERIFIER, SET USER PROFILE,
  CREATE ROLESET, UPDATE ROLESET, DELETE ROLESET,
  CREATE SECURITY CLASS, UPDATE SECURITY CLASS, DELETE SECURITY CLASS,
  CREATE NAMESPACE TEMPLATE, UPDATE NAMESPACE TEMPLATE, DELETE NAMESPACE
  TEMPLATE,
  CREATE ACL, UPDATE ACL, DELETE ACL,
  CREATE DATA SECURITY, UPDATE DATA SECURITY, DELETE DATA SECURITY,
  ENABLE DATA SECURITY, DISABLE DATA SECURITY,
  ADD GLOBAL CALLBACK, DELETE GLOBAL CALLBACK, ENABLE GLOBAL CALLBACK;
```

For STIG compliance, enable the `ORA_RAS_POLICY_MGMT` unified audit policy for all users.

```
AUDIT POLICY ORA_RAS_POLICY_MGMT;
```

29.4.8.2 Session Operations Predefined Unified Audit Policy

The `ORA_RAS_SESSION_MGMT` predefined unified audit policy audits policies for all run-time Oracle Real Application Security session actions and namespace actions.



Note:

Only user `SYS` can alter or drop this predefined policy.

The following statement describes the `ORA_RAS_SESSION_MGMT` policy. By default, this policy is not enabled.

```
CREATE AUDIT POLICY ORA_RAS_SESSION_MGMT
ACTIONS COMPONENT=XS
CREATE SESSION, DESTROY SESSION,
ENABLE ROLE, DISABLE ROLE,
SET COOKIE, SET INACTIVE TIMEOUT,
SWITCH USER, ASSIGN USER,
CREATE SESSION NAMESPACE, DELETE SESSION NAMESPACE,
CREATE NAMESPACE ATTRIBUTE, GET NAMESPACE ATTRIBUTE, SET NAMESPACE
ATTRIBUTE,
DELETE NAMESPACE ATTRIBUTE;
```

For STIG compliance, enable the `ORA_RAS_SESSION_MGMT` for failed operations.

```
AUDIT POLICY ORA_RAS_SESSION_MGMT WHENEVER NOT SUCCESSFUL;
```

29.4.9 Oracle Database Vault Predefined Unified Audit Policy for DVSYS and LBACSYS Schemas

The `ORA_DV_SCHEMA_CHANGES` (previously called `ORA_DV_AUDPOL`) predefined unified audit policy audits Oracle Database Vault `DVSYS` and `LBACSYS` schema objects.

The `ORA_DV_SCHEMA_CHANGES` policy audits all actions that are performed on the Oracle Database Vault `DVSYS` (including `DVF`) schema objects and the Oracle Label Security `LBACSYS` schema objects. It does not capture actions on the `F$*` factor functions in the `DVF` schema. By default, this policy is enabled.



Note:

Only user `SYS` can alter or drop this predefined policy.

To view the complete definition of this policy, query the `AUDIT_UNIFIED_POLICIES` data dictionary view, where `policy_name` is `ORA_DV_SCHEMA_CHANGES`.

Related Topics

- [Auditing Oracle Database Vault Events](#)
In an Oracle Database Vault environment, the `CREATE AUDIT POLICY` statement can audit Database Vault activities.

29.4.10 Oracle Database Vault Predefined Unified Audit Policy for Default Realms and Command Rules

The `ORA_DV_DEFAULT_PROTECTION` (previously called `ORA_DV_AUDPOL2`) predefined unified audit policy audits the Oracle Database Vault default realms and command rules.

The `ORA_DV_DEFAULT_PROTECTION` policy constitutes the audit settings of the Oracle Database Vault-supplied default realms and command rules. By default, this policy is enabled.



Note:

Only user `SYS` can alter or drop this predefined policy.

To view the complete definition of this policy, query the `AUDIT_UNIFIED_POLICIES` data dictionary view, where `policy_name` is `ORA_DV_DEFAULT_PROTECTION`.

Related Topics

- [Auditing Oracle Database Vault Events](#)
In an Oracle Database Vault environment, the `CREATE AUDIT POLICY` statement can audit Database Vault activities.

29.4.11 Oracle Label Security Predefined Unified Audit Policy for LBACSYS Objects

The `ORA_OLS_SCHEMA_CHANGES` predefined unified audit policy audits objects that are owned by the Oracle Label Security `LBACSYS` user.

You can use this audit policy if Oracle Database Vault is not in use. You do not need to enable this policy if the `ORA_DV_SCHEMA_CHANGES` predefined unified audit policy is already enabled. Uninstallation of Oracle Database Vault will drop `ORA_DV_SCHEMA_CHANGES`. To ensure that the `LBACSYS` schema objects are still audited, `ORA_OLS_SCHEMA_CHANGES` will be enabled during uninstallation of Oracle Database Vault if `ORA_DV_SCHEMA_CHANGES` was enabled.



Note:

Only user `SYS` can alter or drop this predefined policy.

To view the complete definition of this policy, query the `AUDIT_UNIFIED_POLICIES` data dictionary view, where `policy_name` is `ORA_OLS_SCHEMA_CHANGES`.

Related Topics

- [Auditing Oracle Label Security Events](#)
In an Oracle Label Security environment, the `CREATE AUDIT POLICY` statement can audit Oracle Label Security activities.

29.5 Steps to Provision Unified Audit Policies

Apart from mandatorily audited activities and predefined unified audit policies enabled by default in the Oracle database, you may need to provision additional unified audit policies based on your security and compliance needs.

- [Auditing Most Commonly Used Security-Relevant Activities](#)
Oracle Database provides a set of predefined unified audit policies that you can choose from for the most common security-relevant activities.

- [Auditing SQL Statements, Privileges, and Other Activities of Interest](#)
You can create custom audit policies to track access to certain objects, actions or use of privileges, or use of Oracle Database components, such as Oracle Label Security. You can conditionally enable them to reduce audit volume.
- [Value-Based Fine-Grained Audit Activities](#)
Use fine-grained auditing if you want to perform value-based auditing to audit access to certain rows based on values in specific columns or if you want to integrate with event handlers within the Oracle database.

29.5.1 Auditing Most Commonly Used Security-Relevant Activities

Oracle Database provides a set of predefined unified audit policies that you can choose from for the most common security-relevant activities.

Follow these steps to enable the predefined unified audit policies:

1. Select from one of the predefined unified audit policies. You can perform the following query to find a list of these policies:

```
SELECT DISTINCT POLICY_NAME FROM AUDIT_UNIFIED_POLICIES WHERE  
ORACLE_SUPPLIED = 'YES';
```

2. Use the `AUDIT` statement to enable the policy and optionally apply (or exclude) the audit settings to one or more users.
3. Query the `UNIFIED_AUDIT_TRAIL` data dictionary view to find the generated audit records.
4. Periodically archive and purge the contents of the audit trail.

Related Topics

- [Auditing Activities with the Predefined Unified Audit Policies](#)
Oracle Database provides predefined unified audit policies that cover commonly used security-relevant audit settings.
- [Enabling and Applying Unified Audit Policies to Users and Roles](#)
You can use the `AUDIT POLICY` statement to enable and apply unified audit policies to users and roles.
- [Purging Audit Trail Records](#)
The `DBMS_AUDIT_MGMT` PL/SQL package can schedule automatic purge jobs, manually purge audit records, and perform other audit trail operations.

29.5.2 Auditing SQL Statements, Privileges, and Other Activities of Interest

You can create custom audit policies to track access to certain objects, actions or use of privileges, or use of Oracle Database components, such as Oracle Label Security. You can conditionally enable them to reduce audit volume.

Follow these steps to create and enable the custom unified audit policies:

1. In most cases, use the `CREATE AUDIT POLICY` statement to create an audit policy. If you must audit application context values, then use the `AUDIT` statement.
2. If you are creating an audit policy, then use the `AUDIT` statement to enable it and optionally apply (or exclude) the audit settings to one or more users, including administrative users who log in with the `SYSDBA` administrative privilege (for example, the `SYS` user).

`AUDIT` also enables you to create an audit record upon an action's success, failure, or both.

3. Query the `UNIFIED_AUDIT_TRAIL` view to find the generated audit records.
4. Periodically archive and purge the contents of the audit trail.

Related Topics

- [Creating Custom Unified Audit Policies](#)
Oracle Database provides the flexibility to create and manage custom unified audit policies for your specialized needs.
- [Configuring Application Context Audit Settings](#)
The `AUDIT` statement with the `CONTEXT` keyword configures auditing for application context values.
- [Unified Audit Policy Data Dictionary Views](#)
You can query data dictionary and dynamic views to find detailed auditing information about custom unified audit policies.
- [Purging Audit Trail Records](#)
The `DBMS_AUDIT_MGMT` PL/SQL package can schedule automatic purge jobs, manually purge audit records, and perform other audit trail operations.

29.5.3 Value-Based Fine-Grained Audit Activities

Use fine-grained auditing if you want to perform value-based auditing to audit access to certain rows based on values in specific columns or if you want to integrate with event handlers within the Oracle database.

Follow these steps to create and enable fine-grained audit policies:

1. Create a fine-grained auditing policy.
2. Use the `DBMS_FGA` PL/SQL package to configure fine-grained auditing policies.
3. Query the `UNIFIED_AUDIT_TRAIL` or `ALL_AUDIT_POLICIES` view to find the generated audit records.
4. Periodically archive and purge the contents of the audit trail.

Related Topics

- [Value-Based Auditing with Fine-Grained Audit Policies](#)
Fine-grained auditing enables you to perform value-based auditing to audit access to certain rows based on values in specific columns.
- [Purging Audit Trail Records](#)
The `DBMS_AUDIT_MGMT` PL/SQL package can schedule automatic purge jobs, manually purge audit records, and perform other audit trail operations.

29.6 Common Audit Configurations Across All PDBs

A common audit configuration is visible and enforced across all PDBs.

Audit configurations are either local or common. The scoping rules that apply to other local or common phenomena, such as users and roles, all apply to audit configurations.



Note:

Audit initialization parameters exist at the CDB level and not in each PDB.

PDBs support the following auditing options:

- Object auditing

Object auditing refers to audit configurations for specific objects. Only common objects can be part of the common audit configuration. A local audit configuration cannot contain common objects.

- Audit policies

Audit policies can be local or common:

- Local audit policies

A local audit policy applies to a single PDB. You can enforce local audit policies for local and common users in this PDB only. Attempts to enforce local audit policies across all containers result in an error.

In all cases, enforcing of a local audit policy is part of the local auditing framework.

- Common audit policies

A common audit policy applies to all containers. When you create a common audit policy, prefix the name with `C##` or `c##` (for example, `c##all_select_pol`). This policy can only contain actions, system privileges, common roles, and common objects. You can apply a common audit policy only to common users. Attempts to enforce a common audit policy for a local user across all containers result in an error.

A common audit configuration is stored in the `SYS` schema of the root. A local audit configuration is stored in the `SYS` schema of the PDB to which it applies.

Audit trails are stored in the `SYS` or `AUDSYS` schemas of the relevant CDB or PDB container. Operating system and XML audit trails for PDBs are stored in subdirectories of the directory specified by the `AUDIT_FILE_DEST` (deprecated) initialization parameter.

29.7 General Audit Data Dictionary Views

Oracle Database provides different types of data dictionary and dynamic views for use with unified auditing.

Table 30-20 lists views that are common to all types of auditing.



Tip:

To find error information about audit policies, check the trace files. The `USER_DUMP_DEST` initialization parameter sets the location of the trace files.

Table 29-1 General Audit Data Dictionary Views

View	Description
<code>AUDIT_UNIFIED_ENABLED_POLICIES</code>	Describes the conditions on which an audit policy is enabled, such as audits for the success or failure of a user's action that is being monitored in a policy
<code>AUDIT_UNIFIED_POLICIES</code>	Describes the action that was intended to be audited by the audit policy
<code>CDB_UNIFIED_AUDIT_TRAIL</code>	Similar to the <code>UNIFIED_AUDIT_TRAIL</code> view, displays the audit records but from all PDBs in a multitenant environment. This view is available only in the CDB root and must be queried from there.

Table 29-1 (Cont.) General Audit Data Dictionary Views

View	Description
UNIFIED_AUDIT_TRAIL	Displays all audit records
V\$OPTION	The <code>PARAMETER</code> column for this view always returns <code>TRUE</code> , which indicates that unified auditing is enabled.
V\$XML_AUDIT_TRAIL	Displays standard, fine-grained, <code>SYS</code> , and mandatory audit records written in XML format files.

Related Topics

- *Oracle Database Reference*

Creating Custom Unified Audit Policies

Oracle Database provides the flexibility to create and manage custom unified audit policies for your specialized needs.

- [About Custom Unified Audit Policies](#)
You can create custom unified audit policies for specialized needs that are typically not met with predefined unified audit policies.
- [Best Practices for Creating Custom Unified Audit Policies](#)
You can optimize the number of enabled policies as a best practice though you can enable multiple policies at a time in the database.
- [Syntax for Creating a Custom Unified Audit Policy](#)
To create a custom unified audit policy, you must use the `CREATE AUDIT POLICY` statement.
- [Auditing Standard Oracle Database Components](#)
You can create unified audit policies to monitor components such as roles, system privileges, administrative users, and actions performed on objects such as tables.
- [Unified Auditing with Configurable Conditions](#)
You can use the `CREATE AUDIT POLICY` statement to create conditions for a unified audit policy.
- [Auditing for Multitier or Multitenant Configurations](#)
You can create unified audit policies using conditions and application contexts, and in multitier and multitenant environments.
- [Extending Unified Auditing to Capture Custom Attributes](#)
You can extend the unified audit trail to capture custom attributes by auditing application context values.
- [Auditing Components of Other Oracle Products and Features](#)
You can create unified audit policies for Oracle products and features such as Oracle Database Vault, Oracle Real Application Security, Oracle Data Pump, and Oracle Machine Learning for SQL events.
- [Managing Unified Audit Policies](#)
After you create a unified audit policy, you must enable it. You can alter disable, and drop unified audit policies.
- [Tutorial: Auditing Nondatabase Users](#)
Auditing nondatabase users who are typical application service accounts is crucial. They are identified in the database using the `CLIENT_IDENTIFIER` attribute.
- [Unified Audit Policy Data Dictionary Views](#)
You can query data dictionary and dynamic views to find detailed auditing information about custom unified audit policies.

30.1 About Custom Unified Audit Policies

You can create custom unified audit policies for specialized needs that are typically not met with predefined unified audit policies.

For example, you may have the following audit requirements:

- Audit access to the database from untrusted database connection paths.
- Audit access to specific sensitive database objects.
- Audit use of certain system privileges.

To create the unified audit policy, you use the `CREATE AUDIT POLICY` statement. The `AUDIT` and `NOAUDIT` SQL statements enable and disable audit policies respectively. The `AUDIT` statement also lets you include or exclude specific users for the policy.

You can have more than one custom unified audit policy effective at any given time. An audit policy can contain both system-wide and object-specific audit options. To find system actions to audit, you can query the `AUDITABLE_SYSTEM_ACTIONS` system table.

30.2 Best Practices for Creating Custom Unified Audit Policies

You can optimize the number of enabled policies as a best practice though you can enable multiple policies at a time in the database.

This optimization has the following benefits:

- It reduces the logon overhead that is associated with loading the audit policy's details into the session's UGA memory. If the enabled policy count is less, then less time is spent in loading the policy information.
- It makes the internal audit check functionality more efficient, which determines whether to generate an audit record for its associated event.
- If you have configured a unified audit policy for `LOGON` statements, then audit records for both direct logins as well as `ALTER SESSION` and `SET CONTAINER` statements are generated.

The unified audit policy syntax is designed to group multiple audit settings in a single policy. Refer to predefined audit policies of Oracle Database to see how multiple audit settings are grouped within one unified audit policy.

Related Topics

- [Auditing Activities with the Predefined Unified Audit Policies](#)
Oracle Database provides predefined unified audit policies that cover commonly used security-relevant audit settings.

30.3 Syntax for Creating a Custom Unified Audit Policy

To create a custom unified audit policy, you must use the `CREATE AUDIT POLICY` statement.

When you create a unified audit policy, Oracle Database stores it in a first class object that is owned by the `SYS` schema, not in the schema of the user who created the policy.

[Example 30-1](#) shows the syntax for the `CREATE AUDIT POLICY` statement.

Example 30-1 Syntax for the CREATE AUDIT POLICY Statement

```
CREATE AUDIT POLICY policy_name
  { {privilege_audit_clause [action_audit_clause ] [role_audit_clause ]}
    | { action_audit_clause [role_audit_clause ] }
    | { role_audit_clause }
  }
  [WHEN audit_condition EVALUATE PER {STATEMENT|SESSION|INSTANCE}]
  [ONLY TOPLEVEL]
  [CONTAINER = {CURRENT | ALL}];
```

In this specification:

- *privilege_audit_clause* describes privilege-related audit options. The detailed syntax for configuring privilege audit options is as follows:

```
privilege_audit_clause := PRIVILEGES privilege1 [, privilege2]
```

- *action_audit_clause* and *standard_actions* describe object action-related audit options. The syntax is as follows:

```
action_audit_clause := {standard_actions | component_actions}
                        [, component_actions ]

standard_actions :=
    ACTIONS action1 [ ON {schema.obj_name
                        | DIRECTORY directory_name
                        | MINING MODEL schema.obj_name
                        }
                    ]
    [, action2 [ ON {schema.obj_name
                    | DIRECTORY directory_name
                    | MINING MODEL schema.obj_name
                    }
                ]
    ]
```

- *component_actions* enables you to create an audit policy for Oracle Label Security, Oracle Database Real Application Security, Oracle Database Vault, Oracle Data Pump, or Oracle SQL*Loader. The syntax is:

```
component_actions :=
    ACTIONS COMPONENT=[OLS|XS] action1 [,action2 ] |
    ACTIONS COMPONENT=DV DV_action ON DV_object_name |
    ACTIONS COMPONENT=DATAPUMP [ EXPORT | IMPORT | ALL ] |
    ACTIONS COMPONENT=DIRECT_LOAD [ LOAD | ALL ] |
    ACTIONS COMPONENT=PROTOCOL [ HTTP | FTP ] |
    ACTIONS COMPONENT=SQL_FIREWALL [SQL VIOLATION | CONTEXT VIOLATION | ALL]
```

- *role_audit_clause* enables you to audit roles. The syntax is:

```
role_audit_clause := ROLES role1 [, role2]
```

- WHEN *audit_condition* EVALUATE PER enables you to specify a function to create a condition for the audit policy and the evaluation frequency. You must include the EVALUATE PER clause with the WHEN condition. The syntax is:

```
WHEN 'audit_condition := function operation value_list'
EVALUATE PER {STATEMENT|SESSION|INSTANCE}
```

- ONLY TOPLEVEL allows users to audit only the top-level operations that are performed for the actions that were configured as part of this audit policy.
- CONTAINER, allows users to audit only the top-level operations that were performed for the actions that were configured as part of this audit policy.

This syntax is designed to audit any of the components listed in the policy. For example, suppose you create the following policy:

```
CREATE AUDIT POLICY table_pol
PRIVILEGES CREATE ANY TABLE, DROP ANY TABLE
ROLES emp_admin, sales_admin;
```

The audit trail will capture SQL statements that require the CREATE ANY TABLE system privilege or the DROP ANY TABLE system privilege or any system privilege directly granted to the role emp_admin or any system privilege directly granted to the role sales_admin.

After you create the policy, you must enable it by using the `AUDIT` statement. Optionally, you can apply the policy to one or more users, exclude one or more users from the policy, and designate whether an audit record is written when the audited action succeeds, fails, or both succeeds or fails.

Related Topics

- [Auditing System Privileges](#)
You can use the `CREATE AUDIT POLICY` statement to audit system privileges.
- [Auditing Object Actions](#)
You can use the `CREATE AUDIT POLICY` statement to audit object actions.
- [Creating Custom Unified Audit Policies](#)
Oracle Database provides the flexibility to create and manage custom unified audit policies for your specialized needs.
- [Auditing Roles](#)
You can use the `CREATE AUDIT POLICY` statement to audit database roles.
- [Unified Auditing with Configurable Conditions](#)
You can use the `CREATE AUDIT POLICY` statement to create conditions for a unified audit policy.
- [Auditing in a Multitenant Deployment](#)
You can create unified audit policies for individual PDBs and in the root.
- [Auditing Only Top-Level Statements](#)
You can audit top-level user-initiated SQL or PL/SQL statements to reduce audit volume.
- [Enabling and Applying Unified Audit Policies to Users and Roles](#)
You can use the `AUDIT POLICY` statement to enable and apply unified audit policies to users and roles.

30.4 Auditing Standard Oracle Database Components

You can create unified audit policies to monitor components such as roles, system privileges, administrative users, and actions performed on objects such as tables.

- [Auditing Roles](#)
You can use the `CREATE AUDIT POLICY` statement to audit database roles.
- [Auditing System Privileges](#)
You can use the `CREATE AUDIT POLICY` statement to audit system privileges.
- [Auditing Administrative Users](#)
You can create unified audit policies to capture the actions of administrative user accounts, such as `SYS`.
- [Auditing Object Actions](#)
You can use the `CREATE AUDIT POLICY` statement to audit object actions.
- [Auditing the `READ ANY TABLE` and `SELECT ANY TABLE` Privileges](#)
The `CREATE AUDIT POLICY` statement can audit the `READ ANY TABLE` and `SELECT ANY TABLE` privileges.
- [Auditing Only Top-Level Statements](#)
You can audit top-level user-initiated SQL or PL/SQL statements to reduce audit volume.

30.4.1 Auditing Roles

You can use the `CREATE AUDIT POLICY` statement to audit database roles.

- [About Role Auditing](#)
Role auditing audits all system privileges that have been assigned directly (or indirectly) to the role if that system privilege is used. This type of auditing does not audit the use of privileges apart from system privileges.
- [Configuring Role Unified Audit Policies](#)
To create a unified audit policy to capture role use, you must include the `ROLES` clause in the `CREATE AUDIT POLICY` statement.
- [Example: Auditing the Predefined Common DBA Role](#)
The `CREATE AUDIT POLICY` statement can audit roles in both the root and in PDBs.

30.4.1.1 About Role Auditing

Role auditing audits all system privileges that have been assigned directly (or indirectly) to the role if that system privilege is used. This type of auditing does not audit the use of privileges apart from system privileges.

You can audit any role, including user-defined roles. If you create a common unified audit policy for roles with the `ROLES` audit option, then you must specify only common roles in the role list. When such a policy is enabled, Oracle Database audits all system privileges that are commonly and directly granted to the common role. The system privileges that are locally granted to the common role will not be audited. To find if a role was commonly granted, query the `DBA_ROLES` data dictionary view. To find if the privileges granted to the role were commonly granted, query the `ROLE_SYS_PRIVS` view.

 **Note:**

Role auditing will audit all the system privileges that are assigned directly (or indirectly) to the role if a user uses that system privilege.

Related Topics

- [Predefined Roles in an Oracle Database Installation](#)
Oracle Database provides a set of predefined roles to help in database administration.

30.4.1.2 Configuring Role Unified Audit Policies

To create a unified audit policy to capture role use, you must include the `ROLES` clause in the `CREATE AUDIT POLICY` statement.

- Use the following syntax to create a unified audit policy that audits roles:

```
CREATE AUDIT POLICY policy_name
  ROLES role1 [, role2];
```

For example:

```
CREATE AUDIT POLICY audit_roles_pol
  ROLES IMP_FULL_DATABASE, EXP_FULL_DATABASE;
```

You can build more complex role unified audit policies, such as those that include conditions. Remember that after you create the policy, you must use the `AUDIT` statement to enable it.

Related Topics

- [Syntax for Creating a Custom Unified Audit Policy](#)
To create a custom unified audit policy, you must use the `CREATE AUDIT POLICY` statement.

30.4.1.3 Example: Auditing the Predefined Common DBA Role

The `CREATE AUDIT POLICY` statement can audit roles in both the root and in PDBs.

The following example shows how to audit a predefined common role `DBA`.

Example 30-2 Auditing the Predefined Common DBA Role

```
CREATE AUDIT POLICY role_dba_audit_pol
ROLES DBA
CONTAINER = ALL;

AUDIT POLICY role_dba_audit_pol;
```

30.4.2 Auditing System Privileges

You can use the `CREATE AUDIT POLICY` statement to audit system privileges.

- [About System Privilege Auditing](#)
System privilege auditing audits activities that successfully use a system privilege, such as `READ ANY TABLE`.
- [System Privileges That Can Be Audited](#)
To find a list of auditable system privileges, you can query the `SYSTEM_PRIVILEGE_MAP` table.
- [System Privileges That Cannot Be Audited](#)
A few system privileges cannot be audited.
- [Configuring a Unified Audit Policy to Capture System Privilege Use](#)
The `PRIVILEGES` clause in the `CREATE AUDIT POLICY` statement audits system privilege use.
- [Example: Auditing a User Who Has ANY Privileges](#)
The `CREATE AUDIT POLICY` statement can audit users for `ANY` privileges.
- [Example: Using a Condition to Audit a System Privilege](#)
The `CREATE AUDIT POLICY` statement can create an audit policy that uses a condition to audit a system privilege.
- [How System Privilege Unified Audit Policies Appear in the Audit Trail](#)
The `UNIFIED_AUDIT_TRAIL` data dictionary view lists system privilege audit events.

30.4.2.1 About System Privilege Auditing

System privilege auditing audits activities that successfully use a system privilege, such as `READ ANY TABLE`.

A single unified audit policy can contain both privilege and action audit options. Do not audit the privilege use of administrative users such as `SYS`. Instead, audit their object actions.

**Note:**

Use privilege analysis in the Oracle database to find the system privileges which are used and unused..

Related Topics

- [Auditing Object Actions](#)
You can use the `CREATE AUDIT POLICY` statement to audit object actions.
- [Performing Privilege Analysis to Identify Privilege Use](#)
Privilege analysis dynamically analyzes the privileges and roles that users use and do not use.

30.4.2.2 System Privileges That Can Be Audited

To find a list of auditable system privileges, you can query the `SYSTEM_PRIVILEGE_MAP` table.

For example:

```
SELECT NAME FROM SYSTEM_PRIVILEGE_MAP;
```

```
NAME
-----
ALTER ANY CUBE BUILD PROCESS
SELECT ANY CUBE BUILD PROCESS
ALTER ANY MEASURE FOLDER
...
```

Similar to action audit options, privilege auditing audits the use of system privileges that have been granted to database users. If you set similar audit options for both SQL statement and privilege auditing, then only a single audit record is generated. For example, if two policies exist, with one auditing `EXECUTE PROCEDURE` specifically on the `HR.PROC` procedure and the second auditing `EXECUTE PROCEDURE` in general (all procedures), then only one audit record is written.

Privilege auditing does not occur if the action is already permitted by the existing owner and object privileges. Privilege auditing is triggered only if the privileges are insufficient, that is, only if what makes the action possible is a system privilege. For example, suppose that user `SCOTT` has been granted the `SELECT ANY TABLE` privilege and `SELECT ANY TABLE` is being audited. If `SCOTT` selects his own table (for example, `SCOTT.EMP`), then the `SELECT ANY TABLE` privilege is not used. Because `SCOTT` performed the `SELECT` statement within his own schema, no audit record is generated. On the other hand, if `SCOTT` selects from another schema (for example, the `HR.EMPLOYEES` table), then an audit record is generated. Because `SCOTT` selected a table outside his own schema, he needed to use the `SELECT ANY TABLE` privilege.

30.4.2.3 System Privileges That Cannot Be Audited

A few system privileges cannot be audited.

These privileges are:

- `INHERIT ANY PRIVILEGE`
- `INHERIT PRIVILEGE`
- `TRANSLATE ANY SQL`

- TRANSLATE SQL

30.4.2.4 Configuring a Unified Audit Policy to Capture System Privilege Use

The `PRIVILEGES` clause in the `CREATE AUDIT POLICY` statement audits system privilege use.

- Use the following syntax to create a unified audit policy that audits privileges:

```
CREATE AUDIT POLICY policy_name
  PRIVILEGES privilege1 [, privilege2];
```

For example:

```
CREATE AUDIT POLICY my_simple_priv_policy
  PRIVILEGES SELECT ANY TABLE, CREATE LIBRARY;
```

You can build more complex privilege unified audit policies, such as those that include conditions. Remember that after you create the policy, you must use the `AUDIT` statement to enable it.

Related Topics

- [Syntax for Creating a Custom Unified Audit Policy](#)
To create a custom unified audit policy, you must use the `CREATE AUDIT POLICY` statement.

30.4.2.5 Example: Auditing a User Who Has ANY Privileges

The `CREATE AUDIT POLICY` statement can audit users for ANY privileges.

[Example 30-3](#) shows how to audit several ANY privileges of the user `HR_MGR`.

Example 30-3 Auditing a User Who Has ANY Privileges

```
CREATE AUDIT POLICY hr_mgr_audit_pol
  PRIVILEGES DROP ANY TABLE, DROP ANY CONTEXT, DROP ANY INDEX, DROP ANY LIBRARY;

AUDIT POLICY hr_mgr_audit_pol BY HR_MGR;
```

30.4.2.6 Example: Using a Condition to Audit a System Privilege

The `CREATE AUDIT POLICY` statement can create an audit policy that uses a condition to audit a system privilege.

[Example 30-4](#) shows how to use a condition to audit privileges that are used by two operating system users, `psmith` and `jrawlins`.

Example 30-4 Using a Condition to Audit a System Privilege

```
CREATE AUDIT POLICY os_users_priv_pol
  PRIVILEGES SELECT ANY TABLE, CREATE LIBRARY
  WHEN 'SYS_CONTEXT ('USERENV', 'OS_USER') IN ('psmith', 'jrawlins')'
  EVALUATE PER SESSION;

AUDIT POLICY os_users_priv_pol;
```

30.4.2.7 How System Privilege Unified Audit Policies Appear in the Audit Trail

The `UNIFIED_AUDIT_TRAIL` data dictionary view lists system privilege audit events.

The following example shows a list of privileges used by the operating system user `psmith`.

```
SELECT SYSTEM_PRIVILEGE_USED FROM UNIFIED_AUDIT_TRAIL
WHERE OS_USERNAME = 'PSMITH' AND UNIFIED_AUDIT_POLICIES = 'OS_USERS_PRIV_POL';

SYSTEM_PRIVILEGE_USED
-----
SELECT ANY TABLE
DROP ANY TABLE
```



Note:

If you have created an audit policy for the `SELECT ANY TABLE` system privilege, whether the user has exercised the `READ` object privilege or the `SELECT` object privilege will affect the actions that the audit trail captures.

Related Topics

- [Auditing the READ ANY TABLE and SELECT ANY TABLE Privileges](#)
The `CREATE AUDIT POLICY` statement can audit the `READ ANY TABLE` and `SELECT ANY TABLE` privileges.

30.4.3 Auditing Administrative Users

You can create unified audit policies to capture the actions of administrative user accounts, such as `SYS`.

- [Administrative User Accounts That Can Be Audited](#)
Oracle Database provides administrative user accounts that are associated with administrative privileges.
- [Configuring a Unified Audit Policy to Capture Administrator Activities](#)
The `CREATE AUDIT POLICY` statement can audit administrative users.
- [Example: Auditing the SYS User](#)
The `CREATE AUDIT POLICY` statement can audit the `SYS` user.

30.4.3.1 Administrative User Accounts That Can Be Audited

Oracle Database provides administrative user accounts that are associated with administrative privileges.

[Table 30-1](#) lists default administrative user accounts and the administrative privileges with which they are typically associated.

Table 30-1 Administrative Users and Administrative Privileges

Administrative User Account	Administrative Privilege
<code>SYS</code>	<code>SYSDBA</code>
<code>PUBLIC</code> ¹	<code>SYSOPER</code>
<code>SYSASM</code>	<code>SYSASM</code>
<code>SYSBACKUP</code>	<code>SYSBACKUP</code>
<code>SYSDG</code>	<code>SYSDG</code>
<code>SYSKM</code>	<code>SYSKM</code>

- ¹ PUBLIC refers to the user PUBLIC, which is the effective user when you log in with the SYSOPER administrative privilege. It does not refer to the PUBLIC role.

Related Topics

- [Activities That Are Mandatorily Audited](#)
Certain security sensitive database activities are always audited and such audit configurations cannot be disabled.

30.4.3.2 Configuring a Unified Audit Policy to Capture Administrator Activities

The `CREATE AUDIT POLICY` statement can audit administrative users.

- To audit administrative users, create a unified audit policy and then apply this policy to the user, the same as you would for non-administrative users. Note that top-level statements by administrative users are mandatorily audited until the database opens.

30.4.3.3 Example: Auditing the SYS User

The `CREATE AUDIT POLICY` statement can audit the SYS user.

[Example 30-5](#) shows how to audit grants of the `DBMS_FGA` PL/SQL package by user SYS.

Example 30-5 Auditing the SYS User

```
CREATE AUDIT POLICY dbms_fga_grants
  ACTIONS GRANT
  ON DBMS_FGA;

AUDIT POLICY dbms_fga_grants BY SYS;
```

30.4.4 Auditing Object Actions

You can use the `CREATE AUDIT POLICY` statement to audit object actions.

- [About Auditing Object Actions](#)
You can audit actions performed on specific objects, such as `UPDATE` statements on the `HR.EMPLOYEES` table.
- [Object Actions That Can Be Audited](#)
Auditing object actions can be broad or focused (for example, auditing all user actions or only a select list of user actions).
- [Guidelines for Column Level Auditing and Virtual Columns](#)
When you create unified audit policies for columns, you should be aware of guidelines for handling virtual columns.
- [Configuring an Object Action Unified Audit Policy](#)
The `ACTIONS` clause in the `CREATE AUDIT POLICY` statement creates a policy that captures object actions.
- [Example: Auditing Actions on SYS Objects](#)
The `CREATE AUDIT POLICY` statement can audit actions on SYS objects.
- [Example: Auditing Multiple Actions on One Object](#)
The `CREATE AUDIT POLICY` statement can audit multiple actions on one object.
- [Example: Auditing GRANT and REVOKE Operations on an Object](#)
The `CREATE AUDIT POLICY` statement can audit `GRANT` and `REVOKE` operations on objects, such as tables.

- [Example: Auditing Both Actions and Privileges on an Object](#)
The `CREATE AUDIT POLICY` statement can audit both actions and privileges on an object, using a single policy.
- [Example: Auditing an Action on a Table Column](#)
The `CREATE AUDIT POLICY` statement can audit actions on table or view columns.
- [Example: Auditing All Actions on a Table](#)
The `CREATE AUDIT POLICY` statement can audit all actions on a table.
- [Example: Auditing All Actions in the Database](#)
The `CREATE AUDIT POLICY` statement can audit all actions in the database.
- [How Object Action Unified Audit Policies Appear in the Audit Trail](#)
The `UNIFIED_AUDIT_TRAIL` data dictionary view lists object action audit events.
- [Auditing Functions, Procedures, Packages, and Triggers](#)
You can audit functions, procedures, PL/SQL packages, and triggers.
- [Auditing of Oracle Virtual Private Database Predicates](#)
The unified audit trail automatically captures the predicates that are used in Oracle Virtual Private Database (VPD) policies.
- [Audit Policies for Oracle Virtual Private Database Policy Functions](#)
Auditing can affect dynamic VPD policies, static VPD policies, and context-sensitive VPD policies.
- [Unified Auditing with Editioned Objects](#)
An audit policy created to audit an action on an editioned object will be applied to all its editions.

30.4.4.1 About Auditing Object Actions

You can audit actions performed on specific objects, such as `UPDATE` statements on the `HR.EMPLOYEES` table.

The audit can include both DDL and DML statements that were used on the object. A single unified audit policy can contain both privilege and action audit options, as well as audit options set for multiple objects.

For tables that contain sensitive information, Oracle recommends that you include the `ACTIONS ALL` clause in the unified audit policy so that the audit record will capture indirect `SELECT` operations.

30.4.4.2 Object Actions That Can Be Audited

Auditing object actions can be broad or focused (for example, auditing all user actions or only a select list of user actions).

[Table 30-2](#) lists the object-level standard database action options. Audit policies for the `SELECT` SQL statement will capture `READ` actions as well as `SELECT` actions.

Table 30-2 Object-Level Standard Database Action Audit Option

Object	SQL Action That Can Be Audited
Directory	AUDIT, GRANT, READ
Function	AUDIT, EXECUTE, GRANT

Table 30-2 (Cont.) Object-Level Standard Database Action Audit Option

Object	SQL Action That Can Be Audited
Java schema objects (source, class, resource)	AUDIT, EXECUTE, GRANT
Library	EXECUTE, GRANT
Materialized views	ALTER, AUDIT, COMMENT, DELETE, INDEX, INSERT, LOCK, SELECT, UPDATE
Mining Model	AUDIT, COMMENT, GRANT, RENAME, SELECT
Object type	ALTER, AUDIT, GRANT
Package	AUDIT, EXECUTE, GRANT
Procedure (including triggers)	AUDIT, EXECUTE, GRANT
Sequence	ALTER, AUDIT, GRANT, SELECT
Table	ALTER, AUDIT, COMMENT, DELETE, FLASHBACK, GRANT, INDEX, INSERT, LOCK, MERGE, RENAME, SELECT, UPDATE
Table or view column	ALL, ALTER, AUDIT, COMMENT, DELETE, GRANT, INDEX, INSERT, SELECT, UPDATE
View	AUDIT, COMMENT, DELETE, FLASHBACK, GRANT, INSERT, LOCK, MERGE, RENAME, SELECT, UPDATE

Related Topics

- [Auditing Functions, Procedures, Packages, and Triggers](#)
You can audit functions, procedures, PL/SQL packages, and triggers.
- [Audit Policies for Oracle Virtual Private Database Policy Functions](#)
Auditing can affect dynamic VPD policies, static VPD policies, and context-sensitive VPD policies.
- [Guidelines for Column Level Auditing and Virtual Columns](#)
When you create unified audit policies for columns, you should be aware of guidelines for handling virtual columns.

30.4.4.3 Guidelines for Column Level Auditing and Virtual Columns

When you create unified audit policies for columns, you should be aware of guidelines for handling virtual columns.

- An audit record is not be generated if an audit policy is defined on a virtual column and the base column is updated, causing an update to the virtual column.

For example, suppose a table has a column `col1` and a virtual column `c_vir`. Depending on the value of `col1`, a column level audit policy defined on `c_vir` for action update will not generate an audit record when `col1` is updated, causing an update to `c_vir`. The same behavior is true for `INSERT` operation.
- If the value of a column is accessed through a virtual column, then an audit record is generated.

For example, suppose a table has a column `col1` and a virtual column `c_vir`. Depending on the value of `col1`, a column level unified audit policy is defined on `col1`. In this case, accessing `c_vir` generates a unified audit record.

30.4.4.4 Configuring an Object Action Unified Audit Policy

The `ACTIONS` clause in the `CREATE AUDIT POLICY` statement creates a policy that captures object actions.

- Use the following syntax to create a unified audit policy that audits object actions:

```
CREATE AUDIT POLICY policy_name
  ACTIONS action1 [, action2 ON object1] [, action3 ON object2];
```

For example:

```
CREATE AUDIT POLICY my_simple_obj_policy
  ACTIONS SELECT ON OE.ORDERS, UPDATE ON HR.EMPLOYEES;
```

Note that you can audit multiple actions on multiple objects, as shown in this example.

You can build complex object action unified audit policies, such as those that include conditions. Remember that after you create the policy, you must use the `AUDIT` statement to enable it.

Related Topics

- [Syntax for Creating a Custom Unified Audit Policy](#)
To create a custom unified audit policy, you must use the `CREATE AUDIT POLICY` statement.

30.4.4.5 Example: Auditing Actions on SYS Objects

The `CREATE AUDIT POLICY` statement can audit actions on `SYS` objects.

[Example 30-6](#) shows how to create an audit policy that audits `SELECT` statements on the `SYS.USER$` system table. The audit policy applies to all users, including `SYS` and `SYSTEM`.

Example 30-6 Auditing Actions on SYS Objects

```
CREATE AUDIT POLICY select_user_dictionary_table_pol ACTIONS SELECT ON SYS.USER$;
AUDIT POLICY select_user_dictionary_table_pol;
```

30.4.4.6 Example: Auditing Multiple Actions on One Object

The `CREATE AUDIT POLICY` statement can audit multiple actions on one object.

[Example 30-7](#) shows how to audit multiple SQL statements performed by users `jrandolph` and `phawkins` on the `app_lib` library.

Example 30-7 Auditing Multiple Actions on One Object

```
CREATE AUDIT POLICY actions_on_hr_emp_poll
  ACTIONS EXECUTE, GRANT
  ON app_lib;
AUDIT POLICY actions_on_hr_emp_poll BY jrandolph, phawkins;
```

30.4.4.7 Example: Auditing GRANT and REVOKE Operations on an Object

The `CREATE AUDIT POLICY` statement can audit `GRANT` and `REVOKE` operations on objects, such as tables.

Enabling auditing on GRANT operations on an object automatically enables the audit of REVOKE operations on the object as well.

Example 30-8 Auditing GRANT and REVOKE Operations

```
CREATE AUDIT POLICY grant_revoke_pol
ACTIONS GRANT ON HR.EMPLOYEES;

AUDIT POLICY grant_revoke_pol;
```

The UNIFIED_AUDIT_TRAIL view captures the relevant information for a grant operation as shown in the following query. The grantee name (to whom the privilege is granted) is recorded in the TARGET_USER column.

```
SELECT DBUSERNAME, OBJECT_PRIVILEGES, ACTION_NAME, OBJECT_SCHEMA, OBJECT_NAME,
TARGET_USER
FROM UNIFIED_AUDIT_TRAIL
WHERE ACTION_NAME IN ('GRANT', 'REVOKE');
```

30.4.4.8 Example: Auditing Both Actions and Privileges on an Object

The CREATE AUDIT POLICY statement can audit both actions and privileges on an object, using a single policy.

Example 30-9 shows how all EXECUTE and GRANT statements on the app_lib library using the CREATE LIBRARY privilege are audited.

Example 30-9 Auditing Both Actions and Privileges on an Object

```
CREATE AUDIT POLICY actions_on_hr_emp_pol2
PRIVILEGES CREATE LIBRARY
ACTIONS EXECUTE, GRANT
ON app_lib;

AUDIT POLICY actions_on_hr_emp_pol2 BY jrandolph, phawkins;
```

You can audit directory objects. For example, suppose you create a directory object that contains a preprocessor program that the ORACLE_LOADER access driver will use. You can audit anyone who runs this program within this directory object.

30.4.4.9 Example: Auditing an Action on a Table Column

The CREATE AUDIT POLICY statement can audit actions on table or view columns.

Example 30-10 shows how to create an audit policy that audits SELECT statements on the SALARY column of the HR.EMPLOYEES table.

Example 30-10 Auditing Actions on a Table Column

```
CREATE AUDIT POLICY emp_hr_emp_sal_access_pol
ACTIONS SELECT(SALARY) ON HR.EMPLOYEES;

AUDIT POLICY emp_hr_emp_sal_access_pol;
```

30.4.4.10 Example: Auditing All Actions on a Table

The CREATE AUDIT POLICY statement can audit all actions on a table.

You can use the `ALL` keyword to audit all actions. Oracle recommends that you audit all actions only on sensitive objects. `ALL` is useful in that it captures indirect `SELECT` operations.

[Example 30-11](#) shows how to audit all actions on the `HR.EMPLOYEES` table by user `pmulligan`.

Example 30-11 Auditing All Actions on a Table

```
CREATE AUDIT POLICY all_actions_on_hr_emp_pol
  ACTIONS ALL ON HR.EMPLOYEES;

AUDIT POLICY all_actions_on_hr_emp_pol BY pmulligan;
```

Related Topics

- [Example: Auditing All Actions in the Database](#)
The `CREATE AUDIT POLICY` statement can audit all actions in the database.

30.4.4.11 Example: Auditing All Actions in the Database

The `CREATE AUDIT POLICY` statement can audit all actions in the database.

Ensure that you include the `ONLY TOPLEVEL` clause to audit only the top-level user initiated actions. Consider adding conditions when you use the `ACTIONS ALL` clause to further reduce the audit volume.



Note:

Use `ACTIONS ALL` auditing with caution. Do not enable it for users who must perform online transaction processing (OLTP) workloads. This will avoid generating a large number of audit records.

[Example 30-12](#) shows how to audit all actions in the entire database.

Example 30-12 Auditing All Actions in the Database

```
CREATE AUDIT POLICY all_actions_pol ACTIONS ALL ONLY TOPLEVEL;

AUDIT POLICY all_actions_pol;
```

Related Topics

- [Unified Auditing with Configurable Conditions](#)
You can use the `CREATE AUDIT POLICY` statement to create conditions for a unified audit policy.

30.4.4.12 How Object Action Unified Audit Policies Appear in the Audit Trail

The `UNIFIED_AUDIT_TRAIL` data dictionary view lists object action audit events.

For example:

```
SELECT ACTION_NAME, OBJECT_SCHEMA, OBJECT_NAME FROM UNIFIED_AUDIT_TRAIL
WHERE DBUSERNAME = 'SYS';
```

```
ACTION_NAME OBJECT_SCHEMA OBJECT_NAME
-----
SELECT      HR              EMPLOYEES
```

30.4.4.13 Auditing Functions, Procedures, Packages, and Triggers

You can audit functions, procedures, PL/SQL packages, and triggers.

Points to consider:

- You can individually audit standalone functions, standalone procedures, and PL/SQL packages.
- If you audit a PL/SQL package, Oracle Database audits all functions and procedures within the package.
- If you enable auditing for all executions, Oracle Database audits all triggers in the database, as well as all the functions and procedures within PL/SQL packages.
- You cannot audit individual functions or procedures within a PL/SQL package.
- When you audit the `EXECUTE` operation on a PL/SQL stored procedure or stored function, the database considers only its ability to find the procedure or function and authorize its execution when determining the success or failure of the operation for the purposes of auditing. Therefore, if you specify the `WHENEVER NOT SUCCESSFUL` clause, then only invalid object errors, non-existent object errors, and authorization failures are audited; errors encountered during the execution of the procedure or function are not audited. If you specify the `WHENEVER SUCCESSFUL` clause, then all executions that are not blocked by invalid object errors, non-existent object errors, or authorization failures are audited, regardless of whether errors are encountered during execution.

30.4.4.14 Auditing of Oracle Virtual Private Database Predicates

The unified audit trail automatically captures the predicates that are used in Oracle Virtual Private Database (VPD) policies.

You do not need to create a unified audit policy to capture the VPD predicate audit information.

This type of audit enables you to identify the predicate expression that was run as part of a DML operation and thereby help you to identify other actions that may have occurred as part of the DML operation. For example, if a malicious attack on your database is performed using a VPD predicate, then you can track the attack by using the unified audit trail. In addition to predicates from user-created VPD policies, the internal predicates from Oracle Label Security and Oracle Real Application Security policies are captured as well. For example, Oracle Label Security internally creates a VPD policy while applying an OLS policy to a table. Oracle Real Application Security generates a VPD policy while enabling an Oracle RAS policy.

The unified audit trail writes this predicate information to the `RLS_INFO` column of the `UNIFIED_AUDIT_TRAIL` data dictionary view. If you have fine-grained audit policies, then the `RLS_INFO` column of these views captures VPD predicate information as well.

The audit trail can capture the predicates and their corresponding policy names if multiple VPD policies are enforced on the object. The audit trail captures the policy schema and policy name to enable you to differentiate predicates that are generated from different policies. By default, this information is concatenated in the `RLS_INFO` column, but Oracle Database provides a function in the `DBMS_AUDIT_UTIL` PL/SQL package that enables you to reformat the results in an easy-to-read format.

The following example shows how you can audit the predicates of a VPD policy:

1. Create the following VPD policy function:

```

CREATE OR REPLACE FUNCTION auth_orders(
  schema_var IN VARCHAR2,
  table_var IN VARCHAR2
)
RETURN VARCHAR2
IS
  return_val VARCHAR2 (400);
BEGIN
  return_val := 'SALES_REP_ID = 159';
  RETURN return_val;
END auth_orders;
/

```

2. Create the following VPD policy:

```

BEGIN
  DBMS_RLS.ADD_POLICY (
    object_schema => 'oe',
    object_name => 'orders',
    policy_name => 'orders_policy',
    function_schema => 'sec_admin',
    policy_function => 'auth_orders',
    statement_types => 'select, insert, update, delete'
  );
END;
/

```

3. Create and enable the following the unified audit policy:

```

CREATE AUDIT POLICY oe_pol
  ACTIONS SELECT ON OE.ORDERS;

AUDIT POLICY oe_pol;

```

4. Connect as user OE and query the OE.ORDERS table.

```

CONNECT OE@pdb_name
Enter password: password

SELECT COUNT(*) FROM ORDERS;

```

5. Connect as a user who has been granted the AUDIT_ADMIN role, and then query the UNIFIED_AUDIT_TRAIL data dictionary view.

```

CONNECT sec_admin@pdb_name
Enter password: password

SELECT RLS_INFO FROM UNIFIED_AUDIT_TRAIL;

```

Output similar to the following should appear:

```

((POLICY_TYPE=[3]'VPD'),(POLICY_SCHEMA=[9]'SEC_ADMIN'),
(POLICY_NAME=[13]'ORDERS_POLICY'),(PREDICATE=[16]'SALES_REP_ID=159'));

```

6. To extract these details and add them to their own columns, run the appropriate function from the DBMS_AUDIT_UTIL PL/SQL package.

For unified auditing, you must run the DBMS_AUDIT_UTIL.DECODE_RLS_INFO_ATRAIL_UNI function.

For example:

```

SELECT DBUSERNAME, ACTION_NAME, OBJECT_NAME, SQL_TEXT,
  RLS_PREDICATE, RLS_POLICY_TYPE, RLS_POLICY_OWNER, RLS_POLICY_NAME
FROM TABLE (DBMS_AUDIT_UTIL.DECODE_RLS_INFO_ATRAIL_UNI
  (CURSOR (SELECT * FROM UNIFIED_AUDIT_TRAIL)));

```

The reformatted audit trail output appears similar to the following:

```

DBUSERNAME ACTION_NAME OBJECT_NAME SQL_TEXT
-----
-----
RLS_PREDICATE      RLS_POLICY_TYPE RLS_POLICY_OWNER RLS_POLICY_NAME
-----
-----
OE          SELECT      ORDERS          SELECT COUNT(*) FROM ORDERS
SALES_REP_ID = 159 VPD              SEC_ADMIN       ORDERS_POLICY

```

Related Topics

- [Using Oracle Virtual Private Database to Control Data Access](#)
Oracle Virtual Private Database (VPD) enables you to filter users who access data.
- [Oracle Database PL/SQL Packages and Types Reference](#)

30.4.4.15 Audit Policies for Oracle Virtual Private Database Policy Functions

Auditing can affect dynamic VPD policies, static VPD policies, and context-sensitive VPD policies.

- **Dynamic policies:** Oracle Database evaluates the policy function twice, once during SQL statement parsing and again during execution. As a result, two audit records are generated for each evaluation.
- **Static policies:** Oracle Database evaluates the policy function once and then caches it in the SGA. As a result, only one audit record is generated.
- **Context-sensitive policies:** Oracle Database executes the policy function once, during statement parsing. As a result, only one audit record is generated.

30.4.4.16 Unified Auditing with Editioned Objects

An audit policy created to audit an action on an editioned object will be applied to all its editions.

In addition, newly created objects in an edition will inherit unified audit policies from the existing edition.

You can find the editions in which audited objects appear by querying the `OBJECT_NAME` and `OBJ_EDITION_NAME` columns in the `UNIFIED_AUDIT_TRAIL` data dictionary view.

Related Topics

- [Oracle Database Development Guide](#)

30.4.5 Auditing the READ ANY TABLE and SELECT ANY TABLE Privileges

The `CREATE AUDIT POLICY` statement can audit the `READ ANY TABLE` and `SELECT ANY TABLE` privileges.

- [About Auditing the READ ANY TABLE and SELECT ANY TABLE Privileges](#)
You can create unified audit policies that capture the use of the `READ ANY TABLE` and `SELECT ANY TABLE` system privileges.
- [Creating a Unified Audit Policy to Capture READ Object Privilege Operations](#)
You can create unified audit policies that capture `READ` object privilege operations.
- [How the Unified Audit Trail Captures READ ANY TABLE and SELECT ANY TABLE](#)
The unified audit trail captures `SELECT` behavior based on whether a user has the `READ ANY TABLE` or the `SELECT ANY TABLE` privilege.

30.4.5.1 About Auditing the READ ANY TABLE and SELECT ANY TABLE Privileges

You can create unified audit policies that capture the use of the `READ ANY TABLE` and `SELECT ANY TABLE` system privileges.

Based on the action that the user tried to perform and the privilege that was granted to the user, the `SYSTEM_PRIVILEGE_USED` column of the `UNIFIED_AUDIT_TRAIL` data dictionary view will record either the `READ ANY TABLE` system privilege or the `SELECT ANY TABLE` system privilege. For example, suppose the user has been granted the `SELECT ANY TABLE` privilege and then performs a query on a table. The audit trail will record that the user used the `SELECT ANY TABLE` system privilege. If the user was granted `READ ANY TABLE` and performed the same query, then the `READ ANY TABLE` privilege is recorded.

30.4.5.2 Creating a Unified Audit Policy to Capture READ Object Privilege Operations

You can create unified audit policies that capture `READ` object privilege operations.

- To create a unified audit policy to capture any `READ` object operations, create the policy for the `SELECT` statement, not for the `READ` statement.

For example:

```
CREATE AUDIT POLICY read_hr_employees
ACTIONS SELECT ON HR.EMPLOYEES;
```

For any `SELECT` object operations, also create the policy on the `SELECT` statement, as with other object actions that you can audit.

Related Topics

- [Auditing Object Actions](#)
You can use the `CREATE AUDIT POLICY` statement to audit object actions.

30.4.5.3 How the Unified Audit Trail Captures READ ANY TABLE and SELECT ANY TABLE

The unified audit trail captures `SELECT` behavior based on whether a user has the `READ ANY TABLE` or the `SELECT ANY TABLE` privilege.

[Table 30-3](#) describes how the unified audit trail captures these actions.

Table 30-3 Auditing Behavior for READ ANY TABLE and SELECT ANY TABLE

Statement User Issues	Privilege Granted to User	System Privilege Being Audited	Expected UNIFIED_AUDIT_TRAIL Behavior
SELECT	SELECT ANY TABLE	SELECT ANY TABLE	Record inserted into <code>SYSTEM_PRIVILEGE_USED</code> : <code>SELECT ANY TABLE</code>
SELECT	SELECT ANY TABLE	READ ANY TABLE	No record
SELECT	SELECT ANY TABLE	Both <code>SELECT ANY TABLE</code> and <code>READ ANY TABLE</code>	Record inserted into <code>SYSTEM_PRIVILEGE_USED</code> : <code>SELECT ANY TABLE</code>

Table 30-3 (Cont.) Auditing Behavior for READ ANY TABLE and SELECT ANY TABLE

Statement User Issues	Privilege Granted to User	System Privilege Being Audited	Expected UNIFIED_AUDIT_TRAIL Behavior
SELECT	SELECT ANY TABLE	Neither SELECT ANY TABLE nor READ ANY TABLE	No record
SELECT	READ ANY TABLE	SELECT ANY TABLE	No record
SELECT	READ ANY TABLE	READ ANY TABLE	Record inserted into SYSTEM_PRIVILEGE_USED: READ ANY TABLE
SELECT	READ ANY TABLE	Both SELECT ANY TABLE and READ ANY TABLE	Record inserted into SYSTEM_PRIVILEGE_USED: READ ANY TABLE
SELECT	READ ANY TABLE	Neither SELECT ANY TABLE nor READ ANY TABLE	No record
SELECT	Both SELECT ANY TABLE and READ ANY TABLE	SELECT ANY TABLE	No record, because READ ANY TABLE was used for access
SELECT	Both SELECT ANY TABLE and READ ANY TABLE	READ ANY TABLE	Record inserted into SYSTEM_PRIVILEGE_USED: READ ANY TABLE
SELECT	Both SELECT ANY TABLE and READ ANY TABLE	Both SELECT ANY TABLE and READ ANY TABLE	Record inserted into SYSTEM_PRIVILEGE_USED: READ ANY TABLE
SELECT	Both SELECT ANY TABLE and READ ANY TABLE	Neither SELECT ANY TABLE nor READ ANY TABLE	No record
SELECT	Neither SELECT ANY TABLE nor READ ANY TABLE	SELECT ANY TABLE	No record
SELECT	Neither SELECT ANY TABLE nor READ ANY TABLE	READ ANY TABLE	No record
SELECT	Neither SELECT ANY TABLE nor READ ANY TABLE	Both SELECT ANY TABLE and READ ANY TABLE	No record
SELECT	Neither SELECT ANY TABLE nor READ ANY TABLE	Neither SELECT ANY TABLE nor READ ANY TABLE	No record
SELECT ... FOR UPDATE	SELECT ANY TABLE	SELECT ANY TABLE	Record inserted into SYSTEM_PRIVILEGE_USED: SELECT ANY TABLE
SELECT ... FOR UPDATE	SELECT ANY TABLE	READ ANY TABLE	No record
SELECT ... FOR UPDATE	SELECT ANY TABLE	Both SELECT ANY TABLE and READ ANY TABLE	Record inserted into SYSTEM_PRIVILEGE_USED: SELECT ANY TABLE

Table 30-3 (Cont.) Auditing Behavior for READ ANY TABLE and SELECT ANY TABLE

Statement User Issues	Privilege Granted to User	System Privilege Being Audited	Expected UNIFIED_AUDIT_TRAIL Behavior
SELECT ... FOR UPDATE	SELECT ANY TABLE	Neither SELECT ANY TABLE nor READ ANY TABLE	No record
SELECT ... FOR UPDATE	READ ANY TABLE	SELECT ANY TABLE	No record
SELECT ... FOR UPDATE	READ ANY TABLE	READ ANY TABLE	No record
SELECT ... FOR UPDATE	READ ANY TABLE	Both SELECT ANY TABLE and READ ANY TABLE	No record
SELECT ... FOR UPDATE	READ ANY TABLE	Neither SELECT ANY TABLE nor READ ANY TABLE	No record
SELECT ... FOR UPDATE	Both SELECT ANY TABLE and READ ANY TABLE	SELECT ANY TABLE	Record inserted into SYSTEM_PRIVILEGE_USED: SELECT ANY TABLE
SELECT ... FOR UPDATE	Both SELECT ANY TABLE and READ ANY TABLE	READ ANY TABLE	No record, because READ ANY TABLE was used for access
SELECT ... FOR UPDATE	Both SELECT ANY TABLE and READ ANY TABLE	Both SELECT ANY TABLE and READ ANY TABLE	Record inserted into SYSTEM_PRIVILEGE_USED: SELECT ANY TABLE
SELECT ... FOR UPDATE	Both SELECT ANY TABLE and READ ANY TABLE	Neither SELECT ANY TABLE nor READ ANY TABLE	No record
SELECT ... FOR UPDATE	Neither SELECT ANY TABLE nor READ ANY TABLE	SELECT ANY TABLE	No record
SELECT ... FOR UPDATE	Neither SELECT ANY TABLE nor READ ANY TABLE	READ ANY TABLE	No record
SELECT ... FOR UPDATE	Neither SELECT ANY TABLE nor READ ANY TABLE	Both SELECT ANY TABLE and READ ANY TABLE	No record
SELECT ... FOR UPDATE	Neither SELECT ANY TABLE nor READ ANY TABLE	Neither SELECT ANY TABLE or READ ANY TABLE	No record

30.4.6 Auditing Only Top-Level Statements

You can audit top-level user-initiated SQL or PL/SQL statements to reduce audit volume.

- [About Auditing Only Top-Level SQL Statements](#)
A top-level statement is a statement that is executed directly by a user, not a statement that is run from within a PL/SQL procedure.
- [Configuring a Unified Audit Policy to Capture Only Top-Level Statements](#)
The ONLY TOPLEVEL clause in the CREATE AUDIT POLICY statement enables you to audit only the SQL statements that are directly issued by an end user by honoring the audit configuration in the audit policy.

- [Example: Auditing Top-Level Statements](#)
The `CREATE AUDIT POLICY` statement can include or exclude top-level statement audit records in the unified audit trail for any user.
- [Example: Comparison of Top-Level SQL Statement Audits](#)
You can generate top-level SQL statement audit records from SQL statements that are run directly in SQL or from within a PL/SQL procedure.
- [How the Unified Audit Trail Captures Top-Level SQL Statements](#)
The `ONLY TOPLEVEL` clause has no impact on the output for an individual unified audit trail record.

30.4.6.1 About Auditing Only Top-Level SQL Statements

A top-level statement is a statement that is executed directly by a user, not a statement that is run from within a PL/SQL procedure.

Consider auditing top-level statements from all users, including user `SYS` to reduce the volume of audit. The feature audits all the user-initiated actions and ignores the recursive SQL statements. For example, auditing the `DBMS_STATS.GATHER_DATABASE_STATS` SQL statement can generate over 200,000 individual audit records and by adding top-level this reduces to a single audit record.

30.4.6.2 Configuring a Unified Audit Policy to Capture Only Top-Level Statements

The `ONLY TOPLEVEL` clause in the `CREATE AUDIT POLICY` statement enables you to audit only the SQL statements that are directly issued by an end user by honoring the audit configuration in the audit policy.

To find policies that include the `ONLY TOPLEVEL` clause, query the `AUDIT_ONLY_TOPLEVEL` column of the `AUDIT_UNIFIED_POLICIES` data dictionary view.

Use the following syntax to create a unified audit policy that audits only top-level SQL statements.

```
CREATE AUDIT POLICY policy_name
all_existing_options
ONLY TOPLEVEL;
```

For example, to limit the audit trail to top-level instances of the `SELECT` statement on the `HR.EMPLOYEES` table:

```
CREATE AUDIT POLICY actions_on_hr_emp_pol
ACTIONS SELECT ON HR.EMPLOYEES
ONLY TOPLEVEL;
```

30.4.6.3 Example: Auditing Top-Level Statements

The `CREATE AUDIT POLICY` statement can include or exclude top-level statement audit records in the unified audit trail for any user.

The following example shows an audit policy that will capture all top level statements executed by user `SYS`.

Example 30-13 Example: Auditing Top-Level Statements Run by User SYS

```
CREATE AUDIT POLICY actions_all_pol ACTIONS ALL
ONLY TOPLEVEL;

AUDIT POLICY actions_all_pol BY SYS;
```

30.4.6.4 Example: Comparison of Top-Level SQL Statement Audits

You can generate top-level SQL statement audit records from SQL statements that are run directly in SQL or from within a PL/SQL procedure.

This example shows how generating audit records differs when you access a view outside a PL/SQL procedure as opposed to accessing the view inside the PL/SQL procedure. The output illustrates the difference in volume in audit records that are generated from the two different audit policies.

1. Log in to the database instance as user `SYS` with the `SYSDBA` administrative privilege. In a multitenant environment, log in to the PDB. To find the available PDBs in a CDB, log in to the CDB root container and then query the `PDB_NAME` column of the `DBA_PDBS` data dictionary view. To check the current container, run the `show con_name` command.
2. Create the following procedure:

```
CREATE OR REPLACE PROCEDURE proc1 AS
  cnt number;
BEGIN
  SELECT COUNT(*) INTO CNT FROM SYS.DBA_USERS WHERE USER_ID=9999;
END;
/
```

3. Create the and enable following audit policy to capture top-level actions:

```
CREATE AUDIT POLICY toplevel_pol ACTIONS ALL ONLY TOPLEVEL;
AUDIT POLICY toplevel_pol;
```

4. Run the following query to generate an audit record and to access the `SYS.DBA_USERS` view outside of the `proc1` procedure that you just created:

```
SELECT /* TOPLEVEL */ COUNT(*) FROM SYS.DBA_USERS WHERE USER_ID=0000;
```

The output should be as follows:

```
  COUNT(*)
-----
         1
```

5. Run the `proc1` procedure that you created earlier, to access the `SYS.DBA_USERS` view again, but from within a procedure.

```
EXEC proc1;
```

6. Query the `UNIFIED_AUDIT_TRAIL` data dictionary view as follows:

```
SELECT ACTION_NAME, OBJECT_SCHEMA, OBJECT_NAME, STATEMENT_ID, ENTRY_ID,
       UNIFIED_AUDIT_POLICIES, SQL_TEXT
FROM UNIFIED_AUDIT_TRAIL
ORDER BY EVENT_TIMESTAMP;
```

Output similar to the following appears:

```

ACTION_NAME          OBJECT_SCHEMA
-----
OBJECT_NAME          STATEMENT_ID  ENTRY_ID
-----
UNIFIED_AUDIT_POLICIES
-----
SQL_TEXT
-----
LOGON
                                1          1
TOPLEVEL_POL

COMMIT
                                3          2
TOPLEVEL_POL

COMMIT
                                4          3
TOPLEVEL_POL

SELECT          SYS
USER$
                                5          4
TOPLEVEL_POL
select /* toplevel */ count(*) from sys.dba_users where user
_id=0000

SELECT          SYS
RESOURCE_GROUP_MAPPING$
                                5          5
TOPLEVEL_POL
select /* toplevel */ count(*) from sys.dba_users where user
_id=0000

SELECT          SYS
TS$
                                5          6
TOPLEVEL_POL
select /* toplevel */ count(*) from sys.dba_users where user
_id=0000

SELECT          SYS
TS$
                                5          7
TOPLEVEL_POL
select /* toplevel */ count(*) from sys.dba_users where user
_id=0000

SELECT          SYS
TS$
                                5          8
TOPLEVEL_POL
select /* toplevel */ count(*) from sys.dba_users where user
_id=0000

SELECT          SYS

```

```

PROFNAME$                                5          9
TOPLEVEL_POL
select /* toplevel */ count(*) from sys.dba_users where user
_id=0000

SELECT                                SYS
USER_ASTATUS_MAP                        5          10
TOPLEVEL_POL
select /* toplevel */ count(*) from sys.dba_users where user
_id=0000

SELECT                                SYS
PROFILE$                                5          11
TOPLEVEL_POL
select /* toplevel */ count(*) from sys.dba_users where user
_id=0000

SELECT                                SYS
PROFILE$                                5          12
TOPLEVEL_POL
select /* toplevel */ count(*) from sys.dba_users where user
_id=0000

SELECT                                SYS
DBA_USERS                                5          13
TOPLEVEL_POL
select /* toplevel */ count(*) from sys.dba_users where user
_id=0000

EXECUTE                                SYS
PROC1                                    7          14
TOPLEVEL_POL
BEGIN proc1; END;

14 rows selected.

```

7. Disable and then drop the `toplevel_pol` audit policy.

```

NOAUDIT POLICY toplevel_pol;
DROP AUDIT POLICY toplevel_pol;

```

8. Create and enable a new audit policy to capture all actions.

```

CREATE AUDIT POLICY recursive_pol ACTIONS ALL;
AUDIT POLICY recursive_pol;

```

9. Clean up the audit trail.

```

DBMS_AUDIT_MGMT.CLEAN_AUDIT_TRAIL(DBMS_AUDIT_MGMT.AUDIT_TRAIL_UNIFIED, FALSE
);

```

10. Run the following query to generate an audit record and to access the `SYS.DBA_USERS` view outside of the `proc1` procedure:

```

SELECT /* TOPLEVEL */ COUNT(*) FROM SYS.DBA_USERS WHERE USER_ID=0000;

```

The output should be as follows:

```

COUNT(*)
-----
1

```

11. Run the `procl` procedure to access the `SYS.DBA_USERS` again, but from within the `procl` procedure.

```
EXEC procl;
```

12. Query the `UNIFIED_AUDIT_TRAIL` data dictionary view as follows:

```

SELECT ACTION_NAME, OBJECT_SCHEMA, OBJECT_NAME, STATEMENT_ID, ENTRY_ID,
       UNIFIED_AUDIT_POLICIES, SQL_TEXT
FROM UNIFIED_AUDIT_TRAIL
ORDER BY EVENT_TIMESTAMP;

```

Output similar to the following should appear:

```

ACTION_NAME          OBJECT_SCHEMA
-----
OBJECT_NAME          UNIFIED_AUDIT_POLICIES          STATEMENT_ID
-----
ENTRY_ID SQL_TEXT
-----
LOGON
          RECURSIVE_POL          1
          1
ALTER SESSION
          RECURSIVE_POL          1
          2 ALTER SESSION SET TIME_ZONE='-07:00'
COMMIT
          RECURSIVE_POL          3
          3
COMMIT
          RECURSIVE_POL          4
          4
SELECT              SYS
USER$              RECURSIVE_POL          5
          5 select /* toplevel */ count(*) from sys.dba_users where user
          _id=0000
SELECT              SYS
RESOURCE_GROUP_MAPPING$ RECURSIVE_POL          5
          6 select /* toplevel */ count(*) from sys.dba_users where user
          _id=0000
SELECT              SYS
TS$              RECURSIVE_POL          5
          7 select /* toplevel */ count(*) from sys.dba_users where user
          _id=0000

```

```

SELECT          SYS
TS$              RECURSIVE_POL                    5
      8 select /* toplevel */ count(*) from sys.dba_users where user
         _id=0000

SELECT          SYS
TS$              RECURSIVE_POL                    5
      9 select /* toplevel */ count(*) from sys.dba_users where user
         _id=0000

SELECT          SYS
PROFNAME$        RECURSIVE_POL                    5
     10 select /* toplevel */ count(*) from sys.dba_users where user
         _id=0000

SELECT          SYS
USER_ASTATUS_MAP RECURSIVE_POL                    5
     11 select /* toplevel */ count(*) from sys.dba_users where user
         _id=0000

SELECT          SYS
PROFILE$         RECURSIVE_POL                    5
     12 select /* toplevel */ count(*) from sys.dba_users where user
         _id=0000

SELECT          SYS
PROFILE$         RECURSIVE_POL                    5
     13 select /* toplevel */ count(*) from sys.dba_users where user
         _id=0000

SELECT          SYS
DBA_USERS        RECURSIVE_POL                    5
     14 select /* toplevel */ count(*) from sys.dba_users where user
         _id=0000

SELECT          SYS
USER$            RECURSIVE_POL                    7
     15 SELECT COUNT(*) FROM SYS.DBA_USERS WHERE USER_ID=9999

SELECT          SYS
RESOURCE_GROUP_MAPPING$ RECURSIVE_POL            7
     16 SELECT COUNT(*) FROM SYS.DBA_USERS WHERE USER_ID=9999

SELECT          SYS
TS$              RECURSIVE_POL                    7
     17 SELECT COUNT(*) FROM SYS.DBA_USERS WHERE USER_ID=9999

SELECT          SYS
TS$              RECURSIVE_POL                    7
     18 SELECT COUNT(*) FROM SYS.DBA_USERS WHERE USER_ID=9999

SELECT          SYS
TS$              RECURSIVE_POL                    7
     19 SELECT COUNT(*) FROM SYS.DBA_USERS WHERE USER_ID=9999

```

```

SELECT          SYS
PROFNAME$          RECURSIVE_POL          7
      20 SELECT COUNT(*) FROM SYS.DBA_USERS WHERE USER_ID=9999

SELECT          SYS
USER_ASTATUS_MAP  RECURSIVE_POL          7
      21 SELECT COUNT(*) FROM SYS.DBA_USERS WHERE USER_ID=9999

SELECT          SYS
PROFILE$          RECURSIVE_POL          7
      22 SELECT COUNT(*) FROM SYS.DBA_USERS WHERE USER_ID=9999

SELECT          SYS
PROFILE$          RECURSIVE_POL          7
      23 SELECT COUNT(*) FROM SYS.DBA_USERS WHERE USER_ID=9999

SELECT          SYS
DBA_USERS         RECURSIVE_POL          7
      24 SELECT COUNT(*) FROM SYS.DBA_USERS WHERE USER_ID=9999

EXECUTE          SYS
PROC1            RECURSIVE_POL          7
      25 BEGIN procl; END;

25 rows selected.

```

The output in this query generates 25 records, as opposed to the 14 that were generated earlier.

13. Disable and remove the `recursive_pol` policy.

```

NOAUDIT POLICY recursive_pol;
DROP AUDIT POLICY recursive_pol;

```

30.4.6.5 How the Unified Audit Trail Captures Top-Level SQL Statements

The `ONLY TOPLEVEL` clause has no impact on the output for an individual unified audit trail record.

The only effect that `ONLY TOPLEVEL` has on a policy is to limit the number of records generated for the given unified audit policy.

30.5 Unified Auditing with Configurable Conditions

You can use the `CREATE AUDIT POLICY` statement to create conditions for a unified audit policy.

- [About Conditions in Unified Audit Policies](#)
You can use conditions in unified audit policies to create focused and selective audit policies.
- [Configuring a Unified Audit Policy with a Condition](#)
The `WHEN` clause in the `CREATE AUDIT POLICY` statement defines the condition in the audit policy.
- [Example: Auditing Access to SQL*Plus](#)
The `CREATE AUDIT POLICY` statement can audit access to SQL*Plus.

- [Example: Auditing Actions Not in Specific Hosts](#)
The `CREATE AUDIT POLICY` statement can audit actions that are not in specific hosts.
- [Example: Auditing Both a System-Wide and a Schema-Specific Action](#)
The `CREATE AUDIT POLICY` statement can audit both system-wide and schema-specific actions.
- [Example: Auditing a Condition Per Statement Occurrence](#)
The `CREATE AUDIT POLICY` statement can audit conditions.
- [Example: Unified Audit Session ID of a Current Administrative User Session](#)
The `SYS_CONTEXT` function can be used to find session IDs.
- [Example: Unified Audit Session ID of a Current Non-Administrative User Session](#)
The `SYS_CONTEXT` function can find the session ID of a current non-administrative user session.
- [How Audit Records from Conditions Appear in the Audit Trail](#)
The audit record conditions from a unified audit policy do not appear in the audit trail.

30.5.1 About Conditions in Unified Audit Policies

You can use conditions in unified audit policies to create focused and selective audit policies.

You can use the `CREATE AUDIT POLICY` statement to create conditions for a unified audit policy. For example, you can create policy that audits only when access is from a specific host or IP address. If the audit condition is satisfied, then only then the audit record is generated for the event. As part of the condition definition, you must specify whether the audited condition is evaluated per statement occurrence, session, or database instance.

Note:

Audit conditions can use attributes from the `USERENV` namespace, or from named application contexts (both secure and insecure).

30.5.2 Configuring a Unified Audit Policy with a Condition

The `WHEN` clause in the `CREATE AUDIT POLICY` statement defines the condition in the audit policy.

- Use the following syntax to create a unified audit policy that uses a condition:

```
CREATE AUDIT POLICY policy_name
  action_privilege_role_audit_option
  [WHEN function_operation_value_list_1 [[AND | OR] function_operation_value_list_n]
  EVALUATE PER STATEMENT | SESSION | INSTANCE];
```

In this specification:

- `action_privilege_role_audit_option` refers to audit options for system actions, object actions, privileges, and roles.
- `WHEN` defines the condition. It has the following components:
 - `function` uses the following types of functions:
 - Numeric functions, such as `BITAND`, `CEIL`, `FLOOR`, and `LN POWER`

Character functions that return character values, such as `CONCAT`, `LOWER`, and `UPPER`

Character functions that return numeric values, such as `LENGTH` or `INSTR`

Environment and identifier functions, such as `SYS_CONTEXT` and `UID`. For `SYS_CONTEXT`, in most cases, you may want to use the `USERENV` namespace.

- *operation* can be any the following operators: `AND`, `OR`, `IN`, `NOT IN`, `=`, `<`, `>`, `<>`
- *value_list* refers to the condition for which you are testing.

You can include additional conditions for each *function_operation_value_list* set, separated by `AND` or `OR`.

When you write the `WHEN` clause, follow these guidelines:

- Enclose the entire *function operation value* setting in single quotation marks. Within the clause, enclose each quoted component within two pairs of single quotation marks. Do not use double quotation marks.
- Do not exceed 4000 bytes for the `WHEN` condition.
- `EVALUATE PER` refers to the following options:
 - `STATEMENT` evaluates the condition for each relevant auditable statement that occurs.
 - `SESSION` evaluates the condition only once during the session, and then caches and re-uses the result during the remainder of the session. Oracle Database evaluates the condition the first time the policy is used, and then stores the result in UGA memory afterward.
 - `INSTANCE` evaluates the condition only once during the database instance lifetime. After Oracle Database evaluates the condition, it caches and re-uses the result for the remainder of the instance lifetime. As with the `SESSION` evaluation, the evaluation takes place the first time it is needed, and then the results are stored in UGA memory afterward.

For example:

```
CREATE AUDIT POLICY oe_orders_pol
ACTIONS UPDATE ON OE.ORDERS
WHEN 'SYS_CONTEXT(''USERENV'', 'IDENTIFICATION_TYPE') = 'EXTERNAL'''
EVALUATE PER STATEMENT;
```

Remember that after you create the policy, you must use the `AUDIT` statement to enable it.

Related Topics

- *Oracle Database SQL Language Reference*

30.5.3 Example: Auditing Access to SQL*Plus

The `CREATE AUDIT POLICY` statement can audit access to SQL*Plus.

[Example 30-14](#) shows how to audit access to the database with SQL*Plus by users who have been directly granted the roles `emp_admin` and `sales_admin`.

Example 30-14 Auditing Access to SQL*Plus

```
CREATE AUDIT POLICY logon_pol
ACTIONS LOGON
WHEN 'INSTR(UPPER(SYS_CONTEXT(''USERENV'', 'CLIENT_PROGRAM_NAME')), 'SQLPLUS') > 0'
EVALUATE PER SESSION;
```

```
AUDIT POLICY logon_pol BY USERS WITH GRANTED ROLES emp_admin, sales_admin;
```

30.5.4 Example: Auditing Actions Not in Specific Hosts

The `CREATE AUDIT POLICY` statement can audit actions that are not in specific hosts.

[Example 30-15](#) shows how to audit two actions (`UPDATE` and `DELETE` statements) on the `OE.ORDERS` table, but excludes the host names `sales_24` and `sales_12` from the audit. It performs the audit on a per session basis and writes audit records for failed attempts only.

Example 30-15 Auditing Actions Not in Specific Hosts

```
CREATE AUDIT POLICY oe_table_audit1
ACTIONS UPDATE ON OE.ORDERS, DELETE ON OE.ORDERS
WHEN 'SYS_CONTEXT (''USERENV'', 'HOST') NOT IN ('sales_24','sales_12')'
EVALUATE PER SESSION;
```

```
AUDIT POLICY oe_table_audit1 WHENEVER NOT SUCCESSFUL;
```

30.5.5 Example: Auditing Both a System-Wide and a Schema-Specific Action

The `CREATE AUDIT POLICY` statement can audit both system-wide and schema-specific actions.

[Example 30-16](#) shows a variation of [Example 30-15](#) in which the `UPDATE` statement is audited system wide. The `DELETE` statement audit is still specific to the `OE.ORDERS` table.

Example 30-16 Auditing Both a System-Wide and a Schema-Specific Action

```
CREATE AUDIT POLICY oe_table_audit2
ACTIONS UPDATE, DELETE ON OE.ORDERS
WHEN 'SYS_CONTEXT (''USERENV'', 'HOST') NOT IN ('sales_24','sales_12')'
EVALUATE PER SESSION;
```

```
AUDIT POLICY oe_table_audit2;
```

30.5.6 Example: Auditing a Condition Per Statement Occurrence

The `CREATE AUDIT POLICY` statement can audit conditions.

[Example 30-17](#) shows how to audit a condition based on each occurrence of the `DELETE` statement on the `OE.ORDERS` table and exclude user `jmartin` from the audit.

Example 30-17 Auditing a Condition Per Statement Occurrence

```
CREATE AUDIT POLICY sales_clerk_pol
ACTIONS DELETE ON OE.ORDERS
WHEN 'SYS_CONTEXT(''USERENV'', 'CLIENT_IDENTIFIER') = 'sales_clerk''
EVALUATE PER STATEMENT;
```

```
AUDIT POLICY sales_clerk_pol EXCEPT jmartin;
```

30.5.7 Example: Unified Audit Session ID of a Current Administrative User Session

The `SYS_CONTEXT` function can be used to find session IDs.

[Example 30-18](#) shows how to find the unified audit session ID of current user session for an administrative user.

Example 30-18 Unified Audit Session ID of a Current Administrative User Session

```
CONNECT SYS AS SYSDBA
Enter password: password

SELECT SYS_CONTEXT('USERENV', 'UNIFIED_AUDIT_SESSIONID') FROM DUAL;
```

Output similar to the following appears:

```
SYS_CONTEXT('USERENV', 'UNIFIED_AUDIT_SESSIONID')
-----
2318470183
```

Note that in mixed mode auditing, the `UNIFIED_AUDIT_SESSIONID` value in the `USERENV` namespace is different from the value that is recorded by the `SESSIONID` parameter. Hence, if you are using mixed mode auditing and want to find the correct audit session ID, you should use the `USERENV UNIFIED_AUDIT_SESSIONID` parameter, not the `SESSIONID` parameter. In pure unified auditing, the `SESSIONID` and `UNIFIED_AUDIT_SESSIONID` values are the same.

30.5.8 Example: Unified Audit Session ID of a Current Non-Administrative User Session

The `SYS_CONTEXT` function can find the session ID of a current non-administrative user session.

[Example 30-19](#) shows how to find the unified audit session ID of a current user session for a non-administrative user.

Example 30-19 Unified Audit Session ID of a Current Non-Administrative User Session

```
CONNECT mblake@pdb_name
Enter password: password

SELECT SYS_CONTEXT('USERENV', 'UNIFIED_AUDIT_SESSIONID') FROM DUAL;
```

Output similar to the following appears:

```
SYS_CONTEXT('USERENV', 'UNIFIED_AUDIT_SESSIONID')
-----
2776921346
```

30.5.9 How Audit Records from Conditions Appear in the Audit Trail

The audit record conditions from a unified audit policy do not appear in the audit trail.

If the condition evaluates to true and the record is written, then the record appears in the audit trail. You can check the audit trail by querying the `UNIFIED_AUDIT_TRAIL` data dictionary view.

Related Topics

- [Unified Audit Policy Data Dictionary Views](#)
You can query data dictionary and dynamic views to find detailed auditing information about custom unified audit policies.

30.6 Auditing for Multitier or Multitenant Configurations

You can create unified audit policies using conditions and application contexts, and in multitier and multitenant environments.

- [Auditing in a Multitier Deployment](#)
You can create a unified audit policy to audit the activities of a client in a multitier environment.
- [Auditing in a Multitenant Deployment](#)
You can create unified audit policies for individual PDBs and in the root.

30.6.1 Auditing in a Multitier Deployment

You can create a unified audit policy to audit the activities of a client in a multitier environment.

In a multitier environment, Oracle Database preserves the identity of a client through all tiers. Thus, you can audit actions taken on behalf of the client by a middle-tier application, by using the `BY user` clause in the `AUDIT` statement for your policy. The audit applies to all user sessions, including proxy sessions.

The middle tier can also set the user client identity in a database session, enabling the auditing of end-user actions through the middle-tier application. The end-user client identity then shows up in the audit trail.

For example, suppose the proxy user `apphr` can connect as user `jackson`. The policy and enablement can be as follows:

```
CREATE AUDIT POLICY prox_pol ACTIONS LOGON;
AUDIT POLICY prox_pol BY jackson;
```

You can audit user activity in a multitier environment. Once audited, you can verify these activities by querying the `UNIFIED_AUDIT_TRAIL` data dictionary view. For example:

```
SELECT DBUSERNAME, DB_PROXY_USERNAME, PROXY_SESSIONID, ACTION_NAME
FROM UNIFIED_AUDIT_TRAIL
WHERE DBPROXY_USERNAME IS NOT NULL;
```

Output similar to the following appears:

DBUSERNAME	DBPROXY_USERNAME	PROXY_SESSIONID	ACTION_NAME
JACKSON	APPHR	1214623540	LOGON

Figure 30-1 illustrates how you can audit proxy users by querying the `PROXY_SESSIONID`, `ACTION_NAME`, and `SESSION_ID` columns of the `UNIFIED_AUDIT_TRAIL` view. In this scenario, both the database user and proxy user accounts are known to the database. Session pooling can be used.

Figure 30-1 Auditing Proxy Users

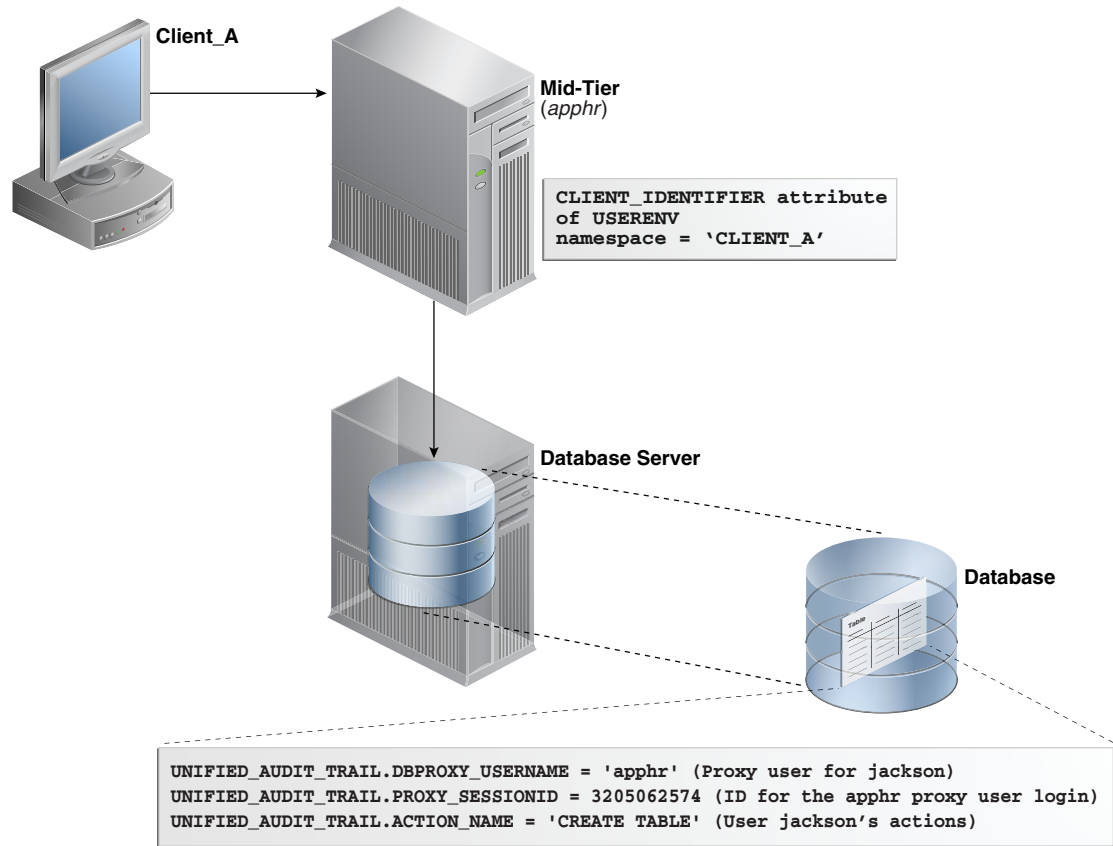
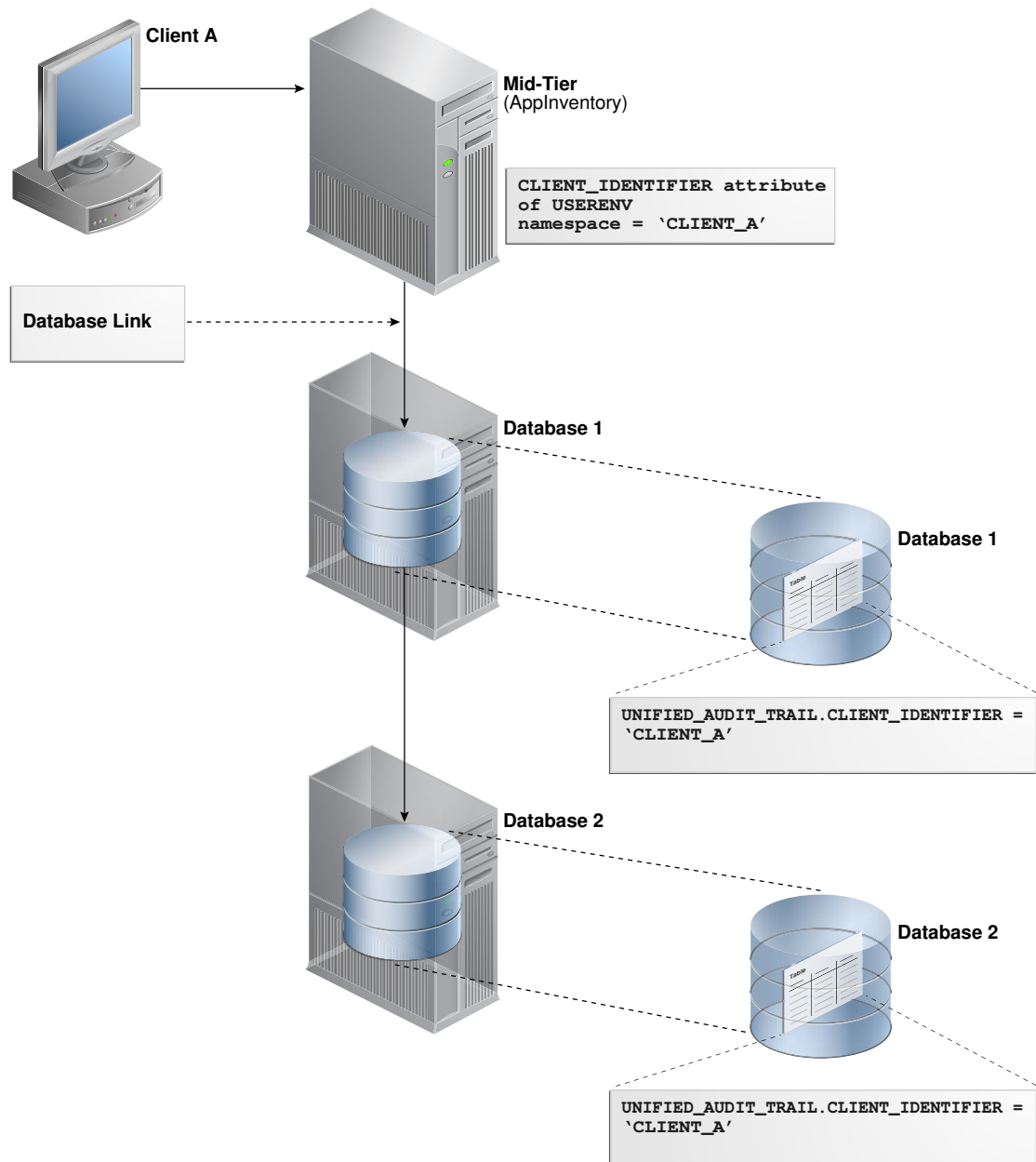

Figure 30-2 illustrates how you can audit client identifier information across multiple database sessions by querying the `CLIENT_ID` column of the `DBA_AUDIT_TRAIL` data dictionary view. In this scenario, the client identifier has been set to `CLIENT_A`. As with the proxy user-database user scenario described in Figure 30-1, session pooling can be used.

Figure 30-2 Auditing Client Identifier Information Across Sessions



Related Topics

- [Preserving User Identity in Multitiered Environments](#)
You can use middle tier servers for proxy authentication and client identifiers to identify application users who are not known to the database.

30.6.2 Auditing in a Multitenant Deployment

You can create unified audit policies for individual PDBs and in the root.

- [About Local, CDB Common, and Application Common Audit Policies](#)
An audit policy can be either a local audit policy, a CDB common audit policy, or an application common audit policy.

- [Common Audit Configurations Across All PDBs](#)
A common audit configuration is visible and enforced across all PDBs.
- [Unified Audit Policies in an Application Root](#)
When you create an application root from a regular PDB, any local unified audit policies in this PDB are added to this application root.
- [Configuring a Local Unified Audit Policy or Common Unified Audit Policy](#)
The `CONTAINER` clause is specific to multitenant environment use for the `CREATE AUDIT POLICY` statement.
- [Example: Local Unified Audit Policy](#)
The `CREATE AUDIT POLICY` statement can create a local unified audit policy in either the root or a PDB.
- [Example: CDB Common Unified Audit Policy](#)
The `CREATE AUDIT POLICY` statement can create a CDB common unified audit policy.
- [Example: Application Common Unified Audit Policy](#)
For application container common unified audit policies, you can audit action options and system privilege options, and refer to common objects and roles.
- [How Local or Common Audit Policies or Settings Appear in the Audit Trail](#)
You can query unified audit policy views from either the root or the PDB in which the action occurred.

30.6.2.1 About Local, CDB Common, and Application Common Audit Policies

An audit policy can be either a local audit policy, a CDB common audit policy, or an application common audit policy.

This applies to both unified audit policies and policies that are created using the `AUDIT SQL` statement.

- **Local audit policy.** This type of policy can exist in either the root (CDB or application) or the PDB (CDB or application). A local audit policy that exists in the root can contain object audit options for both local and common objects. Both local and common users who have been granted the `AUDIT_ADMIN` role can enable local policies: local users from their PDBs and common users from the root or the PDB to which they have privileges. You can enable a local audit policy for both local and common users and roles.

You can create local audit policies for application local objects and application local roles, as well as system action options and system privilege options. You cannot enforce a local audit policy for a common user across all containers, nor can you enforce a common audit policy for a local user.

- **CDB common audit policy.** This type of policy is available to all PDBs in the multitenant environment. Only common users who have been granted the `AUDIT_ADMIN` role can create and maintain common audit policies. You can enable common audit policies only for common users. You must create common audit policies only in the root. This type of policy can contain object audit options of only common objects, and be enabled only for common users. You can enable a common audit policy for common users and roles only.

The name of a CDB common audit policy must begin with the value of the `COMMON_USER_PREFIX` initialization parameter. The default value of the `COMMON_USER_PREFIX` parameter is `c##`. For example, `c##hr_admin` is a valid common audit policy name. The length of the audit policy name cannot exceed 128 bytes and must contain ASCII characters only.

You cannot enforce a common audit policy for a local user across all containers.

- **Application common audit policy.** Similar to CDB common audit policies, this type of policy is available to all PDBs in the multitenant environment. You can create common audit policies for application common objects and application common roles, as well as system action options and system privilege options. You can only create this type of policy in the application root container, but you can enable it on both application common users and CDB common users. If you want to audit objects, then ensure that these objects are application common objects. You can determine whether an object is an application common object by querying the `SHARING` column of the `DBA_OBJECTS` data dictionary view.

The naming conventions for application common audit policies follow the same rules as those for CDB common audit policies, except that the value of the `COMMON_USER_PREFIX` is fetched from the application root. The default value in application root is an empty string. For example, `hr_admin` is a valid application common audit policy name.

By default, audit policies are local to the current PDB, for both CDB and application scenarios.

The following table explains how audit policies apply in different multitenant environments.

Table 30-4 How Audit Policies Apply to the CDB Root, Application Root, and Individual PDBs

Audit Option Type	CDB Root	Application Root	Individual PDB
Common audit statement or audit policy	Applies to CDB common users	Applies to CDB common users	Applies to CDB common users
Application container common audit statement or audit policy	Not applicable	<ul style="list-style-type: none"> • Applies to CDB common users and are valid for the current application container only • Applies to application container common users 	<ul style="list-style-type: none"> • Applies to CDB common users and are valid for this application container only • Applies to application common users
Local audit statement or audit policy	Local configurations not allowed	Local configurations not allowed	<ul style="list-style-type: none"> • Applies to CDB common users • Applies to application common users

30.6.2.2 Common Audit Configurations Across All PDBs

A common audit configuration is visible and enforced across all PDBs.

Audit configurations are either local or common. The scoping rules that apply to other local or common phenomena, such as users and roles, all apply to audit configurations.



Note:

Audit initialization parameters exist at the CDB level and not in each PDB.

PDBs support the following auditing options:

- Object auditing

Object auditing refers to audit configurations for specific objects. Only common objects can be part of the common audit configuration. A local audit configuration cannot contain common objects.

- Audit policies

Audit policies can be local or common:

- Local audit policies

A local audit policy applies to a single PDB. You can enforce local audit policies for local and common users in this PDB only. Attempts to enforce local audit policies across all containers result in an error.

In all cases, enforcing of a local audit policy is part of the local auditing framework.

- Common audit policies

A common audit policy applies to all containers. When you create a common audit policy, prefix the name with `C##` or `c##` (for example, `c##all_select_pol`). This policy can only contain actions, system privileges, common roles, and common objects. You can apply a common audit policy only to common users. Attempts to enforce a common audit policy for a local user across all containers result in an error.

A common audit configuration is stored in the `SYS` schema of the root. A local audit configuration is stored in the `SYS` schema of the PDB to which it applies.

Audit trails are stored in the `SYS` or `AUDSYS` schemas of the relevant CDB or PDB container. Operating system and XML audit trails for PDBs are stored in subdirectories of the directory specified by the `AUDIT_FILE_DEST` (deprecated) initialization parameter.

30.6.2.3 Unified Audit Policies in an Application Root

When you create an application root from a regular PDB, any local unified audit policies in this PDB are added to this application root.

This applies to both unified audit policies and policies that are created using the `AUDIT SQL` statement.

In this situation, you will need to convert the local unified audit policies to common unified audit policies. To do so, drop each existing local unified audit policy from the application root and then use the `CREATE AUDIT POLICY` statement to recreate it as an application common audit policy.

Related Topics

- [Example: Application Common Unified Audit Policy](#)
For application container common unified audit policies, you can audit action options and system privilege options, and refer to common objects and roles.

30.6.2.4 Configuring a Local Unified Audit Policy or Common Unified Audit Policy

The `CONTAINER` clause is specific to multitenant environment use for the `CREATE AUDIT POLICY` statement.

To create a local or common (CDB or application) unified audit policy in either the CDB environment or an application container environment, include the `CONTAINER` clause in the `CREATE AUDIT POLICY` statement.

- Use the following syntax to create a local or common unified audit policy:

```
CREATE AUDIT POLICY policy_name
  action1 [,action2 ]
  [CONTAINER = {CURRENT | ALL}];
```

In this specification:

- `CURRENT` sets the audit policy to be local to the current PDB.
- `ALL` makes the audit policy a common audit policy, that is, available to the entire multitenant environment.

For example, for a common unified audit policy:

```
CREATE AUDIT POLICY dict_updates
  ACTIONS UPDATE ON SYS.USER$,
  DELETE ON SYS.USER$,
  UPDATE ON SYS.LINK$,
  DELETE ON SYS.LINK$
  CONTAINER = ALL;
```

Note the following:

- You can set the `CONTAINER` clause for the `CREATE AUDIT POLICY` statement but not for `ALTER AUDIT POLICY` or `DROP AUDIT POLICY`. If you want to change the scope of an existing unified audit policy to use this setting, then you must drop and re-create the policy.
- For `AUDIT` statements, you can set the `CONTAINER` clause for audit settings only if you have an Oracle database that has not been migrated to the Release 12.x and later audit features. You cannot use the `CONTAINER` clause in an `AUDIT` statement that is used to enable a unified audit policy.
- If you are in a PDB, then you can only set the `CONTAINER` clause to `CURRENT`, not `ALL`. If you omit the setting while in the PDB, then the default is `CONTAINER = CURRENT`.
- If you are in the root, then you can set the `CONTAINER` clause to either `CURRENT` if you want the policy to apply to the root only, or to `ALL` if you want the policy to apply to the entire CDB. If you omit the `CONTAINER` clause, then default is `CONTAINER = CURRENT`.
- For objects:
 - Common audit policies can have common objects only and local audit policies can have both local objects and common objects.
 - You cannot set `CONTAINER` to `ALL` if the objects involved are local. They must be common objects.
- For privileges:
 - You can set the `CONTAINER` to `CURRENT` (or omit the `CONTAINER` clause) if the user accounts involved are a mixture of local and common accounts. This creates a local audit configuration that applies only to the current PDB.
 - You cannot set `CONTAINER` to `ALL` if the users involved are local users. They must be common users.
 - If you set `CONTAINER` to `ALL` and do not specify a user list (using the `BY` clause in the `AUDIT` statement), then the configuration applies to all common users in each PDB.

- For application containers, you can run a common unified audit policy from the application container script that is used for application install, upgrade, patch, and uninstall operations. To do so:
 1. Create a common unified audit policy in the application container root, and set this policy to `CONTAINER = ALL`. Alternatively, you can include this policy in the script that is described in this next step.
 2. Create a custom version of the script you normally would use to install, upgrade, patch, or uninstall Oracle Database.
 3. Within this script, include the SQL statements that you want to audit within the following lines:

```
ALTER PLUGGABLE DATABASE APPLICATION BEGIN INSTALL
List SQL statements here. Separate each statement with a semi-colon.
ALTER PLUGGABLE DATABASE APPLICATION END INSTALL
```

If you include the unified audit policy in the script, then ensure that you include both the `CREATE AUDIT POLICY` and `AUDIT POLICY` statements.

After the audit policy is created and enabled, all user access to the application common objects is audited irrespective of whether the audit policy is defined in the database or from the script.

- To audit application install, upgrade, patch, and uninstall operations locally in an application root or an application PDB, follow a procedure similar to the preceding procedure for common unified audit policies, but synchronize the application PDB afterward. For example:

```
ALTER PLUGGABLE DATABASE APPLICATION application_name SYNC;
```

Related Topics

- *Oracle Multitenant Administrator's Guide*

30.6.2.5 Example: Local Unified Audit Policy

The `CREATE AUDIT POLICY` statement can create a local unified audit policy in either the root or a PDB.

When you create a local unified audit policy in the root, it only applies to the root and not across the multitenant environment.

The following example shows a local unified audit policy that has been created by the common user `c##sec_admin` from a PDB and applied to common user `c##hr_admin`.

Example 30-20 Local Unified Audit Policy

```
CONNECT c##sec_admin@pdb_name
Enter password: password
Connected.
```

```
CREATE AUDIT POLICY table_privs
PRIVILEGES CREATE ANY TABLE, DROP ANY TABLE
CONTAINER = CURRENT;
```

```
AUDIT POLICY table_privs BY c##hr_admin;
```

30.6.2.6 Example: CDB Common Unified Audit Policy

The `CREATE AUDIT POLICY` statement can create a CDB common unified audit policy.

[Example 30-21](#) shows a common unified audit policy that has been created by the common user `c##sec_admin` from the root and applied to common user `c##hr_admin`.

Example 30-21 Common Unified Audit Policy

```
CONNECT c##sec_admin
Enter password: password
Connected.

CREATE AUDIT POLICY admin_pol
ACTIONS CREATE TABLE, ALTER TABLE, DROP TABLE
ROLES c##hr_mgr, c##hr_sup
CONTAINER = ALL;

AUDIT POLICY admin_pol BY c##hr_admin;
```

30.6.2.7 Example: Application Common Unified Audit Policy

For application container common unified audit policies, you can audit action options and system privilege options, and refer to common objects and roles.

You can create the application common audit policy only from the application root, and enable the policy for both application common users and CDB common users.

The following example shows how to create a policy that audits the application common user `SYSTEM` for the application container `app_pdb`. The audit policy audits `SELECT` actions on the `SYSTEM.utils_tab` table and on `DROP TABLE` actions on any of the PDBs in the container database, including the CDB root. The policy also audits the use of the `SELECT ANY TABLE` system privilege across all containers.

Example 30-22 Application Common Unified Audit Policy

```
CONNECT c##sec_admin@app_pdb
Enter password: password
Connected.

CREATE AUDIT POLICY app_pdb_admin_pol
ACTIONS SELECT ON hr_app_cdb.utils_tab, DROP TABLE
PRIVILEGES SELECT ANY TABLE
CONTAINER = ALL;

AUDIT POLICY app_pdb_admin_pol by SYSTEM, c##hr_admin;
```

In the preceding example, setting `CONTAINER` to `ALL` applies the policy only to all the relevant object accesses in the application root and on all the application PDBs that belong to the application root. It does not apply the policy outside this scope.

30.6.2.8 How Local or Common Audit Policies or Settings Appear in the Audit Trail

You can query unified audit policy views from either the root or the PDB in which the action occurred.

You can perform the following types of queries:

- **Audit records from all PDBs.** The audit trail reflects audited actions that have been performed in the PDBs. For example, if user `lbrown` in `PDB1` performs an action that has been audited by either a common or a local audit policy, then the audit trail will capture this action. The `DBID` column in the `UNIFIED_AUDIT_TRAIL` data dictionary view indicates the PDB in which the audited action takes place and to which the policy applies. If you want to see audit records from all PDBs, you should query the `CDB_UNIFIED_AUDIT_TRAIL` data dictionary view from the root.
- **Audit records from common audit policies.** This location is where the common audit policy results in an audit record. The audit record can be generated anywhere in the multitenant environment—the root or the PDBs, depending on where the action really occurred. For example, the common audit policy `fga_pol` audits the `EXECUTE` privilege on the `DBMS_FGA` PL/SQL package, and if this action occurs in `PDB1`, then the audit record is generated in `PDB1` and not in the root. Hence, the audit record can be seen in `PDB1`.

You can query the `UNIFIED_AUDIT_TRAIL` data dictionary view for the policy from either the root or a PDB if you include a `WHERE` clause for the policy name (for example, `WHERE UNIFIED_AUDIT_POLICIES = 'FGA_POL'`).

The following example shows how to find the results of a common unified audit policy:

```
CONNECT c##sec_admin
Enter password: password
Connected.

SELECT DBID, ACTION_NAME, OBJECT_SCHEMA, OBJECT_NAME FROM
CDB_UNIFIED_AUDIT_TRAIL WHERE DBUSERNAME = 'c##hr_admin';
46892-1
```

DBID	ACTION_NAME	OBJECT_SCHEMA	OBJECT_NAME
653916017	UPDATE	HR	EMPLOYEES
653916018	UPDATE	HR	JOB_HISTORY
653916017	UPDATE	HR	JOBS

30.7 Extending Unified Auditing to Capture Custom Attributes

You can extend the unified audit trail to capture custom attributes by auditing application context values.

- [About Auditing Application Context Values](#)
In many cases, you may want to bring your custom attributes into the unified audit trail while auditing (for example, application attributes from the application session).
- [Configuring Application Context Audit Settings](#)
The `AUDIT` statement with the `CONTEXT` keyword configures auditing for application context values.
- [Disabling Application Context Audit Settings](#)
The `NOAUDIT` statement disables application context audit settings.

- [Example: Auditing Application Context Values in a Default Database](#)
The `AUDIT CONTEXT NAMESPACE` statement can audit application context values.
- [Example: Auditing Application Context Values from Oracle Label Security](#)
The `AUDIT CONTEXT NAMESPACE` statement can audit application context values from Oracle Label Security.
- [How Audited Application Contexts Appear in the Audit Trail](#)
The `UNIFIED_AUDIT_POLICIES` data dictionary view lists application context audit events.

30.7.1 About Auditing Application Context Values

In many cases, you may want to bring your custom attributes into the unified audit trail while auditing (for example, application attributes from the application session).

You can extend the unified audit trail to capture such custom attributes by auditing application context values. This feature enables you to capture any application context values set by the database applications, while executing the audited statement.

This feature enables you to capture any application context values set by the database applications, while executing the audited statement.

If you plan to audit Oracle Label Security, then this feature captures session label activity for the database audit trail. The audit trail records all the values retrieved for the specified context-attribute value pairs.

The application context audit setting or the audit policy have session static semantics. In other words, if a new policy is enabled for a user, then the subsequent user sessions will see an effect of this command. After the session is established, then the policies and contexts settings are loaded and the subsequent `AUDIT` statements have no effect on that session.

Note that the application context audit policy applies only to the current PDB.

Related Topics

- [Using Application Contexts to Retrieve User Information](#)
An application context stores user identification that can enable or prevent a user from accessing data in the database.
- [Auditing in a Multitenant Deployment](#)
You can create unified audit policies for individual PDBs and in the root.
- [Oracle Label Security Administrator's Guide](#)

30.7.2 Configuring Application Context Audit Settings

The `AUDIT` statement with the `CONTEXT` keyword configures auditing for application context values.

You do not create an unified audit policy for this type of auditing.

- Use the following syntax to configure auditing for application context values:

```
AUDIT CONTEXT NAMESPACE context_name1 ATTRIBUTES attribute1 [, attribute2]
  [, CONTEXT NAMESPACE context_name2 ATTRIBUTES attribute1 [, attribute2]]
  [BY user_list];
```

In this specification:

- `context_name1`: Optionally, you can include one additional `CONTEXT` name-attribute value pair.

- *user_list* is an optional list of database user accounts. Separate multiple names with a comma. If you omit this setting, then Oracle Database configures the application context policy for all users. When each user logs in, a list of all pertinent application contexts and their attributes is cached for the user session.

For example:

```
AUDIT CONTEXT NAMESPACE clientcontext3 ATTRIBUTES module, action,
CONTEXT NAMESPACE ols_session_labels ATTRIBUTES ols_pol1, ols_pol3
BY appuser1, appuser2;
```

To find a list of currently configured application context audit settings, query the `AUDIT_UNIFIED_CONTEXTS` data dictionary view.

30.7.3 Disabling Application Context Audit Settings

The `NOAUDIT` statement disables application context audit settings.

- To disable an application context audit setting, specify the namespace and attribute settings in the `NOAUDIT` statement. You can enter the attributes in any order (that is, they do not need to match the order used in the corresponding `AUDIT CONTEXT` statement.)

For example:

```
NOAUDIT CONTEXT NAMESPACE client_context ATTRIBUTES module,
CONTEXT NAMESPACE ols_session_labels ATTRIBUTES ols_pol1, ols_pol3
BY USERS WITH GRANTED ROLES emp_admin;
```

To find the currently audited application contexts, query the `AUDIT_UNIFIED_CONTEXTS` data dictionary view.

30.7.4 Example: Auditing Application Context Values in a Default Database

The `AUDIT CONTEXT NAMESPACE` statement can audit application context values.

[Example 30-23](#) shows how to audit the `clientcontext` application values for the `module` and `action` attributes, by the user `appuser1`.

Example 30-23 Auditing Application Context Values in a Default Database

```
AUDIT CONTEXT NAMESPACE clientcontext ATTRIBUTES module, action
BY appuser1;
```

30.7.5 Example: Auditing Application Context Values from Oracle Label Security

The `AUDIT CONTEXT NAMESPACE` statement can audit application context values from Oracle Label Security.

[Example 30-24](#) shows how to audit an application context for Oracle Label Security called `ORA_OLS_SESSION_LABELS`, for the attributes `ols_pol1` and `ols_pol2`.

Example 30-24 Auditing Application Context Values from Oracle Label Security

```
AUDIT CONTEXT NAMESPACE ORA_OLS_SESSION_LABELS ATTRIBUTES ols_pol1, ols_pol2;
```

30.7.6 How Audited Application Contexts Appear in the Audit Trail

The `UNIFIED_AUDIT_POLICIES` data dictionary view lists application context audit events.

The `APPLICATION_CONTEXTS` column of the `UNIFIED_AUDIT_TRAIL` data dictionary view shows application context audit data. The application contexts appear as a list of semi-colon separated values.

For example:

```
SELECT APPLICATION_CONTEXTS FROM UNIFIED_AUDIT_TRAIL
WHERE UNIFIED_AUDIT_POLICIES = 'app_audit_pol';

APPLICATION_CONTEXTS
-----
CLIENT_CONTEXT.APPROLE=MANAGER;E2E_CONTEXT.USERNAME=PSMITH
```

30.8 Auditing Components of Other Oracle Products and Features

You can create unified audit policies for Oracle products and features such as Oracle Database Vault, Oracle Real Application Security, Oracle Data Pump, and Oracle Machine Learning for SQL events.

- [Auditing Oracle SQL Firewall](#)
You can audit Oracle SQL Firewall violations with a unified audit policy.
- [Auditing Oracle Database Vault Events](#)
In an Oracle Database Vault environment, the `CREATE AUDIT POLICY` statement can audit Database Vault activities.
- [Auditing Oracle Database Real Application Security Events](#)
You can use `CREATE AUDIT POLICY` statement to audit Oracle Database Real Application Security events.
- [Auditing Oracle Recovery Manager Events](#)
You can use the `CREATE AUDIT POLICY` statement to audit Oracle Recovery Manager events.
- [Auditing Oracle Label Security Events](#)
In an Oracle Label Security environment, the `CREATE AUDIT POLICY` statement can audit Oracle Label Security activities.
- [Auditing Oracle Data Pump Events](#)
You can use the `CREATE AUDIT POLICY` statement to audit Oracle Data Pump.
- [Auditing Oracle SQL*Loader Direct Load Path Events](#)
You can use the `CREATE AUDIT POLICY` statement to audit Oracle SQL*Loader direct load path events.
- [Auditing Oracle XML DB HTTP and FTP Protocols](#)
You can use the `CREATE AUDIT POLICY` statement to audit Oracle XML DB HTTP and FTP protocol messages.
- [Auditing Oracle Machine Learning for SQL Events](#)
You can use the `CREATE AUDIT POLICY` statement to audit Oracle Machine Learning for SQL events.

30.8.1 Auditing Oracle SQL Firewall

You can audit Oracle SQL Firewall violations with a unified audit policy.

- [About Auditing Oracle SQL Firewall](#)
The occurrence of Oracle SQL Firewall violations potentially indicates abnormal database access attempts, including SQL injection and credential theft or abuse.
- [Example: Auditing Oracle SQL Firewall Violations](#)
You can use the `COMPONENT` clause to set the unified audit policy to track all Oracle SQL Firewall violations.
- [How Oracle SQL Firewall Events Appear in the Audit Trail](#)
The `UNIFIED_AUDIT_TRAIL` data dictionary view lists Oracle SQL Firewall audit events.

30.8.1.1 About Auditing Oracle SQL Firewall

The occurrence of Oracle SQL Firewall violations potentially indicates abnormal database access attempts, including SQL injection and credential theft or abuse.

Auditing violations record the violation in the database audit trail, which can be protected from tampering. As an administrator with `AUDIT_ADMIN` role, you can create unified audit policy with the `CREATE AUDIT POLICY` statement and with the `COMPONENT` clause set to `SQL Firewall`.

The data dictionary views for SQL Firewall begin with the name `DBA_SQL_FIREWALL_`. The columns `FW_ACTION_NAME` and `FW_RETURN_CODE` in the `UNIFIED_AUDIT_TRAIL` data dictionary view stores the relevant information on Oracle SQL Firewall violations.

Related Topics

-

30.8.1.2 Example: Auditing Oracle SQL Firewall Violations

You can use the `COMPONENT` clause to set the unified audit policy to track all Oracle SQL Firewall violations.

[Example 30-25](#) shows how to create and enable this type of a unified audit policy. You can consider setting the `SQL_FIREWALL` component to `SQL VIOLATION` or `CONTEXT VIOLATION` to be more specific.

Example 30-25 Auditing SQL Firewall Violations

```
CREATE AUDIT POLICY sql_firewall_pol
ACTIONS COMPONENT = SQL_FIREWALL ALL
ON pfitch;
```

```
AUDIT POLICY sql_firewall_pol;
```

30.8.1.3 How Oracle SQL Firewall Events Appear in the Audit Trail

The `UNIFIED_AUDIT_TRAIL` data dictionary view lists Oracle SQL Firewall audit events.

The `FW_ACTION_NAME` and `FW_RETURN_CODE` columns of the `UNIFIED_AUDIT_TRAIL` data dictionary view track SQL Firewall violations. To retrieve all the audited Oracle SQL Firewall

violations, consider filtering the `AUDIT_TYPE` component to include the Oracle SQL Firewall component from `V$UNIFIED_AUDIT_RECORD_FORMAT`. For example:

```
SELECT DBUSERNAME, ACTION_NAME, CURRENT_USER, SQL_TEXT,
UNIFIED_AUDIT_POLICIES, FW_ACTION_NAME, FW_RETURN_CODE
FROM UNIFIED_AUDIT_TRAIL
WHERE AUDIT_TYPE
IN (SELECT UNIQUE COMPONENT FROM V$UNIFIED_AUDIT_RECORD_FORMAT WHERE
COMPONENT = 'SQL Firewall')
AND ACTION_NAME <> 'FW ADMIN ACTION';
```

Output similar to the following appears:

```
DBUSERNAME ACTION_NAME    CURRENT_USER SQL_TEXT
UNIFIED_AUDIT_POLICIES FW_ACTION_NAME FW_RETURN_CODE
-----
PFITCH      SQL VIOLATION PFITCH      SELECT SALARY FROM HS.EMPLOYEES
HR_FW_POL          SQL Violation 0
```

30.8.2 Auditing Oracle Database Vault Events

In an Oracle Database Vault environment, the `CREATE AUDIT POLICY` statement can audit Database Vault activities.

- [About Auditing Oracle Database Vault Events](#)
As an administrator with the `AUDIT_ADMIN` role, you can create unified audit policies with the `CREATE AUDIT POLICY` statement and with the `COMPONENT` clause set to `DV`.
- [Who Is Audited in Oracle Database Vault?](#)
Audited Oracle Database Vault users include administrators and users whose activities affect Database Vault enforcement policies.
- [About Oracle Database Vault Unified Audit Trail Events](#)
The audit trail in an Oracle Database Vault environment captures all configuration changes or attempts at changes to Database Vault policies.
- [Oracle Database Vault Realm Audit Events](#)
The unified audit trail captures Oracle Database Vault realm events.
- [Oracle Database Vault Rule Set and Rule Audit Events](#)
The unified audit trail can capture Oracle Database Vault rule set and rule audit events.
- [Oracle Database Vault Command Rule Audit Events](#)
The unified audit trail can capture Oracle Database Vault command rule audit events.
- [Oracle Database Vault Factor Audit Events](#)
The unified audit trail can capture Oracle Database Vault factor events.
- [Oracle Database Vault Secure Application Role Audit Events](#)
The unified audit trail can capture Oracle Database Vault secure application role audit events.
- [Oracle Database Vault Oracle Label Security Audit Events](#)
The unified audit trail can capture Oracle Database Vault Oracle Label Security audit events.
- [Oracle Database Vault Oracle Data Pump Audit Events](#)
The unified audit trail can capture Oracle Database Vault Oracle Data Pump audit events.

- [Oracle Database Vault Enable and Disable Audit Events](#)
The unified audit trail can capture Oracle Database Vault enable and disable audit events.
- [Configuring a Unified Audit Policy for Oracle Database Vault](#)
The `ACTIONS` and `ACTIONS COMPONENT` clauses in the `CREATE AUDIT POLICY` statement can create unified audit policies for Oracle Database Vault events.
- [Example: Auditing an Oracle Database Vault Realm](#)
The `CREATE AUDIT POLICY` statement can audit Oracle Database Vault realms.
- [Example: Auditing an Oracle Database Vault Rule Set](#)
The `CREATE AUDIT POLICY` statement can audit Oracle Database Vault rule sets.
- [Example: Auditing Two Oracle Database Vault Events](#)
The `CREATE AUDIT POLICY` statement can audit multiple Oracle Database Vault events.
- [Example: Auditing Oracle Database Vault Factors](#)
The `CREATE AUDIT POLICY` statement can audit Oracle Database Vault factors.
- [How Oracle Database Vault Audited Events Appear in the Audit Trail](#)
The `UNIFIED_AUDIT_TRAIL` data dictionary view lists Oracle Database Vault audited events.

30.8.2.1 About Auditing Oracle Database Vault Events

As an administrator with the `AUDIT_ADMIN` role, you can create unified audit policies with the `CREATE AUDIT POLICY` statement and with the `COMPONENT` clause set to `DV`.

To do so, you must specify an action, such as `Rule Set Failure`, and an object, such as the name of a rule set.

To create Oracle Database Vault unified audit policies, you must set the `CREATE AUDIT POLICY` statement's `COMPONENT` clause to `DV`, and then specify an action, such as `Rule Set Failure`, and an object, such as the name of a rule set.

To access the audit trail, you can query the following views:

- `UNIFIED_AUDIT_TRAIL`
- `AUDSYS.DV$CONFIGURATION_AUDIT`
- `AUDSYS.DV$ENFORCEMENT_AUDIT`

In the `UNIFIED_AUDIT_TRAIL` view, the Oracle Database Vault-specific columns begin with `DV_`. You must have the `AUDIT_VIEWER` role before you can query the `UNIFIED_AUDIT_TRAIL` view.

In addition to these views, the Database Vault reports capture the results of Database Vault-specific unified audit policies.

Related Topics

- [Oracle Database Vault Predefined Unified Audit Policy for `DVSY` and `LBACSYS` Schemas](#)
The `ORA_DV_SCHEMA_CHANGES` (previously called `ORA_DV_AUDPOL`) predefined unified audit policy audits Oracle Database Vault `DVSY` and `LBACSYS` schema objects.
- *Oracle Database Vault Administrator's Guide*

30.8.2.2 Who Is Audited in Oracle Database Vault?

Audited Oracle Database Vault users include administrators and users whose activities affect Database Vault enforcement policies.

These users are as follows:

- **Database Vault administrators.** All configuration changes that are made to Oracle Database Vault are mandatorily audited. The auditing captures activities such as creating, modifying, or deleting realms, factors, command rules, rule sets, rules, and so on. The `AUDSYS.DV$CONFIGURATION_AUDIT` data dictionary view captures configuration changes made by Database Vault administrators.
- **Users whose activities affect Oracle Database Vault enforcement policies.** The `AUDSYS.DV$ENFORCEMENT_AUDIT` data dictionary view captures enforcement-related audits

30.8.2.3 About Oracle Database Vault Unified Audit Trail Events

The audit trail in an Oracle Database Vault environment captures all configuration changes or attempts at changes to Database Vault policies.

It also captures violations by users to existing Database Vault policies.

You can audit the following kinds of Oracle Database Vault events:

- **All configuration changes or attempts at changes to Oracle Database Vault policies.** It captures both Database Vault administrator changes and attempts made by unauthorized users.
- **Violations by users to existing Database Vault policies.** For example, if you create a policy to prevent users from accessing a specific schema table during non-work hours, the audit trail will capture this activity.

30.8.2.4 Oracle Database Vault Realm Audit Events

The unified audit trail captures Oracle Database Vault realm events.

[Table 30-5](#) describes these events.

Table 30-5 Oracle Database Vault Realm Audit Events

Audit Event	Description
CREATE_REALM	Creates a realm through the <code>DVSYSD.BMS_MACADM.CREATE_REALM</code> procedure
UPDATE_REALM	Updates a realm through the <code>DVSYSD.BMS_MACADM.UPDATE_REALM</code> procedure
RENAME_REALM	Renames a realm through the <code>DVSYSD.BMS_MACADM.RENAME_REALM</code> procedure
DELETE_REALM	Deletes a realm through the <code>DVSYSD.BMS_MACADM.DELETE_REALM</code> procedure
DELETE_REALM_CASCADE	Deletes a realm and its related Database Vault configuration information through the <code>DVSYSD.BMS_MACADM.DELETE_REALM_CASCADE</code> procedure
ADD_AUTH_TO_REALM	Adds an authorization to the realm through the <code>DVSYSD.BMS_MACADM.ADD_AUTH_TO_REALM</code> procedure
DELETE_AUTH_FROM_REALM	Removes an authorization from the realm through the <code>DVSYSD.BMS_MACADM.DELETE_AUTH_FROM_REALM</code> procedure

Table 30-5 (Cont.) Oracle Database Vault Realm Audit Events

Audit Event	Description
UPDATE_REALM_AUTH	Updates a realm authorization through the DVSYS.DBMS_MACADM.UPDATE_REALM_AUTHORIZATION procedure
ADD_OBJECT_TO_REALM	Adds an object to a realm authorization through the DVSYS.DBMS_MACADM.ADD_AUTH_TO_REALM procedure
DELETE_OBJECT_FROM_REALM	Removes an object from a realm authorization through the DVSYS.DBMS_MACADM.DELETE_OBJECT_FROM_REALM procedure

30.8.2.5 Oracle Database Vault Rule Set and Rule Audit Events

The unified audit trail can capture Oracle Database Vault rule set and rule audit events.

[Table 30-6](#) describes these events.

Table 30-6 Oracle Database Vault Rule Set and Rule Audit Events

Audit Event	Description
CREATE_RULE_SET	Creates a rule set through the DVSYS.DBMS_MACADM.CREATE_RULE_SET procedure
UPDATE_RULE_SET	Updates a rule set through the DVSYS.DBMS_MACADM.UPDATE_RULE_SET procedure
RENAME_RULE_SET	Renames a rule set through the DVSYS.DBMS_MACADM.RENAME_RULE_SET procedure
DELETE_RULE_SET	Deletes a rule set through the DVSYS.DBMS_MACADM.DELETE_RULE_SET procedure
ADD_RULE_TO_RULE_SET	Adds a rule to an existing rule set through the DVSYS.DBMS_MACADM.ADD_RULE_TO_RULE_SET procedure
DELETE_RULE_FROM_RULE_SET	Removes a rule from an existing rule set through the DVSYS.DBMS_MACADM.DELETE_RULE_FROM_RULE_SET procedure
CREATE_RULE	Creates a rule through the DVSYS.DBMS_MACADM.CREATE_RULE procedure
UPDATE_RULE	Updates a rule through the DVSYS.DBMS_MACADM.UPDATE_RULE procedure
RENAME_RULE	Renames a rule through the DVSYS.DBMS_MACADM.RENAME_RULE procedure
DELETE_RULE	Deletes a rule through the DVSYS.DBMS_MACADM.DELETE_RULE procedure
SYNC_RULES	Synchronizes the rules in Oracle Database Vault and Advanced Queuing Rules engine through the DVSYS.DBMS_MACADM.SYNC_RULES procedure

30.8.2.6 Oracle Database Vault Command Rule Audit Events

The unified audit trail can capture Oracle Database Vault command rule audit events.

[Table 30-7](#) describes these events.

Table 30-7 Oracle Database Vault Command Rule Audit Events

Audit Event	Description
CREATE_COMMAND_RULE	Creates a command rule through the <code>DVSYS.DBMS_MACADM.CREATE_COMMAND_RULE</code> procedure
DELETE_COMMAND_RULE	Deletes a command rule through the <code>DVSYS.DBMS_MACADM.DELETE_COMMAND_RULE</code> procedure
UPDATE_COMMAND_RULE	Updates a command rule through the <code>DVSYS.DBMS_MACADM.UPDATE_COMMAND_RULE</code> procedure

30.8.2.7 Oracle Database Vault Factor Audit Events

The unified audit trail can capture Oracle Database Vault factor events.

[Table 30-8](#) describes these events.

Table 30-8 Oracle Database Vault Factor Audit Events

Audit Event	Description
CREATE_FACTOR_TYPE	Creates a factor type through the <code>DVSYS.DBMS_MACADM.CREATE_FACTOR_TYPE</code> procedure
DELETE_FACTOR_TYPE	Deletes a factor type through the <code>DVSYS.DBMS_MACADM.DELETE_FACTOR_TYPE</code> procedure
UPDATE_FACTOR_TYPE	Updates a factor type through the <code>DVSYS.DBMS_MACADM.UPDATE_FACTOR_TYPE</code> procedure
RENAME_FACTOR_TYPE	Renames a factor type through the <code>DVSYS.DBMS_MACADM.RENAME_FACTOR_TYPE</code> procedure
CREATE_FACTOR	Creates a factor through the <code>DVSYS.DBMS_MACADM.CREATE_FACTOR</code> procedure
UPDATE_FACTOR	Updates a factor through the <code>DVSYS.DBMS_MACADM.UPDATE_FACTOR</code> procedure
DELETE_FACTOR	Deletes a factor through the <code>DVSYS.DBMS_MACADM.DELETE_FACTOR</code> procedure
RENAME_FACTOR	Renames a factor through the <code>DVSYS.DBMS_MACADM.RENAME_FACTOR</code> procedure
ADD_FACTOR_LINK	Specifies a parent-child relationship between two factors through the <code>DVSYS.DBMS_MACADM.ADD_FACTOR_LINK</code> procedure
DELETE_FACTOR_LINK	Removes the parent-child relationship between two factors through the <code>DVSYS.DBMS_MACADM.DELETE_FACTOR_LINK</code> procedure

Table 30-8 (Cont.) Oracle Database Vault Factor Audit Events

Audit Event	Description
ADD_POLICY_FACTOR	Specifies that the label for a factor contributes to the Oracle Label Security label for a policy, through the DVSYS.DBMS_MACADM.ADD_POLICY_FACTOR procedure
DELETE_POLICY_FACTOR	Removes factor label from being associated with an Oracle Label Security label for a policy, through the DBMS_MACADM.DELETE_POLICY_FACTOR procedure
CREATE_IDENTITY	Creates a factor identity through the DVSYS.DBMS_MACADM.CREATE_IDENTITY procedure
UPDATE_IDENTITY	Updates a factor identity through the DVSYS.DBMS_MACADM.UPDATE_IDENTITY procedure
CHANGE_IDENTITY_FACTOR	Associates an identity with a different factor through the DVSYS.DBMS_MACADM.CHANGE_IDENTITY_FACTOR procedure
CHANGE_IDENTITY_VALUE	Updates the value of an identity through the DVSYS.DBMS_MACADM.CHANGE_IDENTITY_VALUE procedure
DELETE_IDENTITY	Deletes an existing factor identity through the DVSYS.DBMS_MACADM.DELETE_IDENTITY procedure
CREATE_IDENTITY_MAP	Creates a factor identity map through the DVSYS.DBMS_MACADM.CREATE_IDENTITY_MAP procedure
DELETE_IDENTITY_MAP	Deletes a factor identity map through the DVSYS.DBMS_MACADM.DELETE_IDENTITY_MAP procedure
CREATE_DOMAIN_IDENTITY	Adds an Oracle Database Real Application Clusters database node to the domain factor identities and labels it according to the Oracle Label Security policy, through the DVSYS.DBMS_MACADM.CREATE_DOMAIN_IDENTITY procedure
DROP_DOMAIN_IDENTITY	Drops an Oracle RAC node from the domain factor identities through the DVSYS.DBMS_MACADM.DROP_DOMAIN_IDENTITY procedure

30.8.2.8 Oracle Database Vault Secure Application Role Audit Events

The unified audit trail can capture Oracle Database Vault secure application role audit events.

[Table 30-9](#) describes these events.

Table 30-9 Oracle Database Vault Secure Application Role Audit Events

Audit Event	Description
CREATE_ROLE	Creates an Oracle Database Vault secure application role through the DVSYS.DBMS_MACADM.CREATE_ROLE procedure

Table 30-9 (Cont.) Oracle Database Vault Secure Application Role Audit Events

Audit Event	Description
DELETE_ROLE	Deletes an Oracle Database Vault secure application role through the <code>DVSYS.DBMS_MACADM.DELETE_ROLE</code> procedure
UPDATE_ROLE	Updates an Oracle Database Vault secure application role through the <code>DVSYS.DBMS_MACADM.UPDATE_ROLE</code> procedure
RENAME_ROLE	Renames an Oracle Database Vault secure application role through the <code>DVSYS.DBMS_MACADM.RENAME_ROLE</code> procedure

30.8.2.9 Oracle Database Vault Oracle Label Security Audit Events

The unified audit trail can capture Oracle Database Vault Oracle Label Security audit events.

[Table 30-10](#) describes these events.

Table 30-10 Oracle Database Vault Oracle Label Security Audit Events

Audit Event	Description
CREATE_POLICY_LABEL	Creates an Oracle Label Security policy label through the <code>DVSYS.DBMS_MACADM.CREATE_POLICY_LABEL</code> procedure
DELETE_POLICY_LABEL	Deletes an Oracle Label Security policy label through the <code>DVSYS.DBMS_MACADM.DELETE_POLICY_LABEL</code> procedure
CREATE_MAC_POLICY	Specifies the algorithm that is used to merge labels when computing the label for a factor, or the Oracle Label Security Session label, through the <code>DVSYS.DBMS_MACADM.CREATE_MAC_POLICY</code> procedure
UPDATE_MAC_POLICY	Changes the Oracle Label Security merge label algorithm through the <code>DVSYS.DBMS_MACADM.UPDATE_MAC_POLICY</code> procedure
DELETE_MAC_POLICY_CASCADE	Deletes all Oracle Database Vault objects related to an Oracle Label Security policy, through the <code>DVSYS.DBMS_MACADM.DELETE_MAC_POLICY_CASCADE</code> procedure

30.8.2.10 Oracle Database Vault Oracle Data Pump Audit Events

The unified audit trail can capture Oracle Database Vault Oracle Data Pump audit events.

[Table 30-11](#) describes these events.

Table 30-11 Oracle Database Vault Oracle Data Pump Audit Events

Audit Event	Description
AUTHORIZE_DATAPUMP_USER	Authorizes an Oracle Data Pump user through the <code>DVSYS.DBMS_MACADM.AUTHORIZE_DATAPUMP_USER</code> procedure
UNAUTHORIZE_DATAPUMP_USER	Removes from authorization an Oracle Data Pump user through the <code>DVSYS.DBMS_MACADM.UNAUTHORIZE_DATAPUMP_USER</code> procedure

30.8.2.11 Oracle Database Vault Enable and Disable Audit Events

The unified audit trail can capture Oracle Database Vault enable and disable audit events.

[Table 30-12](#) describes these events.

Table 30-12 Oracle Database Vault Enable and Disable Audit Events

Event	Description
ENABLE_EVENT	<code>DBMS_MACADM.ENABLE_EVENT</code>
DISABLE_EVENT	<code>DBMS_MACADM.DISABLE_EVENT</code>

30.8.2.12 Configuring a Unified Audit Policy for Oracle Database Vault

The `ACTIONS` and `ACTIONS COMPONENT` clauses in the `CREATE AUDIT POLICY` statement can create unified audit policies for Oracle Database Vault events.

- Use the following syntax to create an Oracle Database Vault unified audit policy:

```
CREATE AUDIT POLICY policy_name
  ACTIONS COMPONENT= DV DV_action ON DV_object [,DV_action2 ON DV_object2]
```

In this specification:

- DV_action* is one of the following:
 - Realm-related actions:
 - `Realm Violation` audits realm violations (for example, when an unauthorized user attempts to access a realm-protected object).
 - `Realm Success` audits when a realm-protected object is successfully accessed by an authorized user.
 - `Realm Access` audits both realm violation and realm success cases, that is, audits whenever the realm access attempt has been made, whether the access succeeded or failed.
 - Rule set-related actions: `Rule Set Failure`, `Rule Set Success`, `Rule Set Eval`
 - Factor-related actions: `Factor Error`, `Factor Null`, `Factor Validate Error`, `Factor Validate False`, `Factor Trust Level Null`, `Factor Trust Level Neg`, `Factor All`
- DV_objects* is one of the following:
 - `Realm_Name`

- *Rule_Set_Name*
- *Factor_Name*

If the object was created in lower or mixed case, then you must enclose *DV_objects* in double quotation marks. If you had created the object in all capital letters, then you can omit the quotation marks.

For example, to audit realm violations on the Database Vault Account Management realm:

```
CREATE AUDIT POLICY audit_dv
  ACTIONS COMPONENT=DV Realm Violation ON "Database Vault Account Management";
```

Remember that after you create the policy, you must use the `AUDIT` statement to enable it.

30.8.2.13 Example: Auditing an Oracle Database Vault Realm

The `CREATE AUDIT POLICY` statement can audit Oracle Database Vault realms.

[Example 30-26](#) shows how to audit a realm violation on the HR schema.

Example 30-26 Auditing a Realm Violation

```
CREATE AUDIT POLICY dv_realm_hr
  ACTIONS COMPONENT=DV Realm Violation ON "HR Schema Realm";

AUDIT POLICY dv_realm_hr;
```

30.8.2.14 Example: Auditing an Oracle Database Vault Rule Set

The `CREATE AUDIT POLICY` statement can audit Oracle Database Vault rule sets.

[Example: Auditing an Oracle Database Vault Rule Set](#) shows how to audit the Can Maintain Accounts/Profile rule set.

Example 30-27 Auditing a Rule Set

```
CREATE AUDIT POLICY dv_rule_set_accts
  ACTIONS COMPONENT=DV RULE SET FAILURE ON "Can Maintain Accounts/Profile";

AUDIT POLICY dv_rule_set_accts;
```

30.8.2.15 Example: Auditing Two Oracle Database Vault Events

The `CREATE AUDIT POLICY` statement can audit multiple Oracle Database Vault events.

[Example 30-28](#) shows how to audit a realm violation and a rule set failure.

Example 30-28 Auditing Two Oracle Database Vault Events

```
CREATE AUDIT POLICY audit_dv
  ACTIONS COMPONENT=DV REALM VIOLATION ON "Oracle Enterprise Manager", Rule Set
  Failure ON "Allow Sessions";

AUDIT POLICY audit_dv;
```

30.8.2.16 Example: Auditing Oracle Database Vault Factors

The `CREATE AUDIT POLICY` statement can audit Oracle Database Vault factors.

[Example 30-29](#) shows how to audit two types of errors for one factor.

Example 30-29 Auditing Oracle Database Vault Factor Settings

```
CREATE AUDIT POLICY audit_dv_factor
  ACTIONS COMPONENT=DV FACTOR ERROR ON "Database_Domain", Factor Validate Error ON
  "Client_IP";

AUDIT POLICY audit_dv_factor;
```

30.8.2.17 How Oracle Database Vault Audited Events Appear in the Audit Trail

The UNIFIED_AUDIT_TRAIL data dictionary view lists Oracle Database Vault audited events.

The DV_* columns of the UNIFIED_AUDIT_TRAIL view show Oracle Database Vault-specific audit data.

For example:

```
SELECT DBUSERNAME, SQL_TEXT, UNIFIED_AUDIT_POLICIES, DV_ACTION_NAME,
DV_ACTION_OBJECT_NAME, DV_RULE_SET_NAME
FROM UNIFIED_AUDIT_TRAIL
WHERE AUDIT_TYPE = 'DATABASE VAULT'
ORDER BY EVENT_TIMESTAMP;
```

DBUSERNAME	SQL_TEXT	UNIFIED_AUDIT_POLICIES	DV_ACTION_NAME
PFITCH	SELECT * FROM HR.EMPLOYEES	DV_AUDIT_POLICY	Command Failure Audit
SELECT	HR_data_protection		

30.8.3 Auditing Oracle Database Real Application Security Events

You can use CREATE AUDIT POLICY statement to audit Oracle Database Real Application Security events.

- [About Auditing Oracle Database Real Application Security Events](#)
You must have the AUDIT_ADMIN role to audit Oracle Database Real Application Security events.
- [Oracle Database Real Application Security Auditable Events](#)
Oracle Database provides Real Application Security events that you can audit, such CREATE USER, UPDATE USER.
- [Oracle Database Real Application Security User, Privilege, and Role Audit Events](#)
The unified audit trail can capture Oracle Database Real Application Security events for users, privileges, and roles.
- [Oracle Database Real Application Security Security Class and ACL Audit Events](#)
The unified audit trail can capture Oracle Database Real Application Security security class and ACL audit events.
- [Oracle Database Real Application Security Session Audit Events](#)
The unified audit trail can capture Oracle Database Real Application Security session audit events.
- [Oracle Database Real Application Security ALL Events](#)
The unified audit trail can capture Oracle Database Real Application Security ALL events.
- [Configuring a Unified Audit Policy for Oracle Database Real Application Security](#)
The CREATE AUDIT POLICY statement can create a unified audit policy for Oracle Real Application Security.

- [Example: Auditing Real Application Security User Account Modifications](#)
The `CREATE AUDIT POLICY` statement can audit Real Application Security user account modifications.
- [Example: Using a Condition in a Real Application Security Unified Audit Policy](#)
The `CREATE AUDIT POLICY` statement can set a condition for a Real Application Security unified audit policy.
- [How Oracle Database Real Application Security Events Appear in the Audit Trail](#)
The `DBA_XS_AUDIT_TRAIL` data dictionary view lists Oracle Real Application Security audit events.

30.8.3.1 About Auditing Oracle Database Real Application Security Events

You must have the `AUDIT_ADMIN` role to audit Oracle Database Real Application Security events.

To access the audit trail, you can query the `UNIFIED_AUDIT_TRAIL` data dictionary view, whose Real Application Security-specific columns begin with `XS_`. If you want to find audit information about the internally generated VPD predicate that is created while an Oracle Real Application Security policy is being enabled, then you can query the `RLS_INFO` column.

Real Application Security-specific views are as follows:

- `DBA_XS_AUDIT_TRAIL` provides detailed information about Real Application Security events that were audited.
- `DBA_XS_AUDIT_POLICY_OPTIONS` describes the auditing options that were defined for Real Application Security unified audit policies.
- `DBA_XS_ENB_AUDIT_POLICIES` lists users for whom Real Application Security unified audit policies are enabled.

Related Topics

- [Extending Unified Auditing to Capture Custom Attributes](#)
You can extend the unified audit trail to capture custom attributes by auditing application context values.
- [Oracle Database Real Application Security Predefined Audit Policies](#)
You can use predefined unified audit policies for Oracle Database Real Application Security events.
- [Auditing of Oracle Virtual Private Database Predicates](#)
The unified audit trail automatically captures the predicates that are used in Oracle Virtual Private Database (VPD) policies.
- *Oracle Database Real Application Security Administrator's and Developer's Guide*

30.8.3.2 Oracle Database Real Application Security Auditable Events

Oracle Database provides Real Application Security events that you can audit, such `CREATE USER`, `UPDATE USER`.

To find a list of auditable Real Application Security events that you can audit, you can query the `COMPONENT` and `NAME` columns of the `AUDITABLE_SYSTEM_ACTIONS` data dictionary view, as follows:

```
SELECT NAME FROM AUDITABLE_SYSTEM_ACTIONS WHERE COMPONENT = 'XS';
```

```
NAME
```

```
-----
CREATE USER
UPDATE USER
DELETE USER
...
```

Related Topics

- [Oracle Database Real Application Security User, Privilege, and Role Audit Events](#)
The unified audit trail can capture Oracle Database Real Application Security events for users, privileges, and roles.
- [Oracle Database Real Application Security Security Class and ACL Audit Events](#)
The unified audit trail can capture Oracle Database Real Application Security security class and ACL audit events.
- [Oracle Database Real Application Security Session Audit Events](#)
The unified audit trail can capture Oracle Database Real Application Security session audit events.
- [Oracle Database Real Application Security ALL Events](#)
The unified audit trail can capture Oracle Database Real Application Security ALL events.

30.8.3.3 Oracle Database Real Application Security User, Privilege, and Role Audit Events

The unified audit trail can capture Oracle Database Real Application Security events for users, privileges, and roles.

[Table 30-13](#) describes these events.

Table 30-13 Oracle Database Real Application Security User, Privilege, and Role Audit Events

Audit Event	Description
CREATE USER	Creates an Oracle Database Real Application Security user account through the <code>XS_PRINCIPAL.CREATE_USER</code> procedure
UPDATE USER	Updates an Oracle Database Real Application Security user account through the following procedures: <ul style="list-style-type: none"> • <code>XS_PRINCIPAL.SET_EFFECTIVE_DATES</code> • <code>XS_PRINCIPAL.SET_USER_DEFAULT_ROLES_ALL</code> • <code>XS_PRINCIPAL.SET_USER_SCHEMA</code> • <code>XS_PRINCIPAL.SET_GUID</code> • <code>XS_PRINCIPAL.SET_USER_STATUS</code> • <code>XS_PRINCIPAL.SET_DESCRIPTION</code>
DELETE USER	Deletes an Oracle Database Real Application Security user account through the through the <code>XS_PRINCIPAL.DELETE_PRINCIPAL</code> procedure
AUDIT_GRANT_PRIVILEGE	Audits the <code>GRANT_SYSTEM_PRIVILEGE</code> privilege
AUDIT_REVOKE_PRIVILEGE	Audits the <code>REVOKE_SYSTEM_PRIVILEGE</code> privilege
CREATE ROLE	Creates an Oracle Database Real Application Security role through the <code>XS_PRINCIPAL.CREATE_ROLE</code> procedure

Table 30-13 (Cont.) Oracle Database Real Application Security User, Privilege, and Role Audit Events

Audit Event	Description
UPDATE ROLE	Updates an Oracle Database Real Application Security role through the following procedures: <ul style="list-style-type: none"> XS_PRINCIPAL.SET_DYNAMIC_ROLE_SCOPE XS_PRINCIPAL.SET_DYNAMIC_ROLE_DURATION XS_PRINCIPAL.SET_EFFECTIVE_DATES XS_PRINCIPAL.SET_ROLE_DEFAULT
DELETE ROLE	Deletes an Oracle Database Real Application Security role through the XS_PRINCIPAL.DELETE_ROLE procedure
GRANT ROLE	Grants Oracle Database Real Application Security roles through the XS_PRINCIPAL.GRANT_ROLES procedure
REVOKE ROLE	Revokes Oracle Database Real Application Security roles through the XS_PRINCIPAL.REVOKE_ROLES procedure and revokes all granted roles through the XS_PRINCIPAL.REVOKE_ALL_GRANTED_ROLES procedure
ADD PROXY	Adds Oracle Database Real Application Security proxy user account through the XS_PRINCIPAL.ADD_PROXY_USER procedure, and adds proxies to database users through the XS_PRINCIPAL.ADD_PROXY_TO_SCHEMA procedure
REMOVE PROXY	Removes an Oracle Database Real Application Security proxy user account through the XS_PRINCIPAL.REMOVE_PROXY_USER, XS_PRINCIPAL.REMOVE_ALL_PROXY_USERS, and XS_PRINCIPAL.REMOVE_PROXY_FROM_SCHEMA PROCEDURES
SET USER PASSWORD	Sets the Oracle Database Real Application Security user account password through the XS_PRINCIPAL.SET_PASSWORD procedure
SET USER VERIFIER	Sets the Oracle Database Real Application Security proxy user account verifier through the XS_PRINCIPAL.SET_VERIFIER procedure

30.8.3.4 Oracle Database Real Application Security Security Class and ACL Audit Events

The unified audit trail can capture Oracle Database Real Application Security security class and ACL audit events.

[Table 30-14](#) describes these events.

Table 30-14 Oracle Database Real Application Security Security Class and ACL Audit Events

Audit Event	Description
CREATE SECURITY CLASS	Creates a security class through the XS_SECURITY_CLASS.CREATE_SECURITY_CLASS procedure

Table 30-14 (Cont.) Oracle Database Real Application Security Security Class and ACL Audit Events

Audit Event	Description
UPDATE SECURITY CLASS	<p>Creates a security class through the following procedures:</p> <ul style="list-style-type: none"> XS_SECURITY_CLASS.SET_DEFAULT_ACL XS_SECURITY_CLASS.ADD_PARENTS XS_SECURITY_CLASS.REMOVE_ALL_PARENTS XS_SECURITY_CLASS.REMOVE_PARENTS XS_SECURITY_CLASS.ADD_PRIVILEGES XS_SECURITY_CLASS.REMOVE_ALL_PRIVILEGES XS_SECURITY_CLASS.ADD_IMPLIED_PRIVILEGES XS_SECURITY_CLASS.REMOVE_IMPLIED_PRIVILEGES XS_SECURITY_CLASS.REMOVE_ALL_IMPLIED_PRIVILEGES XS_SECURITY_CLASS.SET_DESCRIPTION
DELETE SECURITY CLASS	<p>Deletes a security class through the XS_SECURITY_CLASS.DELETE_SECURITY_CLASS procedure</p>
CREATE ACL	<p>Creates an Access Control List (ACL) through the XS_ACL.CREATE_ACL procedure</p>
UPDATE ACL	<p>Updates an ACL through the following procedures:</p> <ul style="list-style-type: none"> XS_ACL.APPEND_ACES XS_ACL.REMOVE_ALL_ACES XS_ACL.SET_SECURITY_CLASS XS_ACL.SET_PARENT_ACL XS_ACL.ADD_ACL_PARAMETER XS_ACL.REMOVE_ALL_ACL_PARAMETERS XS_ACL.REMOVE_ACL_PARAMETER XS_ACL.SET_DESCRIPTION
DELETE ACL	<p>Deletes an ACL through the XS_ACL.DELETE_ACL procedure</p>
CREATE DATA SECURITY-	<p>Creates a data security policy through the XS_DATA_SECURITY.CREATE_DATA_SECURITY procedure</p>
UPDATE DATA SECURITY	<p>Updates a data security policy through the following procedures:</p> <ul style="list-style-type: none"> XS_DATA_SECURITY.CREATE_ACL_PARAMETER XS_DATA_SECURITY.DELETE_ACL_PARAMETER XS_DATA_SECURITY.SET_DESCRIPTION
DELETE DATA SECURITY	<p>Deletes a data security policy through the XS_DATA_SECURITY.DELETE_DATA_SECURITY procedure</p>
ENABLE DATA SECURITY	<p>Enables extensible data security for a database table or view through the XS_DATA_SECURITY.ENABLE_OBJECT_POLICY procedure</p>
DISABLE DATA SECURITY	<p>Disables extensible data security for a database table or view through the XS_DATA_SECURITY.DISABLE_XDS procedure</p>

30.8.3.5 Oracle Database Real Application Security Session Audit Events

The unified audit trail can capture Oracle Database Real Application Security session audit events.

Table 30-13 describes these events.

Table 30-15 Oracle Database Real Application Security Session Audit Events

Audit Event	Description
CREATE SESSION	Creates a session through the DBMS_XS_SESSIONS.CREATE_SESSION procedure
DESTROY SESSION	Destroys a session through the DBMS_XS_SESSIONS.DESTROY_SESSION procedure
CREATE SESSION NAMESPACE	Creates a namespace through the DBMS_XS_SESSIONS.CREATE_NAMESPACE procedure
DELETE SESSION NAMESPACE	Deletes a namespace through the DBMS_XS_SESSIONS.DELETE_NAMESPACE procedure
CREATE NAMESPACE ATTRIBUTE	Creates a namespace attribute through the DBMS_XS_SESSIONS.CREATE_ATTRIBUTE procedure
SET NAMESPACE ATTRIBUTE	Sets a namespace attribute through the DBMS_XS_SESSIONS.SET_ATTRIBUTE procedure
GET NAMESPACE ATTRIBUTE	Gets a namespace attribute through the DBMS_XS_SESSIONS.GET_ATTRIBUTE procedure
DELETE NAMESPACE ATTRIBUTE	Deletes a namespace attribute through the DBMS_XS_SESSIONS.DELETE_ATTRIBUTE procedure
CREATE NAMESPACE TEMPLATE	Creates a namespace attribute through the XS_NS_TEMPLATE.CREATE_NS_TEMPLATE procedure
UPDATE NAMESPACE TEMPLATE	Updates a namespace attribute through the following procedures: <ul style="list-style-type: none"> • XS_NS_TEMPLATE.SET_HANDLER • XS_NS_TEMPLATE.ADD_ATTRIBUTES • XS_NS_TEMPLATE.REMOVE_ALL_ATTRIBUTES • XS_NS_TEMPLATE.REMOVE_ATTRIBUTES • XS_NS_TEMPLATE.SET_DESCRIPTION
DELETE NAMESPACE TEMPLATE	Deletes a namespace through the XS_NS_TEMPLATE.DELETE_NS_TEMPLATE procedure
ADD GLOBAL CALLBACK	Adds a global callback through the DBMS_XS_SESSIONS.ADD_GLOBAL_CALLBACK procedure
DELETE GLOBAL CALLBACK	Deletes a global callback through the DBMS_XS_SESSIONS.DELETE_GLOBAL_CALLBACK procedure
ENABLE GLOBAL CALLBACK	Enables a global callback through the DBMS_XS_SESSIONS.ENABLE_GLOBAL_CALLBACK procedure
SET COOKIE	Sets a session cookie through the DBMS_XS_SESSIONS.SET_SESSION_COOKIE procedure
SET INACTIVE TIMEOUT	Sets the time-out time for inactive sessions through the DBMS_XS_SESSIONS.SET_INACTIVITY_TIMEOUT procedure
SWITCH USER	Sets the security context of the current lightweight user session to a newly initialized security context for a specified user through the DBMS_XS_SESSIONS.SWITCH_USER procedure
ASSIGN USER	Assigns or removes one or more dynamic roles for the specified user through the DBMS_XS_SESSIONS.ASSIGN_USER procedure
ENABLE ROLE	Enable a role for a lightweight user session through the DBMS_XS_SESSIONS.ENABLE_ROLE procedure
DISABLE ROLE	Disables a role for a lightweight user session through the DBMS_XS_SESSIONS.DISABLE_ROLE procedure

30.8.3.6 Oracle Database Real Application Security ALL Events

The unified audit trail can capture Oracle Database Real Application Security ALL events.

[Table 30-16](#) describes these events.

Table 30-16 Oracle Database Real Application Security ALL Events

Audit Event	Description
ALL	Captures all Real Application Security actions

30.8.3.7 Configuring a Unified Audit Policy for Oracle Database Real Application Security

The `CREATE AUDIT POLICY` statement can create a unified audit policy for Oracle Real Application Security.

- Use the following syntax to create a unified audit policy for Oracle Database Real Application Security:

```
CREATE AUDIT POLICY policy_name
  ACTIONS COMPONENT=XS component_action1 [, action2];
```

For example:

```
CREATE AUDIT POLICY audit_ras_pol
  ACTIONS COMPONENT=XS SWITCH USER, DISABLE ROLE;
```

You can build more complex policies, such as those that include conditions. Remember that after you create the policy, you must use the `AUDIT` statement to enable it.

Related Topics

- [Syntax for Creating a Custom Unified Audit Policy](#)
To create a custom unified audit policy, you must use the `CREATE AUDIT POLICY` statement.

30.8.3.8 Example: Auditing Real Application Security User Account Modifications

The `CREATE AUDIT POLICY` statement can audit Real Application Security user account modifications.

[Example 30-30](#) shows how to audit user `bhurst`'s attempts to switch users and disable roles.

Example 30-30 Auditing Real Application Security User Account Modifications

```
CREATE AUDIT POLICY ras_users_pol
  ACTIONS COMPONENT=XS SWITCH USER, DISABLE ROLE;
```

```
AUDIT POLICY ras_users_pol BY bhurst;
```

30.8.3.9 Example: Using a Condition in a Real Application Security Unified Audit Policy

The `CREATE AUDIT POLICY` statement can set a condition for a Real Application Security unified audit policy.

[Example 30-31](#) shows how to create Real Application Security unified audit policy that applies the audit only to actions from the `nemosity` computer host.

Example 30-31 Using a Condition in a Real Application Security Unified Audit Policy

```
CREATE AUDIT POLICY ras_acl_pol
  ACTIONS DELETE ON OE.CUSTOMERS
  ACTIONS COMPONENT=XS CREATE ACL, UPDATE ACL, DELETE ACL
  WHEN 'SYS_CONTEXT(''USERENV'', 'HOST') = 'nemosity''
  EVALUATE PER INSTANCE;

AUDIT POLICY ras_acl_pol BY pfitch;
```

30.8.3.10 How Oracle Database Real Application Security Events Appear in the Audit Trail

The `DBA_XS_AUDIT_TRAIL` data dictionary view lists Oracle Real Application Security audit events.

The following example queries the Real Application Security-specific view, `DBA_XS_AUDIT_TRAIL`:

```
SELECT XS_USER_NAME FROM DBA_XS_AUDIT_TRAIL
WHERE XS_ENABLED_ROLE = 'CLERK';
```

```
XS_USER_NAME
-----
USER2
```

30.8.4 Auditing Oracle Recovery Manager Events

You can use the `CREATE AUDIT POLICY` statement to audit Oracle Recovery Manager events.

- [About Auditing Oracle Recovery Manager Events](#)
The `UNIFIED_AUDIT_TRAIL` data dictionary view automatically stores Oracle Recovery Manager audit events in the `RMAN_` column.
- [Oracle Recovery Manager Unified Audit Trail Events](#)
The unified audit trail can capture Oracle Recovery Manager events.
- [How Oracle Recovery Manager Audited Events Appear in the Audit Trail](#)
The `UNIFIED_AUDIT_TRAIL` data dictionary view lists Oracle Recovery Manager audit events.

30.8.4.1 About Auditing Oracle Recovery Manager Events

The `UNIFIED_AUDIT_TRAIL` data dictionary view automatically stores Oracle Recovery Manager audit events in the `RMAN_` column.

Unlike other Oracle Database components, you do not create a unified audit policy for Oracle Recovery Manager events.

However, you must have the `AUDIT_ADMIN` or `AUDIT_VIEWER` role in order to query the `UNIFIED_AUDIT_TRAIL` view to see these events. If you have the `SYSDBA` administrative privilege, then you can find additional information about Recovery Manager jobs by querying views such as `V$RMAN_STATUS` or `V$RMAN_BACKUP_JOB_DETAILS`.

Related Topics

- *Oracle Database Backup and Recovery User's Guide*

30.8.4.2 Oracle Recovery Manager Unified Audit Trail Events

The unified audit trail can capture Oracle Recovery Manager events.

[Table 30-17](#) describes these events.

Table 30-17 Oracle Recovery Manager Columns in UNIFIED_AUDIT_TRAIL View

Recovery Manager Column	Description
RMAN_SESSION_RECID	Recovery Manager session identifier. Together with the RMAN_SESSION_STAMP column, this column uniquely identifies the Recovery Manager job. The Recovery Manager session ID is a a RECID value in the control file that identifies the Recovery Manager job. (Note that the Recovery Manager session ID is not the same as a user session ID.)
RMAN_SESSION_STAMP	Timestamp for the session. Together with the RMAN_SESSION_RECID column, this column identifies Recovery Manager jobs.
RMAN_OPERATION	The Recovery Manager operation executed by the job. One row is added for each distinct operation within a Recovery Manager session. For example, a backup job contains BACKUP as the RMAN_OPERATION value.
RMAN_OBJECT_TYPE	Type of objects involved in a Recovery Manager session. It contains one of the following values. If the Recovery Manager session does not satisfy more than one of them, then preference is given in the following order, from top to bottom of the list. <ol style="list-style-type: none"> 1. DB FULL (Database Full) refers to a full backup of the database 2. RECVR AREA refers to the Fast Recovery area 3. DB INCR (Database Incremental) refers to incremental backups of the database 4. DATAFILE FULL refers to a full backup of the data files 5. DATAFILE INCR refers to incremental backups of the data files 6. ARCHIVELOG refers to archived redo log files 7. CONTROLFILE refers to control files 8. SPFILE refers to the server parameter file 9. BACKUPSET refers to backup files
RMAN_DEVICE_TYPE	Device associated with a Recovery Manager session. This column can be DISK, SBT (system backup tape), or * (asterisk). An asterisk indicates more than one device. In most cases, the value will be DISK and SBT.

30.8.4.3 How Oracle Recovery Manager Audited Events Appear in the Audit Trail

The UNIFIED_AUDIT_TRAIL data dictionary view lists Oracle Recovery Manager audit events.

[Table 30-17](#) lists the columns in the `UNIFIED_AUDIT_TRAIL` data dictionary view that you can query to find Oracle Recovery Manager-specific audit data.

For example:

```
SELECT RMAN_OPERATION FROM UNIFIED_AUDIT_TRAIL
WHERE RMAN_OBJECT_TYPE = 'DB FULL';
```

```
RMAN_OPERATION
-----
BACKUP
```

30.8.5 Auditing Oracle Label Security Events

In an Oracle Label Security environment, the `CREATE AUDIT POLICY` statement can audit Oracle Label Security activities.

- [About Auditing Oracle Label Security Events](#)
As with all unified auditing, you must have the `AUDIT_ADMIN` role before you can audit Oracle Label Security (OLS) events.
- [Oracle Label Security Unified Audit Trail Events](#)
The unified audit trail can capture Oracle Label Security audit events.
- [Oracle Label Security Auditable User Session Labels](#)
The `ORA_OLS_SESSION_LABELS` application context can capture user session label usage for each Oracle Database event.
- [Configuring a Unified Audit Policy for Oracle Label Security](#)
The `ACTIONS` and `ACTIONS COMPONENT` clauses in the `CREATE AUDIT POLICY` statement can be used to create Oracle Label Security event audit policies.
- [Example: Auditing Oracle Label Security Session Label Attributes](#)
The `AUDIT CONTEXT NAMESPACE` statement can audit Oracle Label Security session label attributes.
- [Example: Excluding a User from an Oracle Label Security Policy](#)
The `CREATE AUDIT POLICY` statement can exclude users from policies.
- [Example: Auditing Oracle Label Security Policy Actions](#)
The `CREATE AUDIT POLICY` statement can audit Oracle Label Security policy actions.
- [Example: Querying for Audited OLS Session Labels](#)
The `LBACSYS.ORA_GET_AUDITED_LABEL` function can be used in a `UNIFIED_AUDIT_TRAIL` query to find audited Oracle Label Security session labels.
- [How Oracle Label Security Audit Events Appear in the Audit Trail](#)
The `UNIFIED_AUDIT_TRAIL` data dictionary view lists Oracle Label Security audit events.

30.8.5.1 About Auditing Oracle Label Security Events

As with all unified auditing, you must have the `AUDIT_ADMIN` role before you can audit Oracle Label Security (OLS) events.

To create Oracle Label Security unified audit policies, you must set the `CREATE AUDIT POLICY` statement `COMPONENT` clause to `OLS`.

To audit user session label information, you use the `AUDIT` statement to audit application context values.

To access the audit trail, you can query the `UNIFIED_AUDIT_TRAIL` data dictionary view. This view contains Oracle Label Security-specific columns whose names begin with `OLS_`. If you want to find audit information about the internally generated VPD predicate that is created when you apply an Oracle Label Security policy to a table, then you can query the `RLS_INFO` column.

Related Topics

- [Auditing of Oracle Virtual Private Database Predicates](#)
The unified audit trail automatically captures the predicates that are used in Oracle Virtual Private Database (VPD) policies.
- *Oracle Label Security Administrator's Guide*

30.8.5.2 Oracle Label Security Unified Audit Trail Events

The unified audit trail can capture Oracle Label Security audit events.

To find a list of auditable Oracle Label Security events that you can audit, you can query the `COMPONENT` and `NAME` columns of the `AUDITABLE_SYSTEM_ACTIONS` data dictionary view.

For example:

```
SELECT NAME FROM AUDITABLE_SYSTEM_ACTIONS WHERE COMPONENT = 'Label Security';
```

```
NAME
-----
CREATE POLICY
ALTER POLICY
DROP POLICY
...
```

[Table 30-18](#) describes the Oracle Label Security audit events.

Table 30-18 Oracle Label Security Audit Events

Audit Event	Description
CREATE POLICY	Creates an Oracle Label Security policy through the <code>SA_SYSDBA.CREATE_POLICY</code> procedure
ALTER POLICY	Alters an Oracle Label Security policy through the <code>SA_SYSDBA.ALTER_POLICY</code> procedure
DROP POLICY	Drops an Oracle Label Security policy through the <code>SA_SYSDBA.DROP_POLICY</code> procedure
APPLY POLICY	Applies a table policy through the <code>SA_POLICY_ADMIN.APPLY_TABLE_POLICY</code> procedure or a schema policy through the <code>SA_POLICY_ADMIN.APPLY_SCHEMA_POLICY</code> procedure
REMOVE POLICY	Removes a table policy through the <code>SA_POLICY_ADMIN.REMOVE_TABLE_POLICY</code> procedure or a schema policy through the <code>SA_POLICY_ADMIN.REMOVE_SCHEMA_POLICY</code> procedure

Table 30-18 (Cont.) Oracle Label Security Audit Events

Audit Event	Description
SET AUTHORIZATION	Covers all Oracle Label Security authorizations, including Oracle Label Security privileges and user labels to either users or trusted stored procedures. The PL/SQL procedures that correspond to the SET AUTHORIZATION event are SA_USER_ADMIN.SET_USER_LABELS, SA_USER_ADMIN.SET_USER_PRIVS, and SA_USER_ADMIN.SET_PROG_PRIVS.
PRIVILEGED ACTION	Covers any action that requires the user of an Oracle Label Security privilege. These actions are logons, SA_SESSION.SET_ACCESS_PROFILE executions, and the invocation of trusted stored procedures.
ENABLE POLICY	Enables an Oracle Label Security policy through the following procedures: <ul style="list-style-type: none"> • SA_SYSDBA.ENABLE_POLICY: Enforces access control on the tables and schemas protected by the policy • SA_POLICY_ADMIN.ENABLE_TABLE_POLICY: Enables an Oracle Label Security policy for a specified table • SA_POLICY_ADMIN.ENABLE_SCHEMA_POLICY: Enables an Oracle Label Security policy for all the tables in a specified schema
DISABLE POLICY	Disables an Oracle Label Security policy through the following procedures: <ul style="list-style-type: none"> • SA_SYSDBA.DISABLE_POLICY: Disables the enforcement of an Oracle Label Security policy • SA_POLICY_ADMIN.DISABLE_TABLE_POLICY: Disables the enforcement an Oracle Label Security policy for a specified table • SA_POLICY_ADMIN.DISABLE_SCHEMA_POLICY: Disables the enforcement of an Oracle Label Security policy for all the tables in a specified schema
CREATE DATA LABEL	Creates an Oracle Label Security data label through the SA_LABEL_ADMIN.CREATE_LABEL procedure. CREATE DATA LABEL also corresponds to the LBACSYS.TO_DATA_LABEL function.
ALTER DATA LABEL	Alters an Oracle Label Security data label through the SA_LABEL_ADMIN.ALTER_LABEL procedure
DROP DATA LABEL	Drops an Oracle Label Security data label through the SA_LABEL_ADMIN.DROP_LABEL procedure
CREATE LABEL COMPONENT	Creates an Oracle Label Security component through the following procedures: <ul style="list-style-type: none"> • Levels: SA_COMPONENTS.CREATE_LEVEL • Compartments: SA_COMPONENTS.CREATE_COMPARTMENT • Groups: SA_COMPONENTS.CREATE_GROUP
ALTER LABEL COMPONENTS	Alters an Oracle Label Security component through the following procedures: <ul style="list-style-type: none"> • Levels: SA_COMPONENTS.ALTER_LEVEL • Compartments: SA_COMPONENTS.ALTER_COMPARTMENT • Groups: SA_COMPONENTS.ALTER_GROUP and SA_COMPONENTS.ALTER_GROUP_PARENT

Table 30-18 (Cont.) Oracle Label Security Audit Events

Audit Event	Description
DROP LABEL COMPONENTS	Drops an Oracle Label Security component through the following procedures: <ul style="list-style-type: none"> • Levels: SA_COMPONENTS.DROP_LEVEL • Compartments: SA_COMPONENTS.DROP_COMPARTMENT • Groups: SA_COMPONENTS.DROP_GROUP
ALL	Enables auditing of all Oracle Label Security actions

30.8.5.3 Oracle Label Security Auditable User Session Labels

The `ORA_OLS_SESSION_LABELS` application context can capture user session label usage for each Oracle Database event.

The attributes used by this application context refer to Oracle Label Security policies. .

The syntax is the same as the syntax used for application context auditing. For example:

```
AUDIT CONTEXT NAMESPACE ORA_SESSION_LABELS ATTRIBUTES policy1, policy2;
```

Because the recording of session labels is not user-session specific, the `BY user_list` clause is not required for auditing Oracle Label Security application contexts.

To disable the auditing of user session label information, you use the `NOAUDIT` statement. For example, to stop auditing for policies `policy1` and `policy2`, enter the following statement:

```
NOAUDIT CONTEXT NAMESPACE ORA_SESSION_LABELS ATTRIBUTES policy1, policy2;
```

Related Topics

- [Configuring Application Context Audit Settings](#)
The `AUDIT` statement with the `CONTEXT` keyword configures auditing for application context values.

30.8.5.4 Configuring a Unified Audit Policy for Oracle Label Security

The `ACTIONS` and `ACTIONS COMPONENT` clauses in the `CREATE AUDIT POLICY` statement can be used to create Oracle Label Security event audit policies.

- Use the following syntax to create an Oracle Label Security unified audit policy:

```
CREATE AUDIT POLICY policy_name
  ACTIONS action1 [,action2 ]
  ACTIONS COMPONENT=OLS component_action1 [, action2];
```

For example:

```
CREATE AUDIT POLICY audit_ols
  ACTIONS SELECT ON OE.ORDERS
  ACTIONS COMPONENT=OLS ALL;
```

You can build more complex policies, such as those that include conditions. Remember that after you create the policy, you must use the `AUDIT` statement to enable it.

Related Topics

- [Syntax for Creating a Custom Unified Audit Policy](#)
To create a custom unified audit policy, you must use the `CREATE AUDIT POLICY` statement.

30.8.5.5 Example: Auditing Oracle Label Security Session Label Attributes

The `AUDIT CONTEXT NAMESPACE` statement can audit Oracle Label Security session label attributes.

[Example 30-32](#) shows how to audit `ORA_OLS_SESSION_LABELS` application context attributes for the Oracle Label Security policies `usr_pol1` and `usr_pol2`.

Example 30-32 Auditing Oracle Label Security Session Label Attributes

```
AUDIT CONTEXT NAMESPACE ORA_SESSION_LABELS ATTRIBUTES usr_pol1, usr_pol2;
```

30.8.5.6 Example: Excluding a User from an Oracle Label Security Policy

The `CREATE AUDIT POLICY` statement can exclude users from policies.

[Example 30-33](#) shows how to create a unified audit policy that excludes actions from user `ols_mgr`.

Example 30-33 Excluding a User from an Oracle Label Security Policy

```
CREATE AUDIT POLICY auth_ols_audit_pol  
  ACTIONS SELECT ON HR.EMPLOYEES  
  ACTIONS COMPONENT=OLS DROP POLICY, DISABLE POLICY;  
  
AUDIT POLICY auth_ols_audit_pol EXCEPT ols_mgr;
```

30.8.5.7 Example: Auditing Oracle Label Security Policy Actions

The `CREATE AUDIT POLICY` statement can audit Oracle Label Security policy actions.

[Example 30-34](#) shows how to audit the `DROP POLICY` and `DISABLE POLICY` events, and `UPDATE` and `DELETE` statements on the `HR.EMPLOYEES` table. Then this policy is applied to the `HR` and `LBACSYS` users, and audit records are written to the unified audit trail only when the audited actions are successful.

Example 30-34 Auditing Oracle Label Security Policy Actions

```
CREATE AUDIT POLICY generic_audit_pol  
  ACTIONS UPDATE ON HR.EMPLOYEES, DELETE ON HR.EMPLOYEES  
  ACTIONS COMPONENT=OLS DROP POLICY, DISABLE POLICY;  
  
AUDIT POLICY generic_audit_pol BY HR, LBACSYS WHENEVER SUCCESSFUL;
```

30.8.5.8 Example: Querying for Audited OLS Session Labels

The `LBACSYS.ORA_GET_AUDITED_LABEL` function can be used in a `UNIFIED_AUDIT_TRAIL` query to find audited Oracle Label Security session labels.

[Example 30-35](#) shows how to use the `LBACSYS.ORA_GET_AUDITED_LABEL` function in a `UNIFIED_AUDIT_TRAIL` data dictionary view query.

Example 30-35 Querying for Audited Oracle Label Security Session Labels

```

SELECT ENTRY_ID, SESSIONID,
       LBACSYS.ORA_GET_AUDITED_LABEL( APPLICATION_CONTEXTS, 'GENERIC_AUDIT_POL1') AS
SESSION_LABEL1,
       LBACSYS.ORA_GET_AUDITED_LABEL( APPLICATION_CONTEXTS, 'GENERIC_AUDIT_POL2') AS
SESSION_LABEL2
FROM UNIFIED_AUDIT_TRAIL;
/

```

ENTRY_ID	SESSIONID	SESSION_LABEL1	SESSION_LABEL2
1	1023	SECRET	LEVEL_ALPHA
2	1024	TOP_SECRET	LEVEL_BETA

30.8.5.9 How Oracle Label Security Audit Events Appear in the Audit Trail

The `UNIFIED_AUDIT_TRAIL` data dictionary view lists Oracle Label Security audit events.

The `OLS_*` columns of the `UNIFIED_AUDIT_TRAIL` view show Oracle Label Security-specific audit data. For example:

```

SELECT OLS_PRIVILEGES_USED FROM UNIFIED_AUDIT_TRAIL WHERE DBUSERNAME = 'psmith';

OLS_PRIVILEGES_USED
-----
READ
WRITEUP
WRITEACROSS

```

The session labels that the audit trail captures are stored in the `APPLICATION_CONTEXTS` column of the `UNIFIED_AUDIT_TRAIL` view. You can use the `LBACSYS.ORA_GET_AUDITED_LABEL` function to retrieve session labels that are stored in the `APPLICATION_CONTEXTS` column. This function accepts the `UNIFIED_AUDIT_TRAIL.APPLICATION_CONTEXTS` column value, and the Oracle Label Security policy name as arguments, and then returns the session label that is stored in the column for the specified policy.

Related Topics

- [Oracle Label Security Administrator's Guide](#)

30.8.6 Auditing Oracle Data Pump Events

You can use the `CREATE AUDIT POLICY` statement to audit Oracle Data Pump.

- [About Auditing Oracle Data Pump Events](#)
The `CREATE AUDIT POLICY` statement `COMPONENT` clause must be set to `DATAPUMP` to create Oracle Data Pump unified audit policies.
- [Oracle Data Pump Unified Audit Trail Events](#)
The unified audit trail can capture Oracle Data Pump events.
- [Configuring a Unified Audit Policy for Oracle Data Pump](#)
The `ACTIONS COMPONENT` clause in the `CREATE AUDIT POLICY` statement can be used to create an Oracle Data Pump event unified audit policy.
- [Example: Auditing Oracle Data Pump Import Operations](#)
The `CREATE AUDIT POLICY` statement can audit Oracle Data Pump import operations.
- [Example: Auditing All Oracle Data Pump Operations](#)
The `CREATE AUDIT POLICY` statement can audit all Oracle Data Pump operations.

- [How Oracle Data Pump Audit Events Appear in the Audit Trail](#)
The `UNIFIED_AUDIT_TRAIL` data dictionary view lists Oracle Data Pump audited events.

30.8.6.1 About Auditing Oracle Data Pump Events

The `CREATE AUDIT POLICY` statement `COMPONENT` clause must be set to `DATAPUMP` to create Oracle Data Pump unified audit policies.

You can audit Data Pump export (`expdp`) and import (`impdp`) operations.

As with all unified auditing, you must have the `AUDIT_ADMIN` role before you can audit Oracle Data Pump events.

To access the audit trail, query the `UNIFIED_AUDIT_TRAIL` data dictionary view. The Data Pump-specific columns in this view begin with `DP_`.

Oracle Database records the Oracle Data Pump record before the worker process has determined or dispatched the actual workload. Therefore, there is no success or failure code that is captured in the audit record. A return code of 0 is expected behavior irrespective of the success or failure of the Data Pump job. Additionally, because Data Pump is restartable, reports on the success and failure status of the export or import operations might not be feasible to obtain.

Related Topics

- [Oracle Database Utilities](#)

30.8.6.2 Oracle Data Pump Unified Audit Trail Events

The unified audit trail can capture Oracle Data Pump events.

The unified audit trail captures information about both export (`expdp`) and import (`impdp`) operations.

30.8.6.3 Configuring a Unified Audit Policy for Oracle Data Pump

The `ACTIONS COMPONENT` clause in the `CREATE AUDIT POLICY` statement can be used to create an Oracle Data Pump event unified audit policy.

- Use the following syntax to create a unified audit policy for Oracle Data Pump:

```
CREATE AUDIT POLICY policy_name
ACTIONS COMPONENT=DATAPUMP { EXPORT | IMPORT | ALL };
```

For example:

```
CREATE AUDIT POLICY audit_dp_export_pol
ACTIONS COMPONENT=DATAPUMP EXPORT;
```

You can build more complex policies, such as those that include conditions. Remember that after you create the policy, you must use the `AUDIT` statement to enable it.

Related Topics

- [Syntax for Creating a Custom Unified Audit Policy](#)
To create a custom unified audit policy, you must use the `CREATE AUDIT POLICY` statement.

30.8.6.4 Example: Auditing Oracle Data Pump Import Operations

The `CREATE AUDIT POLICY` statement can audit Oracle Data Pump import operations.

[Example 30-36](#) shows how to audit all Oracle Data Pump import operations.

Example 30-36 Auditing Oracle Data Pump Import Operations

```
CREATE AUDIT POLICY audit_dp_import_pol
  ACTIONS COMPONENT=DATAPUMP IMPORT;

AUDIT POLICY audit_dp_import_pol;
```

30.8.6.5 Example: Auditing All Oracle Data Pump Operations

The `CREATE AUDIT POLICY` statement can audit all Oracle Data Pump operations.

[Example 30-37](#) shows how to audit both Oracle Database Pump export and import operations.

Example 30-37 Auditing All Oracle Data Pump Operations

```
CREATE AUDIT POLICY audit_dp_all_pol
  ACTIONS COMPONENT=DATAPUMP ALL;

AUDIT POLICY audit_dp_all_pol BY SYSTEM;
```

30.8.6.6 How Oracle Data Pump Audit Events Appear in the Audit Trail

The `UNIFIED_AUDIT_TRAIL` data dictionary view lists Oracle Data Pump audited events.

The `DP_*` columns of the `UNIFIED_AUDIT_TRAIL` view show Oracle Data Pump-specific audit data. For example:

```
SELECT DP_TEXT_PARAMETERS1, DP_BOOLEAN_PARAMETERS1, DP_WARNINGS1 FROM UNIFIED_AUDIT_TRAIL
WHERE AUDIT_TYPE = 'DATAPUMP';
```

DP_TEXT_PARAMETERS1	DP_BOOLEAN_PARAMETERS1	DP_WARNINGS1

MASTER TABLE: "SCOTT"."SYS_EXPORT_TABLE_01",	MASTER_ONLY: FALSE,	No warnings issued
JOB_TYPE: EXPORT,	DATA_ONLY: FALSE,	
METADATA_JOB_MODE: TABLE_EXPORT,	METADATA_ONLY: FALSE,	
JOB VERSION: 23.1.0.0,	DUMPFILE_PRESENT: TRUE,	
ACCESS METHOD: DIRECT_PATH,	JOB_RESTARTED: FALSE	
DATA OPTIONS: 0,	ENCRYPTED: TRUE	
DUMPER DIRECTORY: NULL		
REMOTE LINK: NULL,		
TABLE EXISTS: NULL,		
PARTITION OPTIONS: NONE		
SCHEMA: SCOTT		

(This output was reformatted for easier readability.)

Oracle Database records the Oracle Data Pump record before the worker process has determined or dispatched the actual workload. Therefore, there is no success or failure code that is captured in the audit record. A return code of 0 is expected behavior irrespective of the success or failure of the Data Pump job. Additionally, because Data Pump is restartable reports on the success and failure status of the export or import operations might not be feasible to obtain.

30.8.7 Auditing Oracle SQL*Loader Direct Load Path Events

You can use the `CREATE AUDIT POLICY` statement to audit Oracle SQL*Loader direct load path events.

- [About Auditing in Oracle SQL*Loader Direct Path Load Events](#)
You must have the `AUDIT_ADMIN` role to audit Oracle SQL*Loader direct path events.
- [Oracle SQL*Loader Direct Load Path Unified Audit Trail Events](#)
The unified audit trail can capture SQL*Loader Direct Load Path events.
- [Configuring a Unified Audit Trail Policy for Oracle SQL*Loader Direct Path Events](#)
The `CREATE AUDIT POLICY` statement `ACTIONS COMPONENT` clause can create unified audit policies for Oracle SQL*Loader direct path events.
- [Example: Auditing Oracle SQL*Loader Direct Path Load Operations](#)
The `CREATE AUDIT POLICY` statement can audit Oracle SQL*Loader direct path load operations.
- [How SQL*Loader Direct Path Load Audited Events Appear in the Audit Trail](#)
The `UNIFIED_AUDIT_TRAIL` data dictionary view lists SQL*Loader direct path load audited events.

30.8.7.1 About Auditing in Oracle SQL*Loader Direct Path Load Events

You must have the `AUDIT_ADMIN` role to audit Oracle SQL*Loader direct path events.

To create SQL*Loader unified audit policies, you must set the `CREATE AUDIT POLICY` statement's `COMPONENT` clause to `DIRECT_LOAD`. You can audit direct path load operations only, not other SQL*Loader loads, such as conventional path loads.

To access the audit trail, you can query the `DIRECT_PATH_NUM_COLUMNS_LOADED` column in the `UNIFIED_AUDIT_TRAIL` data dictionary view.

Related Topics

- *Oracle Database Utilities*

30.8.7.2 Oracle SQL*Loader Direct Load Path Unified Audit Trail Events

The unified audit trail can capture SQL*Loader Direct Load Path events.

The unified audit trail captures information about direct path loads that SQL*Loader performs (that is, when you set `direct=true` on the SQL*Loader command line or in the SQL*Loader control file).

It also audits Oracle Call Interface (OCI) programs that use the direct path API.

Related Topics

- *Oracle Database Utilities*

30.8.7.3 Configuring a Unified Audit Trail Policy for Oracle SQL*Loader Direct Path Events

The `CREATE AUDIT POLICY` statement `ACTIONS COMPONENT` clause can create unified audit policies for Oracle SQL*Loader direct path events.

- Use the following syntax to create an Oracle SQL*Loader unified audit policy:

```
CREATE AUDIT POLICY policy_name
ACTIONS COMPONENT=DIRECT_LOAD { LOAD };
```

For example:

```
CREATE AUDIT POLICY audit_sqlldr_pol
ACTIONS COMPONENT=DIRECT_LOAD LOAD;
```

You can build more complex policies, such as those that include conditions. Remember that after you create the policy, you must use the `AUDIT` statement to enable it.

Related Topics

- [Syntax for Creating a Custom Unified Audit Policy](#)
To create a custom unified audit policy, you must use the `CREATE AUDIT POLICY` statement.

30.8.7.4 Example: Auditing Oracle SQL*Loader Direct Path Load Operations

The `CREATE AUDIT POLICY` statement can audit Oracle SQL*Loader direct path load operations.

[Example 30-36](#) shows how to audit SQL*Loader direct path load operations.

Example 30-38 Auditing Oracle SQL*Loader Direct Path Load Operations

```
CREATE AUDIT POLICY audit_sqlldr_load_pol
ACTIONS COMPONENT=DIRECT_LOAD LOAD;
```

```
AUDIT POLICY audit_sqlldr_load_pol;
```

30.8.7.5 How SQL*Loader Direct Path Load Audited Events Appear in the Audit Trail

The `UNIFIED_AUDIT_TRAIL` data dictionary view lists SQL*Loader direct path load audited events.

The `DIRECT_PATH_NUM_COLUMNS_LOADED` column of the `UNIFIED_AUDIT_TRAIL` view shows the number of columns that were loaded using the SQL*Loader direct path load method. For example:

```
SELECT DBUSERNAME, ACTION_NAME, OBJECT_SCHEMA, OBJECT_NAME,
DIRECT_PATH_NUM_COLUMNS_LOADED FROM UNIFIED_AUDIT_TRAIL WHERE AUDIT_TYPE = 'DIRECT PATH
API';
```

DBUSERNAME	ACTION_NAME	OBJECT_SCHEMA	OBJECT_NAME	DIRECT_PATH_NUM_COLUMNS_LOADED
RLAYTON	INSERT	HR	EMPLOYEES	4

30.8.8 Auditing Oracle XML DB HTTP and FTP Protocols

You can use the `CREATE AUDIT POLICY` statement to audit Oracle XML DB HTTP and FTP protocol messages.

- [About Auditing Oracle XML DB HTTP and FTP Protocols](#)
You must have the `AUDIT_ADMIN` role to audit Oracle XDB HTTP and FTP protocol messages.
- [Configuring a Unified Audit Policy to Capture Oracle XML DB HTTP and FTP Protocols](#)
The `CREATE AUDIT POLICY` statement can create a unified audit policy for Oracle XML DB HTTP and FTP protocols.
- [Example: Auditing Failed Oracle XML DB HTTP Messages](#)
The `CREATE AUDIT POLICY` statement can audit failed Oracle XML DB HTTP messages.
- [Example: Auditing All Oracle XML DB FTP Messages](#)
The `CREATE AUDIT POLICY` statement can audit all Oracle XML DB FTP messages.
- [Example: Auditing Oracle XML DB HTTP Messages That Have 401 AUTH Errors](#)
The `CREATE AUDIT POLICY` statement can audit HTTP messages that have 401 AUTH errors.
- [How the Unified Audit Trail Captures Oracle XML DB HTTP and FTP Protocol Messages](#)
The `UNIFIED_AUDIT_TRAIL` data dictionary view lists Oracle XML DB HTTP and FTP protocol messages.

30.8.8.1 About Auditing Oracle XML DB HTTP and FTP Protocols

You must have the `AUDIT_ADMIN` role to audit Oracle XDB HTTP and FTP protocol messages.

Oracle Database can audit all or failed HTTP messages, 401 AUTH HTTP return code messages, and all or failed FTP messages. The `UNIFIED_AUDIT_TRAIL` data dictionary view captures the result of the audit in the `PROTOCOL_*` columns.

Be aware that a unified audit policy for HTTP and FTP protocols can affect performance.

30.8.8.2 Configuring a Unified Audit Policy to Capture Oracle XML DB HTTP and FTP Protocols

The `CREATE AUDIT POLICY` statement can create a unified audit policy for Oracle XML DB HTTP and FTP protocols.

- Use the following syntax to create a unified audit policy for Oracle XML DB HTTP and FTP protocols:

```
CREATE AUDIT POLICY policy_name
ACTIONS COMPONENT=PROTOCOL [ HTTP | FTP | AUTHENTICATION];
```

In this specification:

- HTTP enabling auditing of Oracle XML DB HTTP messages.
- FTP enables auditing of Oracle XML DB FTP messages.
- AUTHENTICATION enables auditing of HTTP 401 AUTH messages.

For example:

```
CREATE AUDIT POLICY http_pol
ACTIONS COMPONENT=PROTOCOL HTTP;
```

30.8.8.3 Example: Auditing Failed Oracle XML DB HTTP Messages

The `CREATE AUDIT POLICY` statement can audit failed Oracle XML DB HTTP messages.

[Example 30-39](#) shows an example of creating and enabling a unified audit policy that tracks failed HTTP messages.

Example 30-39 Auditing Failed Oracle XML DB HTTP Messages

```
CREATE AUDIT POLICY failed_http_pol
ACTIONS COMPONENT=PROTOCOL HTTP;

AUDIT POLICY failed_http_pol WHENEVER NOT SUCCESSFUL;
```

30.8.8.4 Example: Auditing All Oracle XML DB FTP Messages

The `CREATE AUDIT POLICY` statement can audit all Oracle XML DB FTP messages.

[Example 30-40](#) shows an example of creating and enabling a unified audit policy that tracks all FTP messages.

Example 30-40 Auditing All Oracle XML DB FTP Messages

```
CREATE AUDIT POLICY all_ftp_pol
ACTIONS COMPONENT=PROTOCOL FTP;

AUDIT POLICY all_ftp_pol;
```

30.8.8.5 Example: Auditing Oracle XML DB HTTP Messages That Have 401 AUTH Errors

The `CREATE AUDIT POLICY` statement can audit HTTP messages that have 401 AUTH errors.

[Example 30-41](#) shows an example of creating and enabling a unified audit policy that tracks 401 AUTH messages. When you enable this type of policy, you can set it without using the `WHENEVER` clause or set it using the `WHENEVER SUCCESSFUL` clause. Using a `WHENEVER NOT SUCCESSFUL` will not audit 401 AUTH errors.

Example 30-41 Auditing Oracle XML DB HTTP Messages with 401 AUTH Errors

```
CREATE AUDIT POLICY 401_error_pol
ACTIONS COMPONENT=PROTOCOL AUTHENTICATION;

AUDIT POLICY 401_error_pol;
```

30.8.8.6 How the Unified Audit Trail Captures Oracle XML DB HTTP and FTP Protocol Messages

The `UNIFIED_AUDIT_TRAIL` data dictionary view lists Oracle XML DB HTTP and FTP protocol messages.

The `PROTOCOL_*` columns capture HTTP- and FTP-specific information such as the session ID, the return code, the type of request, and the text of the request or reply.

For example, the following query shows that the `HTTP-GET` request/reply had a return code of 207, which means the reply may have multiple components with separate return codes:

```
SELECT PROTOCOL_RETURN_CODE, PROTOCOL_ACTION_NAME
FROM UNIFIED_AUDIT_POLICY
WHERE USERHOST = "HR_SRV";

PROTOCOL_RETURN_CODE  PROTOCOL_ACTION_NAME
-----
```

207 HTTP-GET-CMD
207 HTTP-GET

30.8.9 Auditing Oracle Machine Learning for SQL Events

You can use the `CREATE AUDIT POLICY` statement to audit Oracle Machine Learning for SQL events.

- [About Auditing Oracle Machine Learning for SQL Events](#)
You must have the `AUDIT_ADMIN` role to audit Oracle Machine Learning for SQL events.
- [Oracle Machine Learning for SQL Unified Audit Trail Events](#)
The unified audit trail can capture Oracle Machine Learning for SQL audit events..
- [Configuring a Unified Audit Policy for Oracle Machine Learning for SQL](#)
The `CREATE AUDIT POLICY` statement `ACTIONS` and `ON MINING MODEL` clauses can be used to create Oracle Machine Learning for SQL event unified audit policies.
- [Example: Auditing Multiple Oracle Machine Learning for SQL Operations by a User](#)
The `CREATE AUDIT POLICY` statement can audit multiple Oracle Machine Learning for SQL operations.
- [Example: Auditing All Failed Oracle Machine Learning for SQL Operations by a User](#)
The `CREATE AUDIT POLICY` statement can audit failed Oracle Machine Learning for SQL operations by a user.
- [How Oracle Machine Learning for SQL Events Appear in the Audit Trail](#)
The `UNIFIED_AUDIT_TRAIL` data dictionary view lists Oracle Machine Learning for SQL audit events.

30.8.9.1 About Auditing Oracle Machine Learning for SQL Events

You must have the `AUDIT_ADMIN` role to audit Oracle Machine Learning for SQL events.

To access the audit trail, you can query the `UNIFIED_AUDIT_TRAIL` data dictionary view.

Related Topics

- [Oracle Machine Learning for SQL Concepts](#)

30.8.9.2 Oracle Machine Learning for SQL Unified Audit Trail Events

The unified audit trail can capture Oracle Machine Learning for SQL audit events..

[Table 30-19](#) describes these events.

Table 30-19 Oracle Machine Learning for SQL Audit Events

Audit Event	Description
AUDIT	Generates an audit record for a Oracle Machine Learning for SQL model
COMMENT	Adds a comment to a Oracle Machine Learning for SQL model
GRANT	Gives permission to a user to access the Oracle Machine Learning for SQL model
RENAME	Changes the name of the Oracle Machine Learning for SQL model

Table 30-19 (Cont.) Oracle Machine Learning for SQL Audit Events

Audit Event	Description
SELECT	Applies the Oracle Machine Learning for SQL model or view its signature

30.8.9.3 Configuring a Unified Audit Policy for Oracle Machine Learning for SQL

The `CREATE AUDIT POLICY` statement `ACTIONS` and `ON MINING MODEL` clauses can be used to create Oracle Machine Learning for SQL event unified audit policies.

- Use the following syntax to create a unified audit policy for Oracle Machine Learning for SQL:

```
CREATE AUDIT POLICY policy_name
ACTIONS {operation | ALL}
ON MINING MODEL schema_name.model_name;
```

For example:

```
CREATE AUDIT POLICY dm_ops ACTIONS RENAME ON MINING MODEL hr.dm_emp;
```

You can build more complex policies, such as those that include conditions. Remember that after you create the policy, you must use the `AUDIT` statement to enable it.

Related Topics

- [Syntax for Creating a Custom Unified Audit Policy](#)
To create a custom unified audit policy, you must use the `CREATE AUDIT POLICY` statement.

30.8.9.4 Example: Auditing Multiple Oracle Machine Learning for SQL Operations by a User

The `CREATE AUDIT POLICY` statement can audit multiple Oracle Machine Learning for SQL operations.

Example 30-42 shows how to audit multiple Oracle Machine Learning for SQL operations by user `psmith`. Include the `ON MINING MODEL schema_name.model_name` clause for each event, and separate each with a comma. This example specifies the same `schema_name.model_name` for both actions, but the syntax enables you to specify different `schema_name.model_name` settings for different schemas and data models.

Example 30-42 Auditing Multiple Oracle Machine Learning for SQL Operations by a User

```
CREATE AUDIT POLICY dm_ops_pol
ACTIONS SELECT ON MINING MODEL dmuser1.nb_model, ALTER ON MINING MODEL dmuser1.nb_model;

AUDIT POLICY dm_ops_pol BY psmith;
```

30.8.9.5 Example: Auditing All Failed Oracle Machine Learning for SQL Operations by a User

The `CREATE AUDIT POLICY` statement can audit failed Oracle Machine Learning for SQL operations by a user.

[Example 30-43](#) shows how to audit all failed Oracle Machine Learning for SQL operations by user psmith.

Example 30-43 Auditing All Failed Oracle Machine Learning for SQL Operations by a User

```
CREATE AUDIT POLICY dm_all_ops_pol ACTIONS ALL ON MINING MODEL dmuser1.nb_model;

AUDIT POLICY dm_all_ops_pol BY psmith WHENEVER NOT SUCCESSFUL;
```

30.8.9.6 How Oracle Machine Learning for SQL Events Appear in the Audit Trail

The UNIFIED_AUDIT_TRAIL data dictionary view lists Oracle Machine Learning for SQL audit events.

The following example shows how to query the UNIFIED_AUDIT_TRAIL data dictionary view for Machine Learning for SQL audit events.

```
SELECT DBUSERNAME, ACTION_NAME, SYSTEM_PRIVILEGE_USED, RETURN_CODE,
OBJECT_SCHEMA, OBJECT_NAME, SQL_TEXT
FROM UNIFIED_AUDIT_TRAIL;
```

DBUSERNAME	ACTION_NAME	SYSTEM_PRIVILEGE_USED	RETURN_CODE
DMUSER1	CREATE MINING MODEL	CREATE MINING MODEL	0
DMUSER1	BEGIN		
	dbms_data_mining.create_model(model_name => 'nb_model',		
	mining_function => dbms_data_mining.classification,		
	data_table_name => 'dm_data',		
	case_id_column_name => 'case_id',		
	target_column_name => 'target');		
DMUSER1	END;		
DMUSER1	SELECT MINING MODEL		0
DMUSER1	NB_MODEL		
	select prediction(nb_model using *) from dual		
DMUSER2	SELECT MINING MODEL		40284
DMUSER1	NB_MODEL		
	select prediction(dmuser1.nb_model using *) from dual		
DMUSER1	ALTER MINING MODEL		0
DMUSER1	NB_MODEL		
	BEGIN dbms_data_mining.rename_model('nb_model', 'nb_model1'); END;		
DMUSER2	ALTER MINING MODEL		40284
DMUSER1	NB_MODEL		
	BEGIN dbms_data_mining.rename_model('dmuser1.nb_model1', 'nb_model'); END;		
DMUSER2	ALTER MINING MODEL		40284
DMUSER1	NB_MODEL		
	BEGIN dbms_data_mining.rename_model('dmuser1.nb_model1', 'nb_model'); END;		

30.9 Managing Unified Audit Policies

After you create a unified audit policy, you must enable it. You can alter, disable, and drop unified audit policies.

- [Altering Unified Audit Policies](#)
You can use the `ALTER AUDIT POLICY` statement to modify a unified audit policy.
- [Enabling and Applying Unified Audit Policies to Users and Roles](#)
You can use the `AUDIT POLICY` statement to enable and apply unified audit policies to users and roles.
- [Disabling Unified Audit Policies](#)
You can use the `NOAUDIT POLICY` statement to disable a unified audit policy.
- [Dropping Unified Audit Policies](#)
You can use the `DROP AUDIT POLICY` statement to drop a unified audit policy.

30.9.1 Altering Unified Audit Policies

You can use the `ALTER AUDIT POLICY` statement to modify a unified audit policy.

- [About Altering Unified Audit Policies](#)
You can change most properties in a unified audit policy, except for its `CONTAINER` setting.
- [Altering a Unified Audit Policy](#)
The `ALTER AUDIT POLICY` statement can modify a unified audit policy.
- [Example: Altering a Condition in a Unified Audit Policy](#)
The `ALTER AUDIT POLICY` statement can alter conditions in unified audit policies.
- [Example: Altering an Oracle Label Security Component in a Unified Audit Policy](#)
The `ALTER AUDIT POLICY` statement can alter Oracle Label Security components in an audit policy.
- [Example: Altering Roles in a Unified Audit Policy](#)
The `ALTER AUDIT POLICY` statement can alter roles in a unified audit policy.
- [Example: Dropping a Condition from a Unified Audit Policy](#)
The `ALTER AUDIT POLICY` statement can drop a condition from a unified audit policy.
- [Example: Altering an Existing Unified Audit Policy Top-Level Statement Audits](#)
The `ALTER AUDIT POLICY` statement can modify an existing unified audit policy so that the unified audit trail captures top-level SQL statements only.

30.9.1.1 About Altering Unified Audit Policies

You can change most properties in a unified audit policy, except for its `CONTAINER` setting.

You cannot alter unified audit policies in a multitenant environment. For example, you cannot turn a common unified audit policy into a local unified audit policy.

To find existing unified audit policies, query the `AUDIT_UNIFIED_POLICIES` data dictionary view. If you want to find only the enabled unified audit policies, then query the `AUDIT_UNIFIED_ENABLED_POLICIES` view. You can alter both enabled and disabled audit policies. If you alter an enabled audit policy, it remains enabled after you alter it.

After you alter an object unified audit policy, the new audit settings take place immediately, for both the active and subsequent user sessions. If you alter system audit options, or audit

conditions of the policy, then they are activated for new user sessions, but not the current user session.

30.9.1.2 Altering a Unified Audit Policy

The `ALTER AUDIT POLICY` statement can modify a unified audit policy.

- Use the following syntax to alter a unified audit policy, you use the `ALTER AUDIT POLICY` statement.

```
ALTER AUDIT POLICY policy_name
[ADD [privilege_audit_clause][action_audit_clause]
     [role_audit_clause] [ONLY TOPLEVEL] ]
[DROP [privilege_audit_clause][action_audit_clause]
      [role_audit_clause] [ONLY TOPLEVEL]]
[CONDITION {DROP | audit_condition EVALUATE PER {STATEMENT|SESSION|INSTANCE}}]
```

In this specification:

- `ADD` enables you to alter the following the following settings:
 - * *privilege_audit_clause* describes privilege-related audit options. The detailed syntax for configuring privilege audit options is as follows:

```
ADD privilege_audit_clause := PRIVILEGES privilege1 [, privilege2]
```
 - * *action_audit_clause* and *standard_actions* describe object action-related audit options. The syntax is as follows:

```
ADD action_audit_clause := {standard_actions | component_actions}
                               [, component_actions ]
standard_actions :=
    ACTIONS action1 [ ON {schema.obj_name
                          | DIRECTORY directory_name
                          | MINING MODEL schema.obj_name
                          }
                    ]
    [, action2 [ ON {schema.obj_name
                    | DIRECTORY directory_name
                    | MINING MODEL schema.obj_name
                    }
              ]
    ]
```
 - * *role_audit_clause* enables you to add or drop the policy for roles. The syntax is:

```
ADD role_audit_clause := ROLES role1 [, role2]
```
 - * `ONLY TOPLEVEL` includes in the unified audit trail only the top-level SQL statements that are affected by this policy.
- `DROP` enables you to drop the same components that are described for the `ADD` clause. For example:

```
DROP role_audit_clause := ROLES role1 [, role2 ONLY TOPLEVEL]
```
- `CONDITION {DROP...}` enables you to add or drop a condition for the policy. If you are altering an existing condition, then you must include the `EVALUATE PER` clause with the condition. The syntax is:

```
CONDITION 'audit_condition := function operation value_list'
EVALUATE PER {STATEMENT|SESSION|INSTANCE}
```

If you want to drop a condition, then omit the condition definition and the `EVALUATE PER` clause. For example:

CONDITION DROP

Related Topics

- [Auditing System Privileges](#)
You can use the `CREATE AUDIT POLICY` statement to audit system privileges.
- [Auditing Roles](#)
You can use the `CREATE AUDIT POLICY` statement to audit database roles.
- [Auditing Object Actions](#)
You can use the `CREATE AUDIT POLICY` statement to audit object actions.
- [Unified Auditing with Configurable Conditions](#)
You can use the `CREATE AUDIT POLICY` statement to create conditions for a unified audit policy.

30.9.1.3 Example: Altering a Condition in a Unified Audit Policy

The `ALTER AUDIT POLICY` statement can alter conditions in unified audit policies.

[Example 30-44](#) shows how to change a condition in an existing unified audit policy.

Example 30-44 Altering a Condition in a Unified Audit Policy

```
ALTER AUDIT POLICY orders_unified_audpol
  ADD ACTIONS INSERT ON SCOTT.EMP
  CONDITION 'SYS_CONTEXT(''ENTERPRISE'', 'GROUP') = 'ACCESS_MANAGER'''
  EVALUATE PER SESSION;
```

30.9.1.4 Example: Altering an Oracle Label Security Component in a Unified Audit Policy

The `ALTER AUDIT POLICY` statement can alter Oracle Label Security components in an audit policy.

[Example 30-45](#) shows how to alter an Oracle Label Security component in an audit policy.

Example 30-45 Altering an Oracle Label Security Component in a Unified Audit Policy

```
ALTER AUDIT POLICY audit_ols
  ADD ACTIONS SELECT ON HR.EMPLOYEES
  ACTIONS COMPONENT=OLS DROP POLICY, DISABLE POLICY, REMOVE POLICY;
```

30.9.1.5 Example: Altering Roles in a Unified Audit Policy

The `ALTER AUDIT POLICY` statement can alter roles in a unified audit policy.

[Example 30-46](#) shows how to add roles to a common unified audit policy.

Example 30-46 Altering Roles in a Unified Audit Policy

```
CONNECT c##sec_admin
Enter password: password
Connected.

ALTER AUDIT POLICY RoleConnectAudit
  ADD ROLES c##role1, c##role2;
```

30.9.1.6 Example: Dropping a Condition from a Unified Audit Policy

The `ALTER AUDIT POLICY` statement can drop a condition from a unified audit policy.

[Example 30-47](#) shows how to drop a condition from an existing unified audit policy.

Example 30-47 Dropping a Condition from a Unified Audit Policy

```
ALTER AUDIT POLICY orders_unified_audpol  
CONDITION DROP;
```

30.9.1.7 Example: Altering an Existing Unified Audit Policy Top-Level Statement Audits

The `ALTER AUDIT POLICY` statement can modify an existing unified audit policy so that the unified audit trail captures top-level SQL statements only.

The following example shows how to modify the `orders_unified_audpol` policy to capture only top-level SQL statements.

Example 30-48 Altering an Existing Unified Audit Policy to Audit for Top-Level Statements

```
ALTER AUDIT POLICY orders_unified_audpol ADD ONLY TOPLEVEL;
```

Similarly, to remove the top-level SQL statement audit, use the `DROP` clause:

```
ALTER AUDIT POLICY orders_unified_audpol DROP ONLY TOPLEVEL;
```

30.9.2 Enabling and Applying Unified Audit Policies to Users and Roles

You can use the `AUDIT POLICY` statement to enable and apply unified audit policies to users and roles.

- [About Enabling Unified Audit Policies](#)
The `AUDIT` statement with the `POLICY` clause enables a unified audit policy, applying for all types of audit options, including object-level options.
- [Enabling a Unified Audit Policy](#)
The `AUDIT POLICY` statement can enable a unified audit policy.
- [Example: Enabling a Unified Audit Policy](#)
The `AUDIT POLICY` statement can enable a unified audit policy using conditions, such as `WHENEVER NOT SUCCESSFUL`.

30.9.2.1 About Enabling Unified Audit Policies

The `AUDIT` statement with the `POLICY` clause enables a unified audit policy, applying for all types of audit options, including object-level options.

The policy is enabled immediately in the current session and in any ongoing active sessions, including sessions for other users who are logged in.

You can enable the audit policy for individual users or for roles. Enabling the audit policy for roles allows you to enable the policy for a group of users who have been directly granted the role. When the role has been directly granted to a new user, then the policy automatically

applies to the user. When the role is revoked from a user, then the policy no longer applies to the user.

You can check the results of the audit by querying the `UNIFIED_AUDIT_TRAIL` data dictionary view. To find a list of existing unified audit policies, query the `AUDIT_UNIFIED_POLICIES` data dictionary view.

The `AUDIT` statement lets you specify the following optional additional settings:

- **Whether to apply the unified audit policy to one or more users or roles.** To apply the policy to one or more users or roles, including administrative users who log in with the `SYSDBA` administrative privilege (such as `SYS`), use the `BY` clause. For example, to apply the policy to users `SYS` and `SYSTEM`:

For example, to apply the policy to two users:

```
AUDIT POLICY role_connect_audit_pol BY SYS, SYSTEM;
```

To apply a policy to users who have been directly granted the `DBA` and `CDB_DBA` roles:

```
AUDIT POLICY admin_audit_pol BY USERS WITH GRANTED ROLES DBA, CDB_DBA;
```

- **Whether to exclude users from the unified audit policy.** To exclude users from the audit policy, include the `EXCEPT` clause.

For example:

```
AUDIT POLICY role_connect_audit_pol EXCEPT rlee, jrandolph;
```

- **Whether to create an audit record if the activity succeeds or fails.** Auditing the successes and failures of actions helps to narrow down the events that matter the most. Enter one of the following clauses:
 - `WHENEVER SUCCESSFUL` audits only successful executions of the user's activity.
 - `WHENEVER NOT SUCCESSFUL` audits only failed executions of the user's activity. Monitoring unsuccessful SQL statement can expose users who are snooping or acting maliciously, though most unsuccessful SQL statements are neither.

For example:

```
AUDIT POLICY role_connect_audit_pol WHENEVER NOT SUCCESSFUL;
```

If you omit this clause, then both failed and successful user activities are written to the audit trail.

Note the following:

- The unified audit policy only can have either the `BY`, `BY USERS WITH GRANTED ROLES`, or the `EXCEPT` clause, but not more than one of these clauses for the same policy.
- If you run multiple `AUDIT` statements on the same unified audit policy but specify different `BY` users or different `BY USERS WITH GRANTED ROLES` roles, then Oracle Database audits all of these users or roles.
- If you run multiple `AUDIT` statements on the same unified audit policy but specify different `EXCEPT` users, then Oracle Database uses the last exception user list, not any of the users from the preceding lists. This means the effect of the earlier `AUDIT POLICY ... EXCEPT` statements are overridden by the latest `AUDIT POLICY ... EXCEPT` statement.
- You cannot use the `EXCEPT` clause for roles. It applies to users only.
- You can only enable common unified audit policies for common users or roles.

- You can enable a common audit policy only from the root and a local audit policy only from the PDB to which it applies.

30.9.2.2 Enabling a Unified Audit Policy

The `AUDIT POLICY` statement can enable a unified audit policy.

- Use the following syntax to enable a unified audit policy:

```
AUDIT POLICY { policy_auditing }  
  [WHENEVER [NOT] SUCCESSFUL]
```

In this specification:

- *policy_auditing* refers to the following components:

- * **The name of the unified audit policy.** To find all existing policies, query the `AUDIT_UNIFIED_POLICIES` data dictionary view. To find currently enabled policies, query `AUDIT_UNIFIED_ENABLED_POLICIES`.
- * **Users or roles to whom the unified audit policy applies.** To apply the policy to one or more users (including user `SYS`), enter the `BY` clause. For example:

```
BY psmith, rlee
```

To apply the policy to one or more users to whom the list of roles are directly granted, use the `BY USERS WITH GRANTED ROLES` clause. For example:

```
BY USERS WITH GRANTED ROLES HS_ADMIN_ROLE, HS_ADMIN_SELECT_ROLE
```

- * **Users to exclude from the unified audit policy.** To exclude one or more users from the policy, enter the `EXCEPT` clause. For example:

```
EXCEPT psmith, rlee
```

Mandatory audit records are captured in the `UNIFIED_AUDIT_TRAIL` data dictionary view for the `AUDIT POLICY SQL` statement. To find users who have been excluded in the audit records, you can query the `EXCLUDED_USER` column in the `UNIFIED_AUDIT_TRAIL` view to list the excluded users.

You cannot enable the same audit policy with the `BY`, `BY USERS WITH GRANTED ROLES`, and `EXCEPT` clauses in the same statement. This action throws an error for the subsequent `AUDIT` statement with the conflicting clause

- `WHENEVER [NOT] SUCCESSFUL` enables the policy to generate audit records based on whether the user's actions failed or succeeded.

After you enable the unified audit policy and it is generating records, you can find the audit records by querying the `UNIFIED_AUDIT_TRAIL` data dictionary view.

Related Topics

- [About Enabling Unified Audit Policies](#)
The `AUDIT` statement with the `POLICY` clause enables a unified audit policy, applying for all types of audit options, including object-level options.

30.9.2.3 Example: Enabling a Unified Audit Policy

The `AUDIT POLICY` statement can enable a unified audit policy using conditions, such as `WHENEVER NOT SUCCESSFUL`.

[Example 30-49](#) shows how to enable a unified audit policy to record only failed actions by the user `dv_admin`.

Example 30-49 Enabling a Unified Audit Policy

```
AUDIT POLICY dv_admin_pol BY tjones
WHENEVER NOT SUCCESSFUL;
```

30.9.3 Disabling Unified Audit Policies

You can use the `NOAUDIT POLICY` statement to disable a unified audit policy.

- [About Disabling Unified Audit Policies](#)
The `NOAUDIT` statement with the `POLICY` clause can disable a unified audit policy.
- [Disabling a Unified Audit Policy](#)
The `NOAUDIT` statement can disable a unified audit policy using supported audit options.
- [Example: Disabling a Unified Audit Policy](#)
The `NOAUDIT POLICY` statement disable a unified audit policy using filtering, such as by user name.

30.9.3.1 About Disabling Unified Audit Policies

The `NOAUDIT` statement with the `POLICY` clause can disable a unified audit policy.

In the `NOAUDIT` statement, you can specify a `BY user` or `BY USERS WITH GRANTED ROLES role list`, but not an `EXCEPT user list`. The disablement of a unified audit policy takes effect on subsequent user sessions.

You can find a list of existing unified audit policies by querying the `AUDIT_UNIFIED_POLICIES` data dictionary view.

You can disable a common audit policy only from the root and a local audit policy only from the PDB to which it applies.

30.9.3.2 Disabling a Unified Audit Policy

The `NOAUDIT` statement can disable a unified audit policy using supported audit options.

- Use the following syntax to disable a unified audit policy:

```
NOAUDIT POLICY {policy_auditing | existing_audit_options};
```

In this specification:

- *policy_auditing* is the name of the policy. To find all currently enabled policies, query the `AUDIT_UNIFIED_ENABLED_POLICIES` data dictionary view. As part of this specification, you optionally can include the `BY` or `BY USERS WITH GRANTED ROLES` clause, but not the `EXCEPT` clause.
- *existing_audit_options* refers to `AUDIT` options that were available in releases earlier than Oracle Database 12c release 1 (12.1), such as the following:
 - * `SELECT ANY TABLE, UPDATE ANY TABLE BY SCOTT, HR`
 - * `UPDATE ON SCOTT.EMP`

If the unified policy had been applied to all users, then you only need to specify the policy name. For example:

```
NOAUDIT POLICY logons_pol;
```

Related Topics

- [About Enabling Unified Audit Policies](#)
The `AUDIT` statement with the `POLICY` clause enables a unified audit policy, applying for all types of audit options, including object-level options.

30.9.3.3 Example: Disabling a Unified Audit Policy

The `NOAUDIT POLICY` statement disable a unified audit policy using filtering, such as by user name.

[Example 30-50](#) shows examples of how to disable a unified audit policy for a user and for a role.

Example 30-50 Disabling a Unified Audit Policy

```
NOAUDIT POLICY dv_admin_pol BY tjones;
```

```
NOAUDIT POLICY dv_admin_pol BY USERS WITH GRANTED ROLES emp_admin;
```

30.9.4 Dropping Unified Audit Policies

You can use the `DROP AUDIT POLICY` statement to drop a unified audit policy.

- [About Dropping Unified Audit Policies](#)
The `DROP AUDIT POLICY` statement can be used to unified audit policies.
- [Dropping a Unified Audit Policy](#)
To drop a unified audit policy, you must first disable it, and then run the `DROP AUDIT POLICY` statement to remove it.
- [Example: Disabling and Dropping a Unified Audit Policy](#)
The `NOAUDIT POLICY` and `DROP AUDIT POLICY` statements can disable and drop a unified audit policy.

30.9.4.1 About Dropping Unified Audit Policies

The `DROP AUDIT POLICY` statement can be used to unified audit policies.

If a unified audit policy is already enabled for a session, the effect of dropping the policy is not seen by this existing session. Until that time, the unified audit policy's settings remain in effect. For object-related unified audit policies, however, the effect is immediate.

You can find a list of existing unified audit policies by querying the `AUDIT_UNIFIED_POLICIES` data dictionary view.

When you disable an audit policy before dropping it, ensure that you disable it using the same settings that you used to enable it. For example, suppose you enabled the `logon_pol` policy as follows:

```
AUDIT POLICY logon_pol BY HR, OE;
```

Before you can drop it, your `NOAUDIT` statement must include the `HR` and `OE` users as follows:

```
NOAUDIT POLICY logon_pol BY HR, OE;
```

You can drop a common audit policy only from the root and a local audit policy only from the PDB to which it applies.

30.9.4.2 Dropping a Unified Audit Policy

To drop a unified audit policy, you must first disable it, and then run the `DROP AUDIT POLICY` statement to remove it.

- Use the following the following syntax to drop a unified audit policy:

```
DROP AUDIT POLICY policy_name;
```

The unified audit policy drop applies to the current PDB. If the unified audit policy was created as a common unified audit policy, then you cannot drop it from the local PDB.

Related Topics

- [Auditing in a Multitenant Deployment](#)
You can create unified audit policies for individual PDBs and in the root.

30.9.4.3 Example: Disabling and Dropping a Unified Audit Policy

The `NOAUDIT POLICY` and `DROP AUDIT POLICY` statements can disable and drop a unified audit policy.

[Example 30-51](#) shows how to disable and drop a common unified audit policy.

Example 30-51 Disabling and Dropping a Unified Audit Policy

```
CONNECT c##sec_admin
Enter password: password
Connected.

NOAUDIT POLICY dv_admin_pol;

DROP AUDIT POLICY dv_admin_pol
```

30.10 Tutorial: Auditing Nondatabase Users

Auditing nondatabase users who are typical application service accounts is crucial. They are identified in the database using the `CLIENT_IDENTIFIER` attribute.

- [Step 1: Create the User Accounts and Ensure the User OE Is Active](#)
You must first create users and ensure that the user `OE` is active.
- [Step 2: Create the Unified Audit Policy](#)
Next, you are ready to create the unified audit policy.
- [Step 3: Test the Policy](#)
To test the policy, use `OE` must try to select from the `OE.ORDERS` table.
- [Step 4: Remove the Components of This Tutorial](#)
If you no longer need the components of this tutorial, then you can remove them.

30.10.1 Step 1: Create the User Accounts and Ensure the User OE Is Active

You must first create users and ensure that the user `OE` is active.

1. Log in to a PDB as user `SYS` with the `SYSDBA` administrative privilege.

```
sqlplus sys@pdb_name as sysdba
Enter password: password
```

To find the available PDBs in a CDB, log in to the CDB root container and then query the `PDB_NAME` column of the `DBA_PDBS` data dictionary view. To check the current container, run the `show con_name` command.

2. Create the local user `policy_admin`, who will create the fine-grained audit policy.

```
CREATE USER policy_admin IDENTIFIED BY password;
GRANT CREATE SESSION, AUDIT_ADMIN TO policy_admin;
```

Replace `password` with a password that is secure.

3. Create the local user `account_auditor`, who will check the audit trail for this policy.

```
CREATE USER policy_auditor IDENTIFIED BY password;
GRANT CREATE SESSION, AUDIT_VIEWER TO policy_auditor;
```

4. The sample user `OE` will also be used in this tutorial, so query the `DBA_USERS` data dictionary view to ensure that `OE` is not locked or expired.

```
SELECT USERNAME, ACCOUNT_STATUS FROM DBA_USERS WHERE USERNAME = 'OE';
```

The account status should be `OPEN`. If the `DBA_USERS` view lists user `OE` as locked and expired, log in as user `SYSTEM` and then enter the following statement to unlock the `OE` account and create a new password:

```
ALTER USER OE ACCOUNT UNLOCK IDENTIFIED BY password;
```

Replace `password` with a password that is secure. For greater security, do **not** give the `OE` account the same password from previous releases of Oracle Database.

Related Topics

- [Guidelines for Securing Passwords](#)
Oracle provides guidelines for securing passwords in a variety of situations.

30.10.2 Step 2: Create the Unified Audit Policy

Next, you are ready to create the unified audit policy.

1. Connect to the PDB as user `policy_admin`.

```
CONNECT policy_admin@pdb_name
Enter password: password
```

2. Create the following policy:

```
CREATE AUDIT POLICY orders_unified_audpol
  ACTIONS INSERT ON OE.ORDERS, UPDATE ON OE.ORDERS, DELETE ON OE.ORDERS, SELECT ON
  OE.ORDERS
  WHEN 'SYS_CONTEXT(''USERENV'', 'CLIENT_IDENTIFIER') = 'robert''
  EVALUATE PER STATEMENT;

AUDIT POLICY orders_unified_audpol;
```

In this example, the `AUDIT_CONDITION` parameter assumes that the nondatabase user is named `robert`. The policy will monitor any `INSERT`, `UPDATE`, `DELETE`, and `SELECT` statements that `robert` will attempt. Remember that the user's `CLIENT_IDENTIFIER` setting that you enter in the policy is case sensitive and that the policy only recognizes the case used for the identity that you specify here. In other words, later on, if the user session is set to `Robert` or `ROBERT`, the policy's condition will not be satisfied.

30.10.3 Step 3: Test the Policy

To test the policy, use OE must try to select from the OE.ORDERS table.

A unified auditing policy takes effect in the next user session for the users who are being audited. So, before their audit records can be captured, the users must connect to the database *after* the policy has been created.

1. Connect as user OE and then select from the OE.ORDERS table.

```
CONNECT OE@pdb_name
Enter password: password

SELECT COUNT(*) FROM ORDERS;
```

The following output appears:

```
  COUNT(*)
-----
         105
```

2. Connect as user policy_auditor and then check if any audit records were generated.

```
CONNECT policy_auditor@pdb_name
Enter password: password

col dbusername format a10
col client_identifier format a20
col sql_text format a29

SELECT DBUSERNAME, CLIENT_IDENTIFIER, SQL_TEXT FROM UNIFIED_AUDIT_TRAIL
WHERE SQL_TEXT LIKE '%FROM ORDERS%';
```

The following output appears:

```
no rows selected
```

3. Reconnect as user OE, set the client identifier to robert, and then reselect from the OE.ORDERS table.

```
CONNECT OE@pdb_name
Enter password: password

EXEC DBMS_SESSION.SET_IDENTIFIER('robert');

SELECT COUNT(*) FROM ORDERS;
```

The following output should appear:

```
  COUNT(*)
-----
         105
```

4. Reconnect as user auditor and then check the audit trail again.

```
CONNECT policy_auditor@pdb_name
Enter password: password

SELECT DBUSERNAME, CLIENT_IDENTIFIER, SQL_TEXT FROM UNIFIED_AUDIT_TRAIL
WHERE SQL_TEXT LIKE '%FROM ORDERS%';
```

This time, because robert has queried the OE.ORDERS table, the audit trail captures their actions:

```
DBUSERNAME CLIENT_IDENTIFIER SQL_TEXT
-----
OE          robert          SELECT COUNT(*) FROM ORDERS;
```

30.10.4 Step 4: Remove the Components of This Tutorial

If you no longer need the components of this tutorial, then you can remove them.

1. Connect as user `policy_admin`, and then manually disable and drop the `orders_unified_audpol` policy.

```
CONNECT policy_admin@pdb_name
Enter password: password

NOAUDIT POLICY orders_unified_audpol;
DROP AUDIT policy orders_unified_audpol;
```

(Unified audit policies reside in the `SYS` schema, not the schema of the user who created them.)

2. Connect to SQL*Plus as user `SYSTEM`.

```
CONNECT SYSTEM@pdb_name
Enter password: password
```

3. Drop users `policy_admin` and `policy_auditor`.

```
DROP USER policy_admin;
DROP USER policy_auditor;
```

4. If you want, lock and expire `OE`, unless other users want to use this account:

```
ALTER USER OE PASSWORD EXPIRE ACCOUNT LOCK;
```

30.11 Unified Audit Policy Data Dictionary Views

You can query data dictionary and dynamic views to find detailed auditing information about custom unified audit policies.

Table 30-20 lists these views.



Tip:

To find error information about audit policies, check the trace files. The `USER_DUMP_DEST` initialization parameter sets the location of the trace files.

Table 30-20 Views for Use with Custom Unified Audit Policies

View	Description
<code>ALL_AUDIT_POLICIES</code>	Displays information about all fine-grained audit policies
<code>ALL_DEF_AUDIT_OPTS</code>	Lists default object-auditing options that are to be applied when objects are created
<code>AUDIT_UNIFIED_CONTEXTS</code>	Describes application context values that have been configured to be captured in the audit trail
<code>AUDIT_UNIFIED_ENABLED_POLICIES</code>	Describes all unified audit policies that are enabled in the database

Table 30-20 (Cont.) Views for Use with Custom Unified Audit Policies

View	Description
AUDIT_UNIFIED_POLICIES	Describes all unified audit policies created in the database
AUDIT_UNIFIED_POLICY_COMMENTS	Shows the description of each unified audit policy, if a description was entered for the unified audit policy using the <code>COMMENT</code> SQL statement
AUDITABLE_SYSTEM_ACTIONS	Maps the auditable system action numbers to the action names
CDB_UNIFIED_AUDIT_TRAIL	Similar to the <code>UNIFIED_AUDIT_TRAIL</code> view, displays the audit records but from all PDBs in a multitenant environment. This view is available only in the CDB root and must be queried from there.
DBA_SA_AUDIT_OPTIONS	Describes audited Oracle Label Security events performed by users, and indicates if the user's action failed or succeeded
DBA_XS_AUDIT_TRAIL	Displays audit trail information related to Oracle Database Real Application Security
DV\$CONFIGURATION_AUDIT	Displays configuration changes made by Oracle Database Vault administrators
DV\$ENFORCEMENT_AUDIT	Displays user activities that are affected by Oracle Database Vault policies
SYSTEM_PRIVILEGE_MAP (table)	Describes privilege (auditing option) type codes. This table can be used to map privilege (auditing option) type numbers to type names.
UNIFIED_AUDIT_TRAIL	Displays all audit records

Related Topics

- *Oracle Database Reference*

31

Value-Based Auditing with Fine-Grained Audit Policies

Fine-grained auditing enables you to perform value-based auditing to audit access to certain rows based on values in specific columns.

- [Overview of Fine-Grained Auditing](#)
Before you create fine-grained audit policies, you should understand the overall concepts how of fine-grained auditing works.
- [Creating Fine-Grained Audit Policies](#)
The `DBMS_FGA.ADD_POLICY` procedure creates a fine-grained audit policy.
- [Managing Fine-Grained Audit Policies](#)
After you create a fine-grained audit policy, you can alter or drop it.
- [Tutorial: Adding an Email Alert to a Fine-Grained Audit Policy](#)
This tutorial demonstrates how to create a fine-grained audit policy that generates an email alert when users violate the policy.
- [Fine-Grained Audit Policy Data Dictionary Views](#)
You can query data dictionary and dynamic views to find detailed auditing information about fine-grained audit policies.

Related Topics

- [Value-Based Fine-Grained Audit Activities](#)
Use fine-grained auditing if you want to perform value-based auditing to audit access to certain rows based on values in specific columns or if you want to integrate with event handlers within the Oracle database.

31.1 Overview of Fine-Grained Auditing

Before you create fine-grained audit policies, you should understand the overall concepts how of fine-grained auditing works.

- [About Fine-Grained Auditing](#)
Oracle Database enables you to create customized audit policies using fine-grained auditing (FGA), which is available in Oracle Database Enterprise Edition.
- [Where Are Fine-Grained Audit Records Stored?](#)
Fine-grained auditing records are stored in the unified audit trail, which you can view by querying the `UNIFIED_AUDIT_TRAIL` data dictionary view.
- [Who Can Perform Fine-Grained Auditing?](#)
Oracle provides roles for privileges needed to create fine-grained audit policies and to view and analyze fine-grained audit policy data.
- [Fine-Grained Auditing on Tables or Views That Have Oracle VPD Policies](#)
The audit trail captures the VPD predicate for fine-grained audited tables or views that are included in an Oracle VPD policy.

- [Fine-Grained Auditing in a Multitenant Environment](#)
You can create fine-grained audit policies in the CDB root, application root, CDB PDBs, and application PDBs.
- [Fine-Grained Audit Policies with Editions](#)
You can create `DBMS_FGA` policies for use in an editions environment.

Related Topics

- [Value-Based Fine-Grained Audit Activities](#)
Use fine-grained auditing if you want to perform value-based auditing to audit access to certain rows based on values in specific columns or if you want to integrate with event handlers within the Oracle database.

31.1.1 About Fine-Grained Auditing

Oracle Database enables you to create customized audit policies using fine-grained auditing (FGA), which is available in Oracle Database Enterprise Edition.

Use fine-grained auditing if you want to perform value-based auditing to audit access to certain rows based on values in specific columns or if you want to integrate with event handlers within the Oracle database.

Fine-grained auditing enables you to monitor data access based on content of the column values returned. For instance, with fine-grained auditing, you can audit access to a sensitive column such as `SALARY` in the `EMPLOYEES` table only when record values with `SALARY >1500` are retrieved by the query. Fine-grained audit policies also enable you to specify an event handler. Event handlers are PL/SQL functions that Oracle Database calls when an audit condition is triggered. When a SQL query satisfies the fine-grained audit policy conditions (that is, relevant columns and specific data values being accessed), Oracle Database invokes the event handler, which in turn can be configured to message to a database administrator or it can trigger a security alert in an external system. This speeds up the detection of a security violation and enables administrators to respond to the problem sooner.

Two key use-cases where you will want to consider fine-grained audit policies in addition to unified audit policies are:

- When you want to audit access to specific security-relevant columns, and their sensitive data values, such as salaries or Social Security numbers
- Raise alerts on possible security breaches

Fine-grained auditing enables you to monitor data access based on content. It provides granular auditing of queries, and `INSERT`, `UPDATE`, and `DELETE` operations. Some sample instances where you might consider fine-grained auditing includes the following:

- Accessing a table between 9 p.m. and 6 a.m. or on Saturday and Sunday
- Using an IP address from outside the corporate network
- Modifying a sensitive data value above an expected threshold

Fine-grained audit policies are based on simple, user-defined SQL predicates on table objects that act as conditions for selective auditing. The SQL statement is audited during fetching, whenever the policy conditions are met for a row.

Consider using fine-grained audit policies over unified audit policies if you have the following requirements:

- You need row value-based auditing. For instance, you want to audit updates to a salary column when the updated value is higher than a specified threshold, but not otherwise.

- You need to pro-actively notify administrators or other users of specific events in the Oracle database.
- You need to capture differing bind variable values in DML statement for bulk data processing operation using `BULK COLLECT` and `FORALL` in PL/SQL.

 **Note:**

- Fine-grained auditing is supported only with cost-based optimization. For queries using rule-based optimization, fine-grained auditing checks before applying row filtering, which could result in an unnecessary audit event trigger.
- Policies currently in force on an object involved in a flashback query are applied to the data returned from the specified flashback snapshot based on time or system change number (SCN).
- If you want to use fine-grained auditing to audit data that is being directly loaded (for example, using Oracle Warehouse Builder to run DML statements), then Oracle Database transparently makes all direct loads that are performed in the database instance into conventional loads. If you want to preserve the direct loading of data, consider using unified audit policies instead.

31.1.2 Where Are Fine-Grained Audit Records Stored?

Fine-grained auditing records are stored in the unified audit trail, which you can view by querying the `UNIFIED_AUDIT_TRAIL` data dictionary view.

Administrators who have the `AUDIT_ADMIN` or `AUDIT_VIEWER` role can query `UNIFIED_AUDIT_TRAIL` data dictionary view.

The audit trail captures an audit record for each reference of a table or a view within a SQL statement. For example, if you run a `UNION` statement that references the `HR.EMPLOYEES` table twice, then an audit policy for statement generates two audit records, one for each access of the `HR.EMPLOYEES` table.

Related Topics

- [Activities That Are Mandatorily Audited](#)
Certain security sensitive database activities are always audited and such audit configurations cannot be disabled.
- *Oracle Database PL/SQL Packages and Types Reference*

31.1.3 Who Can Perform Fine-Grained Auditing?

Oracle provides roles for privileges needed to create fine-grained audit policies and to view and analyze fine-grained audit policy data.

The fine-grained audit privileges are as follows:

- To create and administer fine-grained audit policies, you must be granted the `AUDIT_ADMIN` role or the `EXECUTE` privilege on the `DBMS_FGA` package. You must also be granted the `ADMINISTER FINE GRAINED AUDIT POLICY` system privilege to administer other schemas than your own schemas. (A user does not need this privilege to administer fine-grained audit policies in their own schema.) To grant the `ADMINISTER FINE GRAINED AUDIT POLICY` privilege:

- Syntax of the `ADMINISTER FINE GRAINED AUDIT POLICY` privilege grant if the fine-grained audit policy is to apply to all non-SYS schemas across the database:

```
GRANT ADMINISTER FINE GRAINED AUDIT POLICY TO grantee;
```

- Syntax of the `ADMINISTER FINE GRAINED AUDIT POLICY` privilege grant if the fine-grained audit policy is to be restricted to a specific schema:

```
GRANT ADMINISTER FINE GRAINED AUDIT POLICY ON SCHEMA schema TO grantee;
```

- To view and analyze fine-grained audit data, you must be granted the `AUDIT_VIEWER` role.

The PL/SQL package is already granted to `AUDIT_ADMIN` role. As with all privileges, an administrator must only grant these roles to trusted users only. You can find the roles that user have been granted by querying the `DBA_ROLE_PRIVS` data dictionary view.

31.1.4 Fine-Grained Auditing on Tables or Views That Have Oracle VPD Policies

The audit trail captures the VPD predicate for fine-grained audited tables or views that are included in an Oracle VPD policy.

This behavior is similar to how the unified audit trail captures the VPD predicate for unified audit policies.

The audit trail also captures internal predicates from Oracle Label Security and Oracle Real Application Security policies.

You do not need to create a special audit policy to capture the VPD predicate audit records. The predicate information is automatically stored in the `RLS_INFO` column of the `UNIFIED_AUDIT_TRAIL` data dictionary view.

Related Topics

- [Auditing of Oracle Virtual Private Database Predicates](#)
The unified audit trail automatically captures the predicates that are used in Oracle Virtual Private Database (VPD) policies.
- *Oracle Database PL/SQL Packages and Types Reference*

31.1.5 Fine-Grained Auditing in a Multitenant Environment

You can create fine-grained audit policies in the CDB root, application root, CDB PDBs, and application PDBs.

Note the following general rules about fine-grained audit policies:

- You cannot create fine-grained audit policies on `SYS` objects.
- You cannot create fine-grained audit policies, either local or application common, for extended data link objects.
- When you create a fine-grained audit policy in the CDB root, the policy cannot be applied to all PDBs. It only applies to objects within the CDB root. (In other words, there is no such thing as a common fine-grained audit policy for the CDB root.) If you want to create a fine-grained audit policy to audit a common object's access in all the PDBs, then you must explicitly create that policy in each PDB and then enable it on the common objects that is accessible in the PDB.

- When you create a fine-grained audit policy in a PDB, it applies only to objects within the PDB. You cannot create one policy for the entire multitenant environment. The policy must be specific to objects within a PDB.
- You can create application common fine-grained audit policies only if you are connected to the application root and only within the `BEGIN/END` block. If you are connected to the application root and create the fine-grained audit policy outside the `BEGIN/END` block, then the fine-grained audit policy is created in the application root.
- You cannot create application common fine-grained audit policies on local PDB objects.
- If the application common fine-grained audit policy has a handler, then this handler must be owned by either an application common user or a CDB common user.
- You can create an application fine-grained audit policy on local (PDB) objects and CDB common objects. Because the policy is local to its container, the object on which the policy is defined is audited only in the particular container where the policy is defined. For example, if you create a fine-grained audit policy in the `hr_pdb` PDB, the object for which you create this policy must exist in the `hr_pdb` PDB.
- You cannot create local fine-grained audit policies in an application PDB on object linked and extended data link objects. On metadata-linked objects are allowed in the fine-grained audit policy.
- Application root local policies are allowed for all application common objects.
- When you create a fine-grained audit policy as a common audit policy in an application root, it will be effective in each PDB that belongs to this application root. Therefore, any access to the application common object and CDB common object (on which the application common fine-grained audit policy is defined) from the application PDB is audited in the fine-grained audit trail in that application PDB.
- When you create scripts for application install, upgrade, patch, or uninstall operations, you can include SQL statements within the `ALTER PLUGGABLE DATABASE app_name BEGIN INSTALL` and `ALTER PLUGGABLE DATABASE app_name END INSTALL` blocks to perform various operations. You can include fine-grained audit policy statements only within these blocks.
- You can only enable, disable, or drop application common fine-grained audit policies from the application root, and from within a `ALTER PLUGGABLE DATABASE app_name BEGIN INSTALL` and `ALTER PLUGGABLE DATABASE app_name END INSTALL` block in a script.

31.1.6 Fine-Grained Audit Policies with Editions

You can create `DBMS_FGA` policies for use in an editions environment.

Note the following:

- You can prepare an application for edition-based redefinition, and cover each table that the application uses with an editioning view. If you do this, then you must move the fine-grained audit policies that protect these tables to the editioning view. You can find information about the currently configured editions by querying the `DBA_EDITIONS` data dictionary view. To find information about fine-grained audit policies, query `DBA_AUDIT_POLICIES`.
- If you plan to use the `DBMS_FGA` package policy across different editions, then you can control the results of the policy: whether the results are uniform across all editions, or specific to the edition in which the policy is used.

Related Topics

- [How Editions Affects the Results of a Global Application Context PL/SQL Package](#)
Global application context packages, Oracle Virtual Private Database packages, and fine-grained audit policies can be used across multiple editions.

31.2 Creating Fine-Grained Audit Policies

The `DBMS_FGA.ADD_POLICY` procedure creates a fine-grained audit policy.

- [About Creating a Fine-Grained Audit Policy](#)
You can create and manage fine-grained audit policies by using the `DBMS_FGA` PL/SQL package.
- [Syntax for Creating a Fine-Grained Audit Policy](#)
The `DBMS_FGA.ADD_POLICY` procedure includes many settings, such as the ability to use a handler for complex auditing.
- [Example: Using DBMS_FGA.ADD_POLICY to Create a Fine-Grained Audit Policy](#)
The `DBMS_FGA.ADD_POLICY` procedure can create a fine-grained audit policy using multiple statement types.
- [Audits of Specific Columns and Rows](#)
You can do value-based auditing to audit access to certain rows based on values in specific columns.

31.2.1 About Creating a Fine-Grained Audit Policy

You can create and manage fine-grained audit policies by using the `DBMS_FGA` PL/SQL package.

Consider the following when you create fine-grained audit policies:

- The `DBMS_FGA` PL/SQL package enables you to add all combinations of the following statements into one policy:
 - `SELECT`
 - `INSERT`
 - `UPDATE`
 - `DELETE`
- For `MERGE` statements:
 - You can audit `MERGE` statements by configuring fine-grained access on the underlying actions of `INSERT` and `UPDATE`.
 - Only one record is generated for each policy for successful `MERGE` operations.

If you plan to create a materialized view on the base table on which you want to create a fine-grained audit policy, then you must create the fine-grained audit policy on the base table *before* you create the materialized view on the same table. Otherwise, any refresh operations on the materialized view will fail with an `ORA-12008: error in materialized view refresh path error`.

When you create a fine-grained audit policy, be aware that sensitive data, such as credit card information, can be recorded in clear text.

To administer fine-grained audit policies, you must have been granted the `AUDIT_ADMIN` role. Note also that the `EXECUTE` privilege for the `DBMS_FGA` package is mandatorily audited.

The audit policy is bound to the table for which you created it. This simplifies the management of audit policies because the policy only needs to be changed once in the database, not in each application. In addition, no matter how a user connects to the database—from an application, a Web interface, or through SQL*Plus or Oracle SQL Developer—Oracle Database records any actions that affect the policy.

If any rows returned from a query match the audit condition that you define, then Oracle Database inserts an audit entry into the unified audit trail. This entry excludes all the information that is reported in the regular audit trail. In other words, only one row of audit information is inserted into the audit trail for every fine-grained audit policy that evaluates to true.

The `DBMS_FGA.ADD_POLICY` procedure creates an audit policy using the supplied predicate as the audit condition.

By default, Oracle Database runs the policy predicate with the privileges of the user who owns the policy. The maximum number of fine-grained policies on any table or view object is 256. Oracle Database stores the policy in the data dictionary table, but you can create the policy on any table or view that is not in the `SYS` schema. The fine-grained policy is only created in the local PDB.

You cannot modify a fine-grained audit policy after you have created it. If you must modify the policy, then drop and recreate it.

You can find information about a fine-grained audit policy by querying the `ALL_AUDIT_POLICIES`, `DBA_AUDIT_POLICIES`, and `USER_AUDIT_POLICIES` views. The `UNIFIED_AUDIT_TRAIL` view contains a column entitled `FGA_POLICY_NAME`, which you can use to filter out rows that were generated using a specific fine-grained audit policy.

Related Topics

- *Oracle Database PL/SQL Packages and Types Reference*

31.2.2 Syntax for Creating a Fine-Grained Audit Policy

The `DBMS_FGA.ADD_POLICY` procedure includes many settings, such as the ability to use a handler for complex auditing.

The `DBMS_FGA.ADD_POLICY` procedure syntax is as follows:

```
DBMS_FGA.ADD_POLICY(
  object_schema      IN  VARCHAR2 DEFAULT NULL,
  object_name        IN  VARCHAR2,
  policy_name        IN  VARCHAR2,
  audit_condition    IN  VARCHAR2 DEFAULT NULL,
  audit_column       IN  VARCHAR2 DEFAULT NULL,
  handler_schema     IN  VARCHAR2 DEFAULT NULL,
  handler_module     IN  VARCHAR2 DEFAULT NULL,
  enable             IN  BOOLEAN DEFAULT TRUE,
  statement_types    IN  VARCHAR2 DEFAULT SELECT,
  audit_trail        IN  BINARY_INTEGER DEFAULT NULL,
  audit_column_opts  IN  BINARY_INTEGER DEFAULT ANY_COLUMNS,
  policy_owner       IN  VARCHAR2 DEFAULT NULL);
```

In this specification:

- `object_schema` specifies the schema of the object to be audited. (If `NULL`, the current log-on user schema is assumed.)
- `object_name` specifies the name of the object to be audited.
- `policy_name` specifies the name of the policy to be created. Ensure that this name is unique.
- `audit_condition` specifies a Boolean condition in a row. `NULL` is allowed and acts as `TRUE`. If you specify `NULL` or no audit condition, then any action on a table with that policy creates an audit record, whether or not rows are returned.

Follow these guidelines:

- Do not include functions, which run the auditable statement on the same base table, in the `audit_condition` setting. For example, suppose you create a function that runs an `INSERT` statement on the `HR.EMPLOYEES` table. The policy's `audit_condition` contains this function and it is for `INSERT` statements (as set by `statement_types`). When the policy is used, the function runs recursively until the system has run out of memory. This can raise the error `ORA-1000: maximum open cursors exceeded` or `ORA-00036: maximum number of recursive SQL levels (50) exceeded`.
- Do not issue the `DBMS_FGA.ENABLE_POLICY` or `DBMS_FGA.DISABLE_POLICY` statement from a function in a policy's condition.
- `audit_column` specifies one or more columns to audit, including hidden columns. If set to `NULL` or omitted, all columns are audited. These can include Oracle Label Security hidden columns or object type columns. The default, `NULL`, causes audit if any column is accessed or affected.
- `handler_schema`: If an alert is used to trigger a response when the policy is violated, specifies the name of the schema that contains the event handler. The default, `NULL`, uses the current schema.
- `handler_module` specifies the name of the event handler. Include the package the event handler is in. This function is invoked only after the first row that matches the audit condition in the query is processed.

Follow these guidelines:

- Do not create recursive fine-grained audit handlers. For example, suppose you create a handler that runs an `INSERT` statement on the `HR.EMPLOYEES` table. The policy that is associated with this handler is for `INSERT` statements (as set by the `statement_types` parameter). When the policy is used, the handler runs recursively until the system has run out of memory. This can raise the error `ORA-1000: maximum open cursors exceeded` or `ORA-00036: maximum number of recursive SQL levels (50) exceeded`.
- Do not issue the `DBMS_FGA.ENABLE_POLICY` or `DBMS_FGA.DISABLE_POLICY` statement from a policy handler. Doing so can raise the `ORA-28144: Failed to execute fine-grained audit handler error`.
- `enable` enables or disables the policy using `true` or `false`. If omitted, the policy is enabled. The default is `TRUE`.
- `statement_types`: Specifies the SQL statements to be audited: `INSERT`, `UPDATE`, `DELETE`, or `SELECT` only. If you want to audit a `MERGE` operation, then set `statement_types` to `'INSERT,UPDATE'`. The default is `SELECT`.
- `audit_trail`: If you have migrated to unified auditing, then Oracle Database ignores this parameter and writes the audit records immediately to the unified audit trail. Starting in Oracle Database 23ai, traditional auditing is desupported, so the `audit_trail` is ignored.

- `audit_column_opts`: If you specify more than one column in the `audit_column` parameter, then this parameter determines whether to audit all or specific columns.
- `policy_owner` is the user who owns the fine-grained auditing policy. However, this setting is not a user-supplied argument. The Oracle Data Pump client uses this setting internally to recreate the fine-grained audit policies appropriately.

Related Topics

- [Audits of Specific Columns and Rows](#)
You can do value-based auditing to audit access to certain rows based on values in specific columns.
- *Oracle Database PL/SQL Packages and Types Reference*

31.2.3 Example: Using DBMS_FGA.ADD_POLICY to Create a Fine-Grained Audit Policy

The `DBMS_FGA.ADD_POLICY` procedure can create a fine-grained audit policy using multiple statement types.

[Example 31-1](#) shows how to audit statements `INSERT`, `UPDATE`, `DELETE`, and `SELECT` on table `HR.EMPLOYEES`.

Note that this example omits the `audit_column_opts` parameter, because it is not a mandatory parameter.

Example 31-1 Using DBMS_FGA.ADD_POLICY to Create a Fine-Grained Audit Policy

```
BEGIN
  DBMS_FGA.ADD_POLICY(
    object_schema    => 'HR',
    object_name      => 'EMPLOYEES',
    policy_name      => 'chk_hr_employees',
    audit_column     => 'SALARY',
    enable           => TRUE,
    statement_types  => 'INSERT, UPDATE, SELECT, DELETE');
END;
/
```

After you create the policy, if you query the `DBA_AUDIT_POLICIES` view, you will find the new policy listed:

```
SELECT POLICY_NAME FROM DBA_AUDIT_POLICIES;
```

```
POLICY_NAME
-----
CHK_HR_EMPLOYEES
```

Afterwards, any of the following SQL statements log an audit event record.

```
SELECT COUNT(*) FROM HR.EMPLOYEES WHERE COMMISSION_PCT = 20 AND SALARY > 4500;
```

```
SELECT SALARY FROM HR.EMPLOYEES WHERE DEPARTMENT_ID = 50;
```

```
DELETE FROM HR.EMPLOYEES WHERE SALARY > 1000000;
```

31.2.4 Audits of Specific Columns and Rows

You can do value-based auditing to audit access to certain rows based on values in specific columns.

To accomplish this, use the `audit_column` parameter of the `DBMS_FGA.ADD_POLICY` procedure to specify one or more sensitive columns. Use the `audit_condition` boolean parameter to audit data in specific rows. Consider using unified audit policy if you do not have a need to do value-based auditing.

The following settings enable you to perform an audit if anyone in Department 50 (`DEPARTMENT_ID = 50`) tries to access the `SALARY` and `COMMISSION_PCT` columns.

```
audit_condition => 'DEPARTMENT_ID = 50',  
audit_column    => 'SALARY,COMMISSION_PCT,'
```

As you can see, this feature is enormously beneficial. It not only enables you to pinpoint particularly important types of data to audit, but it provides increased protection for columns that contain sensitive data, such as Social Security numbers, salaries, patient diagnoses, and so on.

If the `audit_column` lists more than one column, then you can use the `audit_column_opts` parameter to specify whether a statement is audited when the query references *any* column specified in the `audit_column` parameter or only when *all* columns are referenced. For example:

```
audit_column_opts => DBMS_FGA.ANY_COLUMNS,  
audit_column_opts => DBMS_FGA.ALL_COLUMNS,
```

If you do not specify a relevant column, then auditing applies to all columns.

Related Topics

- [Unified Auditing with Configurable Conditions](#)
You can use the `CREATE AUDIT POLICY` statement to create conditions for a unified audit policy.
- [Oracle Database PL/SQL Packages and Types Reference](#)

31.3 Managing Fine-Grained Audit Policies

After you create a fine-grained audit policy, you can alter or drop it.

- [Enabling a Fine-Grained Audit Policy](#)
The `DBMS_FGA.ENABLE_POLICY` procedure enables a fine-grained audit policy.
- [Disabling a Fine-Grained Audit Policy](#)
The `DBMS_FGA.DISABLE_POLICY` procedure disables a fine-grained audit policy.
- [Dropping a Fine-Grained Audit Policy](#)
The `DBMS_FGA.DROP_POLICY` procedure drops a fine-grained audit policy.

31.3.1 Enabling a Fine-Grained Audit Policy

The `DBMS_FGA.ENABLE_POLICY` procedure enables a fine-grained audit policy.

- Use the following syntax to enable a fine-grained audit policy:

```
DBMS_FGA.ENABLE_POLICY(
  object_schema VARCHAR2,
  object_name   VARCHAR2,
  policy_name   VARCHAR2,
  enable        BOOLEAN);
```

For example, to reenable the `chk_hr_emp` policy by using the `DBMS_FGA.ENABLE_POLICY` procedure

```
BEGIN
  DBMS_FGA.ENABLE_POLICY(
    object_schema => 'HR',
    object_name   => 'EMPLOYEES',
    policy_name   => 'chk_hr_employees',
    enable        => TRUE);
END;
/
```

Related Topics

- *Oracle Database PL/SQL Packages and Types Reference*

31.3.2 Disabling a Fine-Grained Audit Policy

The `DBMS_FGA.DISABLE_POLICY` procedure disables a fine-grained audit policy.

- Use the following syntax to disable a fine-grained audit policy:

```
DBMS_FGA.DISABLE_POLICY(
  object_schema VARCHAR2,
  object_name   VARCHAR2,
  policy_name   VARCHAR2);
```

For example:

```
BEGIN
  DBMS_FGA.DISABLE_POLICY(
    object_schema => 'HR',
    object_name   => 'EMPLOYEES',
    policy_name   => 'chk_hr_employees');
END;
/
```

Related Topics

- *Oracle Database PL/SQL Packages and Types Reference*

31.3.3 Dropping a Fine-Grained Audit Policy

The `DBMS_FGA.DROP_POLICY` procedure drops a fine-grained audit policy.

Oracle Database automatically drops the audit policy if you remove the object specified in the `object_name` parameter of the `DBMS_FGA.ADD_POLICY` procedure, or if you drop the user who created the audit policy.

- Use the following syntax to drop a fine-grained audit policy:

```
DBMS_FGA.DROP_POLICY(
  object_schema VARCHAR2,
  object_name   VARCHAR2,
  policy_name   VARCHAR2);
```

For example:

```
BEGIN
  DBMS_FGA.DROP_POLICY(
    object_schema => 'HR',
    object_name   => 'EMPLOYEES',
    policy_name   => 'chk_hr_employees');
END;
/
```

Related Topics

- [Oracle Database PL/SQL Packages and Types Reference](#)

31.4 Tutorial: Adding an Email Alert to a Fine-Grained Audit Policy

This tutorial demonstrates how to create a fine-grained audit policy that generates an email alert when users violate the policy.

- [About This Tutorial](#)
This tutorial shows how you can add an email alert to a fine-grained audit policy that goes into effect when a user (or an intruder) violates the policy.
- [Step 1: Install and Configure the UTL_MAIL PL/SQL Package](#)
The `UTL_MAIL` PL/SQL manages email that includes commonly used email features, such as attachments, CC, and BCC.
- [Step 2: Create User Accounts](#)
You must create an administrative account and an auditor user.
- [Step 3: Configure an Access Control List File for Network Services](#)
An access control list (ACL) file can be used to enable fine-grained access to external network services.
- [Step 4: Create the Email Security Alert PL/SQL Procedure](#)
The email security alert PL/SQL procedure generates a message describing the violation and then sends this message to the appropriate users.
- [Step 5: Create and Test the Fine-Grained Audit Policy Settings](#)
The fine-grained audit policy will trigger the alert when the policy is violated.
- [Step 6: Test the Alert](#)
With the components in place, you are ready to test the alert.
- [Step 7: Remove the Components of This Tutorial](#)
If you no longer need the components of this tutorial, then you can remove them.

31.4.1 About This Tutorial

This tutorial shows how you can add an email alert to a fine-grained audit policy that goes into effect when a user (or an intruder) violates the policy.

 **Note:**

- To complete this tutorial, you must use a database that has an SMTP server.
- This tutorial applies to the current PDB only.

To add an email alert to a fine-grained audit policy, you first must create a procedure that generates the alert, and then use the following `DBMS_FGA.ADD_POLICY` parameters to call this function when someone violates this policy:

- `handler_schema`: The schema in which the handler event is stored
- `handler_module`: The name of the event handler

The alert can come in any form that best suits your environment: an email or pager notification, updates to a particular file or table, and so on. Creating alerts also helps to meet certain compliance regulations, such as California Senate Bill 1386. In this tutorial, you will create an email alert.

In this tutorial, you create an email alert that notifies a security administrator that a Human Resources representative is trying to select or modify salary information in the `HR.EMPLOYEES` table. The representative is permitted to make changes to this table, but to meet compliance regulations, we want to create a record of all salary selections and modifications to the table.

31.4.2 Step 1: Install and Configure the UTL_MAIL PL/SQL Package

The `UTL_MAIL` PL/SQL manages email that includes commonly used email features, such as attachments, CC, and BCC.

You must install and configure this package before you can use it. It is not installed and configured by default.

1. Log in to a PDB as user `SYS` with the `SYSDBA` administrative privilege.

```
sqlplus sys@pdb_name as sysdba
Enter password: password
```

To find the available PDBs in a CDB, log in to the CDB root container and then query the `PDB_NAME` column of the `DBA_PDBS` data dictionary view. To check the current container, run the `show con_name` command.

2. Install the `UTL_MAIL` package.

```
@$ORACLE_HOME/rdbms/admin/utlmail.sql
@$ORACLE_HOME/rdbms/admin/prvtmail.plb
```

The `UTL_MAIL` package enables you to manage email.

Be aware that currently, the `UTL_MAIL` PL/SQL package does not support SSL servers.

3. Check the current value of the `SMTP_OUT_SERVER` initialization parameter, and make a note of this value so that you can restore it when you complete this tutorial.

For example:

```
SHOW PARAMETER SMTP_OUT_SERVER
```

If the `SMTP_OUT_SERVER` parameter has already been set, then output similar to the following appears:

NAME	TYPE	VALUE
SMTP_OUT_SERVER	string	some_imap_server.example.com

4. Issue the following ALTER SYSTEM statement:

```
ALTER SYSTEM SET SMTP_OUT_SERVER='imap_mail_server.example.com';
```

Replace *imap_mail_server.example.com* with the name of your SMTP server, which you can find in the account settings in your email tool. Enclose these settings in quotation marks. For example:

```
ALTER SYSTEM SET SMTP_OUT_SERVER='my_imap_server.example.com';
```

5. Connect as SYS using the SYSOPER privilege and then restart the database.

```
CONNECT SYS@pdb_name AS SYSOPER
Enter password: password
```

```
SHUTDOWN IMMEDIATE
STARTUP
```

6. Ensure that the SMTP_OUT_SERVER parameter setting is correct.

```
CONNECT SYS@pdb_name AS SYSDBA
Enter password: password
```

```
SHOW PARAMETER SMTP_OUT_SERVER
```

Output similar to the following appears:

NAME	TYPE	VALUE
SMTP_OUT_SERVER	string	my_imap_server.example.com

Related Topics

- [Oracle Database PL/SQL Packages and Types Reference](#)

31.4.3 Step 2: Create User Accounts

You must create an administrative account and an auditor user.

1. Ensure that you are connected as SYS using the SYSDBA administrative privilege, and then create the *fga_admin* user, who will create the fine-grained audit policy.

For example:

```
CONNECT SYS@pdb_name AS SYSDBA
Enter password: password

CREATE USER fga_admin IDENTIFIED BY password;
GRANT CREATE SESSION, CREATE PROCEDURE, AUDIT_ADMIN TO fga_admin;
GRANT ADMINISTER FINE GRAINED AUDIT POLICY TO fga_admin;
GRANT EXECUTE ON UTL_TCP TO fga_admin;
GRANT EXECUTE ON UTL_SMTP TO fga_admin;
GRANT EXECUTE ON UTL_MAIL TO fga_admin;
GRANT EXECUTE ON DBMS_NETWORK_ACL_ADMIN TO fga_admin;
```

Replace *password* with a password that is secure.

The UTL_TCP, UTL_SMTP, UTL_MAIL, and DBMS_NETWORK_ACL_ADMIN PL/SQL packages are used by the email security alert that you create.

2. Create the auditor user, who will check the audit trail for this policy.

```
GRANT CREATE SESSION TO fga_auditor IDENTIFIED BY password;
GRANT AUDIT_VIEWER TO fga_auditor;
```

3. Connect as user SYSTEM.

```
CONNECT SYSTEM@pdb_name
Enter password: password
```

4. Ensure that the HR schema account is unlocked and has a password. If necessary, unlock HR and grant this user a password.

```
SELECT USERNAME, ACCOUNT_STATUS FROM DBA_USERS WHERE USERNAME = 'HR';
```

The account status should be OPEN. If the DBA_USERS view lists user HR as locked and expired, then enter the following statement to unlock the HR account and create a new password:

```
ALTER USER HR ACCOUNT UNLOCK IDENTIFIED BY password;
```

Create a password that is secure. For greater security, do **not** give the HR account the same password from previous releases of Oracle Database.

5. Create a user account for Susan Mavris, who is an HR representative whose actions you will audit, and then grant this user access to the HR.EMPLOYEES table.

```
GRANT CREATE SESSION TO smavris IDENTIFIED BY password;
GRANT SELECT, INSERT, UPDATE, DELETE ON HR.EMPLOYEES TO SMAVRIS;
```

Related Topics

- [Guidelines for Securing Passwords](#)
Oracle provides guidelines for securing passwords in a variety of situations.

31.4.4 Step 3: Configure an Access Control List File for Network Services

An access control list (ACL) file can be used to enable fine-grained access to external network services.

Before you can use PL/SQL network utility packages such as UTL_MAIL, you must configure this type of access control list (ACL) file.

1. Connect to the PDB as user fga_admin.

```
CONNECT fga_admin@pdb_name
Enter password: password
```

2. Configure the following access control setting and its privilege definitions.

```
BEGIN
  DBMS_NETWORK_ACL_ADMIN.APPEND_HOST_ACE(
    host          => 'SMTP_OUT_SERVER_setting',
    lower_port    => 25,
    ace           => xs$acl_type(privilege_list => xs$name_list('smtp'),
                                principal_name => 'FGA_ADMIN',
                                principal_type => xs_acl.p_type_db));
END;
/
```

In this example:

- *SMTP_OUT_SERVER_setting*: Enter the `SMTP_OUT_SERVER` setting that you set for the `SMTP_OUT_SERVER` parameter when you installed and configured the `UTL_MAIL` PL/SQL package. This setting should match exactly the setting that your email tool specifies for its outgoing server.
- *lower_port*: Enter the port number that your email tool specifies for its outgoing server. Typically, this setting is 25. Enter this value for the `lower_port` setting. (Currently, the `UTL_MAIL` package does not support SSL. If your email server is an SSL server, then enter 25 for the port number, even if the email server uses a different port number.)
- *ace*: Define the privileges here.

Related Topics

- [Step 1: Install and Configure the UTL_MAIL PL/SQL Package](#)
The `UTL_MAIL` PL/SQL manages email that includes commonly used email features, such as attachments, CC, and BCC.
- [Managing Fine-Grained Access in PL/SQL Packages and Types](#)
Oracle Database provides PL/SQL packages and types for fine-grained access to control access to external network services and wallets.

31.4.5 Step 4: Create the Email Security Alert PL/SQL Procedure

The email security alert PL/SQL procedure generates a message describing the violation and then sends this message to the appropriate users.

- As user `fga_admin`, create the following procedure.

```
CREATE OR REPLACE PROCEDURE email_alert (sch varchar2, tab varchar2, pol
varchar2)
AS
msg varchar2(20000) := 'HR.EMPLOYEES table violation. The time is: ';
BEGIN
  msg := msg||TO_CHAR(SYSDATE, 'Day DD MON, YYYY HH24:MI:SS');
  UTL_MAIL.SEND (
    sender      => 'youremail@example.com',
    recipients => 'recipientemail@example.com',
    subject     => 'Table modification on HR.EMPLOYEES',
    message     => msg);
END email_alert;
/
```

In this example:

- `CREATE OR REPLACE PROCEDURE ...AS`: You must include a signature that describes the schema name (`sch`), table name (`tab`), and the name of the audit procedure (`pol`) that you will define in audit policy in the next step.
- `sender` and `recipients`: Replace `youremail@example.com` with your email address, and `recipientemail@example.com` with the email address of the person you want to receive the notification.

31.4.6 Step 5: Create and Test the Fine-Grained Audit Policy Settings

The fine-grained audit policy will trigger the alert when the policy is violated.

1. As user `fga_admin`, create the `chk_hr_emp` policy fine-grained audit policy as follows.

```

BEGIN
  DBMS_FGA.ADD_POLICY (
    object_schema => 'HR',
    object_name   => 'EMPLOYEES',
    policy_name   => 'CHK_HR_EMP',
    audit_column  => 'SALARY',
    handler_schema => 'FGA_ADMIN',
    handler_module => 'EMAIL_ALERT',
    enable        => TRUE,
    statement_types => 'SELECT, UPDATE');
END;
/

```

2. Commit the changes you have made to the database.

```
COMMIT;
```

3. Test the settings that you have created so far.

```
EXEC email_alert ('hr', 'employees', 'chk_hr_emp');
```

SQL*Plus should display a PL/SQL procedure successfully completed message, and in a moment, depending on the speed of your email server, you should receive the email alert.

If you receive an ORA-24247: network access denied by access control list (ACL) error followed by ORA-06512: at *stringline string* errors, then check the settings in the access control list file.

31.4.7 Step 6: Test the Alert

With the components in place, you are ready to test the alert.

1. Connect to the PDB as user `smavris`, check your salary, and give yourself a nice raise.

```

CONNECT smavris@pdb_name
Enter password: password

SELECT SALARY FROM HR.EMPLOYEES WHERE LAST_NAME = 'Mavris';

SALARY
-----
6500

UPDATE HR.EMPLOYEES SET SALARY = 38000 WHERE LAST_NAME = 'Mavris';

```

By now, depending on the speed of your email server, you (or your recipient) should have received an email with the subject header `Table modification on HR.EMPLOYEES` notifying you of the tampering of the `HR.EMPLOYEES` table. Now all you need to do is to query the `UNIFIED_AUDIT_TRAIL` data dictionary view to find who the violator is.

2. As user `fga_auditor`, query the `UNIFIED_AUDIT_TRAIL` data dictionary view as follows:

```

CONNECT fga_auditor@pdb_name
Enter password: password

col dbusername format a20
col sql_text format a66
col audit_type format a17

SELECT DBUSERNAME, SQL_TEXT, AUDIT_TYPE
FROM UNIFIED_AUDIT_TRAIL
WHERE OBJECT_SCHEMA = 'HR' AND OBJECT_NAME = 'EMPLOYEES';

```

Output similar to the following appears:

DBUSERNAME	SQL_TEXT	AUDIT_TYPE
SMAVRIS	UPDATE HR.EMPLOYEES SET SALARY = 38000 WHERE LAST_NAME = 'Mavris'	FineGrainedAudit

The audit trail captures the SQL statement that Susan Mavris ran that affected the `SALARY` column in the `HR.EMPLOYEES` table. The first statement that Susan ran, in which she asked about her current salary, was not recorded because it was not affected by the audit policy. This is because Oracle Database runs the audit function as an autonomous transaction, committing only the actions of the `handler_module` setting and not any user transaction. The function has no effect on any user SQL transaction.

31.4.8 Step 7: Remove the Components of This Tutorial

If you no longer need the components of this tutorial, then you can remove them.

1. Connect to SQL*Plus as user `SYSTEM` privilege, and then drop users `fga_admin` (including the objects in the `fga_admin` schema), `fga_auditor`, and `smavris`.

```
CONNECT SYSTEM@pdb_name
Enter password: password
```

```
DROP USER fga_admin CASCADE;
DROP USER fga_auditor;
DROP USER smavris;
```

2. Connect as user `HR` and remove the loftiness of Susan Mavris's salary.

```
CONNECT HR@pdb_name
Enter password: password
```

```
UPDATE HR.EMPLOYEES SET SALARY = 6500 WHERE LAST_NAME = 'Mavris';
```

3. If you want, lock and expire `HR`, unless other users want to use this account:

```
ALTER USER HR PASSWORD EXPIRE ACCOUNT LOCK;
```

4. Issue the following `ALTER SYSTEM` statement to restore the `SMTP_OUT_SERVER` parameter to the previous value, from Step 4 under [Step 1: Install and Configure the UTL_MAIL PL/SQL Package](#):

```
ALTER SYSTEM SET SMTP_OUT_SERVER="previous_value";
```

Enclose this setting in quotation marks. For example:

```
ALTER SYSTEM SET SMTP_OUT_SERVER="some_imap_server.example.com"
```

5. Connect to the CDB root as a user who has the `SYSDBA` administrative privilege.

```
CONNECT / AS SYSDBA
```

6. Close and then reopen the PDB.

```
ALTER PLUGGABLE DATABASE pdb_name CLOSE IMMEDIATE;
ALTER PLUGGABLE DATABASE pdb_name OPEN;
```

31.5 Fine-Grained Audit Policy Data Dictionary Views

You can query data dictionary and dynamic views to find detailed auditing information about fine-grained audit policies.

[Table 30-20](#) lists these views.

**Tip:**

To find error information about audit policies, check the trace files. The `USER_DUMP_DEST` initialization parameter sets the location of the trace files.

Table 31-1 Views for Use with Fine-Grained Audit Policies

View	Description
<code>ALL_AUDIT_POLICIES</code>	Displays information about all fine-grained audit policies
<code>ALL_DEF_AUDIT_OPTS</code>	Lists default object-auditing options that are to be applied when objects are created
<code>AUDITABLE_SYSTEM_ACTIONS</code>	Maps the auditable system action numbers to the action names
<code>CDB_UNIFIED_AUDIT_TRAIL</code>	Similar to the <code>UNIFIED_AUDIT_TRAIL</code> view, displays the audit records but from all PDBs in a multitenant environment. This view is available only in the CDB root and must be queried from there.
<code>DBA_AUDIT_POLICIES</code>	Displays information about fine-grained audit policies
<code>DBA_SA_AUDIT_OPTIONS</code>	Describes audited Oracle Label Security events performed by users, and indicates if the user's action failed or succeeded
<code>SYSTEM_PRIVILEGE_MAP</code> (table)	Describes privilege (auditing option) type codes. This table can be used to map privilege (auditing option) type numbers to type names.
<code>USER_AUDIT_POLICIES</code>	Displays information about all fine-grained audit policies on table and views owned by the current user
<code>UNIFIED_AUDIT_TRAIL</code>	Displays all audit records

Related Topics

- *Oracle Database Reference*

Administering the Audit Trail

Properly managing the audit trail on your databases ensures efficient performance and optimum use of the disk space. Users granted the `AUDIT_ADMIN` role can manage, archive, and purge audit trail.

- [Managing the Unified Audit Trail](#)
Unified auditing is enabled by default, and audit trail management ensures audit configuration is efficient for your needs.
- [Archiving the Audit Trail](#)
To maintain the integrity and reliability of audit data, keep only minimal required audit data locally in the database.
- [Purging Audit Trail Records](#)
The `DBMS_AUDIT_MGMT` PL/SQL package can schedule automatic purge jobs, manually purge audit records, and perform other audit trail operations.
- [Audit Trail Management Data Dictionary Views](#)
Oracle Database provides data dictionary views that list information about audit trail management settings.

32.1 Managing the Unified Audit Trail

Unified auditing is enabled by default, and audit trail management ensures audit configuration is efficient for your needs.

- [How and Where Unified Audit Records Are Created](#)
Auditing is always enabled. Oracle Database generates audit records during or after the execution phase of the audited SQL statements.
- [Sizing Recommendations for Unified Auditing](#)
Unified audit trail records require at least 50 percent more disk space than traditional audit records.
- [How Audit Trail Records Are Written to the AUDSYS Schema](#)
Oracle Database automatically writes audit records to an internal relational table in the `AUDSYS` schema.
- [Writing the Unified Audit Trail Records to SYSLOG or the Windows Event Viewer](#)
You can write the unified audit trail records to SYSLOG or the Windows Event Viewer by setting an initialization parameter.
- [How Unified Audit Records are Written to the Operating System](#)
When the database cannot write audit trail records in the database itself, Oracle Database writes these records to operating system spillover audit files (`.bin` format).
- [Moving Operating System Audit Records into the Unified Audit Trail](#)
Audit records that have been written to the spillover audit files can be moved to the unified audit trail database table.
- [Improving the Performance of Queries and Purge Operations](#)
If the partition on which the `AUDSYS.AUD$UNIFIED` table is located is too large, then queries to and purges of the `UNIFIED_AUDIT_TRAIL` data dictionary view may take a long time to complete.

- [Using Oracle Data Pump to Export and Import Unified Audit Trail Records](#)
You can include the unified audit trail in Oracle Database Pump export and import dump files.
- [How Do Cursors Affect Auditing?](#)
For each execution of an auditable operation within a cursor, Oracle Database inserts one audit record into the audit trail.

Related Topics

- [Purging Audit Trail Records](#)
The `DBMS_AUDIT_MGMT` PL/SQL package can schedule automatic purge jobs, manually purge audit records, and perform other audit trail operations.

32.1.1 How and Where Unified Audit Records Are Created

Auditing is always enabled. Oracle Database generates audit records during or after the execution phase of the audited SQL statements.

The unified audit records are written immediately to disk to an internal relational table in the `AUDSYS` schema. In the previous release, the unified audit records were written to SecureFile LOBs. The partitioned version of this table is based on the `EVENT_TIMESTAMP` timestamp as a partition key with a default partition interval of once a day. If the database version does not support partitioning, then the internal table is a regular, non-partitioned table.



Note:

If you had migrated to unified auditing in Oracle Database 12c release 1 (12.1), then you can manually transfer the unified audit records from the SecureFile LOBS to this internal table. If the version of the database that you are using supports partitioned tables, then this internal table is a partitioned table. In this case, you can modify the partition interval of the table by using the

`DBMS_AUDIT_MGMT.ALTER_PARTITION_INTERVAL` procedure.

The generation and insertion of an audit trail record is independent of the user transaction being committed. That is, even if a user transaction is rolled back, the audit trail record remains committed.

Statement and privilege audit options from unified audit policies that are in effect at the time a database user connects to the database remain in effect for the duration of the session. When an unified audit policy is created and enabled, it will take effect immediately in the on-going session of the user on whom that policy is enabled without requiring that user to restart the database session. This holds true even when the unified audit policy gets disabled as well. However, any modifications (with respect to the statement audit option, privilege audit option, and audit conditions) to the existing unified audit policy definition using `ALTER AUDIT POLICY` statement will take effect in the subsequent sessions of the users on whom that policy is enabled.

In contrast, changes to schema object audit options become immediately effective for current sessions.

By default, audit trail records are written to the `AUDSYS` schema in the `SYSAUX` tablespace. Oracle recommends that you designate a different tablespace, including the one that is encrypted, by using the `DBMS_AUDIT_MGMT.SET_AUDIT_TRAIL_LOCATION` procedure.

Example 32-1 Designate a different tablespace by using**DBMS_AUDIT_MGMT.SET_AUDIT_TRAIL_LOCATION**

1. Create a dedicated auto segment space managed (ASSM) tablespace for unified auditing:

```
CREATE TABLESPACE auto_seg_audit_tablespace DATAFILE 'DiskGroup_name' SIZE
1M
EXTENT MANAGEMENT LOCAL
SEGMENT SPACE MANAGEMENT AUTO;
```

2. Designate the tablespace for unified auditing:

```
BEGIN
DBMS_AUDIT_MGMT.SET_AUDIT_TRAIL_LOCATION(
audit_trail_type          => DBMS_AUDIT_MGMT.AUDIT_TRAIL_UNIFIED,
audit_trail_location_value => 'auto_seg_audit_tablespace');
END;
```

Related Topics

- [How Audit Trail Records Are Written to the AUDSYS Schema](#)
Oracle Database automatically writes audit records to an internal relational table in the AUDSYS schema.
- [Activities That Are Mandatorily Audited](#)
Certain security sensitive database activities are always audited and such audit configurations cannot be disabled.
- [Oracle Database Upgrade Guide](#)
- [DBMS_AUDIT_MGMT.SET_AUDIT_TRAIL_LOCATION in the Oracle Database PL/SQL Packages and Types Reference](#)

32.1.2 Sizing Recommendations for Unified Auditing

Unified audit trail records require at least 50 percent more disk space than traditional audit records.

As a best practice, Oracle recommends that you archive and purge unified audit trail records on a regular basis.

Related Topics

- [Archiving the Audit Trail](#)
To maintain the integrity and reliability of audit data, keep only minimal required audit data locally in the database.
- [Purging Audit Trail Records](#)
The DBMS_AUDIT_MGMT PL/SQL package can schedule automatic purge jobs, manually purge audit records, and perform other audit trail operations.

32.1.3 How Audit Trail Records Are Written to the AUDSYS Schema

Oracle Database automatically writes audit records to an internal relational table in the AUDSYS schema.

Writing audit records to a relational table in the AUDSYS schema prevents the risk of audit records being lost in the event of an instance crash or during a SHUTDOWN ABORT operation. By

default, the `AUDSYS` schema is dictionary protected, which means that other users cannot use system privileges (including `ANY` privileges) to modify or tamper with its data.

 **Note:**

In Oracle Database 12c release 1 (12.1), you had the option of queuing the audit records in memory (queued-write mode) and be written periodically to the `AUDSYS` schema audit table. However, starting with Oracle Database 12c release 2 (12.2), immediate-write mode and queued-write mode are deprecated. The parameters that controlled them (`DBMS_AUDIT_MGMT.AUDIT_TRAIL_IMMEDIATE_WRITE` and `DBMS_AUDIT_MGMT.AUDIT_TRAIL_QUEUED_WRITE`), while still viewable, no longer have any functionality.

If you have upgraded from Oracle Database 12c release 1 (12.1) and migrated to unified auditing in that release, then Oracle recommends that you use the `DBMS_AUDIT_MGMT.TRANSFER_UNIFIED_AUDIT_RECORDS` procedure to transfer the audit records as generated in the previous release to the `AUDSYS` audit internal table. *Oracle Database Upgrade Guide* provides information about transferring unified audit records after an upgrade.

Related Topics

- [Oracle Database Upgrade Guide](#)

32.1.4 Writing the Unified Audit Trail Records to SYSLOG or the Windows Event Viewer

You can write the unified audit trail records to SYSLOG or the Windows Event Viewer by setting an initialization parameter.

- [About Writing the Unified Audit Trail Records to SYSLOG or the Windows Event Viewer](#)
With this feature, you can copy some of the key unified audit fields to SYSLOG or the Windows Event Viewer.
- [Enabling SYSLOG and Windows Event Viewer Captures for the Unified Audit Trail](#)
You can write a subset of unified audit trail records to the UNIX SYSLOG or to the Windows Event Viewer.

32.1.4.1 About Writing the Unified Audit Trail Records to SYSLOG or the Windows Event Viewer

With this feature, you can copy some of the key unified audit fields to SYSLOG or the Windows Event Viewer.

Only key fields of unified audit records in the `UNIFIED_AUDIT_TRAIL` data dictionary view are copied to SYSLOG. SYSLOG records in a unified audit environment provide proof of operational integrity.

You can configure this feature on both UNIX and Microsoft Windows systems. On Windows systems, you either enable it or disable it. If enabled, it writes the records to the Windows Event Viewer.

On UNIX systems, you can fine-tune the capture of unified audit trail records for SYSLOG to specify the facility where the SYSLOG records are sent and the severity level of the records (for example, `DEBUG` if it is capturing debugging-related messages).

[Table 32-1](#) maps the names given to the unified audit records fields that are written to SYSLOG and the Windows Event Viewer to the corresponding column names in the `UNIFIED_AUDIT_TRAIL` view.

Table 32-1 Audit Record Field Names for SYSLOG and the Windows Event Viewer

Field Name	Column Name in UNIFIED_AUDIT_TRAIL	Column Type	Column Description
TYPE	AUDIT_TYPE	NUMBER	Type of the audit record
DBID	DBID	NUMBER	Database identifier
SESID	SESSION_ID	NUMBER	Session identifier
CLIENTID	CLIENT_IDENTIFIER	VARCHAR2	Client identifier in the session
STMTID	STATEMENT_ID	NUMBER	Identifier for each statement run in the system
DBUSER	DB_USERNAME	VARCHAR2	Session user
CURUSER	CURRENT_USER	VARCHAR2	Effective user for the audited event
ACTION	ACTION	NUMBER	Action code of the audited event
RETCODE	RETURN_CODE	NUMBER	Return code for the audited event
SCHEMA	OBJECT_SCHEMA	VARCHAR2	Schema name of the object
OBJNAME	OBJECT_NAME	VARCHAR2	Name of the object
PDB_GUID	NULL (there are no columns in UNIFIED_AUDIT_TRAIL for this field)	VARCHAR2	GUID of the container in which the unified audit record is generated

32.1.4.2 Enabling SYSLOG and Windows Event Viewer Captures for the Unified Audit Trail

You can write a subset of unified audit trail records to the UNIX SYSLOG or to the Windows Event Viewer.

1. Locate the `init.ora` initialization file, which by default is in the `$ORACLE_HOME/dbs` directory.
2. Edit the `init.ora` file to include the `UNIFIED_AUDIT_SYSTEMLOG` parameter.

You can set `UNIFIED_AUDIT_SYSTEMLOG` in either the CDB root or in a PDB.

In an Oracle Database Real Application Clusters (Oracle RAC) environment, set `UNIFIED_AUDIT_SYSTEMLOG` to the same value on each Oracle RAC instance.

- On Windows, set `UNIFIED_AUDIT_SYSTEMLOG` to either `TRUE` or `FALSE`. `TRUE` writes the `SYSLOG` values to the Windows Event Viewer; `FALSE` disables the parameter. On Windows, the default is `FALSE`. For example:

```
UNIFIED_AUDIT_SYSTEMLOG = TRUE
```

- On UNIX systems, use the following syntax:

```
UNIFIED_AUDIT_SYSTEMLOG = 'facility_clause.priority_clause'
```

There is no default setting for `UNIFIED_AUDIT_SYSTEMLOG` on UNIX systems.

In this specification:

- *facility_clause* refers to the facility to which you will write the audit trail records. Valid choices are `USER` and `LOCAL`. If you enter `LOCAL`, then optionally append `0–7` to designate a local custom facility for the `SYSLOG` records.
- *priority_clause* refers to the type of warning in which to categorize the record. Valid choices are `NOTICE`, `INFO`, `DEBUG`, `WARNING`, `ERR`, `CRIT`, `ALERT`, and `EMERG`.

For example:

```
UNIFIED_AUDIT_SYSTEMLOG = 'LOCAL7.EMERG'
```

3. On UNIX platforms, to write unified audit records to `SYSLOG` set the `UNIFIED_AUDIT_COMMON_SYSTEMLOG` parameter to either `TRUE` or `FALSE` in the `init.ora` file in the root.

Setting `UNIFIED_AUDIT_COMMON_SYSTEMLOG` to `TRUE` writes predefined columns of unified audit records from common unified audit policies to `SYSLOG`. `FALSE` disables these columns from being written to `SYSLOG`.

You cannot set this parameter in a pluggable database (PDB). There is no Windows equivalent of the `UNIFIED_AUDIT_COMMON_SYSTEMLOG` parameter.

4. Add the audit file destination to the `SYSLOG` configuration file `/etc/syslog.conf`.

For example, assuming you had set the `UNIFIED_AUDIT_SYSTEMLOG` to `LOCAL7.EMERG`, enter the following:

```
local7.emerg /var/log/audit.log
```

This setting logs all emergency messages to the `/var/log/audit.log` file.

5. Restart the `SYSLOG` logger.

```
$/etc/rc.d/init.d/syslog restart
```

Now, all audit records will be captured in the file `/var/log/audit.log` through the `syslog` daemon.

6. Log back in to the database instance.
7. Restart the database.

For example:

```
SHUTDOWN IMMEDIATE
STARTUP
```

If you set `UNIFIED_AUDIT_SYSTEMLOG` in a PDB, then close and reopen the PDB:

```
ALTER PLUGGABLE DATABASE pdb_name CLOSE IMMEDIATE;
ALTER PLUGGABLE DATABASE pdb_name OPEN;
```

Related Topics

- [About Writing the Unified Audit Trail Records to SYSLOG or the Windows Event Viewer](#)
With this feature, you can copy some of the key unified audit fields to SYSLOG or the Windows Event Viewer.
- [Oracle Database Reference](#)

32.1.5 How Unified Audit Records are Written to the Operating System

When the database cannot write audit trail records in the database itself, Oracle Database writes these records to operating system spillover audit files (`.bin` format).

This can happen in situations such as the following:

- The audit tablespace is offline.
- The tablespace is read only.
- The tablespace is full.
- The database is read only.

The default locations for unified audit spillover `.bin` files are as follows:

- **For pluggable databases (PDBs):** `$ORACLE_BASE/audit/$ORACLE_SID/PDB_GUID`
- **For the CDB root:** `$ORACLE_BASE/audit/$ORACLE_SID/`

The unified audit records will continue to be written to OS spillover files until the OS disk space becomes full. At this point, when there is no room in the OS for the audit records, user auditable transactions will fail with `ORA-02002` error while writing to audit trail errors. To prevent this problem, Oracle recommends that you purge the audit trail on a regular basis.

Related Topics

- [Purging Audit Trail Records](#)
The `DBMS_AUDIT_MGMT` PL/SQL package can schedule automatic purge jobs, manually purge audit records, and perform other audit trail operations.

32.1.6 Moving Operating System Audit Records into the Unified Audit Trail

Audit records that have been written to the spillover audit files can be moved to the unified audit trail database table.

When the database is not writable (such as during database mounts), if the database is closed, or if it is read-only, then Oracle Database writes the audit records to these external files. The default location for these external files is the `$ORACLE_BASE/audit/$ORACLE_SID` directory.

You can load the files into the database by running the `DBMS_AUDIT_MGMT.LOAD_UNIFIED_AUDIT_FILES` procedure. If you are loading a large number of operating system audit records in the external files, then consider the impact on the performance.

Follow these steps to load the audit records from operating system files to the `AUDSYS` schema audit table when the database is writable:

1. Log into the database as a user who has been granted the `AUDIT_ADMIN` role.

Before you can upgrade to the current release or Oracle Database, you must run the `DBMS_AUDIT_MGMT.LOAD_UNIFIED_AUDIT_FILES` procedure from the CDB root to avoid losing operating system spillover files during the upgrade process.

2. Ensure that the database is open and writable.

To find if the database is open and writable, query the `V$DATABASE` view.

```
SELECT NAME, OPEN_MODE FROM V$DATABASE;
```

```
NAME                OPEN_MODE
-----
HRPDB                READ WRITE
```

You can run the `show pdbs` command to find information about PDBs associated with the current instance.

3. Run the `DBMS_AUDIT_MGMT.LOAD_UNIFIED_AUDIT_FILES` procedure.

For example:

```
EXEC DBMS_AUDIT_MGMT.LOAD_UNIFIED_AUDIT_FILES;
```

If you want to load a specific batch size of spillover operating system audit files, include the `load_batch_size` parameter. For example, to load 10 spillover files for the current container:

```
BEGIN
  DBMS_AUDIT_MGMT.LOAD_UNIFIED_AUDIT_FILES(
    container      => 1,
    load_batch_size => 10);
END;
/
```

If you omit the `load_batch_size` parameter, then the default value of `load_batch_size` is 3. In that case, `EXEC DBMS_AUDIT_MGMT.LOAD_UNIFIED_AUDIT_FILES;` only loads 3 files at a time.

4. If you want to load individual PDB audit records, then log in to each PDB and run the `DBMS_AUDIT_MGMT.LOAD_UNIFIED_AUDIT_FILES` procedure again.

The audit records are loaded into the `AUDSYS` schema audit table immediately, and then deleted from the `$ORACLE_BASE/audit/$ORACLE_SID` directory.

If the session ID linked to the spillover audit files is owned by the PMON process, then the files can't be loaded until the database is restarted.

32.1.7 Improving the Performance of Queries and Purge Operations

If the partition on which the `AUDSYS.AUD$UNIFIED` table is located is too large, then queries to and purges of the `UNIFIED_AUDIT_TRAIL` data dictionary view may take a long time to complete.

- To improve performance, break the partition into smaller portions by using the `ALTER TABLE SPLIT PARTITION` statement.

For example:

```
ALTER TABLE "AUDSYS"."AUD$UNIFIED" SPLIT PARTITION "SYS_P1602"
INTO
(PARTITION SYS_P1602_1 VALUES LESS THAN (DATE '2020-08-15'),
PARTITION SYS_P1602
);
```

Related Topics

- [Oracle Database VLDB and Partitioning Guide](#)

32.1.8 Using Oracle Data Pump to Export and Import Unified Audit Trail Records

You can include the unified audit trail in Oracle Database Pump export and import dump files.

The unified audit trail is automatically included in either full database or partial database export and import operations using Oracle Data Pump. As part of the schema level export or import operation, Oracle Database does not include the audit policy's metadata in the `SYS` schema during the export or import operation. Instead, use full export (`expdp`) or import (`impdp`) for the export and import of the metadata in unified audit policies.

For example, for a partial database export operation that does not use schema level export or import, if you wanted to export only the unified audit trail tables, then you could enter the following commands:

1. In SQL*Plus, move any operating system audit records that have been written to the spillover audit files to the unified audit trail table. Doing so ensures that all records will be exported.
2. From the operating system prompt, run the following command:

```
expdp system
full=y
directory=aud_dp_dir
logfile=audexp_log.log
dumpfile=audexp_dump.dmp
version=18.02.00.02.00
INCLUDE=AUDIT_TRAILS
```

Password: *password*

Next, you can import all the exported content by reading the export dump file. This operation imports only the unified audit trail tables.

```
impdp system
full=y
directory=aud_dp_dir
dumpfile=audexp_dump.dmp
logfile=audimp_log.log
```

Password: *password*

You do not need to perform any special configuration to achieve this operation. However, you must have the `EXP_FULL_DATABASE` role if you are performing the export operation and the `IMP_FULL_DATABASE` role if you are performing the import operation.

Related Topics

- [Moving Operating System Audit Records into the Unified Audit Trail](#)
Audit records that have been written to the spillover audit files can be moved to the unified audit trail database table.

32.1.9 How Do Cursors Affect Auditing?

For each execution of an auditable operation within a cursor, Oracle Database inserts one audit record into the audit trail.

Events that cause cursors to be reused include the following:

- An application, such as Oracle Forms, holding a cursor open for reuse
- Subsequent execution of a cursor using new bind variables
- Statements run within PL/SQL loops where the PL/SQL engine optimizes the statements to reuse a single cursor

Auditing is *not* affected by whether or not a cursor is shared. Each user creates their own audit trail records on first execution of the cursor.

32.2 Archiving the Audit Trail

To maintain the integrity and reliability of audit data, keep only minimal required audit data locally in the database.

Move audit data to a dedicated repository outside of the source database (such as Oracle Audit Vault and Database Firewall (AVDF) or Oracle Data Safe) for long-term audit data retention and detailed analysis.

- [Archiving the Traditional Operating System Audit Trail](#)
You can create an archive of the traditional operating system audit files after you have upgraded Oracle Database.
- [Archiving the Unified and Traditional Database Audit Trails](#)
You should periodically archive and then purge the audit trail to prevent it from growing too large.

32.2.1 Archiving the Traditional Operating System Audit Trail

You can create an archive of the traditional operating system audit files after you have upgraded Oracle Database.

To archive the traditional operating system audit trail from an upgraded database, use your platform-specific operating system tools to create an archive of the traditional operating system audit files.

 **Note:**

Traditional auditing is desupported in Oracle Database 23ai. Oracle recommends that you use unified auditing instead.

- Use the following methods to archive the traditional operating system audit files:

- **Use Oracle Audit Vault and Database Firewall.** You install Oracle Audit Vault and Database Firewall separately from Oracle Database.
- **Create tape or disk backups.** You can create a compressed file of the audit files, and then store it on tapes or disks. Consult your operating system documentation for more information.

Afterwards, you should purge (delete) the traditional operating system audit records to facilitate audit trail management.

Related Topics

- [Moving Operating System Audit Records into the Unified Audit Trail](#)
Audit records that have been written to the spillover audit files can be moved to the unified audit trail database table.
- [Purging Audit Trail Records](#)
The `DBMS_AUDIT_MGMT` PL/SQL package can schedule automatic purge jobs, manually purge audit records, and perform other audit trail operations.
- [Handling the Desupport of Traditional Auditing](#)
Traditional auditing is desupported, starting in Oracle Database 23ai. Oracle recommends that you use unified auditing instead.

32.2.2 Archiving the Unified and Traditional Database Audit Trails

You should periodically archive and then purge the audit trail to prevent it from growing too large.

Archiving and purging facilitate the purging of the database audit trail.

You can create an archive of the unified and traditional database audit trail by using Oracle Audit Vault and Database Firewall or Oracle Data Safe. You install both of these products separately from Oracle Database.

Note:

Traditional auditing is desupported in Oracle Database 23ai. Oracle recommends that you use unified auditing instead.

After you complete the archive, you can purge the database audit trail contents.

Related Topics

- [Purging Audit Trail Records](#)
The `DBMS_AUDIT_MGMT` PL/SQL package can schedule automatic purge jobs, manually purge audit records, and perform other audit trail operations.
- [Handling the Desupport of Traditional Auditing](#)
Traditional auditing is desupported, starting in Oracle Database 23ai. Oracle recommends that you use unified auditing instead.

32.3 Purging Audit Trail Records

The `DBMS_AUDIT_MGMT` PL/SQL package can schedule automatic purge jobs, manually purge audit records, and perform other audit trail operations.

- [About Purging Audit Trail Records](#)
You can use a variety of ways to purge audit trail records.
- [Selecting an Audit Trail Purge Method](#)
You can perform the purge on a regularly scheduled basis or at a specified times.
- [Scheduling an Automatic Purge Job for the Audit Trail](#)
Scheduling an automatic purge job requires planning beforehand, such as tuning the online and archive redo log sizes.
- [Manually Purging the Audit Trail](#)
You can use the `DBMS_AUDIT_MGMT.CLEAN_AUDIT_TRAIL` procedure to manually purge the audit trail.
- [Other Audit Trail Purge Operations](#)
Other kinds of audit trail purge include enabling or disabling the audit trail purge job or setting the default audit trail purge job interval.
- [Example: Directly Calling a Unified Audit Trail Purge Operation](#)
You can create a customized archive procedure to directly call a unified audit trail purge operation.

Related Topics

- [Managing the Unified Audit Trail](#)
Unified auditing is enabled by default, and audit trail management ensures audit configuration is efficient for your needs.

32.3.1 About Purging Audit Trail Records

You can use a variety of ways to purge audit trail records.

You should periodically archive and then delete (purge) audit trail records. You can purge a subset of audit trail records or create a purge job that performs at a specified time interval. Oracle Database either purges the audit trail records that were created before the archive timestamp, or it purges all audit trail records. You can purge audit trail records in both read-write and read-only databases.

The purge process takes into account not just the unified audit trail, but audit trails from earlier releases of Oracle Database. For example, if you have migrated an upgraded database that still has operating system or XML audit records, then you can use the procedures in this section to archive and purge them.

To perform the audit trail purge tasks, you use the `DBMS_AUDIT_MGMT` PL/SQL package. You must have the `AUDIT_ADMIN` role before you can use the `DBMS_AUDIT_MGMT` package. Oracle Database mandatorily audits all executions of the `DBMS_AUDIT_MGMT` PL/SQL package procedures.

If you have Oracle Database activity monitoring solutions such as Oracle Audit Vault and Database Firewall (AVDF) or Oracle Data Safe to collect audit data, refer to the documentation of these solutions to check the specific recommendations for purge process.



Note:

Oracle Database audits all deletions from the audit trail, without exception.

Related Topics

- [Oracle Database PL/SQL Packages and Types Reference](#)

32.3.2 Selecting an Audit Trail Purge Method

You can perform the purge on a regularly scheduled basis or at a specified times.

- [Purging the Audit Trail on a Regularly Scheduled Basis](#)
You can purge all audit records, or audit records that were created before a specified timestamp, on a regularly scheduled basis.
- [Purging the Audit Trail on Demand](#)
You can manually purge the audit records on demand rather than scheduling the purge.

32.3.2.1 Purging the Audit Trail on a Regularly Scheduled Basis

You can purge all audit records, or audit records that were created before a specified timestamp, on a regularly scheduled basis.

For example, you can schedule the purge for every Saturday at 2 a.m.

1. Ensure that online and archive redo log sizes are tuned to accommodate the additional records generated during the audit table purge process.
2. Plan a timestamp and archive strategy.
3. Optionally, set an archive timestamp for the audit records.
4. Create and schedule the purge job.

Related Topics

- [Scheduling an Automatic Purge Job for the Audit Trail](#)
Scheduling an automatic purge job requires planning beforehand, such as tuning the online and archive redo log sizes.

32.3.2.2 Purging the Audit Trail on Demand

You can manually purge the audit records on demand rather than scheduling the purge.

1. Ensure that online and archive redo log sizes are tuned to accommodate the additional records that were generated during the audit table purge process.
2. Plan a timestamp and archive strategy.
3. Optionally, set an archive timestamp for the audit records.
4. Run the purge operation.

Related Topics

- [Manually Purging the Audit Trail](#)
You can use the `DBMS_AUDIT_MGMT.CLEAN_AUDIT_TRAIL` procedure to manually purge the audit trail.

32.3.3 Scheduling an Automatic Purge Job for the Audit Trail

Scheduling an automatic purge job requires planning beforehand, such as tuning the online and archive redo log sizes.

- [About Scheduling an Automatic Purge Job](#)
You can purge the entire audit trail, or purge older audit records in an audit trail that was created before a specific time period.
- [Step 1: Ensure Online and Archive redo Log Sizes Are Tuned Appropriately](#)
The purge process may generate additional redo logs.
- [Step 2: Optionally, Set an Archive Timestamp for Audit Records](#)
If you want to delete all of the audit trail, then you can bypass this step.
- [Step 3: Create and Schedule the Purge Job](#)
You can use the `DBMS_AUDIT_MGMT` PL/SQL package to create and schedule the purge job.

32.3.3.1 About Scheduling an Automatic Purge Job

You can purge the entire audit trail, or purge older audit records in an audit trail that was created before a specific time period.

Be aware that purging the audit trail, particularly a large one, can take a while to complete. Oracle recommends that you schedule the purge job at a time when the database is not busy. If the audit trail is considerably large, then the purge process can take a while to complete.

You can create multiple purge jobs for different audit trail types, so long as they do not conflict. For example, you can create a purge job for the standard audit trail table and then the fine-grained audit trail table. However, you cannot then create a purge job for both or all types, that is, by using the `DBMS_AUDIT_MGMT.AUDIT_TRAIL_DB_STD` or `DBMS_AUDIT_MGMT.AUDIT_TRAIL_ALL` property.

Note:

In addition, be aware that the jobs created by the `DBMS_SCHEDULER` PL/SQL package do not run on a read-only database. An automatic purge job created with `DBMS_AUDIT_MGMT` uses the `DBMS_SCHEDULER` package to schedule the tasks. Therefore, these jobs cannot run on a database or PDB that is open in read-only mode.

32.3.3.2 Step 1: Ensure Online and Archive redo Log Sizes Are Tuned Appropriately

The purge process may generate additional redo logs.

You may consider skipping the step if you have turned **off** traditional auditing in the upgraded instance.

- Ensure that the online and archive redo log sizes accommodate the additional records generated during the audit table purge process.

In a unified auditing environment, the purge process does not generate as many redo logs as in a mixed mode auditing environment, so if you have migrated to unified auditing, then you may want to bypass this step.

Related Topics

- *Oracle Database Administrator's Guide*

32.3.3.3 Step 2: Optionally, Set an Archive Timestamp for Audit Records

If you want to delete all of the audit trail, then you can bypass this step.

You must record the timestamp of the audit records before you can archive them. You can set a timestamp for when the last audit record was archived. Setting an archive timestamp provides the point of cleanup to the purge infrastructure. If you are setting a timestamp for a read-only database, then you can use the `DBMS_AUDIT.MGMT.GET_LAST_ARCHIVE_TIMESTAMP` function to find the last archive timestamp that was configured for the instance on which it was run. For a read-write database, you can query the `DBA_AUDIT_MGMT_LAST_ARCH_TS` data dictionary view.

To find the last archive timestamps for the unified audit trail, you can query the `DBA_AUDIT_MGMT_LAST_ARCH_TS` data dictionary view. After you set the timestamp, all audit records in the audit trail that indicate a time earlier than that timestamp are purged when you run the `DBMS_AUDIT_MGMT.CLEAN_AUDIT_TRAIL` PL/SQL procedure. Optionally, you can clear the archive timestamp setting.

If you are using Oracle Database Real Application Clusters, then use Network Time Protocol (NTP) to synchronize the time on each computer where you have installed an Oracle Database instance. For example, suppose you set the time for one Oracle RAC instance node at 11:00:00 a.m. and then set the next Oracle RAC instance node at 11:00:05. As a result, the two nodes have inconsistent times. You can use Network Time Protocol (NTP) to synchronize the times for these Oracle RAC instance nodes.

1. As a user who has been granted the `AUDIT_ADMIN` role, log into the either the root or the PDB in which you want to schedule the purge job.

In most cases, you may want to schedule the purge job on individual PDBs. For example, to log into a PDB called `hrpdb`:

```
CONNECT aud_admin@hrpdb
Enter password: password
Connected.
```

2. Find the timestamp date, by querying the `DBA_AUDIT_MGMT_LAST_ARCH_TS` data dictionary view.

The last archived timestamp is set automatically if you are using Oracle Audit Vault and Database Firewall or Oracle Data Safe after the audit record is collected. Later on, when the purge takes place, Oracle Database purges only the audit trail records that were created before the date of this archive timestamp. After you have timestamped the records, you are ready to archive them.

3. Run the `DBMS_AUDIT_MGMT.SET_LAST_ARCHIVE_TIMESTAMP` PL/SQL procedure to set the timestamp.

For example:

```
BEGIN
  DBMS_AUDIT_MGMT.SET_LAST_ARCHIVE_TIMESTAMP (
    AUDIT_TRAIL_TYPE      => DBMS_AUDIT_MGMT.AUDIT_TRAIL_UNIFIED,
    LAST_ARCHIVE_TIME     => '12-OCT-2013 06:30:00.00',
    RAC_INSTANCE_NUMBER  => 1,
    CONTAINER             => DBMS_AUDIT_MGMT.CONTAINER_CURRENT);
END;
/
```

In this example:

- `AUDIT_TRAIL_TYPE` specifies the audit trail type.
`DBMS_AUDIT_MGMT.AUDIT_TRAIL_UNIFIED` sets it for the unified audit trail.

For upgraded databases that still have audit data from previous releases, use the following settings. Note that traditional auditing is desupported in Oracle Database 23ai. Oracle recommends that you use unified auditing instead.

- `DBMS_AUDIT_MGMT.AUDIT_TRAIL_AUD_STD` is used for the traditional standard audit trail table, `AUD$`. (This setting does not apply to read-only databases.)
- `DBMS_AUDIT_MGMT.AUDIT_TRAIL_FGA_STD` is used for the traditional fine-grained audit trail table, `FGA_LOG$`. (This setting does not apply to read-only databases.)
- `DBMS_AUDIT_MGMT.AUDIT_TRAIL_OS` is used for the traditional operating system audit trail files with the `.aud` extension. (This setting does not apply to Windows Event Log entries.)
- `DBMS_AUDIT_MGMT.AUDIT_TRAIL_XML` is used for the XML traditional operating system audit trail files.

To archive records from the `AUDSYS.AUD$UNIFIED` table or from the operating system spillover files:

- `DBMS_AUDIT_MGMT.AUDIT_TRAIL_UNIFIED_TABLE` archives records from the `AUDSYS.AUD$UNIFIED` table.
- `DBMS_AUDIT_MGMT.AUDIT_TRAIL_UNIFIED_FILES` archives records from the operating system spillover files in each database (primary or standby).
- `LAST_ARCHIVE_TIME` specifies the timestamp in `YYYY-MM-DD HH:MI:SS.FF UTC` (Coordinated Universal Time) format for `AUDIT_TRAIL_UNIFIED`, `AUDIT_TRAIL_AUD_STD`, and `AUDIT_TRAIL_FGA_STD`, and in the Local Time Zone for `AUDIT_TRAIL_OS` and `AUDIT_TRAIL_XML`. Do not enter a future system date or timestamp (for example, `SYSDATE + 1`, or a date in the future) for this value.
- `RAC_INSTANCE_NUMBER` specifies the instance number for an Oracle RAC installation. This setting is not relevant for single instance databases. If you specified the `DBMS_AUDIT_MGMT.AUDIT_TRAIL_AUD_STD` or `DBMS_AUDIT_MGMT.AUDIT_TRAIL_FGA_STD` audit trail types, then you can omit the `RAC_INSTANCE_NUMBER` argument. This is because there is only one `AUD$` or `FGA_LOG$` table, even for an Oracle RAC installation. The default is `NULL`. You can find the instance number for the current instance by issuing the `SHOW PARAMETER INSTANCE_NUMBER` command in `SQL*Plus`.
- `CONTAINER` applies the timestamp to either the current PDB or to all PDBs.
`DBMS_AUDIT_MGMT.CONTAINER_CURRENT` specifies the current PDB;
`DBMS_AUDIT_MGMT.CONTAINER_ALL` applies to all PDBs in the multitenant environment.

Note that you can set `CONTAINER` to `DBMS_MGMT.CONTAINER_ALL` only from the root.

Typically, after you set the timestamp, you can use the `DBMS_AUDIT_MGMT.CLEAN_AUDIT_TRAIL` PL/SQL procedure to remove the audit records that were created before the timestamp date.

Related Topics

- [Clearing the Archive Timestamp Setting](#)
The `DBMS_AUDIT_MGMT.CLEAR_LAST_ARCHIVE_TIMESTAMP` procedure can clear the archive timestamp setting.

32.3.3.4 Step 3: Create and Schedule the Purge Job

You can use the `DBMS_AUDIT_MGMT` PL/SQL package to create and schedule the purge job.

- Create and schedule the purge job by running the `DBMS_AUDIT_MGMT.CREATE_PURGE_JOB` PL/SQL procedure.

For example:

```
CONNECT aud_admin@hrpdb
Enter password: password
Connected.

BEGIN
  DBMS_AUDIT_MGMT.CREATE_PURGE_JOB (
    AUDIT_TRAIL_TYPE           => DBMS_AUDIT_MGMT.AUDIT_TRAIL_UNIFIED,
    AUDIT_TRAIL_PURGE_INTERVAL => 12,
    AUDIT_TRAIL_PURGE_NAME     => 'Audit_Trail_PJ',
    USE_LAST_ARCH_TIMESTAMP    => TRUE,
    CONTAINER                  => DBMS_AUDIT_MGMT.CONTAINER_CURRENT);
END;
/
```

In this example:

- `AUDIT_TRAIL_TYPE`: Specifies the audit trail type.
`DBMS_AUDIT_MGMT.AUDIT_TRAIL_UNIFIED` sets it for the unified audit trail.

For upgraded databases that still have audit data from previous releases, use the following settings. Note that traditional auditing is desupported in Oracle Database 23ai. Oracle recommends that you use unified auditing instead.

- * `DBMS_AUDIT_MGMT.AUDIT_TRAIL_AUD_STD` is used for the standard audit trail table, `AUD$`. (This setting does not apply to read-only databases.)
- * `DBMS_AUDIT_MGMT.AUDIT_TRAIL_FGA_STD` is used for the fine-grained audit trail table, `FGA_LOG$`. (This setting does not apply to read-only databases.)
- * `DBMS_AUDIT_MGMT.AUDIT_TRAIL_DB_STD` is used for both standard and fine-grained audit trail tables. (This setting does not apply to read-only databases.)
- * `DBMS_AUDIT_MGMT.AUDIT_TRAIL_OS` is used for the operating system audit trail files with the `.aud` extension. (This setting does not apply to Windows Event Log entries.)
- * `DBMS_AUDIT_MGMT.AUDIT_TRAIL_XML` is used for the XML operating system audit trail files.
- * `DBMS_AUDIT_MGMT.AUDIT_TRAIL_FILES` is used for both operating system and XML audit trail files.
- * `DBMS_AUDIT_MGMT.AUDIT_TRAIL_ALL` is used for all traditional audit trail records, that is, both database audit trail and operating system audit trail types. (This setting does not apply to read-only databases.)

To purge records from the `AUDSYS.AUD$UNIFIED` table or from the operating system spillover files:

- * `DBMS_AUDIT_MGMT.AUDIT_TRAIL_UNIFIED_TABLE` purges records from the `AUDSYS.AUD$UNIFIED` table.

- * `DBMS_AUDIT_MGMT.AUDIT_TRAIL_UNIFIED_FILES` purges records from the operating system spillover files in each database (primary or standby).
- `AUDIT_TRAIL_PURGE_INTERVAL` specifies the hourly interval for this purge job to run. The timing begins when you run the `DBMS_AUDIT_MGMT.CREATE_PURGE_JOB` procedure, in this case, 12 hours after you run this procedure. Later on, if you want to update this value, run the `DBMS_AUDIT_MGMT.SET_PURGE_JOB_INTERVAL` procedure.
- `USE_LAST_ARCH_TIMESTAMP` accepts either of the following settings:
 - * `TRUE` deletes audit records created before the last archive timestamp. To check the last recorded timestamp, query the `LAST_ARCHIVE_TS` column of the `DBA_AUDIT_MGMT_LAST_ARCH_TS` data dictionary view for read-write databases and the `DBMS_AUDIT_MGMT.GET_LAST_ARCHIVE_TIMESTAMP` function for read-only databases. The default value is `TRUE`. Oracle recommends that you set `USE_LAST_ARCH_TIMESTAMP` to `TRUE`.
 - * `FALSE` deletes all audit records without considering last archive timestamp. Be careful about using this setting, in case you inadvertently delete audit records that should not have been deleted.

To purge records from the `AUDSYS.AUD$UNIFIED` table or from the operating system spillover files:

- * `DBMS_AUDIT_MGMT.AUDIT_TRAIL_UNIFIED_TABLE` purges records from the `AUDSYS.AUD$UNIFIED` table.
- * `DBMS_AUDIT_MGMT.AUDIT_TRAIL_UNIFIED_FILES` purges records from the operating system spillover files in each database (primary or standby).
- `CONTAINER` defines where to create the purge job in the multitenant environment. You can set it as follows:
 - * `DBMS_AUDIT_MGMT.CONTAINER_CURRENT` can be set in either the CDB root or the current PDB, enabling the purge job to be available, visible, and managed from these locations. If set in the CDB root, then the purge job applies only to the CDB root; if set in the current PDB, then it applies only to that PDB.
 - * `DBMS_AUDIT_MGMT.CONTAINER_ALL` is set in the CDB root, enabling the purge job to be a global job, which runs according to the defined job schedule. When the job is invoked, it cleans up audit trails in all the PDBs in the multitenant environment. If you create the job in the CDB root, then it is visible only in the CDB root. Hence, you can enable, disable, and drop it from the CDB root only.

32.3.4 Manually Purging the Audit Trail

You can use the `DBMS_AUDIT_MGMT.CLEAN_AUDIT_TRAIL` procedure to manually purge the audit trail.

- [About Manually Purging the Audit Trail](#)
You can manually purge the audit trail right away, without scheduling a purge job.
- [Using DBMS_AUDIT_MGMT.CLEAN_AUDIT_TRAIL to Manually Purge the Audit Trail](#)
After you complete preparatory steps, you can use the `DBMS_AUDIT_MGMT.CLEAN_AUDIT_TRAIL` procedure to manually purge the audit trail.

32.3.4.1 About Manually Purging the Audit Trail

You can manually purge the audit trail right away, without scheduling a purge job.

Similar to a purge job, you can purge audit trail records that were created before an archive timestamp date or all the records in the audit trail. Only the current audit directory is cleaned up when you run this procedure.

For upgraded databases that may still have audit trails from earlier releases, note the following about the `DBMS_AUDIT_MGMT.CLEAN_AUDIT_TRAIL` PL/SQL procedure:

- On Microsoft Windows, because the `DBMS_AUDIT_MGMT` package does not support cleanup of Windows Event Viewer, setting the `AUDIT_TRAIL_TYPE` property to `DBMS_AUDIT_MGMT.AUDIT_TRAIL_OS` has no effect. This is because operating system audit records on Windows are written to Windows Event Viewer. The `DBMS_AUDIT_MGMT` package does not support this type of cleanup operation.
- On UNIX platforms, if you had set the `AUDIT_SYSLOG_LEVEL` (deprecated) initialization parameter, then Oracle Database writes the operating system log files to syslog files. (Be aware that when you configure the use of syslog files, the messages are sent to the syslog daemon process. The syslog daemon process does not return an acknowledgment to Oracle Database indicating a committed write to the syslog files.) If you set the `AUDIT_TRAIL_TYPE` property to `DBMS_AUDIT_MGMT.AUDIT_TRAIL_OS`, then the procedure only removes `.aud` files under audit directory (This directory is specified by the `AUDIT_FILE_DEST` (deprecated) initialization parameter).

32.3.4.2 Using `DBMS_AUDIT_MGMT.CLEAN_AUDIT_TRAIL` to Manually Purge the Audit Trail

After you complete preparatory steps, you can use the `DBMS_AUDIT_MGMT.CLEAN_AUDIT_TRAIL` procedure to manually purge the audit trail.

1. If you have set the `AUDIT_SYSLOG_LEVEL` (deprecated) initialization parameter so that the audit trail will be written to operating system log files (`syslog`), then check for the following:
 - Ensure that no one is currently writing to the audit trail files.
 - Ensure that the session ID that is associated with the audit trail files is not owned by the PMON process.

If either of these conditions is true, then the audit trail cannot be purged.

2. Perform the following scheduling tasks:
 - If necessary, tune the online and archive redo log sizes.
 - Plan a timestamp and archive strategy.
 - Optionally, set an archive timestamp for the audit records.
3. Connect to the root or to the PDB in which you created the purge job.

If you created the purge job in the root, then you must log into the root. If you created the purge job in a specific PDB, then log into that PDB.

4. Purge the audit trail records by running the `DBMS_AUDIT_MGMT.CLEAN_AUDIT_TRAIL` PL/SQL procedure.

For example:

```
BEGIN
  DBMS_AUDIT_MGMT.CLEAN_AUDIT_TRAIL(
    AUDIT_TRAIL_TYPE      => DBMS_AUDIT_MGMT.AUDIT_TRAIL_UNIFIED,
    USE_LAST_ARCH_TIMESTAMP => TRUE,
    CONTAINER              => DBMS_AUDIT_MGMT.CONTAINER_CURRENT );
```

```
END;  
/
```

In this example:

- **AUDIT_TRAIL_TYPE:** Specifies the audit trail type.
`DBMS_AUDIT_MGMT.AUDIT_TRAIL_UNIFIED` sets it for the unified audit trail.

For upgraded databases that still have audit data from previous releases, use the following settings. Note that traditional auditing is desupported in Oracle Database 23ai. Oracle recommends that you use unified auditing instead.

- `DBMS_AUDIT_MGMT.AUDIT_TRAIL_AUD_STD`: Standard audit trail table, `AUD$`. (This setting does not apply to read-only databases.)
- `DBMS_AUDIT_MGMT.AUDIT_TRAIL_FGA_STD`: Fine-grained audit trail table, `FGA_LOG$`. (This setting does not apply to read-only databases.)
- `DBMS_AUDIT_MGMT.AUDIT_TRAIL_DB_STD`: Both standard and fine-grained audit trail tables. (This setting does not apply to read-only databases)
- `DBMS_AUDIT_MGMT.AUDIT_TRAIL_OS`: Operating system audit trail files with the `.aud` extension. (This setting does not apply to Windows Event Log entries.)
- `DBMS_AUDIT_MGMT.AUDIT_TRAIL_XML`: XML Operating system audit trail files.
- `DBMS_AUDIT_MGMT.AUDIT_TRAIL_FILES`: Both operating system and XML audit trail files.
- `DBMS_AUDIT_MGMT.AUDIT_TRAIL_ALL`: All audit trail records, that is, both database audit trail and operating system audit trail types. (This setting does not apply to read-only databases.)

To purge records from the `AUDSYS.AUD$UNIFIED` table or from the operating system spillover files:

- `DBMS_AUDIT_MGMT.AUDIT_TRAIL_UNIFIED_TABLE` purges records from the `AUDSYS.AUD$UNIFIED` table.
- `DBMS_AUDIT_MGMT.AUDIT_TRAIL_UNIFIED_FILES` purges records from the operating system spillover files in each database (primary or standby).
- **USE_LAST_ARCH_TIMESTAMP:** Enter either of the following settings:
 - **TRUE:** Deletes audit records created before the last archive timestamp. The default (and recommended) value is `TRUE`. Oracle recommends that you set `USE_LAST_ARCH_TIMESTAMP` to `TRUE`.
 - **FALSE:** Deletes all audit records without considering last archive timestamp. Be careful about using this setting, in case you inadvertently delete audit records that should not have been deleted.
- **CONTAINER:** Applies the cleansing to either the current PDB or to all PDBs.
`DBMS_AUDIT_MGMT.CONTAINER_CURRENT` specifies the current PDB;
`DBMS_AUDIT_MGMT.CONTAINER_ALL` applies to all PDBs.

Related Topics

- [Step 1: Ensure Online and Archive redo Log Sizes Are Tuned Appropriately](#)
The purge process may generate additional redo logs.
- [Step 2: Optionally, Set an Archive Timestamp for Audit Records](#)
If you want to delete all of the audit trail, then you can bypass this step.

32.3.5 Other Audit Trail Purge Operations

Other kinds of audit trail purge include enabling or disabling the audit trail purge job or setting the default audit trail purge job interval.

- [Enabling or Disabling an Audit Trail Purge Job](#)
The `DBMS_AUDIT_MGMT.SET_PURGE_JOB_STATUS` procedure enables or disables an audit trail purge job.
- [Setting the Default Audit Trail Purge Job Interval for a Specified Purge Job](#)
You can set a default purge operation interval, in hours, that must pass before the next purge job operation takes place.
- [Deleting an Audit Trail Purge Job](#)
You can delete existing audit trail purge jobs.
- [Clearing the Archive Timestamp Setting](#)
The `DBMS_AUDIT_MGMT.CLEAR_LAST_ARCHIVE_TIMESTAMP` procedure can clear the archive timestamp setting.

32.3.5.1 Enabling or Disabling an Audit Trail Purge Job

The `DBMS_AUDIT_MGMT.SET_PURGE_JOB_STATUS` procedure enables or disables an audit trail purge job.

Where you run the `DBMS_AUDIT_MGMT.SET_PURGE_JOB_STATUS` procedure in the multitenant environment depends on the location of the purge job, which is determined by the `CONTAINER` parameter of the `DBMS_MGMT.CREATE_PURGE_JOB` procedure. If you had set `CONTAINER` to `CONTAINER_ALL` (to create the purge job in the root), then you must run the `DBMS_AUDIT_MGMT.SET_PURGE_JOB_STATUS` procedure from the root. If you had set `CONTAINER` to `CONTAINER_CURRENT`, then you must run the `DBMS_AUDIT_MGMT.SET_PURGE_JOB_STATUS` procedure from the PDB in which it was created.

- To enable or disable an audit trail purge job, use the `DBMS_AUDIT_MGMT.SET_PURGE_JOB_STATUS` PL/SQL procedure.

For example, assuming that you had created the purge job in a the `hrpdb` PDB:

```
CONNECT aud_admin@hrpdb
Enter password: password
Connected.

BEGIN
  DBMS_AUDIT_MGMT.SET_PURGE_JOB_STATUS (
    AUDIT_TRAIL_PURGE_NAME      => 'Audit_Trail_PJ',
    AUDIT_TRAIL_STATUS_VALUE    => DBMS_AUDIT_MGMT.PURGE_JOB_ENABLE);
END;
/
```

In this example:

- `AUDIT_TRAIL_PURGE_NAME` specifies a purge job called `Audit_Trail_PJ`. To find existing purge jobs, query the `JOB_NAME` and `JOB_STATUS` columns of the `DBA_AUDIT_MGMT_CLEANUP_JOBS` data dictionary view.
- `AUDIT_TRAIL_STATUS_VALUE` accepts either of the following properties:
 - * `DBMS_AUDIT_MGMT.PURGE_JOB_ENABLE` enables the specified purge job.
 - * `DBMS_AUDIT_MGMT.PURGE_JOB_DISABLE` disables the specified purge job.

32.3.5.2 Setting the Default Audit Trail Purge Job Interval for a Specified Purge Job

You can set a default purge operation interval, in hours, that must pass before the next purge job operation takes place.

The interval setting that is used in the `DBMS_AUDIT_MGMT.CREATE_PURGE_JOB` procedure takes precedence over this setting.

- To set the default audit trail purge job interval for a specific purge job, run the `DBMS_AUDIT_MGMT.SET_PURGE_JOB_INTERVAL` procedure.

For example, assuming that you had created the purge job in the `hrpdb` PDB:

```
CONNECT aud_admin@hrpdb
Enter password: password
Connected.

BEGIN
  DBMS_AUDIT_MGMT.SET_PURGE_JOB_INTERVAL(
    AUDIT_TRAIL_PURGE_NAME      => 'Audit_Trail_PJ',
    AUDIT_TRAIL_INTERVAL_VALUE => 24);
END;
/
```

In this example:

- `AUDIT_TRAIL_PURGE_NAME` specifies the name of the audit trail purge job. To find a list of existing purge jobs, query the `JOB_NAME` and `JOB_STATUS` columns of the `DBA_AUDIT_MGMT_CLEANUP_JOBS` data dictionary view.
- `AUDIT_TRAIL_INTERVAL_VALUE` updates the default hourly interval set by the `DBMS_AUDIT_MGMT.CREATE_PURGE_JOB` procedure. Enter a value between 1 and 999. The timing begins when you run the purge job.

Where you run the `DBMS_AUDIT_MGMT.SET_PURGE_JOB_INTERVAL` procedure depends on the location of the purge job, which is determined by the `CONTAINER` parameter of the `DBMS_AUDIT_MGMT.CREATE_PURGE_JOB` procedure. If you had set `CONTAINER` to `CONTAINER_ALL`, then the purge job exists in the root, so you must run the `DBMS_AUDIT_MGMT.SET_PURGE_JOB_STATUS` procedure from the root. If you had set `CONTAINER` to `CONTAINER_CURRENT`, then you must run the `DBMS_AUDIT_MGMT.SET_PURGE_JOB_INTERVAL` procedure from the PDB in which it was created.

32.3.5.3 Deleting an Audit Trail Purge Job

You can delete existing audit trail purge jobs.

To find existing purge jobs, query the `JOB_NAME` and `JOB_STATUS` columns of the `DBA_AUDIT_MGMT_CLEANUP_JOBS` data dictionary view.

- To delete an audit trail purge job, use the `DBMS_AUDIT_MGMT.DROP_PURGE_JOB` PL/SQL procedure.

For example, assuming that you had created the purge job in the `hrpdb` PDB:

```
CONNECT aud_admin@hrpdb
Enter password: password
Connected.

BEGIN
```

```

DBMS_AUDIT_MGMT.DROP_PURGE_JOB(
  AUDIT_TRAIL_PURGE_NAME => 'Audit_Trail_PJ');
END;
/

```

Where you run the `DBMS_AUDIT_MGMT.DROP_PURGE_JOB` procedure in the multitenant environment depends on the location of the purge job, which is determined by the `CONTAINER` parameter of the `DBMS_MGMT.CREATE_PURGE_JOB` procedure. If you had set `CONTAINER` to `CONTAINER_ALL`, then the purge job exists in the root, so you must run the `DBMS_AUDIT_MGMT.SET_PURGE_JOB_STATUS` procedure from the root. If you had set `CONTAINER` to `CONTAINER_CURRENT`, then you must run the `DBMS_AUDIT_MGMT.DROP_PURGE_JOB_INTERVAL` procedure from the PDB in which it was created.

32.3.5.4 Clearing the Archive Timestamp Setting

The `DBMS_AUDIT_MGMT.CLEAR_LAST_ARCHIVE_TIMESTAMP` procedure can clear the archive timestamp setting.

To find a history of audit trail log cleanup, you can query the `UNIFIED_AUDIT_TRAIL` data dictionary view, using the following criteria: `OBJECT_NAME` is `DBMS_AUDIT_MGMT`, `OBJECT_SCHEMA` is `SYS`, and `SQL_TEXT` is set to `LIKE %DBMS_AUDIT_MGMT.CLEAN_AUDIT_TRAIL%`.

- To clear the archive timestamp setting, use the `DBMS_AUDIT_MGMT.CLEAR_LAST_ARCHIVE_TIMESTAMP` PL/SQL procedure to specify the audit trail type.

For example, assuming that you had created the purge job in the `hrpdb` PDB:

```

CONNECT aud_admin@hrpdb
Enter password: password
Connected.

BEGIN
  DBMS_AUDIT_MGMT.CLEAR_LAST_ARCHIVE_TIMESTAMP (
    AUDIT_TRAIL_TYPE      => DBMS_AUDIT_MGMT.AUDIT_TRAIL_UNIFIED,
    CONTAINER             => DBMS_AUDIT_MGMT.CONTAINER_CURRENT);
END;
/

```

In this example:

- `AUDIT_TRAIL_TYPE` is set for the unified audit trail. If the `AUDIT_TRAIL_TYPE` property is set to `DBMS_AUDIT_MGMT.AUDIT_TRAIL_OS` or `DBMS_AUDIT_MGMT.AUDIT_TRAIL_XML`, then you cannot set `RAC_INSTANCE_NUMBER` to 0. You can omit the `RAC_INSTANCE_NUMBER` setting if you set `AUDIT_TRAIL_TYPE` to `DBMS_AUDIT_MGMT.AUDIT_TRAIL_UNIFIED`.

You can clear the archive timestamps from the `AUDSYS.AUD$UNIFIED` table by setting `DBMS_AUDIT_MGMT.AUDIT_TRAIL_UNIFIED_TABLE`. To clear the archive timestamps from the operating system spillover files in each database (primary or standby), set `DBMS_AUDIT_MGMT.AUDIT_TRAIL_UNIFIED_FILES`.

- `CONTAINER` specifies where to perform the purge. `DBMS_AUDIT_MGMT.CONTAINER_CURRENT` specifies the local PDB; `DBMS_AUDIT_MGMT.CONTAINER_ALL` applies to all containers in the CDB environment.

32.3.6 Example: Directly Calling a Unified Audit Trail Purge Operation

You can create a customized archive procedure to directly call a unified audit trail purge operation.

The pseudo code in [Example 32-2](#) creates a database audit trail purge operation that the user calls by invoking the `DBMS_AUDIT.CLEAN_AUDIT_TRAIL` procedure for the unified audit trail.

The purge operation deletes records that were created before the last archived timestamp by using a loop. The loop archives the audit records, calculates which audit records were archived and uses the `SetCleanUpAuditTrail` call to set the last archive timestamp, and then calls the `CLEAN_AUDIT_TRAIL` procedure. In this example, major steps are in **bold typeface**.

Example 32-2 Directly Calling a Database Audit Trail Purge Operation

```
-- 1. Set the last archive timestamp:
PROCEDURE SetCleanUpAuditTrail()
BEGIN
  CALL FindLastArchivedTimestamp(AUD$);
  DBMS_AUDIT_MGMT.SET_LAST_ARCHIVE_TIMESTAMP(
    AUDIT_TRAIL_TYPE      => DBMS_AUDIT_MGMT.AUDIT_TRAIL_UNIFIED,
    LAST_ARCHIVE_TIME     => '23-AUG-2013 12:00:00',
    CONTAINER             => DBMS_AUDIT_MGMT.CONTAINER_CURRENT);
END;
/

-- 2. Run a customized archive procedure to purge the audit trail records:
BEGIN
  CALL MakeAuditSettings();
  LOOP (/* How long to loop*/)
    -- Invoke function for audit record archival
    CALL DoUnifiedAuditRecordArchival();

    CALL SetCleanUpAuditTrail();
    IF (/* Clean up is needed immediately */)
      DBMS_AUDIT_MGMT.CLEAN_AUDIT_TRAIL(
        AUDIT_TRAIL_TYPE      => DBMS_AUDIT_MGMT.AUDIT_TRAIL_UNIFIED,
        USE_LAST_ARCH_TIMESTAMP => TRUE,
        CONTAINER             => DBMS_AUDIT_MGMT.CONTAINER_CURRENT );
    END IF
  END LOOP /*LOOP*/
END; /* PROCEDURE */
/
```

32.4 Audit Trail Management Data Dictionary Views

Oracle Database provides data dictionary views that list information about audit trail management settings.

[Table 32-2](#) lists these views.

Table 32-2 Views That Display Information about Audit Trail Management Settings

View	Description
DBA_AUDIT_MGMT_CLEAN_EVENTS	<p>Displays the history of purge events of the traditional (that is, non-unified) audit trails. Periodically, as a user who has been granted the <code>AUDIT_ADMIN</code> role, you should delete the contents of this view so that it does not grow too large. For example:</p> <pre>DELETE FROM DBA_AUDIT_MGMT_CLEAN_EVENTS;</pre> <p>This view applies to read-write databases only. For read-only databases, a history of purge events is in the alert log.</p> <p>For unified auditing, you can find a history of purged events by querying the <code>UNIFIED_AUDIT_TRAIL</code> data dictionary view, using the following criteria: <code>OBJECT_NAME</code> is <code>DBMS_AUDIT_MGMT</code>, <code>OBJECT_SCHEMA</code> is <code>SYS</code>, and <code>SQL_TEXT</code> is set to <code>LIKE %DBMS_AUDIT_MGMT.CLEAN_AUDIT_TRAIL%</code>.</p>
DBA_AUDIT_MGMT_CLEANUP_JOBS	Displays the currently configured audit trail purge jobs
DBA_AUDIT_MGMT_CONFIG_PARAMS	Displays the currently configured audit trail properties that are used by the <code>DBMS_AUDIT_MGMT</code> PL/SQL package
DBA_AUDIT_MGMT_LAST_ARCH_TS	Displays the last archive timestamps that have set for audit trail purges

Related Topics

- [Oracle Database Reference](#)

Part VII

Appendixes

Part VII contains a set of reference appendixes.

- [Keeping Your Oracle Database Secure](#)
Oracle provides guidelines for keeping your database secure, such as advice on securing user accounts, privileges, roles, passwords, and data.
- [Managing Oracle Database Wallets and Certificates](#)
You can use the `orapki` command line utility and `sqlnet.ora` parameters to manage public key infrastructure (PKI) elements.
- [Oracle Database FIPS 140-2 Settings](#)
Oracle supports the Federal Information Processing Standard (FIPS) standard for 140-2.
- [Considerations for Transitioning from Traditional to Unified Auditing](#)
If you want to transition to unified auditing after you have upgraded to Oracle Database 23ai, note that most of the traditional auditing features will continue to exist in Oracle Database 23ai to help you transition smoothly.

A

Keeping Your Oracle Database Secure

Oracle provides guidelines for keeping your database secure, such as advice on securing user accounts, privileges, roles, passwords, and data.

- [About the Oracle Database Security Guidelines](#)
Information security, and privacy and protection of corporate assets and data are critical in any business.
- [Downloading Security Patches and Contacting Oracle Regarding Vulnerabilities](#)
You should always apply security patches as soon as they are available. If problems arise, then you should contact Oracle regarding vulnerabilities.
- [Guidelines for Securing User Accounts and Privileges](#)
Oracle provides guidelines to secure user accounts and privileges.
- [Guidelines for Securing Passwords](#)
Oracle provides guidelines for securing passwords in a variety of situations.
- [Securing Authentication for Oracle Database Microsoft Windows Installations](#)
By default, the `SQLNET.NO_NTLM` parameter setting in the `sqlnet.ora` file on Microsoft Windows installations with `AUTHENTICATION_SERVICES=NTS` is `TRUE`.
- [Guidelines for Securing Roles](#)
Oracle provides guidelines for role management.
- [Guidelines for Securing Data](#)
Oracle provides guidelines for securing data on your system.
- [Guidelines for Securing the ORACLE_LOADER Access Driver](#)
Oracle provides guidelines to secure the `ORACLE_LOADER` access driver.
- [Guidelines for Securing a Database Installation and Configuration](#)
Oracle provides guidelines to secure the database installation and configuration.
- [Guideline for Securing Multitenant PDBs from the Root in a Linux Environment](#)
In Linux, you can securely compartmentalize PDBs to manage their resources in containers called nests.
- [Guidelines for Securing the Network](#)
Security for network communications is improved by using client, listener, and network guidelines to ensure thorough protection.
- [Guideline for Securing External Procedures](#)
The `ENFORCE_CREDENTIAL` environment variable controls how an `extproc` process authenticates user credentials and callout functions.
- [Guidelines for Auditing](#)
Oracle provides guidelines for auditing.
- [Addressing the CONNECT Role Change](#)
The `CONNECT` role, introduced with Oracle Database version 7, added new and robust support for database roles.

A.1 About the Oracle Database Security Guidelines

Information security, and privacy and protection of corporate assets and data are critical in any business.

Oracle Database comprehensively addresses the need for information security by providing cutting-edge security features such as deep data protection, auditing, scalable security, secure hosting, and data exchange.

Oracle Database leads the industry in security. To maximize the security features offered by Oracle Database in any business environment, it is imperative that the database itself be well protected.

Security guidelines provide advice about how to configure Oracle Database to be secure by adhering to and recommending industry-standard and advisable security practices for operational database deployments. Many of the guidelines described in this section address common regulatory requirements such as those described in the Sarbanes-Oxley Act. For more information about how Oracle Database addresses regulatory compliance, protection of personally identifiable information, and internal threats, visit:

<http://www.oracle.com/technetwork/topics/security/whatsnew/index.html>

A.2 Downloading Security Patches and Contacting Oracle Regarding Vulnerabilities

You should always apply security patches as soon as they are available. If problems arise, then you should contact Oracle regarding vulnerabilities.

- [Downloading Security Patches and Workaround Solutions](#)
Security patches apply to the operating system on which Oracle Database resides, Oracle Database itself, and all installed Oracle Database options and components.
- [Contacting Oracle Security Regarding Vulnerabilities in Oracle Database](#)
You can contact Oracle Security regarding vulnerabilities in Oracle Database.

A.2.1 Downloading Security Patches and Workaround Solutions

Security patches apply to the operating system on which Oracle Database resides, Oracle Database itself, and all installed Oracle Database options and components.

- To download security patches and workaround solutions:
 - For security patches, periodically check the security site on Oracle Technology Network for details about security alerts released by Oracle at <http://www.oracle.com/technetwork/topics/security/alerts-086861.html>.
 - Check the Oracle Worldwide Support Service site, My Oracle Support, for details about available and upcoming security-related patches at <https://support.oracle.com>.

A.2.2 Contacting Oracle Security Regarding Vulnerabilities in Oracle Database

You can contact Oracle Security regarding vulnerabilities in Oracle Database.

- Contact Oracle Security using either of the following methods:
 - If you are an Oracle customer or an Oracle partner, use My Oracle Support to submit a Service Request on any potential Oracle product security vulnerability.
 - Send an email to `secalert_us@oracle.com` with a complete description of the problem, including product version and platform, together with any scripts and examples. Oracle encourages those who want to contact Oracle Security to employ email encryption, using our encryption key.

A.3 Guidelines for Securing User Accounts and Privileges

Oracle provides guidelines to secure user accounts and privileges.

1. Lock and expire default (predefined) user accounts.

Oracle Database installs with several default database user accounts. Upon successful installation of the database, the Database Configuration Assistant automatically locks and expires most default database user accounts.

If you perform a manual (without using Database Configuration Assistant) installation of Oracle Database, then no default database users are locked upon successful installation of the database server. Or, if you have upgraded from a previous release of Oracle Database, you may have default accounts from earlier releases. Left open in their default states, these user accounts can be exploited, to gain unauthorized access to data or disrupt database operations.

You should *lock* and *expire* all default database user accounts. Oracle Database provides SQL statements to perform these operations. For example:

```
ALTER USER ANONYMOUS PASSWORD EXPIRE ACCOUNT LOCK;
```

Installing additional products and components after the initial installation also results in creating more default database accounts. Database Configuration Assistant automatically locks and expires all additionally created database user accounts. Unlock only those accounts that need to be accessed on a regular basis and assign a strong, meaningful password to each of these unlocked accounts. Oracle provides SQL and password management to perform these operations.

If any default database user account other than the ones left open is required for any reason, then a database administrator (DBA) must unlock and activate that account with a new, secure password.

If a default database user account, other than the ones left open, is required for any reason, then a database administrator (DBA) can unlock and activate that account with a new, secure password.

Securing Oracle Enterprise Manager Accounts

If you install Oracle Enterprise Manager, the `SYSMAN` and `DBSNMP` accounts are open, unless you configure Oracle Enterprise Manager for central administration. In this case, the `SYSMAN` account (if present) will be locked.

If you do not install Oracle Enterprise Manager, then only the `SYS` and `SYSTEM` accounts are open. Database Configuration Assistant locks and expires all other accounts (including `SYSMAN` and `DBSNMP`).

2. Discourage users from using the NOLOGGING clause in SQL statements.

In some SQL statements, the user has the option of specifying the `NOLOGGING` clause, which indicates that the database operation is not logged in the online redo log file. Even though the user specifies the clause, a redo record is still written to the online redo log file.

However, there is no data associated with this record. Because of this, using `NOLOGGING` has the potential for malicious code to be entered can be accomplished without an audit trail.

3. Practice the principle of least privilege.

Oracle recommends the following guidelines:

a. Grant necessary privileges only.

Do not provide database users or roles more privileges than are necessary. (If possible, grant privileges to roles, not users.) In other words, the *principle of least privilege* is that users be given only those privileges that are actually required to efficiently perform their jobs.

To implement this principle, restrict the following as much as possible:

- The number of `SYSTEM` and `OBJECT` privileges granted to database users.
- The number of people who are allowed to make `SYS`-privileged connections to the database.
- The number of users who are granted the `ANY` privileges, such as the `DROP ANY TABLE` privilege. For example, there is generally no need to grant `CREATE ANY TABLE` privileges to a non-DBA-privileged user.
- The number of users who are allowed to perform actions that create, modify, or drop database objects, such as the `TRUNCATE TABLE`, `DELETE TABLE`, `DROP TABLE` statements, and so on.

b. Limit granting the `CREATE ANY EDITION` and `DROP ANY EDITION` privileges.

To maintain additional versions of objects, editions can increase resource and disk space consumption in the database. Only grant the `CREATE ANY EDITION` and `DROP ANY EDITION` privileges to trusted users who are responsible for performing upgrades.

c. Re-evaluate the `SELECT` object privilege and `SELECT ANY TABLE` system privileges that you have granted to users.

If you want to restrict users to only being able to query tables, views, materialized views, and synonyms, then grant users the `READ` object privilege, or for trusted users only, the `READ ANY TABLE` system privilege. If in addition to performing query operations, you want users to be able to lock tables in exclusive mode or perform `SELECT ... FOR UPDATE` statements, then grant the user the `SELECT` object privilege or, for trusted users only, the `SELECT ANY TABLE` system privilege.

d. Restrict the `CREATE ANY JOB`, `BECOME USER`, `EXP_FULL_DATABASE`, and `IMP_FULL_DATABASE` privileges. Also restrict grants of the `CREATE DIRECTORY` and `CREATE ANY DIRECTORY` privileges.

These are powerful security-related privileges. Only grant these privileges to users who need them.

e. Restrict the `BECOME USER` privilege to users of Oracle Data Pump, and the `DBMS_WORKLOAD_CAPTURE` and `DBMS_WORKLOAD_REPLAY` packages.

The `BECOME USER` privilege is used only for the following subsystems:

- Oracle Data Pump Import utilities `impdp` and `imp`, to assume the identity of another user to perform operations that cannot be directly performed by a third party (for example, loading objects such as object privilege grants). In an Oracle Database Vault environment, Database Vault provides several levels of required authorization that affect grants of `BECOME USER`.

- `DBMS_WORKLOAD_CAPTURE` and `DBMS_WORKLOAD_REPLAY` PL/SQL packages, as a required privilege to be granted to users who must use these packages.

If you use the `AUTHID CURRENT_USER` clause when invoking one of these subsystems (for example, in static references in PL/SQL code), then ensure that the `CURRENT_USER` is granted the `BECOME USER` privilege, either by a direct grant or through a role.

f. Restrict library-related privileges to trusted users only.

The `CREATE LIBRARY`, `CREATE ANY LIBRARY`, `ALTER ANY LIBRARY`, and `EXECUTE ANY LIBRARY` privileges, and grants of `EXECUTE ON library_name` convey a great deal of power to users. If you plan to create PL/SQL interfaces to libraries, only grant the `EXECUTE` privilege to the PL/SQL interface. Do not grant `EXECUTE` on the underlying library. You must have the `EXECUTE` privilege on a library to create the PL/SQL interface to it. However, users have this privilege implicitly on libraries that they create in their own schemas. Explicit grants of `EXECUTE ON library_name` are rarely required. Only make an explicit grant of these privileges to trusted users, and never to the `PUBLIC` role.

g. Restrict synonym-related privileges to trusted users only.

The `CREATE PUBLIC SYNONYM` and `DROP PUBLIC SYNONYM` system privileges convey a great deal of power to these users. Do not grant these privileges to users, unless they are trusted.

h. Do not allow non-administrative users access to objects owned by the SYS schema.

Do not allow users to alter table rows or schema objects in the `SYS` schema, because doing so can compromise data integrity. Limit the use of statements such as `DROP TABLE`, `TRUNCATE TABLE`, `DELETE`, `INSERT`, or similar object-modification statements on `SYS` objects only to highly privileged administrative users.

i. Restrict permissions on run-time facilities.

Many Oracle Database products use run-time facilities, such as Oracle Java Virtual Machine (OJVM). Do not assign all permissions to a database run-time facility. Instead, grant specific permissions to the explicit document the root file paths for facilities that might run files and packages outside the database.

Here is an example of a vulnerable run-time call, which individual files are specified:

```
call dbms_java.grant_permission('wsmith', 'SYS:java.io.FilePermission', '<<ALL FILES>>', 'read');
```

Here is an example of a better (more secure) run-time call, which specifies a directory path instead:

```
call dbms_java.grant_permission('wsmith', 'SYS:java.io.FilePermission', '<<actual directory path>>', 'read');
```

4. Revoke access to the following:

- The `SYS.USER_HISTORY$` table from all users except `SYS` and `DBA` accounts
- The `RESOURCE` role from typical application accounts
- The `CONNECT` role from typical application accounts
- The `DBA` role from users who do not need this role

5. Grant privileges only to roles.

Granting privileges to roles and not individual users makes the management and tracking of privileges much easier.

6. **Limit the proxy account (for proxy authorization) privileges to CREATE SESSION only.**
7. **Use secure application roles to protect roles that are enabled by application code.**

Secure application roles allow you to define a set of conditions, within a PL/SQL package, that determine whether or not a user can log on to an application. Users do not need to use a password with secure application roles.

Another approach to protecting roles from being enabled or disabled in an application is the use of role passwords. This approach prevents a user from directly accessing the database in SQL (rather than the application) to enable the privileges associated with the role. However, Oracle recommends that you use secure application roles instead, to avoid having to manage another set of passwords.

8. **Create privilege captures to find excessively granted privileges.** Privilege analysis captures the privileges that users and applications use, and then presents these in a format for easy analysis. From there, you can revoke unnecessary privileges if you want.
9. **Monitor the granting of the following privileges only to users and roles who need these privileges.**

By default, Oracle Database audits the following privileges:

- ALTER SYSTEM
- AUDIT SYSTEM
- CREATE EXTERNAL JOB

Oracle recommends that you also audit the following privileges:

- ALL PRIVILEGES (which includes privileges such as BECOME USER, CREATE LIBRARY, and CREATE PROCEDURE)
 - DBMS_BACKUP_RESTORE package
 - EXECUTE to DBMS_SYS_SQL
 - SELECT ANY TABLE
 - SELECT on PERFSTAT.STATS\$SQLTEXT
 - SELECT on PERFSTAT.STATS\$SQL_SUMMARY
 - SELECT on SYS.SOURCE\$
 - Privileges that have the WITH ADMIN clause
 - Privileges that have the WITH GRANT clause
 - Privileges that have the CREATE keyword
10. **Use the following data dictionary views to find information about user access to the database.**
 - DBA_*
 - DBA_ROLES
 - DBA_SYS_PRIVS
 - DBA_ROLE_PRIVS
 - DBA_TAB_PRIVS
 - DBA_AUDIT_TRAIL (if standard auditing is enabled)
 - DBA_FGA_AUDIT_TRAIL (if fine-grained auditing is enabled)

Related Topics

- [Oracle Database Vault Administrator's Guide](#)
- [Performing Privilege Analysis to Identify Privilege Use](#)
Privilege analysis dynamically analyzes the privileges and roles that users use and do not use.

A.4 Guidelines for Securing Passwords

Oracle provides guidelines for securing passwords in a variety of situations.

When you create a user account, Oracle Database assigns a default password policy for that user. The password policy defines rules for how the password should be created, such as a minimum number of characters, when it expires, and so on. You can strengthen passwords by using password policies.

Follow these guidelines to further strengthen passwords:

1. Choose passwords carefully.

In addition to the minimum requirements for creating passwords, follow these additional guidelines when you create or change passwords:

- Make the password have a length of between 12 and 1024 bytes, and include both alphabetic characters and digits in the password.
- Have the password contain at least one digit, one upper-case character, and one lower-case character.
- Use mixed case characters and special characters in the password.
- You can include multibyte characters in the password but not in the password of any common user or role.
- Use the database character set for the password's characters, which can include the underscore (`_`), dollar (`$`), and number sign (`#`) characters.
- You must enclose the following passwords in double-quotation marks:
 - Passwords containing multibyte characters.
 - Passwords starting with numbers or special characters and containing alphabetic characters (a–z, A–Z). For example:

```
"123abc"  
"#abc"  
"123dc$"
```
 - Passwords containing any character other than alphabetic characters, numbers, and special characters. For example:

```
"abc>"  
"abc@",  
" "
```
- You do not need to specify the following passwords in double-quotation marks.
 - Passwords starting with an alphabetic character (a–z, A–Z) and containing numbers (0–9) or special characters (`$`, `#`, `_`). For example:

```
abc123
```

ab23a

ab\$#_

- Passwords containing only numbers
 - Passwords containing only alphabetic characters (a–z, A–Z)
 - Do not include double-quotation marks within the password.
 - Do not use an actual word for the entire password.
2. **To create a longer, more complex password from a shorter, easier to remember password, create the password from the first letters of the words of an easy-to-remember sentence.**

For example, "I usually work until 6:00 almost every day of the week" can be Iuwu6aedotw.

3. **Ensure that the password is sufficiently complex.**

Oracle Database provides a password complexity verification routine, the PL/SQL script `utlpwdmg.sql`, that you can run to check whether or not passwords are sufficiently complex. Ideally, edit the `utlpwdmg.sql` script to provide stronger password protections.

4. **Remember that multibyte characters are not allowed in passwords for common users or roles.**

For users who are local to a PDB, if you want to use multibyte characters in the password, then ensure that the database character set is configured as a multibyte character set so that the authentication will work properly.

Be aware that because multibyte characters consume more bytes than single-byte characters, they tend to provide less entropy per byte. Because the maximum length of the password is limited to 1024 bytes, to help increase the amount of entropy in a password, Oracle recommends that you also include a number of single-byte characters in the password, even when multibyte characters are being used.

5. **Associate a password complexity function with the user profile or the default profile.**

The `PASSWORD_VERIFY_FUNCTION` clause of the `CREATE PROFILE` and `ALTER PROFILE` statements associates a password complexity function with a user profile or the default profile. Password complexity functions ensure that users create strong passwords using guidelines that are specific to your site. Having a password complexity function also requires a user changing their own password (without the `ALTER USER` system privilege) to provide both the old and new passwords. You can create your own password complexity functions or use the password complexity functions that Oracle Database provides.

6. **Change default user passwords.**

Oracle Database installs with a set of predefined, default user accounts. Security is most easily broken when a default database user account still has a default password *even after installation*. This is particularly true for the user account `SCOTT`, which is a well known account that may be vulnerable to intruders. In Oracle Database, default accounts are installed locked with the passwords expired, but if you have upgraded from a previous release, you may still have accounts that use default passwords.

To find user accounts that have default passwords, query the `DBA_USERS_WITH_DEFPWD` data dictionary view.

7. **Change default passwords of administrative users.**

You can use the same or different passwords for the `SYS`, `SYSTEM`, `SYSMAN`, and `DBSNMP` administrative accounts. Oracle recommends that you use different passwords for each. In any Oracle environment (production or test), assign strong, secure, and distinct passwords to these administrative accounts. If you use Database Configuration Assistant to create a

new database, then it requires you to enter passwords for the SYS and SYSTEM accounts, disallowing the default passwords CHANGE_ON_INSTALL and MANAGER.

Similarly, for production environments, do not use default passwords for administrative accounts, including SYSMAN and DBSNMP.

8. Enforce password management.

Apply basic password management rules (such as password length, history, complexity, and so forth) to all user passwords. Oracle Database has password policies enabled for the default profile. Guideline 1 in this section lists these password policies.

You can find information about user accounts by querying the DBA_USERS view. The PASSWORD column of the DBA_USERS view indicates whether the password is global, external, or null. The DBA_USERS view provides useful information such as the user account status, whether the account is locked, and password versions.

Oracle also recommends, if possible, using Oracle strong authentication with network authentication services (such as Kerberos), token cards, smart cards, or X.509 certificates. These services provide strong authentication of users, and provide protection against unauthorized access to Oracle Database.

9. Do not store user passwords in clear text in Oracle tables.

For better security, do not store passwords in clear text (that is, human readable) in Oracle tables. You can correct this problem by using a secure external password store to encrypt the password within an Oracle wallet. (An Oracle wallet is a secure software container that stores authentication and signing credentials.)

When you create or modify a password for a user account, Oracle Database automatically creates a cryptographic hash or digest of the password. If you query the DBA_USERS view to find information about a user account, the data in the PASSWORD column indicates if the user password is global, external, or null. The DBA_USERS view also has a column called PASSWORD_VERSIONS, which lists the types of cryptographic hash that exist for the user's password (11G or 12C).

10. Disable the HTTP verifier if the user is not going to be using either XDB authentication or HTTP Digest authentication.

The HTTP verifier is used only for XDB authentication and HTTP Digest authentication. If a user is not going to use XDB authentication or HTTP Digest authentication, then you can safely remove the HTTP verifier from the user's list of verifiers. To remove a user's HTTP verifier, run the following statement:

```
ALTER USER username DIGEST DISABLE;
```

Related Topics

- [Minimum Requirements for Passwords](#)
Oracle provides a set of minimum requirements for passwords.
- [Configuring Password Protection](#)
You can secure user passwords in a variety of ways, such as controlling the password creation requirements or using password management policies.
- [Ensuring Against Password Security Threats by Using the 12C Password Version](#)
The 12C password version enables users to create complex passwords that meet compliance standards.
- [About Password Complexity Verification](#)
Complexity verification checks that each password is complex enough to protect against intruders who try to guess user passwords.

- [Managing the Complexity of Passwords](#)
Oracle Database provides a set of functions that you can use to manage the complexity of passwords.
- [Finding User Accounts That Have Default Passwords](#)
The `DBA_USERS_WITH_DEFPWD` data dictionary view can find user accounts that use default passwords.
- [Managing the Secure External Password Store for Password Credentials](#)
The secure external password store (SEPS) is a client-side wallet that is used to store password credentials.

A.5 Securing Authentication for Oracle Database Microsoft Windows Installations

By default, the `SQLNET.NO_NTLM` parameter setting in the `sqlnet.ora` file on Microsoft Windows installations with `AUTHENTICATION_SERVICES=NTS` is `TRUE`.

If you upgrade from a previous release where the `SQLNET.NO_NTLM` parameter had not been set, then it defaults to `TRUE`.

You must include this setting on both the server and client, and this setting should be the same on both. Ideally, you should ensure that `SQLNET.NO_NTLM` is set to `TRUE`. However, if there is an authentication failure in `extproc`, a virtual account, or a local account on Windows, set the client `SQLNET.NO_NTLM` to `FALSE`, and then retry the login. If you change `SQLNET.NO_NTLM` on the server, then you must restart the database.

A.6 Guidelines for Securing Roles

Oracle provides guidelines for role management.

1. Grant a role to users only if they need all privileges of the role.

Roles (groups of privileges) are useful for quickly and easily granting permissions to users. Although you can use Oracle-defined roles, you have more control and continuity if you create your own roles containing only the privileges pertaining to your requirements. Oracle may change or remove the privileges in an Oracle Database-defined role, as it has with the `CONNECT` role, which now has only the `CREATE SESSION` privilege. Formerly, this role had eight other privileges.

Ensure that the roles you define contain only the privileges that reflect job responsibility. If your application users do not need all the privileges encompassed by an existing role, then apply a different set of roles that supply just the correct privileges. Alternatively, create and assign a more restricted role.

For example, it is imperative to strictly limit the privileges of user `SCOTT`, because this is a well known account that may be vulnerable to intruders. Because the `CREATE DBLINK` privilege allows access from one database to another, drop its privilege for `SCOTT`. Then, drop the entire role for the user, because privileges acquired by means of a role cannot be dropped individually. Re-create your own role with only the privileges needed, and grant that new role to that user. Similarly, for better security, drop the `CREATE DBLINK` privilege from all users who do not require it.

2. Do not grant user roles to application developers.

Roles are not meant to be used by application developers, because the privileges to access schema objects within stored programmatic constructs need to be granted directly.

Remember that roles are not enabled within stored procedures except for invoker's right procedures.

3. Create and assign roles specific to each Oracle Database installation.

This principle enables the organization to retain detailed control of its roles and privileges. This also avoids the necessity to adjust if Oracle Database changes or removes Oracle Database-defined roles, as it has with `CONNECT`, which now has only the `CREATE SESSION` privilege. Formerly, it also had eight other privileges.

4. For enterprise users, create global roles.

Global roles are managed by an enterprise directory service, such as Oracle Internet Directory.

Related Topics

- [How Roles Work in PL/SQL Blocks](#)
Role behavior in a PL/SQL block is determined by the type of block and by definer's rights or invoker's rights.
- [Authorizing a Global Role by an Enterprise Directory Service](#)
A global role enables a global user to be authorized only by an enterprise directory service.
- *Oracle Database Enterprise User Security Administrator's Guide*

A.7 Guidelines for Securing Data

Oracle provides guidelines for securing data on your system.

1. Restrict operating system access.

Follow these guidelines:

- Limit the number of operating system users.
- Limit the privileges of the operating system accounts (administrative, root-privileged, or database administrative) on the Oracle Database host computer to the least privileges required for a user to perform necessary tasks.
- Restrict the ability to modify the default file and directory permissions for the Oracle Database home (installation) directory or its contents. Even privileged operating system users and the Oracle owner should not modify these permissions, unless instructed otherwise by Oracle.
- Restrict symbolic links. Ensure that when you provide a path or file to the database, neither the file nor any part of the path is modifiable by an untrusted user. The file and all components of the path should be owned by the database administrator or trusted account, such as *root*.

This recommendation applies to all types of log files, trace files, external tables, BFILE data types, and so on.

2. Encrypt sensitive data and all backup media that contains database files.

According to common regulatory compliance requirements, you must encrypt sensitive data such as credit card numbers and passwords. When you delete sensitive data from the database, encrypted data does not linger in data blocks, operating system files, or sectors on disk.

In most cases, you may want to use Transparent Data Encryption to encrypt your sensitive data.

3. **For Oracle Automatic Storage Management (Oracle ASM) environments on Linux and UNIX systems, use Oracle ASM File Access Control to restrict access to the Oracle ASM disk groups.**

If you use different operating system users and groups for Oracle Database installations, then you can configure Oracle ASM File Access Control to restrict the access to files in Oracle ASM disk groups to only authorized users. For example, a database administrator would only be able to access the data files for the databases that they manage. This administrator would not be able to see or overwrite the data files belonging (or used by) other databases.

For more information about managing Oracle ASM File Access Control for disk groups and the various privileges that are required for multiple software owners, see *Oracle Automatic Storage Management Administrator's Guide*.

Related Topics

- [Security Problems That Encryption Does Not Solve](#)
While there are many good reasons to encrypt data, there are many reasons not to encrypt data.
- [Oracle Database Advanced Security Guide](#)
- [Oracle Automatic Storage Management Administrator's Guide](#)
- [Oracle Automatic Storage Management Administrator's Guide](#)

A.8 Guidelines for Securing the ORACLE_LOADER Access Driver

Oracle provides guidelines to secure the ORACLE_LOADER access driver.

1. **Create a separate operating system directory to store the access driver preprocessors.** You (or the operating system manager) may need to create multiple directories if different Oracle Database users will run different preprocessors. If you want to prevent one set of users from using one preprocessor while allowing those users access to another preprocessor, then place the preprocessors in separate directories. If all the users need equal access, then you can place the preprocessors together in one directory. After you create these operating system directories, in SQL*Plus, you can create a directory object for each directory.
2. **Grant the operating system user ORACLE the correct operating system privileges to run the access driver preprocessor.** In addition, protect the preprocessor program from WRITE access by operating system users other than the user responsible for managing the preprocessor program.
3. **Grant the EXECUTE privilege to each user who will run the preprocessor program in the directory object.** Do not grant this user the WRITE privilege on the directory object. Never grant users both the EXECUTE and WRITE privilege for directory objects.
4. **Grant the WRITE privilege sparingly to anyone who will manage directory objects that contain preprocessors.** This prevents database users from accidentally or maliciously overwriting the preprocessor program.
5. **Create a separate operating system directory and directory object for any data files that are required for external tables.** Ensure that these are separate from the directory and directory object used by the access directory preprocessor.

Work with the operating system manager to ensure that only the appropriate operating system users have access to this directory. Grant the ORACLE operating system user READ

access to any directory that has a directory object with `READ` privileges granted to database users. Similarly, grant the `ORACLE` operating system user `WRITE` access to any directory that has the `WRITE` privilege granted to database users.

6. **Create a separate operating system directory and directory object for any files that the access driver generates.** This includes log files, bad files, and discarded files. You and the operating system manager must ensure that this directory and directory object have the proper protections, similar to those described in Guideline 5. The database user may need to access these files when resolving problems in data files, so you and the operating system manager must determine a way for this user to read those files.
7. **Grant the `CREATE ANY DIRECTORY` and `DROP ANY DIRECTORY` privileges sparingly.** Users who have these privileges and users who have been granted the `DBA` role have full access to all directory objects.
8. **Consider auditing the `DROP ANY DIRECTORY` privilege.** You can create a unified audit policy to audit privileges.
9. **Consider auditing the directory object.** You can create a unified audit policy to audit objects.

Related Topics

- [Auditing System Privileges](#)
You can use the `CREATE AUDIT POLICY` statement to audit system privileges.
- [Auditing Object Actions](#)
You can use the `CREATE AUDIT POLICY` statement to audit object actions.
- *Oracle Database Utilities*

A.9 Guidelines for Securing a Database Installation and Configuration

Oracle provides guidelines to secure the database installation and configuration.

Changes were made to the default configuration of Oracle Database to make it more secure. The recommendations in this section augment the new, secure default configuration.

1. **Before you begin an Oracle Database installation on UNIX systems, ensure that the umask value is 022 for the Oracle owner account.**
2. **Install only what is required.**

Options and Products: The Oracle Database CD pack contains products and options in addition to the database. Install additional products and options only as necessary. Use the Custom Installation feature to avoid installing unnecessary products, or perform a typical installation, and then deinstall options and products that are not required. There is no need to maintain additional products and options if they are not being used. They can always be properly installed, as required.

Sample Schemas: Oracle Database provides sample schemas to provide a common platform for examples. If your database will be used in a production environment, then do not install the sample schema. If you have installed the sample schema on a test database, then before going to production, remove or relock the sample schema accounts.

3. **During installation, when you are prompted for a password, create a secure password.**

Choose the password carefully, ensure that you change the default passwords, and change the default passwords of administrative users.

4. Immediately after installation, lock and expire default user accounts.

For better security, you should lock and expire all default (predefined) user accounts.

Related Topics

- *Oracle Database Administrator's Reference for Linux and UNIX-Based Operating Systems*
- *Oracle Database Sample Schemas*
- [Guidelines for Securing Passwords](#)
Oracle provides guidelines for securing passwords in a variety of situations.
- [Guidelines for Securing User Accounts and Privileges](#)
Oracle provides guidelines to secure user accounts and privileges.

A.10 Guideline for Securing Multitenant PDBs from the Root in a Linux Environment

In Linux, you can securely compartmentalize PDBs to manage their resources in containers called nests.

A database instance that runs on a host must have isolation and resource management with respect to other databases and applications running in the same host. You can use security isolation to shield this database instance (even from the root), so that a security breach in any application does not affect the database instance.

To use this feature, you create a container, called a nest, around the pluggable database (PDB) that you want to protect. The nests are hierarchical. Each nest exists in isolation from other nests, and enables the nest administrator to manage isolation and resource settings for the PDB contained within the nest. Each nest provides the following features:

- Isolation of operating system resources, such as pid, mount, and network
- Resource management for resources such as CPU, memory, and network
- File system isolation, in which you can control the visibility for various system level entities in a nest
- Secure computing, to filter, enable, or disable required system calls at the nest level

Related Topics

- *Oracle Multitenant Administrator's Guide*

A.11 Guidelines for Securing the Network

Security for network communications is improved by using client, listener, and network guidelines to ensure thorough protection.

- [Client Connection Security](#)
Authenticating clients stringently, configuring encryption for the connection, and using strong authentication strengthens client connections.
- [Network Connection Security](#)
Protecting the network and its traffic from inappropriate access or modification is the essence of network security.
- [Transport Layer Security Connection Security](#)
Oracle provides guidelines for securing Transport Layer Security (TLS).

A.11.1 Client Connection Security

Authenticating clients stringently, configuring encryption for the connection, and using strong authentication strengthens client connections.

Because authenticating client computers is problematic, typically, user authentication is performed instead. This approach avoids client system issues that include falsified IP addresses, hacked operating systems or applications, and falsified or stolen client system identities.

Nevertheless, the following guidelines improve the security of client connections:

- 1. Configure the connection to use encryption.**

Oracle native network encryption makes eavesdropping difficult.

- 2. Set up strong authentication.**

You can use Kerberos authentication and public key infrastructure (PKI).

- 3. In an Oracle Data Guard environment, set the `ADG_ACCOUNT_INFO_TRACKING` initialization parameter.**

The `ADG_ACCOUNT_INFO_TRACKING` parameter controls login attempts on Oracle Active Data Guard standby databases. It provides more security against login attacks across an Oracle Database production environment and all Active Data Guard standby databases. Use one of the following settings:

- `LOCAL` (default) enforces the existing behavior, which maintains a local copy of user account information in the standby database's in-memory view. This setting only tracks login failures locally on a per-database basis. It denies the login when the maximum of failed logins is reached.
- `GLOBAL` increases the security of logins by maintaining a single global copy of user account information across all Data Guard primary and standby databases. Login failures across all databases in the Data Guard environment count toward the maximum count. When this count is reached, then logins anywhere are denied access.

Related Topics

- [Configuring Kerberos Authentication](#)
Kerberos is a trusted third-party authentication system that relies on shared secrets and presumes that the third party is secure.
- *Oracle Database Reference*

A.11.2 Network Connection Security

Protecting the network and its traffic from inappropriate access or modification is the essence of network security.

You should consider all paths the data travels, and assess the threats on each path and node. Then, take steps to lessen or eliminate those threats and the consequences of a security breach. In addition, monitor and audit to detect either increased threat levels or penetration attempts.

To manage network connections, you can use Oracle Net Manager. For more information about Net Manager, see *Oracle Database Net Services Administrator's Guide*.

The following practices improve network security:

1. Use Transport Layer Security (TLS) when administering the listener.

TLS can protect the messages sent and received by you or by applications and servers, supporting secure authentication, authorization, and messaging through certificates and, if necessary, encryption.

2. Prevent online administration by requiring the administrator to have the write privilege on the listener password and on the listener.ora file on the server.

a. Add or alter this line in the `listener.ora` file:

```
ADMIN_RESTRICTIONS_LISTENER=ON
```

b. Use `RELOAD` to reload the configuration.

c. Use TLS when administering the listener by making the TCPS protocol the first entry in the address list, as follows:

```
LISTENER=
  (DESCRIPTION=
    (ADDRESS_LIST=
      (ADDRESS=
        (PROTOCOL=tcps)
        (HOST = sales.us.example.com)
        (PORT = 8281)))
```

To administer the listener remotely, you define the listener in the `listener.ora` file on the client computer. For example, to access listener `USER281` remotely, use the following configuration:

```
user281 =
  (DESCRIPTION =
    (ADDRESS =
      (PROTOCOL = tcps)
      (HOST = sales.us.example.com)
      (PORT = 8281))
    )
  )
```

3. Do not set the listener password.

Ensure that the password has not been set in the `listener.ora` file. The local operating system authentication will secure the listener administration. The remote listener administration is disabled when the password has not been set. This prevents brute force attacks of the listener password.

The listener password has been deprecated in this release. It will not be supported in the next release of Oracle Database.

4. When a host computer has multiple IP addresses associated with multiple network interface controller (NIC) cards, configure the listener to the specific IP address.

This allows the listener to listen on all the IP addresses. You can restrict the listener to listen on a specific IP address. Oracle recommends that you specify the specific IP addresses on these types of computers, rather than allowing the listener to listen on all IP addresses. Restricting the listener to specific IP addresses helps to prevent an intruder from stealing a TCP end point from under the listener process.

5. Restrict the privileges of the listener, so that it cannot read or write files in the database or the Oracle server address space.

This restriction prevents external procedure agents spawned by the listener (or procedures run by an agent) from inheriting the ability to perform read or write operations. The owner of this separate listener process should not be the owner that installed Oracle Database or runs the Oracle Database instance (such as `ORACLE`, the default owner).

For more information about configuring external procedures in the listener, see *Oracle Database Net Services Administrator's Guide*.

6. Use encryption to secure the data in flight.

Strong authentication will help to protect network data encryption.

7. Use a firewall.

Appropriately placed and configured firewalls can prevent outside access to your databases.

- Keep the database server behind a firewall. Oracle Database network infrastructure, Oracle Net Services (formerly known as SQL*Net), provides support for a variety of firewalls from various vendors. Supported proxy-enabled firewalls include Gauntlet from Network Associates and Raptor from Axent. Supported packet-filtering firewalls include PIX Firewall from Cisco, and supported stateful inspection firewalls (more sophisticated packet-filtered firewalls) include Firewall-1 from CheckPoint.
- Ensure that the firewall is placed outside the network to be protected.
- Configure the firewall to accept only those protocols, applications, or client/server sources that you know are safe.
- Use a product such as Net8 and Oracle Connection Manager to manage multiplex multiple client network sessions through a single network connection to the database. It can filter on source, destination, and host name. This product enables you to ensure that connections are accepted only from physically secure terminals or from application Web servers with known IP addresses. (Filtering on IP address alone is not enough for authentication, because it can be falsified.)

8. Prevent unauthorized administration of the Oracle listener.

For more information about the listener, see *Oracle Database Net Services Administrator's Guide*.

9. Check network IP addresses.

Use the Oracle Net *valid node checking* security feature to allow or deny access to Oracle server processes from network clients with specified IP addresses. To use this feature, set the following `sqlnet.ora` configuration file parameters:

```
tcp.validnode_checking = YES

tcp.excluded_nodes = {list of IP addresses}

tcp.invited_nodes = {list of IP addresses}
```

The `tcp.validnode_checking` parameter enables the feature. The `tcp.excluded_nodes` and `tcp.invited_nodes` parameters deny and enable specific client IP addresses from making connections to the Oracle listener. This helps to prevent potential Denial of Service attacks.

10. Set Oracle Connection Manager parameters to prevent denial-of-service attacks. The following parameters in the Oracle Connection Manager `cman.ora` configuration file set a limit on the number of new connections that are allowed from an IP address in the specified unit of time:

- `IP_RATE_COUNT`: Specifies the number of new connections allowed from an IP address in the specified time interval.
- `IP_RATE_INTERVAL`: Specifies the time interval, in seconds, for which `IP_RATE_COUNT` connections are accepted from the IP address.

- `IP_RATE_BLOCK`: Specifies the duration, in minutes, for which the IP address is blocked after exceeding the specified IP rate limit.

See *Oracle Database Net Services Administrator's Guide*.

11. Encrypt network traffic.

If possible, use Oracle native network data encryption to encrypt network traffic among clients, databases, and application servers.

12. Secure the host operating system (the system on which Oracle Database is installed).

Secure the host operating system by disabling all unnecessary operating system services. Both UNIX and Windows provide a variety of operating system services, most of which are not necessary for typical deployments. These services include FTP, TFTP, TELNET, and so forth. Be sure to close both the UDP and TCP ports for each service that is being disabled. Disabling one type of port and not the other does not make the operating system more secure.

13. Configure database link communication protocol.

To specify the protocols over which the database link communication takes place, set the `OUTBOUND_DBLINK_PROTOCOLS` initialization parameter to one of the following settings:

- `ALL` (default) enables all net protocols to be used for the database links.
- `comma-separated_list_of_protocols` can be set `TPC`, `TCPS`, or `IPC`. For example, for a single protocol:

```
ALTER SYSTEM SET OUTBOUND_DBLINK_PROTOCOLS=TCPS;
```

For multiple protocols:

```
ALTER SYSTEM SET OUTBOUND_DBLINK_PROTOCOLS=TCP,TCPS,IPC;
```

- `NONE` disables any database link communication.

14. If necessary, disable LDAP lookup for global database links.

Set the `ALLOW_GLOBAL_DBLINKS` initialization parameter to enable or disable LDAP lookup for global database links. Settings are as follows:

- `ON` enables LDAP lookup for global database links.
- `OFF` (default) disables LDAP lookup for global database links.

Related Topics

- *Oracle Database Net Services Administrator's Guide*
- [Configuring PKI Certificate Authentication](#)
You can configure Oracle Database to use PKI certificates for end-user authentication.
- *Oracle Database Net Services Administrator's Guide*
- [Introduction to Strong Authentication](#)
Strong authentication supports tools such as Transport Layer Security (TLS) to verify the identities of users who log in to the database.
- *Oracle Database Net Services Administrator's Guide*
- [Configuring Oracle Database Native Network Encryption and Data Integrity](#)
You can configure native Oracle Net Services data encryption and data integrity for both servers and clients.

A.11.3 Transport Layer Security Connection Security

Oracle provides guidelines for securing Transport Layer Security (TLS).

Transport Layer Security (TLS) is the Internet standard protocol for secure communication, providing mechanisms for data integrity and data encryption. These mechanisms can protect the messages sent and received by you or by applications and servers, supporting secure authentication, authorization, and messaging through certificates and, if necessary, encryption. Good security practices maximize protection and minimize gaps or disclosures that threaten security.

- 1. Ensure that configuration files (for example, for clients and listeners) use the correct port for TLS, which is the port configured upon installation.**

You can run HTTPS on any port, but the standards specify port 443, where any HTTPS-compliant browser looks by default. The port can also be specified in the URL, for example:

```
https://secure.example.com:4445/
```

If a firewall is in use, then it too must use the same ports for secure (TLS) communication.

- 2. Ensure that TCPS is specified as the PROTOCOL in the ADDRESS parameter in the tnsnames.ora file (typically on the client or in the LDAP directory).**

An identical specification must appear in the `listener.ora` file (typically in the `$ORACLE_HOME/network/admin` directory).

- 3. Ensure that the TLS mode is consistent for both ends of every communication. For example, the database (on one side) and the user or application (on the other) must have the same TLS mode.**

The mode can specify either client or server authentication (one-way), both client and server authentication (two-way), or no authentication.

- 4. Ensure that the server supports the client cipher suites and the certificate key algorithm in use.**
- 5. Enable DN matching for both the server and client, to prevent the server from falsifying its identity to the client during connections.**

This setting ensures that the server identity is correct by matching its global database name against the DN from the server certificate.

You can enable DN matching in the `tnsnames.ora` file. For example:

```
set:SSL_SERVER_CERT_DN="cn=finance,cn=OracleContext,c=us,o=example"
```

Otherwise, a client application would not check the server certificate, which could allow the server to falsify its identity.

- 6. Do not remove the encryption from your RSA private key inside your server.key file, which requires that you enter your pass phrase to read and parse this file.**

 **Note:**

A server without TLS does not require a pass phrase.

If you decide your server is secure enough, you could remove the encryption from the RSA private key while preserving the original file. This enables system boot scripts to start the database server, because no pass phrase is needed. Ideally, restrict permissions to the root user only, and have the Web server start as `root`, but then log on as another user. Otherwise, anyone who gets this key can impersonate you on the Internet, or decrypt the data that was sent to the server.

Related Topics

- [Configuring PKI Certificate Authentication](#)
You can configure Oracle Database to use PKI certificates for end-user authentication.
- [Oracle Database Net Services Reference](#)

A.12 Guideline for Securing External Procedures

The `ENFORCE_CREDENTIAL` environment variable controls how an `extproc` process authenticates user credentials and callout functions.

You can specify this variable in the `extproc.ora` file. Before modifying this variable, review your site's security requirements for the handling of external libraries. For maximum security, set the `ENFORCE_CREDENTIAL` variable to `TRUE`. The default setting is `FALSE`.

Related Topics

- [Securing External Procedures](#)
An external procedure is stored in a `.dll` or an `.so` file, separately from the database, and can be through a credential authentication.

A.13 Guidelines for Auditing

Oracle provides guidelines for auditing.

- [Manageability of Audited Information](#)
Although auditing is relatively inexpensive, limit the number of audited events as much as possible.
- [Audits of Typical Database Activity](#)
Oracle provides guidelines for when you must gather historical information about particular database activities.
- [Audits of Suspicious Database Activity](#)
Oracle provides guidelines for when you audit to monitor suspicious database activity.
- [Audits of Sensitive Data](#)
Oracle recommends that you include the `ACTIONS ALL` clause when you create unified audit policies on sensitive objects.
- [Recommended Audit Settings](#)
Oracle provides predefined policies that contain recommended audit settings that apply to most sites.
- [Best Practices for Querying the UNIFIED_AUDIT_TRAIL Data Dictionary View](#)
To get the best results from querying the `UNIFIED_AUDIT_TRAIL` data dictionary view, you should follow these guidelines.

A.13.1 Manageability of Audited Information

Although auditing is relatively inexpensive, limit the number of audited events as much as possible.

This minimizes the performance impact on the execution of audited statements and the size of the audit trail, making it easier to analyze and understand.

Follow these guidelines when devising an auditing strategy:

1. Evaluate your reason for auditing.

After you have a clear understanding of the reasons for auditing, you can devise an appropriate auditing strategy and avoid unnecessary auditing.

For example, suppose you are auditing to investigate suspicious database activity. This information by itself is not specific enough. What types of suspicious database activity do you suspect or have you noticed? A more focused auditing strategy might be to audit unauthorized deletions from arbitrary tables in the database. This purpose narrows the type of action being audited and the type of object being affected by the suspicious activity.

2. Audit knowledgeably.

Audit the minimum number of statements, users, or objects required to get the targeted information. This prevents unnecessary audit information from cluttering the meaningful information and using valuable space in the `SYSTEM` tablespace. Balance your need to gather sufficient security information with your ability to store and process it.

For example, if you are auditing to gather information about database activity, then determine exactly what types of activities you want to track, audit only the activities of interest, and audit only for the amount of time necessary to gather the information that you want. As another example, do not audit *objects* if you are only interested in logical I/O information for each session.

3. Before you implement an auditing strategy, consult your legal department.

You should have the legal department of your organization review your audit strategy. Because your auditing will monitor other users in your organization, you must ensure that you are correctly following the compliance and corporate policy of your site.

A.13.2 Audits of Typical Database Activity

Oracle provides guidelines for when you must gather historical information about particular database activities.

1. Audit only pertinent actions.

At a minimum, audit user access, the use of system privileges, and changes to the database schema structure. To avoid cluttering meaningful information with useless audit records and reduce the amount of audit trail administration, only audit the targeted database activities. Remember also that auditing too much can affect database performance.

For example, auditing changes to all tables in a database produces far too many audit trail records and can slow down database performance. However, auditing changes to critical tables, such as salaries in a Human Resources table, is useful.

You can audit specific actions by using fine-grained auditing.

2. Archive audit records and purge the audit trail.

After you collect the required information, archive the audit records of interest and then purge the audit trail of this information.

3. Remember your company's privacy considerations.

Privacy regulations often lead to additional business privacy policies. Most privacy laws require businesses to monitor access to personally identifiable information (PII), and monitoring is implemented by auditing. A business-level privacy policy should address all relevant aspects of data access and user accountability, including technical, legal, and company policy concerns.

4. Check the Oracle Database log files for additional audit information.

The log files generated by Oracle Database contain useful information that you can use when auditing a database. For example, an Oracle database creates an alert file to record `STARTUP` and `SHUTDOWN` operations, and structural changes such as adding data files to the database.

For example, if you want to audit committed or rolled back transactions, you can use the redo log files.

5. To reduce the size of the audit trail and recursive SQL statements, audit only top-level statements.

If you have concerns that the unified audit policy that you create will generate a very large number of records, then include the `ONLY TOPLEVEL` clause in the `CREATE AUDIT POLICY` statement. For example, an audit of the `DBMS_STATS.GATHER_DATABASE_STATS` SQL statement can generate thousands of audit records. You can audit top-level statements from all users, including user `SYS`.

Related Topics

- [Value-Based Auditing with Fine-Grained Audit Policies](#)
Fine-grained auditing enables you to perform value-based auditing to audit access to certain rows based on values in specific columns.
- [Archiving the Audit Trail](#)
To maintain the integrity and reliability of audit data, keep only minimal required audit data locally in the database.
- [Purging Audit Trail Records](#)
The `DBMS_AUDIT_MGMT` PL/SQL package can schedule automatic purge jobs, manually purge audit records, and perform other audit trail operations.

A.13.3 Audits of Suspicious Database Activity

Oracle provides guidelines for when you audit to monitor suspicious database activity.

1. First audit generally, and then specifically.

When you start to audit for suspicious database activity, often not much information is available to target specific users or schema objects. Therefore, audit generally first, that is, by using the unified audit policies. You can audit SQL statements, schema objects, privileges, and so on.

After you have recorded and analyzed the preliminary audit information, alter your audit policies to audit specific actions and privileges. You can add conditions to your policies to exclude unnecessary audit records. You can also use the `EXCEPT` clause in the `AUDIT POLICY` statement to exclude specific users who do not need to be audited.

You can use fine-grained auditing to audit specific actions, such as when and where a user logged in to a specific database instance.

Continue this process until you have gathered enough evidence to draw conclusions about the origin of the suspicious database activity.

2. Audit common suspicious activities.

Common suspicious activities are as follows:

- Users who access the database during unusual hours
- Multiple failed user login attempts
- Login attempts by non-existent users

In addition, be aware that sensitive data, such as credit card numbers, can appear in the audit trail columns, such as SQL text when used in the SQL query. You should also monitor users who share accounts or multiple users who are logging in from the same IP address. You can query the `UNIFIED_AUDIT_TRAIL` data dictionary view to find this kind of activity. For a very granular approach, create fine-grained audit policies.

Related Topics

- [Provisioning Audit Policies](#)
Oracle Database provides a variety of ways for you to audit activities.
- [Creating Custom Unified Audit Policies](#)
Oracle Database provides the flexibility to create and manage custom unified audit policies for your specialized needs.
- [Value-Based Auditing with Fine-Grained Audit Policies](#)
Fine-grained auditing enables you to perform value-based auditing to audit access to certain rows based on values in specific columns.

A.13.4 Audits of Sensitive Data

Oracle recommends that you include the `ACTIONS ALL` clause when you create unified audit policies on sensitive objects.

Including this clause ensures the generation of audit record for both direct access and indirect access of these sensitive objects. Only use `ACTIONS ALL` for the audit of sensitive objects.

Related Topics

- [Example: Auditing All Actions on a Table](#)
The `CREATE AUDIT POLICY` statement can audit all actions on a table.

A.13.5 Recommended Audit Settings

Oracle provides predefined policies that contain recommended audit settings that apply to most sites.

For example:

- `ORA_SECURECONFIG` audits the same default audit settings from Oracle Database Release 11g. It tracks the use of a number of privileges such as `ALTER ANY TABLE`, `GRANT ANY PRIVILEGE`, and `CREATE USER`. The actions that it tracks include `ALTER USER`, `CREATE ROLE`, `LOGON`, and other commonly performed activities. This policy is enabled by default only when the database is created in Oracle Database Release 12c.
- `ORA_DATABASE_PARAMETER` audits commonly used Oracle Database parameter settings: `ALTER DATABASE`, `ALTER SYSTEM`, and `CREATE SPFILE`. By default, this policy is not enabled.

- `ORA_ACCOUNT_MGMT` audits the commonly used user account and privilege settings: `CREATE USER`, `ALTER USER`, `DROP USER`, `CREATE ROLE`, `DROP ROLE`, `ALTER ROLE`, `SET ROLE`, `GRANT`, and `REVOKE`. By default, this policy is not enabled.

Related Topics

- [Auditing Activities with the Predefined Unified Audit Policies](#)
Oracle Database provides predefined unified audit policies that cover commonly used security-relevant audit settings.

A.13.6 Best Practices for Querying the UNIFIED_AUDIT_TRAIL Data Dictionary View

To get the best results from querying the `UNIFIED_AUDIT_TRAIL` data dictionary view, you should follow these guidelines.

- 1. Ensure the statistics of unified audit internal table are up to date.**
Run the `DBMS_STATS.GATHER_TABLE_STATS` procedure on the `AUD$UNIFIED` table in the `AUDSYS` schema to ensure that the unified audit table statistics are updated before you query the `UNIFIED_AUDIT_TRAIL` data dictionary view.
- 2. Load the unified audit records that were written to operating system spillover files.**
You can do this either explicitly or by configuring an Oracle Scheduler job, using the `DBMS_AUDIT_MGMT.LOAD_UNIFIED_AUDIT_FILES` procedure.
- 3. When the number of records in the unified audit trail reaches a significantly large number (for example, a million), then initiate the proper archiving and purging mechanisms.**
Archiving and purging the unified audit trail reduces the amount of data that otherwise could grow and cause read performance problems. Oracle recommends that you configure standard purging policies. The purging policies that you create will depend on the rate of audit records that are generated on your system. Frequent purges are required for high audit record generation rates.
- 4. Move the unified audit trail to a custom tablespace.**
Using a custom tablespace enables you to better manage audit data and reduces the impact on other objects in the `SYSAUX` tablespace. By default, the unified audit trail records are written to the `SYSAUX` tablespace. To use a different tablespace, run the `DBMS_AUDIT_MGMT.SET_AUDIT_TRAIL_LOCATION` procedure.
- 5. When you query the UNIFIED_AUDIT_TRAIL data dictionary view, include the EVENT_TIMESTAMP_UTC column in a WHERE clause.**
The `EVENT_TIMESTAMP_UTC` column records the timestamp of audited events in the UTC timezone. Including this column in the query helps to achieve the partition pruning, and thus improves read performance of the `UNIFIED_AUDIT_TRAIL` view.

Related Topics

- [Moving Operating System Audit Records into the Unified Audit Trail](#)
Audit records that have been written to the spillover audit files can be moved to the unified audit trail database table.
- [Archiving the Audit Trail](#)
To maintain the integrity and reliability of audit data, keep only minimal required audit data locally in the database.
- [Purging Audit Trail Records](#)
The `DBMS_AUDIT_MGMT` PL/SQL package can schedule automatic purge jobs, manually purge audit records, and perform other audit trail operations.

A.14 Addressing the CONNECT Role Change

The `CONNECT` role, introduced with Oracle Database version 7, added new and robust support for database roles.

- [Why Was the CONNECT Role Changed?](#)
The `CONNECT` role is used in sample code, applications, documentation, and technical papers.
- [How the CONNECT Role Change Affects Applications](#)
The `CONNECT` role changes can be seen in database upgrades, account provisioning, and installation of applications using new databases.
- [How the CONNECT Role Change Affects Users](#)
The change to the `CONNECT` role affects general users, application developers, and client/server applications differently.
- [Approaches to Addressing the CONNECT Role Change](#)
Oracle recommends three approaches to address the impact of the `CONNECT` role change.

A.14.1 Why Was the CONNECT Role Changed?

The `CONNECT` role is used in sample code, applications, documentation, and technical papers.

In Oracle Database 10g release 2 (10.2), the `CONNECT` role was changed. If you are upgrading from a release earlier than Oracle Database 10.2 to the current release, then you should be aware of how the `CONNECT` role has changed in the most recent release.

The `CONNECT` role was originally established a special set of privileges. These privileges were as follows: `ALTER SESSION`, `CREATE CLUSTER`, `CREATE DATABASE LINK`, `CREATE SEQUENCE`, `CREATE SESSION`, `CREATE SYNONYM`, `CREATE TABLE`, `CREATE VIEW`.

Beginning in Oracle Database 10g release 2, the `CONNECT` role has only the `CREATE SESSION` privilege, all other privileges are removed. Starting with Oracle Database 12c release 1, the `CONNECT` role had the `CREATE SESSION` and `SET CONTAINER` privileges.

Although the `CONNECT` role was frequently used to provision new accounts in Oracle Database, connecting to the database does not require all those privileges. Making this change enables you to enforce good security practices more easily.

Each user should have only the privileges needed to perform their tasks, an idea called the principle of least privilege. Least privilege mitigates risk by limiting privileges, so that it remains easy to do what is needed while concurrently reducing the ability to do inappropriate things, either inadvertently or maliciously.

A.14.2 How the CONNECT Role Change Affects Applications

The `CONNECT` role changes can be seen in database upgrades, account provisioning, and installation of applications using new databases.

- [How the CONNECT Role Change Affects Database Upgrades](#)
You should be aware of how the `CONNECT` role affects database upgrades.
- [How the CONNECT Role Change Affects Account Provisioning](#)
You should be aware of how the `CONNECT` role affects accounts provisioning.

- [How the CONNECT Role Change Affects Applications Using New Databases](#)
You should be aware of how the `CONNECT` role affects applications that use new databases.

A.14.2.1 How the CONNECT Role Change Affects Database Upgrades

You should be aware of how the `CONNECT` role affects database upgrades.

Upgrading your existing Oracle database to Oracle Database 10g Release 2 (10.2) automatically changes the `CONNECT` role to have only the `CREATE SESSION` privilege.

Most applications are not affected because the applications objects already exist: no new tables, views, sequences, synonyms, clusters, or database links need to be created.

Applications that create tables, views, sequences, synonyms, clusters, or database links, or that use the `ALTER SESSION` command dynamically, may fail due to insufficient privileges.

A.14.2.2 How the CONNECT Role Change Affects Account Provisioning

You should be aware of how the `CONNECT` role affects accounts provisioning.

If your application or DBA grants the `CONNECT` role as part of the account provisioning process, then only `CREATE SESSION` privileges are included. Any additional privileges must be granted either directly or through another role.

This issue can be addressed by creating a new customized database role.

Related Topics

- [Approaches to Addressing the CONNECT Role Change](#)
Oracle recommends three approaches to address the impact of the `CONNECT` role change.

A.14.2.3 How the CONNECT Role Change Affects Applications Using New Databases

You should be aware of how the `CONNECT` role affects applications that use new databases.

New databases created using the Oracle Database 10g Release 2 (10.2) Utility (DBCA), or using database creation templates generated from DBCA, define the `CONNECT` role with only the `CREATE SESSION` privilege.

Installing an application to use a new database may fail if the database schema used for the application is granted privileges solely through the `CONNECT` role.

A.14.3 How the CONNECT Role Change Affects Users

The change to the `CONNECT` role affects general users, application developers, and client/server applications differently.

- [How the CONNECT Role Change Affects General Users](#)
You should be aware of how the `CONNECT` role affects general users.
- [How the CONNECT Role Change Affects Application Developers](#)
You should be aware of how the `CONNECT` role affects application developers.
- [How the CONNECT Role Change Affects Client Server Applications](#)
You should be aware of how the `CONNECT` role affects client server applications.

A.14.3.1 How the CONNECT Role Change Affects General Users

You should be aware of how the `CONNECT` role affects general users.

The new `CONNECT` role supplies only the `CREATE SESSION` privilege. Users who connect to the database to use an application are not affected, because the `CONNECT` role still has the `CREATE SESSION` privilege.

However, appropriate privileges will not be present for a certain set of users if they are provisioned solely with the `CONNECT` role. These are users who create tables, views, sequences, synonyms, clusters, or database links, or use the `ALTER SESSION` command. The privileges they need are no longer provided with the `CONNECT` role. To authorize the additional privileges needed, the database administrator must create and apply additional roles for the appropriate privileges, or grant them directly to the users who need them.

Note that the `ALTER SESSION` privilege is required for setting events. Few database users should require the `ALTER SESSION` privilege.

The `ALTER SESSION` privilege is *not* required for other alter session commands.

A.14.3.2 How the CONNECT Role Change Affects Application Developers

You should be aware of how the `CONNECT` role affects application developers.

Application developers provisioned solely with the `CONNECT` role do not have appropriate privileges to create tables, views, sequences, synonyms, clusters, or database links, nor to use the `ALTER SESSION` statement.

You must either create and apply additional roles for the appropriate privileges, or grant them directly to the application developers who need them.

A.14.3.3 How the CONNECT Role Change Affects Client Server Applications

You should be aware of how the `CONNECT` role affects client server applications.

Most client/server applications that use dedicated user accounts will not be affected by this change.

However, applications that create private synonyms or temporary tables using dynamic SQL in the user schema during account provisioning or run-time operations will be affected. They will require additional roles or grants to acquire the system privileges appropriate to their activities.

A.14.4 Approaches to Addressing the CONNECT Role Change

Oracle recommends three approaches to address the impact of the `CONNECT` role change.

- [Creating a New Database Role](#)
The privileges removed from the `CONNECT` role can be managed by creating a new database role.
- [Restoring the CONNECT Privilege](#)
The `rstrconn.sql` script restores the `CONNECT` privileges.
- [Data Dictionary View to Show CONNECT Grantees](#)
The `DBA_CONNECT_ROLE_GRANTEES` data dictionary view enables administrators who continue using the old `CONNECT` role to see which users have that role.

- [Least Privilege Analysis Studies](#)
Oracle partners and application providers should conduct a least privilege analysis so that they can deliver more secure products to their Oracle customers.

A.14.4.1 Creating a New Database Role

The privileges removed from the `CONNECT` role can be managed by creating a new database role.

1. Connect to the upgraded Oracle database and create a new database role.

The following example uses a role called `my_app_developer`.

```
CREATE ROLE my_app_developer;
GRANT CREATE TABLE, CREATE VIEW, CREATE SEQUENCE, CREATE SYNONYM, CREATE CLUSTER,
CREATE DATABASE LINK, ALTER SESSION TO my_app_developer;
```

2. Determine which users or database roles have the `CONNECT` role, and grant the new role to these users or roles.

```
SELECT USER$.NAME, ADMIN_OPTION, DEFAULT_ROLE
FROM USER$, SYSAUTH$, DBA_ROLE_PRIVS
WHERE PRIVILEGE# =
(SELECT USER# FROM USER$ WHERE NAME = 'CONNECT')
AND USER$.USER# = GRANTEE#
AND GRANTEE = USER$.NAME
AND GRANTED_ROLE = 'CONNECT';
```

NAME	ADMIN_OPTI	DEF
R1	YES	YES
R2	NO	YES

```
GRANT my_app_developer TO R1 WITH ADMIN OPTION;
GRANT my_app_developer TO R2;
```

3. Determine the privileges that users require by creating a privilege analysis policy.

The information that you gather can then be analyzed and used to create additional database roles with finer granularity. Privileges that are not used can then be revoked for specific users.

For example:

```
BEGIN
DBMS_PRIVILEGE_CAPTURE.CREATE_CAPTURE(
  name      => 'my_app_dev_role_pol',
  description => 'Captures my_app_developer role use',
  type      => DBMS_PRIVILEGE_CAPTURE.G_ROLE,
  roles     => role_name_list('my_app_developer');
END;
/
EXEC DBMS_PRIVILEGE_CAPTURE.ENABLE_CAPTURE ('my_app_dev_role_pol');
```

4. After a period of time, disable the privilege analysis policy and then generate a report.

```
EXEC DBMS_PRIVILEGE_CAPTURE.DISABLE_CAPTURE ('my_app_dev_role_pol');

EXEC DBMS_PRIVILEGE_CAPTURE.GENERATE_RESULT ('my_app_dev_role_pol');
```

5. After you generate the report, query the privilege analysis data dictionary views.

For example:

```
SELECT USERNAME, SYS_PRIV, OBJECT_OWNER, OBJECT_NAME FROM DBA_USED_PRIVS;
```

Related Topics

- [Performing Privilege Analysis to Identify Privilege Use](#)
Privilege analysis dynamically analyzes the privileges and roles that users use and do not use.

A.14.4.2 Restoring the CONNECT Privilege

The `rstrconn.sql` script restores the `CONNECT` privileges.

After a database upgrade or new database creation, you can use this script to grant the privileges that were removed from the `CONNECT` role in Oracle Database 10g release 2 (10.2). If you use this approach, then you should revoke privileges that are not used from users who do not need them.

To restore the `CONNECT` privilege:

1. Run the `rstrconn.sql` script, which is in the `$ORACLE_HOME/rdbms/admin` directory.

```
@$ORACLE_HOME/rdbms_admin/rstrconn.sql
```

2. Monitor the privileges that are used.

For example:

```
CREATE AUDIT POLICY connect_priv_pol
  PRIVILEGES AUDIT CREATE TABLE, CREATE SEQUENCE, CREATE SYNONYM, CREATE DATABASE
  LINK, CREATE CLUSTER, CREATE VIEW, ALTER SESSION;
```

```
AUDIT POLICY connect_priv_pol BY psmith;
```

3. Periodically, monitor database privilege usage.

For example:

```
SELECT USERID, NAME FROM AUD$, SYSTEM_PRIVILEGE_MAP WHERE - PRIV$USED = PRIVILEGE;
```

```
USERID                                NAME
-----                                -
ACME                                   CREATE TABLE
ACME                                   CREATE SEQUENCE
ACME                                   CREATE TABLE
ACME                                   ALTER SESSION
APPS                                   CREATE TABLE
APPS                                   CREATE TABLE
APPS                                   CREATE TABLE
APPS                                   CREATE TABLE
8 rows selected.
```

A.14.4.3 Data Dictionary View to Show CONNECT Grantees

The `DBA_CONNECT_ROLE_GRANTEES` data dictionary view enables administrators who continue using the old `CONNECT` role to see which users have that role.

[Table A-1](#) shows the columns in the `DBA_CONNECT_ROLE_GRANTEES` view.

Table A-1 Columns and Contents for DBA_CONNECT_ROLE GRANTEES

Column	Datatype	NULL	Description
GRANTEE	VARCHAR2 (128)	NULL	User granted the CONNECT role
PATH_OF_CONNECT_ROLE_GRANT	VARCHAR2 (4000)	NULL	Role (or nested roles) by which the user is granted CONNECT
ADMIN_OPT	VARCHAR2 (3)	NULL	YES if user has the ADMIN option on CONNECT; otherwise, NO

A.14.4.4 Least Privilege Analysis Studies

Oracle partners and application providers should conduct a least privilege analysis so that they can deliver more secure products to their Oracle customers.

The principle of least privilege mitigates risk by limiting privileges to the minimum set required to perform a given function.

For each class of users that the analysis shows need the same set of privileges, create a role with only those privileges. Remove all other privileges from those users, and assign that role to those users. As needs change, you can grant additional privileges, either directly or through these new roles, or create new roles to meet new needs. This approach helps to ensure that inappropriate privileges have been limited, thereby reducing the risk of inadvertent or malicious harm.

You can create privilege analysis policies that show the use of privileges by database users. The policies capture this information and make it available in data dictionary views. Based on these reports, you can determine who should have access to your data.

Related Topics

- [Performing Privilege Analysis to Identify Privilege Use](#)
Privilege analysis dynamically analyzes the privileges and roles that users use and do not use.

B

Managing Oracle Database Wallets and Certificates

You can use the `orapki` command line utility and `sqlnet.ora` parameters to manage public key infrastructure (PKI) elements.

- [Introduction to Oracle Database Wallets and Certificates](#)
Oracle Database provides several types of public key infrastructure (PKI) elements (wallets and certificates), as well as tools to manage them.
- [Managing Oracle Database Wallets and Certificates with the `orapki` Utility](#)
The `orapki` command-line utility is installed by default with the Oracle Database server.
- [Managing Oracle Database Wallets](#)
The `orapki` command-line utility enables you to create and manage wallets before you add certificates to them.
- [Managing Oracle Database Certificates](#)
After you create a wallet, you can associate certificates with it to validate the identities of entities that are associated with the wallet.
- [Examples of Creating Wallets and Certificates Using `orapki`](#)
Examples of `orapki` commands include creating wallets, user certificates, and wallets with self-signed certificates, and exporting certificates.
- [orapki Utility Commands Summary](#)
The `orapki` commands perform a variety of wallet, certificate revocation lists (CRL), and certificate management tasks.
- [mkstore Utility Commands Summary](#)
The `mkstore` command line utility, available as part other Oracle Database client and server installations, enables you to create wallets and add credential secrets such as user names and passwords.

B.1 Introduction to Oracle Database Wallets and Certificates

Oracle Database provides several types of public key infrastructure (PKI) elements (wallets and certificates), as well as tools to manage them.

- [About Oracle Database Wallets](#)
An Oracle Database wallet is a password-protected container that stores authentication and signing credentials, including private keys and certificates that enable database clients to communicate across an Oracle Database network.
- [About Oracle Database Certificates](#)
An Oracle Database certificate (public key infrastructure (PKI) digital certificate) is a wallet component that validates the identity of an end entity in a public key or private key exchange that uses the wallet.
- [About Certificate Authority \(CA\)](#)
A certificate authority (CA) is a trusted third party that certifies that other entities—users, databases, administrators, clients, servers—are who they say they are.

- [Tools Used to Manage Oracle Database Wallets and Certificates](#)
Oracle Database provides different tools for managing wallets and certificates, depending on how the wallet will be used.
- [General Process of Managing Oracle Database Wallets and Certificates](#)
Except for Transparent Data Encryption (TDE), you can use the `orapki` utility to create and manage Oracle Database wallets and certificates.
- [Oracle Database Wallet Search Order](#)
The search order that Oracle Database uses to find wallets depends on the feature for which the wallet was created, such as Transparent Data Encryption (TDE).

B.1.1 About Oracle Database Wallets

An Oracle Database wallet is a password-protected container that stores authentication and signing credentials, including private keys and certificates that enable database clients to communicate across an Oracle Database network.

The authentication and signing credentials in a wallet are encrypted. Oracle Database clients can read and use wallets when the client connects to the database server. The database server can also read and use wallets when it connects with other services such as directory services. Before a wallet can be used, it must be "open", that is, made accessible by the database server that must read and use the wallet. Depending on how the wallet is created, the wallet must be either opened manually by a database administrator or it can be opened automatically.

Oracle Database provides the following use cases for wallet use:

- Outbound wallets, which are used by the database server to connect with outside services, such as Oracle wallets used for Oracle Database connections with Microsoft Active Directory and `UTL_HTTP`. These are created and managed with the `orapki` utility.
- Secure external password store (SEPS) wallets, which are used for clients only and are created only with the read/write permissions of the current user, so that other users cannot read this wallet.
- Transport Layer Security (TLS) wallets, for both server and clients. These are used for strong authentication.
- Transparent Data Encryption (TDE) wallets, which are used for servers and clients, and are called keystores. See *Oracle Database Advanced Security Guide*.

There are four types (or modes) of wallets: standard password-protected wallet (PKCS#12, which have the `.p12` file extension), and three types of auto-login wallets.

- **Password-protected wallets:** When you create this type of wallet, you must assign it a password. Later on, when you perform different tasks with this wallet, such as modifying it, you must provide the password. This type of wallet must be explicitly opened by a database administrator before it can be used. The password-protected wallet conforms to the PKCS#12 standard with a file name of `ewallet.p12`.
- **Single sign-on (SSO) auto-login wallets:** When you create an auto-login wallet, you must provide a password. An auto-login wallet allows encrypted storage of secrets such as passwords so they are not stored in clear text files. Oracle Database can read the secrets in the wallet without requiring a user to enter a password every time. This type is automatically opened by the database server that accesses it. An auto-login wallet is a read/write wallet that consists of both a PKCS #12 file called `ewallet.p12` and a single sign-on (SSO) file called `cwallet.sso`. Both files contain the same content except that the `ewallet.p12` is protected with a user password while `cwallet.sso` is protected with an obfuscated random password. When you use the Oracle wallet utilities (`orapki` and

`mkstore` (deprecated)) to modify auto-login wallets, you must provide the password that was used to create the `ewallet.p12` wallet file. (Any modification can happen only on the `ewallet.p12` file and the changes are internally applied to the corresponding `cwallet.sso` file. The `cwallet.sso` cannot be modified on its own.)

You can use auto-login wallets across different systems. If your environment does not require the extra security provided by a wallet that must be explicitly opened for use, then you can use an auto-login wallet. Auto-login wallets are ideal for unattended scenarios (for example, Oracle Data Guard standby databases).

- **Local single sign-on (LSSO) auto-login wallets:** This type is an auto-login wallet that is used only locally to the computer on which it was created. It cannot be opened on any computer other than the one on which it is created. It is a read/write wallet that does not require a user password. It is locked to the host name and user name that were in effect when it was created; it consists only of an SSO file called `cwallet.sso`.
Local auto-login wallets are used for scenarios where additional security is required (that is, to limit the use of the auto-login for that computer) while supporting an unattended operation. You cannot use local auto-open wallets in Oracle Real Application Clusters (Oracle RAC)-enabled databases, because only shared wallets (in ACFS or ASM) are supported on those systems.
- **Auto-Login only (ALO or ESSO) wallet:** This wallet type is a read/write wallet that does not require a user password. It consists an SSO file called `cwallet.sso`.

All wallets that you create in this release of Oracle Database are in the PKCS#12 format. You can include the following security objects in a wallet:

- Certificates, which authenticate and validate user identities and encrypt data on communication channels. You can include the following types of certificates: trusted certificates, root certificates, user certificates, server certificates, private certificates, public certificates, and self-signed certificates.
- Certificates requests, which are requests submitted by an applicant to a CA to get an SSL certificate.
- Certificate revocation list (CRL), which is a list of digital certificates that have been revoked by the issuing certificate authority (CA).
- Secrets (such as passwords).
- For PKCS#11 wallets, specific PKCS#11 information, such as the path to the PKCS#11 library, tokens, smart cards, token passwords, and the certificate label on the token. The current standard is PKCS#12 and by default, the `orapki` utility creates wallets using this standard.
- For TDE keystores, a master encryption key, which is responsible for encrypting the data it is associated with, such as a table column, tablespace, or database. When you set the key for the wallet, you can specify an encryption algorithm for it, such as AES256. TDE keystores can also store secrets, such as user names and passwords.

 **Note:**

Be careful about deleting wallets. Doing so can cause problems in the Oracle Database environment if the wallet is in use. If you want to delete a wallet, then back it up beforehand.

Related Topics

- [Managing Oracle Database Wallets and Certificates with the orapki Utility](#)
The `orapki` command-line utility is installed by default with the Oracle Database server.
- [Configuring Centrally Managed Users with Microsoft Active Directory](#)
Oracle Database can authenticate and authorize Microsoft Active Directory users with the database directly without intermediate directories or Oracle Enterprise User Security.
- [Authenticating and Authorizing IAM Users for Oracle DBaaS Databases](#)
Identity and Access Management (IAM) users can be configured to connect to an Oracle Database as a service (Oracle DBaaS) instance.
- [Authenticating and Authorizing Microsoft Azure Users for Oracle Databases](#)
An Oracle database can be configured for Microsoft Azure users of Microsoft Entra ID (previously called Microsoft Azure AD) to connect using single sign-on authentication.
- [Managing the Secure External Password Store for Password Credentials](#)
The secure external password store (SEPS) is a client-side wallet that is used to store password credentials.
- [Configuring Transport Layer Security Encryption](#)
Use Transport Layer Security (TLS), a secure and standard protocol, to encrypt your database client and server connections.
- [Deleting a Wallet](#)
You can delete wallets, but be cautious when doing so. Deleting a wallet that is in use can problems with the Oracle Database environment.

B.1.2 About Oracle Database Certificates

An Oracle Database certificate (public key infrastructure (PKI) digital certificate) is a wallet component that validates the identity of an end entity in a public key or private key exchange that uses the wallet.

The certificate is an International Telecommunications Union (ITU) x.509 v3 standard data structure that securely binds an identity to a public key. It is created when the public key of an entity is signed by a trusted identity, a certificate authority (CA). The certificate ensures that information in the entity is correct, and that the public key belongs to that entity. A certificate contains the name of the entity, identifying information, expiration date, and a public key. It is also likely to contain a serial number and information about the rights, uses, and privileges associated with the certificate. Finally, it contains information about the CA that issued it.

Oracle Database enables you to configure and work with the following types of certificates:

- **Certificate chain:** This is an ordered list of certificates that contain an end-user or subscriber certificate and its certificate authority certificates.
- **Trusted root certificate:** This type, which is mandatory, identifies the certificate authority (CA) that issued the server or user certificate. If the server presents its certificate to the client, then the client will not accept that certificate unless it has a trusted root certificate from the CA that issued the server certificate. The reverse is also true: the server only trusts the client certificate if the server has the trusted root certificate that issued the client certificate. The trusted root certificate is the top certificate in a certificate chain, which is an ordered list of certificate components that can comprise the following: server or user certificate, trusted certificate, public or private certificate. Because it is trusted, it enables you to keep customer information private and secure.
- **Private certificate:** This type identifies the private key on which the wallet was created. A private certificate is only used by the user or server and is never sent to any other users or servers. A trust certificate validates a signed private or public certificate.

- **Public certificate:** This type identifies the public key on which the wallet is created, and is similar to private certificates. It is a digitally signed document that validates the name and authorization of a sender.
- **Server certificate:** This type, which is mandatory, identifies the database server that the wallet will use. It specifies which resources that a given server can have access to. It is sometimes used on devices that several servers share. Server certificates are typically issued to hosts or domains. There will always be a server certificate, even if that certificate is self-signed.
- **User certificate:** This type, which is optional, identifies the client that the wallet will use. It specifies which resources that a given user can have access to. It is sometimes used on devices that several users share. When different users log in, their profile and certificate are automatically loaded, granting them access to their required information. User certificates are used in the following cases:
 - For mutual Transport Layer Security (TLS), in which both ends of the communications channel must identify themselves
 - For PKI certificate authentication, in which the user certificate not only identifies the client, but also authenticates the server
- **Self-signed certificate:** This type is a public key certificate that is not issued by a CA. Configure self-signed certificates when there is no need for anyone to trust it, that is, you are only concerned with encryption. Even with a self-signed certificate, you still need the clients to connect. Therefore, the self-signed certificate is added to the client as a trusted certificate.

Following are some of the PKI elements that are related to certificates:

- **Certificate request:** The request has three parts: certification request information, a signature algorithm identifier, and a digital signature on the certification request information. The certification request information consists of the subject's distinguished name, public key, and an optional set of attributes. The attributes may provide additional information about the subject identity, such as postal address, or a challenge password by which the subject entity may later request certificate revocation. It is not mandatory to create a certificate request for the wallet. You can directly add a trusted certificate to the wallet or even a user certificate if a trusted certificate is already added.
- **Certificate revocation list (CRL):** This type is a signed data structure that contains a list of revoked certificates. The authenticity and integrity of the CRL is provided by a digital signature appended to it. Usually, the CRL signer is the same entity that signed the issued certificate. Typically, you create CRLs for user certificates. Because user certificates are held by users, it is not uncommon for them to be lost or stolen. When that happens, the issuing authority revokes them, and then publishes the revocation in the certificate revocation list that the services know not to trust the compromised certificates.

Related Topics

- [About Certificate Authority \(CA\)](#)
A certificate authority (CA) is a trusted third party that certifies that other entities—users, databases, administrators, clients, servers—are who they say they are.

B.1.3 About Certificate Authority (CA)

A certificate authority (CA) is a trusted third party that certifies that other entities—users, databases, administrators, clients, servers—are who they say they are.

When it certifies a user, the CA first seeks verification that the user is not on the certificate revocation list (CRL), then verifies the user's identity and grants a certificate, signing it with the certificate authority's private key. The CA has its own certificate and public key which it

publishes. Servers and clients use these to verify signatures the certificate authority has made. A CA might be an external company that offers certificate services, or an internal organization such as a corporate management information systems (MIS) department. You must send the certificate request to this CA. The CA will send you a signed user certificate and its associated trusted certificate.

B.1.4 Tools Used to Manage Oracle Database Wallets and Certificates

Oracle Database provides different tools for managing wallets and certificates, depending on how the wallet will be used.

- `orapki` is a command-line Oracle utility that you can use to create wallets, and then add and manage certificates, certificate requests, and certificate revocation lists (CRLs) in the wallet.
- `mkstore` is a command-line Oracle utility that you can use to add secrets and credentials to the wallet and then manage them. It is available in the Oracle Database client. Starting in Oracle Database release 23ai, `mkstore` is deprecated. Oracle recommends that you use the `orapki` instead of `mkstore`.
- The `ADMINISTER KEY MANAGEMENT` statement provides a SQL*Plus interface for managing Transparent Data Encryption (TDE) keystores. TDE keystore management also provides data dictionary and dynamic views for finding information about keystores.
- Oracle Key Vault enables you to centrally manage existing keys and security objects within an enterprise.



Note:

Starting with Oracle Database 23ai, the Oracle Wallet Manager (OWM) is desupported. Oracle recommends using the `orapki` command line tool to replace OWM.

Related Topics

- *Oracle Database SQL Language Reference*
- *Oracle Key Vault Administrator's Guide*

B.1.5 General Process of Managing Oracle Database Wallets and Certificates

Except for Transparent Data Encryption (TDE), you can use the `orapki` utility to create and manage Oracle Database wallets and certificates.

The general process is as follows:

1. Use the `orapki wallet create` command to create the wallet.
For example, to create the wallet in the `$ORACLE_HOME/admin/db_unique_name/wallet` directory:

```
orapki wallet create -wallet $ORACLE_HOME/admin/db_unique_name/wallet
```

2. Use the `orapki wallet add` command to generate a certificate request to associate with the wallet.

For example, for a DN named `CN=server_dn,C=US`, using a key size of 2048 bits:

```
orapki wallet add -wallet $ORACLE_HOME/admin/db_unique_name/wallet
-dn 'CN=server_dn,C=US'
-keySize 2048
```

3. After the certificate request is generated, send it to the certificate authority (CA) that you want to use.

You can export the certificate request to a file by using the `orapki wallet export` command, and share that file with CA to get a signed certificate.

For example, to export a request called `creq.txt`:

```
orapki wallet export -wallet $ORACLE_HOME/admin/db_unique_name/wallet
-dn 'CN=server_dn,C=US'
-request $ORACLE_HOME/admin/db_unique_name/wallet/creq.txt
```

4. The CA generates your signed user certificate and its associated trusted certificate. At this stage, you are ready to start importing certificates into the wallet.

5. Use the `orapki wallet add` command to import all the trusted certificates into the wallet. If you do not add all the trusted certificates, then the `orapki add` command will fail.

For example, to add a trusted certificate `trusted_cert.txt` to the wallet:

```
orapki wallet add -wallet $ORACLE_HOME/admin/db_unique_name/wallet
-trusted_cert -cert $ORACLE_HOME/wallet/trusted_cert.txt
```

6. Use the `orapki wallet add` command to import the user certificate into the wallet. For example, to import a user certificate that is in the `cert.txt` file:

```
orapki wallet add -wallet $ORACLE_HOME/admin/db_unique_name/wallet/
ewallet.p12
-user_cert
-cert $ORACLE_HOME/wallet/cert.txt
```

B.1.6 Oracle Database Wallet Search Order

The search order that Oracle Database uses to find wallets depends on the feature for which the wallet was created, such as Transparent Data Encryption (TDE).

The Oracle Database listener uses the following search path for the wallet, in this order:

1. `WALLET_LOCATION` parameter setting in connect string
2. `WALLET_LOCATION` parameter setting in the `sqlnet.ora` file
3. Wallet in the `$TNS_ADMIN` environment variable setting

The default wallet locations are as follows:

- Linux: `/etc/ORACLE/WALLETS/user_name`
- Windows: `C:\Users\user_name\ORACLE\WALLETS`

See the following topics for information about various search orders for wallets:

- Centrally managed users (CMU) with Microsoft Active Directory: [About Using a dsi.ora File](#)
- Secure external password (SEP) wallets: TBA
- Transport Layer Security (TLS) server wallets: [Oracle Wallet Search Order](#)
- Transparent Data Encryption keystores: *Oracle Database Advanced Security Guide*
- Enterprise User Security wallets: *Oracle Database Enterprise User Security Administrator's Guide* (Note that Enterprise User Security is deprecated starting with Oracle Database 23ai.)

B.2 Managing Oracle Database Wallets and Certificates with the orapki Utility

The `orapki` command-line utility is installed by default with the Oracle Database server.

- [About Managing Oracle Database Wallets and Certificates with the orapki Utility](#)
The `orapki` command-line utility enables you to create and manage wallets and certificates from the command line.
- [orapki Utility Syntax](#)
The `orapki` utility syntax provides ways to create and manage wallets and certificates.

B.2.1 About Managing Oracle Database Wallets and Certificates with the orapki Utility

The `orapki` command-line utility enables you to create and manage wallets and certificates from the command line.

You can use `orapki` to perform the following tasks:

- Creating and viewing signed certificates for testing purposes
- Managing Oracle wallets (except for Transparent Data Encryption keystores):
 - Creating and displaying Oracle wallets
 - Adding and removing certificate requests
 - Adding and removing user certificates
 - Adding and removing trusted certificates
 - Importing and exporting the private key
 - Importing a PKCS12 file
 - Converting a JKS keystore to a PKCS12 file or vice versa
 - Exporting the certificates and certificate chain
- Managing certificate revocation lists (CRLs):
 - Renaming CRLs with a hash value for certificate validation
 - Uploading, listing, viewing, and deleting CRLs in Oracle Internet Directory

`orapki` enables you to automate these tasks by using scripts. Providing a way to incorporate the management of wallets, certificates, and certificate revocation lists (CRLs) into scripts makes it possible to automate many of the routine tasks of maintaining them.

You can use the `orapki utility wallet` module commands in scripts to automate the wallet creation process. For example, you can create password-protected wallets, auto-login wallets, auto-login-only wallets, or local auto-login wallets. You can create local auto-login wallets that are associated with PKCS#12 wallets that are local to the computer on which they were created and the user who created them. You can view wallets, import wallets, modify wallet passwords, and convert wallets to use the AES256 algorithm.

When you create a new wallet (any type), Oracle creates it as a version 6 wallet. If you modify an existing LSSO version 6 wallet, then `orapki` converts it to version 7. Starting in Oracle Database 23ai, version 6 of the local auto-login wallet is deprecated. You can check the version of the wallet by running the `orapki wallet display` command with the `ssvs` parameter, which displays the version of the wallet.

**Note:**

The `-wallet` parameter is mandatory for all `wallet` module commands.

Related Topics

- [orapki wallet display](#)
The `orapki wallet display` command displays the certificate requests, user certificates, and trusted certificates in an Oracle wallet.

B.2.2 orapki Utility Syntax

The `orapki utility` syntax provides ways to create and manage wallets and certificates.

The syntax of the `orapki` command-line utility is as follows:

```
orapki module command -parameter value
```

In this specification, *module* can be `wallet` (Oracle wallet), `crl` (certificate revocation list), `cert` (PKI digital certificate), or `secretstore` (secrets and credentials). The available commands depend on the *module* you are using.

For example, if you are working with a `wallet`, then you can add a certificate or a key to the wallet with the `add` command. The following example adds the user certificate located at `/private/lhale/cert.txt` to the wallet located at `$ORACLE_HOME/admin/db_unique_name/wallet/ewallet.p12`:

```
orapki wallet add -wallet $ORACLE_HOME/admin/db_unique_name/wallet/ewallet.p12 -  
user_cert -cert /private/lhale/cert.txt
```

B.3 Managing Oracle Database Wallets

The `orapki` command-line utility enables you to create and manage wallets before you add certificates to them.

- [Creating a PKCS#12 Wallet](#)
You can use the `orapki` utility to create a PKCS#12 Oracle wallet.
- [Importing a PKCS#12 Wallet](#)
You can use the `orapki` utility to import a PKCS#12 file into an existing wallet.

- [Creating an Auto-Login-Only Wallet](#)
You can use the `orapki` utility to create an auto-login only wallet.
- [Creating a Local Auto-Login Wallet](#)
The `orapki` utility can create a local auto-login wallet.
- [Creating an Auto-Login Wallet That Is Associated with a PKCS#12 Wallet](#)
You can create an auto-login wallet that is associated with a PKCS#12 wallet.
- [Viewing a Wallet](#)
You can use the `orapki` utility to view a wallet.
- [Modifying the Password for a Wallet](#)
You can use the `orapki` utility to modify the password of a wallet.
- [Converting an Oracle Wallet to Use the AES256 Algorithm](#)
By default, an Oracle wallet that was created with the `ADMINISTER KEY MANAGEMENT` or `ALTER SYSTEM` statement is encrypted with AES256.
- [Deleting a Wallet](#)
You can delete wallets, but be cautious when doing so. Deleting a wallet that is in use can problems with the Oracle Database environment.

B.3.1 Creating a PKCS#12 Wallet

You can use the `orapki` utility to create a PKCS#12 Oracle wallet.

- To create an Oracle PKCS#12 wallet (`ewallet.p12`), use the `orapki wallet create` command.

```
orapki wallet create -wallet wallet_file_directory [-pwd password]
```

In this specification:

- `wallet` specifies the location in which to create the `ewallet.p12` wallet file.
- `pwd` is a new password to be assigned to the wallet. If you create an auto-login wallet later on, then it will require this password. If you do not provide a password using the `pwd` parameter, then you are prompted to enter and reenter the new password. For better security, enter the password at the prompt instead of entering it at the command line. When you create the password, follow these requirements:
 - Use no fewer than 8 characters. The maximum length is unlimited.
 - Use mixed alphanumeric characters.

B.3.2 Importing a PKCS#12 Wallet

You can use the `orapki` utility to import a PKCS#12 file into an existing wallet.

- To import an Oracle PKCS#12 wallet (`ewallet.p12`), use the `orapki wallet import_pkcs12` command.

```
orapki wallet import_pkcs12 -wallet wallet_file_directory [[-pwd password] | [-  
auto_login_only]]  
[-pkcs12file pkcs12_location] [-pkcs12pwd pkcs12_password]
```

In this specification:

- `pkcs12file` refers to the Oracle PKCS#12 wallet that to import into the `wallet_file_directory` location.
- `pkcs12Pwd` is the password of that wallet file.

B.3.3 Creating an Auto-Login-Only Wallet

You can use the `orapki` utility to create an auto-login only wallet.

- To create an auto-login only wallet (`cwallet.sso`), which does not need a password to open the wallet, use the `orapki wallet create` command.

```
orapki wallet create -wallet wallet_file_directory -auto_login_only
```

Note the following:

- You can modify or delete the auto-login-only wallet without using a password. File system permissions provide the necessary security for such auto-login-only wallets.
- This command creates a `cwallet.sso` file.

B.3.4 Creating a Local Auto-Login Wallet

The `orapki` utility can create a local auto-login wallet.

Starting in Oracle Database 23ai, version 6 of the local auto-login wallet is deprecated, to be replaced with version 7.

- To create a local auto-login wallet that is local to both the computer on which it is created and the user who created it, use the `orapki wallet create` command.

```
orapki wallet create -wallet wallet_file_directory -auto_login_local [-pwd  
wallet_password]
```

In this specification, `pwd` is the password that was created when the PKCS#12 wallet was created. If no password is provided, then you are prompted to enter and reenter the new password. For better security, enter the password at the prompt instead of entering it at the command line.

This command does the following:

- Creates an auto-login wallet (`cwallet.sso`) file in the `wallet_file_directory`.
- Associates the auto-login wallet with a PKCS#12 wallet (`ewallet.p12`). If the `ewallet.p12` file does not exist, this command creates it.
- You cannot move local auto-login wallets to another computer. They must be used on the host on which they are created.
- Even though a local auto-login wallet does not need a password to open, you must supply the password for the associated PKCS#12 wallet in order to modify or delete the wallet. Any update to the PKCS#12 wallet also updates the associated auto-login wallet.

B.3.5 Creating an Auto-Login Wallet That Is Associated with a PKCS#12 Wallet

You can create an auto-login wallet that is associated with a PKCS#12 wallet.

- To create an auto-login wallet (`cwallet.sso`) that is associated with a PKCS#12 wallet (`ewallet.p12`), use the `orapki wallet create` command.

```
orapki wallet create -wallet wallet_file_directory -auto_login [-pwd wallet_password]
```

In this specification,

- If the `wallet_file_directory` already contains a PKCS#12 wallet, then auto-login is enabled for it. You must supply the password for the existing PKCS#12 wallet in order to enable auto-login for it. If the `wallet_file_directory` does not contain a PKCS#12 wallet, then a new PKCS#12 wallet is created. You must create a password for the new PKCS#12 wallet. Follow these password creation requirements:
 - * Use no fewer than 8 characters. The maximum length is unlimited.
 - * Use mixed alphanumeric characters.
- `pwd` is the PKCS#12 wallet password. If no password is provided, then a password prompt appears. For better security, enter the password at the prompt instead of entering it at the command line.

Note that the auto-login wallet does not need a password to open; it automatically uses the password of its associated PKCS#12 wallet. Therefore, you must supply the password for the associated PKCS#12 wallet to modify or delete the auto-login wallet. Any update to the PKCS#12 wallet also updates the associated auto-login wallet.

B.3.6 Viewing a Wallet

You can use the `orapki` utility to view a wallet.

This command displays the certificate requests, user certificates, trusted certificates, secret store entries, and credentials that are contained in the wallet.

- To view an Oracle wallet, use the `orapki wallet display` command.

```
orapki wallet display -wallet wallet_file_directory
```

Output similar to the following appears:

```
Requested Certificates:  
User Certificates:  
Trusted Certificates:
```

B.3.7 Modifying the Password for a Wallet

You can use the `orapki` utility to modify the password of a wallet.

When you change the password of an auto-login wallet, and if that wallet is version 6, then Oracle Database automatically updates the wallet to version 7.

1. Use the `orapki wallet change_pwd` command to change the password.

```
orapki wallet change_pwd -wallet wallet_file_directory [-oldpwd wallet_password ] [-  
newpwd wallet_password]
```

This command changes the current wallet password to the new password. The command prompts you for the old and new passwords if no password is supplied at the command line. Change the password using the following requirements:

- Use no fewer than 8 characters. The maximum length is unlimited.
 - Use mixed alphanumeric characters.
2. If this wallet uses an auto-login only wallet, then regenerate the auto-login only wallet.

```
orapki wallet create -wallet wallet_file_directory -auto_login_only
```

B.3.8 Converting an Oracle Wallet to Use the AES256 Algorithm

By default, an Oracle wallet that was created with the `ADMINISTER KEY MANAGEMENT` or `ALTER SYSTEM` statement is encrypted with AES256.

If you are using an older wallet that is encrypted with 3DES instead of AES256, then you can use the `orapki convert` command to convert the wallet to use the AES256 algorithm, which is stronger than 3DES. Oracle wallets that are created with `orapki` are created with the AES256 algorithm by default.

Be aware that though the AES256 algorithm is stronger than 3DES, there will be some degradation in `orapki` operations if you use AES256.

- To change the wallet algorithm from 3DES to AES256, use the `orapki wallet convert` command.

```
orapki wallet convert -wallet wallet_file_directory [-pwd wallet_password] -  
compat_v12
```

In this specification:

- `pwd` is the wallet password. If no password is provided, then a password prompt appears. For better security, enter the password at the prompt instead of entering it at the command line.
- `compat_v12` performs the conversion from 3DES to AES256.

You can check if the wallet has been converted from 3DES to AES356 by running the `openssl pkcs12` command. For example:

```
openssl pkcs12 -in sample/ewallet.p12 -info  
Enter Import Password: password
```

Output similar to the following appears. The `AES-256-CBC` value in the last line confirms that the wallet is encrypted with AES256.

```
MAC: sha1, Iteration 10000  
MAC length: 20, salt length: 8  
PKCS7 Encrypted data: PBES2, PBKDF2, AES-256-CBC, Iteration 10000, PRF  
hmacWithSHA256
```

B.3.9 Deleting a Wallet

You can delete wallets, but be cautious when doing so. Deleting a wallet that is in use can problems with the Oracle Database environment.

1. Check the wallet contents to ensure that it is safe to delete it.

It is important to check a wallet's contents because some wallets may have additional information that you were not aware of that is being used by the database. Use the following `orapki` command to check the contents of the wallet:

```
orapki wallet display -wallet wallet_file_directory
```

2. Back up the wallet in case you may need it again.

You should be able to easily recreate the wallet if it is needed again.

3. Delete the wallet.

The following example deletes a password-protected wallet:

```
orapki wallet delete -wallet $ORACLE_HOME/admin/db_unique_name/wallet
Enter password: wallet_password
```

To delete an auto-login wallet, include the `-sso` parameter:

```
orapki wallet delete -wallet $ORACLE_HOME/admin/db_unique_name/wallet -sso
Enter password: wallet_password
```

If you want to delete Transparent Data Encryption keystores, then see *Oracle Database Advanced Security Guide* for information about the dangers of deleting keystores.

B.4 Managing Oracle Database Certificates

After you create a wallet, you can associate certificates with it to validate the identities of entities that are associated with the wallet.

- [Certificate Store Location for System Wallets](#)
System wallets are located in the certificate store location.
- [Adding a Certificate Request to an Oracle Wallet](#)
You can use the `orapki` utility to add certificate requests to Oracle wallets.
- [Creating Signed Certificates](#)
The `orapki` utility provides a way to sign user certificate requests by an intermediate or root key.
- [Creating a Signed Certificate Using a Self-Signed Root](#)
This certificates creation method involves the use of an Oracle wallet with self signed certificate.
- [Adding a Trusted Certificate to an Oracle Wallet](#)
You can use the `orapki` utility to add trusted certificates to an Oracle wallet.
- [Adding a Root Certificate to an Oracle Wallet](#)
You can use the `orapki` utility to add a root certificate to an Oracle wallet.
- [Adding Root Certificate Authority That Requires an Intermediate Certificate Using Microsoft Internet Explorer](#)
This procedure explains how to install a new or replacement root certificate authority (CA) by downloading it from Microsoft Explorer versions 5, 6, or 7.
- [Adding a User Certificate to an Oracle Wallet](#)
You can use the `orapki` utility to add a user certificate to an Oracle wallet.
- [Verifying Credentials on the Hardware Device That Uses a PKCS#11 Wallet](#)
You can verify credentials on the hardware device using the PKCS#11 wallet.
- [Adding PKCS#11 Information to an Oracle Wallet](#)
A wallet that contains PKCS#11 information can be used like any Oracle wallet.
- [Viewing a Certificate](#)
After you create a certificate, you can use the `orapki` utility to view it.
- [Controlling MD5 and SHA-1 Certificate Use](#)
You can use the `sqlnet.ora` file to control whether MD5 and SHA-1 signed certificates are accepted.

- [Certificate Import and Export Operations](#)
You can use `orapki` to import and export certificates.
- [Management of Certificate Revocation Lists \(CRLs\) with orapki Utility](#)
You must manage certificate revocation lists (CRLs) with the `orapki` utility.

B.4.1 Certificate Store Location for System Wallets

System wallets are located in the certificate store location.

The default certificate store location depends on the platform. For Microsoft Windows, it is in the Microsoft Certificate Store for Microsoft Windows. For Linux, its locations are as follows:

- `/etc/pki/tls/cert.pem`
- `/etc/ssl/certs/ca-certificates.crt`
- `/etc/pki/tls/certs/ca-bundle.crt`
- `/etc/ssl/ca-bundle.pem`
- `/etc/pki/tls/cacert.pem`
- `/etc/pki/ca-trust/extracted/pem/tls-ca-bundle.pem`
- `/etc/ssl/cert.pem`

If the certificate authority (CA) is not in any of these locations, then you can create a symlink `/etc/pki/tls/cert.pem` pointing to the CA certificate file. Only PEM-formatted certificates are supported in all of the system certificate store locations.

B.4.2 Adding a Certificate Request to an Oracle Wallet

You can use the `orapki` utility to add certificate requests to Oracle wallets.

- To add a certificate request to an Oracle wallet, use the `orapki wallet add` command.

```
orapki wallet add -wallet wallet_file_directory -dn user_dn -keySize 512|768|1024|
2048|4096|8192|16384
```

In this specification:

Table B-1 Parameter Descriptions of `orapki wallet add`

Parameter	Description
wallet	Specifies the location of the wallet to which you want to add a certificate request.
dn	Specifies the distinguished name of the certificate to add.

Table B-1 (Cont.) Parameter Descriptions of `orapki wallet add`

Parameter	Description
<code>keySize</code>	<p>Specifies the key size in bits for the certificate. The size that you enter indicates the strength of security for the certificate. Values are as follows:</p> <ul style="list-style-type: none"> – 512: Included for backward compatibility and is supported in non-FIPS mode – 768: Supported in non-FIPS mode – 1024: Current default for non-FIPS certificate keys and is supported in non-FIPS mode – 2048: Current default for FIPS certificate keys – 4096: As needed per your site's requirements – 8192: As needed per your site's requirements – 16384: As needed per your site's requirements

To sign the request, export it with the `orapki wallet export` command.

Related Topics

- [Exporting Certificates and Certificate Requests from an Oracle Wallet](#)
You can use the `orapki` utility to export certificates and certificate requests from an Oracle wallet.

B.4.3 Creating Signed Certificates

The `orapki` utility provides a way to sign user certificate requests by an intermediate or root key.

In most cases, this command is used to create a signed certificate for testing purposes, but it can be used for other reasons as well. It creates a signed certificate from the certificate request. A self-signed certificate is not issued or signed by a Certificate Authority (CA).

- To create a signed certificate, use the `orapki cert create` command.

```
orapki cert create [-wallet wallet_file_directory] -request
certificate_request_location -cert certificate_file_directory -validity
number_of_days [-pwd wallet_password]
```

In this specification:

- `wallet` specifies the wallet containing the user certificate and private key that will be used to sign the certificate request.
- `validity` specifies the number of days, starting from the current date, that this certificate will be valid. Specifying a certificate and certificate request is mandatory for this command.
- `pwd` is the wallet password. If you omit this parameter, then you are prompted for the password. For better security, enter the password at this prompt.

B.4.4 Creating a Signed Certificate Using a Self-Signed Root

This certificates creation method involves the use of an Oracle wallet with self signed certificate.

Using a certificate signed by a public Certificate Authority (CA) simplifies TLS connections because the root trust certificate for the database server is most likely already available in the default trust store on clients.

1. Create a wallet and add a self-signed root certificate to this wallet.

- a. Create the wallet as follows:

Create the wallet in its own directory (for example, `wallet1`) under the wallet directory structure

```
orapki wallet create -wallet wallet_file_directory/wallet1 -pwd
wallet_password -auto_login
```

The default algorithm is AES256.

- b. Add a self-signed certificate to this wallet.

For example:

```
orapki wallet add -wallet wallet_file_directory/wallet1
-dn 'CN=sales.us.example.com, O=Oracle, L=Reading, ST=Texas,
C=US' -self_signed -validity 3650 -keysize 2048 -sign_alg sha256
-pwd wallet_password
```

2. Create a second wallet in its own directory (for example, `wallet2`) for the certificate.

```
orapki wallet create -wallet wallet_file_directory/wallet2 -pwd
wallet_password
-auto_login
```

3. Add a certificate request to this second wallet and export it into a file.

```
orapki wallet add -wallet wallet_file_directory/wallet2
-dn 'CN=server_test,C=US' -keysize 2048 -pwd wallet_password

orapki wallet export -wallet wallet_file_directory/wallet2
-dn 'CN=server_test,C=US' -request creq.txt -pwd wallet_password
```

4. Use the first wallet with a self-signed root key to sign the certificate request `creq.txt`.

The option `-sign_alg sha256` setting to specifies the SHA-2 algorithm. The file `usercert.txt` file will contain the SHA-2 certificate.

```
orapki cert create -wallet wallet_file_directory/wallet1
-request wallet_file_directory/wallet2/creq.txt -cert
wallet_file_directory/wallet2/usercert.txt
-sign_alg sha256 -validity 3650
```

5. Verify that the user certificate has been created with SHA-2 algorithm.

```
openssl x509 -in wallet_file_directory/wallet2/usercert.txt -text
```

Output similar to the following appears:

```
Certificate:
Data:
Version: 1 (0x0)
Serial Number: 0 (0x0)
Signature Algorithm: sha256WithRSAEncryption
Issuer: C=US, ST=Texas, L=Reading, O=Oracle,
sales.us.example.com
Validity
Not Before: Aug 5 06:50:44 2023 GMT
Not After : Aug 2 06:50:44 2027 GMT
Subject: C=US, CN=server_test
Subject Public Key Info:
Public Key Algorithm: rsaEncryption
RSA Public Key: (2048 bit)
Modulus (2048 bit):
00:b0:36:ba:33:86:9f:f2:03:c0:13:b5:a2:99:09:
...

oU6jgrYfZkxcMMZMhnWKCpNBdA==
-----END CERTIFICATE-----
```

6. Export the self-signed certificate from the first wallet and import it as a trusted certificate into the second wallet.

To add the signed certificate into the original (second wallet), first you must import the root trust certificate and any intermediate trust certificates in hierarchical order before you can add the newly signed user certificate. This example uses the root private key to sign the user certificate, so you just need to export the self-signed root certificate from the first wallet and then import it as a trusted certificate into the second wallet.

```
orapki wallet export -wallet wallet_file_directory/wallet1
-dn 'CN=sales.us.example.com, O=Oracle, L=Reading, ST=Texas, C=US'
-cert self_cert.crt

orapki wallet add -wallet wallet_file_directory/wallet2 -trusted_cert -
cert
/wallet_file_directory/wallet1/self_cert.crt -pwd wallet_password
```

7. Import the certificate file usercert.txt into the second wallet.

```
orapki wallet add -wallet wallet_file_directory/wallet2 -user_cert
-cert wallet_file_directory/wallet2/usercert.txt
-sign_alg sha256 -pwd wallet_password
```

8. In the domain for the wallet and certificate, display the wallet to confirm.

```
[sales]wallet_file_directory/wallet2> orapki
wallet display -wallet .
```

Output similar to the following should appear:

```
Requested Certificates:
User Certificates:
Subject: CN=server_test,C=US
Trusted Certificates:
Subject: O=Oracle\, Inc.,C=US,
Inc.,C=US
Subject: CN=GTE CyberTrust Global Root,
Inc.,O=GTE Corporation,C=US
```

B.4.5 Adding a Trusted Certificate to an Oracle Wallet

You can use the `orapki` utility to add trusted certificates to an Oracle wallet.

This command adds a trusted certificate to the specified location (`-cert certificate_file_directory`), to a wallet. You must add all trusted certificates in the certificate chain of a user certificate before adding a user certificate, or the command to add the user certificate will fail.

- To add a trusted certificate to an Oracle wallet, use the `orapki wallet add` command.

```
orapki wallet add -wallet wallet_file_directory -trusted_cert -cert certificate_file
[-pwd wallet_password]
```

If you omit the `-pwd` parameter, then you are prompted to enter the wallet password. For better security, enter the password at this prompt.

B.4.6 Adding a Root Certificate to an Oracle Wallet

You can use the `orapki` utility to add a root certificate to an Oracle wallet.

This command creates a new self-signed (root) certificate and adds it to the wallet.

- To add a root certificate to an Oracle wallet, use the `orapki wallet add` command.

```
orapki wallet add -wallet wallet_file_directory -dn certificate_dn -keySize 512|768|
1024|2048|4096|8192|16384 -self_signed -validity number_of_days
[-pwd wallet_password]
```

In this specification:

- `validity` specifies the number of days, starting from the current date, that this certificate will be valid. This parameter is mandatory.
- `keySize` specifies the key size in bits of the requested certificate. The size that you enter indicates the strength of security for the certificate. Values are as follows:
 - * 512: Included for backward compatibility and is supported in non-FIPS mode
 - * 768: Supported in non-FIPS mode
 - * 1024: Current default for non-FIPS certificate keys and is supported in non-FIPS mode
 - * 2048: Current default for FIPS certificate keys
 - * 4096: As needed per your site's requirements
 - * 8192: As needed per your site's requirements

- * 16384: As needed per your site's requirements
- `pwd` is the wallet password. If you omit this parameter, then you are prompted for the password. For better security, enter the password at this prompt.

B.4.7 Adding Root Certificate Authority That Requires an Intermediate Certificate Using Microsoft Internet Explorer

This procedure explains how to install a new or replacement root certificate authority (CA) by downloading it from Microsoft Explorer versions 5, 6, or 7.

1. In Internet Explorer, select **Tools**, then **Internet Options**, then **Content**, then **Certificates**.
2. Select the **Trusted Root Certification Authorities** tab.
3. Select **Issued to: ...**.
4. Click **Export**.
5. In the wizard that opens, select **Next**, then **Select Base-64 encoded X.509 (.CER)**.
6. Enter a file name and select **Finish**.

B.4.8 Adding a User Certificate to an Oracle Wallet

You can use the `orapki` utility to add a user certificate to an Oracle wallet.

1. Ensure that you have added to the wallet all the trust certificates that make up the certificate chain.

If all trusted certificates are not installed in the wallet before you add the user certificate, then adding the user certificate will fail.

2. Use the `orapki wallet add` command to add the user certificate to the wallet.

```
orapki wallet add -wallet wallet_file_directory -user_cert -cert
certificate_file_directory [-pwd wallet_password]
```

If you omit the `-pwd` parameter, then you are prompted to enter the wallet password. For better security, enter the password at this prompt.

B.4.9 Verifying Credentials on the Hardware Device That Uses a PKCS#11 Wallet

You can verify credentials on the hardware device using the PKCS#11 wallet.

- To verify the credential details, use the `orapki wallet p11_verify` command.

```
orapki wallet p11_verify -wallet wallet_file_directory [-pwd wallet_password]
```

`pwd` is the wallet password. If no password is provided, then a password prompt appears. For better security, enter the password at the prompt instead of entering it at the command line

B.4.10 Adding PKCS#11 Information to an Oracle Wallet

A wallet that contains PKCS#11 information can be used like any Oracle wallet.

The private keys for this type of wallet are stored on a hardware device. Hardware devices maintain the private key and perform cryptographic operations using the private key. Therefore, the private key is never needed outside of the hardware device boundary.

- To add PKCS#11 information to a wallet, use the `orapki wallet p11_add` command.

```
orapki wallet p11_add -wallet wallet_file_directory -p11_lib pkcs11Lib
[-p11_tokenlabel tokenLabel] [-p11_tokenpw tokenPassphrase]
[-p11_certlabel certLabel] [-pwd wallet_password]
```

In this specification:

- `p11_lib` specifies the path to the PKCS#11 library. This includes the library file name.
- `p11_tokenlabel` specifies the token or smart card used on the device. Use this when there are multiple tokens on the device. Token labels are set using vendor tools.
- `p11_tokenpw` specifies the password that is used to access the token. Token passwords are set using vendor tools.
- `p11_certlabel` is used to specify a certificate label on the token. Use this when a token contains multiple certificates. Certificate labels are set using vendor tools.
- `pwd` is the wallet password. If no password is provided, then a password prompt appears. For better security, enter the password at the prompt instead of entering it at the command line.

B.4.11 Viewing a Certificate

After you create a certificate, you can use the `orapki` utility to view it.

- To view a certificate, use the `orapki cert display` command.

```
orapki cert display -cert certificate_file_directory [-complete]
```

In this specification:

- `summary` displays the certificate and its expiration date.
- `complete` displays additional certificate information, including the serial number and public key.

B.4.12 Controlling MD5 and SHA-1 Certificate Use

You can use the `sqlnet.ora` file to control whether MD5 and SHA-1 signed certificates are accepted.

To control whether the MD5 and SHA-1 signed certificates are accepted, you can edit the `sqlnet.ora` file to enable or disable their use.



Note:

MD5 is deprecated in this release.

1. Log in to the server where the Oracle database resides.
2. Edit the `sqlnet.ora` file.
By default, the `sqlnet.ora` file is located in the `$ORACLE_HOME/dbs` directory or in the location set by the `TNS_ADMIN` environment variable.
3. Set the following parameters:
 - `ACCEPT_MD5_CERTS` controls the use of MD5 certificates. The default is `FALSE`. This parameter replaces the `ORACLE_SSL_ALLOW_MD5_CERT_SIGNATURES` environment variable.
 - `ACCEPT_SHA1_CERTS` controls the use of SHA-1 certificates. The default is `TRUE`.

B.4.13 Certificate Import and Export Operations

You can use `orapki` to import and export certificates.

- [Importing a User-Supplied or Trusted Certificate into an Oracle Wallet](#)
You can add a user-supplied or trusted certificate to an Oracle wallet.
- [Exporting Certificates and Certificate Requests from an Oracle Wallet](#)
You can use the `orapki` utility to export certificates and certificate requests from an Oracle wallet.

B.4.13.1 Importing a User-Supplied or Trusted Certificate into an Oracle Wallet

You can add a user-supplied or trusted certificate to an Oracle wallet.

- Use the `orapki wallet add -wallet` command as follows:
 - To add a trusted certificate to an Oracle wallet, use the `-trusted_cert` parameter.

```
orapki wallet add -wallet wallet_file_directory [-pwd wallet_password] -trusted_cert -cert root_and/or_intermediate_certificate_file
```
 - To add a user-created certificate to an Oracle wallet, use the `-user_cert` parameter.

```
orapki wallet add -wallet wallet_file_directory [-pwd wallet_password] -user_cert -cert user_certificate_file
```

In this specification, `pwd` is the wallet password. If no password is provided, then a password prompt appears. For better security, enter the password at the prompt instead of entering it at the command line.

B.4.13.2 Exporting Certificates and Certificate Requests from an Oracle Wallet

You can use the `orapki` utility to export certificates and certificate requests from an Oracle wallet.

- Depending on the type of certificate that you want to export from a wallet, use the `orapki wallet export` command.
 - To export a certificate with the subject's distinguished name (`-dn`) to a file that is specified by the `-cert` parameter:

```
orapki wallet export -wallet wallet_file_directory -dn certificate_dn -cert certificate_filename
```

`dn` specifies the distinguished name of the certificate. In the case of a multi-valued DN, the order in which the individual DN values are stored in the wallet is uncertain. To find the correct DN that you want, run `orapki wallet display`.

- To export a certificate with an alias:

```
orapki wallet export -wallet wallet_file_directory -alias alias_name -cert
certificate_filename
```

- To export a certificate request with the subject's distinguished name (`-dn`) to a file that is specified by the `-request` parameter:

```
orapki wallet export -wallet wallet_file_directory -dn certificate_request_dn -
request certificate_request_filename
```

- To export private keys, use the following syntax:

```
orapki export_private_key -wallet wallet_file_directory -pvtkeyfile pvt_key_file
-alias pvt_key_alias -pvtkeypwd pvt_key_password
```

Related Topics

- [orapki wallet display](#)
The `orapki wallet display` command displays the certificate requests, user certificates, and trusted certificates in an Oracle wallet.

B.4.14 Management of Certificate Revocation Lists (CRLs) with orapki Utility

You must manage certificate revocation lists (CRLs) with the `orapki` utility.

This utility creates a hashed value of the CRL issuer's name to identify the CRLs location in your system. If you do not use `orapki`, your Oracle server cannot locate CRLs to validate PKI digital certificates.

Related Topics

- [Certificate Revocation List Management](#)
Certificate revocation list management entails ensuring that the CRLs are the correct format before you enable certificate revocation checking.

B.5 Examples of Creating Wallets and Certificates Using orapki

Examples of `orapki` commands include creating wallets, user certificates, and wallets with self-signed certificates, and exporting certificates.

- [Example: Wallet with a Self-Signed Certificate and Export of the Certificate](#)
The `orapki wallet add` command can create a wallet with a self-signed certificate; the `orapki wallet export` can export the certificate.
- [Example: Creating a Wallet and a User Certificate](#)
The `orapki` utility can create wallets and user certificates.

B.5.1 Example: Wallet with a Self-Signed Certificate and Export of the Certificate

The `orapki wallet add` command can create a wallet with a self-signed certificate; the `orapki wallet export` can export the certificate.

The following example illustrates the steps to create a wallet with a self-signed certificate, view the wallet, and then export the certificate to a file.

Example B-1 Creating a Wallet with a Self-Signed Certificate and Exporting the Certificate

1. Create a wallet.

For example:

```
orapki wallet create -wallet /private/user/orapki_use/root
Enter password: new_password
Enter password again: new_password
```

The wallet is created at the location, `/private/user/orapki_use/root`.

2. Add a self-signed certificate to the wallet.

```
orapki wallet add -wallet /private/user/orapki_use/root -dn
'CN=root_test,C=US' -keysize 2048 -self_signed -validity 3650
```

This creates a self-signed certificate with a validity of 3650 days. The distinguished name of the subject is `CN=root_test,C=US`. The key size for the certificate is 2048 bits.

3. View the wallet to check that the certificate is contained in the wallet.

```
orapki wallet display -wallet /private/user/orapki_use/root
```

4. Export the certificate.

```
orapki wallet export -wallet /private/user/orapki_use/root -dn
'CN=root_test,C=US' -cert /private/user/orapki_use/root/b64certificate.txt
```

This exports the self-signed certificate to the file, `b64certificate.txt`. Note that the distinguished name used is the same as in step 2.

B.5.2 Example: Creating a Wallet and a User Certificate

The `orapki` utility can create wallets and user certificates.

The following steps illustrate creating a wallet, creating a certificate request, exporting the certificate request, creating a signed certificate from the request for testing, viewing the certificate, adding a trusted certificate to the wallet and adding a user certificate to the wallet.

Example B-2 Creating a Wallet and a User Certificate

1. Create a wallet with auto-login enabled.

For example:

```
orapki wallet create -wallet /private/user/orapki_use/server -auto_login
Enter wallet password: password
```

2. Add a certificate request to the wallet.

```
orapki wallet add -wallet /private/user/orapki_use/server/ewallet.p12 -dn  
'CN=server_test,C=US' -keysize 2048
```

This command adds a certificate request to the wallet that was created (ewallet.p12). The distinguished name of the subject is CN=server_test,C=US. The key size specified is 2048 bits, which sets it to a secure level.

3. Export the certificate request to a file.

```
orapki wallet export -wallet /private/user/orapki_use/server -dn  
'CN=server_test,C=US' -request /private/user/orapki_use/server/creq.txt
```

This command exports the certificate request to the specified file, which is creq.txt in this case.

4. Create a signed certificate from the request for test purposes.

```
orapki cert create -wallet /private/user/orapki_use/root -request /private/user/  
orapki_use/server/creq.txt -cert /private/user/orapki_use/server/cert.txt -validity  
3650
```

This command creates a certificate, cert.txt with a validity of 3650 days. The certificate is created from the certificate request generated in the preceding step.

5. View the certificate.

```
orapki cert display -cert /private/user/orapki_use/server/cert.txt -complete
```

This command displays the certificate generated in the preceding step. The -complete option enables you to display additional certificate information, including the serial number and public key.

6. Add a trusted certificate to the wallet.

```
orapki wallet add -wallet /private/user/orapki_use/server/ewallet.p12 -trusted_cert -  
cert /private/user/orapki_use/root/b64certificate.txt
```

This command adds a trusted certificate, b64certificate.txt to the ewallet.p12 wallet. You must add all trusted certificates in the certificate chain of a user certificate before adding a user certificate.

7. Add a user certificate to the wallet.

```
orapki wallet add -wallet /private/user/orapki_use/server/ewallet.p12 -user_cert -  
cert /private/user/orapki_use/server/cert.txt
```

This command adds the user certificate, cert.txt to the ewallet.p12 wallet.

B.6 orapki Utility Commands Summary

The orapki commands perform a variety of wallet, certificate revocation lists (CRL), and certificate management tasks.

- [orapki cert create](#)
The orapki cert create command creates a signed certificate for testing purposes.
- [orapki cert display](#)
The orapki cert display command displays details of a specified certificate.
- [orapki crl delete](#)
The orapki crl delete command deletes a certificate revocation list (CRL) that is stored in Oracle Internet Directory.

- [orapki crl display](#)
The `orapki crl display` command displays a specified certificate revocation list (CRL) that is stored in Oracle Internet Directory.
- [orapki crl hash](#)
The `orapki crl hash` command generates a hash value of the certificate revocation list (CRL) issuer to identify the CRL file system location for certificate validation.
- [orapki crl list](#)
The `orapki crl list` command displays a list of certificate revocation lists (CRLs) that are stored in Oracle Internet Directory.
- [orapki crl upload](#)
The `orapki crl upload` command uploads a certificate revocation list (CRL) to the CRL subtree in Oracle Internet Directory.
- [orapki secretstore create_credential](#)
The `orapki secretstore create_credential` command creates database connection credentials in the wallet.
- [orapki secretstore create_entry](#)
The `orapki secretstore create_entry` command stores a secret entries against an alias in a wallet.
- [orapki secretstore create_user_credential](#)
The `orapki secretstore create_user_credential` command creates a credential object that is referenced by an alias that is constituted from a map and key name.
- [orapki secretstore delete_credential](#)
The `orapki secretstore delete_credential` command deletes database connection credentials from a wallet.
- [orapki secretstore delete_entry](#)
The `orapki secretstore delete_entry` command deletes the secret entries for an alias from a wallet.
- [orapki secretstore delete_user_credential](#)
The `orapki secretstore delete_user_credential` command deletes the credential object that is referenced by the alias that was constituted from the map and key name.
- [orapki secretstore list_credentials](#)
The `orapki secretstore list_credentials` command lists the contents of the external password store.
- [orapki secretstore list_entries](#)
The `orapki secretstore list_entries` command lists the identifiers in a wallet.
- [orapki secretstore list_entries_unsorted](#)
The `orapki secretstore list_entries_unsorted` command lists the identifiers in a wallet in unsorted order.
- [orapki secretstore modify_credential](#)
The `orapki secretstore modify_credential` command modifies database connection credentials in the wallet.
- [orapki secretstore modify_entry](#)
The `orapki secretstore modify_entry` command modifies the secret entry for an alias in a wallet.
- [orapki secretstore modify_user_credential](#)
The `orapki secretstore modify_user_credential` command modifies a credential object that is referenced by an alias that was constituted from a map and key name.

- [orapki secretstore view_entry](#)
 The `orapki secretstore view_entry` command lists the secret entries for an alias in a wallet.
- [orapki wallet add](#)
 The `orapki wallet add` command adds certificate requests and certificates to an Oracle wallet.
- [orapki wallet change_pwd](#)
 The `orapki wallet change_pwd` command changes the password for a wallet.
- [orapki wallet convert](#)
 The `orapki wallet convert` command converts the 3DES algorithm in an Oracle wallet to use the AES256 algorithm.
- [orapki wallet create](#)
 The `orapki wallet create` command creates an Oracle wallet or enables auto-login for an Oracle wallet.
- [orapki wallet delete](#)
 The `orapki wallet delete` command deletes an Oracle wallet.
- [orapki wallet display](#)
 The `orapki wallet display` command displays the certificate requests, user certificates, and trusted certificates in an Oracle wallet.
- [orapki wallet export](#)
 The `orapki wallet export` command exports certificate requests and certificates from an Oracle wallet.
- [orapki wallet export_private_key](#)
 The `orapki wallet export_private_key` command exports a private key from a wallet.
- [orapki wallet import_pkcs12](#)
 The `orapki wallet import_pkcs12` command imports a PKCS #12 file into the wallet. Only the latest valid certificate for each unique private key in a PKCS#12 file will be imported into an Oracle wallet. If a private key already exists in the wallet, its associated certificate chain will be skipped.
- [orapki wallet import_private_key](#)
 The `orapki wallet import_private_key` command imports a private key into a wallet.
- [orapki wallet jks_to_pkcs12](#)
 The `orapki wallet jks_to_pkcs12` command converts a Java keystore to PKCS #12 format for the storage of certificate information.
- [orapki wallet pkcs12_to_jks](#)
 The `orapki wallet pkcs12_to_jks` command converts a PKCS #12 keystore to a Java keystore for the storage of certificate information.
- [orapki wallet remove](#)
 The `orapki wallet remove` command removes certificates and certificate requests from the wallet.

B.6.1 orapki cert create

The `orapki cert create` command creates a signed certificate for testing purposes.

Syntax

```
orapki cert create [-wallet wallet_file_directory] -request certificate_request_location
-cert certificate_file_directory -validity number_of_days
```

- `wallet` specifies the location of the wallet that contains the user certificate and private key that will be used to sign the certificate request.
- `request` specifies the location of the certificate request for the certificate you are creating.
- `cert` specifies the directory location where the tool places the new signed certificate.
- `validity` specifies the number of days, starting from the current date, that this certificate will be valid.

Example

```
orapki cert create -wallet $ORACLE_HOME/admin/db_unique_name/wallet
-request $ORACLE_HOME/admin/db_unique_name/wallet/cert_reqs
-cert $ORACLE_HOME/admin/db_unique_name/wallet/certs
-validity 365 -summary
```

B.6.2 orapki cert display

The `orapki cert display` command displays details of a specified certificate.

Syntax

```
orapki cert display -cert certificate_file_directory [-complete]
```

- `cert` specifies the location of the certificate you want to display.
- `summary|complete` display the following information:
 - `summary` displays the certificate and its expiration date.
 - `complete` displays additional certificate information, including the serial number and public key.

Example

```
orapki cert display -wallet $ORACLE_HOME/admin/db_unique_name/wallet/certs
```

B.6.3 orapki crl delete

The `orapki crl delete` command deletes a certificate revocation list (CRL) that is stored in Oracle Internet Directory.

The user who deletes the CRLs from the directory by using `orapki` must be a member of the `CRLAdmins (cn=CRLAdmins,cn=groups,%s_OracleContextDN%)` directory group.

Syntax

```
orapki crl delete -issuer issuer_name -ldap hostname:ssl_port -user user_name [-wallet
wallet_file_directory] [-summary]
```

- `issuer` specifies the name of the certificate authority (CA) who issued the CRL.
- `ldap` specifies the host name and SSL port for the directory where the CRLs are to be deleted. Note that this must be a directory SSL port (uploaded to Oracle Internet Directory) with no authentication.

- `user` specifies the user name of the directory user who has permission to delete CRLs from the CRL subtree in the directory.
- `wallet` specifies the location of the wallet that contains the certificate of the certificate authority (CA) who issued the CRL. Using it causes the tool to verify the validity of the CRL against the CA's certificate prior to deleting it from the directory.
- `summary` displays the CRL LDAP entry that was deleted.

Example

```
orapki crl delete -issuer psmith
-ldap hr_db:4415
-user psmith
-wallet $ORACLE_HOME/admin/db_unique_name/wallet
-summary
```

Related Topics

- [Uploading CRLs to Oracle Internet Directory](#)
Publishing CRLs in the directory enables CRL validation throughout your enterprise, eliminating the need for individual applications to configure their own CRLs.

B.6.4 orapki crl display

The `orapki crl display` command displays a specified certificate revocation list (CRL) that is stored in Oracle Internet Directory.

Syntax

```
orapki crl display -crl crl_location [-wallet wallet_file_directory] [-summary|-complete]
```

- `crl` parameter specifies the location of the CRL in the directory. It is convenient to paste the CRL location from the list that displays when you use the `orapki crl list` command.
- `wallet` (optional) specifies the location of the wallet that contains the certificate of the certificate authority (CA) who issued the CRL. Using it causes the tool to verify the validity of the CRL against the CA's certificate prior to displaying it.
- `summary` and `complete` display the following information:
 - `summary` provides a listing that contains the CRL issuer's name and the validity period of the CRL.
 - `complete` provides a list of all revoked certificates that the CRL contains. The output for this option may take a long time to display, depending on the size of the CRL.

Example

```
orapki crl display -crl $ORACLE_HOME/admin/db_unique_name/wallet/crls
-wallet $ORACLE_HOME/admin/db_unique_name/wallet
-summary
```

Related Topics

- [orapki crl list](#)
The `orapki crl list` command displays a list of certificate revocation lists (CRLs) that are stored in Oracle Internet Directory.

B.6.5 orapki crl hash

The `orapki crl hash` command generates a hash value of the certificate revocation list (CRL) issuer to identify the CRL file system location for certificate validation.

Syntax

```
orapki crl hash -crl crl_filename|URL [-wallet wallet_file_directory] [-symlink|-copy]
crl_directory [-summary]
```

- `crl` specifies the file name that contains the CRL or the URL where it can be found.
- `wallet` (optional) specifies the location of the wallet that contains the certificate of the certificate authority (CA) who issued the CRL. Using it causes the tool to verify the validity of the CRL against the CA's certificate prior to uploading it to the directory.
- Depending on the operating system, use either the `-symlink` or the `-copy` parameter:
 - (UNIX) `symlink` creates a symbolic link to the CRL at the `crl_directory` location
 - (Windows) `copy` creates a copy of the CRL at the `crl_directory` location
- `summary` displays the CRL issuer's name.

Example

```
orapki crl hash -crl db_cert_rev
-wallet $ORACLE_HOME/admin/db_unique_name/wallet
-copy
-$ORACLE_HOME/admin/db_unique_name/wallet/crls
-summary
```

B.6.6 orapki crl list

The `orapki crl list` command displays a list of certificate revocation lists (CRLs) that are stored in Oracle Internet Directory.

Syntax

This command is useful for browsing to locate a particular CRL to view or download to your local file system.

```
orapki crl list -ldap hostname:ssl_port
```

`ldap` specifies the host name and SSL port for the directory server from where you want to list CRLs. Note that this must be a directory SSL port with no authentication.

Example

```
orapki crl list -ldap hr_db:4415
```

Related Topics

- [Uploading CRLs to Oracle Internet Directory](#)
Publishing CRLs in the directory enables CRL validation throughout your enterprise, eliminating the need for individual applications to configure their own CRLs.

B.6.7 orapki crl upload

The `orapki crl upload` command uploads a certificate revocation list (CRL) to the CRL subtree in Oracle Internet Directory.

Note that you must be a member of the directory administrative group `CRLAdmins` (`cn=CRLAdmins,cn=groups,%s_OracleContextDN%`) to upload CRLs to the directory.

Syntax

```
orapki crl upload -crl crl_location -ldap hostname:ssl_port -user username [-wallet wallet_file_directory] [-summary]
```

- `crl` specifies the directory location or the URL where the CRL is located that you are uploading to the directory.
- `ldap` specifies the host name and SSL port for the directory where you are uploading the CRLs. Note that this must be a directory SSL port with no authentication.
- `user` specifies the user name of the directory user who has permission to add CRLs to the CRL subtree in the directory.
- `wallet` specifies the location of the wallet that contains the certificate of the certificate authority (CA) who issued the CRL. This is an optional parameter. Using it causes the tool to verify the validity of the CRL against the CA's certificate prior to uploading it to the directory.
- `summary` displays the CRL issuer's name and the LDAP entry where the CRL is stored in the directory.

Example

```
orapki crl upload -crl $ORACLE_HOME/admin/db_unique_name/wallet/crls  
-ldap hr_db:4415  
-user psmith  
-wallet $ORACLE_HOME/admin/db_unique_name/wallet
```

Related Topics

- [Uploading CRLs to Oracle Internet Directory](#)
Publishing CRLs in the directory enables CRL validation throughout your enterprise, eliminating the need for individual applications to configure their own CRLs.

B.6.8 orapki secretstore create_credential

The `orapki secretstore create_credential` command creates database connection credentials in the wallet.

Syntax

```
orapki secretstore create_credential [-wallet wallet_file_directory] [-pwd wallet_password]  
[-default | -connect_string db_connect_string]  
[-username user_name] [-password user_password]
```

- `wallet` specifies the path to the wallet directory where you want to store the credential. If you omit the `pwd` argument for the password, then you will be prompted for the password. For better security, enter the password when prompted.
- `connect_string` can be the TNS alias that you use to specify the database in the `tnsnames.ora` file or any service name you use to identify the database on an Oracle Database network.
- `default` can be used instead of `connect_string` to add default credentials if the `connect_string` is neither available nor required. It is used to more conveniently set the default username and password.
- `username` and `password` are the database login credentials. If no password is provided, then a password prompt appears. For better security, enter the password at the prompt instead of entering it at the command line.

Example B-3 Create credentials with a connect string

```
orapki secretstore create_credential -wallet $ORACLE_HOME/admin/  
db_unique_name/wallet  
-connect_string sales.us.example.com -username pfitch  
Enter wallet password: wallet_password  
Enter user password: user_password
```

Example B-4 Create default credentials

```
orapki secretstore create_credential -wallet $ORACLE_HOME/admin/  
db_unique_name/wallet  
-default -username pfitch -password sample_pass1
```

B.6.9 orapki secretstore create_entry

The `orapki secretstore create_entry` command stores a secret entries against an alias in a wallet.

Syntax

```
orapki secretstore create_entry [-wallet wallet_file_directory] [-pwd wallet_password]  
[-alias alias] [-secret secret]
```

- `wallet` specifies the location of the wallet that will contain the secret entries for the specified alias. If you omit the `pwd` argument for the password, then you will be prompted for the password. For better security, enter the password when prompted.
- `alias` specifies the name of the alias in which you want to store the secret entries.
- `secret` specifies the secret text that you want to store.

Example

```
orapki secretstore create_entry -wallet $ORACLE_HOME/admin/db_unique_name/  
wallet  
-alias db_alias -secret Time2Laugh@  
Enter wallet password: wallet_password
```

B.6.10 orapki secretstore create_user_credential

The `orapki secretstore create_user_credential` command creates a credential object that is referenced by an alias that is constituted from a map and key name.

Syntax

```
orapki secretstore create_user_credential [-wallet wallet_file_directory] [-pwd  
wallet_password]  
[-map map] [-key key] [-username user_name] [-password user_password]
```

- `wallet` specifies the path to the directory where you created the wallet that will contain the user credentials. If you omit the `pwd` argument for the password, then you will be prompted for the password. For better security, enter the password when prompted.
- `map` specifies the map that is used to reference a credential in the Oracle Platform Security Services (OPSS) credential store framework (CSF). This is combined with the key to construct the alias for the credential.
- `key` specifies the map that is used to reference a credential in the OPSS CSF. This is combined with the map to construct the alias for the credential.
- `username` and `password` are the credentials of the user name to be stored in the secret store. If no password is provided, then a password prompt appears. For better security, enter the password at the prompt instead of entering it at the command line.

Example

```
orapki secretstore create_user_credential -wallet $ORACLE_HOME/admin/  
db_unique_name/wallet  
-map ofss.map -key cwalletkey -username pfitch  
Enter wallet password: wallet_password  
Enter user password: user_password
```

B.6.11 orapki secretstore delete_credential

The `orapki secretstore delete_credential` command deletes database connection credentials from a wallet.

Syntax

```
orapki secretstore delete_credential [-wallet wallet_file_directory] [-pwd  
wallet_password]  
[-connect_string db_connect_string]
```

- `wallet` specifies the path to the wallet directory where the credential is stored. If you omit the `pwd` argument for the password, then you will be prompted for the password. For better security, enter the password when prompted.
- `connect_string` can be the TNS alias that you use to specify the database in the `tnsnames.ora` file or any service name you use to identify the database on an Oracle Database network.

Example

```
orapki secretstore delete_credential -wallet $ORACLE_HOME/admin/  
db_unique_name/wallet  
-connect_string sales.us.example.com  
Enter wallet password: wallet_password
```

B.6.12 orapki secretstore delete_entry

The `orapki secretstore delete_entry` command deletes the secret entries for an alias from a wallet.

Syntax

```
orapki secretstore delete_entry [-wallet wallet_file_directory] [-pwd wallet_password]  
[-alias alias]
```

- `wallet` specifies the location of the wallet that contains the secret entries to be deleted for the specified alias. If you omit the `pwd` argument for the password, then you will be prompted for the password. For better security, enter the password when prompted.
- `alias` specifies the name of the alias from which you want to delete the secret entries.

Example

```
orapki secretstore delete_entry -wallet $ORACLE_HOME/admin/db_unique_name/  
wallet  
-alias db_alias
```

B.6.13 orapki secretstore delete_user_credential

The `orapki secretstore delete_user_credential` command deletes the credential object that is referenced by the alias that was constituted from the map and key name.

Syntax

```
orapki secretstore delete_user_credential [-wallet wallet_file_directory] -pwd  
wallet_password  
[-map map] [-key key]
```

- `wallet` specifies the path to the directory where you created the wallet that contains the user credentials.
- `map` specifies the map that is used to reference a credential in the Oracle Platform Security Services (OPSS) credential store framework (CSF). This is combined with the key to construct the alias for the credential.
- `key` specifies the map that is used to reference a credential in the OPSS CSF. This is combined with the key to construct the alias for the credential.

Example

```
orapki secretstore delete_user_credential -wallet $ORACLE_HOME/admin/  
db_unique_name/wallet
```

```
-map ofss.map -key cwalletkey  
Enter wallet password: wallet_password
```

B.6.14 orapki secretstore list_credentials

The `orapki secretstore list_credentials` command lists the contents of the external password store.

Syntax

```
orapki secretstore list_credentials [-wallet wallet_file_directory] [-pwd  
wallet_password]
```

- `wallet` specifies the location of the wallet whose external password store credentials you want to view. If you omit the `pwd` argument for the password, then you will be prompted for the password. For better security, enter the password when prompted.

Example

```
orapki secretstore list_credentials -wallet $ORACLE_HOME/admin/db_unique_name/  
wallet  
Enter wallet password: wallet_password
```

B.6.15 orapki secretstore list_entries

The `orapki secretstore list_entries` command lists the identifiers in a wallet.

The `orapki wallet display` command is a superset of the information that is shown in the `orapki secretstore list_entries` command.

Syntax

```
orapki secretstore list_entries [-wallet wallet_file_directory] [-pwd wallet_password]
```

- `wallet` specifies the location of the wallet whose identifiers you want to list. If you omit the `pwd` argument for the password, then you will be prompted for the password. For better security, enter the password when prompted.

Example

```
orapki secretstore list_entries -wallet $ORACLE_HOME/admin/db_unique_name/  
wallet  
Enter wallet password: wallet_password
```

Related Topics

- [orapki wallet display](#)
The `orapki wallet display` command displays the certificate requests, user certificates, and trusted certificates in an Oracle wallet.

B.6.16 orapki secretstore list_entries_unsorted

The `orapki secretstore list_entries_unsorted` command lists the identifiers in a wallet in unsorted order.

Syntax

```
orapki secretstore list_entries_unsorted [-wallet wallet_file_directory] [-pwd wallet_password]
```

- `wallet` specifies the location of the wallet whose identifiers you want to list. If you omit the `pwd` argument for the password, then you will be prompted for the password. For better security, enter the password when prompted.

Example

```
orapki secretstore list_entries_unsorted -wallet $ORACLE_HOME/admin/  
db_unique_name/wallet  
Enter wallet password: wallet_password
```

B.6.17 orapki secretstore modify_credential

The `orapki secretstore modify_credential` command modifies database connection credentials in the wallet.

Syntax

```
orapki secretstore modify_credential [-wallet wallet_file_directory] [-pwd  
[wallet_password]]  
[-connect_string db_connect_string]  
[-username user_name] [-password user_password]
```

- `wallet` specifies the path to the wallet directory that stores the credential. If you omit the `pwd` argument for the password, then you will be prompted for the password. For better security, enter the password when prompted.
- `connect_string` is the TNS alias that you use to specify the database in the `tnsnames.ora` file or any service name you use to identify the database on an Oracle Database network.
- `username` and `password` are the database login credentials. If no password is provided, then a password prompt appears. For better security, enter the password at the prompt instead of entering it at the command line.

Example

```
orapki secretstore modify_credential -wallet $ORACLE_HOME/admin/  
db_unique_name/wallet  
-connect_string sales.us.example.com -username pfitch  
Enter wallet password: wallet_password  
Enter user password: user_password
```

B.6.18 orapki secretstore modify_entry

The `orapki secretstore modify_entry` command modifies the secret entry for an alias in a wallet.

Syntax

```
orapki secretstore modify_entry [-wallet wallet_file_directory] [-pwd wallet_password]  
[-alias alias] [-secret secret]
```

- `wallet` specifies the location of the wallet that contains the secret entry to be modified for the specified alias. If you omit the `pwd` argument for the password, then you will be prompted for the password. For better security, enter the password when prompted.
- `alias` specifies the name of the alias where the secret entries are stored.
- `secret` specifies the secret text that you store.

Example

```
orapki secretstore modify_entry -wallet $ORACLE_HOME/admin/db_unique_name/  
wallet  
-alias db_alias -secret Time2Cry@  
Enter wallet password: wallet_password
```

B.6.19 orapki secretstore modify_user_credential

The `orapki secretstore modify_user_credential` command modifies a credential object that is referenced by an alias that was constituted from a map and key name.

Syntax

```
orapki secretstore modify_user_credential [-wallet wallet_file_directory] [-pwd  
wallet_password]  
[-map map] [-key key] [-username user_name] [-password user_password]
```

- `wallet` specifies the path to the directory where you created the wallet that contains the user credentials. If you omit the `pwd` argument for the password, then you will be prompted for the password. For better security, enter the password when prompted.
- `map` specifies the map that is used to reference a credential in the Oracle Platform Security Services (OPSS) credential store framework (CSF). This is combined with the key to construct the alias for the credential.
- `key` specifies the map that is used to reference a credential in the OPSS CSF. This is combined with the key to construct the alias for the credential.
- `username` and `password` are the credentials of the user name to be stored in the secret store. If no password is provided, then a password prompt appears. For better security, enter the password at the prompt instead of entering it at the command line.

Example

```
orapki secretstore modify_user_credential -wallet $ORACLE_HOME/admin/  
db_unique_name/wallet  
-map ofss.map -key cwalletkeyhr -username psmith
```

```
Enter wallet password: wallet_password
Enter user password: user_password
```

B.6.20 orapki secretstore view_entry

The `orapki secretstore view_entry` command lists the secret entries for an alias in a wallet.

Syntax

```
orapki secretstore view_entry [-wallet <wallet_file_directory>] [-pwd <wallet_password>]
[-alias <alias>]
```

- `wallet` specifies the location of the wallet that will contain the secret entries for the specified alias. If you omit the `pwd` argument for the password, then you will be prompted for the password. For better security, enter the password when prompted.
- `alias` specifies the name of the alias for which the secret entries will be displayed

Example

```
orapki secretstore view_entry -wallet $ORACLE_HOME/admin/<db_unique_name>/
wallet -alias <db_alias>
Enter wallet password: wallet_password
```

Related Topics

- [orapki wallet display](#)
 The `orapki wallet display` command displays the certificate requests, user certificates, and trusted certificates in an Oracle wallet.

B.6.21 orapki wallet add

The `orapki wallet add` command adds certificate requests and certificates to an Oracle wallet.

Syntax

```
orapki wallet add [-wallet [wallet_file_directory]] [-dn [user_dn]] [-alias [alias]] -
asym_alg [RSA|ECC]
[-keysize [512|768|1024|2048|4096|8192|16384]] | [-ecurve [p192|p224|p256|p384|p521|
k163|k233|k283|k409|k571|b163|b233|b283|b409|b571]]
-self_signed [-validity [number_of_days]] | [-valid_from [mm/dd/yyyy] -valid_until
[mm/dd/yyyy]]
[-serial_file file_path] | [-serial_num serial_num] -addext_ski
-addext_ku
digitalSignature,nonRepudiation,keyEncipherment,dataEncipherment,keyAgreement,keyCertSign
,cRLSign,encipherOnly,decipherOnly
-addext_basic_cons [CA] | [-pathLen [pathlen]]] -addext_san [DNS:value] [-cert
[file_name]]
[-trusted_cert|-user_cert] [-pwd password] | [-auto_login_only]
[-sign_alg md5|sha1|sha256|sha384|sha512|ecdsasha1|ecdsasha256|ecdsasha384|ecdsasha512]
```

Table B-2 Parameter Descriptions of orapki wallet add

Parameter	Description
wallet	Specifies the location of the wallet to which you want to add a certificate request.
alias	Specifies a unique certificate or certificate request. For example, it can be used to add and later export a certificate request: <pre>orapki wallet create -wallet sample_wallet orapki wallet add -wallet sample_wallet -dn CN=ROOT - keysize 2048 -validity 365 -self_signed -alias sample_alias orapki wallet export -wallet sample_wallet -alias sample_alias -request cert_request.csr</pre>
dn	Specifies the distinguished name of the certificate to add.
keySize	Specifies the key size in bits for the certificate. The size that you enter indicates the strength of security for the certificate. Values are as follows: <ul style="list-style-type: none"> • 512: Included for backward compatibility and is supported in non-FIPS mode • 768: Supported in non-FIPS mode • 1024: Current default for non-FIPS certificate keys and is supported in non-FIPS mode • 2048: Current default for FIPS certificate keys • 4096: As needed per your site's requirements • 8192: As needed per your site's requirements • 16384: As needed per your site's requirements
asym_alg	Specifies the algorithm (RSA or ECC) to use for the certificate creation, in the case of a self-signed certificate.
self-signed	Creates and adds a root certificate. This option provides either the validity option or the valid_from and valid_until options (mandatory).
serial_file	Specifies the file location of the serial file for the certificate.
serial_num	Specifies the serial number of the certificate.
addtext_ski	Adds the Subject Key Identifier extension and identifies the public key certified by the certificate.
addtext_ku <list of key usage separated by spaces>	Adds the Key Usage extension to the certificate.
addtext_basic_cons [CA] [-pathLen <pathlen>]	Adds the Basic Constraint extension. The optional [CA] and [-pathLen] fields signify whether the given certificate is a certificate authority or not.
addtext_san	Is an extension to X509 certificates used to add subject alternative names, which is used in addition to identify the subject. This option only allows you to add domain names separated by comma. For example: <pre>addtext_san DNS:value_1,DNS:value_2,DNS:value_3 -addtext_san DNS:ns1.example.com,DNS:ns2.example.com</pre>
addtext_xyz	Specifies different constraints.

Table B-2 (Cont.) Parameter Descriptions of orapki wallet add

Parameter	Description
cert	Specifies the location of certificate to add.
trusted_cert user_cert	Specify the type of certificate to add, either trusted or user.
sign_alg	Specifies the signing algorithm to be used for signing certificates. This setting applies to self-signed certificates only.

To sign the request, export it with the export option.

To add trusted certificates:

```
orapki wallet add -wallet wallet_file_directory -trusted_cert -cert  

certificate_file_directory
```

- `trusted_cert` adds the trusted certificate, at the location specified with `-cert`, to the wallet.

To add root certificates:

```
orapki wallet add -wallet wallet_file_directory -dn certificate_dn -keySize 512|1024|  

2048 -self_signed -validity number_of_days
```

- `self_signed` creates a root certificate.
- `validity` is mandatory. Use it to specify the number of days, starting from the current date, that this root certificate will be valid.

To add user certificates:

```
orapki wallet add -wallet wallet_file_directory -user_cert -cert  

certificate_file_directory
```

- `user_cert` adds the user certificate at the location specified with the `-cert` parameter to the wallet. Before you add a user certificate to a wallet, you must add all the trusted certificates that make up the certificate chain. If all trusted certificates are not installed in the wallet before you add the user certificate, then adding the user certificate will fail.

Example

```
orapki wallet add -wallet $ORACLE_HOME/admin/db_unique_name/wallet -dn  

"cn=mavis green, o=example, c=us" -keySize 2048
```

Related Topics

- [orapki wallet export](#)
 The `orapki wallet export` command exports certificate requests and certificates from an Oracle wallet.

B.6.22 orapki wallet change_pwd

The `orapki wallet change_pwd` command changes the password for a wallet.

Syntax

```
orapki wallet change_pwd [-wallet wallet_file_directory] [-oldpwd old_wallet_password] [-newpwd new_wallet_password]
```

- `wallet` specifies the location of the wallet whose password you want to change.
- `oldpwd` specifies the current password to change.
- `newpwd` specifies the new password. Follow these requirements:
 - Use no fewer than 8 characters. The maximum length is unlimited.
 - Use mixed alphanumeric characters.

Example

```
orapki wallet change_pwd -wallet wallet_file_directory -oldpwd  
old_wallet_password -newpwd new_wallet_password  
Enter password: wallet_password
```

B.6.23 orapki wallet convert

The `orapki wallet convert` command converts the 3DES algorithm in an Oracle wallet to use the AES256 algorithm.

Be aware that though the AES256 algorithm is stronger than 3DES, there will be degradation in `orapki` operations if you use AES256.

Syntax

```
orapki wallet convert -wallet wallet_file_directory [-pwd wallet_password] -compat_v12
```

- `wallet` specifies the wallet location for which you want to turn on auto-login.
- `pwd` is the wallet password. If no password is provided, then a password prompt appears. For better security, enter the password at the prompt instead of entering it at the command line.
- `compat_v12` performs the conversion from 3DES to AES256.

Example

```
orapki wallet convert -wallet $ORACLE_HOME/admin/db_unique_name/wallet  
compat_v12  
Enter wallet password: password
```

B.6.24 orapki wallet create

The `orapki wallet create` command creates an Oracle wallet or enables auto-login for an Oracle wallet.

Syntax

```
orapki wallet create [-wallet wallet_file_directory] [-pwd wallet_password] [-auto_login|-auto_login_local] | [-auto_login_only]
```

- `wallet` specifies a location for the new wallet or the location of the wallet for which you want to turn on auto-login.
- `pwd` is a new password to be assigned to the wallet. If you create an auto-login wallet later on, then it will require this password. If you omit the `pwd` argument for the password, then you will be prompted for the password. For better security, enter the password when prompted. When you create the password, follow these requirements:
 - Use no fewer than 8 characters. The maximum length is unlimited.
 - Use mixed alphanumeric characters.
- `auto_login` creates an auto-login wallet, or it turns on automatic login for the wallet specified with the `-wallet` option.
- `auto_login_only` is a type of auto-login wallet that does not require a password.
- `auto_login_local` creates a local auto-login wallet, or it turns on local automatic login for the wallet specified with the `-wallet` option.

Example

```
orapki wallet create -wallet $ORACLE_HOME/admin/db_unique_name/wallet
Enter password: wallet_password
Enter password again: password
```

B.6.25 orapki wallet delete

The `orapki wallet delete` command deletes an Oracle wallet.

Syntax

```
orapki wallet delete [-wallet wallet_file_directory] [-pwd wallet_password] [-sso]
```

- `wallet` specifies the location of the wallet that you want to delete. If you omit the `pwd` argument for the password, then you will be prompted for the password. For better security, enter the password when prompted.
- `sso` enables you to delete an auto-login wallet.

Example

```
orapki wallet delete -wallet $ORACLE_HOME/admin/db_unique_name/wallet -sso
Enter password: wallet_password
```

B.6.26 orapki wallet display

The `orapki wallet display` command displays the certificate requests, user certificates, and trusted certificates in an Oracle wallet.

The `orapki wallet display` command is a superset of the information that is shown in the `orapki secretstore list_entries` command. `orapki wallet display` shows everything, including the secret store entries' thumbprint. It includes both the SHA-1 and SHA-256 thumbprint information for a private key. These thumbprints select a particular certificate from the wallet and are displayed when you run the `orapki wallet display` command. You can specify an alias when you store a private key. The alias and thumbprint enable you to specify the exact private key to use with the connect string.

Syntax

```
orapki wallet display [-wallet wallet_file_directory] [-summary | [-complete | -  
complete -details]]  
[-pwd wallet_password] [-ssvs]
```

- `wallet` specifies a location for the wallet you want to open if it is not located in the current working directory.
- `summary` displays a summary of the wallet information; `complete` displays more details.
- `ssvs` displays the version of the wallet.
- `details` displays additional attributes such as version, signature algorithm, subject public key information, and extensions, as follows:
 - `summary` is the subject name.
 - `complete` contains Alias, Subject, Issuer, Not Before, Not After, Serial Number, Key Length, MD5 digest, SHA-256 digest, SHA-1 digest, Thumbprint
 - `details` contains Alias, Subject, Version, Subject, Issuer, Serial Number, Not Before, Not After, Fingerprint, Signature Algorithm, MD5 digest, SHA-256 digest (thumbprint), SHA-1 digest (thumbprint), Subject Public Key Information (which includes Key Algorithm, Key Length, and Key Data), and, if any, Certificate Extensions.

Example

```
orapki wallet display -wallet $ORACLE_HOME/admin/db_unique_name/wallet
```

Related Topics

- [orapki secretstore list_entries](#)
The `orapki secretstore list_entries` command lists the identifiers in a wallet.

B.6.27 orapki wallet export

The `orapki wallet export` command exports certificate requests and certificates from an Oracle wallet.

Syntax

```
orapki wallet export -wallet wallet_file_directory -dn certificate_dn -cert  
certificate_filename
```

- `wallet` specifies the location of the wallet from which you want to export the certificate.
- `dn` specifies the distinguished name of the certificate. In the case of a multi-valued DN, the order in which the individual DN values are stored in the wallet is uncertain. To find the correct DN that you want, run `orapki wallet display`.
- `cert` specifies the name of the file that contains the exported certificate.

To export a certificate request from an Oracle wallet:

```
orapki wallet export -wallet ./rsa_server_host_name -dn "O=Example, C=US" -request ./
rsa_server_hostname/csr2.pem
Enter wallet password: password
```

- `request` specifies the name of the file that contains the exported certificate request.

Example

```
orapki wallet export -wallet $ORACLE_HOME/admin/db_unique_name/wallet
-dn db_cert
-request db_req
```

Related Topics

- [orapki wallet display](#)
The `orapki wallet display` command displays the certificate requests, user certificates, and trusted certificates in an Oracle wallet.

B.6.28 orapki wallet export_private_key

The `orapki wallet export_private_key` command exports a private key from a wallet.

Syntax

```
orapki wallet export_private_key [-wallet wallet_file_directory] [-pwd wallet_password]
[-alias pvtkey_alias]
[-pvtkeyfile filename] [-pvtkeypwd private_key_password] [-salt salt]
[-cert certificate_filename] [-cacert ca_certificate_filename]
```

- `wallet` specifies the location of the wallet from which you want to export the private key.
- `pvtkeyfile` specifies the name of the private key file
- `pvtkeypwd` specifies password for the private key file. If omitted, a password prompt appears.
- `salt` specifies the salt to use.
- `cert` specifies certificate file name.
- `cacert` specifies the CA file name .

Example

```
orapki wallet export_private_key -wallet wallet_file_directory -alias
pvtkey_alias
-pvtkeyfile pvt_key_filename -pvtkeypwd pvt_key_password -cert cert_file -
cacert cacert_file
Enter password: wallet_password
```

B.6.29 orapki wallet import_pkcs12

The `orapki wallet import_pkcs12` command imports a PKCS #12 file into the wallet. Only the latest valid certificate for each unique private key in a PKCS#12 file will be imported into an Oracle wallet. If a private key already exists in the wallet, its associated certificate chain will be skipped.

Syntax

```
orapki wallet import_pkcs12 -wallet wallet_location [-pwd wallet_password]  
[-auto_login_only]] -pkcs12file pkcs12_file_location [-pkcs12pwd pkcs12_file_password]
```

- `wallet` specifies the location into which PKCS#12 file is to be imported..
- `pkcs12file` specifies the location of the PKCS#12 file to be imported into the wallet.
- `pkcs12pwd` specifies the password of PKCS#12 file that is to be imported into the wallet. If omitted, a password prompt appears.

Example

```
orapki wallet import_pkcs12 -wallet wallet_location -pkcs12file  
pkcs12_file_location -pkcs12pwd pkcs12_file_password  
Enter password: wallet_password
```

B.6.30 orapki wallet import_private_key

The `orapki wallet import_private_key` command imports a private key into a wallet.

Syntax

```
orapki wallet import_private_key [-wallet wallet_file_directory] [-pwd wallet_password]  
[-alias pvtkey_alias]  
[-pvtkeyfile filename] [-pvtkeypwd private_key_password] [-salt salt]  
[-cert certificate_filename] [-cacert ca_certificate_filename]
```

- `wallet` specifies the location of the wallet into which you want to import the private key.
- `pvtkeyfile` specifies the name of the private key file
- `pvtkeypwd` specifies password for the private key file. If omitted, a password prompt appears.
- `salt` specifies the type of salt to use.
- `cert` specifies certificate file name.
- `cacert` specifies the CA file name .

Example

```
orapki wallet import_private_key -wallet wallet_file_directory -alias  
pvtkey_alias  
-pvtkeyfile pvt_key_filename -pvtkeypwd pvt_key_password -cert cert_file -  
cacert cacert_file  
Enter password: wallet_password
```

B.6.31 orapki wallet jks_to_pkcs12

The `orapki wallet jks_to_pkcs12` command converts a Java keystore to PKCS #12 format for the storage of certificate information.

To convert a wallet that uses PKCS #12 format to a Java keystore, you can use `orapki wallet pkcs12_to_jks` command.

Syntax

```
orapki wallet jks_to_pkcs12 [-wallet wallet_file_directory] [-pwd wallet_password]  
[-keystore keystore] [-jkspwd jks_password]
```

- `wallet` specifies the location of the wallet that you want to convert to use PKCS #12 format.
- `keystore` specifies the name of the Java keystore to convert.
- `jkspwd` specifies the password of the Java keystore. If omitted, a password prompt appears.

Example

```
orapki wallet jks_to_pkcs12 -wallet wallet_file_directory -keystore  
keystore_name -jkspwd keystore_password  
Enter password: wallet_password
```

B.6.32 orapki wallet pkcs12_to_jks

The `orapki wallet pkcs12_to_jks` command converts a PKCS #12 keystore to a Java keystore for the storage of certificate information.

To convert a Java keystore wallet to PKCS #12 format to a Java keystore, you can use `orapki wallet jks_to_pkcs12` command.

Syntax

```
orapki wallet pkcs12_to_jks [-wallet wallet_file_directory] [-pwd wallet_password]  
[-jksKeyStoreLoc Java_keystore_location -jksKeyStorepwd Java_keystore_password]  
[-jksTrustStoreLoc jks_trust_store_location -jksTrustStorepwd jks_trust_store_password]
```

- `wallet` specifies the location of the wallet that you want to convert to use Java keystore format.
- `jksKeyStoreLoc` specifies the location for the Java keystore that will be created.
- `jksTrustStorepwd` specifies the password of the JKS trust store. If omitted, a password prompt appears.

Example

```
orapki wallet pkcs12_to_jks -wallet wallet_file_directory -jksKeyStoreLoc  
Java_keystore_location -jkspwd Java_keystore_password  
Enter password: wallet_password
```

B.6.33 orapki wallet remove

The `orapki wallet remove` command removes certificates and certificate requests from the wallet.

Syntax

```
orapki wallet remove [-wallet wallet_file_directory] [-dn subject_dn] | [-alias alias]  
[-issuer_dn issuer_dn] [-serial_file file_path] | [-serial_num serial_num]  
[-trusted_cert_all|-trusted_cert|-user_cert|-cert_req] [-pwd wallet_password] | [-  
auto_login_only]
```

- `wallet` specifies the location of the file where a certificate or certificate request will be removed.
- `dn` specifies distinguished name of the wallet.
- `alias` specifies the alias for this wallet.
- `issuer_dn` specifies the issuer of the DN.
- `trusted_cert_all|-trusted_cert|-user_cert|-cert_req` specifies the type of certificate to remove from the wallet.
- `serial_file` specifies the file location of the serial file for the certificate.
- `serial_num` specifies the serial number of the certificate.

Example

```
orapki wallet remove -wallet wallet_file_directory -dn certificate_dn  
Enter password: wallet_password
```

B.7 mkstore Utility Commands Summary

The `mkstore` command line utility, available as part other Oracle Database client and server installations, enables you to create wallets and add credential secrets such as user names and passwords.

Starting with Oracle Database release 23ai, `mkstore` is deprecated. Use `orapki` instead.

- [mkstore create](#)
The `mkstore create` command creates a wallet (`cwallet.sso` and `ewallet.p12`) at the command line.
- [mkstore createALO](#)
The `mkstore createALO` command creates an auto-login-only wallet (`cwallet.sso`).
- [mkstore createCredential](#)
The `mkstore createCredential` command creates database connection credentials in the wallet.
- [mkstore createEntry](#)
The `mkstore createEntry` command stores a secret text against an alias.
- [mkstore createUserCredential](#)
The `mkstore createUserCredential` command creates a credential object that is referenced by an alias that is constituted from a map and key name.

- **mkstore delete**
The `mkstore delete` command deletes a wallet.
- **mkstore deleteCredential**
The `mkstore deleteCredential` command deletes database login credentials from a wallet.
- **mkstore deleteEntry**
The `mkstore deleteEntry` command deletes the secret entries for an alias in a wallet.
- **mkstore deleteSSO**
The `mkstore deleteSSO` command deletes an auto-login wallet.
- **mkstore deleteUserCredential**
The `mkstore deleteUserCredential` command deletes the credential object that is referenced by the alias that was constituted from the map and key name.
- **mkstore list**
The `mkstore list` command lists the identifiers in a wallet.
- **mkstore listCredential**
The `mkstore listCredential` command lists the contents of the external password store.
- **mkstore modifyCredential**
The `mkstore modifyCredential` command modifies the database login credentials that are in a wallet.
- **mkstore modifyEntry**
The `mkstore modifyEntry` command modifies the secret entries for an alias in a wallet.
- **mkstore modifyUserCredential**
The `mkstore modifyUserCredential` command modifies a credential object that is referenced by an alias constituted from a map and key name.
- **mkstore viewEntry**
The `mkstore viewEntry` command lists the secret entries for an alias in a wallet.

B.7.1 mkstore create

The `mkstore create` command creates a wallet (`cwallet.sso` and `ewallet.p12`) at the command line.

Syntax

```
mkstore -wrl wallet_file_directory -create
```

- `wrl` specifies the path to the directory where you want to create and store the wallet.
- This command prompts you to enter and reenter a new password. When you create the password, follow these requirements:
 - Use no fewer than 8 characters. The maximum length is unlimited.
 - Use mixed alphanumeric characters.

Example

```
mkstore -wrl $ORACLE_HOME/admin/db_unique_name/wallet -create
Enter password: password
Enter password again: password
```

Related Topics

- [orapki wallet create](#)
The `orapki wallet create` command creates an Oracle wallet or enables auto-login for an Oracle wallet.

B.7.2 mkstore createALO

The `mkstore createALO` command creates an auto-login-only wallet (`cwallet.sso`).

Syntax

```
mkstore -wrl wallet_file_directory -createALO
```

- `wrl` specifies the path to the directory where you want to create and store the auto-login-only wallet.

Example

```
mkstore -wrl $ORACLE_HOME/admin/db_unique_name/wallet -createALO
```

Related Topics

- [orapki wallet create](#)
The `orapki wallet create` command creates an Oracle wallet or enables auto-login for an Oracle wallet.

B.7.3 mkstore createCredential

The `mkstore createCredential` command creates database connection credentials in the wallet.

Syntax

```
mkstore -wrl wallet_file_directory -createCredential db_connect_string username password
```

- `wrl` specifies the path to the directory where you created the wallet.
- `db_connect_string` can be the TNS alias that you use to specify the database in the `tnsnames.ora` file or any service name you use to identify the database on an Oracle Database network.
- `username` and `password` are the database login credentials. If no password is provided, then a password prompt appears. For better security, enter the password at the prompt instead of entering it at the command line.

Example

```
mkstore -wrl $ORACLE_HOME/admin/db_unique_name/wallet -createCredential DBFS
dbfs_admin
Enter password: password
```

Related Topics

- [orapki secretstore create_credential](#)
The `orapki secretstore create_credential` command creates database connection credentials in the wallet.

B.7.4 mkstore createEntry

The `mkstore createEntry` command stores a secret text against an alias.

Syntax

```
mkstore -wrl wallet_file_directory -createEntry alias secret
```

- *wrl* specifies the path to the directory wallet for which you want to create the entry.
- *alias* is the name of the alias for which you want to store the secret text.
- *secret* specifies the secret text that you want to store.

Example

```
mkstore -wrl $ORACLE_HOME/admin/db_unique_name/wallet -createEntry  
oracle.security.client.default_username SCOTT
```

Related Topics

- [orapki secretstore create_entry](#)
The `orapki secretstore create_entry` command stores a secret entries against an alias in a wallet.

B.7.5 mkstore createUserCredential

The `mkstore createUserCredential` command creates a credential object that is referenced by an alias that is constituted from a map and key name.

Syntax

```
mkstore -wrl wallet_file_directory -createUserCredential map key username password
```

- *wrl* specifies the path to the directory where you created the wallet.
- *map* is the map that is used to reference a credential in the Oracle Platform Security Services (OPSS) credential store framework (CSF). This is combined with the key to construct the alias for the credential.
- *key* is the key used to reference a credential in the OPSS CSF. This is combined with the map to construct the alias for the credential.
- *username* is the user name to be stored in the secret store. If a user name is not specified, then `mkstore` sets it as `NO_USER` in the credential.
- *password* is the password to be stored in the secret store. If no password is provided, then a password prompt appears. For better security, enter the password at the prompt instead of entering it at the command line.

Example

```
mkstore -wrl $ORACLE_HOME/admin/db_unique_name/wallet -createUserCredential  
ofss.map cwalletkey ofss  
Enter your secret/Password: password  
Re-enter your secret/Password: password
```

Related Topics

- [orapki secretstore create_user_credential](#)
The `orapki secretstore create_user_credential` command creates a credential object that is referenced by an alias that is constituted from a map and key name.

B.7.6 mkstore delete

The `mkstore delete` command deletes a wallet.

Syntax

```
mkstore -wrl wallet_file_directory -delete
```

- `wallet` specifies the location of the wallet to be deleted.
- This command prompts you to enter the wallet password.

Example

```
mkstore -wrl $ORACLE_HOME/admin/db_unique_name/wallet -delete  
Enter wallet password: password
```

Related Topics

- [orapki wallet delete](#)
The `orapki wallet delete` command deletes an Oracle wallet.

B.7.7 mkstore deleteCredential

The `mkstore deleteCredential` command deletes database login credentials from a wallet.

Syntax

```
mkstore -wrl wallet_file_directory -deleteCredential connect_string
```

- `wrl` specifies the location of the wallet that contains the credentials to be deleted.
- `connect_string` can be the TNS alias you use to specify the database in the `tnsnames.ora` file, or any service name that you use to identify the database on an Oracle Database network.
- This command prompts you to enter the wallet password.

Example

```
mkstore -wrl $ORACLE_HOME/admin/db_unique_name/wallet -deleteCredential DBFS  
dbfs_admin  
Enter wallet password: password
```

Related Topics

- [orapki secretstore delete_credential](#)
The `orapki secretstore delete_credential` command deletes database connection credentials from a wallet.

B.7.8 mkstore deleteEntry

The `mkstore deleteEntry` command deletes the secret entries for an alias in a wallet.

Syntax

```
mkstore -wrl wallet_file_directory -deleteEntry alias
```

- `wrl` specifies the location of the wallet that contains the secret entries to be deleted for the specified alias.
- `alias` specifies the name of alias for which you want to delete the secret entries.
- This command prompts you to enter and reenter a new password. When you create the password, follow these requirements:
 - Use no fewer than 8 characters. The maximum length is unlimited.
 - Use mixed alphanumeric characters.

Example

```
mkstore -wrl $ORACLE_HOME/admin/db_unique_name/wallet -deleteEntry db_alias  
Enter wallet password: password
```

Related Topics

- [orapki secretstore delete_entry](#)
The `orapki secretstore delete_entry` command deletes the secret entries for an alias from a wallet.

B.7.9 mkstore deleteSSO

The `mkstore deleteSSO` command deletes an auto-login wallet.

Syntax

```
mkstore -wrl wallet_file_directory -deleteSSO
```

- `wrl` specifies the location of the SSO wallet to delete.
- This command prompts you to enter the wallet password.

Example

```
mkstore -wrl $ORACLE_HOME/admin/db_unique_name/wallet -deleteSSO  
Enter wallet password: password
```

Related Topics

- [orapki wallet delete](#)
The `orapki wallet delete` command deletes an Oracle wallet.

B.7.10 mkstore deleteUserCredential

The `mkstore deleteUserCredential` command deletes the credential object that is referenced by the alias that was constituted from the map and key name.

Syntax

```
mkstore -wrl wallet_file_directory -deleteUserCredential map key
```

- `wrl` specifies the location of the wallet that contains the credential object to delete.
- `map` specifies the map that used to reference a credential in the Oracle Platform Security Services (OPSS) credential store framework (CSF). This is combined with the key to construct the alias for the credential.
- `key` specifies the key that used to reference a credential in the OPSS CSF. This is combined with the map to construct the alias for the credential.
- This command prompts you to enter the wallet password.

Example

```
mkstore -wrl $ORACLE_HOME/admin/db_unique_name/wallet -deleteUserCredential  
ofss.map cwalletkey  
Enter wallet password: password
```

Related Topics

- [orapki secretstore delete_user_credential](#)
The `orapki secretstore delete_user_credential` command deletes the credential object that is referenced by the alias that was constituted from the map and key name.

B.7.11 mkstore list

The `mkstore list` command lists the identifiers in a wallet.

Syntax

```
mkstore -wrl wallet_file_directory -list
```

- `wrl` specifies the location of the wallet whose identifiers you want to list.
- This command prompts you to enter the wallet password.

Example

```
mkstore -wrl $ORACLE_HOME/admin/db_unique_name/wallet -list  
Enter wallet password: password
```

Related Topics

- [orapki secretstore list_entries](#)
The `orapki secretstore list_entries` command lists the identifiers in a wallet.

B.7.12 mkstore listCredential

The `mkstore listCredential` command lists the contents of the external password store.

Syntax

```
mkstore -wrl wallet_file_directory -listCredential
```

- `wrl` specifies the location of the wallet whose external password store credentials you want to view.
- This command prompts you to enter the wallet password.

Example

```
mkstore -wrl $ORACLE_HOME/admin/db_unique_name/wallet -listCredential  
Enter wallet password: password
```

Related Topics

- [orapki secretstore list_credentials](#)
The `orapki secretstore list_credentials` command lists the contents of the external password store.

B.7.13 mkstore modifyCredential

The `mkstore modifyCredential` command modifies the database login credentials that are in a wallet.

Syntax

```
mkstore -wrl wallet_file_directory] -modifyCredential connect_string username password
```

- `wrl` specifies the location of the wallet.
- `db_connect_string` can be the TNS alias that you used to specify the database in the `tnsnames.ora` file or the service name you used to identify the database on an Oracle Database network.
- `username` and `password` are the database login credentials. If no password is provided, then a password prompt appears. For better security, enter the password at the prompt instead of entering it at the command line.

Example

```
mkstore -wrl $ORACLE_HOME/admin/db_unique_name/wallet -modifyCredential DBFS  
sec_admin  
Enter your secret/Password: password  
Re-enter your secret/Password: password
```

Related Topics

- [orapki secretstore modify_credential](#)
The `orapki secretstore modify_credential` command modifies database connection credentials in the wallet.

B.7.14 mkstore modifyEntry

The `mkstore modifyEntry` command modifies the secret entries for an alias in a wallet.

Syntax

```
mkstore -wrl wallet_file_directory -modifyEntry alias secret
```

- *wrl* specifies the location of the wallet that contains the secret entries to modify.
- *alias* is the name of the alias for the secret text.
- *secret* specifies the secret text.
- This command prompts you to enter the wallet password.

Example

```
mkstore -wrl $ORACLE_HOME/admin/db_unique_name/wallet -modifyEntry  
oracle.security.client.default_username PSMITH  
Enter wallet password: password
```

Related Topics

- [orapki secretstore modify_entry](#)
The `orapki secretstore modify_entry` command modifies the secret entry for an alias in a wallet.

B.7.15 mkstore modifyUserCredential

The `mkstore modifyUserCredential` command modifies a credential object that is referenced by an alias constituted from a map and key name.

Syntax

```
mkstore -wrl wallet_file_directory -modifyUserCredential map key username password
```

- *wallet* specifies the location of the wallet whose user credentials need to be modified.
- *map* is an attribute that is used to reference a credential. This is combined with the key to construct the alias for the credential.
- *key* is the key used to reference a credential. This is combined with the map to construct the alias for the credential.
- *username* is the user name to be stored in the secret store. If a user name is not specified, then `mkstore` sets it as `NO_USER` in the credential.
- *password* is the password to be stored in the secret store. If no password is provided, then a password prompt appears. For better security, enter the password at the prompt instead of entering it at the command line.

Example

```
mkstore -wrl $ORACLE_HOME/admin/db_unique_name/wallet -modifyUserCredential  
connect_string.map cwalletkey sample_user  
Enter your secret/Password: password
```

```
Re-enter your secret/Password: password  
Enter wallet password: password
```

Related Topics

- [orapki secretstore modify_user_credential](#)
The `orapki secretstore modify_user_credential` command modifies a credential object that is referenced by an alias that was constituted from a map and key name.

B.7.16 mkstore viewEntry

The `mkstore viewEntry` command lists the secret entries for an alias in a wallet.

Syntax

```
mkstore -wrl wallet_file_directory -viewEntry alias
```

- `wrl` specifies the location of the wallet that contains the secret entries to view.
- `alias` specifies the name of alias.
- This command prompts you to enter the wallet password.

Example

```
mkstore -wrl $ORACLE_HOME/admin/db_unique_name/wallet -viewEntry db_alias  
Enter wallet password: password
```

Related Topics

- [orapki secretstore view_entry](#)
The `orapki secretstore view_entry` command lists the secret entries for an alias in a wallet.

C

Oracle Database FIPS 140-2 Settings

Oracle supports the Federal Information Processing Standard (FIPS) standard for 140-2.

- [About the Oracle Database FIPS 140-2 Settings](#)
Federal Information Processing Standards (FIPS) are standards and guidelines for federal computer systems that are developed by the U.S. National Institute of Standards and Technology (NIST).
- [Configuration of FIPS 140-2 Using the Consolidated FIPS_140 Parameter](#)
The consolidated `FIPS_140` parameter can be set for several different Oracle Database environments.
- [Legacy FIPS 140-2 Configurations](#)
The legacy FIPS 140-2 configurations apply to Transparent Data Encryption (TDE), `DBMS_CRYPTO`, network native encryption, and Transport Layer Security (TLS).
- [Postinstallation Checks for FIPS 140-2](#)
After you configure the FIPS 140-2 settings, you must verify permissions in the operating system.
- [Verifying FIPS 140-2 Connections](#)
You can use trace files and other methods to verify the FIPS 140-2 connections.
- [Managing Deprecated Weaker Algorithm Keys](#)
In Oracle Database release 23ai, several algorithms for both FIPS and non-FIPS have been deprecated.

C.1 About the Oracle Database FIPS 140-2 Settings

Federal Information Processing Standards (FIPS) are standards and guidelines for federal computer systems that are developed by the U.S. National Institute of Standards and Technology (NIST).

FIPS was developed in accordance with the Federal Information Security Management Act (FISMA). Although FIPS was developed for use by the federal government, many private sector entities voluntarily use these standards.

FIPS 140-2 specifies the security requirements that will be satisfied by a cryptographic module, providing four increasing, qualitative levels intended to cover a range of potential applications and environments. Security Level 1 conforms to the FIPS 140-2 algorithms, key sizes, integrity checks, and other requirements that are imposed by the regulations. FIPS 140-2 Security Level 1 requires no physical security mechanisms in the module beyond the requirement for production-grade equipment. As a result, this level allows software cryptographic functions to be performed in a general-purpose computer running on a specified operating environment.

When FIPS 140-2 settings are configured for Oracle Database, the database uses FIPS 140-2 Level 1 validated cryptographic libraries to protect data at rest and in transit over the network. Oracle Database uses these cryptographic libraries for native network encryption, Transparent Data Encryption (TDE) of columns and tablespaces (including Oracle SecureFiles), Transport Layer Security (TLS), and the `DBMS_CRYPTO` PL/SQL package.

Oracle Database has integrated the following FIPS 140-2 Software Level 1 validated cryptographic modules for authentication, network encryption, and data encryption:

- Oracle OpenSSL FIPS Provider Version 3.0:
 - NIST's Cryptographic Module Validation Program FIPS Certificate #4506. See the NIST Computer Information Technology Laboratory Security Resource Center page [Cryptographic Module Validation Program Certificate #4506](#)
 - Security Policy mapped to Certificate #4506. See [Oracle FIPS 140-2 Non-Proprietary Security Policy](#)
- RSA/Dell BSAFE Crypto-J 6.3 and RSA/Dell BSAFE Java Crypto Module 6.3:
 - NIST's Cryptographic Module Validation Program FIPS Certificate #4697. See the NIST Computer Information Technology Laboratory Security Resource Center page [Cryptographic Module Validation Program Certificate #4697](#)
 - Security Policy mapped to Certificate #4697. See [BSAFE Java Crypto Module 6.3 Security Policy Level 1](#)

See [FIPS certifications](#) for a complete list of Oracle product FIPS security certifications that are completed and are in progress.

To enable FIPS mode for Java components by configuring the `java.properties` file, see *Oracle Fusion Middleware Administering Security for Oracle WebLogic Server*.

Note that Oracle Database FIPS settings enforce the use of FIPS-approved algorithms for the Oracle database only. Third-party vendor software used with Oracle Database running in FIPS mode must use only these FIPS-approved algorithms, or else the vendor software will encounter failures.

C.2 Configuration of FIPS 140-2 Using the Consolidated FIPS_140 Parameter

The consolidated `FIPS_140` parameter can be set for several different Oracle Database environments.

- [About Configuration of FIPS 140-2 Using the FIPS_140 Parameter](#)
 Configuring the `FIPS_140` parameter is the same for all supported environments.
- [Configuring the FIPS_140 Parameter](#)
 To configure FIPS 140-2, you must set the `FIPS_140` parameter in the `fips.ora` file.
- [Running orapki in FIPS Mode](#)
 Run `orapki` in FIPS mode by appending `-fips140_mode` at end of each `orapki` command for any wallet creation command.
- [Configuring Standalone Java FIPS for Running Java Client Applications in FIPS Mode](#)
 To configure standalone Java FIPS for running Java client applications in FIPS mode, you must check the `CLASSPATH` settings and set the appropriate FIPS-validated provider in the `java.security` properties file.
- [Enabling FIPS by Running the enable_fips.py Python Script](#)
 The `enable_fips.py` script enables FIPS mode for Java applications used with Oracle Database, such as Workload Manager, Oracle Database Configuration Assistant (DBCA), and Oracle Net Configuration Assistant (NetCA).
- [FIPS-Supported Algorithms for Transparent Data Encryption](#)
 FIPS-supported algorithms for Transparent Data Encryption (TDE) include AES algorithms.
- [FIPS-Supported Cipher Suites for DBMS_CRYPTO](#)
 The FIPS library supports the use of cipher suites for the `DBMS_CRYPTO` PL/SQL package.

- [FIPS-Supported Cipher Suites for Transport Layer Security](#)
A cipher suite is a set of authentication, encryption, and data integrity algorithms that exchange messages between network nodes.
- [FIPS-Supported Algorithms for Network Native Encryption](#)
The FIPS library supports both encryption and checksumming algorithms for native network encryption.

C.2.1 About Configuration of FIPS 140-2 Using the FIPS_140 Parameter

Configuring the `FIPS_140` parameter is the same for all supported environments.

The `FIPS_140` parameter has been consolidated for Oracle databases that use the following environments and features:

- Transparent Data Encryption (TDE)
- `DBMS_CRYPTO` PL/SQL package
- Transport Layer Security (TLS)
- Native network encryption

C.2.2 Configuring the FIPS_140 Parameter

To configure FIPS 140-2, you must set the `FIPS_140` parameter in the `fips.ora` file.

1. Locate the `fips.ora` file that is used by the database client or database server.

Ensure that the `fips.ora` file is either located in the `$ORACLE_HOME/ldap/admin` directory, or is in a location pointed to by the `FIPS_HOME` environment variable.

2. Add the following line to the `fips.ora` file:

```
FIPS_140=TRUE
```

When you set `FIPS_140` to `TRUE`, cryptographic operations take place within a FIPS-validated cryptographic module.

This parameter is `FALSE` by default. If you set `FIPS_140` to `FALSE`, then cryptographic operations take place in a cryptography module that is not validated for FIPS.

For either setting, cryptographic operations are accelerated if possible.

3. Repeat this procedure in any Oracle Database home for any database server or client.

C.2.3 Running orapki in FIPS Mode

Run `orapki` in FIPS mode by appending `-fips140_mode` at end of each `orapki` command for any wallet creation command.

- Use the following syntax:

```
orapki command -fips140_mode
```

C.2.4 Configuring Standalone Java FIPS for Running Java Client Applications in FIPS Mode

To configure standalone Java FIPS for running Java client applications in FIPS mode, you must check the `CLASSPATH` settings and set the appropriate FIPS-validated provider in the `java.security` properties file.

1. Navigate to the JDK home within the Oracle home.
2. Verify that the `CLASSPATH` includes the following jars: `cryptojce.jar`, `cryptojcommon.jar`, and `jcmFIPS.jar`.
3. In the `java.security` properties file, do the following:
 - a. Set `com.rsa.jsafe.provider.JsafeJCE` as the first security provider. The default values of the `java.security` properties file are read from an implementation-specific location, which is typically the properties file `conf/security/java.security` in the Java installation directory.
 - b. Move up the index of the existing security providers.

Related Topics

- [orapki Utility Commands Summary](#)
The `orapki` commands perform a variety of wallet, certificate revocation lists (CRL), and certificate management tasks.

C.2.5 Enabling FIPS by Running the `enable_fips.py` Python Script

The `enable_fips.py` script enables FIPS mode for Java applications used with Oracle Database, such as Workload Manager, Oracle Database Configuration Assistant (DBCA), and Oracle Net Configuration Assistant (NetCA).

The `enable_fips.py` script updates the `fips.ora` file by setting the parameter `FIPS_140=TRUE` in the `fips.ora` file. It also sets `com.rsa.jsafe.provider.JsafeJCE` as the first security provider in the `java.security` file.

1. Locate the `enable_fips.py` Python script in the `$ORACLE_HOME/bin` directory.
2. Run the `enable_fips.py` script.

```
python enable_fips.py
```

3. In the scenario of running this script on the Oracle Database server, restart the server after the script completes running.

C.2.6 FIPS-Supported Algorithms for Transparent Data Encryption

FIPS-supported algorithms for Transparent Data Encryption (TDE) include AES algorithms.

- AES128
- AES192
- AES256

You can migrate the encryption algorithms in tables and tablespaces to the latest versions. Note that `3DES168` is no longer supported, starting with Oracle Database 23ai.

- For tables: *Oracle Database Advanced Security Guide*
- For tablespaces: *Oracle Database Advanced Security Guide*

C.2.7 FIPS-Supported Cipher Suites for DBMS_CRYPTO

The FIPS library supports the use of cipher suites for the `DBMS_CRYPTO` PL/SQL package.

For the `DBMS_CRYPTO` cryptographic hash:

- `HASH_SH256`
- `HASH_SH384`
- `HASH_SH512`
- `HASH_SHA3_256`
- `HASH_SHA3_384`
- `HASH_SHA3_512`
- `HASH_SHAKE128`
- `HASH_SHAKE256`

`DBMS_CRYPTO` MAC (Message Authentication Code):

- `HMAC_SH256`
- `HMAC_SH384`
- `HMAC_SH512`
- `HMAC_SHA3_256`
- `HMAC_SHA3_384`
- `HMAC_SHA3_512`

`DBMS_CRYPTO` KMACXOF (KECCAK Message Authentication Code):

- `KMACXOF_128`
- `KMACXOF_256`

`DBMS_CRYPTO` ENCRYPT and DECRYPT:

- `ENCRYPT_AES`
- `ENCRYPT_AES128`
- `ENCRYPT_AES192`
- `ENCRYPT_AES256`

`DBMS_CRYPTO` PKENCRYPT and PKDECRYPT:

- `PKENCRYPT_RSA_PKCS1_OAEP_SHA2`

`DBMS_CRYPTO` SIGN and VERIFY:

- `SIGN_SHA224_RSA`
- `SIGN_SHA256_RSA`
- `SIGN_SHA256_RSA_X931`

- SIGN_SHA384_RSA
- SIGN_SHA384_RSA_X931
- SIGN_SHA512_RSA
- SIGN_SHA512_RSA_X931
- SIGN_SHA3_224_RSA
- SIGN_SHA3_256_RSA
- SIGN_SHA3_384_RSA
- SIGN_SHA3_512_RSA
- SIGN_SHA3_224_ECDSA
- SIGN_SHA3_256_ECDSA
- SIGN_SHA3_384_ECDSA
- SIGN_SHA3_512_ECDSA

C.2.8 FIPS-Supported Cipher Suites for Transport Layer Security

A cipher suite is a set of authentication, encryption, and data integrity algorithms that exchange messages between network nodes.

During a TLS handshake, for example, the two nodes negotiate to see as to which cipher suite they will use when transmitting messages back and forth.

Configuring Specific Cipher Suites

Oracle Database TLS cipher suites are automatically set to FIPS approved cipher suites. If you want to configure specific cipher suites, then you can do so by setting the `SSL_CIPHER_SUITES` parameter in the `sqlnet.ora` or the `listener.ora` file.

```
SSL_CIPHER_SUITES=(SSL_cipher_suite1[,SSL_cipher_suite2[,..]])
```

You can also use Oracle Net Manager to set this parameter on the server and the client.

If a specific cipher suite is not specified, then Oracle Database will use the strongest cipher suite common to both the database server and client. The priority order of cipher suites to be selected are in order as they are listed in the preferred and less preferred cipher lists below. Oracle Database will not select 3DES cipher suites automatically due to their weakness; they must be configured explicitly.

Preferred Cipher Suites

The following cipher suites are approved for FIPS validation if you are using TLS version 1.3:

- TLS_AES_128_CCM_SHA256
- TLS_AES_128_GCM_SHA256
- TLS_AES_256_GCM_SHA384

The following cipher suites are approved for FIPS validation if you are using Transport Layer Security (TLS) version 1.2:

- TLS_ECDHE_ECDSA_WITH_AES_128_CBC_SHA
- TLS_ECDHE_ECDSA_WITH_AES_128_CBC_SHA256

- TLS_ECDHE_ECDSA_WITH_AES_128_GCM_SHA256
- TLS_ECDHE_ECDSA_WITH_AES_256_CBC_SHA
- TLS_ECDHE_ECDSA_WITH_AES_256_CBC_SHA384
- TLS_ECDHE_ECDSA_WITH_AES_256_GCM_SHA384
- TLS_ECDHE_RSA_WITH_AES_128_CBC_SHA
- TLS_ECDHE_RSA_WITH_AES_128_CBC_SHA256
- TLS_ECDHE_RSA_WITH_AES_128_GCM_SHA256
- TLS_ECDHE_RSA_WITH_AES_256_CBC_SHA
- TLS_ECDHE_RSA_WITH_AES_256_CBC_SHA384
- TLS_ECDHE_RSA_WITH_AES_256_GCM_SHA384

3DES-Based Cipher Suites

Oracle does not recommend 3DES-based cipher suites because of a weakness in their design. Oracle Database release 21c and later contains support for the following 3DES-based cipher suites. However, they are not enabled by default and must be explicitly configured through the `SSL_CIPHER_SUITES` parameter in the `sqlnet.ora` or the `listener.ora` file.

- TLS_ECDHE_ECDSA_WITH_3DES_EDE_CBC_SHA
- TLS_ECDHE_RSA_WITH_3DES_EDE_CBC_SHA
- TLS_RSA_WITH_3DES_EDE_CBC_SHA

Related Topics

- [Configuring TLS Cipher Suites](#)
A cipher suite is a set of authentication, encryption, and data integrity algorithms used for exchanging messages between network entities.

C.2.9 FIPS-Supported Algorithms for Network Native Encryption

The FIPS library supports both encryption and checksumming algorithms for native network encryption.

- Encryption algorithms: AES128, AES192, and AES256
- Checksumming algorithms: SHA1, SHA256, SHA384, and SHA512

C.3 Legacy FIPS 140-2 Configurations

The legacy FIPS 140-2 configurations apply to Transparent Data Encryption (TDE), `DBMS_CRYPTO`, network native encryption, and Transport Layer Security (TLS).

- [About Legacy FIPS 140-2 Configurations](#)
The use of the legacy FIPS 140-2 configurations is still supported, but Oracle recommends that you use the consolidated `FIPS_140` parameter instead.
- [Configuring FIPS 140-2 for Transparent Data Encryption and DBMS_CRYPTO](#)
The `DBFIPS_140` initialization parameter configures FIPS mode.
- [Configuring FIPS 140-2 for Transport Layer Security](#)
To configure FIPS 140-2 for Transport Layer Security (TLS), you can set the `SSLFIPS_140` parameter.

- [Configuring FIPS 140-2 for Native Network Encryption](#)
To configure FIPS 140-2 for native network encryption, you must set the `FIPS_140` parameter in the `sqlnet.ora` file.

C.3.1 About Legacy FIPS 140-2 Configurations

The use of the legacy FIPS 140-2 configurations is still supported, but Oracle recommends that you use the consolidated `FIPS_140` parameter instead.

The legacy FIPS 140-2 configurations apply to the following environments:

- Transparent Data Encryption (TDE)
- `DBMS_CCRYPTO` PL/SQL packages
- Transport Layer Security (TLS)
- Network native encryption

Related Topics

- [Configuration of FIPS 140-2 Using the Consolidated FIPS_140 Parameter](#)
The consolidated `FIPS_140` parameter can be set for several different Oracle Database environments.

C.3.2 Configuring FIPS 140-2 for Transparent Data Encryption and `DBMS_CCRYPTO`

The `DBFIPS_140` initialization parameter configures FIPS mode.

This method of configuring FIPS 140-2 for TDE and `DBMS_CCRYPTO` is considered a legacy configuration, but it is still supported. Oracle recommends that you use the consolidated `FIPS_140` parameter instead.

1. To configure Transparent Data Encryption and the `DBMS_CCRYPTO` PL/SQL package program units to run in FIPS mode, set the `DBFIPS_140` initialization parameter to `TRUE`.

The settings have the following effect for all platforms:

- `TRUE`: TDE and `DBMS_CCRYPTO` program units use a FIPS-validated cryptographic module.

Be aware that setting `DBFIPS_140` to `TRUE` and thus using the underlying library in FIPS mode incurs a certain amount of overhead when the library is first loaded for each process. This is due to the verification of the signature and the execution of the self tests on the library. Once the library is loaded for each process, then there is no other impact on performance.

- `FALSE`: TDE and `DBMS_CCRYPTO` program units use a cryptographic module that is not validated for FIPS.

2. Restart the database.

Related Topics

- [Configuration of FIPS 140-2 Using the Consolidated FIPS_140 Parameter](#)
The consolidated `FIPS_140` parameter can be set for several different Oracle Database environments.

C.3.3 Configuring FIPS 140-2 for Transport Layer Security

To configure FIPS 140-2 for Transport Layer Security (TLS), you can set the `SSLFIPS_140` parameter.

This method of configuring FIPS 140-2 for TLS is considered a legacy configuration, but it is still supported. Oracle recommends that you use the consolidated `FIPS_140` parameter instead.

1. Ensure that the `fips.ora` file is either located in the `$ORACLE_HOME/ldap/admin` directory, or is in a location pointed to by the `FIPS_HOME` environment variable.
2. In the `fips.ora` file, set `SSLFIPS_140` to `TRUE` so that the TLS adapter can run in FIPS mode.

For example:

```
SSLFIPS_140=TRUE
```

When you set `SSLFIPS_140` to `TRUE`, TLS cryptographic operations take place within a cryptographic module that is designed to comply with FIPS requirements.

This parameter is `FALSE` by default. If you set `SSLFIPS_140` to `FALSE`, then TLS cryptographic operations take place in a cryptography module that is not validated for FIPS, and as with the `TRUE` setting, the operations are accelerated if possible.

3. Repeat this procedure in any Oracle Database home for any database server or client.

Note:

The `SSLFIPS_140` parameter replaces the `SQLNET.SSLFIPS_140` parameter used in Oracle Database 10g release 2 (10.2). You must set the parameter in the `fips.ora` file, and not the `sqlnet.ora` file.

Related Topics

- [Configuration of FIPS 140-2 Using the Consolidated FIPS_140 Parameter](#)
The consolidated `FIPS_140` parameter can be set for several different Oracle Database environments.

C.3.4 Configuring FIPS 140-2 for Native Network Encryption

To configure FIPS 140-2 for native network encryption, you must set the `FIPS_140` parameter in the `sqlnet.ora` file.

This method of configuring FIPS 140-2 for network native encryption is considered a legacy configuration, but it is still supported. Oracle recommends that you use the consolidated `FIPS_140` parameter instead.

1. Locate the `sqlnet.ora` file that is used by the database client or database server
2. Add the following line to the `sqlnet.ora` file:

```
SQLNET.FIPS_140=TRUE
```

When you set `FIPS_140` to `TRUE`, native network encryption cryptographic operations take place within a cryptographic module that is designed to comply with FIPS requirements.

This parameter is `FALSE` by default. If you set `FIPS_140` to `FALSE`, then native network cryptographic operations take place in a cryptography module that is not validated for FIPS, and as with the `TRUE` setting, the operations are accelerated if possible.

3. Repeat this procedure in any Oracle Database home for any database server or client.

Related Topics

- [Configuration of FIPS 140-2 Using the Consolidated FIPS_140 Parameter](#)
The consolidated `FIPS_140` parameter can be set for several different Oracle Database environments.

C.4 Postinstallation Checks for FIPS 140-2

After you configure the FIPS 140-2 settings, you must verify permissions in the operating system.

The permissions are as follows:

- Set execute permissions on all Oracle executable files to prevent the execution of Oracle Cryptographic Libraries by users who are unauthorized to do so, in accordance with the system security policy.
- Set read and write permissions on all Oracle executable files to prevent accidental or deliberate reading or modification of Oracle Cryptographic Libraries by any user.

To comply with FIPS 140-2 Level 2 requirements, in the security policy, include procedures to prevent unauthorized users from reading, modifying or executing Oracle Cryptographic Libraries processes and the memory they are using in the operating system.

C.5 Verifying FIPS 140-2 Connections

You can use trace files and other methods to verify the FIPS 140-2 connections.

- [Verifying FIPS 140-2 Connections When Using the FIPS_140 Parameter](#)
You can use trace files to check the FIPS 140-2 status when using the `FIPS_140` parameter.
- [Verifying FIPS 140-2 Connections for Transport Layer Security](#)
You can use trace files to check the FIPS 140-2 connections for Transport Layer Security (TLS).
- [Verifying FIPS 140-2 Connections for Network Native Encryption](#)
You can use trace files to check the FIPS 140-2 connections for network native encryption.
- [Verifying FIPS 140-2 Connections for Transparent Data Encryption and DBMS_CRYPT](#)
You can check if FIPS mode is enabled by using SQL*Plus.

C.5.1 Verifying FIPS 140-2 Connections When Using the FIPS_140 Parameter

You can use trace files to check the FIPS 140-2 status when using the `FIPS_140` parameter.

1. Set the environment variable `ENABLE_TRACE` to 1 to enable tracing.

- In C shell:

```
setenv ENABLE_TRACE 1
```

- In bash:

```
export ENABLE_TRACE=1
```

2. Check the trace files by searching for FIPS.

C.5.2 Verifying FIPS 140-2 Connections for Transport Layer Security

You can use trace files to check the FIPS 140-2 connections for Transport Layer Security (TLS).

1. Add the following lines to `sqlnet.ora` to enable tracing:

```
trace_directory_server=trace_directory  
trace_file_server=trace_file  
trace_level_server=trace_level
```

For example:

```
trace_directory=/private/oracle/owm  
trace_file_server=fips_trace.trc  
trace_level_server=16
```

Trace level 16 is the minimum trace level required to check the results of the FIPS self-tests.

2. Check the trace files by searching for `Provider Type: FIPS140`.

C.5.3 Verifying FIPS 140-2 Connections for Network Native Encryption

You can use trace files to check the FIPS 140-2 connections for network native encryption.

1. Add the following lines to `sqlnet.ora` to enable tracing:

```
trace_directory_server=trace_directory  
trace_file_server=trace_file  
trace_level_server=trace_level
```

For example:

```
trace_directory=/private/oracle/owm  
trace_file_server=fips_trace.trc  
trace_level_server=16
```

Trace level 16 is the minimum trace level required to check the results of the FIPS self-tests.

2. Check the trace files by searching for `FIPS mode activated successfully`.

C.5.4 Verifying FIPS 140-2 Connections for Transparent Data Encryption and DBMS_CRYPTO

You can check if FIPS mode is enabled by using SQL*Plus.

1. Connect to the database instance by using SQL*Plus.
2. Run the following `SHOW PARAMETER` command:

```
SHOW PARAMETER DBFIPS_140
```

Output similar to the following should appear:

NAME	TYPE	VALUE
DBFIPS_140	boolean	TRUE

C.6 Managing Deprecated Weaker Algorithm Keys

In Oracle Database release 23ai, several algorithms for both FIPS and non-FIPS have been deprecated.

The security strength of the cipher algorithms has been strengthened in Oracle Database 23ai. The following cipher algorithms are deprecated or removed:

- For FIPS mode:
 - The FIPS security strength of 80 is no longer supported. The new default security strength for FIPS mode is 112. Currently, this is the only supported FIPS security strength.
 - RSA, Diffie Hellman, and Digital Signature Algorithm (RSA/DH/DSA) with 1024 key size are no longer supported. The new minimum supported key size is 2048.
- For non-FIPS mode:
 - Security Strength 0 (RSA/DH/DSA key length 512) is deprecated. By default, Security Strength support is now 80. Security strength 0 (RSA key 512 and equivalent) is still available, but not recommended for use. Available security strengths for non-FIPS use are 0 (deprecated), 80, and 112.

Oracle recommends that you find existing use of RSA/DH/DSA 512 /1024 key sizes (along with ECC equivalents) and replace these with RSA/DH/DSA 2048 key size and equivalents.

The following tables describe the security strength of various encryption keys.

You can use the `orapki` command line utility to create signed certificates, manage Oracle wallets, and manage certificate revocation lists. It has the same default key sizes as listed in the following tables.

FIPS Default Setting (Starting with Oracle Database 23ai)

Table C-1 FIPS Default Setting (Starting with Oracle Database 23ai)

Algorithm Key Type	Security Strength
-	Default Security strength: 112 (was 80) Security strength: 0, 80 are not supported and not available for FIPS use
Default RSA/DH/DSA (Diffie Hellman, Digital Signature Algorithm)	2048 key size (Key size support for less than 2048 bits key size is not supported)
Default ECC (Elliptic Curve Cryptography)	ECC curves with minimum ECC curve key length 224, ECC names curves P192, K163, and B163 and lower are not supported

Non-FIPS Default Setting (Starting with Oracle Database 23ai)

Table C-2 Non-FIPS Default Setting (Starting with Oracle Database 23ai)

Algorithm Key Type	Security Strength
-	Default Security strength: 80 Security strength: 0, 112 (available)
Default RSA/DH/DSA (Diffie Hellman, Digital Signature Algorithm)	1024 key size (512 and 2048 are also available by setting <code>ORACLE_MIN_KEY_STRENGTH_SUPPORT</code>). To change Non-FIPS security strength to 0 or 112, set the <code>ORACLE_MIN_KEY_STRENGTH_SUPPORT</code> parameter in the <code>fips.ora</code> file to 0 or 112. This file is either in <code>\$ORACLE_HOME/crypto/admin</code> or in a location pointed to by the environment variable <code>FIPS_HOME</code> .
Default ECC (Elliptic Curve Cryptography)	ECC curves with minimum ECC curve key length 163. ECC names curves lower than K163, B163 are not supported.

D

Considerations for Transitioning from Traditional to Unified Auditing

If you want to transition to unified auditing after you have upgraded to Oracle Database 23ai, note that most of the traditional auditing features will continue to exist in Oracle Database 23ai to help you transition smoothly.

[Table D-1](#) describes how the characteristics of database auditing features differ with transition.

Table D-1 Characteristics of Oracle Database Auditing Features Before and After the Transition to Unified Auditing

Feature	Availability Before Transition	Availability After Transition
General Auditing Features	-	-
Operating system audit trail	Yes	No
XML file audit trail	Yes	No
Network auditing	Yes	No
The ability of users to audit and to removing auditing from their own schema objects	Yes	No
Mandatory auditing of audit administrative actions	No	Yes
Auditing Roles	-	-
AUDIT_ADMIN	Yes, but not needed for users who want to audit their own objects, nor for users who already have the ALTER SYSTEM privilege and want to change the auditing initialization parameters	Yes
AUDIT_VIEWER	Yes	Yes
System Tables	-	-
SYS.AUD\$	Yes	Yes, but will only have pre-transition audit records
SYS.FGA_LOG\$	Yes	Yes, but will only have pre-transition audit records
Initialization Parameters	-	-
AUDIT_TRAIL (deprecated)	Yes	Yes, but will not have any effect
AUDIT_FILE_DEST (deprecated)	Yes	Yes, but will not have any effect
AUDIT_SYS_OPERATIONS (deprecated)	Yes	Yes, but will not have any effect
AUDIT_SYSLOG_LEVEL (deprecated)	Yes	Yes, but will not have any effect
Data Dictionary Views ¹	-	-
ALL_AUDIT_POLICIES	Yes	Yes, but only if fine-grained audit policies are created using the DBMS_FGA PL/SQL package

Table D-1 (Cont.) Characteristics of Oracle Database Auditing Features Before and After the Transition to Unified Auditing

Feature	Availability Before Transition	Availability After Transition
DBA_AUDIT_POLICIES	Yes	Yes, but only if fine-grained audit policies are created using the DBMS_FGA PL/SQL package
DBA_AUDIT_POLICY_COLUMNS	Yes	Yes, but only if fine-grained audit policies are created using the DBMS_FGA PL/SQL package
DBA_COMMON_AUDIT_TRAIL	Yes	Yes, but will only have pre-transition audit records
DBA_AUDIT_EXISTS	Yes	Yes
DBA_AUDIT_OBJECT	Yes	Yes
DBA_AUDIT_POLICIES	Yes	Yes, but only if fine-grained audit policies are created using the DBMS_FGA PL/SQL package
DBA_AUDIT_POLICY_COLUMNS	Yes	Yes, but only if fine-grained audit policies are created using the DBMS_FGA PL/SQL package
DBA_AUDIT_SESSION	Yes	Yes, but will only have pre-transition audit records
DBA_AUDIT_STATEMENT	Yes	Yes, but will only have pre-transition audit records
DBA_AUDIT_TRAIL	Yes	Yes, but will only have pre-transition audit records. The RLS_INFO column captures audited Oracle VPD predicates.
DBA_FGA_AUDIT_TRAIL	Yes	Yes, but will only have pre-transition audit records. The RLS_INFO column captures audited Oracle VPD predicates.
DBA_OBJ_AUDIT_OPTS	Yes	Yes
DBA_PRIV_AUDIT_OPTS	Yes	Yes
DBA_STMT_AUDIT_OPTS	Yes	Yes
UNIFIED_AUDIT_TRAIL	Yes, but does not collect any audit records	Yes, and collects audit records
USER_AUDIT_OBJECT	Yes	Yes
USER_AUDIT_POLICY_COLUMN	Yes	Yes, but only if fine-grained audit policies are created using the DBMS_FGA PL/SQL package
USER_AUDIT_POLICIES	Yes	Yes, but only if fine-grained audit policies are created using the DBMS_FGA PL/SQL package
USER_AUDIT_SESSION	Yes	Yes
USER_AUDIT_STATEMENT	Yes	Yes
USER_AUDIT_TRAIL	Yes	Yes, but will only have pre-transition audit records

Table D-1 (Cont.) Characteristics of Oracle Database Auditing Features Before and After the Transition to Unified Auditing

Feature	Availability Before Transition	Availability After Transition
USER_OBJ_AUDIT_OPTS	Yes	Yes
V\$XML_AUDIT_TRAIL	Yes	Yes, but will only have pre-transition audit records. The RLS_INFO column captures audited Oracle VPD predicates.
CREATE AUDIT POLICY, ALTER AUDIT POLICY, and DROP AUDIT POLICY Statements	The statements are available, but the audit policies will not write to the old audit trails. When a policy is enabled, its audit records are written to the unified audit trail.	Yes, but writes the audit record to the unified audit trail only
AUDIT and NOAUDIT Statements	-	-
AUDIT	Yes	Yes, but enhanced to enable audit policies; create application context audit settings; create audit records on success, failure, or both; and use in a multitenant environment
NOAUDIT	Yes	Yes, but changed to disable audit policies, disable application context audit settings
DBMS_FGA.ADD_POLICY Procedure Parameters	-	-
audit_trail	Yes, and is used as in previous releases	Yes, but when unified auditing is enabled, you can omit this parameter because all records will be written to the unified audit trail.
DBMS_AUDIT_MGMT Package AUDIT_TRAIL_TYPE Property Options	-	-
DBMS_AUDIT_MGMT.AUDIT_TRAIL_AUD_STD	Yes	Yes, but only pre-transition audit records
DBMS_AUDIT_MGMT.AUDIT_TRAIL_FGA_STD	Yes	Yes, but only pre-transition audit records
DBMS_AUDIT_MGMT.AUDIT_TRAIL_DB_STD	Yes	Yes, but only pre-transition audit records
DBMS_AUDIT_MGMT.AUDIT_TRAIL_OS	Yes	Yes, but only pre-transition audit records
DBMS_AUDIT_MGMT.AUDIT_TRAIL_XML	Yes	Yes, but only pre-transition audit records
DBMS_AUDIT_MGMT.AUDIT_TRAIL_FILES	Yes	Yes, but only pre-transition audit records
DBMS_AUDIT_MGMT.AUDIT_TRAIL_ALL	Yes	Yes, but only pre-transition audit records
Oracle Database Vault Features	-	-

Table D-1 (Cont.) Characteristics of Oracle Database Auditing Features Before and After the Transition to Unified Auditing

Feature	Availability Before Transition	Availability After Transition
DVSYS.AUDIT_TRAIL\$ system table	Yes	Is renamed to DVSYS.OLD_AUDIT_TRAIL\$ and retains the old audit records. The previous DVSYS.AUDIT_TRAIL\$ table is made into a view named DVSYS.AUDIT_TRAIL\$. No new audit records are added.
Oracle Label Security Features	-	-
SA_AUDIT_ADMIN PL/SQL package	Yes	No

¹ These data dictionary views will continue to show audit data from audit records that are still in the SYS.AUD\$ and SYS.FGA_LOG\$ system tables. Unified audit trail records are shown only in the unified audit trail-specific views. You must be granted the AUDIT_ADMIN or AUDIT_VIEWER role to query any views that are not prefaced with USER_.

Glossary

access control

The ability of a system to grant or limit access to specific data for specific clients or groups of clients.

Access Control Lists (ACLs)

The group of access directives that you define. The directives grant levels of access to specific data for specific clients, or groups of clients, or both.

Advanced Encryption Standard

Advanced Encryption Standard (AES) is a new cryptographic algorithm that has been approved by the National Institute of Standards and Technology as a replacement for DES. (DES is deprecated in this release. To transition your Oracle Database environment to use stronger algorithms, download and install the patch described in My Oracle Support note [2118136.2](#).) The AES standard is available in Federal Information Processing Standards Publication 197. The AES algorithm is a symmetric block cipher that can process data blocks of 128 bits, using cipher keys with lengths of 128, 192, and 256 bits.

AES

See [Advanced Encryption Standard](#)

application context

A name-value pair that enables an application to access session information about a user, such as the user ID or other user-specific information, and then securely pass this data to the database.

See also [global application context](#).

attribute

An item of information that describes some aspect of an entry in an LDAP directory. An entry comprises a set of attributes, each of which belongs to an [object class](#). Moreover, each attribute has both a *type*, which describes the kind of information in the attribute, and a *value*, which contains the actual data.

application role

A database role that is granted to application users and that is secured by embedding passwords inside the application.

See also [secure application role](#).

authentication

The process of verifying the identity of a user, device, or other entity in a computer system, often as a prerequisite to granting access to resources in a system. A recipient of an authenticated message can be certain of the message's origin (its sender). Authentication is presumed to preclude the possibility that another party has impersonated the sender.

authentication method

A security method that verifies a user's, client's, or server's identity in distributed environments. Network authentication methods can also provide the benefit of [single sign-on \(SSO\)](#) for users. The following authentication methods are supported:

- [Kerberos](#)
- [RADIUS](#)
- [Transport Layer Security \(TLS\)](#)
- [Windows native authentication](#)

authorization

Permission given to a user, program, or process to access an object or set of objects. In Oracle, authorization is done through the role mechanism. A single person or a group of people can be granted a role or a group of roles. A role, in turn, can be granted other roles. The set of privileges available to an authenticated entity.

auto-login wallet

Password-based access to services without providing credentials at the time of access. This auto-login access stays in effect until the auto-login feature is disabled for that wallet. File system permissions provide the necessary security for auto-login wallet. When auto-login is enabled for a wallet, it is only available to the operating system user who created that wallet. Sometimes these are called "SSO wallets" because they provide single sign-on capability.

CDB

Multitenant container database. An Oracle Database installation contains one [root](#) and zero or more pluggable databases ([PDBs](#)). Every Oracle database is a CDB.

base

The root of a subtree search in an [LDAP](#)-compliant directory.

CA

See [certificate authority](#)

certificate

An ITU x.509 v3 standard data structure that securely binds an identify to a public key.

A certificate is created when an entity's public key is signed by a trusted identity, a certificate authority. The certificate ensures that the entity's information is correct, and that the public key belongs to that entity.

A certificate contains the entity's name, identifying information, and public key. It is also likely to contain a serial number, expiration date, and information about the rights, uses, and privileges associated with the certificate. Finally, it contains information about the certificate authority that issued it.

certificate authority

A trusted third party that certifies that other entities—users, databases, administrators, clients, servers—are who they say they are. When it certifies a user, the certificate authority first seeks verification that the user is not on the certificate revocation list (CRL), then verifies the user's identity and grants a certificate, signing it with the certificate authority's private key. The certificate authority has its own certificate and public key which it publishes. Servers and clients use these to verify signatures the certificate authority has made. A certificate authority might be an external company that offers certificate services, or an internal organization such as a corporate MIS department.

certificate chain

An ordered list of certificates containing an end-user or subscriber certificate and its certificate authority certificates.

certificate request

A certificate request, which consists of three parts: certification request information, a signature algorithm identifier, and a digital signature on the certification request information. The certification request information consists of the subject's distinguished name, public key, and an optional set of attributes. The attributes may provide additional information about the subject identity, such as postal address, or a challenge password by which the subject entity may later request certificate revocation. See [PKCS #10](#).

certificate revocation list (CRL)

(CRLs) Signed data structures that contain a list of revoked [certificate s](#). The authenticity and integrity of the CRL is provided by a digital signature appended to it. Usually, the CRL signer is the same entity that signed the issued certificate.

checksumming

A mechanism that computes a value for a message packet, based on the data it contains, and passes it along with the data to authenticate that the data has not been tampered with. The recipient of the data recomputes the cryptographic checksum and compares it with the cryptographic checksum passed with the data; if they match, it is "probabilistic" proof the data was not tampered with during transmission.

cleartext

Unencrypted plain text.

Cipher Block Chaining (CBC)

An encryption method that protects against block replay attacks by making the encryption of a cipher block dependent on all blocks that precede it; it is designed to make unauthorized decryption incrementally more difficult. Oracle Database employs *outer* cipher block chaining because it is more secure than *inner* cipher block chaining, with no material performance penalty.

CIDR

The standard notation used for IP addresses. In CIDR notation, an IPv6 subnet is denoted by the subnet prefix and the size in bits of the prefix (in decimal), separated by the slash (/) character. For example, `fe80:0000:0217:f2ff::/64` denotes a subnet with addresses `fe80:0000:0217:f2ff:0000:0000:0000:0000` through `fe80:0000:0217:f2ff:ffff:ffff:ffff:ffff`. The CIDR notation includes support for IPv4 addresses. For example, `192.0.2.1/24` denotes the subnet with addresses `192.0.2.1` through `192.0.2.255`.

cipher suite

A set of authentication, encryption, and data integrity algorithms used for exchanging messages between network nodes. During a TLS handshake, for example, the two nodes negotiate to see which cipher suite they will use when transmitting messages back and forth.

cipher suite name

Cipher suites describe the kind of cryptographics protection that is used by connections in a particular session.

ciphertext

Message text that has been encrypted.

Classless Inter-Domain Routing

See [CIDR](#) .

client

A client relies on a service. A client can sometimes be a user, sometimes a process acting on behalf of the user during a database link (sometimes called a proxy).

common privilege grant

A privilege that a [common user](#) grants to another common user or to a [common role](#). Common privilege grants can be either system privileges or object privileges, and they apply across all [PDBs](#) in a [CDB](#).

See also [local privilege grant](#).

common role

A role that exists in all containers in a [CDB](#).

common user

In a [CDB](#), a database user that exists with the same identity in every existing and future [PDB](#).

confidentiality

A function of cryptography. Confidentiality guarantees that only the intended recipient(s) of a message can view the message (decrypt the ciphertext).

connect descriptor

A specially formatted description of the destination for a network connection. A connect descriptor contains destination [service](#) and network route information. The destination service is indicated by using its service name for Oracle9i or Oracle8i databases or its Oracle [system identifier \(SID\)](#) for Oracle databases version 8.0. The network route provides, at a minimum, the location of the [listener](#) through use of a network address. See [connect identifier](#)

connect identifier

A name, net service name, or service name that resolves to a [connect descriptor](#). Users initiate a connect request by passing a user name and password along with a connect identifier in a connect string for the service to which they want to connect.

For example:

```
CONNECT username@connect_identifier
Enter password: password
```

connect string

Information the user passes to a [service](#) to connect, such as [user name](#), password and [net service name](#). For example:

```
CONNECT username@net_service_name
Enter password: password
```

container

In a [CDB](#) either, a [root](#) or a [PDB](#).

container data object

In a [CDB](#), a table or view containing data pertaining to multiple containers and possibly the [CDB](#) as a whole, along with mechanisms to restrict data visible to specific common users through such objects to one or more containers. Examples of container data objects are Oracle-supplied views whose names begin with `V$` and `CDB_`.

credentials

A [user name](#), password, or certificate used to gain access to the database.

CRL

See [certificate revocation list \(CRL\)](#)

CRL Distribution Point

(CRL DP) An optional extension specified by the X.509 version 3 certificate standard, which indicates the location of the Partitioned CRL where revocation information for a certificate is stored. Typically, the value in this extension is in the form of a URL. CRL DPs allow revocation information within a single [certificate authority](#) domain to be posted in multiple CRLs. CRL DPs subdivide revocation information into more manageable pieces to avoid proliferating voluminous CRLs, thereby providing performance benefits. For example, a CRL DP is specified in the certificate and can point to a file on a Web server from which that certificate's revocation information can be downloaded.

CRL DP

See [CRL Distribution Point](#)

cryptography

The practice of encoding and decoding data, resulting in secure messages.

data dictionary

A set of read-only tables that provide information about a database.

Data Encryption Standard (DES)

An older Federal Information Processing Standards encryption algorithm superseded by the Advanced Encryption Standard (AES). The DES, DES40, 3DES112, and 3DES168 algorithms are deprecated in this release. To transition your Oracle Database environment to use stronger algorithms, download and install the patch described in My Oracle Support note [2118136.2](#).

database administrator

(1) A person responsible for operating and maintaining an Oracle Server or a database application. (2) An Oracle user name that has been given DBA privileges and can perform database administration functions. Usually the two meanings coincide. Many sites have multiple DBAs.

database alias

See [net service name](#)

Database Installation Administrator

Also called a database creator. This administrator is in charge of creating new databases. This includes registering each database in the directory using the Database Configuration Assistant. This administrator has create and modify access to database service objects and attributes. This administrator can also modify the Default [domain](#).

database link

A network object stored in the local database or in the network definition that identifies a remote database, a communication path to that database, and optionally, a user name and password. Once defined, the database link is used to access the remote database.

A public or private database link from one database to another is created on the local database by a DBA or user.

A global database link is created automatically from each database to every other database in a network with Oracle Names. Global database links are stored in the network definition.

database password version

An irreversible value that is derived from the user's database password. It is also called a password verifier. This value is used during password authentication to the database to prove the identity of the connecting user.

Database Security Administrator

The highest level administrator for database enterprise user security. This administrator has permissions on all of the enterprise domains and is responsible for:

- Administering the Oracle `DBSecurityAdmins` and `OracleDBCreators` groups.

Creating new [enterprise domains](#).

- Moving databases from one [domain](#) to another within the enterprise.

decryption

The process of converting the contents of an encrypted message (ciphertext) back into its original readable format ([plaintext](#)).

definer's rights procedure

A procedure (or program unit) that runs with the privileges of its owner, not its current user. Definer's rights subprograms are bound to the schema in which they are located.

For example, assume that user `blake` and user `scott` each have a table called `dept` in their respective user schemas. If user `blake` calls a definer's rights procedure, which is owned by user `scott`, to update the `dept` table, then this procedure will update the `dept` table in the `scott` schema. This is because the procedure runs with the privileges of the user who owns (defined) the procedure (that is, `scott`).

See also [invoker's rights procedure](#).

denial-of-service (DoS) attack

An attack that renders a Web site inaccessible or unusable. The denial-of-service attack can occur in many different ways but frequently includes attacks that cause the site to crash, reject connections, or perform too slowly to be usable. DoS attacks come in two forms:

- Basic denial-of-service attacks, which require only one or a few computers
- Distributed DoS attacks, which require many computers to run

DES

See [Data Encryption Standard \(DES\)](#)

dictionary attack

A common attack on passwords. The attacker creates a list of many common passwords and encrypts them. Then the attacker steals a file containing encrypted passwords and compares it to their list of encrypted common passwords. If any of the encrypted password values (called verifiers) match, then the attacker can steal the corresponding password. Dictionary attacks can be avoided by using "salt" on the password before encryption. See [salt](#).

Diffie-Hellman key negotiation algorithm

This is a method that lets two parties communicating over an insecure channel to agree upon a random number known only to them. Though the parties exchange information over the insecure channel during execution of the Diffie-Hellman key negotiation algorithm, it is

computationally infeasible for an attacker to deduce the random number they agree upon by analyzing their network communications. Oracle Database uses the Diffie-Hellman key negotiation algorithm to generate session keys.

digital signature

A digital signature is created when a public key algorithm is used to sign the sender's message with the sender's private key. The digital signature assures that the document is authentic, has not been forged by another entity, has not been altered, and cannot be repudiated by the sender.

directory information tree (DIT)

A hierarchical tree-like structure consisting of the DNs of the entries in an LDAP directory. See [distinguished name \(DN\)](#)

directory naming

A [naming method](#) that resolves a database service, [net service name](#), or [net service alias](#) to a [connect descriptor](#) stored in a central directory server. A

directory naming context

A subtree which is of significance within a directory server. It is usually the top of some organizational subtree. Some directories only permit one such context which is fixed; others permit none to many to be configured by the directory administrator.

distinguished name (DN)

The unique name of a directory entry. It is comprised of all of the individual names of the parent entries back to the root entry of the directory information tree. See [directory information tree \(DIT\)](#)

domain

Any tree or subtree within the [Domain Name System \(DNS\)](#) namespace. Domain most commonly refers to a group of computers whose host names share a common suffix, the domain name.

Domain Name System (DNS)

A system for naming computers and network services that is organized into a hierarchy of [domains](#). DNS is used in TCP/IP networks to locate computers through user-friendly names. DNS resolves a friendly name into an IP address, which is understood by computers.

In [Oracle Net Services](#), DNS translates the host name in a TCP/IP address into an IP address.

directly granted role

A [role](#) that has been granted directly to the user, as opposed to an [indirectly granted role](#).

encrypted text

Text that has been encrypted, using an encryption algorithm; the output stream of an encryption process. On its face, it is not readable or decipherable, without first being subject to [decryption](#). Also called [ciphertext](#). Encrypted text ultimately originates as [plaintext](#).

encryption

Disguising a message, rendering it unreadable to all but the intended recipient.

enterprise domain

A directory construct that consists of a group of databases and [enterprise roles](#). A database should only exist in one enterprise domain at any time. Enterprise domains are different from Windows 2000 domains, which are collections of computers that share a common directory database.

Enterprise Domain Administrator

User authorized to manage a specific [enterprise domain](#), including the authority to add new enterprise domain administrators.

enterprise role

Access privileges assigned to [enterprise users](#). A set of Oracle role-based [authorizations](#) across one or more databases in an [enterprise domain](#). Enterprise roles are stored in the directory and contain one or more [global roles](#).

enterprise user

A user defined and managed in a directory. Each enterprise user has a unique identify across an enterprise.

entry

The building block of a directory, it contains information about an object of interest to directory users.

external authentication

Verification of a user identity by a third party authentication service, such as Kerberos or RADIUS.

Federal Information Processing Standard (FIPS)

A U.S. government standard that defines security requirements for cryptographic modules—employed within a security system protecting unclassified information within computer and

telecommunication systems. Published by the National Institute of Standards and Technology (NIST).

FIPS

See [Federal Information Processing Standard \(FIPS\)](#).

forced cleanup

The ability to forcibly cleanup (that is, remove) all audit records from the database. To accomplish this, you set the `USE_LAST_ARCH_TIMESTAMP` argument of the `DBMS_AUDIT_MGMT.CLEAN_AUDIT_TRAIL` procedure to `FALSE`.

See also [purge job](#).

forest

A group of one or more Active Directory trees that trust each other. All trees in a forest share a common [schema](#), configuration, and global catalog. When a forest contains multiple trees, the trees do not form a contiguous namespace. All trees in a given forest trust each other through transitive bidirectional trust relationships.

Forwardable Ticket Granting Ticket

A special Kerberos ticket that can be forwarded to proxies, permitting the proxy to obtain additional Kerberos tickets on behalf of the client for proxy authentication.

See also [Kerberos ticket](#).

global role

A role managed in a directory, but its privileges are contained within a single database. A global role is created in a database by using the following syntax:

```
CREATE ROLE role_name IDENTIFIED GLOBALLY;
```

global application context

A name-value pair that enables application context values to be accessible across database sessions.

See also [application context](#).

grid computing

A computing architecture that coordinates large numbers of servers and storage to act as a single large computer. Oracle Grid Computing creates a flexible, on-demand computing resource for all enterprise computing needs. Applications running on the Oracle Database grid computing infrastructure can take advantage of common infrastructure services for failover,

software provisioning, and management. Oracle Grid Computing analyzes demand for resources and adjusts supply accordingly.

HTTP

Hypertext Transfer Protocol: The set of rules for exchanging files (text, graphic images, sound, video, and other multimedia files) on the World Wide Web. Relative to the TCP/IP suite of protocols (which are the basis for information exchange on the Internet), HTTP is an application protocol.

HTTPS

The use of Transport Layer Security (TLS) as a sublayer under the regular HTTP application layer.

indirectly granted role

A [role](#) granted to a user through another role that has already been granted to this user. Then you grant the `role2` and `role3` roles to the `role1` role. Roles `role2` and `role3` are now under `role1`. This means `psmith` has been indirectly granted the roles `role2` and `role3`, in addition to the direct grant of `role1`. Enabling the direct `role1` for `psmith` enables the indirect roles `role2` and `role3` for this user as well.

identity

The combination of the public key and any other public information for an entity. The public information may include user identification data such as, for example, an e-mail address. A user certified as being the entity it claims to be.

identity management

The creation, management, and use of online, or digital, entities. Identity management involves securely managing the full life cycle of a digital identity from creation (provisioning of digital identities) to maintenance (enforcing organizational policies regarding access to electronic resources), and, finally, to termination.

identity management realm

A subtree in Oracle Internet Directory, including not only an [Oracle Context](#), but also additional subtrees for users and groups, each of which are protected with access control lists.

initial ticket

In Kerberos authentication, an initial ticket or ticket granting ticket (TGT) identifies the user as having the right to ask for additional service tickets. No tickets can be obtained without an initial ticket. An initial ticket is retrieved by running the `okinit` program and providing a password.

instance

Every running Oracle database is associated with an Oracle instance. When a database is started on a database server (regardless of the type of computer), Oracle allocates a memory area called the [System Global Area \(SGA\)](#) and starts an Oracle process. This combination of the SGA and an Oracle process is called an instance. The memory and the process of an instance manage the associated database's data efficiently and serve the one or more users of the database.

integrity

A guarantee that the contents of a message received were not altered from the contents of the original message sent.

invoker's rights procedure

A procedure (or program unit) that runs with the privileges of the current user, that is, the user who invokes the procedure. These procedures are not bound to a particular schema. They can be run by a variety of users and allow multiple users to manage their own data by using centralized application logic. Invoker's rights procedures are created with the `AUTHID` clause in the declaration section of the procedure code.

For example, assume that user `blake` and user `scott` each have a table called `dept` in their respective user schemas. If user `blake` calls an invoker's rights procedure, which is owned by user `scott`, to update the `dept` table, then this procedure will update the `dept` table in the `blake` schema. This is because the procedure runs with the privileges of the user who invoked the procedure (that is, `blake`).

See also [definer's rights procedure](#).

java code obfuscation

Java code [obfuscation](#) is used to protect Java programs from reverse engineering. A special program (an obfuscator) is used to scramble Java symbols found in the code. The process leaves the original program structure intact, letting the program run correctly while changing the names of the classes, methods, and variables in order to hide the intended behavior. Although it is possible to decompile and read non-obfuscated Java code, the obfuscated Java code is sufficiently difficult to decompile to satisfy U.S. government export controls.

Java Database Connectivity (JDBC)

An industry-standard Java interface for connecting to a relational database from a Java program, defined by Sun Microsystems.

JDBC

See [Java Database Connectivity \(JDBC\)](#)

KDC

See [Key Distribution Center \(KDC\)](#).

Kerberos

A network authentication service developed under Massachusetts Institute of Technology's Project Athena that strengthens security in distributed environments. Kerberos is a trusted third-party authentication system that relies on shared secrets and assumes that the third party is secure. It provides single sign-on capabilities and database link authentication (MIT Kerberos only) for users, provides centralized password storage, and enhances PC security.

Kerberos ticket

A temporary set of electronic credentials that verify the identity of a client for a particular service. Also referred to as a service ticket.

Key Distribution Center (KDC)

In Kerberos authentication, the KDC maintains a list of user principals and is contacted through the `kinit` (`okinit` is the Oracle version) program for the user's [initial ticket](#). Frequently, the KDC and the Ticket Granting Service are combined into the same entity and are simply referred to as the KDC. The Ticket Granting Service maintains a list of service principals and is contacted when a user wants to authenticate to a server providing such a service. The KDC is a trusted third party that must run on a secure host. It creates ticket-granting tickets and service tickets.

See also [Kerberos ticket](#).

key pair

A [public key](#) and its associated [private key](#). See [public and private key pair](#).

keytab file

A Kerberos key table file containing one or more service keys. Hosts or services use *keytab* files in the same way as users use their passwords.

kinstance

An instantiation or location of a Kerberos authenticated service. This is an arbitrary string, but the host Computer name for a service is typically specified.

kservice

An arbitrary name of a Kerberos service object.

last archive timestamp

A timestamp that indicates the timestamp of the last archived audit record. For the database audit trail, this timestamp indicates the last audit record archived. For operating system audit

files, it indicates the highest last modified timestamp property of the audit file that was archived. To set this timestamp, you use the `DBMS_AUDIT_MGMT.SET_LAST_ARCHIVE_TIMESTAMP` PL/SQL procedure.

See also [purge job](#).

LDAP

See [Lightweight Directory Access Protocol \(LDAP\)](#)

ldap.ora file

A file created by Oracle Net Configuration Assistant that contains the following directory server access information:

- Type of directory server
- Location of the directory server
- Default identity management realm or Oracle Context (including ports) that the client or server will use

Lightweight Directory Access Protocol (LDAP)

A standard, extensible directory access protocol. It is a common language that LDAP clients and servers use to communicate. The framework of design conventions supporting industry-standard directory products, such as the Oracle Internet Directory.

listener

A process that resides on the server whose responsibility is to listen for incoming client connection requests and manage the traffic to the server.

Every time a client requests a network session with a server, a listener receives the actual request. If the client information matches the listener information, then the listener grants a connection to the server.

listener.ora file

A configuration file for the listener that identifies the:

- Listener name
- Protocol addresses that it is accepting connection requests on
- Services it is listening for

The `listener.ora` file typically resides in `$ORACLE_HOME/network/admin` on UNIX platforms and `ORACLE_BASE\ORACLE_HOME\network\admin` on Windows.

lightweight user session

A user session that contains only information pertinent to the application that the user is logging onto. The lightweight user session does not hold its own database resources, such as

transactions and cursors; hence it is considered "lightweight." Lightweight user sessions consume far less system resources than traditional database session. Because lightweight user sessions consume much fewer server resources, a lightweight user session can be dedicated to each end user and can persist for as long as the application deems necessary.

local privilege grant

A privilege that applies only to the [PDB](#) in which it was granted.

See also [common privilege grant](#).

local role

A role that exists only in a single [PDB](#). Unlike a [common role](#), a local role can only contain roles and privileges that apply within the container in which the role exists.

local user

In a [CDB](#), any user that is not a [common user](#).

MD5

Message Digest 5. An algorithm that assures data integrity by generating a 128-bit cryptographic message digest value from given data. If as little as a single bit value in the data is modified, the MD5 checksum for the data changes. Forgery of data in a way that will cause MD5 to generate the same result as that for the original data is considered computationally infeasible.

MD5 is deprecated in this release. To transition your Oracle Database environment to use stronger algorithms, download and install the patch described in My Oracle Support note [2118136.2](#).

mandatory auditing

Activities that are audited by default. Examples are modifications to unified audit trail policies (such as `ALTER AUDIT POLICY` statements) and top level statements by the administrative users `SYS`, `SYSDBA`, `SYSOPER`, `SYSASM`, `SYSBACKUP`, `SYSDG`, and `SYSKM`, until the database opens. See "[Activities That Are Mandatorily Audited](#)" for more information.

message authentication code

Also known as data authentication code (DAC). A [checksumming](#) with the addition of a secret key. Only someone with the key can verify the cryptographic checksum.

message digest

See [checksumming](#)

CDB

See [CDB](#).

namespace

In Oracle Database security, the name of an application context. You create this name in a `CREATE CONTEXT` statement.

naming method

The resolution method used by a client application to resolve a [connect identifier](#) to a [connect descriptor](#) when attempting to connect to a database service.

National Institute of Standards and Technology (NIST)

An agency within the U.S. Department of Commerce responsible for the development of security standards related to the design, acquisition, and implementation of cryptographic-based security systems within computer and telecommunication systems, operated by a Federal agency or by a contractor of a Federal agency or other organization that processes information on behalf of the Federal Government to accomplish a Federal function.

net service alias

An alternative name for a [directory naming](#) object in a directory server. A directory server stores net service aliases for any defined [net service name](#) or database service. A net service alias entry does not have connect descriptor information. Instead, it only references the location of the object for which it is an alias. When a client requests a directory lookup of a net service alias, the directory determines that the entry is a net service alias and completes the lookup as if it was actually the entry it is referencing.

net service name

A simple name for a service that resolves to a connect descriptor. Users initiate a connect request by passing a user name and password along with a net service name in a connect string for the service to which they want to connect:

```
CONNECT username@net_service_name  
Enter password: password
```

Depending on your needs, net service names can be stored in a variety of places, including:

- Local configuration file, `tnsnames.ora`, on each client
- Directory server
- External naming service, such as NIS

network authentication service

A means for authenticating clients to servers, servers to servers, and users to both clients and servers in distributed environments. A network authentication service is a repository for storing

information about users and the services on different servers to which they have access, as well as information about clients and servers on the network. An authentication server can be a physically separate computer, or it can be a facility co-located on another server within the system. To ensure availability, some authentication services may be replicated to avoid a single point of failure.

network listener

A listener on a server that listens for connection requests for one or more databases on one or more protocols. See [listener](#).

NIST

See [National Institute of Standards and Technology \(NIST\)](#).

non-repudiation

Incontestable proof of the origin, delivery, submission, or transmission of a message.

obfuscation

A process by which information is scrambled into a non-readable form, such that it is extremely difficult to de-scramble if the algorithm used for scrambling is not known.

obfuscator

A special program used to obfuscate Java source code. See [obfuscation](#).

object class

A named group of [attributes](#). When you want to assign attributes to an entry, you do so by assigning to that entry the object classes that hold those attributes. All objects associated with the same object class share the same attributes.

Oracle Context

1. An entry in an LDAP-compliant internet directory called `cn=OracleContext`, under which all Oracle software relevant information is kept, including entries for [Oracle Net Services](#) directory naming and [checksumming](#) security.

There can be one or more Oracle Contexts in a directory. An Oracle Context is usually located in an [identity management realm](#).

Oracle Virtual Private Database

A set of features that enables you to create security policies to control database access at the row and column level. Essentially, Oracle Virtual Private Database adds a dynamic `WHERE`

clause to a SQL statement that is issued against the table, view, or synonym to which an Oracle Virtual Private Database security policy was applied.

Oracle Net Services

An Oracle product that enables two or more computers that run the Oracle server or Oracle tools such as Designer/2000 to exchange data through a third-party network. Oracle Net Services support distributed processing and distributed database capability. Oracle Net Services is an open system because it is independent of the communication protocol, and users can interface Oracle Net to many network environments.

Oracle PKI certificate usages

Defines Oracle application types that a [certificate](#) supports.

Password-Accessible Domains List

A group of [enterprise domains](#) configured to accept connections from password-authenticated users.

PCMCIA cards

Small credit card-sized computing devices that comply with the Personal Computer Memory Card International Association (PCMCIA) standard. These devices, also called PC cards, are used for adding memory, modems, or as hardware security modules. PCMCIA cards that are used as hardware security modules securely store the private key component of a [public and private key pair](#) and some also perform the cryptographic operations as well.

PDB

An individual database that is part of a [CDB](#).

See also [root](#).

peer identity

SSL connect sessions are between a particular client and a particular server. The identity of the peer may have been established as part of session setup. Peers are identified by [X.509 certificate chains](#).

PEM

The Internet Privacy-Enhanced Mail protocols standard, adopted by the Internet Architecture Board to provide secure electronic mail over the Internet. The PEM protocols provide for encryption, authentication, message integrity, and key management. PEM is an inclusive standard, intended to be compatible with a wide range of key-management approaches, including both symmetric and public-key schemes to encrypt data-encrypting keys. The

specifications for PEM come from four Internet Engineering Task Force (IETF) documents: RFCs 1421, 1422, 1423, and 1424.

PKCS #10

An RSA Security, Inc., Public-Key Cryptography Standards (PKCS) specification that describes a syntax for certification requests. A certification request consists of a distinguished name, a public key, and optionally a set of attributes, collectively signed by the entity requesting certification. Certification requests are referred to as certificate requests in this manual. See [certificate request](#)

PKCS #11

An RSA Security, Inc., Public-Key Cryptography Standards (PKCS) specification that defines an application programming interface (API), called Cryptoki, to devices which hold cryptographic information and perform cryptographic operations. See [PCMCIA cards](#)

PKCS #12

An RSA Security, Inc., Public-Key Cryptography Standards (PKCS) specification that describes a transfer syntax for storing and transferring personal authentication credentials—typically in a format called a [wallet](#).

PKI

See [public key infrastructure \(PKI\)](#)

plaintext

Message text that has not been encrypted.

pluggable database

See [PDB](#).

principal

A string that uniquely identifies a client or server to which a set of Kerberos credentials is assigned. It generally has three parts: `kservice/kinstance@REALM`. In the case of a user, `kservice` is the user name. See also [kservice](#), [kinstance](#), and [realm](#)

private key

In public-key cryptography, this key is the secret key. It is primarily used for decryption but is also used for encryption with digital signatures. See [public and private key pair](#).

proxy authentication

A process typically employed in an environment with a middle tier such as a firewall, wherein the end user authenticates to the middle tier, which thence authenticates to the directory on the

user's behalf—as its *proxy*. The middle tier logs into the directory as a *proxy user*. A proxy user can switch identities and, once logged into the directory, switch to the end user's identity. It can perform operations on the end user's behalf, using the authorization appropriate to that particular end user.

public key

In public-key cryptography, this key is made public to all. It is primarily used for encryption but can be used for verifying signatures. See [public and private key pair](#).

public and private key pair

A set of two numbers used for [encryption](#) and [decryption](#), where one is called the [private key](#) and the other is called the [public key](#). Public keys are typically made widely available, while private keys are held by their respective owners. Though mathematically related, it is generally viewed as computationally infeasible to derive the private key from the public key. Public and private keys are used only with asymmetric encryption algorithms, also called public-key encryption algorithms, or public-key cryptosystems. Data encrypted with either a public key or a private key from a [key pair](#) can be decrypted with its associated key from the key-pair. However, data encrypted with a public key cannot be decrypted with the same public key, and data enwrapped with a private key cannot be decrypted with the same private key.

public key infrastructure (PKI)

Information security technology utilizing the principles of public key cryptography. Public key cryptography involves encrypting and decrypting information using a shared public and private key pair. Provides for secure, private communications within a public network.

PUBLIC role

A special role that every database account automatically has. By default, it has no privileges assigned to it, but it does have grants to many Java objects. You cannot drop the `PUBLIC` role, and a manual grant or revoke of this role has no meaning, because the user account will always assume this role. Because all database user accounts assume the `PUBLIC` role, it does not appear in the `DBA_ROLES` and `SESSION_ROLES` data dictionary views.

purge job

A database job created by the `DBMS_AUDIT_MGMT.CREATE_PURGE_JOB` procedure, which manages the deletion of the audit trail. A database administrator schedules, enables, and disables the purge job. When the purge job becomes active, it deletes audit records from the database audit tables, or it deletes Oracle Database operating system audit files.

See also [forced cleanup](#), [last archive timestamp](#).

RADIUS

Remote Authentication Dial-In User Service (RADIUS) is a client/server protocol and software that enables remote access servers to communicate with a central server to authenticate dial-in users and authorize their access to the requested system or service.

realm

1. Short for [identity management realm](#). 2. A Kerberos object. A set of clients and servers operating under a single key distribution center/ticket-granting service (KDC/TGS). Services (see [kservice](#)) in different realms that share the same name are unique.

realm Oracle Context

An [Oracle Context](#) that is part of an [identity management realm](#) in Oracle Internet Directory.

registry

A Windows repository that stores configuration information for a computer.

remote computer

A computer on a network other than the local computer.

role

A named group of related privileges that you grant as a group to users or other roles.

See also [indirectly granted role](#).

root

A collection of Oracle-supplied and user-created schemas to which all PDBs belong. The container database has only one root. Each PDB is considered to be a child of this root. Root has an entry in its data dictionary that indicates the existence of each PDB.

See also [container](#), [CDB](#), [PDB](#).

root key certificate

See [trusted certificate](#)

salt

In cryptography, a way to strengthen the security of encrypted data. Salt is a random string that is added to the data before it is encrypted, making it more difficult for attackers to steal the data by matching patterns of ciphertext to known ciphertext samples. Salt is often also added to passwords, before the passwords are encrypted, to avoid dictionary attacks, a method that unethical hackers (attackers) use to steal passwords. The encrypted salted values make it

difficult for attackers to match the hash value of encrypted passwords (sometimes called verifiers) with their dictionary lists of common password hash values.

schema

1. Database schema: A named collection of objects, such as tables, [views](#), clusters, procedures, packages, [attributes](#), [object classes](#), and their corresponding matching rules, which are associated with a particular user. 2. LDAP directory schema: The collection of attributes, object classes, and their corresponding matching rules.

schema mapping

See [user-schema mapping](#)

secure application role

A database role that is granted to application users, but secured by using an invoker's right stored procedure to retrieve the role password from a database table. A secure application role password is not embedded in the application.

See also [application role](#).

Secure Hash Algorithm (SHA)

An algorithm that assures data integrity by generating a 160-bit cryptographic message digest value from given data. If as little as a single bit in the data is modified, the Secure Hash Algorithm checksum for the data changes. Forgery of a given data set in a way that will cause the Secure Hash Algorithm to generate the same result as that for the original data is considered computationally infeasible.

An algorithm that takes a message of less than 264 bits in length and produces a 160-bit message digest. The algorithm is slightly slower than MD5 (which Oracle Database no longer supports), but the larger message digest makes it more secure against brute-force collision and inversion attacks.

Secure Sockets Layer (SSL)

An industry standard protocol designed by Netscape Communications Corporation for securing network connections. SSL provides authentication, encryption, and data integrity using public key infrastructure (PKI).

The [Transport Layer Security \(TLS\)](#) protocol is the successor to the SSL protocol.

separation of duty

Restricting activities only to those users who must perform them. For example, you should not grant the `SYSDBA` administrative privilege to any user. Only grant this privilege to administrative users. Separation of duty is required by many compliance policies. See "[Guidelines for](#)

[Securing User Accounts and Privileges](#)" for guidelines on granting privileges to the correct users.

server

A provider of a service.

service

1. A network resource used by clients; for example, an Oracle database server.
2. An executable process installed in the Windows [registry](#) and administered by Windows. Once a service is created and started, it can run even when no user is logged on to the computer.

service name

For Kerberos-based authentication, the [kservice](#) portion of a service principal.

service principal

See [principal](#)

service key table

In Kerberos authentication, a service key table is a list of service principals that exist on a [kinstance](#). This information must be extracted from Kerberos and copied to the Oracle server computer before Kerberos can be used by Oracle.

service ticket

A service ticket is trusted information used to authenticate the client, to a specific service or server, for a predetermined period of time. It is obtained from the [KDC](#) using the [initial ticket](#). See also [Kerberos ticket](#).

session key

A key shared by at least two parties (usually a client and a server) that is used for data encryption for the duration of a single communication session. Session keys are typically used to encrypt network traffic; a client and a server can negotiate a session key at the beginning of a session, and that key is used to encrypt all network traffic between the parties for that session. If the client and server communicate again in a new session, they negotiate a new session key.

session layer

A network layer that provides the services needed by the presentation layer entities that enable them to organize and synchronize their dialogue and manage their data exchange. This layer

establishes, manages, and terminates network sessions between the client and server. An example of a session layer is Network Session.

SHA

See [Secure Hash Algorithm \(SHA\)](#).

shared schema

A database or application schema that can be used by multiple enterprise users. Oracle Database supports the mapping of multiple enterprise users to the same shared schema on a database, which lets an administrator avoid creating an account for each user in every database. Instead, the administrator can create a user in one location, the enterprise directory, and map the user to a shared schema that other enterprise users can also map to. Sometimes called [user/schema separation](#).

single key-pair wallet

A [PKCS #12](#)-format [wallet](#) that contains a single user [certificate](#) and its associated [private key](#). The [public key](#) is imbedded in the certificate.

single password authentication

The ability of a user to authenticate with multiple databases by using a single password. In the Oracle Database implementation, the password is stored in an LDAP-compliant directory and protected with encryption and Access Control Lists.

single sign-on (SSO)

The ability of a user to *authenticate once*, combined with strong authentication occurring transparently in subsequent connections to other databases or applications. Single sign-on lets a user access multiple accounts and applications with a single password, entered during a single connection. *Single password, single authentication*. Oracle Database supports Kerberos and SSL-based single sign-on.

smart card

A plastic card (like a credit card) with an embedded integrated circuit for storing information, including such information as user names and passwords, and also for performing computations associated with authentication exchanges. A smart card is read by a hardware device at any client or server.

A smartcard can generate random numbers which can be used as one-time use passwords. In this case, smartcards are synchronized with a service on the server so that the server expects the same password generated by the smart card.

sniffer

Device used to surreptitiously listen to or capture private data traffic from a network.

SSO

See [single sign-on \(SSO\)](#)

System Global Area (SGA)

A group of shared memory structures that contain data and control information for an Oracle [instance](#).

system identifier (SID)

A unique name for an Oracle [instance](#). To switch between Oracle databases, users must specify the desired SID. The SID is included in the `CONNECT DATA` parts of the [connect descriptor](#) in a [tnsnames.ora](#) file, and in the definition of the [network listener](#) in a [listener.ora](#) file.

third-party attack

A security attack characterized by the third-party, surreptitious interception of a message, wherein the third-party decrypts the message, re-encrypts it (with or without alteration of the original message), and re-transmits it to the originally-intended recipient—all without the knowledge of the legitimate sender and receiver. This type of security attack works only in the absence of [authentication](#). Formerly called man-in-the-middle attack.

ticket

A piece of information that helps identify who the owner is. See [initial ticket](#) and [service ticket](#).

tnsnames.ora

A file that contains connect descriptors; each [connect descriptor](#) is mapped to a [net service name](#). The file may be maintained centrally or locally, for use by all or individual clients. This file typically resides in the following locations depending on your platform:

- (UNIX) `ORACLE_HOME/network/admin`
- (Windows) `ORACLE_BASE\ORACLE_HOME\network\admin`

token card

A device for providing improved ease-of-use for users through several different mechanisms. Some token cards offer one-time passwords that are synchronized with an authentication service. The server can verify the password provided by the token card at any given time by contacting the authentication service. Other token cards operate on a challenge-response basis. In this case, the server offers a challenge (a number) which the user types into the token

card. The token card then provides another number (cryptographically-derived from the challenge), which the user then offers to the server.

transport layer

A networking layer that maintains end-to-end reliability through data flow control and error recovery methods. [Oracle Net Services](#) uses *Oracle protocol supports* for the transport layer.

Transport Layer Security (TLS)

An industry standard protocol for securing network connections. The TLS protocol is a successor to the SSL protocol. It provides authentication, encryption, and data integrity using public key infrastructure (PKI). The TLS protocol is developed by the Internet Engineering Task Force (IETF).

trusted certificate

A trusted certificate, sometimes called a root key certificate, is a third party identity that is qualified with a level of trust. The trusted certificate is used when an identity is being validated as the entity it claims to be. Typically, the certificate authorities you trust are called trusted certificates. If there are several levels of trusted certificates, a trusted certificate at a lower level in the certificate chain does not need to have all its higher level certificates reverified.

trusted certificate authority

See [certificate authority](#).

trust point

See [trusted certificate](#).

user name

A name that can connect to and access objects in a database.

user-schema mapping

An [LDAP](#) directory entry that contains a pair of values: the [base](#) in the directory at which users exist, and the name of the database schema to which they are mapped. The users referenced in the mapping are connected to the specified schema when they connect to the database. User-schema mapping entries can apply only to one database or they can apply to all databases in a domain. See [shared schema](#).

user/schema separation

See [shared schema](#).

user search base

The node in the LDAP directory under which the user resides.

views

Selective presentations of one or more tables (or other views), showing both their structure and their data.

wallet

A data structure used to store and manage security credentials for an individual entity.

Windows native authentication

An [authentication method](#) that enables a client single login access to a Windows server and a database running on that server.

X.509

An industry-standard specification for digital [certificate s](#).

Index

Symbols

"all permissions", [A-3](#)

Numerics

12C password hash version
about, [3-34](#)

12C password version
recommended by Oracle, [3-34](#)

A

about, [6-2](#), [9-22](#), [B-4](#), [B-5](#)

about connection, [6-6](#)

ACCEPT_MD5_CERTS sqlnet.ora parameter,
[B-21](#)

ACCEPT_SHA1_CERTS sqlnet.ora parameter,
[B-21](#)

access configuration, DBCA, [6-20](#)

access configuration, silent mode, [6-22](#)

access configuration, system parameters, [6-19](#)

access control

encryption, about manual, [18-1](#)

encryption, problems not solved by, [18-2](#)

enforcing, [A-15](#)

object privileges, [4-72](#)

password encryption, [3-3](#)

access control list (ACL), [10-2](#), [10-4](#)

examples

external network connection for email
alert, [31-12](#)

external network connections, [10-14](#)

wallet access, [10-14](#)

external network services

about, [10-2](#)

advantages, [10-2](#)

affect of upgrade from earlier release,
[10-3](#)

email alert for audit violation tutorial,
[31-12](#)

finding information about, [10-23](#)

network hosts, using wildcards to specify,
[10-18](#)

ORA-06512 error, [10-22](#)

ORA-24247 error, [10-22](#)

access control list (ACL) (*continued*)

external network services (*continued*)

ORA-24247 errors, [10-3](#)

order of precedence, hosts, [10-18](#)

port ranges, [10-19](#)

privilege assignments, about, [10-20](#)

privilege assignments, database
administrators checking, [10-20](#)

privilege assignments, users checking,
[10-21](#)

revoking privileges, [10-7](#)

wallet access

about, [10-3](#)

advantages, [10-3](#)

client certificate credentials, using, [10-8](#)

finding information about, [10-23](#)

non-shared wallets, [10-8](#)

password credentials, [10-8](#)

password credentials, using, [10-8](#)

revoking, [10-13](#)

revoking access, [10-13](#)

shared database session, [10-8](#)

wallets with sensitive information, [10-8](#)

wallets without sensitive information, [10-8](#)

account locking

example, [3-11](#)

explicit, [3-11](#)

password management, [3-10](#)

PASSWORD_LOCK_TIME profile parameter,
[3-10](#)

accounting, RADIUS, [26-17](#)

activating checksumming and encryption, [20-8](#)

ad hoc tools

database access, security problems of, [4-56](#)

adapters, [22-6](#)

ADG_ACCOUNT_INFO_TRACKING initialization
parameter

guideline for securing, [A-15](#)

ADM_PARALLEL_EXECUTE_TASK role

about, [4-40](#)

ADMIN OPTION

about, [4-93](#)

revoking privileges, [4-98](#)

revoking roles, [4-98](#)

roles, [4-55](#)

system privileges, [4-19](#)

- ADMINISTER FINE GRAINED AUDIT POLICY
 - system privilege, [4-26](#)
- ADMINISTER REDACTION POLICY system
 - privilege, [4-26](#)
- ADMINISTER ROW LEVEL SECURITY POLICY
 - system privilege, [4-26](#)
- administrative accounts
 - about, [2-39](#)
 - predefined, listed, [2-39](#)
- administrative privileges
 - about, [4-13](#)
 - granting to users, [4-13](#)
 - SYSBACKUP privilege, [4-14](#)
 - SYSDBA privilege, [4-13](#)
 - SYSDBG privilege, [4-16](#)
 - SYSKM privilege, [4-17](#)
 - SYSOPER privilege, [4-13](#)
 - SYSRAC privilege, [4-17](#)
- administrative user passwords
 - default, importance of changing, [A-7](#)
- administrative users
 - auditing, [30-9](#)
 - last successful login time, [3-49](#)
 - locked or expired accounts, [3-49](#)
 - mandatorily audited, [29-3](#)
 - password complexity verification functions, [3-51](#)
 - password files, managing, [3-49](#)
 - password files, multitenant environment, [3-51](#)
 - password management, [3-49](#)
 - password profile limits, [3-49](#)
- administrator privileges
 - access, [A-15](#)
 - operating system authentication, [3-55](#)
 - passwords, [3-55](#), [A-7](#)
 - SYSDBA and SYSOPER access, centrally controlling, [3-52](#)
 - write, on listener.ora file, [A-15](#)
- Advanced Encryption Standard (AES)
 - about, [20-2](#)
- Advanced Networking Option (ANO) (Oracle native encryption), [20-15](#)
- AES256 algorithm
 - converting to in Oracle wallets, [B-13](#)
- alerts, used in fine-grained audit policy, [31-12](#)
- algorithms
 - weaker keys, [C-12](#)
- ALTER ANY LIBRARY statement
 - security guidelines, [A-3](#)
- ALTER DATABASE DICTIONARY DELETE CREDENTIALS statement, [12-20](#)
- ALTER DATABASE DICTIONARY ENCRYPT CREDENTIALS statement, [12-20](#)
- ALTER DATABASE DICTIONARY REKEY CREDENTIALS statement, [12-20](#)
- ALTER PROCEDURE statement
 - used for compiling procedures, [4-85](#)
- ALTER PROFILE statement
 - altering profile limits with, [3-8](#)
 - password management, [3-5](#)
- ALTER RESOURCE COST statement, [2-29](#)
- ALTER ROLE statement
 - changing authorization method, [4-51](#)
- ALTER SESSION statement
 - schema, setting current, [12-26](#)
- ALTER USER privilege, [2-18](#)
- ALTER USER statement
 - changing SYS password with, [2-21](#)
 - default roles, [4-107](#)
 - explicit account unlocking, [3-11](#)
 - profiles, changing, [3-13](#)
 - REVOKE CONNECT THROUGH clause, [3-76](#)
- altering users, [2-18](#)
- ANO encryption
 - configuring with SSL authentication, [20-15](#)
- ANONYMOUS user account, [2-39](#)
- ANSI operations
 - Oracle Virtual Private Database affect on, [14-45](#)
- ANY system privilege
 - guidelines for security, [A-11](#)
- application common users
 - about, [2-3](#)
- application containers
 - application contexts, [13-3](#)
 - Virtual Private Database policies, [14-5](#)
- application contexts, [13-6](#), [13-28](#), [13-52](#)
 - about, [13-2](#)
 - application containers, [13-3](#)
 - as secure data cache, [13-3](#)
 - benefits of using, [13-3](#)
 - bind variables, [14-4](#)
 - components, [13-2](#)
 - creating session based, [13-8](#)
 - DBMS_SESSION.SET_CONTEXT procedure, [13-13](#)
 - driving context, [13-54](#)
 - editions, affect on, [13-3](#)
 - finding errors by checking trace files, [13-54](#)
 - finding information about, [13-54](#)
 - global application contexts
 - authenticating user for multiple applications, [13-35](#)
 - creating, [13-30](#)
 - logon trigger, creating, [13-15](#)
 - Oracle Virtual Private Database, used with, [14-4](#)
 - performance, [14-36](#)
 - policy groups, used in, [14-16](#)
 - returning predicate, [14-4](#)
 - session information, retrieving, [13-11](#)

- application contexts (*continued*)
 - support for database links, [13-21](#)
 - types, [13-4](#)
 - users, nondatabase connections, [13-29](#), [13-36](#)
 - where values are stored, [13-2](#)
 - See also client session-based application contexts, database session-based application contexts, global application contexts
- application developers
 - CONNECT role change, [A-27](#)
 - managing privileges for, [12-4](#)
- application security
 - finding privilege use by users, [5-2](#)
 - restricting wallet access to current application, [10-8](#)
 - revoking access control privileges from Oracle wallets, [10-13](#)
 - sharing wallet with other applications, [10-8](#)
 - specifying attributes, [13-9](#)
- application users who are database users
 - Oracle Virtual Private Database, how it works with, [14-52](#)
- applications
 - about security policies for, [12-2](#)
 - database users, [12-2](#)
 - DB_DEVELOPER_ROLE role, [12-4](#)
 - enhancing security with, [4-36](#)
 - object privileges, [12-28](#)
 - object privileges permitting SQL statements, [12-28](#)
 - One Big Application User authentication
 - security considerations, [12-3](#)
 - security risks of, [12-2](#)
 - Oracle Virtual Private Database, how it works with, [14-45](#)
 - password handling, guidelines, [12-8](#)
 - password protection strategies, [12-7](#)
 - privileges, managing, [12-21](#)
 - roles
 - multiple, [4-38](#)
 - privileges, associating with database roles, [12-25](#)
 - security, [4-56](#), [12-3](#)
 - security considerations for use, [12-2](#)
 - security limitations, [14-45](#)
 - security policies, [14-17](#)
 - validating with security policies, [14-18](#)
- APPQOSSYS user account, [2-39](#)
- architecture, [6-3](#)
- archiving
 - operating system audit files, [32-10](#)
 - standard audit trail, [32-11](#)
 - timestamping audit trail, [32-15](#)
- ASMSNMP user account, [2-39](#)
- asymmetric key operations, [18-15](#)
- asynchronous authentication mode in RADIUS, [26-5](#)
- attacks
 - See security attacks
- audit files
 - operating system audit trail
 - archiving, setting timestamp, [32-15](#)
 - operating system file
 - archiving, [32-10](#)
 - standard audit trail
 - archiving, setting timestamp, [32-15](#)
 - records, archiving, [32-11](#)
- audit policies, [28-1](#)
 - about, [29-2](#)
 - about predefined, [29-5](#)
 - what to audit, [29-1](#)
 - See also unified audit policies
- audit policies, application contexts
 - about, [30-43](#)
 - appearance in audit trail, [30-45](#)
 - configuring, [30-43](#)
 - disabling, [30-44](#)
 - examples, [30-44](#)
- audit records
 - when written to OS files, [32-7](#)
- audit trail
 - archiving, [32-11](#)
 - capturing syslog records, [32-5](#)
 - capturing Windows Event Viewer records, [32-5](#)
 - finding information about audit management, [32-24](#)
 - finding information about fine-grained audit usage, [31-18](#)
 - finding information about usage, [29-17](#)
 - finding information about usage in custom audit policies, [30-91](#)
 - SYSLOG records, [32-4](#)
 - unified
 - archiving, [32-11](#)
- AUDIT_ADMIN role, [4-40](#)
- AUDIT_VIEWER role, [4-40](#)
- auditing, [29-14](#)
 - administrators, Database Vault, [30-48](#)
 - audit configurations, [29-16](#), [30-37](#)
 - audit options, [29-14](#)
 - audit policies, [29-16](#), [30-37](#)
 - audit trail, sensitive data in, [A-20](#)
 - CDBs, [28-9](#)
 - committed data, [A-21](#)
 - common objects, [29-16](#), [30-37](#)
 - cursors, affect on auditing, [32-10](#)
 - database user names, [3-65](#)
 - Database Vault administrators, [30-48](#)
 - databases, when unavailable, [32-7](#)
 - disk space size for unified audit records, [32-3](#)

auditing (*continued*)

- distributed databases and, [28-10](#)
- DV_ADMIN role user, [30-48](#)
- DV_OWNER role user, [30-48](#)
- finding information about audit management, [32-24](#)
- finding information about fine-grained auditing, [31-18](#)
- finding information about usage, [29-17](#)
- finding information about usage in custom audit policies, [30-91](#)
- fine-grained
 - See fine-grained auditing, [31-2](#)
- functions, [30-16](#)
- functions, Oracle Virtual Private Database, [30-18](#)
- general steps
 - commonly used security-relevant activities, [29-15](#)
 - specific fine-grained activities, [29-16](#)
 - SQL statements and other general activities, [29-15](#)
- general steps for, [29-14](#)
- guidelines for security, [A-20](#)
- historical information, [A-21](#)
- INHERIT PRIVILEGE privilege, [9-8](#)
- keeping information manageable, [A-21](#)
- loading audit records to unified audit trail, [32-7](#)
- mandatory auditing, [29-3](#)
- multitier environments
 - See standard auditing, [30-33](#)
- One Big Application User authentication, compromised by, [12-2](#)
- operating-system user names, [3-65](#)
- Oracle Virtual Private Database policy functions, [30-18](#)
- packages, [30-16](#)
- performance, [28-4](#)
- PL/SQL packages, [30-16](#)
- predefined policies
 - general steps for using, [29-15](#)
- privileges required, [28-6](#)
- procedures, [30-16](#)
- purging records
 - example, [32-24](#)
 - general steps for on-demand, [32-13](#)
 - general steps for scheduled purges, [32-13](#)
- range of focus, [29-14](#)
- READ object privileges in policies, [30-19](#)
- READ privileges
 - about, [30-19](#)
 - how recorded in audit trail, [30-19](#)
- recommended settings, [A-23](#)

auditing (*continued*)

- Sarbanes-Oxley Act
 - auditing, meeting compliance through, [28-1](#)
- SELECT privileges
 - about, [30-19](#)
 - how recorded in audit trail, [30-19](#)
- sensitive data, [A-23](#)
- suspicious activity, [A-22](#)
- triggers, [30-16](#)
- unified audit trail
 - about, [28-5](#)
- VPD predicates
 - fine-grained audit policies, [31-4](#)
 - unified audit policies, [30-16](#)
 - when audit options take effect, [32-2](#)
 - when records are created, [32-2](#)
 - See also unified audit policies
- auditing, purging records
 - about, [32-12](#)
 - cancelling archive timestamp, [32-23](#)
 - creating audit trail
 - purge job, [32-14](#)
 - creating the purge job, [32-17](#)
 - DBMS_SCHEDULER package, [32-14](#)
 - deleting a purge job, [32-22](#)
 - disabling purge jobs, [32-21](#)
 - enabling purge jobs, [32-21](#)
 - general steps for, [32-13](#)
 - purging audit trail manually, [32-18](#)
 - roadmap, [32-13](#)
 - scheduling the purge job, [32-17](#)
 - setting archive timestamp, [32-15](#)
 - time interval for named purge job, [32-22](#)
- AUDSYS user account, [2-39](#)
- AUTHENTICATEDUSER role, [4-40](#)
- authentication, [3-3](#), [22-6](#)
 - about, [3-1](#)
 - administrators
 - operating system, [3-55](#)
 - passwords, [3-55](#)
 - SYSDBA and SYSOPER access, centrally controlling, [3-52](#)
 - by database, [3-57](#)
 - client, [A-15](#)
 - client-to-middle tier process, [3-77](#)
 - configuring multiple methods, [27-4](#)
 - database administrators, [3-52](#)
 - databases, using
 - about, [3-57](#)
 - advantages, [3-59](#)
 - procedure, [3-59](#)
 - Enterprise User Security, [3-69](#)
 - external with local database authorization, [3-64](#), [3-68](#), [3-69](#)
 - methods, [22-3](#)

authentication (*continued*)

- middle-tier authentication
 - proxies, example, [3-79](#)
- modes in RADIUS, [26-3](#)
- multitier, [3-69](#)
- One Big Application User, compromised by, [12-2](#)
- operating system authentication, [3-62](#)
 - about, [3-65](#)
 - advantages, [3-65](#)
 - disadvantages, [3-65](#)
- operating system user in PDBs, [3-62](#)
- ORA-28040 errors, [3-37](#)
- PDBs, [3-62](#)
- proxy user authentication
 - about, [3-73](#)
 - expired passwords, [3-76](#)
- public key infrastructure, [3-66](#)
- RADIUS, [3-67](#)
- remote, [A-15](#)
- schema-only accounts, [3-60](#)
 - about, [3-60](#)
 - altering, [3-61](#)
 - creating users, [3-61](#)
- schema-only accounts, users created with, [3-60](#)
- security guideline, [A-10](#)
- specifying when creating a user, [2-9](#)
- strong, [A-7](#)
- SYSDBA on Windows systems, [3-55](#)
- Windows native authentication, [3-55](#)
 - See also passwords, proxy authentication

authentication types, [6-4](#)

AUTHID DEFINER clause

- used with Oracle Virtual Private Database functions, [14-4](#)

authorization

- about, [4-1](#)
- changing for roles, [4-51](#)
- local database for external authentication, [3-64](#), [3-68](#), [3-69](#)
- multitier, [3-69](#)
- omitting for roles, [4-48](#)
- operating system, [4-53](#)
- roles, about, [4-51](#)

automatic reparse

- Oracle Virtual Private Database, how it works with, [14-46](#)

AVTUNE_PKG_ROLE role, [4-40](#)

B

banners

- auditing user actions, configuring, [12-32](#)
- unauthorized access, configuring, [12-32](#)

BDSQL_ADMIN role, [4-40](#)

BDSQL_USER role, [4-40](#)

BFILES

- guidelines for security, [A-11](#)

bind variables

- application contexts, used with, [14-4](#)
- sensitive columns, [15-17](#)

BLOBS

- encrypting, [18-8](#)

C

CAPTURE_ADMIN role, [4-40](#)

cascading revokes, [4-101](#)

catpvf.sql script (password complexity functions), [3-26](#)

CDB common users

- about, [2-3](#)
- plug-in operations, [2-4](#)

CDB_DBA role, [4-40](#)

CDBs, [2-3](#)

- auditing
 - how affects, [28-9](#)
- CBAC role grants with DELEGATE option, [9-15](#)
- common mandatory profiles for CDB root, about, [2-30](#)
- common mandatory profiles for CDB root, creating, [2-31](#)
- common mandatory profiles for CDB root, example, [2-32](#)
- common privilege grants, [4-6](#), [4-8](#), [4-29](#)
- common roles, [4-59](#)
- common users, [4-6](#), [4-8](#)
- granting common roles and privileges, [4-7](#)
- granting privileges and roles, [4-5](#), [4-31](#)
- local privilege grants, [4-29](#)
- local roles, [4-5](#), [4-62](#)
- object privileges, [4-30](#)
- PDB lockdown profiles, [4-64](#), [4-67](#)
- PDB lockdown profiles, features that benefit from, [4-66](#)
- principles of grants, [4-4](#)
- privilege management, [4-29](#)
- privilege profiles, [5-4](#)
- revoking privileges, [4-31](#)
- roles
 - altering, [4-51](#)
 - creating common, [4-61](#)
 - creating local, [4-62](#)
 - granting common, [4-6](#), [4-8](#), [4-62](#)
 - how common roles work, [4-60](#)
 - managing, [4-58](#)
 - privileges required to manage, [4-60](#)
 - rules for creating common, [4-60](#)
- security isolation guideline, [A-14](#)

- CDBs (*continued*)
 - SYSLOG capture of unified audit records, [32-5](#)
 - system privileges, [4-30](#)
 - transparent sensitive data protection, [15-4](#)
 - user accounts
 - creating, [2-14](#)
 - local, [2-5](#)
 - user privileges, how affects, [4-12](#)
 - users
 - CDB common, [2-3](#)
 - common, [2-3](#)
 - viewing information about, [4-32](#)
 - Virtual Private Database
 - policies, [14-5](#)
- Center for Internet Security (CIS), [29-8](#)
 - ORA_CIS_PROFILE user profile, [2-27](#)
 - ORA_LOGIN_LOGOUT predefined unified audit policy, [29-10](#)
- centrally managed users
 - Oracle Autonomous Database, [6-38](#)
- certificate authority (CA), [B-5](#)
- certificate key algorithm
 - Transport Layer Security, [A-19](#)
- certificate revocation list (CRL)
 - deleting, [B-28](#)
 - displaying, [B-29](#)
 - displaying list of, [B-30](#)
 - hash value generation, [B-30](#)
 - uploading, [B-31](#)
- certificate revocation lists
 - manipulating with orapki tool, [21-46](#)
 - uploading to LDAP directory, [21-46](#)
 - where to store them, [21-42](#)
- certificate revocation status checking
 - disabling on server, [21-44](#), [21-45](#)
- certificate store location
 - system wallet, [B-15](#)
- certificate validation error message
 - CRL could not be found, [21-50](#)
 - CRL date verification failed with RSA status, [21-50](#)
 - CRL signature verification failed with RSA status, [21-50](#)
 - Fetch CRL from CRL DP
 - No CRLs found, [21-50](#)
 - OID hostname or port number not set, [21-50](#)
- certificates, [6-16](#), [B-4](#)
 - adding to wallet using orapki, [B-22](#)
 - creating SHA-2 with orapki, [B-17](#)
 - creating signed with orapki, [B-16](#)
 - general process of management, [B-6](#)
 - Oracle Real Application Clusters components that need certificates, [21-55](#)
 - tools to manage, [B-6](#)
- challenge-response authentication in RADIUS, [26-5](#)
- change_on_install default password, [A-7](#)
- character sets
 - role names, multibyte characters in, [4-48](#)
 - role passwords, multibyte characters in, [4-51](#)
- Cipher Block Chaining (CBC) mode, defined, [20-2](#)
- cipher suites
 - Transport Layer Security, [A-19](#)
- ciphertext data
 - defined, [20-2](#)
- client connections
 - guidelines for security, [A-15](#)
 - secure external password store, [3-43](#)
 - securing, [A-15](#)
- client identifier
 - setting for applications that use JDBC, [3-84](#)
- client identifiers, [13-29](#)
 - about, [3-82](#)
 - auditing users, [30-33](#)
 - consistency between DBMS_SESSION.SET_IDENTIFIER and DBMS_APPLICATION_INFO.SET_CLIENT_INFO, [3-85](#)
 - global application context, independent of, [3-83](#)
 - setting with DBMS_SESSION.SET_IDENTIFIER procedure, [13-29](#)
 - See also* nondatabase users
- client session-based application contexts, [13-52](#)
 - about, [13-52](#)
 - CLIENTCONTEXT namespace, clearing value from, [13-54](#)
 - CLIENTCONTEXT namespace, setting value in, [13-52](#)
 - retrieving CLIENTCONTEXT namespace, [13-53](#)
 - See also* application contexts
- CLIENT_IDENTIFIER USERENV attribute, [3-83](#)
 - setting and clearing with DBMS_SESSION package, [3-85](#)
 - setting with OCI user session handle attribute, [3-84](#)
 - See also* USERENV namespace
- CLIENTID_OVERWRITE event, [3-85](#)
- CMU_WALLET database property
 - about, [6-11](#)
 - wallet creation, [6-17](#)
- code based access control (CBAC)
 - about, [9-11](#)
 - granting and revoking roles to program unit, [9-16](#)
 - how works with definers rights, [9-14](#)
 - how works with invoker's rights, [9-12](#)
 - privileges, [9-12](#)
 - tutorial, [9-17](#)

- column masking behavior, [14-14](#)
 - column specification, [14-15](#)
 - restrictions, [14-15](#)
- columns
 - auditing, [30-11](#), [30-14](#)
 - granting privileges for selected, [4-97](#)
 - granting privileges on, [4-97](#)
 - INSERT privilege and, [4-97](#)
 - listing users granted to, [4-113](#)
 - privileges, [4-97](#)
 - pseudo columns
 - USER, [4-83](#)
 - revoking privileges on, [4-100](#)
- command line recall attacks, [12-7](#), [12-10](#)
- committed data
 - auditing, [A-21](#)
- common privilege grants, [4-6](#), [4-8](#)
 - about, [4-29](#)
 - granting, [4-31](#)
 - revoking, [4-31](#)
 - with object privileges, [4-30](#)
 - with system privileges, [4-30](#)
- common roles, [4-59](#)
 - about, [4-59](#)
 - auditing, [30-5](#)
 - creating, [4-61](#)
 - granting, [4-6](#), [4-8](#), [4-62](#)
 - how they work, [4-60](#)
 - privileges required to manage, [4-60](#)
 - rules for creating, [4-60](#)
- common user accounts
 - creating, [2-14](#)
 - enabling access to other PDBs, [4-31](#)
 - granting privileges to, [4-6](#), [4-8](#), [4-29](#)
- common users
 - accessing data in PDBs, [4-33](#)
 - altering, [2-18](#)
- configuration
 - guidelines for security, [A-13](#)
- configuration files
 - Kerberos, [24-5](#)
 - listener.ora, [A-15](#)
 - RADIUS, [26-7](#)
 - sample listener.ora file, [A-15](#)
 - server.key encryption file, [A-19](#)
 - tsnames.ora, [A-19](#)
 - typical directory, [A-19](#)
- configuring
 - Kerberos authentication service parameters, [24-12](#)
 - RADIUS authentication, [26-9](#)
- CONNECT role
 - about, [A-25](#)
 - applications
 - account provisioning, [A-26](#)
 - affects of, [A-25](#)
 - CONNECT role (*continued*)
 - applications (*continued*)
 - database upgrades, [A-26](#)
 - installation of, [A-26](#)
 - script to create, [4-40](#)
 - users
 - application developers, impact, [A-27](#)
 - client-server applications, impact, [A-27](#)
 - general users, impact, [A-27](#)
 - how affects, [A-26](#)
 - why changed, [A-25](#)
- connecting
 - with username and password, [27-1](#)
- connection pooling
 - about, [3-69](#)
 - finding unnecessarily granted privileges, [5-2](#)
 - global application contexts, [13-29](#)
 - nondatabase users, [13-36](#)
 - proxy authentication, [3-77](#)
- container data objects
 - about, [4-32](#)
- container database (CDB)
 - See CDBs
- CONTAINER_DATA objects
 - viewing information about, [4-31](#)
- context profiles
 - privilege analysis, [5-3](#)
- controlled step-in procedures, [9-3](#)
- CPU time limit, [2-24](#)
- CREATE ANY LIBRARY statement
 - security guidelines, [A-3](#)
- CREATE ANY PROCEDURE system privilege, [4-84](#)
- CREATE CONTEXT statement
 - example, [13-8](#)
- CREATE LOCKDOWN PROFILE statement, [4-64](#), [4-68](#)
- CREATE PROCEDURE system privilege, [4-84](#)
- CREATE PROFILE statement
 - password aging and expiration, [3-12](#)
 - password management, [3-5](#)
 - passwords, example, [3-13](#)
- CREATE ROLE statement, [4-59](#)
 - IDENTIFIED EXTERNALLY option, [4-52](#)
- CREATE SCHEMA statement
 - securing, [12-26](#)
- CREATE SESSION statement
 - CONNECT role privilege, [A-10](#)
 - securing, [12-26](#)
- CREATE USER statement
 - explicit account locking, [3-11](#)
 - IDENTIFIED BY option, [2-9](#)
 - IDENTIFIED EXTERNALLY option, [2-9](#)
 - creating Oracle service directory user account, [6-7](#)

- credentials
 - SQL*Loader object store, [3-47](#)
 - CRLAdmins directory administrative group, [B-31](#)
 - CRLs
 - disabling on server, [21-44](#), [21-45](#)
 - where to store them, [21-42](#)
 - cryptographic libraries
 - FIPS 140-2, [C-1](#)
 - CTXAPP role, [4-40](#)
 - CTXSYS user account, [2-39](#)
 - cursors
 - affect on auditing, [32-10](#)
 - reparsing, for application contexts, [13-15](#)
 - shared, used with Virtual Private Database, [14-4](#)
- ## D
-
- data definition language (DDL)
 - roles and privileges, [4-39](#)
 - data dictionary
 - about, [16-1](#)
 - data dictionary views, [16-6](#)
 - deleting, [16-4](#)
 - encrypting sensitive information in, [16-1–16-6](#)
 - multitenant environment, [16-2](#)
 - procedure, [16-2](#)
 - protecting, [A-11](#)
 - rekeying, [16-3](#)
 - restoring lost keystore, [16-5](#)
 - data encryption and integrity parameters
 - about, [20-4](#)
 - data files, [A-11](#)
 - guidelines for security, [A-11](#)
 - data manipulation language (DML)
 - privileges controlling, [4-81](#)
 - data security
 - encryption, problems not solved by, [18-4](#)
 - database administrators (DBAs)
 - access, controlling, [18-3](#)
 - authentication, [3-52](#)
 - malicious, encryption not solved by, [18-3](#)
 - Database Configuration Assistant (DBCA)
 - default passwords, changing, [A-7](#)
 - user accounts, automatically locking and expiring, [A-3](#)
 - database links, [6-5](#)
 - application context support, [13-21](#)
 - application contexts, [13-13](#)
 - authenticating with Kerberos, [3-66](#)
 - definer's rights procedures, [9-22](#)
 - object privileges, [4-72](#)
 - operating system accounts, care needed, [3-65](#)
 - Oracle DBaaS-to-IAM connections, [7-37](#)
 - RADIUS not supported, [26-1](#)
 - database links (*continued*)
 - sensitive credential data
 - about, [16-1](#)
 - data dictionary views, [16-6](#)
 - deleting, [16-4](#)
 - encrypting, [16-2](#)
 - multitenant environment, [16-2](#)
 - rekeying, [16-3](#)
 - restoring functioning of after lost keystore, [16-5](#)
 - session-based application contexts,
 - accessing, [13-13](#)
 - database session-based application contexts, [13-6](#)
 - about, [13-6](#)
 - cleaning up after user exits, [13-6](#)
 - components, [13-7](#)
 - database links, [13-13](#)
 - dynamic SQL, [13-12](#)
 - externalized, using, [13-27](#)
 - how to use, [13-5](#)
 - initializing externally, [13-21](#)
 - initializing globally, [13-23](#)
 - ownership, [13-8](#)
 - parallel queries, [13-12](#)
 - PL/SQL package creation, [13-9](#)
 - session information, setting, [13-13](#)
 - SYS_CONTEXT function, [13-11](#)
 - trusted procedure, [13-2](#)
 - tutorial, [13-17](#)
 - See also* application contexts
 - database upgrades and CONNECT role, [A-26](#)
 - databases
 - access control
 - password encryption, [3-3](#)
 - additional security products, [1-3](#)
 - authentication, [3-57](#)
 - database user and application user, [12-2](#)
 - default password security settings, [3-9](#)
 - DBCA-created databases, [3-9](#)
 - manually-created databases, [3-9](#)
 - default security features, summary, [1-1](#)
 - granting privileges, [4-92](#)
 - granting roles, [4-92](#)
 - limitations on usage, [2-23](#)
 - schema-only accounts, [3-60](#)
 - security and schemas, [12-26](#)
 - security embedded, advantages of, [12-3](#)
 - security policies based on, [14-3](#)
 - DATAPUMP_EXP_FULL_DATABASE role, [4-40](#)
 - DATAPUMP_IMP_FULL_DATABASE role, [4-40](#)
 - DB_DEVELOPER_ROLE role
 - about, [4-40](#), [12-4](#)
 - DBA role
 - about, [4-40](#)

- DBA_CONTAINER_DATA data dictionary view, [4-32](#)
- DBA_ROLE_PRIVS view
 - application privileges, finding, [12-22](#)
- DBA_ROLES data dictionary view
 - PUBLIC role, [4-21](#)
- DBFS_ROLE role, [4-40](#)
- DBJAVASCRIPT role, [4-40](#)
- DBMS_CREDENTIAL package, [3-62](#), [4-66](#)
- DBMS_CREDENTIAL.CREATE_CREDENTIAL procedure, [12-18](#)
- DBMS_CRYPTO
 - FIPS-supported cipher suites, [C-5](#)
- DBMS_CRYPTO package
 - asymmetric key operations, [18-15](#)
 - data encryption storage, [18-9](#)
 - examples, [18-16](#)
 - supported cryptographic algorithms, [18-9](#)
- DBMS_CRYPTO PL/SQL package
 - enabling for FIPS 140-2, [C-8](#)
- DBMS_FGA package
 - about, [31-6](#)
 - DISABLE_POLICY procedure, [31-11](#)
 - DROP_POLICY procedure, [31-11](#)
 - editions, [31-5](#)
 - ENABLE_POLICY procedure, [31-10](#)
- DBMS_MDX_INTERNAL role, [4-40](#)
- DBMS_NETWORK_ACL_ADMIN.REMOVE_HOST_ACE procedure, [10-7](#)
- DBMS_PRIVILEGE_CAPTURE PL/SQL package, [5-5](#)
- DBMS_RLS.ADD_POLICY
 - sec_relevant_cols parameter, [14-12](#)
 - sec_relevant_cols_opt parameter, [14-15](#)
- DBMS_RLS.ADD_POLICY procedure
 - transparent sensitive data protection policies, [15-22](#)
- DBMS_SESSION package
 - client identifiers, using, [3-85](#)
 - global application context, used in, [13-31](#)
 - SET_CONTEXT procedure
 - about, [13-13](#)
- DBMS_SESSION.SET_CONTEXT procedure
 - about, [13-13](#)
 - syntax, [13-13](#)
 - username and client_id settings, [13-32](#)
- DBMS_SESSION.SET_IDENTIFIER procedure
 - client session ID, setting, [13-29](#)
 - DBMS_APPLICATION.SET_CLIENT_INFO value, overwritten by, [3-85](#)
- DbNest
 - about, [17-1](#)
 - architecture, [17-4](#)
 - configuration file, [17-5](#)
 - enabling, [17-7](#)
 - file system isolation for nest, [17-8](#)
- DbNest (*continued*)
 - how Oracle Database manages nest, [17-7](#)
 - initialization parameters, [17-5](#)
 - Linux namespaces, [17-2](#)
 - properties of, [17-3](#)
 - purpose of, [17-2](#)
- DBNEST_ENABLE initialization parameter, [17-5](#)
- DBNEST_PDB_FS_CONF initialization parameter, [17-5](#)
- DBSFUSER user account, [2-39](#)
- DBSNMP user account
 - about, [2-39](#)
 - password usage, [A-7](#)
- DDL
 - See data definition language
- debugging
 - Java stored procedures, [10-22](#)
 - PL/SQL stored procedures, [10-22](#)
- decryption
 - number strings using DBMS_CRYPTO, [18-21](#)
- default command rules
 - ORA_DV_DEFAULT_PROTECTION predefined audit policy for, [29-13](#)
- default passwords, [A-7](#)
 - change_on_install or manager passwords, [A-7](#)
 - changing, importance of, [3-6](#)
 - finding, [3-6](#)
- default permissions, [A-11](#)
- default profiles
 - about, [3-7](#)
- default realms
 - ORA_DV_DEFAULT_PROTECTION predefined audit policy for, [29-13](#)
- default roles
 - setting for user, [2-17](#)
 - specifying, [4-107](#)
- default users
 - accounts, [A-3](#)
 - Enterprise Manager accounts, [A-3](#)
 - passwords, [A-7](#)
- defaults
 - tablespace quota, [2-11](#)
 - user tablespaces, [2-9](#)
- definer's rights
 - about, [9-2](#)
 - code based access control
 - about, [9-11](#)
 - granting and revoking roles to program unit, [9-16](#)
 - how code based access control works, [9-14](#)
 - compared with invoker's rights, [9-1](#)
 - example of when to use, [9-2](#)
 - procedure privileges, used with, [9-2](#)
 - procedure security, [9-2](#)

- definer's rights (*continued*)
 - schema privileges for, [9-2](#)
 - secure application roles, [12-23](#)
 - used with Oracle Virtual Private Database functions, [14-4](#)
 - views, [9-9](#)
- definer's rights, database links
 - revokes of INHERIT [ANY] REMOTE PRIVILEGES, [9-24](#)
 - grants of INHERIT ANY REMOTE PRIVILEGES, [9-24](#)
 - grants of INHERIT ANY REMOTE PRIVILEGES on connected user to current user, example, [9-23](#)
 - grants of INHERIT REMOTE PRIVILEGES to other users, [9-23](#)
 - revoking INHERIT REMOTE PRIVILEGES from PUBLIC, example, [9-25](#)
 - revoking INHERIT REMOTE PRIVILEGES on connecting user from procedure owner, example, [9-25](#)
 - tutorial, [9-26](#)
- definers's rights, database links
 - about, [9-22](#)
 - ORA-25433 error, [9-22](#)
- denial of service (DoS) attacks
 - about, [8](#)
- denial-of-service (DoS) attacks
 - bad packets, preventing, [12-30](#)
 - networks, securing, [A-15](#)
 - password concurrent guesses, [3-3](#)
- Department of Defense Database Security
 - Technical Implementation Guide, [3-26](#), [3-27](#)
- DGPDB_INT user account, [2-39](#)
- DGPDB_ROLE role, [4-40](#)
- diagnostics
 - DIAGNOSTICS_CONTROL initialization parameter, [4-28](#)
 - restricting use to SYSDBA and ENABLE DIAGNOSTICS, [4-28](#)
- dictionary privileges
 - about, [4-79](#)
- dictionary protection
 - disabling for Oracle-maintained schema, [4-80](#)
 - enabling for Oracle-maintained schema, [4-80](#)
- dictionary tables
 - auditing, [30-13](#)
- Diffie-Hellman key negotiation algorithm, [20-7](#)
- DIP user account, [2-42](#)
- direct path load
 - fine-grained auditing effects on, [31-2](#)
- directories
 - auditing, [30-11](#)
- directory authentication, configuring for SYSDBA or SYSOPER access, [3-53](#)
- directory objects
 - granting EXECUTE privilege on, [4-93](#)
- disabling unnecessary services
 - FTP, TFTP, TELNET, [A-15](#)
- dispatcher processes (Dnnn)
 - limiting SGA space for each session, [2-25](#)
- distributed databases
 - auditing and, [28-10](#)
- DML
 - See data manipulation language
- driving context, [13-54](#)
- DROP PROFILE statement
 - example, [2-29](#)
- DROP ROLE statement
 - example, [4-55](#)
 - security domain, affected, [4-55](#)
- DROP USER statement
 - about, [2-37](#)
 - schema objects of dropped user, [2-38](#)
- dsi.ora file
 - about, [6-11](#)
 - changing contents of, [6-11](#)
 - CMU_WALLET database property, [6-11](#)
 - compared with ldap.ora, [6-10](#)
 - multitenant environment, [6-11](#)
 - placement of, [6-11](#)
 - search order for, [6-11](#)
 - WALLET_LOCATION parameter and, [6-11](#)
 - when to use, [6-11](#)
- DV_role, [4-40](#)
- DV_ACCTMGR role, [4-40](#)
- DV_ADMIN role, [4-40](#)
- DV_AUDIT_CLEANUP role, [4-40](#)
- DV_DATAPUMP_NETWORK_LINK role, [4-40](#)
- DV_GOLDENGATE_ADMIN role, [4-40](#)
- DV_GOLDENGATE_REDO_ACCESS role, [4-40](#)
- DV_MONITOR role, [4-40](#)
- DV_OWNER role, [4-40](#)
- DV_PATCH_ADMIN role, [4-40](#)
- DV_POLICY_OWNER role, [4-40](#)
- DV_SECANALYST role, [4-40](#)
- DV_STREAMS_ADMIN role, [4-40](#)
- DV_XSTREAMS_ADMIN role, [4-40](#)
- DVF schema
 - ORA_DV_SCHEMA_CHANGES predefined audit policy for, [29-13](#)
- DVSYS schema
 - ORA_DV_SCHEMA_CHANGES predefined audit policy for, [29-13](#)
- dynamic Oracle Virtual Private Database policy types, [14-20](#)
- DYNAMIC policy type, [14-20](#)

E

editions

- application contexts, how affects, [13-3](#)
- fine-grained auditing packages, results in, [13-32](#)
- global application contexts, how affects, [13-32](#)
- Oracle Virtual Private Database packages, results in, [13-32](#)

EJBCLIENT role, [4-40](#)

email alert example, [31-12](#)

enable_fips.py script, [C-4](#)

encrypting information in, [16-1](#)

encryption

- access control, [18-2](#)
- BLOBS, [18-8](#)
- challenges, [18-4](#)
- data security, problems not solved by, [18-4](#)
- data transfer, [A-15](#)
- deleted encrypted data, [A-11](#)
- examples, [18-16](#)
- indexed data, [18-4](#)
- key generation, [18-5](#)
- key storage, [18-6](#)
- key transmission, [18-5](#)
- keys, changing, [18-8](#)
- malicious database administrators, [18-3](#)
- network encryption, [20-7](#)
- network traffic, [A-15](#)
- number strings using DBMS_CRYPTO, [18-21](#)
- on-demand encryption, [18-1](#)
- problems not solved by, [18-2](#)
- Transparent Data Encryption, [18-8](#)
- transparent tablespace encryption, [18-8](#)

encryption and checksumming

- activating, [20-8](#)
- negotiating, [20-9](#)
- parameter settings, [20-11](#)

encryption of data dictionary sensitive data, [16-1](#)

ENFORCE_CREDENTIAL configuration

- parameter
- security guideline, [A-20](#)

enterprise directory service, [4-53](#)

enterprise roles, [4-53](#)

enterprise user management, [12-2](#)

Enterprise User Security

- application context, globally initialized, [13-25](#)
- proxy authentication
 - Oracle Virtual Private Database, how it works with, [14-52](#)

enterprise users

- global role, creating, [4-53](#)
- One Big Application User authentication, compromised by, [12-2](#)
- proxy authentication, [3-73](#)
- shared schemas, protecting users, [12-27](#)

error messages

- ORA-12650, [20-8](#), [20-10](#)
- ORA-25433, [9-22](#)

errors

- ORA-00036, [31-7](#)
- ORA-01720, [4-82](#)
- ORA-01994, [2-21](#)
- ORA-06512, [10-22](#), [31-16](#)
- ORA-06598, [9-6](#)
- ORA-1000, [31-7](#)
- ORA-1536, [2-11](#)
- ORA-24247, [10-3](#), [10-22](#), [31-16](#)
- ORA-28017, [2-21](#)
- ORA-28040, [3-37](#), [3-57](#)
- ORA-28046, [2-21](#)
- ORA-28144, [31-7](#)
- ORA-28575, [12-18](#)
- ORA-45622, [15-12](#)

example, basic, [30-22](#)

example, comparison, [30-23](#)

examples, [13-17](#), [14-27](#)

access control lists

- external network connections, [10-14](#)
- wallet access, [10-14](#)

account locking, [3-11](#)

audit trail, purging unified trail, [32-24](#)

auditing GRANT operations, [30-13](#)

auditing REVOKE operations, [30-13](#)

auditing user SYS, [30-8](#)

data encryption

- encrypting and decrypting BLOB data, [18-17](#)
- encrypting and decrypting procedure with AES 256-Bit, [18-17](#)

decrypting a number using DBMS_CRYPTO, [18-21](#)

directory objects, granting EXECUTE privilege on, [4-93](#)

encrypting a number using DBMS_CRYPTO, [18-21](#)

encrypting procedure, [18-16](#)

Java code to read passwords, [12-11](#)

locking an account with CREATE PROFILE, [3-11](#)

login attempt grace period, [3-13](#)

nondatabase user authentication, [13-36](#)

passwords

- aging and expiration, [3-13](#)
- changing, [2-19](#)
- creating for user, [2-9](#)

privileges

- granting ADMIN OPTION, [4-93](#)
- views, [4-110](#)

procedure privileges affecting packages, [4-86](#)

profiles, assigning to user, [2-13](#)

examples (*continued*)

roles

- altering for external authorization, [4-51](#)
- creating for application authorization, [4-52](#)
- creating for external authorization, [4-52](#)
- creating for password authorization, [4-49](#), [4-50](#)

default, setting, [4-107](#)

external, [4-50](#)

global, [4-50](#)

using SET ROLE for password-authenticated roles, [4-51](#)

views, [4-110](#)

secure external password store, [3-42](#)

session ID of user

finding, [2-37](#)

system privilege and role, granting, [4-93](#)

tablespaces

assigning default to user, [2-10](#)

quota, assigning to user, [2-11](#)

temporary, [2-13](#)

type creation, [4-89](#)

users

account creation, [2-6](#)

creating with GRANT statement, [4-93](#)

dropping, [2-38](#)

middle-tier server proxying a client, [3-75](#)

object privileges granted to, [4-94](#)

proxy user, connecting as, [3-75](#)

See also tutorials

exceptions

WHEN NO DATA FOUND, used in application context package, [13-18](#)

WHEN OTHERS, used in triggers

development environment (debugging) example, [13-16](#)

production environment example, [13-16](#)

Exclusive Mode

SHA-2 password hashing algorithm, enabling, [3-35](#)

EXECUTE ANY LIBRARY statement

security guidelines, [A-3](#)

EXECUTE_CATALOG_ROLE role

SYS schema objects, enabling access to, [4-20](#)

EXEMPT ACCESS POLICY privilege

Oracle Virtual Private Database enforcements, exemption, [14-47](#)

EXP_FULL_DATABASE role

about, [4-40](#)

expiring a password

explicitly, [3-13](#)

exporting data

direct path export impact on Oracle Virtual Private Database, [14-47](#)

policy enforcement, [14-47](#)

extended data objects

views and Virtual Private Database, [14-10](#)

external network services

enabling listener for, [10-6](#)

external network services, fine-grained access to
See access control list (ACL)

external network services, syntax for, [10-4](#)

external procedures

configuring extproc process for, [12-18](#)

credentials, [12-16](#)

DBMS_CREDENTIAL.CREATE_CREDENTIAL procedure, [12-18](#)

legacy applications, [12-19](#)

security guideline, [A-20](#)

external roles, [4-50](#)external tables, [A-11](#)

extproc process

about, [12-16](#)

configuring credential for, [12-18](#)

legacy applications, [12-19](#)

F

failed login attempts

account locking, [3-10](#)

password management, [3-10](#)

resetting, [3-10](#)

fallback authentication, Kerberos, [24-28](#)

Federal Information Processing Standard (FIPS)

DBMS_CRYPTO package, [C-8](#)

FIPS 140-2

postinstallation checks, [C-10](#)

SQLNET.FIPS_140, [C-9](#)

SSLFIPS_140, [C-9](#)

SSLFIPS_LIB, [C-9](#)

verifying connections for

DBMS_CRYPTO, [C-11](#)

verifying connections for network native encryption, [C-11](#)

verifying connections for TLS, [C-11](#)

verifying connections when using FIPS_140 parameter, [C-10](#)

Transparent Data Encryption, [C-8](#)

files

BFILES

operating system access, restricting, [A-11](#)

BLOB, [18-8](#)

keys, [18-7](#)

listener.ora file

guidelines for security, [A-15](#), [A-19](#)

restrict listener access, [A-15](#)

server.key encryption file, [A-19](#)

symbolic links, restricting, [A-11](#)

tnsnames.ora, [A-19](#)

fine grained auditing
 Data Redaction
 schema system privileges, [4-26](#)
 schema system privileges, [4-26](#)
 fine-grained access control
 See Oracle Virtual Private Database (VPD)
 fine-grained auditing
 about, [31-2](#)
 alerts, adding to policy, [31-12](#)
 archiving audit trail, [32-11](#)
 columns, specific, [31-10](#)
 direct loads of data, [31-2](#)
 edition-based redefinitions, [31-5](#)
 editions, results in, [13-32](#)
 finding errors by checking trace files, [29-17](#),
 [31-18](#)
 how audit records are generated, [31-3](#)
 how to use, [31-2](#)
 policies
 adding, [31-6](#)
 disabling, [31-11](#)
 dropping, [31-11](#)
 enabling, [31-10](#)
 modifying, [31-6](#)
 policy creation syntax, [31-7](#)
 privileges required, [31-3](#)
 records
 archiving, [32-11](#)
 transparent sensitive data protection policy
 settings, [15-31](#)
 TSDP policies and, [15-30](#)
 VPD predicates, [31-4](#)

FIPS
 weaker deprecated algorithm keys, [C-12](#)

FIPS 140-2
 approved DBMS_CRYPTO cipher suites, [C-5](#)
 approved network native encryption
 algorithms, [C-7](#)
 approved TDE algorithms, [C-4](#)
 approved TLS cipher suites, [C-6](#)

FIPS 140-2 cryptographic libraries
 about, [C-1](#)

FIPS_140 parameter
 about, [C-3](#), [C-8](#)
 DBMS_CRYPTO, [C-3](#), [C-8](#)
 Java applications, enabling in, [C-4](#)
 Java applications, enabling using orapki and
 java.security file, [C-4](#)
 network native encryption, [C-3](#), [C-8](#)
 TDE, [C-3](#), [C-8](#)
 TLS, [C-3](#)
 Transport Layer Security, [C-8](#)

fips.ora file, [C-3](#), [C-9](#)

firewalls
 advice about using, [A-15](#)
 database server location, [A-15](#)

firewalls (*continued*)
 ports, [A-19](#)
 supported types, [A-15](#)

flashback query
 Oracle Virtual Private Database, how it works
 with, [14-46](#)

forcetcp parameter in krb5.conf, [24-15](#)

foreign keys
 privilege to use parent key, [4-81](#)

FTP protocol messages, auditing, [30-75](#)

FTP service, [A-15](#)

functions
 auditing, [30-11](#), [30-16](#)
 granting roles to, [4-55](#)
 Oracle Virtual Private Database
 components of, [14-6](#)
 privileges used to run, [14-4](#)
 privileges for, [4-84](#)
 roles, [4-38](#)

G

GATHER_SYSTEM_STATISTICS role, [4-40](#)

GDS_CATALOG_SELECT role, [4-40](#)

global application contexts, [13-28](#)
 about, [13-28](#)
 authenticating nondatabase users, [13-36](#)
 checking values set globally for all users,
 [13-34](#)
 clearing values set globally for all users,
 [13-34](#)
 components, [13-29](#)
 editions, affect on, [13-32](#)
 example of authenticating nondatabase users,
 [13-37](#)
 example of authenticating user moving to
 different application, [13-35](#)
 example of setting values for all users, [13-34](#)
 Oracle RAC environment, [13-30](#)
 Oracle RAC instances, [13-28](#)
 ownership, [13-30](#)
 PL/SQL package creation, [13-31](#)
 process, lightweight users, [13-49](#)
 process, standard, [13-48](#)
 sharing values globally for all users, [13-33](#)
 system global area, [13-28](#)
 tutorial for client session IDs, [13-44](#)
 used for One Big Application User scenarios,
 [14-52](#)
 uses for, [14-52](#)
 See also application contexts

global authorization
 role creation, [4-53](#)

global roles, [4-50](#)
 about, [4-53](#)

GLOBAL_AQ_USER_ROLE role, [4-40](#)

GLOBAL_EXTPROC_CREDENTIAL
 configuration parameter
 security guideline, [12-19](#)

grace period for login attempts
 example, [3-13](#)

grace period for password expiration, [3-13](#)

gradual database password rollover
 about, [3-17](#)
 actions permitted during, [3-22](#)
 changing password during rollover period,
[3-21](#)
 changing password to begin rollover period,
[3-20](#)
 enabling, [3-19](#)
 finding users who use old passwords, [3-24](#)
 manually ending the password before rollover
 period, [3-22](#)
 Oracle Data Guard, [3-24](#)
 Oracle Data Pump exports, [3-24](#)
 password change life cycle, [3-18](#)
 passwords, compromised, [3-23](#)
 server behavior after rollover ends, [3-23](#)

GRANT ALL PRIVILEGES statement
 SELECT ANY DICTIONARY privilege,
 exclusion of, [A-11](#)

GRANT ANY PRIVILEGE system privilege, [4-19](#)

GRANT CONNECT THROUGH clause
 consideration when setting
 FAILED_LOGIN_ATTEMPTS
 parameter, [3-7](#)
 for proxy authorization, [3-75](#)

GRANT statement, [4-92](#)
 ADMIN OPTION, [4-93](#)
 creating a new user, [4-93](#)
 object privileges, [4-94](#), [12-28](#)
 system privileges and roles, [4-92](#)
 when takes effect, [4-106](#)
 WITH GRANT OPTION, [4-95](#)

granting privileges and roles
 about, [4-21](#)
 specifying ALL, [4-74](#)

GRAPH_ADMINISTRATOR role, [4-40](#)

GRAPH_DEVELOPER role, [4-40](#)

GRAPH_USER role, [4-40](#)

GSM_OGG_CAPTURE role, [4-40](#)

GSM_POOLADMIN_ROLE role, [4-40](#)

GSMADMIN_ROLE role, [4-40](#)

GSMCATUSER_ROLE role, [4-40](#)

GSMROOTUSER user account, [2-39](#)

GSMROOTUSER_ROLE role, [4-40](#)

GSMUSER_ROLE role, [4-40](#)

guidelines
 handling compromised passwords, [3-23](#)

guidelines for security
 auditing, [A-20](#)
 custom installation, [A-13](#)

guidelines for security (*continued*)
 data files and directories, [A-11](#)
 encrypting sensitive data, [A-11](#)
 guidelines for security
 custom installation, [A-13](#)
 installation and configuration, [A-13](#)
 networking security, [A-14](#)
 operating system accounts, limiting privileges,
[A-11](#)
 operating system users, limiting number of,
[A-11](#)

Oracle home default permissions, disallowing
 modification, [A-11](#)

ORACLE_DATAPUMP access driver, [A-12](#)

passwords, [A-7](#)

PDBs, [A-14](#)

products and options
 install only as necessary, [A-13](#)

sample schemas, [A-13](#)

Sample Schemas
 remove or relock for production, [A-13](#)
 test database, [A-13](#)

symbolic links, restricting, [A-11](#)

Transport Layer Security
 mode, [A-19](#)
 TCPS protocol, [A-19](#)

user accounts and privileges, [A-3](#)

Windows installations, [A-10](#)

H

hackers
 See security attacks

how it works, [6-3](#)

HS_ADMIN_EXECUTE_ROLE role
 about, [4-40](#)

HS_ADMIN_ROLE role
 about, [4-40](#)

HS_ADMIN_SELECT_ROLE role
 about, [4-40](#)

HTTP authentication
 See access control lists (ACL), wallet access

HTTP protocol messages, auditing, [30-75](#)

HTTP verifier removal, [A-7](#)

HTTPS
 port, correct running on, [A-19](#)

I

IMP_FULL_DATABASE role
 about, [4-40](#)

inactive user accounts, locking automatically, [3-9](#)

INACTIVE_ACCOUNT_TIME profile parameter,
[3-9](#)

indexed data
 encryption, [18-4](#)

- indirectly granted roles, [4-35](#)
 - INHERIT ANY PRIVILEGES privilege
 - about, [9-6](#)
 - managing, [9-8](#)
 - revoking from powerful users, [9-7](#)
 - when it should be granted, [9-7](#)
 - INHERIT ANY REMOTE PRIVILEGES, [9-22](#)
 - INHERIT PRIVILEGES privilege
 - about, [9-6](#)
 - auditing, [9-8](#)
 - managing, [9-8](#)
 - when it should be granted, [9-6](#)
 - INHERIT REMOTE PRIVILEGES
 - about, [9-22](#)
 - initial ticket, defined, [24-17](#)
 - initialization parameter file
 - parameters for clients and servers using Kerberos, [24-5](#)
 - parameters for clients and servers using RADIUS, [26-7](#)
 - initialization parameters
 - application protection, [12-29](#)
 - MAX_ENABLED_ROLES, [4-107](#)
 - OS_ROLES, [4-53](#)
 - SEC_MAX_FAILED_LOGIN_ATTEMPTS, [12-31](#)
 - SEC_RETURN_SERVER_RELEASE_BANNER, [12-32](#)
 - SEC_USER_AUDIT_ACTION_BANNER, [12-32](#)
 - SEC_USER_UNAUTHORIZED_ACCESS_BANNER, [12-32](#)
 - INSERT privilege
 - granting, [4-97](#)
 - revoking, [4-100](#)
 - installation
 - guidelines for security, [A-13](#)
 - intruders
 - See security attacks
 - invoker's rights
 - about, [9-3](#)
 - code based access control
 - about, [9-11](#)
 - granting and revoking roles to program unit, [9-16](#)
 - how code based access control works, [9-12](#)
 - tutorial, [9-17](#)
 - compared with definer's rights, [9-1](#)
 - controlled step-in, [9-3](#)
 - procedure privileges, used with, [9-2](#)
 - procedure security, [9-3](#)
 - secure application roles, [12-23](#)
 - secure application roles, requirement for enabling, [12-23](#)
 - security risk, [9-5](#)
 - views
 - about, [9-9](#)
 - invoker's rights (*continued*)
 - views (*continued*)
 - finding user who invoked invoker's right view, [9-10](#)
 - IP addresses
 - falsifying, [A-15](#)
- ## J
-
- Java Debug Wire Protocol (JDWP)
 - network access for debugging operations, [10-22](#)
 - Java schema objects
 - auditing, [30-11](#)
 - Java stored procedures
 - network access for debugging operations, [10-22](#)
 - JAVA_ADMIN role, [4-40](#)
 - JAVA_RESTRICT initialization parameter
 - security guideline, [A-11](#)
 - java.security file, [C-4](#)
 - JVADEBUGPRIV role, [4-40](#)
 - JVAIDPRIV role, [4-40](#)
 - JAVASYSPRIV role, [4-40](#)
 - JVAUSERPRIV role, [4-40](#)
 - JDBC connections
 - JDBC Thin Driver proxy authentication
 - configuring, [3-73](#)
 - with real user, [3-77](#)
 - JDBC/OCI proxy authentication, [3-73](#)
 - multiple user sessions, [3-77](#)
 - Oracle Virtual Private Database, [14-52](#)
 - JDeveloper
 - debugging using Java Debug Wire Protocol, [10-22](#)
 - JMXSERVER role, [4-40](#)
- ## K
-
- Kerberos, [22-4](#)
 - authentication adapter utilities, [24-17](#)
 - authentication fallback behavior, [24-28](#)
 - authentication in Oracle Database, [24-6](#)
 - components, [24-2](#)
 - configuring authentication, [24-8](#), [24-12](#)
 - configuring for database server, [24-10](#)
 - configuring for Windows Server Domain Controller KDC, [24-22](#)
 - connecting to database, [24-21](#)
 - how Oracle Database works with, [24-5](#)
 - interoperability with Windows Server Domain Controller KDC, [24-22](#)
 - Kerberos server (KDC), [24-4](#)
 - kinstance, [24-10](#)
 - kservice, [24-10](#)
 - Oracle Database parameters, [24-5](#)

- Kerberos (*continued*)
 - realm, [24-10](#)
 - sqlnet.ora file sample, [20-5](#)
 - system requirements, [22-7](#)
 - tickets
 - client service ticket, [24-4](#)
 - client ticket granting ticket, [24-2](#)
 - Kerberos authentication, [3-66](#)
 - configuring for SYSDBA or SYSOPER
 - access, [3-54](#)
 - password management, [A-7](#)
 - Kerberos Key Distribution Center (KDC), [24-22](#)
 - key generation
 - encryption, [18-5](#)
 - key storage
 - encryption, [18-6](#)
 - key transmission
 - encryption, [18-5](#)
 - kinstance (Kerberos), [24-10](#)
 - krb5.conf
 - configuring TCP or UDP connection, [24-15](#)
 - kservice (Kerberos), [24-10](#)
- ## L
-
- large objects (LOBs)
 - about securing, [12-20](#)
 - encryption management, [12-20](#)
 - LBAC_DBA role, [4-40](#)
 - LBACSYS schema
 - ORA_DV_SCHEMA_CHANGES predefined
 - audit policy for, [29-13](#)
 - LBACSYS user account, [2-39](#)
 - LBACSYS.ORA_GET_AUDITED_LABEL function
 - about, [30-70](#)
 - ldap.ora
 - which directory SSL port to use for no
 - authentication, [21-47](#)
 - ldap.ora file
 - about, [6-15](#)
 - benefit of, [6-15](#)
 - changing contents of, [6-15](#)
 - compared with dsi.ora, [6-10](#)
 - creating for Microsoft Active Directory
 - services, [6-13](#), [6-16](#)
 - placement of, [6-15](#)
 - search order for, [6-15](#)
 - least privilege principle, [A-3](#)
 - about, [A-3](#)
 - granting user privileges, [A-3](#)
 - middle-tier privileges, [3-78](#)
 - libraries
 - auditing, [30-11](#)
 - lightweight users
 - example using a global application context,
 - [13-44](#)
 - lightweight users (*continued*)
 - Lightweight Directory Access Protocol
 - (LDAP), [14-36](#)
 - listener
 - not an Oracle owner, [A-15](#)
 - preventing online administration, [A-15](#)
 - restrict privileges, [A-15](#)
 - secure administration, [A-15](#)
 - listener.ora file
 - administering remotely, [A-15](#)
 - default location, [A-19](#)
 - online administration, preventing, [A-15](#)
 - TCPS, securing, [A-19](#)
 - lists data dictionary
 - data dictionary views
 - See views
 - granting privileges and roles
 - finding information about, [4-110](#)
 - privileges, [4-18](#)
 - finding information about, [4-110](#)
 - roles, [12-23](#)
 - finding information about, [4-110](#)
 - views, [4-110](#)
 - privileges, [4-82](#), [4-110](#)
 - roles, [4-110](#)
 - LOB_SIGNATURE_ENABLE initialization
 - parameter, [12-20](#)
 - LOBs
 - about securing, [12-20](#)
 - encryption management, [12-20](#)
 - local privilege grants
 - about, [4-29](#)
 - granting, [4-31](#)
 - revoking, [4-31](#)
 - local privileges
 - granting, [4-5](#)
 - local roles, [4-5](#), [4-62](#)
 - about, [4-59](#)
 - creating, [4-62](#)
 - granting, [4-5](#)
 - rules for creating, [4-61](#)
 - local user accounts
 - creating, [2-16](#)
 - local users
 - about, [2-5](#)
 - lock and expire
 - default accounts, [A-3](#)
 - predefined user accounts, [A-3](#)
 - lockdown profiles
 - example, [4-64](#)
 - lockdown profiles, PDB, [4-64](#)
 - locking inactive user accounts automatically, [3-9](#)
 - log files
 - owned by trusted user, [A-11](#)
 - logical reads limit, [2-24](#)

logon triggers
 externally initialized application contexts,
[13-15](#)
 for application context packages, [13-15](#)
 running database session application context
 package, [13-15](#)
 secure application roles, [4-57](#)
 LOGSTDBY_ADMINISTRATOR role, [4-40](#)

M

malicious database administrators, [18-3](#)
See also security attacks
 manager default password, [A-7](#)
 managing roles with RADIUS server, [26-19](#)
 materialized views
 auditing, [30-11](#)
 MD5 message digest algorithm, [20-6](#)
 MDDATA user account, [2-42](#)
 MDSYS user account, [2-39](#)
 memory
 users, viewing, [2-46](#)
 MERGE INTO statement, affected by
 DBMS_RLS.ADD_POLICY
 statement_types parameter, [14-11](#)
 metadata links
 privilege management, [4-77](#)
 methods
 privileges on, [4-87](#)
 Microsoft Active Directory services, [6-3](#), [6-4](#), [6-6](#),
[6-7](#), [6-16](#), [6-19](#), [6-20](#)
 about configuring connection, [6-19](#)
 about password authentication, [6-24](#)
 access configuration, Oracle wallet
 verification, [6-22](#)
 access configuration, testing integration, [6-23](#)
 access, Kerberos authentication, [6-29](#)
 access, PKI authentication, [6-30](#)
 account policies, [6-38](#)
 administrative user configuration, exclusive
 mapping, [6-34](#)
 administrative user configuration, shared
 access accounts, [6-34](#)
 dsi.ora file, about, [6-11](#)
 dsi.ora file, compared with ldap.ora, [6-10](#)
 extending Active Directory schema, [6-8](#)
 ldap.ora file, about, [6-15](#)
 ldap.ora file, compared with dsi.ora, [6-10](#)
 ldap.ora file, creating, [6-13](#), [6-16](#)
 logon user name with password
 authentication, [6-27](#)
 multitenant users, how affected, [6-5](#)
 user authorization, about, [6-31](#)
 user authorization, mapping Directory user
 group to global role, [6-32](#)
 user authorization, verifying, [6-35](#)

Microsoft Active Directory services (*continued*)
 user management, altering mapping
 definition, [6-33](#)
 user management, exclusively mapping
 Directory user to database global
 user, [6-33](#)
 user management, mapping group to shared
 global user, [6-32](#)
 user management, migrating mapping
 definition, [6-33](#)
 Microsoft Active Directory services integration,
[6-2](#), [6-3](#), [6-5](#)
 Microsoft Active Directory services proxy
 authentication, [6-29](#)
 about, [6-28](#)
 configuring, [6-28](#)
 Microsoft Directory Access services, [6-22](#)
 Microsoft Entra ID token
 checking version of, [8-48](#)
 Microsoft Windows
 Kerberos
 configuring for Windows Server Domain
 Controller KDC, [24-22](#)
 middle-tier systems
 client identifiers, [3-82](#)
 enterprise user connections, [3-81](#)
 password-based proxy authentication, [3-80](#)
 privileges, limiting, [3-78](#)
 proxies authenticating users, [3-79](#)
 proxying but not authenticating users, [3-79](#)
 reauthenticating user to database, [3-80](#)
 USERENV namespace attributes, accessing,
[13-22](#)
 mining models
 auditing, [30-11](#)
 mkstore utility
 create command, [B-48](#)
 createALO command, [B-49](#)
 createCredential command, [B-49](#)
 createEntry command, [B-50](#)
 createUserCredential command, [B-50](#)
 delete command, [B-51](#)
 deleteCredential command, [B-51](#)
 deleteEntry command, [B-52](#)
 deleteSSO command, [B-52](#)
 deleteUserCredential command, [B-53](#)
 list command, [B-53](#)
 listCredential command, [B-54](#)
 modifyCredential command, [B-54](#)
 modifyEntry command, [B-55](#)
 modifyUserCredential command, [B-55](#)
 SQL*Loader object store credentials, [3-47](#)
 viewEntry command, [B-56](#)
 monitoring user actions, [28-1](#)
See also auditing, standard auditing, fine-
 grained auditing

multiplex multiple-client network sessions, [A-15](#)
 multitenant container database (CDB)
 See CDBs
 multitenant option
 centrally managed users, how affected, [6-5](#)
 My Oracle Support, [A-2](#)
 security patches, downloading, [A-2](#)
 user account for logging service requests,
 [2-42](#)

N

native network encryption
 checking if enabled in current session, [20-16](#)
 compared with Transport Layer Security, [20-2](#)
 FIPS library location setting (SSLFIPS_LIB),
 [C-9](#)
 FIPS mode setting (FIPS_140), [C-9](#)
 troubleshooting, [20-16](#)
 native network encryption and integrity
 how it works, [20-2](#)
 native network encryption
 disabling, [27-2](#)
 Net8
 See Oracle Net
 network authentication
 guidelines for securing, [A-7](#)
 roles, granting using, [4-103](#)
 smart cards, [A-7](#)
 token cards, [A-7](#)
 X.509 certificates, [A-7](#)
 network connections
 denial-of-service (DoS) attacks, addressing,
 [A-15](#)
 guidelines for security, [A-14](#), [A-15](#)
 securing, [A-15](#)
 network encryption
 about, [20-7](#)
 configuring, [20-7](#)
 troubleshooting, [20-16](#)
 network IP addresses
 guidelines for security, [A-15](#)
 network native encryption
 FIPS-supported algorithms, [C-7](#)
 network traffic encryption, [A-15](#)
 nondatabase users, [13-28](#), [13-29](#)
 about, [13-29](#)
 auditing, [30-88](#)
 clearing session data, [13-39](#)
 creating client session-based application
 contexts, [13-52](#)
 global application contexts
 package example, [13-37](#)
 reason for using, [13-29](#)
 setting, [13-36](#)
 tutorial, [13-44](#)

nondatabase users (*continued*)
 One Big Application User authentication
 about, [14-52](#)
 features compromised by, [12-2](#)
 security risks, [12-2](#)
 Oracle Virtual Private Database
 how it works with, [14-52](#)
 tutorial for creating a policy group, [14-38](#)
 See also application contexts, client identifiers

O

object privileges, [4-72](#), [A-3](#)
 about, [4-72](#)
 granting on behalf of the owner, [4-95](#)
 managing, [12-27](#)
 revoking, [4-98](#)
 revoking on behalf of owner, [4-99](#)
 schema object privileges, [4-72](#)
 synonyms, [4-75](#)
 with common privilege grants, [4-30](#)
 See also schema object privileges
 object types
 auditing, [30-11](#)
 objects
 applications, managing privileges in, [12-27](#)
 granting privileges, [12-28](#)
 privileges
 applications, [12-28](#)
 managing, [4-87](#)
 protecting in shared schemas, [12-27](#)
 protecting in unique schemas, [12-26](#)
 SYS schema, access to, [4-20](#)
 OEM_ADVISOR role, [4-40](#)
 OEM_MONITOR role, [4-40](#)
 OGG_APPLY role, [4-40](#)
 OGG_APPLY_PROCREP role, [4-40](#)
 OGG_SHARED_CAPTURE role, [4-40](#)
 OJVMSYS user account, [2-39](#)
 okcreate
 Kerberos adapter utility, [24-17](#)
 okcreate options, [24-21](#)
 okdstry
 Kerberos adapter utility, [24-17](#)
 okdstry options, [24-20](#)
 okinit
 Kerberos adapter utility, [24-17](#)
 okinit utility options, [24-18](#)
 oklist
 Kerberos adapter utility, [24-17](#)
 OLAPSYS user account, [2-39](#)
 One Big Application User authentication
 See nondatabase users
 operating system
 audit files written to, [32-7](#)

- operating system users
 - configuring for PDBs, [3-62](#)
 - setting default credential, [3-63](#)
- operating systems, [3-62](#)
 - accounts, [4-104](#)
 - authentication
 - about, [3-65](#)
 - advantages, [3-65](#)
 - disadvantages, [3-65](#)
 - operating system user for PDB, [3-62](#)
 - roles, using, [4-103](#)
 - default permissions, [A-11](#)
 - enabling and disabling roles, [4-105](#)
 - operating system account privileges, limiting, [A-11](#)
 - role identification, [4-104](#)
 - roles and, [4-40](#)
 - roles, granting using, [4-103](#)
 - users, limiting number of, [A-11](#)
- OPTIMIZER_PROCESSING_RATE role, [4-40](#)
- ORA_ACCOUNT_MGMT predefined unified audit policy, [29-7](#)
- ORA_ALL_TOPLEVEL_ACTIONS predefined unified audit policy, [29-10](#)
- ORA_CIS_RECOMMENDATIONS predefined unified audit policy, [29-8](#)
- ORA_DATABASE_PARAMETER predefined unified audit policy, [29-7](#)
- ORA_DV_DEFAULT_PROTECTION predefined unified audit policy, [29-13](#)
- ORA_DV_SCHEMA_CHANGES predefined unified audit policy, [29-13](#)
- ORA_LOGIN_LOGOUT predefined unified audit policy, [29-10](#)
- ORA_OLS_SCHEMA_CHANGES predefined unified audit policy, [29-14](#)
- ORA_SECURECONFIG predefined unified audit policy, [29-6](#)
- ORA_STIG_PROFILE profile, [3-26](#)
- ORA_STIG_RECOMMENDATIONS predefined unified audit policy, [29-9](#)
- ORA-01017 errors in Oracle Cloud Infrastructure-IAM integration, [7-41](#)
- ORA-01017 errors in Oracle DBaaS-IAM integration
 - client-side, [7-38](#)
 - IAM administrator actions to remedy, [7-43](#)
 - IAM user configurations, [7-42](#)
- ORA-01720 error, [4-82](#)
- ORA-01741 error, [31-6](#)
- ORA-01994, [2-21](#)
- ORA-03114 error, [7-43](#), [8-47](#)
- ORA-06512 error, [10-22](#), [31-16](#)
- ORA-06598 error, [9-6](#)
- ORA-12008 error, [31-6](#)
- ORA-12599 error, [7-43](#), [8-47](#)
- ORA-1536 error, [2-11](#)
- ORA-24247 error, [10-3](#), [10-22](#), [31-16](#)
- ORA-28017 error, [2-21](#)
- ORA-28040 error, [3-37](#), [3-57](#)
- ORA-28046 error, [2-21](#)
- ORA-28575 error, [12-18](#)
- ORA-29024 error, [10-13](#)
- ORA-45622 errors, [15-12](#)
- ORA-64219: invalid LOB locator encountered, [12-20](#)
- ORA\$DEPENDENCY profile, [5-4](#)
- ORA\$DICTIONARY_SENS_COL_ACCESS predefined unified audit policy, [29-11](#)
- Oracle Advanced Security
 - checksum sample for sqlnet.ora file, [20-5](#)
 - encryption sample for sqlnet.ora file, [20-5](#)
 - network authentication services, [A-7](#)
 - TLS features, [25-1](#)
 - user access to application schemas, [12-27](#)
- Oracle Audit Vault and Database Firewall
 - schema-only accounts, [3-60](#)
- Oracle Autonomous Database
 - centrally managed users, [6-38](#)
- Oracle Call Interface (OCI)
 - application contexts, client session-based, [13-52](#)
 - proxy authentication, [3-73](#)
 - Oracle Virtual Private Database, how it works with, [14-52](#)
 - proxy authentication with real user, [3-77](#)
 - security-related initialization parameters, [12-29](#)
- Oracle Connection Manager
 - securing client networks with, [A-15](#)
- Oracle Data Guard
 - gradual database password rollover, [3-24](#)
 - SYSDG administrative privilege, [4-16](#)
- Oracle Data Pump
 - audit events, [30-71](#)
 - exported data from VPD policies, [14-48](#)
 - exports during gradual database password rollover, [3-24](#)
 - unified audit trail, [32-9](#)
- Oracle Database Enterprise User Security
 - password security threats, [3-34](#)
- Oracle Database Real Application Clusters
 - archive timestamp for audit records, [32-15](#)
 - global contexts, [13-28](#)
- Oracle Database Real Application Security
 - ALL audit events, [30-62](#)
 - auditing, [30-56](#)
 - security class and ACL audit events, [30-59](#)
 - session audit events, [30-60](#)
 - user, privilege, and role audit events, [30-58](#)
- Oracle Database Vault
 - auditing, [30-47](#)

- Oracle Database Vault (*continued*)
 - command rules, audit events, [30-51](#)
 - Data Pump, audit events, [30-53](#)
 - enable and disable, audit events, [30-54](#)
 - factors, audit events, [30-51](#)
 - OLS, audit events, [30-53](#)
 - realms, audit events, [30-49](#)
 - rule sets and rules, audit events, [30-50](#)
 - secure application roles, audit events, [30-52](#)
- Oracle Database-to-Entra ID authorizations
 - disabling, [8-17](#)
 - enabling, [8-16](#)
- Oracle Database-to-IAM
 - trace files for client side, [8-47](#)
- Oracle Database-to-Microsoft Azure Active Directory client connections
 - network proxies, [8-36](#)
- Oracle Database-to-Microsoft Azure Entra ID
 - creating Entra ID app roles, [8-14](#)
- Oracle Database-to-Microsoft Entra ID
 - about, [8-2](#)
 - architecture, [8-4](#)
 - assigning app role to service principal, [8-15](#)
 - assigning users and groups to Entra ID app roles, [8-15](#)
 - configuring v2 tokens, [8-13](#)
 - Entra ID token, checking version of, [8-48](#)
 - exclusive mapping between database schema and Azure user, [8-18](#)
 - mapping Oracle roles with Entra ID roles, [8-19](#)
 - on-premises requirements, [8-8](#)
 - operational flow, [8-21](#)
 - Oracle schema-to-Entra ID application role mapping, [8-18](#)
 - registering database instance to Microsoft Azure tenancy, [8-9](#)
 - trace files for client, levels, [8-46](#)
 - trace files for client, setting, [8-47](#)
 - use cases, [8-6](#)
 - user and group mappings, [8-5](#), [8-7](#)
- Oracle Database-to-Microsoft Entra ID client connections
 - about, [8-20](#)
 - confidential client registration, [8-25](#)
 - configuring to work with Entra ID token, [8-27](#)
 - creating a client app registration, [8-25](#)
 - direct token retrievals, [8-28](#)
 - enabling client to retrieve token from file location, [8-33](#)
 - example using Python script for MSAL library, [8-34](#)
 - examples of retrieving OAuth2 tokens, [8-34](#)
 - net naming for Azure, [8-41](#)
 - net naming for IAM, [7-22](#)
 - network proxy for default database, [8-39](#)
- Oracle Database-to-Microsoft Entra ID client connections (*continued*)
 - network proxy for Oracle Real Application Clusters, [8-39](#)
 - network proxy for Windows, [8-40](#)
 - public client registration, [8-25](#)
 - requesting tokens using Azure CLI, [8-36](#)
 - retrieving token using Entra ID CLI, [8-35](#)
 - secrets for Azure, [8-41](#)
 - secrets for IAM, [7-22](#)
 - supported drivers, [8-24](#)
 - testing Azure endpoint accessibility, [8-37](#)
- Oracle DBaaS client connections
 - supported drivers, [7-22](#)
- Oracle DBaaS-to-Entra ID proxy authentication
 - about, [8-41](#)
 - configuring, [8-42](#)
 - validating, [8-42](#)
- Oracle DBaaS-to-IAM
 - about, [7-2](#), [7-22](#)
 - about token requests using passwords or SEPS, [7-23](#)
 - architecture, [7-4](#)
 - cross-tenancy access examples, [7-35](#)
 - cross-tenancy, about, [7-32](#)
 - database clients for cross-tenancy access, [7-37](#)
 - parameters for setting password or SEPS token requests, [7-24](#)
 - requesting cross-tenancy tokens, [7-37](#)
 - trace files for client side, [7-40](#)
 - troubleshooting client side, [7-40](#)
- Oracle DBaaS-to-IAM authorizations
 - about, [7-10](#)
 - altering, [7-13](#)
 - creating IAM database password, [7-20](#)
 - creating policies for authenticating users, [7-19](#)
 - enabling, [7-8](#)
 - IAM group to database global role, [7-12](#)
 - IAM user to database global user, [7-12](#)
 - instance principals, [7-13](#)
 - mapping schemas and roles to users and groups in another tenancy, [7-36](#)
 - migrating, [7-13](#)
 - resource principals, [7-13](#)
 - shared database global user, [7-11](#)
 - source user tenancy, [7-34](#)
 - target database resource tenancy, [7-34](#)
 - token requested by IAM user name and password, [7-27](#)
 - token requested by IAM user name and secure external password store (SEPS), [7-26](#)
 - user authorization, verifying, [7-14](#)
- Oracle DBaaS-to-IAM client connections
 - IAM token, [7-30](#)
 - password verifier, [7-23](#)

- Oracle DBaaS-to-IAM client connections (*continued*)
 - SQL*Plus using an IAM database password, [7-29](#)
 - token, [7-27](#)
- Oracle DBaaS-to-IAM connections
 - about, [7-8](#)
 - connection pools using instance or resource principals, [7-20](#)
 - database links, [7-37](#)
 - direct token retrievals, [7-28](#)
 - walletless connections, [7-28](#)
- Oracle DBaaS-to-IAM proxy authentication
 - about, [7-17](#)
 - configuring, [7-18](#)
 - validating, [7-18](#)
- Oracle DBaaS-to-Power BI SSO
 - about, [8-43](#)
- Oracle Developer Tools For Visual Studio (ODT)
 - debugging using Java Debug Wire Protocol, [10-22](#)
- Oracle E-Business Suite
 - schema-only accounts, [3-60](#)
- Oracle Enterprise Manager
 - PDBs, [11-1](#)
 - statistics monitor, [2-25](#)
- Oracle Flashback Data Archive
 - Oracle Virtual Private Database, [14-49](#)
- Oracle home
 - default permissions, disallowing modification, [A-11](#)
- Oracle Internet Directory
 - Diffie-Hellman TLS port, [21-47](#)
- Oracle Internet Directory (OID)
 - SYSDBA and SYSOPER access, controlling, [3-52](#)
 - Transport Layer Security authentication, [25-2](#)
- Oracle Java Virtual Machine
 - JAVA_RESTRICT initialization parameter security guideline, [A-11](#)
- Oracle Java Virtual Machine (OJVM)
 - permissions, restricting, [A-3](#)
- Oracle Label Security
 - audit events, [30-66](#)
 - auditing, [30-65](#)
 - auditing internal predicates in policies, [30-16](#)
 - user session label audit events, [30-68](#)
- Oracle Label Security (OLS)
 - Oracle Virtual Private Database, using with, [14-47](#)
- Oracle Machine Learning for SQL
 - audit events, [30-77](#)
- Oracle native encryption
 - configured with SSL authentication, [20-15](#)
- Oracle Net, [A-15](#)
 - firewall support, [A-15](#)
- Oracle parameters
 - authentication, [27-5](#)
- Oracle RAC
 - Transport Layer Security, [21-53](#)
- Oracle Real Application Clusters
 - components that need certificates, [21-55](#)
 - global application contexts, [13-30](#)
 - SYSRAC administrative privilege, [4-17](#)
- Oracle Real Application Security
 - auditing internal predicates in policies, [30-16](#)
- Oracle Recovery Manager
 - audit events, [30-64](#)
 - auditing, [30-63](#)
 - SYSBACKUP administrative privilege, [4-14](#)
- Oracle Scheduler
 - sensitive credential data
 - about, [16-1](#)
 - data dictionary views, [16-6](#)
 - deleting, [16-4](#)
 - encrypting, [16-2](#)
 - multitenant environment, [16-2](#)
 - rekeying, [16-3](#)
 - restoring functioning of lost keystore, [16-5](#)
- Oracle SQL*Loader
 - Direct Load Path audit events, [30-73](#)
- Oracle Technology Network
 - security alerts, [A-2](#)
- Oracle Virtual Private Database, [14-2](#)
 - exporting data using Data Pump Export, [14-48](#)
 - Oracle Flashback Data Archive, [14-49](#)
- Oracle Virtual Private Database (VPD), [14-3](#)
 - about, [14-2](#)
 - ANSI operations, [14-45](#)
 - application containers, [14-5](#)
 - application contexts
 - tutorial, [14-31](#)
 - used with, [14-4](#)
 - applications
 - how it works with, [14-45](#)
 - users who are database users, how it works with, [14-52](#)
 - applications using for security, [12-3](#)
 - automatic reparsing, how it works with, [14-46](#)
 - benefits, [14-3](#)
 - CDBs, [14-5](#)
 - column level, [14-12](#)
 - column masking behavior
 - enabling, [14-14](#)
 - restrictions, [14-15](#)
 - column-level display, [14-12](#)
 - components, [14-6](#)
 - configuring, [14-8](#)
 - cursors, shared, [14-4](#)
 - edition-based redefinitions, [14-44](#)
 - editions, results in, [13-32](#)

Oracle Virtual Private Database (VPD) (*continued*)

- Enterprise User Security proxy authentication,
 - how it works with, [14-52](#)
- exporting data, [14-47](#)
- extended data objects in views, [14-10](#)
- finding information about, [14-33](#)
- flashback query, how it works with, [14-46](#)
- function
 - components, [14-6](#)
 - how it is run, [14-4](#)
- JDBC proxy authentication, how it works with,
 - [14-52](#)
- JSON, [14-53](#)
- nondatabase user applications, how works with, [14-52](#)
- OCI proxy authentication, how it works with,
 - [14-52](#)
- Oracle Label Security
 - exceptions in behavior, [14-47](#)
 - using with, [14-47](#)
- outer join operations, [14-45](#)
- performance benefit, [14-3](#)
- policies, Oracle Virtual Private Database
 - about, [14-9](#)
 - applications, validating, [14-18](#)
 - attaching to database object, [14-10](#)
 - column display, [14-12](#)
 - column-level display, default, [14-13](#)
 - dynamic, [14-20](#)
 - multiple, [14-18](#)
 - optimizing performance, [14-20](#)
 - privileges used to run, [14-4](#)
 - SQL statements, specifying, [14-11](#)
- policy groups
 - about, [14-16](#)
 - benefits, [14-16](#)
 - creating, [14-17](#)
 - default, [14-17](#)
 - tutorial, implementation, [14-38](#)
- policy types
 - context sensitive, about, [14-23](#)
 - context sensitive, altering existing policy,
 - [14-25](#)
 - context sensitive, creating, [14-24](#)
 - context sensitive, refreshing, [14-24](#)
 - context sensitive, restricting evaluation,
 - [14-23](#)
 - context sensitive, when to use, [14-26](#)
 - context-sensitive, audited, [30-18](#)
 - DYNAMIC, [14-20](#)
 - dynamic, audited, [30-18](#)
 - shared context sensitive, about, [14-25](#)
 - shared context sensitive, when to use,
 - [14-26](#)
 - shared static, about, [14-22](#)
 - shared static, when to use, [14-23](#)

Oracle Virtual Private Database (VPD) (*continued*)

- policy types (*continued*)
 - static, about, [14-21](#)
 - static, audited, [30-18](#)
 - static, when to use, [14-23](#)
 - summary of features, [14-26](#)
 - privileges required to create policies, [14-4](#)
 - SELECT FOR UPDATE statements in
 - policies, [14-45](#)
 - tutorial, simple, [14-28](#)
 - user models, [14-52](#)
 - Web-based applications, how it works with,
 - [14-52](#)
- Oracle Virtual Private Database (VPD)
- predicates
 - audited in fine-grained audit policies, [31-4](#)
 - audited in unified audit policies, [30-16](#)
- Oracle wallets
- authentication method, [3-66](#)
 - search order for TLS, [21-30](#)
- ORACLE_DATAPUMP access driver
- guidelines for security, [A-12](#)
- ORACLE_OCM user account, [2-42](#)
- OracleMetaLink
- See My Oracle Support
- orapki
- running in FIPS mode, [C-3](#)
- orapki utility
- adding a certificate request to a wallet with,
 - [B-15](#)
 - adding a root certificate to a wallet with, [B-19](#)
 - adding a trusted certificate to a wallet with,
 - [B-19](#)
 - adding certificate to wallet, [B-22](#)
 - adding user certificates to a wallet with, [B-20](#)
 - adding user-supplied certificate to wallet, [B-22](#)
 - cert create command, [B-27](#)
 - cert display command, [B-28](#)
 - certificate revocation lists, [21-46](#)
 - changing the wallet password with, [B-12](#)
 - converting wallet to use AES256 algorithm,
 - [B-13](#)
 - creating a local auto-login wallet with, [B-11](#)
 - creating a wallet with, [B-10](#)
 - creating an auto-login only wallet with, [B-11](#)
 - creating an auto-login wallet with, [B-11](#)
 - creating SHA-2 certificates for testing, [B-17](#)
 - creating signed certificates for testing, [B-16](#)
 - crl delete command, [B-28](#)
 - crl display command, [B-29](#)
 - crl hash command, [B-30](#)
 - crl list command, [B-30](#)
 - crl upload command, [B-31](#)
 - examples, [B-23](#)
 - exporting a certificate from a wallet with, [B-22](#)

orapki utility (*continued*)

- exporting a certificate request from a wallet with, [B-22](#)
 - importing a wallet with, [B-10](#)
 - managing certificate revocation lists, [B-23](#)
 - secretstore create_credential command, [B-31](#)
 - secretstore create_entry command, [B-32](#)
 - secretstore create_user_credential command, [B-33](#)
 - secretstore delete_credential command, [B-33](#)
 - secretstore delete_entry command, [B-34](#)
 - secretstore delete_user_credential command, [B-34](#)
 - secretstore list_credentials command, [B-35](#)
 - secretstore list_entries command, [B-35](#), [B-38](#)
 - secretstore list_entries_unsorted command, [B-36](#)
 - secretstore modify_credential command, [B-36](#)
 - secretstore modify_entry command, [B-37](#)
 - secretstore modify_user_credential command, [B-37](#)
 - syntax, [B-9](#)
 - viewing a certificate with, [B-21](#)
 - viewing a wallet with, [B-12](#)
 - wallet add command, [B-38](#)
 - wallet change_pwd command, [B-41](#)
 - wallet convert command, [B-41](#)
 - wallet create command, [B-42](#)
 - wallet delete command, [B-42](#)
 - wallet display command, [B-43](#)
 - wallet export command, [B-43](#)
 - wallet export_private_key command, [B-44](#)
 - wallet import_pkcs12 command, [B-45](#)
 - wallet import_private_key command, [B-45](#)
 - wallet jks_to_pkcs12 command, [B-46](#)
 - wallet pkcs12_to_jks command, [B-46](#)
 - wallet remove command, [B-47](#)
- ORAPWD utility
- case sensitivity in passwords, [3-32](#)
 - changing SYS password, [2-22](#)
 - changing SYS password with, [2-21](#)
- ORDDATA user account, [2-39](#)
- ORDPLUGINS user account, [2-39](#)
- ORDSYS user account, [2-39](#)
- OS_AUTHENT_PREFIX parameter, [27-6](#)
- OS_ROLES initialization parameter
- operating system role grants, [4-105](#)
 - operating-system authorization and, [4-53](#)
 - REMOTE_OS_ROLES and, [4-105](#)
 - using, [4-104](#)
- OSAK_ADMIN_ROLE role, [4-40](#)
- outer join operations
- Oracle Virtual Private Database affect on, [14-45](#)
- OUTLN user account, [2-39](#)

P

- packages
- auditing, [30-11](#), [30-16](#)
 - examples, [4-86](#)
 - examples of privilege use, [4-86](#)
 - granting roles to, [4-55](#)
 - privileges
 - divided by construct, [4-85](#)
 - executing, [4-84](#), [4-85](#)
- parallel execution servers, [13-12](#)
- parallel query, and SYS_CONTEXT, [13-12](#)
- parameters
- authentication
 - Kerberos, [24-5](#)
 - RADIUS, [26-7](#)
 - encryption and checksumming, [20-11](#)
- pass phrase
- read and parse server.key file, [A-19](#)
- PASSWORD command
- about, [2-20](#)
 - changing SYS password with, [2-21](#)
- password complexity functions
- about, [3-26](#)
 - administrative users, for, [3-51](#)
 - customizing, [3-28](#)
 - enabling, [3-28](#)
 - how database checks password complexity, [3-26](#)
 - ora12c_stig_verify_function, [3-27](#)
 - ora12c_strong_verify_function, [3-27](#)
 - ora12c_verify_function, [3-26](#)
 - privileges required, [3-26](#)
- password files
- how used to authenticate administrators, [3-55](#)
 - migration of for administrative users, [3-50](#)
- password limits
- administrative logins, [3-55](#)
- password management
- inactive user accounts, locking automatically, [3-9](#)
- password versions
- target databases that run earlier releases, [3-38](#)
 - using 12C exclusively, [3-37](#)
- PASSWORD_LIFE_TIME profile parameter, [3-12](#)
- PASSWORD_LOCK_TIME profile parameter, [3-10](#)
- PASSWORD_REUSE_MAX profile parameter, [3-11](#)
- PASSWORD_REUSE_TIME profile parameter, [3-11](#)
- PASSWORD_ROLLOVER_TIME parameter, [3-19](#)
- passwords, [3-3](#)
- 10G password version, finding and resetting, [3-30](#)

- passwords (*continued*)
- about managing, [3-5](#)
 - account locking, [3-10](#)
 - administrator
 - authenticating with, [3-55](#)
 - guidelines for securing, [A-7](#)
 - aging and expiration, [3-12](#)
 - ALTER PROFILE statement, [3-5](#)
 - altering, [2-19](#)
 - application design guidelines, [12-8](#)
 - applications, strategies for protecting
 - passwords, [12-7](#)
 - brute force attacks, [3-3](#)
 - changing for roles, [4-51](#)
 - changing SYS with ORAPWD utility, [2-22](#)
 - complexity verification
 - about, [3-26](#)
 - complexity, guidelines for enforcing, [A-7](#)
 - compromised, how to handle, [3-23](#)
 - connecting without, [3-65](#)
 - CREATE PROFILE statement, [3-5](#)
 - danger in storing as clear text, [A-7](#)
 - database user authentication, [3-57](#)
 - default profile settings
 - about, [3-7](#)
 - default user account, [A-7](#)
 - default, finding, [3-6](#)
 - delays for incorrect passwords, [3-3](#)
 - duration, [A-7](#)
 - encrypting, [3-3](#), [A-7](#)
 - examples of creating, [3-4](#)
 - expiring
 - explicitly, [3-13](#)
 - procedure for, [3-12](#)
 - proxy account passwords, [3-76](#)
 - with grace period, [3-13](#)
 - failed logins, resetting, [3-10](#)
 - finding users who use old passwords, [3-24](#)
 - forcing oracle user to enter when logging in as
 - SYSDBA, [4-14](#)
 - grace period, example, [3-13](#)
 - gradual database rollover, [3-17](#)
 - guidelines for security, [A-7](#)
 - history, [3-11](#), [A-7](#)
 - Java code example to read passwords, [12-11](#)
 - length, [A-7](#)
 - life time set too low, [3-15](#)
 - lifetime for, [3-12](#)
 - lock time, [3-10](#)
 - management rules, [A-7](#)
 - managing, [3-4](#)
 - maximum reuse time, [3-11](#)
 - ORAPWD utility, [3-32](#)
 - password complexity verification, [3-26](#)
 - how database checks, [3-26](#)
 - ora12c_stig_verify_function, [3-27](#)
- passwords (*continued*)
- password complexity verification (*continued*)
 - ora12c_verify_function function, [3-26](#)
 - privileges required, [3-26](#)
 - password file risks, [3-56](#)
 - PASSWORD_LOCK_TIME profile parameter, [3-10](#)
 - PASSWORD_REUSE_MAX profile parameter, [3-11](#)
 - PASSWORD_REUSE_TIME profile parameter, [3-11](#)
 - policies, [3-4](#)
 - privileges for changing for roles, [4-51](#)
 - privileges to alter, [2-18](#)
 - protections, built-in, [3-3](#)
 - proxy authentication, [3-80](#)
 - requirements
 - additional, [A-7](#)
 - minimum, [3-4](#)
 - reusing, [3-11](#), [A-7](#)
 - reusing passwords, [3-11](#)
 - role password case sensitivity, [3-29](#)
 - roles authenticated by passwords, [4-48](#)
 - roles enabled by SET ROLE statement, [4-51](#)
 - secure external password store, [3-41](#)
 - security risks, [3-56](#)
 - SYS account, [2-21](#)
 - SYS and SYSTEM, [A-7](#)
 - used in roles, [4-36](#)
 - utlpwdmg.sql password script
 - password management, [3-26](#)
 - verified using SHA-512 hash function, [3-37](#)
 - versions, management of, [3-30](#)
 - See also authentication, and access control list (ACL), wallet access
- PDB lockdown profiles
- about, [4-64](#)
 - creating, [4-68](#)
 - default, [4-67](#)
 - disabling, [4-69](#)
 - dropping, [4-71](#)
 - enabling, [4-69](#)
 - features that benefit from, [4-66](#)
 - inheritance, [4-67](#)
- PDB_DBA role, [4-40](#)
- PDB_OS_CREDENTIAL initialization parameter, [3-62](#), [4-66](#)
- PDBs
- application common users
 - about, [2-3](#)
 - auditing
 - types of audit settings allowed, [28-9](#)
 - unified audit policy syntax, [30-2](#)
 - what can be audited, [28-1](#)
 - CDB common users
 - about, [2-3](#)

- PDBs (*continued*)
- common roles
 - about, [4-59](#)
 - creating, [4-61](#)
 - granting, [4-62](#)
 - how they work, [4-60](#)
 - privileges required for management, [4-60](#)
 - revoking, [4-62](#)
 - rules for creating, [4-60](#)
 - common users
 - accessing data in PDBs, [4-33](#)
 - creating, [2-14](#)
 - viewing privilege information, [4-32](#)
 - Enterprise Manager
 - about, [11-1](#)
 - creating common roles, [11-7](#)
 - creating common users, [11-3](#)
 - creating local roles, [11-9](#)
 - creating local users, [11-5](#)
 - dropping common roles, [11-9](#)
 - dropping common users, [11-5](#)
 - dropping local roles, [11-10](#)
 - dropping local users, [11-6](#)
 - editing common roles, [11-8](#)
 - editing common users, [11-4](#)
 - editing local roles, [11-10](#)
 - editing local users, [11-6](#)
 - logging in, [11-1](#)
 - revoking common privilege grants, [11-9](#)
 - revoking local privilege grants, [11-11](#)
 - switching to different container, [11-2](#)
 - fine-grained audit policies, [31-4](#)
 - granting privileges and roles, [4-4](#)
 - local roles
 - about, [4-59](#)
 - creating, [4-62](#)
 - rules for creating, [4-61](#)
 - local users
 - about, [2-5](#)
 - creating, [2-16](#)
 - lockdown profiles, [4-64](#)
 - operating system user configuration, [3-62](#)
 - operating system user for, setting, [3-62](#)
 - privilege analysis, [5-4](#)
 - privileges
 - common, [4-30](#)
 - granting, [4-31](#)
 - how affected, [4-12](#)
 - object, [4-30](#)
 - revoking, [4-31](#)
 - viewing information about, [4-32](#)
 - PUBLIC role, [4-60](#)
 - security isolation guideline, [A-14](#)
 - setting default credential, [3-63](#)
 - sqlnet.ora settings, [3-37](#)
 - transparent sensitive data protection, [15-4](#)
- PDBs (*continued*)
- viewing information about, [4-32](#)
 - Virtual Private Database policies, [14-5](#)
 - performance
 - application contexts, [13-2](#)
 - auditing, [28-4](#)
 - Oracle Virtual Private Database policies, [14-3](#)
 - Oracle Virtual Private Database policy types, [14-20](#)
 - resource limits and, [2-23](#)
 - permissions
 - default, [A-11](#)
 - run-time facilities, [A-3](#)
 - PGX_SERVER_GET_INFO role, [4-40](#)
 - PGX_SERVER_MANAGE role, [4-40](#)
 - PGX_SESSION_ADD_PUBLISHED_GRAPH role, [4-40](#)
 - PGX_SESSION_COMPILE_ALGORITHM role, [4-40](#)
 - PGX_SESSION_CREATE role, [4-40](#)
 - PGX_SESSION_GET_PUBLISHED_GRAPH role, [4-40](#)
 - PGX_SESSION_MODIFY_MODEL role, [4-40](#)
 - PGX_SESSION_NEW_GRAPH role, [4-40](#)
 - PGX_SESSION_READ_MODEL role, [4-40](#)
 - PKI
 - See public key infrastructure (PKI)
 - PL/SQL
 - roles in procedures, [4-38](#)
 - PL/SQL packages
 - auditing, [30-11](#), [30-16](#)
 - PL/SQL procedures
 - setting application context, [13-10](#)
 - PL/SQL stored procedures
 - network access for debugging operations, [10-22](#)
 - plaintext data
 - defined, [20-2](#)
 - PMON background process
 - application contexts, cleaning up, [13-6](#)
 - positional parameters
 - security risks, [12-10](#)
 - predefined schema user accounts, [2-38](#)
 - principle of least privilege, [A-3](#)
 - about, [A-3](#)
 - granting user privileges, [A-3](#)
 - middle-tier privileges, [3-78](#)
 - privilege analysis
 - about, [5-2](#)
 - accessing reports in Cloud Control, [5-13](#)
 - benefits, [5-2](#)
 - CDBs, [5-4](#)
 - creating, [5-6](#)
 - creating role in Cloud Control, [5-15](#)
 - data dictionary views, [5-30](#)
 - DBMS_PRIVILEGE_CAPTURE PL/SQL package, [5-5](#)

- privilege analysis (*continued*)
 - disabling, [5-10](#)
 - dropping, [5-14](#)
 - enabling, [5-9](#)
 - examples of creating and enabling, [5-8](#)
 - general steps for managing, [5-6](#)
 - generating regrant scripts, [5-17](#)
 - generating reports
 - about, [5-11](#)
 - in Cloud Control, [5-13](#)
 - using DBMS_PRIVILEGE_CAPTURE.GENERATE_REPORTgranting and revoking, [4-73](#)
 - generating revoke scripts, [5-16](#)
 - logon users, [5-3](#)
 - multiple named capture runs, [5-11](#)
 - pre-compiled database objects, [5-4](#)
 - privilege uses captured, [5-3](#)
 - requirements for using, [5-3](#)
 - restrictions, [5-3](#)
 - revoking and re-granting in Cloud Control, [5-15](#)
 - revoking and regranting using scripts, [5-16](#)
 - tutorial, [5-22](#)
 - tutorial for ANY privileges, [5-18](#)
 - tutorial for schema privileges, [5-27](#)
 - use cases, [5-2](#)
 - finding application pool privileges, [5-2](#)
 - finding overly privileged users, [5-3](#)
- privileges, [4-18](#)
 - about, [4-2](#)
 - access control lists, checking for external
 - network services, [10-20](#)
 - altering
 - passwords, [2-19](#)
 - users, [2-18](#)
 - altering role authentication method, [4-51](#)
 - applications, managing, [12-21](#)
 - auditing use of, [30-6](#)
 - auditing, recommended settings for, [A-23](#)
 - cascading revokes, [4-101](#)
 - column, [4-97](#)
 - compiling procedures, [4-85](#)
 - creating or replacing procedures, [4-84](#)
 - creating users, [2-6](#)
 - data links
 - privilege management, [4-77](#)
 - diagnostics, [4-28](#)
 - dropping profiles, [2-29](#)
 - extended data links
 - privilege management, [4-78](#)
 - granted locally, [4-6](#)
 - granting
 - about, [4-21](#), [4-92](#)
 - examples, [4-86](#)
 - object privileges, [4-73](#), [4-94](#)
 - system, [4-92](#)
 - system privileges, [4-92](#)
- privileges (*continued*)
 - granting common, [4-6–4-8](#)
 - granting in a CDB, [4-4](#)
 - grants, listing, [4-112](#)
 - grouping with roles, [4-33](#)
 - local, [4-5](#)
 - managing, [12-27](#)
 - metadata links, [4-77](#)
 - middle tier, [3-78](#)
 - object, [4-72](#), [4-74](#), [12-28](#)
 - on selected columns, [4-100](#)
 - procedures, [4-84](#)
 - creating and replacing, [4-84](#)
 - executing, [4-84](#)
 - in packages, [4-85](#)
 - READ ANY TABLE system privilege
 - about, [4-75](#)
 - restrictions, [4-75](#)
 - READ object privilege, [4-74](#)
 - read-only configuration, [4-108](#)
 - reasons to grant, [4-11](#)
 - revoking privileges
 - about, [4-21](#)
 - object, [4-98](#)
 - object privileges, cascading effect, [4-101](#)
 - object privileges, requirements for, [4-98](#)
 - schema object, [4-73](#)
 - revoking system privileges, [4-98](#)
 - roles
 - creating, [4-48](#)
 - dropping, [4-55](#)
 - restrictions on, [4-39](#)
 - roles, why better to grant, [4-11](#)
 - schema grants, listing, [4-112](#)
 - schema object, [4-72](#)
 - DML and DDL operations, [4-81](#)
 - packages, [4-85](#)
 - procedures, [4-84](#)
 - SELECT system privilege, [4-74](#)
 - SQL statements permitted, [12-28](#)
 - synonyms and underlying objects, [4-75](#)
 - system
 - granting and revoking, [4-21](#)
 - SELECT ANY DICTIONARY, [A-11](#)
 - SYSTEM and OBJECT, [A-3](#)
 - system privileges
 - about, [4-19](#)
 - trigger privileges, [9-2](#)
 - used for Oracle Virtual Private Database
 - policy functions, [14-4](#)
 - view privileges
 - creating a view, [4-82](#)
 - using a view, [4-83](#)
 - views, [4-82](#)

- privileges (*continued*)
 See also access control list (ACL) and system privileges, privilege captures
- procedures
 auditing, [30-11](#), [30-16](#)
 compiling, [4-85](#)
 definer's rights
 about, [9-2](#)
 roles disabled, [4-38](#)
 examples of, [4-86](#)
 examples of privilege use, [4-86](#)
 granting roles to, [4-55](#)
 invoker's rights
 about, [9-3](#)
 roles used, [4-39](#)
 privileges for procedures
 create or replace, [4-84](#)
 executing, [4-84](#)
 executing in packages, [4-85](#)
 privileges required for, [4-84](#)
 security enhanced by, [9-2](#)
- process monitor process (PMON)
 cleans up timed-out sessions, [2-25](#)
- PRODUCT_USER_PROFILE table
 SQL commands, disabling with, [4-57](#)
- profile limits
 modifying, [3-8](#)
- profile parameters
 FAILED_LOGIN_ATTEMPTS, [3-7](#)
 INACTIVE_ACCOUNT_TIME, [3-7](#), [3-9](#)
 PASSWORD_GRACE_TIME, [3-7](#), [3-13](#)
 PASSWORD_LIFE_TIME, [3-7](#), [3-13](#), [3-15](#)
 PASSWORD_LOCK_TIME, [3-7](#), [3-10](#)
 PASSWORD_REUSE_MAX, [3-7](#), [3-11](#)
 PASSWORD_REUSE_TIME, [3-7](#), [3-11](#)
 PASSWORD_ROLLOVER_TIME, [3-19](#)
- profiles, [2-26](#)
 about, [2-26](#)
 application, [2-29](#)
 assigning to user, [2-29](#)
 CDB, [2-29](#)
 common, [2-29](#)
 common mandatory for CDB root, about, [2-30](#)
 common mandatory for CDB root, creating, [2-31](#)
 common mandatory for CDB root, example, [2-32](#)
 creating, [2-28](#)
 dropping, [2-29](#)
 finding information about, [2-43](#)
 finding settings for default profile, [2-45](#)
 managing, [2-26](#)
 ORA_CIS_PROFILE user profile, [2-27](#)
 ORA_STIG_PROFILE user profile, [2-27](#)
 privileges for dropping, [2-29](#)
 specifying for user, [2-13](#)
- profiles (*continued*)
 viewing, [2-45](#)
- program units
 granting roles to, [4-55](#)
- PROVISIONER role, [4-40](#)
- proxy authentication
 about, [3-73](#)
 advantages, [3-73](#)
 auditing operations, [3-70](#)
 auditing users, [30-33](#)
 client-to-middle tier sequence, [3-77](#)
 creating proxy user accounts, [3-74](#)
 middle-tier
 authorizing but not authenticating users, [3-79](#)
 authorizing to proxy and authenticate users, [3-79](#)
 limiting privileges, [3-78](#)
 reauthenticating users, [3-80](#)
 passwords, expired, [3-76](#)
 privileges required for creating users, [3-74](#)
 secure external password store, used with, [3-76](#)
 security benefits, [3-73](#)
 users, passing real identity of, [3-77](#)
- proxy user accounts
 privileges required for creation, [3-74](#)
- PROXY_USERS view, [3-76](#)
- pseudo columns
 USER, [4-83](#)
- public and private key pair, defined, [22-5](#)
- public key infrastructure (PKI), [3-66](#), [22-5](#)
 about, [3-66](#)
- PUBLIC role
 about, [4-21](#)
 granting and revoking privileges, [4-102](#)
 grants to in a CDB, [4-8](#)
 procedures and, [4-102](#)
 security domain of users, [4-38](#)
- PUBLIC role, CDBs, [4-60](#)
- PUBLIC_DEFAULT profile
 profiles, dropping, [2-29](#)
- ## Q
-
- quotas
 tablespace, [2-11](#)
 temporary segments and, [2-11](#)
 unlimited, [2-12](#)
 viewing, [2-45](#)
- ## R
-
- RADIUS, [22-4](#)
 accounting, [26-17](#)
 asynchronous authentication mode, [26-5](#)

- RADIUS** (*continued*)
- authentication modes, [26-3](#)
 - challenge-response
 - authentication, [26-5](#)
 - user interface, [26-20](#), [26-21](#)
 - configuring, [26-9](#)
 - database links not supported, [26-1](#)
 - initialization parameter file setting, [26-8](#)
 - minimum parameters to set, [26-8](#)
 - older clients, [26-15](#)
 - RADIUS_SECRET parameter, [26-13](#)
 - smartcards and, [22-4](#), [26-14](#), [26-20](#)
 - SQLNET.AUTHENTICATION_SERVICES
 - parameter, [26-9](#), [26-11](#)
 - sqlnet.ora file sample, [20-5](#)
 - SQLNET.RADIUS_ALLOW_WEAK_CLIENTS, [26-15](#)
 - SQLNET.RADIUS_ALLOW_WEAK_PROTOCOL, [26-15](#)
 - SQLNET.RADIUS_ALTERNATE parameter, [26-15](#)
 - SQLNET.RADIUS_ALTERNATE_PORT parameter, [26-15](#)
 - SQLNET.RADIUS_ALTERNATE_RETRIES
 - parameter, [26-15](#)
 - SQLNET.RADIUS_ALTERNATE_TIMEOUT
 - parameter, [26-15](#)
 - SQLNET.RADIUS_ALTERNATE_TLS_HOST
 - parameter, [26-15](#)
 - SQLNET.RADIUS_ALTERNATE_TLS_PORT
 - parameter, [26-15](#)
 - SQLNET.RADIUS_AUTHENTICATION_PORT
 - parameter, [26-13](#)
 - SQLNET.RADIUS_AUTHENTICATION_RETRIES
 - parameter, [26-13](#)
 - SQLNET.RADIUS_AUTHENTICATION_TIMEOUT
 - parameter, [26-13](#)
 - SQLNET.RADIUS_AUTHENTICATION_TLS_HOST
 - parameter, [26-11](#)
 - SQLNET.RADIUS_AUTHENTICATION_TLS_PORT
 - parameter, [26-11](#)
 - SQLNET.RADIUS_SEND_ACCOUNTING
 - parameter, [26-18](#)
 - SQLNET.RADIUS_TRANSPORT_PROTOCOL
 - parameter, [26-11](#)
 - synchronous authentication mode, [26-3](#)
 - system requirements, [22-7](#)
- RADIUS authentication, [3-67](#)
- RADIUS SQLNET.RADIUS_AUTHENTICATION
 - parameter
 - SQLNET.RADIUS_AUTHENTICATION
 - parameter, [26-11](#)
- RADIUS_SECRET parameter, [26-13](#)
- READ ANY TABLE system privilege
 - about, [4-75](#)
 - restrictions, [4-75](#)
- READ object privilege
 - about, [4-74](#)
 - guideline for using, [A-3](#)
 - SQL92_SECURITY initialization parameter, [4-75](#)
- read-only user configuration, [4-108](#)
- reads
 - limits on data blocks, [2-24](#)
- realm (Kerberos), [24-10](#)
- RECOVERY_CATALOG_OWNER_VPD role, [4-40](#)
- RECOVERY_CATALOG_USER role, [4-40](#)
- REDACT_AUDIT transparent sensitive data
 - protection default policy, [15-17](#)
- redo log files
 - auditing committed and rolled back transactions, [A-21](#)
- REFERENCES privilege
 - CASCADE CONSTRAINTS option, [4-100](#)
 - revoking, [4-100](#)
- remote authentication, [A-15](#)
- remote debugging
 - configuring network access, [10-22](#)
- REMOTE_OS_AUTHENT initialization parameter
 - guideline for securing, [A-15](#)
- REMOTE_OS_ROLES initialization parameter
 - OS role management risk on network, [4-105](#)
 - setting, [4-53](#)
- REMOTE_SCHEDULER_AGENT user account, [2-39](#)
- resource limits
 - about, [2-23](#)
 - call level, limiting, [2-24](#)
 - connection time for each session, [2-25](#)
 - CPU time, limiting, [2-24](#)
 - determining values for, [2-25](#)
 - idle time in each session, [2-25](#)
 - logical reads, limiting, [2-24](#)
 - private SGA space for each session, [2-25](#)
 - profiles, [2-26](#)
 - session level, limiting, [2-24](#)
 - sessions
 - concurrent for user, [2-25](#)
 - elapsed connection time, [2-25](#)
 - idle time, [2-25](#)
 - SGA space, [2-25](#)
 - types, [2-23](#)
- RESOURCE privilege
 - CREATE SCHEMA statement, needed for, [12-26](#)
- RESOURCE role, [4-88](#)
 - about, [4-40](#)
- restrictions, [22-8](#)
- REVOKE CONNECT THROUGH clause
 - revoking proxy authorization, [3-76](#)

- REVOKE statement
- system privileges and roles, [4-98](#)
 - when takes effect, [4-106](#)
- revoking privileges and roles
- cascading effects, [4-101](#)
 - on selected columns, [4-100](#)
 - REVOKE statement, [4-98](#)
 - specifying ALL, [4-74](#)
 - when using operating-system roles, [4-105](#)
- role identification
- operating system accounts, [4-104](#)
- ROLE_SYS_PRIVS view
- application privileges, [12-22](#)
- ROLE_TAB_PRIVS view
- application privileges, finding, [12-22](#)
- roles, [12-23](#)
- about, [4-2](#), [4-35](#)
 - ADM_PARALLEL_EXECUTE_TASK role, [4-40](#)
 - ADMIN OPTION and, [4-93](#)
 - advantages in application use, [12-22](#)
 - application, [4-38](#), [4-56](#), [12-25](#), [12-27](#)
 - application privileges, [12-22](#)
 - applications, for user, [12-25](#)
 - AUDIT_ADMIN role, [4-40](#)
 - AUDIT_VIEWER role, [4-40](#)
 - AUTHENTICATEDUSER role, [4-40](#)
 - authorization, [4-51](#)
 - authorized by enterprise directory service, [4-53](#)
 - AVTUNE_PKG_ROLE role, [4-40](#)
 - BDSQL_ADMIN role, [4-40](#)
 - BDSQL_USER role, [4-40](#)
 - CAPTURE_ADMIN role, [4-40](#)
 - CDB_DBA role, [4-40](#)
 - changing authorization for, [4-51](#)
 - changing passwords, [4-51](#)
 - common, [4-7](#)
 - common, auditing, [30-5](#)
 - common, granting, [4-62](#)
 - CONNECT role
 - about, [4-40](#)
 - create your own, [A-10](#)
 - CTXAPP role, [4-40](#)
 - database role, users, [12-25](#)
 - DATAPUMP_EXP_FULL_DATABASE role, [4-40](#)
 - DATAPUMP_IMP_FULL_DATABASE role, [4-40](#)
 - DB_DEVELOPER_ROLE role, [4-40](#)
 - DBA role, [4-40](#)
 - DBFS_ROLE role, [4-40](#)
 - DBJAVASCRIPT role, [4-40](#)
 - DBMS_MDX_INTERNAL role, [4-40](#)
 - DDL statements and, [4-39](#)
 - default, [4-107](#)
- roles (*continued*)
- default, setting for user, [2-17](#)
 - definer's rights procedures disable, [4-38](#)
 - dependency management in, [4-39](#)
 - DGPDB_ROLE role, [4-40](#)
 - disabling, [4-106](#)
 - dropping, [4-55](#)
 - DV_ACCTMGR role, [4-40](#)
 - DV_ADMIN role, [4-40](#)
 - DV_AUDIT_CLEANUP role, [4-40](#)
 - DV_DATAPUMP_NETWORK_LINK role, [4-40](#)
 - DV_GOLDENGATE_ADMIN role, [4-40](#)
 - DV_GOLDENGATE_REDO_ACCESS role, [4-40](#)
 - DV_MONITOR role, [4-40](#)
 - DV_OWNER role, [4-40](#)
 - DV_PATCH_ADMIN role, [4-40](#)
 - DV_POLICY_OWNER role, [4-40](#)
 - DV_SECANALYST role, [4-40](#)
 - DV_STREAMS_ADMIN role, [4-40](#)
 - DV_XSTREAMS_ADMIN role, [4-40](#)
 - EJBCLIENT role, [4-40](#)
 - enabled or disabled, [4-35](#), [4-54](#)
 - enabling, [4-106](#), [12-25](#)
 - enterprise, [4-53](#)
 - EXP_FULL_DATABASE role, [4-40](#)
 - external, [4-50](#)
 - FSQL_FIREWALL_VIEWER role, [4-40](#)
 - functionality, [4-11](#), [4-35](#)
 - functionality of, [4-35](#)
 - GATHER_SYSTEM_STATISTICS role, [4-40](#)
 - GDS_CATALOG_SELECT role, [4-40](#)
 - global authorization, [4-53](#)
 - about, [4-53](#)
 - global roles
 - creating, [4-53](#)
 - example, [4-50](#)
 - external sources, and, [4-52](#)
 - GLOBAL_AQ_USER_ROLE role, [4-40](#)
 - GRANT statement, [4-105](#)
 - granted locally, [4-6](#)
 - granted to other roles, [4-35](#)
 - granting and revoking to program units, [9-16](#)
 - granting in a CDB, [4-4](#)
 - granting roles
 - about, [4-92](#)
 - methods for, [4-54](#)
 - system, [4-92](#)
 - system privileges, [4-21](#)
 - granting to program units, [4-55](#)
 - GRAPH_ADMINISTRATOR role, [4-40](#)
 - GRAPH_DEVELOPER role, [4-40](#)
 - GRAPH_USER role, [4-40](#)
 - GSM_POOLADMIN_ROLE role, [4-40](#)
 - GSMADMIN_ROLE role, [4-40](#)
 - GSMCATUSER_ROLE role, [4-40](#)

roles (*continued*)

- GSMROOTUSER_ROLE role, [4-40](#)
- GSMUSER_ROLE role, [4-40](#)
- guidelines for security, [A-10](#)
- HS_ADMIN_EXECUTE_ROLE role, [4-40](#)
- HS_ADMIN_ROLE role, [4-40](#)
- HS_ADMIN_SELECT_ROLE role, [4-40](#)
- IMP_FULL_DATABASE role, [4-40](#)
- in applications, [4-36](#)
- indirectly granted, [4-35](#)
- invoker's rights procedures use, [4-39](#)
- JAVA_ADMIN role, [4-40](#)
- JAVADEBUGPRIV role, [4-40](#)
- JAVAIDPRIV role, [4-40](#)
- JAVASYSPRIV role, [4-40](#)
- JAVAUSSPRIV role, [4-40](#)
- JMXSERVER role, [4-40](#)
- job responsibility privileges only, [A-10](#)
- LBAC_DBA role, [4-40](#)
- listing grants, [4-112](#)
- listing privileges and roles in, [4-114](#)
- listing roles, [4-114](#)
- local, [4-5](#), [4-62](#)
- LOGSTDBY_ADMINISTRATOR role, [4-40](#)
- management using the operating system, [4-103](#)
- managing roles
 - about, [4-33](#)
 - categorizing users, [12-27](#)
- managing through operating system, [4-40](#)
- managing with RADIUS server, [26-19](#)
- maximum number a user can enable, [4-107](#)
- multibyte characters in names, [4-48](#)
- multibyte characters in passwords, [4-51](#)
- naming, [4-35](#)
- network authorization, [4-53](#)
- network client authorization, [4-53](#)
- OEM_ADVISOR role, [4-40](#)
- OEM_MONITOR role, [4-40](#)
- OGG_APPLY role, [4-40](#)
- OGG_APPLY_PROCREP role, [4-40](#)
- OGG_CAPTURE role, [4-40](#)
- OGG_SHARED_CAPTURE role, [4-40](#)
- One Big Application User, compromised by, [12-2](#)
- operating system, [4-104](#)
- operating system authorization, [4-53](#)
- operating system granting of, [4-105](#)
- operating system identification of, [4-104](#)
- operating system management and the shared server, [4-105](#)
- operating system-managed, [4-105](#)
- operating-system authorization, [4-52](#)
- OPTIMIZER_PROCESSING_RATE role, [4-40](#)
- OSAK_ADMIN_ROLE role, [4-40](#)
- password case sensitivity, [3-29](#)

roles (*continued*)

- PDB_DBA role, [4-40](#)
- PGX_SERVER_GET_INFO role, [4-40](#)
- PGX_SERVER_MANAGE role, [4-40](#)
- PGX_SESSION_ADD_PUBLISHED_GRAPH role, [4-40](#)
- PGX_SESSION_COMPILE_ALGORITHM role, [4-40](#)
- PGX_SESSION_CREATE role, [4-40](#)
- PGX_SESSION_GET_PUBLISHED_GRAPH role, [4-40](#)
- PGX_SESSION_MODIFY_MODEL role, [4-40](#)
- PGX_SESSION_NEW_GRAPH role, [4-40](#)
- PGX_SESSION_READ_MODEL role, [4-40](#)
- predefined, [4-40](#)
- privilege analysis, [5-3](#)
- privileges for creating, [4-48](#)
- privileges for dropping, [4-55](#)
- privileges, changing authorization method for, [4-51](#)
- privileges, changing passwords, [4-51](#)
- PROVISIONER role, [4-40](#)
- RECOVERY_CATALOG_OWNER_VPD role, [4-40](#)
- RECOVERY_CATALOG_USER role, [4-40](#)
- RESOURCE role, [4-40](#)
- restricting from tool users, [4-56](#)
- restrictions on privileges of, [4-39](#)
- REVOKE statement, [4-105](#)
- revoking, [4-54](#), [4-98](#)
- SAGA_ADM_ROLE role, [4-40](#)
- SAGA_CONNECT_ROLE role, [4-40](#)
- SAGA_PARTICIPANT_ROLE role, [4-40](#)
- SCHEDULER_ADMIN role, [4-40](#)
- schemas do not contain, [4-35](#)
- security domains of, [4-38](#)
- SET ROLE statement
 - about, [4-51](#)
 - example, [4-51](#)
 - OS_ROLES parameter, [4-105](#)
- setting in PL/SQL blocks, [4-39](#)
- SHARDED_SCHEMA_OWNER role, [4-40](#)
- SODA_APP role, [4-40](#)
- SQL_FIREWALL_ADMIN role, [4-40](#)
- unique names for, [4-48](#)
- use of passwords with, [4-36](#)
- user, [4-38](#), [12-27](#)
- users capable of granting, [4-55](#)
- uses of, [4-35](#), [4-36](#)
- WITH GRANT OPTION and, [4-95](#)
- without authorization, [4-48](#)
- WM_ADMIN_ROLE role, [4-40](#)
- XDB_SET_INVOKER roles, [4-40](#)
- XDB_WEBSERVICES role, [4-40](#)
- XDB_WEBSERVICES_OVER_HTTP role, [4-40](#)

roles (*continued*)

- XDB_WEBSERVICES_WITH_PUBLIC role, [4-40](#)
 - XDBADMIN role, [4-40](#)
 - XS_CACHE_ADMIN role, [4-40](#)
 - XS_NAMESPACE_ADMIN role, [4-40](#)
 - XS_NSATTR_ADMIN role, [4-40](#)
 - XS_RESOURCE role, [4-40](#)
 - XSTREAM_APPLY role, [4-40](#)
 - XSTREAM_CAPTURE role, [4-40](#)
- See also* secure application roles

root container

- viewing information about, [4-32](#)

root file paths

- for files and packages outside the database, [A-3](#)

row level security

- schema system privileges, [4-26](#)

row-level security

- See* fine-grained access control, Oracle Virtual Private Database (VPD)

RSA private key, [A-19](#)run-time facilities, [A-3](#)

- restriction permissions, [A-3](#)

S

SAGA_ADM_ROLE role, [4-40](#)SAGA_CONNECT_ROLE role, [4-40](#)SAGA_PARTICIPANT_ROLE role, [4-40](#)salt, [3-34](#)

Sarbanes-Oxley Act

- auditing to meet compliance, [28-1](#)

SCHEDULER_ADMIN role

- about, [4-40](#)

schema object privileges, [4-72](#)

schema objects

- cascading effects on revoking, [4-101](#)
- default tablespace for, [2-9](#)
- dropped users, owned by, [2-37](#)
- granting privileges, [4-94](#)
- privileges
 - DML and DDL operations, [4-81](#)
 - granting and revoking, [4-73](#)
 - view privileges, [4-82](#)
- privileges on, [4-72](#)
- privileges to access, [4-74](#)
- privileges with, [4-74](#)
- revoking privileges, [4-98](#)

schema privileges

- about, [4-22](#)

ADMINISTER FINE GRAINED AUDIT POLICY system privilege, [4-26](#)ADMINISTER REDACTION POLICY system privilege, [4-26](#)schema privileges (*continued*)ADMINISTER ROW LEVEL SECURITY POLICY system privilege, [4-26](#)

- administrative privileges excluded from, [4-23](#)
- granting, [4-25](#)

- revoking, [4-26](#)

- system privileges excluded from, [4-23](#)

- system privileges for security policies, about, [4-26](#)

- system privileges for security policies, granting, [4-27](#)

- system privileges for security policies, revoking, [4-27](#)

- tutorial using privilege analysis, [5-27](#)

schema user accounts, predefined, [2-38](#)schema-independent users, [12-27](#)schema-only accounts, [3-60](#)

schemas

- auditing, recommended settings for, [A-23](#)

- shared, protecting objects in, [12-27](#)

- unique, [12-26](#)

- unique, protecting objects in, [12-26](#)

SCOTT user account

- restricting privileges of, [A-10](#)

SEC_MAX_FAILED_LOGIN_ATTEMPTS

- initialization parameter, [12-31](#)

SEC_PROTOCOL_ERROR_FURTHER_ACTION

- initialization parameter, [12-30](#)

sec_relevant_cols_opt parameter, [14-15](#)

SEC_RETURN_SERVER_RELEASE_BANNER

- initialization parameter, [12-32](#)

SEC_USER_AUDIT_ACTION_BANNER

- initialization parameter, [12-32](#)

SEC_USER_UNAUTHORIZED_ACCESS_BANNER

- initialization parameter, [12-32](#)

seconf.sql script

- password settings, [3-9](#)

secret key

- location in RADIUS, [26-13](#)

secure application roles, [12-23](#)

- about, [4-57](#)

- creating, [12-22](#)

- creating PL/SQL package, [12-23](#)

- finding with DBA_ROLES view, [4-110](#)

- invoker's rights, [12-23](#)

- invoker's rights requirement, [12-23](#)

- package for, [12-23](#)

- user environment information from

- SYS_CONTEXT SQL function, [12-23](#)

- using to ensure database connection, [4-57](#)

secure external password store

- about, [3-41](#)

- client configuration, [3-43](#)

- examples, [3-42](#)

- how it works, [3-42](#)

- proxy authentication, used with, [3-76](#)

- Secure Sockets Layer on Oracle RAC
 - remote client, testing configuration, [21-59](#)
- SecurID, [26-4](#)
 - token cards, [26-4](#)
- security, [A-3](#)
 - application enforcement of, [4-36](#)
 - default user accounts
 - locked and expired automatically, [A-3](#)
 - locking and expiring, [A-3](#)
 - domains, enabled roles and, [4-54](#)
 - enforcement in application, [12-3](#)
 - enforcement in database, [12-3](#)
 - multibyte characters in role names, [4-48](#)
 - multibyte characters in role passwords, [4-51](#)
 - passwords, [3-57](#)
 - policies
 - applications, [12-2](#)
 - SQL*Plus users, restricting, [4-56](#)
 - tables or views, [14-3](#)
 - procedures enhance, [9-2](#)
 - products, additional, [1-3](#)
 - roles, advantages in application use, [12-22](#)
 - See also security risks
- security alerts, [A-2](#)
- security attacks, [3-3](#), [3-76](#), [18-3](#), [A-15](#)
 - access to server after protocol errors, preventing, [12-30](#)
 - application context values, attempts to change, [13-8](#)
 - application design to prevent attacks, [12-7](#)
 - command line recall attacks, [12-7](#), [12-10](#)
 - denial of service, [A-15](#)
 - denial-of-service
 - bad packets, addressing, [12-30](#)
 - denial-of-service attacks through listener, [A-15](#)
 - disk flooding, preventing, [12-30](#)
 - eavesdropping, [A-15](#)
 - encryption, problems not solved by, [18-3](#)
 - falsified IP addresses, [A-15](#)
 - falsified or stolen client system identities, [A-15](#)
 - hacked operating systems or applications, [A-15](#)
 - intruders, [18-3](#)
 - password cracking, [3-3](#)
 - password protections against, [3-3](#)
 - preventing malicious attacks from clients, [12-29](#)
 - preventing password theft with proxy authentication and secure external password store, [3-76](#)
 - session ID, need for encryption, [13-42](#)
 - shoulder surfing, [12-10](#)
 - SQL injection attacks, [12-8](#)
 - unlimited authenticated requests, preventing, [12-31](#)
- security attacks (*continued*)
 - user session output, hiding from intruders, [13-16](#)
 - See also security risks
- security domains
 - enabled roles and, [4-35](#)
- security isolation
 - guidelines for, [A-14](#)
- security patches
 - about, [A-2](#)
 - downloading, [A-2](#)
- security policies
 - See Oracle Virtual Private Database, policies
- security risks, [3-76](#), [A-3](#)
 - ad hoc tools, [4-56](#)
 - application users not being database users, [12-2](#)
 - applications enforcing rather than database, [12-3](#)
 - bad packets to server, [12-30](#)
 - database version displaying, [12-32](#)
 - encryption keys, users managing, [18-8](#)
 - invoker's rights procedures, [9-5](#)
 - password files, [3-56](#)
 - passwords exposed in large deployments, [3-41](#)
 - passwords, exposing in programs or scripts, [12-10](#)
 - positional parameters in SQL scripts, [12-10](#)
 - privileges carelessly granted, [4-21](#)
 - remote user impersonating another user, [4-53](#)
 - sensitive data in audit trail, [A-20](#)
 - server falsifying identities, [A-19](#)
 - users with multiple roles, [12-25](#)
 - See also security attacks
- security settings scripts
 - password settings
 - seconf.sql, [3-9](#)
- Security Technical Implementation Guide (STIG)
 - ORA_ALL_TOPLEVEL_ACTIONS predefined unified audit policy, [29-10](#)
 - ORA_LOGIN_LOGOUT predefined unified audit policy, [29-10](#)
 - ORA_STIG_PROFILE user profile, [2-27](#)
 - ORA_STIG_RECOMMENDATIONS predefined unified audit policy, [29-9](#)
 - ora12c_stig_verify_function password complexity function, [3-27](#)
- SELECT ANY DICTIONARY privilege
 - data dictionary, accessing, [A-11](#)
 - exclusion from GRANT ALL PRIVILEGES privilege, [A-11](#)
- SELECT FOR UPDATE statement in Virtual Private Database policies, [14-45](#)
- SELECT object privilege
 - guideline for using, [A-3](#)

- SELECT object privilege (*continued*)
 - privileges enabled, [4-74](#)
- SELECT_CATALOG_ROLE role
 - SYS schema objects, enabling access to, [4-20](#)
- sensitive data, auditing of, [A-23](#)
- separation of duty concepts, [23](#)
- sequences
 - auditing, [30-11](#)
- server.key file
 - pass phrase to read and parse, [A-19](#)
- SESSION_ROLES data dictionary view
 - PUBLIC role, [4-21](#)
- SESSION_ROLES view
 - queried from PL/SQL block, [4-38](#)
- sessions
 - listing privilege domain of, [4-113](#)
 - memory use, viewing, [2-46](#)
 - time limits on, [2-25](#)
 - when auditing options take effect, [32-2](#)
- SET ROLE statement
 - application code, including in, [12-26](#)
 - associating privileges with role, [12-25](#)
 - disabling roles with, [4-106](#)
 - enabling roles with, [4-106](#)
 - when using operating-system roles, [4-105](#)
- SGA
 - See System Global Area (SGA)
- SHA-512 cryptographic hash function
 - enabling exclusive mode, [3-37](#)
- SHARDED_SCHEMA_OWNER role, [4-40](#)
- Shared Global Area (SGA)
 - See System Global Area (SGA)
- shared server
 - limiting private SQL areas, [2-25](#)
 - operating system role management restrictions, [4-105](#)
- shoulder surfing, [12-10](#)
- SI_INFORMTN_SCHEMA user account, [2-39](#)
- single sign-on (SSO)
 - defined, [22-2](#)
- smart cards
 - guidelines for security, [A-7](#)
- smartcards, [22-4](#)
 - and RADIUS, [22-4](#), [26-14](#), [26-20](#)
- SODA_APP role, [4-40](#)
- SQL Developer
 - debugging using Java Debug Wire Protocol, [10-22](#)
- SQL Firewall
 - appearance of events in audit trail, [30-46](#)
 - auditing, about, [30-46](#)
- SQL injection attacks, [12-8](#)
- SQL statements
 - dynamic, [13-12](#)
- SQL statements (*continued*)
 - object privileges permitting in applications, [12-28](#)
 - privileges required for, [4-72](#), [12-28](#)
 - resource limits and, [2-24](#)
 - restricting ad hoc use, [4-56](#)
- SQL statements, top-level in unified audit policies, [30-22](#)
- SQL_FIREWALL_ADMIN role, [4-40](#)
- SQL_FIREWALL_VIEWER role, [4-40](#)
- SQL*Loader
 - object store credential creation, [3-47](#)
- SQL*Net
 - See Oracle Net Services
- SQL*Plus
 - connecting with, [3-65](#)
 - restricting ad hoc use, [4-56](#)
 - statistics monitor, [2-25](#)
- SQL92_SECURITY initialization parameter
 - READ object privilege impact, [4-75](#)
- SQLNET.ALLOWED_LOGON_VERSION_CLIENT
 - target databases from earlier releases, [3-38](#)
- SQLNET.ALLOWED_LOGON_VERSION_SERVER
 - target databases from earlier releases, [3-38](#)
 - using only 12C password version, [3-37](#)
- SQLNET.ALLOWED_LOGON_VERSION_SERVER
 - parameter
 - effect on role passwords, [3-29](#)
- SQLNET.AUTHENTICATION_KERBEROS5_SER
 - VICE parameter, [24-12](#)
- SQLNET.AUTHENTICATION_SERVICES
 - parameter, [24-12](#), [26-9](#), [26-11](#), [27-2](#), [27-4](#), [A-19](#)
- SQLNET.CRYPTO_CHECKSUM_CLIENT
 - parameter, [20-13](#)
- SQLNET.CRYPTO_CHECKSUM_SERVER
 - parameter, [20-13](#)
- SQLNET.CRYPTO_CHECKSUM_TYPES_CLIENT
 - T parameter, [20-13](#)
- SQLNET.CRYPTO_CHECKSUM_TYPES_SERVER
 - parameter, [20-13](#)
- SQLNET.ENCRYPTION_CLIENT
 - with ANO encryption and TLS authentication, [20-15](#)
- SQLNET.ENCRYPTION_CLIENT parameter, [20-11](#), [27-2](#)
- SQLNET.ENCRYPTION_SERVER
 - with ANO encryption and TLS authentication, [20-15](#)
- SQLNET.ENCRYPTION_SERVER parameter, [20-11](#), [27-2](#)
- SQLNET.ENCRYPTION_TYPES_CLIENT
 - parameter, [20-11](#)
- SQLNET.ENCRYPTION_TYPES_SERVER
 - parameter, [20-11](#)

- SQLNET.IGNORE_ANO_ENCRYPTION_FOR_TCPS
 - setting, [20-15](#)
 - with ANO encryption and TLS authentication, [20-15](#)
- SQLNET.KERBEROS5_CC_NAME parameter, [24-14](#)
- SQLNET.KERBEROS5_CLOCKSKEW
 - parameter, [24-14](#)
- SQLNET.KERBEROS5_CONF parameter, [24-14](#)
- SQLNET.KERBEROS5_REALMS parameter, [24-14](#)
- sqlnet.ora file
 - Common sample, [20-5](#)
 - Kerberos sample, [20-5](#)
 - Oracle Advanced Security checksum sample, [20-5](#)
 - Oracle Advanced Security encryption sample, [20-5](#)
 - parameters for clients and servers using Kerberos, [24-5](#)
 - parameters for clients and servers using RADIUS, [26-7](#)
 - PDBs, [3-37](#)
 - RADIUS sample, [20-5](#)
 - sample, [20-5](#)
 - SQLNET.AUTHENTICATION_KERBEROS5_SERVICE
 - parameter, [24-12](#)
 - SQLNET.AUTHENTICATION_SERVICES parameter, [24-12](#), [27-2](#), [27-4](#), [A-19](#)
 - SQLNET.CRYPTO_CHECKSUM_CLIENT parameter, [20-13](#)
 - SQLNET.CRYPTO_CHECKSUM_SERVER parameter, [20-13](#)
 - SQLNET.CRYPTO_CHECKSUM_TYPES_CLIENT
 - parameter, [20-13](#)
 - SQLNET.CRYPTO_CHECKSUM_TYPES_SERVER
 - parameter, [20-13](#)
 - SQLNET.ENCRYPTION_CLIENT parameter, [27-2](#)
 - SQLNET.ENCRYPTION_SERVER parameter, [20-11](#), [27-2](#)
 - SQLNET.ENCRYPTION_TYPES_CLIENT parameter, [20-11](#)
 - SQLNET.ENCRYPTION_TYPES_SERVER parameter, [20-11](#)
 - SQLNET.KERBEROS5_CC_NAME parameter, [24-14](#)
 - SQLNET.KERBEROS5_CLOCKSKEW parameter, [24-14](#)
 - SQLNET.KERBEROS5_CONF parameter, [24-14](#)
 - SQLNET.KERBEROS5_REALMS parameter, [24-14](#)
 - SSL sample, [20-5](#)
 - Trace File Set Up sample, [20-5](#)
- SQLNET.RADIUS_ALTERNATE parameter, [26-15](#)
- SQLNET.RADIUS_ALTERNATE_PORT
 - parameter, [26-15](#)
- SQLNET.RADIUS_ALTERNATE_RETRIES
 - parameter, [26-15](#)
- SQLNET.RADIUS_ALTERNATE_TIMEOUT
 - parameter, [26-15](#)
- SQLNET.RADIUS_ALTERNATE_TLS_HOST
 - parameter, [26-15](#)
- SQLNET.RADIUS_ALTERNATE_TLS_PORT
 - parameter, [26-15](#)
- SQLNET.RADIUS_AUTHENTICATION_PORT
 - parameter, [26-13](#)
- SQLNET.RADIUS_AUTHENTICATION_RETRIES
 - parameter, [26-13](#)
- SQLNET.RADIUS_AUTHENTICATION_TIMEOUT
 - parameter, [26-13](#)
- SQLNET.RADIUS_AUTHENTICATION_TLS_HOST
 - parameter, [26-11](#)
- SQLNET.RADIUS_AUTHENTICATION_TLS_PORT
 - parameter, [26-11](#)
- SQLNET.RADIUS_SEND_ACCOUNTING
 - parameter, [26-18](#)
- SQLNET.RADIUS_TRANSPORT_PROTOCOL
 - parameter, [26-11](#)
- SSL_VERSION
 - See [SSL_VERSION](#)
- standard audit trail
 - records, purging, [32-10](#)
- standard auditing
 - affected by editions, [30-18](#)
 - archiving audit trail, [32-11](#)
 - privilege auditing
 - about, [30-6](#)
 - multitier environment, [30-33](#)
 - records
 - archiving, [32-11](#)
 - statement auditing
 - multitier environment, [30-33](#)
- statement_types parameter of
 - DBMS_RLS.ADD_POLICY procedure, [14-11](#)
- storage
 - quotas and, [2-11](#)
 - unlimited quotas, [2-12](#)
- stored procedures
 - using privileges granted to PUBLIC role, [4-102](#)
- strong authentication
 - centrally controlling SYSDBA and SYSOPER access to multiple databases, [3-52](#)
 - disabling, [27-2](#)
 - guideline, [A-7](#)
- symbolic links
 - restricting, [A-11](#)
- synchronous authentication mode, RADIUS, [26-3](#)
- synonyms
 - object privileges, [4-75](#)
 - privileges, guidelines on, [A-3](#)
- SYS account
 - auditing, [30-83](#)
 - changing password, [2-21](#)
 - policy enforcement, [14-47](#)

- SYS account (*continued*)
 - privilege analysis, [5-3](#)
 - SYS and SYSTEM
 - passwords, [A-7](#)
 - SYS and SYSTEM accounts
 - auditing, [30-83](#)
 - SYS objects
 - auditing, [30-13](#)
 - SYS schema
 - objects, access to, [4-20](#)
 - SYS user
 - auditing example, [30-8](#)
 - SYS user account
 - about, [2-39](#)
 - SYS_CONTEXT function
 - about, [13-10](#)
 - auditing nondatabase users with, [30-89](#)
 - Boolean expressions used in privilege analysis, [5-6](#)
 - database links, [13-13](#)
 - dynamic SQL statements, [13-12](#)
 - example, [13-14](#)
 - parallel query, [13-12](#)
 - syntax, [13-11](#)
 - unified audit policies, [30-29](#)
 - used in views, [9-9](#)
 - validating users, [12-23](#)
 - SYS_DEFAULT Oracle Virtual Private Database
 - policy group, [14-17](#)
 - SYS_SESSION_ROLES namespace, [13-10](#)
 - SYS.AUD\$ table
 - archiving, [32-11](#)
 - SYS.FGA_LOG\$ table
 - archiving, [32-11](#)
 - SYS.LINK\$ system table, [16-1](#)
 - SYS.SCHEDULER\$_CREDENTIAL system table, [16-1](#)
 - SYS\$UMF user account, [2-39](#)
 - SYSASM privilege
 - password file, [3-55](#)
 - SYSBACKUP privilege
 - operations supported, [4-14](#)
 - password file, [3-55](#)
 - SYSBACKUP user account
 - about, [2-39](#)
 - SYSDBA administrative privilege
 - forcing oracle user to enter password, [4-14](#)
 - SYSDBA privilege, [4-13](#)
 - directory authentication, [3-53](#)
 - Kerberos authentication, [3-54](#)
 - password file, [3-55](#)
 - TLS authentication, [25-3](#)
 - SYSDBG privilege
 - operations supported, [4-16](#)
 - password file, [3-55](#)
 - SYSDBG user account
 - about, [2-39](#)
 - SYSKM privilege
 - operations supported, [4-17](#)
 - password file, [3-55](#)
 - SYSKM user account
 - about, [2-39](#)
 - SYSLOG
 - audit trail records, [32-4](#)
 - capturing audit trail records, [32-5](#)
 - SYSMAN user account, [A-7](#)
 - SYSOPER privilege, [4-13](#)
 - directory authentication, [3-53](#)
 - password file, [3-55](#)
 - SYSRAC privilege
 - operations supported, [4-17](#)
 - System Global Area (SGA), [13-2](#)
 - application contexts, storing in, [13-2](#)
 - global application context information location, [13-28](#)
 - limiting private SQL areas, [2-25](#)
 - system privileges, [A-3](#)
 - about, [4-19](#)
 - ADMIN OPTION, [4-19](#)
 - ANY
 - guidelines for security, [A-11](#)
 - CDBs, [4-30](#)
 - GRANT ANY PRIVILEGE, [4-19](#)
 - granting, [4-92](#)
 - granting and revoking, [4-21](#)
 - granting as a schema privilege, [4-22](#)
 - power of, [4-19](#)
 - preventing from being used on schemas, [4-79](#)
 - restriction needs, [4-20](#)
 - revoking, cascading effect of, [4-101](#)
 - SELECT ANY DICTIONARY, [A-11](#)
 - with common privilege grants, [4-30](#)
 - system requirements
 - Kerberos, [22-7](#)
 - RADIUS, [22-7](#)
 - strong authentication, [22-7](#)
 - TLS, [22-7](#)
 - SYSTEM user account
 - about, [2-39](#)
- ## T
-
- table encryption
 - transparent sensitive data protection policy settings, [15-34](#)
 - tables
 - auditing, [30-11](#)
 - privileges on, [4-81](#)
 - tablespaces
 - assigning defaults for users, [2-9](#)
 - default quota, [2-11](#)

- tablespaces (*continued*)
 - quotas for users, [2-11](#)
 - quotas, viewing, [2-45](#)
 - temporary
 - assigning to users, [2-12](#)
 - unlimited quotas, [2-12](#)
- TCP connection
 - Kerberos krb5.conf configuration, [24-15](#)
- TCPS protocol
 - tnsnames.ora file, used in, [A-19](#)
 - Transport Layer Security, used with, [A-15](#)
- TELNET service, [A-15](#)
- TFTP service, [A-15](#)
- token cards, [22-4](#), [A-7](#)
- trace file
 - set up sample for sqlnet.ora file, [20-5](#)
- trace files
 - access to, importance of restricting, [A-11](#)
 - bad packets, [12-30](#)
 - location of, finding, [13-54](#)
 - Oracle DBaaS-to-IAM client side tracing, [7-40](#)
- traditional auditing
 - desupport, [28-8](#)
- Transparent Data Encryption
 - about, [18-8](#)
 - enabling for FIPS 140-2, [C-8](#)
 - FIPS-supported algorithms, [C-4](#)
 - SYSKM administrative privilege, [4-17](#)
- Transparent Data Encryption (TDE), [16-1](#)
 - TSDP with TDE column encryption, [15-33](#)
- transparent sensitive data protection (TSDP)
 - unified auditing
 - general steps, [15-28](#)
- transparent sensitive data protection (TSDP)
 - about, [15-2](#)
 - altering policies, [15-13](#)
 - benefits, [15-2](#), [15-3](#)
 - bind variables
 - about, [15-17](#)
 - expressions of conditions, [15-18](#)
 - creating policies, [15-5](#)
 - disabling policies, [15-14](#)
 - disabling REDACT_AUDIT policy, [15-20](#)
 - dropping policies, [15-15](#)
 - enabling REDACT_AUDIT policy, [15-20](#)
 - finding information about, [15-35](#)
 - fine-grained auditing
 - general steps, [15-30](#)
 - general steps, [15-2](#)
 - PDBs, [15-4](#)
 - privileges required, [15-4](#)
 - REDACT_AUDIT policy, [15-17](#)
 - sensitive columns in INSERT or UPDATE operations, [15-19](#)
 - sensitive columns in same SELECT query, [15-19](#)
- transparent sensitive data protection (TSDP) (*continued*)
 - sensitive columns in views, [15-20](#)
 - TDE column encryption
 - general steps, [15-33](#)
 - settings used, [15-34](#)
 - unified auditing: settings used, [15-29](#)
 - Virtual Private Database
 - DBMS_RLS.ADD_POLICY parameters, [15-22](#)
 - general steps, [15-22](#)
 - tutorial, [15-24](#)
- transparent sensitive data protection (TSDP); fine-grained auditing
 - settings used, [15-31](#)
- transparent tablespace encryption
 - about, [18-8](#)
- Transport Layer Security
 - compared with native network encryption, [20-2](#)
 - FIPS-supported cipher suites, [C-6](#)
- Transport Layer Security (SSL)
 - sqlnet.ora file sample, [20-5](#)
- Transport Layer Security (TLS), [22-5](#)
 - allowing certificates from earlier algorithms, [21-41](#)
 - ANO encryption and, [20-15](#)
 - certificate key algorithm, [A-19](#)
 - cipher suites, [A-19](#)
 - combining with other authentication methods, [21-35](#)
 - configuration files, securing, [A-19](#)
 - configuration troubleshooting, [21-60](#)
 - configuring ANO encryption with, [20-15](#)
 - FIPS library location setting (SSLFIPS_LIB), [C-9](#)
 - FIPS mode setting (SSLFIPS_140), [C-9](#)
 - guidelines for security, [A-19](#)
 - listener, administering, [A-15](#)
 - MD5 certification, [B-21](#)
 - mode, [A-19](#)
 - Oracle Internet Directory, [25-2](#), [25-16](#)
 - pass phrase, [A-19](#)
 - RSA private key, [A-19](#)
 - securing TLS connection, [A-19](#)
 - server.key file, [A-19](#)
 - SHA-1 certification, [B-21](#)
 - system requirements, [22-7](#)
 - TCPS, [A-19](#)
 - wallet search order, [21-30](#)
- Transport Layer Security (TLS) troubleshooting
 - checking connection, [25-22](#)
 - checking sqlnet.ora and listener.ora wallet settings, [25-24](#)
 - checking SSL_VERSION parameter, [25-23](#)
 - checking wallet file permissions, [25-23](#)
 - SQL*Net and listener tracing, [25-25](#)

- Transport Layer Security on Oracle RAC
 - cluster node, testing configuration, [21-59](#)
 - listener.ora, [21-58](#)
 - local_listener startup parameter, [21-54](#)
 - restarting instances, [21-58](#)
 - restarting listeners, [21-58](#)
 - sqlnet.ora, [21-58](#)
 - TCPS protocol endpoints, [21-53](#)
 - wallet and certificate creation, [21-55](#)
 - wallet creation in nodes, [21-57](#)
- Transport Layer Security, X.509 Certificates
 - about, [25-5](#)
 - about configuring MCS on client, [25-12](#)
 - configuring MCS on client, [25-14](#)
 - configuring sqlnet.ora on client, [25-11](#)
 - configuring sqlnet.ora on server, [25-8](#)
 - configuring TNS_NAMES on client, [25-13](#)
 - configuring tnsnames.ora on client, [25-12](#)
 - creating and configuring server wallet, [25-6](#)
 - external user, [25-10](#)
 - Grid Infrastructure, listener.ora on server, [25-9](#)
 - initialization parameters on server, [25-10](#)
 - logical volume management, listener.ora on server, [25-8](#)
 - restarting and checking listener on server, [25-10](#)
 - shutting down listener on server, [25-7](#)
 - testing MCS configuration, SQL*Plus, [25-15](#)
 - testing MCS configuration, tnsping, [25-14](#)
- Transport Layer Security(TLS)
 - configuring for SYSDBA or SYSOPER access, [25-3](#)
- triggers
 - auditing, [30-11](#), [30-16](#)
 - CREATE TRIGGER ON, [12-28](#)
 - logon
 - examples, [13-15](#)
 - externally initialized application contexts, [13-15](#)
 - privileges for executing, [9-2](#)
 - roles, [4-38](#)
 - WHEN OTHERS exception, [13-16](#)
- troubleshooting, [24-29](#)
 - finding errors by checking trace files, [13-54](#)
 - Kerberos common configuration problems, [24-28](#)
 - ORA-01017 connection errors in CMU configuration, [6-39](#)
 - ORA-01017 errors in Kerberos configuration, [24-30](#)
 - ORA-12631 errors in Kerberos configuration, [24-29](#)
 - ORA-12650 and ORA-12660 errors in native network encryption configuration, [20-17](#)
- troubleshooting (*continued*)
 - ORA-28030 connection errors in CMU configuration, [6-41](#)
 - ORA-28274 connection errors in CMU configuration, [6-39](#)
 - ORA-28276 connection errors in CMU configuration, [6-40](#)
 - trace files for in CMU connection errors, [6-41](#)
- trusted procedure
 - database session-based application contexts, [13-2](#)
- tnsnames.ora configuration file, [A-19](#)
- tutorials, [13-17](#), [14-27](#)
 - application context, database session-based, [13-17](#)
 - auditing
 - creating policy to audit nondatabase users, [30-88](#)
 - creating policy using email alert, [31-12](#)
 - definer's rights, database links, [9-26](#)
 - external network services, using email alert, [31-12](#)
 - global application context with client session ID, [13-44](#)
 - invoker's rights procedure using CBAC, [9-17](#)
 - nondatabase users
 - creating Oracle Virtual Private Database policy group, [14-38](#)
 - global application context, [13-44](#)
 - Oracle Virtual Private Database
 - policy groups, [14-38](#)
 - policy implementing, [14-31](#)
 - simple example, [14-28](#)
 - privilege analysis, [5-22](#)
 - privilege analysis for ANY privileges, [5-18](#)
 - schema privilege use, [5-27](#)
 - TSDP with VPD, [15-24](#)
 - See also* examples
- types
 - creating, [4-89](#)
 - privileges on, [4-87](#)
 - user defined
 - creation requirements, [4-89](#)

U

- UDP and TCP ports
 - close for ALL disabled services, [A-15](#)
- UDP connection
 - Kerberos krb5.conf configuration, [24-15](#)
- UGA
 - See* User Global Area (UGA)
- unified audit policies, [28-1](#), [29-14](#)
 - about custom, [30-1](#)
 - best practices for creating, [30-2](#)

- unified audit policies (*continued*)
 - dropping
 - about, [30-87](#)
 - procedure, [30-88](#)
 - location of, [30-2](#)
 - predefined
 - ORA_ACCOUNT_MGMT, [29-7](#)
 - ORA_ALL_TOPLEVEL_ACTIONS, [29-10](#)
 - ORA_CIS_RECOMMENDATIONS, [29-8](#)
 - ORA_DATABASE_PARAMETER, [29-7](#)
 - ORA_DV_DEFAULT_PROTECTION, [29-13](#)
 - ORA_DV_SCHEMA_CHANGES, [29-13](#)
 - ORA_LOGIN_LOGOUT, [29-10](#)
 - ORA_OLS_SCHEMA_CHANGES, [29-14](#)
 - ORA_SECURECONFIG, [29-6](#)
 - ORA_STIG_RECOMMENDATIONS, [29-9](#)
 - ORA\$DICTIONARY_SENS_COL_ACCESS, [29-11](#)
 - syntax for creating, [30-2](#)
 - top-level statements, [30-22](#)
 - users, applying to, [30-83](#)
 - users, excluding, [30-83](#)
 - users, success or failure, [30-83](#)
- unified audit policies, administrative users
 - configuring, [30-10](#)
 - example, [30-10](#)
 - users that can be audited, [30-9](#)
- unified audit policies, altering
 - about, [30-80](#)
 - configuring, [30-81](#)
 - examples, [30-82](#)
- unified audit policies, application common policies, [30-38](#)
- unified audit policies, application containers
 - example, [30-41](#)
- unified audit policies, CDBs
 - about, [30-36](#)
 - appearance in audit trail, [30-42](#)
 - configuring, [30-38](#)
 - examples, [30-40](#), [30-41](#)
- unified audit policies, column level auditing, [30-12](#)
- unified audit policies, conditions
 - about, [30-29](#)
 - configuring, [30-29](#)
 - examples, [30-31](#)
- unified audit policies, disabling
 - about, [30-83](#), [30-86](#)
 - configuring, [30-86](#)
- unified audit policies, enabling
 - about, [30-83](#)
 - configuring, [30-85](#)
 - for groups of users through roles, [30-83](#)
- unified audit policies, object actions
 - about, [30-11](#)
 - actions that can be audited, [30-11](#)
 - appearance in audit trail, [30-15](#)
- unified audit policies, object actions (*continued*)
 - columns, [30-14](#)
 - configuring, [30-13](#)
 - dictionary tables
 - auditing, [30-13](#)
 - examples, [30-13](#)
 - GRANT operations, [30-13](#)
 - SYS objects, [30-13](#)
- unified audit policies, objects actions
 - REVOKE operations, [30-13](#)
- unified audit policies, Oracle Data Miner
 - about, [30-77](#)
- unified audit policies, Oracle Data Pump
 - about, [30-71](#)
 - appearance in audit trail, [30-72](#), [30-74](#)
 - configuring, [30-71](#)
 - examples, [30-71](#)
 - how events appear in audit trail, [30-72](#)
- unified audit policies, Oracle Database Real Application Security
 - about, [30-57](#)
 - configuring, [30-62](#)
 - events to audit, [30-57](#)
 - examples, [30-62](#)
 - how events appear in audit trail, [30-63](#)
 - predefined
 - about, [29-11](#)
 - ORA_RAS_POLICY_MGMT, [29-12](#)
 - ORA_RAS_SESSION_MGMT, [29-12](#)
- unified audit policies, Oracle Database Vault
 - about, [30-48](#)
 - appearance in audit trail, [30-56](#)
 - attributes to audit, [30-49](#)
 - configuring, [30-54](#)
 - data dictionary views, [30-48](#)
 - example of auditing factors, [30-55](#)
 - example of auditing realm, [30-55](#)
 - example of auditing rule set, [30-55](#)
 - example of auditing two events, [30-55](#)
 - how events appear in audit trail, [30-56](#)
- unified audit policies, Oracle Firewall
 - example, [30-46](#)
- unified audit policies, Oracle Label Security
 - about, [30-65](#)
 - appearance in audit trail, [30-70](#)
 - configuring, [30-68](#)
 - examples, [30-69](#)
 - how events appear in audit trail, [30-70](#)
 - LBACSYS.ORA_GET_AUDITED_LABEL
 - function, [30-70](#)
- unified audit policies, Oracle Machine Learning for SQL
 - configuring, [30-78](#)
 - how events appear in audit trail, [30-79](#)
- unified audit policies, Oracle Recovery Manager
 - about, [30-63](#)

- unified audit policies, Oracle Recovery Manager (*continued*)
 - how events appear in audit trail, [30-64](#)
- unified audit policies, Oracle SQL*Loader
 - about, [30-73](#)
 - configuring, [30-74](#)
 - example, [30-74](#)
 - how events appear in audit trail, [30-74](#)
- unified audit policies, Oracle XML DB HTTP and FTP protocols
 - about, [30-75](#)
 - configuring, [30-75](#)
 - example of policy for 401 AUTH HTTP errors, [30-76](#)
 - example of policy for all FTP messages, [30-76](#)
 - example of policy for failed HTTP messages, [30-75](#)
 - how appears in audit trail, [30-76](#)
- unified audit policies, privileges
 - about, [30-6](#)
 - appearance in audit trail, [30-8](#)
 - configuring, [30-8](#)
 - examples, [30-8](#)
 - privileges that can be audited, [30-7](#)
 - privileges that cannot be audited, [30-7](#)
- unified audit policies, roles
 - about, [30-5](#)
 - configuring, [30-5](#)
 - examples, [30-6](#)
- unified audit policies, SQL Firewall
 - how events appear in audit trail, [30-46](#)
- unified audit policies, top-level statements, [30-22](#)
 - appearance in audit trail, [30-28](#)
 - how events appear in audit trail, [30-28](#)
- unified audit policies, virtual columns, [30-12](#)
- unified audit session ID, finding, [30-32](#)
- unified audit trail
 - about, [28-5](#)
 - archiving, [32-11](#)
 - disk space size, [32-3](#)
 - improving performance of, [32-8](#)
 - loading audit records to, [32-7](#)
 - Oracle Data Pump, [32-9](#)
 - partition management, [32-8](#)
 - when records are created, [32-2](#)
 - writing audit trail records to AUDSYS
 - about, [32-3](#)
 - immediate-write mode, [32-3](#)
 - minimum flush threshold for queues, [32-2](#)
 - queued-write mode, [32-3](#)
- unified audit trail, object actions
 - READ object actions, [30-19](#)
 - SELECT object actions, [30-19](#)
- unified audit trail, Oracle Machine Learning for SQL
 - examples, [30-78](#)
- unified audit trail, top-level statements, [30-22](#), [30-23](#)
- unified audit trail
 - Oracle Data Pump audit events, [30-71](#)
 - Oracle Database Real Application Security
 - ALL audit events, [30-62](#)
 - Oracle Database Real Application Security security class and ACL audit events, [30-59](#)
 - Oracle Database Real Application Security session audit events, [30-60](#)
 - Oracle Database Real Application Security user, privilege, and role audit events, [30-58](#)
 - Oracle Database Vault command rule events, [30-51](#)
 - Oracle Database Vault Data Pump events, [30-53](#)
 - Oracle Database Vault enable and disable events, [30-54](#)
 - Oracle Database Vault factor events, [30-51](#)
 - Oracle Database Vault OLS events, [30-53](#)
 - Oracle Database Vault realm events, [30-49](#)
 - Oracle Database Vault rule set and rule events, [30-50](#)
 - Oracle Database Vault secure application role events, [30-52](#)
 - Oracle Label Security audit events, [30-66](#)
 - Oracle Label Security user session label events, [30-68](#)
 - Oracle Machine Learning for SQL audit events, [30-77](#)
 - Oracle Recovery Manager audit events, [30-64](#)
 - Oracle SQL*Loader Direct Load Path audit events, [30-73](#)
- unified auditing
 - benefits, [28-5](#)
 - purging records
 - example, [32-24](#)
 - general steps for on-demand purges, [32-13](#)
 - general steps for scheduled purges, [32-13](#)
 - traditional audit desupport, [28-8](#)
 - transparent sensitive data protection policy settings, [15-29](#)
 - tutorial, [30-88](#)
- unified auditing
 - TSDP policies and, [15-28](#)
- UNIFIED_AUDIT_COMMON_SYSTEMLOG
 - initialization parameter
 - using, [32-5](#)
- UNIFIED_AUDIT_SYSTEMLOG initialization parameter
 - about, [32-4](#)
 - using, [32-5](#)

- UNIFIED_AUDIT_TRAIL data dictionary view
 - best practices for using, [A-24](#)
- UNLIMITED TABLESPACE privilege, [2-12](#)
- UPDATE privilege
 - revoking, [4-100](#)
- user accounts
 - administrative user passwords, [A-7](#)
 - application common user
 - about, [2-3](#)
 - CDB common user
 - about, [2-3](#)
 - common
 - creating, [2-14](#)
 - default user account, [A-7](#)
 - local
 - creating, [2-16](#)
 - local user
 - about, [2-5](#)
 - password guidelines, [A-7](#)
 - passwords, encrypted, [A-7](#)
 - predefined
 - administrative, [2-39](#)
 - non-administrative, [2-42](#)
 - predefined sample schemas, [2-42](#)
 - predefined schema, [2-38](#)
 - privileges required to create, [2-6](#)
 - proxy users, [3-74](#)
- user accounts, predefined
 - ANONYMOUS, [2-39](#)
 - ASMSNMP, [2-39](#)
 - AUDSYS, [2-39](#)
 - CTXSYS, [2-39](#)
 - DBSFUSER, [2-39](#)
 - DBSNMP, [2-39](#)
 - DGPDB_INT, [2-39](#)
 - DIP, [2-42](#)
 - GSMROOTUSER, [2-39](#)
 - LBACSYS, [2-39](#)
 - MDDATA, [2-42](#)
 - MDSYS, [2-39](#)
 - OJVMSYS, [2-39](#)
 - OLAPSYS, [2-39](#)
 - ORACLE_OCM, [2-42](#)
 - ORDDATA, [2-39](#)
 - ORDPLUGINS, [2-39](#)
 - ORDSYS, [2-39](#)
 - OUTLN, [2-39](#)
 - REMOTE_SCHEDULER_AGENT, [2-39](#)
 - SI_INFORMTN_SCHEMA, [2-39](#)
 - SYS, [2-39](#)
 - SYS\$UMF, [2-39](#)
 - SYSBACKUP, [2-39](#)
 - SYSDG, [2-39](#)
 - SYSKM, [2-39](#)
 - SYSTEM, [2-39](#)
 - WMSYS, [2-39](#)
- user accounts, predefined (*continued*)
 - XDB, [2-39](#)
 - XS\$NULL, [2-42](#)
- User Global Area (UGA), [13-2](#)
 - application contexts, storing in, [13-2](#)
- user names
 - schemas, [12-26](#)
- user privileges
 - CDBs, [4-12](#)
- USER pseudo column, [4-83](#)
- user sessions, multiple within single database
 - connection, [3-77](#)
- USERENV function
 - used in views, [9-9](#)
- USERENV namespace, [3-83](#)
 - about, [13-11](#)
 - See also CLIENT_IDENTIFIER USERENV attribute
- users
 - administrative option (ADMIN OPTION), [4-93](#)
 - altering, [2-18](#)
 - altering common users, [2-18](#)
 - altering local users, [2-18](#)
 - application users not known to database, [3-82](#)
 - assigning unlimited quotas for, [2-12](#)
 - auditing, [30-83](#)
 - database role, current, [12-25](#)
 - default roles, changing, [2-17](#)
 - default tablespaces, [2-9](#)
 - dropping, [2-37](#)
 - dropping profiles and, [2-29](#)
 - dropping roles and, [4-55](#)
 - enabling roles for, [12-25](#)
 - enterprise, [4-53](#)
 - enterprise, shared schema protection, [12-27](#)
 - external authentication
 - assigning profiles, [2-29](#)
 - finding information about, [2-43](#)
 - finding information about authentication, [3-86](#)
 - global
 - assigning profiles, [2-29](#)
 - hosts, connecting to multiple
 - See external network services, fine-grained access to, [10-2](#)
 - information about, viewing, [2-44](#)
 - listing roles granted to, [4-112](#)
 - memory use, viewing, [2-46](#)
 - names
 - case sensitivity, [2-8](#)
 - how stored in database, [2-8](#)
 - nondatabase, [13-29](#), [13-36](#)
 - objects after dropping, [2-37](#)
 - password encryption, [3-3](#)
 - privileges
 - for changing passwords, [2-18](#)
 - for creating, [2-6](#)

users (*continued*)

- privileges (*continued*)
 - granted to, listing, [4-112](#)
 - of current database role, [12-25](#)
- profiles
 - assigning, [2-29](#)
 - creating, [2-28](#)
 - specifying, [2-13](#)
- profiles, CDB or application, [2-29](#)
- proxy authentication, [3-73](#)
- proxy users, connecting as, [3-73](#)
- PUBLIC role, [4-38](#), [4-102](#)
- quota limits for tablespace, [2-11](#)
- read-only configuration, [4-108](#)
- restricting application roles, [4-56](#)
- restrictions on user names, [2-8](#)
- roles and, [4-36](#)
 - for types of users, [4-38](#)
- schema-independent, [12-27](#)
- security domains of, [4-38](#)
- security, about, [2-1](#)
- tablespace quotas, [2-11](#)
- tablespace quotas, viewing, [2-45](#)
- user accounts, creating, [2-6](#)
- user models and Oracle Virtual Private Database, [14-52](#)
- user name, specifying with CREATE USER statement, [2-8](#)
- views for finding information about, [2-43](#)

users supported, [6-4](#)

utlplwmg.sql

- about, [3-26](#)

V

valid node checking, [A-15](#)

validating, [6-29](#)

views, [4-110](#)

- about, [4-82](#)
- access control list data
 - external network services, [10-23](#)
 - wallet access, [10-23](#)
- application contexts, [13-54](#)
- audit management settings, [32-24](#)
- audit trail usage, [29-17](#)
- audit trail usage for fine grained auditing, [31-18](#)
- audited activities, [29-17](#)
- audited activities from custom audit policies, [30-91](#)
- auditing, [30-11](#)
- authentication, [3-86](#)
- bind variables in TSDP sensitive columns, [15-20](#)
- custom audit policy audit trail usage, [30-91](#)
- DBA_COL_PRIVS, [4-113](#)

views (*continued*)

- DBA_HOST_ACES, [10-23](#)
- DBA_HOST_ACLS, [10-23](#)
- DBA_ROLE_PRIVS, [4-112](#)
- DBA_ROLES, [4-114](#)
- DBA_SCHEMA_PRIVS, [4-112](#)
- DBA_SYS_PRIVS, [4-112](#)
- DBA_TAB_PRIVS, [4-113](#)
- DBA_USERS_WITH_DEFPWD, [3-6](#)
- DBA_WALLET_ACES, [10-23](#)
- DBA_WALLET_ACLS, [10-23](#)
- definer's rights, [9-9](#)
- fine-grained audited activities, [31-18](#)
- invoker's rights, [9-9](#)
- Oracle Virtual Private Database policies, [14-53](#)
- privileges, [4-82](#), [4-110](#)
- privileges to query views in other schemas, [4-83](#)
- profiles, [2-43](#)
- ROLE_SYS_PRIVS, [4-114](#)
- ROLE_TAB_PRIVS, [4-114](#)
- security applications of, [4-83](#)
- SESSION_PRIVS, [4-113](#)
- SESSION_ROLES, [4-113](#)
- transparent sensitive data protection, [15-35](#)
- USER_HOST_ACES, [10-23](#)
- USER_WALLET_ACES, [10-23](#)
- users, [2-43](#)

Virtual Private Database

- See Oracle Virtual Private Database

VPD

- See Oracle Virtual Private Database

vulnerable run-time call, [A-3](#)

- made more secure, [A-3](#)

W

wallets, [10-2](#)

- about, [B-2](#)
- adding certificate to, [6-17](#)
- authentication method, [3-66](#)
- certificates
 - adding to wallet, [6-17](#)
- deleting, [B-13](#)
- general process of management, [B-6](#)
- search paths, [B-7](#)
- system wallet, [B-15](#)
- tools to manage, [B-6](#)
 - See also access control lists (ACL), wallet access

Web applications

- user connections, [13-29](#), [13-36](#)

Web-based applications

- Oracle Virtual Private Database, how it works with, [14-52](#)

- WHEN OTHERS exceptions
 - logon triggers, used in, [13-16](#)
 - Windows Event Viewer
 - capturing audit trail records, [32-5](#)
 - Windows installations
 - security guideline, [A-10](#)
 - Windows native authentication, [3-55](#)
 - WITH GRANT OPTION clause
 - about, [4-95](#)
 - user and role grants, [4-73](#)
 - WM_ADMIN_ROLE role, [4-40](#)
 - WMSYS user account, [2-39](#)
- X
-
- X.509 certificates, [25-5](#)
 - guidelines for security, [A-7](#)
 - XDB user account, [2-39](#)
 - XDB_SET_INVOKER role, [4-40](#)
 - XDB_WEBSERVICES role, [4-40](#)
 - XDB_WEBSERVICES_OVER_HTTP role
 - about, [4-40](#)
 - XDB_WEBSERVICES_WITH_PUBLIC role, [4-40](#)
 - XDBADMIN role, [4-40](#)
 - XS_CACHE_ADMIN role, [4-40](#)
 - XS_NAMESPACE_ADMIN role, [4-40](#)
 - XS_NSATTR_ADMIN role, [4-40](#)
 - XS_RESOURCE role, [4-40](#)
 - XS\$NULL user account, [2-42](#)
 - XSTREAM_APPLY role, [4-40](#)
 - XSTREAM_CAPTURE role, [4-40](#)