

# Oracle® Data Mining

## API Guide



19c  
E97869-10  
March 2025

The Oracle logo, consisting of a solid red square with the word "ORACLE" in white, uppercase, sans-serif font centered within it.

ORACLE®

This software and related documentation are provided under a license agreement containing restrictions on use and disclosure and are protected by intellectual property laws. Except as expressly permitted in your license agreement or allowed by law, you may not use, copy, reproduce, translate, broadcast, modify, license, transmit, distribute, exhibit, perform, publish, or display any part, in any form, or by any means. Reverse engineering, disassembly, or decompilation of this software, unless required by law for interoperability, is prohibited.

The information contained herein is subject to change without notice and is not warranted to be error-free. If you find any errors, please report them to us in writing.

If this is software, software documentation, data (as defined in the Federal Acquisition Regulation), or related documentation that is delivered to the U.S. Government or anyone licensing it on behalf of the U.S. Government, then the following notice is applicable:

U.S. GOVERNMENT END USERS: Oracle programs (including any operating system, integrated software, any programs embedded, installed, or activated on delivered hardware, and modifications of such programs) and Oracle computer documentation or other Oracle data delivered to or accessed by U.S. Government end users are "commercial computer software," "commercial computer software documentation," or "limited rights data" pursuant to the applicable Federal Acquisition Regulation and agency-specific supplemental regulations. As such, the use, reproduction, duplication, release, display, disclosure, modification, preparation of derivative works, and/or adaptation of i) Oracle programs (including any operating system, integrated software, any programs embedded, installed, or activated on delivered hardware, and modifications of such programs), ii) Oracle computer documentation and/or iii) other Oracle data, is subject to the rights and limitations specified in the license contained in the applicable contract. The terms governing the U.S. Government's use of Oracle cloud services are defined by the applicable contract for such services. No other rights are granted to the U.S. Government.

This software or hardware is developed for general use in a variety of information management applications. It is not developed or intended for use in any inherently dangerous applications, including applications that may create a risk of personal injury. If you use this software or hardware in dangerous applications, then you shall be responsible to take all appropriate fail-safe, backup, redundancy, and other measures to ensure its safe use. Oracle Corporation and its affiliates disclaim any liability for any damages caused by use of this software or hardware in dangerous applications.

Oracle®, Java, MySQL, and NetSuite are registered trademarks of Oracle and/or its affiliates. Other names may be trademarks of their respective owners.

Intel and Intel Inside are trademarks or registered trademarks of Intel Corporation. All SPARC trademarks are used under license and are trademarks or registered trademarks of SPARC International, Inc. AMD, Epyc, and the AMD logo are trademarks or registered trademarks of Advanced Micro Devices. UNIX is a registered trademark of The Open Group.

This software or hardware and documentation may provide access to or information about content, products, and services from third parties. Oracle Corporation and its affiliates are not responsible for and expressly disclaim all warranties of any kind with respect to third-party content, products, and services unless otherwise set forth in an applicable agreement between you and Oracle. Oracle Corporation and its affiliates will not be responsible for any loss, costs, or damages incurred due to your access to or use of third-party content, products, or services, except as set forth in an applicable agreement between you and Oracle.

# Contents

## Preface

---

Audience	xxi
Documentation Accessibility	xxi
Diversity and Inclusion	xxi
Related Resources	xxi
Conventions	xxii

## Part I Introductions

---

### 1 Introduction to Oracle Data Mining

---

1.1	About Oracle Data Mining	1-1
1.2	Data Mining in the Database Kernel	1-1
1.3	Data Mining in Oracle Exadata	1-2
1.4	About Partitioned Model	1-3
1.5	Interfaces to Oracle Data Mining	1-3
1.5.1	PL/SQL API	1-3
1.5.2	SQL Functions	1-4
1.5.3	Oracle Data Miner	1-4
1.5.4	Predictive Analytics	1-5
1.6	Overview of Database Analytics	1-6

### 2 Oracle Data Mining Basics

---

2.1	Mining Functions	2-1
2.1.1	Supervised Data Mining	2-1
2.1.1.1	Supervised Learning: Testing	2-2
2.1.1.2	Supervised Learning: Scoring	2-2
2.1.2	Unsupervised Data Mining	2-2
2.1.2.1	Unsupervised Learning: Scoring	2-3
2.2	Algorithms	2-3
2.2.1	Oracle Data Mining Supervised Algorithms	2-4
2.2.2	Oracle Data Mining Unsupervised Algorithms	2-4

2.3	Data Preparation	2-6
2.3.1	Oracle Data Mining Simplifies Data Preparation	2-6
2.3.2	Case Data	2-6
2.3.2.1	Nested Data	2-6
2.3.3	Text Data	2-7
2.4	In-Database Scoring	2-7
2.4.1	Parallel Execution and Ease of Administration	2-7
2.4.2	SQL Functions for Model Apply and Dynamic Scoring	2-7

## Part II Mining Functions

---

### 3 Regression

---

3.1	About Regression	3-1
3.1.1	How Does Regression Work?	3-1
3.1.1.1	Linear Regression	3-2
3.1.1.2	Multivariate Linear Regression	3-3
3.1.1.3	Regression Coefficients	3-3
3.1.1.4	Nonlinear Regression	3-3
3.1.1.5	Multivariate Nonlinear Regression	3-3
3.1.1.6	Confidence Bounds	3-4
3.2	Testing a Regression Model	3-4
3.2.1	Regression Statistics	3-4
3.2.1.1	Root Mean Squared Error	3-4
3.2.1.2	Mean Absolute Error	3-5
3.3	Regression Algorithms	3-5

### 4 Classification

---

4.1	About Classification	4-1
4.2	Testing a Classification Model	4-2
4.2.1	Confusion Matrix	4-2
4.2.2	Lift	4-3
4.2.2.1	Lift Statistics	4-3
4.2.3	Receiver Operating Characteristic (ROC)	4-4
4.2.3.1	The ROC Curve	4-4
4.2.3.2	Area Under the Curve	4-4
4.2.3.3	ROC and Model Bias	4-5
4.2.3.4	ROC Statistics	4-5
4.3	Biassing a Classification Model	4-5
4.3.1	Costs	4-5
4.3.1.1	Costs Versus Accuracy	4-6

4.3.1.2	Positive and Negative Classes	4-6
4.3.1.3	Assigning Costs and Benefits	4-7
4.3.2	Priors and Class Weights	4-8
4.4	Classification Algorithms	4-8

## 5 Anomaly Detection

---

5.1	About Anomaly Detection	5-1
5.1.1	One-Class Classification	5-1
5.1.2	Anomaly Detection for Single-Class Data	5-2
5.1.3	Anomaly Detection for Finding Outliers	5-2
5.2	Anomaly Detection Algorithm	5-2

## 6 Clustering

---

6.1	About Clustering	6-1
6.1.1	How are Clusters Computed?	6-1
6.1.2	Scoring New Data	6-2
6.1.3	Hierarchical Clustering	6-2
6.1.3.1	Rules	6-2
6.1.3.2	Support and Confidence	6-2
6.2	Evaluating a Clustering Model	6-2
6.3	Clustering Algorithms	6-2

## 7 Association

---

7.1	About Association	7-1
7.1.1	Association Rules	7-1
7.1.2	Market-Basket Analysis	7-1
7.1.3	Association Rules and eCommerce	7-2
7.2	Transactional Data	7-2
7.3	Association Algorithm	7-3

## 8 Feature Selection and Extraction

---

8.1	Finding the Best Attributes	8-1
8.2	About Feature Selection and Attribute Importance	8-1
8.2.1	Attribute Importance and Scoring	8-2
8.3	About Feature Extraction	8-2
8.3.1	Feature Extraction and Scoring	8-2
8.4	Algorithms for Attribute Importance and Feature Extraction	8-2

## 9 Time Series

---

9.1	About Time Series	9-1
9.2	Choosing a Time Series Model	9-1
9.3	Time Series Statistics	9-2
9.3.1	Conditional Log-Likelihood	9-2
9.3.2	Mean Square Error (MSE) and Other Error Measures	9-3
9.3.3	Irregular Time Series	9-3
9.3.4	Build Apply	9-4
9.4	Time Series Algorithm	9-4

## Part III Algorithms

---

## 10 Apriori

---

10.1	About Apriori	10-1
10.2	Association Rules and Frequent Itemsets	10-2
10.2.1	Antecedent and Consequent	10-2
10.2.2	Confidence	10-2
10.3	Data Preparation for Apriori	10-2
10.3.1	Native Transactional Data and Star Schemas	10-2
10.3.2	Items and Collections	10-2
10.3.3	Sparse Data	10-3
10.3.4	Improved Sampling	10-3
10.3.4.1	Sampling Implementation	10-3
10.4	Calculating Association Rules	10-4
10.4.1	Itemsets	10-4
10.4.2	Frequent Itemsets	10-5
10.4.3	Example: Calculating Rules from Frequent Itemsets	10-5
10.4.4	Aggregates	10-7
10.4.5	Example: Calculating Aggregates	10-7
10.4.6	Including and Excluding Rules	10-8
10.4.7	Performance Impact for Aggregates	10-8
10.5	Evaluating Association Rules	10-9
10.5.1	Support	10-9
10.5.2	Minimum Support Count	10-9
10.5.3	Confidence	10-9
10.5.4	Reverse Confidence	10-10
10.5.5	Lift	10-10

## 11 CUR Matrix Decomposition

---

11.1	About CUR Matrix Decomposition	11-1
11.2	Singular Vectors	11-1
11.3	Statistical Leverage Score	11-2
11.4	Column (Attribute) Selection and Row Selection	11-2
11.5	CUR Matrix Decomposition Algorithm Configuration	11-3

## 12 Decision Tree

---

12.1	About Decision Tree	12-1
12.1.1	Decision Tree Rules	12-1
12.1.1.1	Confidence and Support	12-2
12.1.2	Advantages of Decision Trees	12-2
12.1.3	XML for Decision Tree Models	12-3
12.2	Growing a Decision Tree	12-3
12.2.1	Splitting	12-4
12.2.2	Cost Matrix	12-5
12.2.3	Preventing Over-Fitting	12-5
12.3	Tuning the Decision Tree Algorithm	12-5
12.4	Data Preparation for Decision Tree	12-5

## 13 Expectation Maximization

---

13.1	About Expectation Maximization	13-1
13.1.1	Expectation Step and Maximization Step	13-1
13.1.2	Probability Density Estimation	13-1
13.2	Algorithm Enhancements	13-1
13.2.1	Scalability	13-2
13.2.2	High Dimensionality	13-2
13.2.3	Number of Components	13-3
13.2.4	Parameter Initialization	13-3
13.2.5	From Components to Clusters	13-3
13.3	Configuring the Algorithm	13-3
13.4	Data Preparation for Expectation Maximization	13-4

## 14 Explicit Semantic Analysis

---

14.1	About Explicit Semantic Analysis	14-1
14.1.1	Scoring with ESA	14-2
14.1.2	Scoring Large ESA Models	14-2
14.2	ESA for Text Mining	14-2
14.3	Data Preparation for ESA	14-2

## 15 Exponential Smoothing

---

15.1	About Exponential Smoothing	15-1
15.1.1	Exponential Smoothing Models	15-1
15.1.2	Simple Exponential Smoothing	15-2
15.1.3	Models with Trend but No Seasonality	15-2
15.1.4	Models with Seasonality but No Trend	15-2
15.1.5	Models with Trend and Seasonality	15-2
15.1.6	Prediction Intervals	15-3
15.2	Data Preparation for Exponential Smoothing Models	15-3
15.2.1	Input Data	15-3
15.2.2	Accumulation	15-4
15.2.3	Missing Value	15-4
15.2.4	Prediction	15-4
15.2.5	Parallellism by Partition	15-5

## 16 Generalized Linear Models

---

16.1	About Generalized Linear Models	16-1
16.2	GLM in Oracle Data Mining	16-2
16.2.1	Interpretability and Transparency	16-2
16.2.2	Wide Data	16-2
16.2.3	Confidence Bounds	16-2
16.2.4	Ridge Regression	16-3
16.2.4.1	Configuring Ridge Regression	16-3
16.2.4.2	Ridge and Confidence Bounds	16-3
16.2.4.3	Ridge and Data Preparation	16-4
16.3	Scalable Feature Selection	16-4
16.3.1	Feature Selection	16-4
16.3.1.1	Configuring Feature Selection	16-4
16.3.1.2	Feature Selection and Ridge Regression	16-4
16.3.2	Feature Generation	16-5
16.3.2.1	Configuring Feature Generation	16-5
16.4	Tuning and Diagnostics for GLM	16-5
16.4.1	Build Settings	16-5
16.4.2	Diagnostics	16-6
16.4.2.1	Coefficient Statistics	16-6
16.4.2.2	Global Model Statistics	16-6
16.4.2.3	Row Diagnostics	16-6
16.5	GLM Solvers	16-6



16.6	Data Preparation for GLM	16-7
16.6.1	Data Preparation for Linear Regression	16-7
16.6.2	Data Preparation for Logistic Regression	16-8
16.6.3	Missing Values	16-8
16.7	Linear Regression	16-9
16.7.1	Coefficient Statistics for Linear Regression	16-9
16.7.2	Global Model Statistics for Linear Regression	16-9
16.7.3	Row Diagnostics for Linear Regression	16-10
16.8	Logistic Regression	16-10
16.8.1	Reference Class	16-11
16.8.2	Class Weights	16-11
16.8.3	Coefficient Statistics for Logistic Regression	16-11
16.8.4	Global Model Statistics for Logistic Regression	16-11
16.8.5	Row Diagnostics for Logistic Regression	16-12

## 17 k-Means

---

17.1	About k-Means	17-1
17.1.1	Oracle Data Mining Enhanced k-Means	17-1
17.1.2	Centroid	17-1
17.2	k-Means Algorithm Configuration	17-2
17.3	Data Preparation for k-Means	17-2

## 18 Minimum Description Length

---

18.1	About MDL	18-1
18.1.1	Compression and Entropy	18-1
18.1.1.1	Values of a Random Variable: Statistical Distribution	18-2
18.1.1.2	Values of a Random Variable: Significant Predictors	18-2
18.1.1.3	Total Entropy	18-2
18.1.2	Model Size	18-2
18.1.3	Model Selection	18-2
18.1.4	The MDL Metric	18-3
18.2	Data Preparation for MDL	18-3

## 19 Naive Bayes

---

19.1	About Naive Bayes	19-1
19.1.1	Advantages of Naive Bayes	19-2
19.2	Tuning a Naive Bayes Model	19-3
19.3	Data Preparation for Naive Bayes	19-3

## 20 Neural Network

---

20.1	About Neural Network	20-1
20.1.1	Neuron and activation function	20-1
20.1.2	Loss or Cost function	20-2
20.1.3	Forward-Backward Propagation	20-2
20.1.4	Optimization Solver	20-2
20.1.5	Regularization	20-2
20.1.6	Convergence Check	20-3
20.1.7	LBFGS_SCALE_HESSIAN	20-3
20.1.8	NNET_HELDASIDE_MAX_FAIL	20-3
20.2	Data Preparation for Neural Network	20-3
20.3	Neural Network Algorithm Configuration	20-4
20.4	Scoring with Neural Network	20-4

## 21 Non-Negative Matrix Factorization

---

21.1	About NMF	21-1
21.1.1	Matrix Factorization	21-1
21.1.2	Scoring with NMF	21-2
21.1.3	Text Mining with NMF	21-2
21.2	Tuning the NMF Algorithm	21-2
21.3	Data Preparation for NMF	21-3

## 22 O-Cluster

---

22.1	About O-Cluster	22-1
22.1.1	Partitioning Strategy	22-1
22.1.1.1	Partitioning Numerical Attributes	22-2
22.1.1.2	Partitioning Categorical Attributes	22-2
22.1.2	Active Sampling	22-2
22.1.3	Process Flow	22-2
22.1.4	Scoring	22-3
22.2	Tuning the O-Cluster Algorithm	22-3
22.3	Data Preparation for O-Cluster	22-3
22.3.1	User-Specified Data Preparation for O-Cluster	22-4

## 23 R Extensibility

---

23.1	Oracle Data Mining with R Extensibility	23-1
23.2	Scoring with R	23-2
23.3	About Algorithm Meta Data Registration	23-2

## 24 Random Forest

---

24.1	About Random Forest	24-1
24.2	Building a Random Forest	24-1
24.3	Scoring with Random Forest	24-2

## 25 Singular Value Decomposition

---

25.1	About Singular Value Decomposition	25-1
25.1.1	Matrix Manipulation	25-1
25.1.2	Low Rank Decomposition	25-2
25.1.3	Scalability	25-2
25.2	Configuring the Algorithm	25-2
25.2.1	Model Size	25-3
25.2.2	Performance	25-3
25.2.3	PCA scoring	25-3
25.3	Data Preparation for SVD	25-3

## 26 Support Vector Machines

---

26.1	About Support Vector Machines	26-1
26.1.1	Advantages of SVM	26-1
26.1.2	Advantages of SVM in Oracle Data Mining	26-2
26.1.2.1	Usability	26-2
26.1.2.2	Scalability	26-2
26.1.3	Kernel-Based Learning	26-2
26.2	Tuning an SVM Model	26-3
26.3	Data Preparation for SVM	26-3
26.3.1	Normalization	26-3
26.3.2	SVM and Automatic Data Preparation	26-4
26.4	SVM Classification	26-4
26.4.1	Class Weights	26-4
26.5	One-Class SVM	26-5
26.6	SVM Regression	26-5

## Part IV Using the Data Mining API

---

## 27 Data Mining With SQL

---

27.1	Highlights of the Data Mining API	27-1
27.2	Example: Targeting Likely Candidates for a Sales Promotion	27-2
27.3	Example: Analyzing Preferred Customers	27-3
27.4	Example: Segmenting Customer Data	27-5
27.5	Example : Building an ESA Model with a Wiki Dataset	27-6

## 28 About the Data Mining API

---

28.1	About Mining Models	28-1
28.2	Data Mining Data Dictionary Views	28-2
28.2.1	ALL_MINING_MODELS	28-2
28.2.2	ALL_MINING_MODEL_ATTRIBUTES	28-3
28.2.3	ALL_MINING_MODEL_PARTITIONS	28-4
28.2.4	ALL_MINING_MODEL_SETTINGS	28-5
28.2.5	ALL_MINING_MODEL_VIEWS	28-6
28.2.6	ALL_MINING_MODEL_XFORMS	28-6
28.3	Data Mining PL/SQL Packages	28-7
28.3.1	DBMS_DATA_MINING	28-8
28.3.2	DBMS_DATA_MINING_TRANSFORM	28-8
28.3.2.1	Transformation Methods in DBMS_DATA_MINING_TRANSFORM	28-8
28.3.3	DBMS_PREDICTIVE_ANALYTICS	28-9
28.4	Data Mining SQL Scoring Functions	28-10

## 29 Preparing the Data

---

29.1	Data Requirements	29-1
29.1.1	Column Data Types	29-2
29.1.2	Data Sets for Classification and Regression	29-2
29.1.3	Scoring Requirements	29-2
29.2	About Attributes	29-3
29.2.1	Data Attributes and Model Attributes	29-3
29.2.2	Target Attribute	29-4
29.2.3	Numericals, Categoricals, and Unstructured Text	29-4
29.2.4	Model Signature	29-5
29.2.5	Scoping of Model Attribute Name	29-5
29.2.6	Model Details	29-6
29.3	Using Nested Data	29-6
29.3.1	Nested Object Types	29-7
29.3.2	Example: Transforming Transactional Data for Mining	29-8
29.4	Using Market Basket Data	29-9

29.4.1	Example: Creating a Nested Column for Market Basket Analysis	29-10
29.5	Using Retail Analysis Data	29-11
29.5.1	Example: Calculating Aggregates	29-11
29.6	Handling Missing Values	29-11
29.6.1	Examples: Missing Values or Sparse Data?	29-12
29.6.1.1	Sparsity in a Sales Table	29-12
29.6.1.2	Missing Values in a Table of Customer Data	29-12
29.6.2	Missing Value Treatment in Oracle Data Mining	29-12
29.6.3	Changing the Missing Value Treatment	29-13

## 30 Transforming the Data

---

30.1	About Transformations	30-1
30.2	Preparing the Case Table	30-2
30.2.1	Creating Nested Columns	30-2
30.2.2	Converting Column Data Types	30-2
30.2.3	Text Transformation	30-2
30.2.4	About Business and Domain-Sensitive Transformations	30-3
30.3	Understanding Automatic Data Preparation	30-3
30.3.1	Binning	30-3
30.3.2	Normalization	30-4
30.3.3	How ADP Transforms the Data	30-4
30.4	Embedding Transformations in a Model	30-4
30.4.1	Specifying Transformation Instructions for an Attribute	30-5
30.4.1.1	Expression Records	30-6
30.4.1.2	Attribute Specifications	30-6
30.4.2	Building a Transformation List	30-7
30.4.2.1	SET_TRANSFORM	30-7
30.4.2.2	The STACK Interface	30-7
30.4.2.3	GET_MODEL_TRANSFORMATIONS and GET_TRANSFORM_LIST	30-8
30.4.3	Transformation Lists and Automatic Data Preparation	30-8
30.4.4	Oracle Data Mining Transformation Routines	30-9
30.4.4.1	Binning Routines	30-9
30.4.4.2	Normalization Routines	30-10
30.4.4.3	Outlier Treatment	30-10
30.4.4.4	Routines for Outlier Treatment	30-10
30.5	Understanding Reverse Transformations	30-11

## 31 Creating a Model

---

31.1	Before Creating a Model	31-1
31.2	The CREATE_MODEL Procedure	31-1

31.2.1	Choosing the Mining Function	31-2
31.2.2	Choosing the Algorithm	31-3
31.2.3	Supplying Transformations	31-4
31.2.3.1	Creating a Transformation List	31-4
31.2.3.2	Transformation List and Automatic Data Preparation	31-5
31.2.4	About Partitioned Model	31-5
31.2.4.1	Partitioned Model Build Process	31-6
31.2.4.2	DDL in Partitioned model	31-6
31.2.4.3	Partitioned Model scoring	31-7
31.3	Specifying Model Settings	31-7
31.3.1	Specifying Costs	31-9
31.3.2	Specifying Prior Probabilities	31-9
31.3.3	Specifying Class Weights	31-10
31.3.4	Model Settings in the Data Dictionary	31-10
31.3.5	Specifying Mining Model Settings for R Model	31-11
31.3.5.1	ALGO_EXTENSIBLE_LANG	31-12
31.3.5.2	RALG_BUILD_FUNCTION	31-12
31.3.5.3	RALG_DETAILS_FUNCTION	31-14
31.3.5.4	RALG_SCORE_FUNCTION	31-15
31.3.5.5	RALG_WEIGHT_FUNCTION	31-18
31.3.5.6	Registered R Scripts	31-19
31.3.5.7	R Model Demonstration Scripts	31-19
31.4	Model Detail Views	31-19
31.4.1	Model Detail Views for Association Rules	31-20
31.4.2	Model Detail View for Frequent Itemsets	31-25
31.4.3	Model Detail View for Transactional Itemsets	31-26
31.4.4	Model Detail View for Transactional Rule	31-27
31.4.5	Model Detail Views for Classification Algorithms	31-28
31.4.6	Model Detail Views for Decision Tree	31-29
31.4.7	Model Detail Views for Generalized Linear Model	31-31
31.4.8	Model Detail Views for Naive Bayes	31-38
31.4.9	Model Detail Views for Neural Network	31-39
31.4.10	Model Detail Views for Random Forest	31-41
31.4.11	Model Detail View for Support Vector Machine	31-42
31.4.12	Model Detail Views for Clustering Algorithms	31-43
31.4.13	Model Detail Views for Expectation Maximization	31-45
31.4.14	Model Detail Views for k-Means	31-49
31.4.15	Model Detail Views for O-Cluster	31-50
31.4.16	Model Detail Views for CUR Matrix Decomposition	31-52
31.4.17	Model Detail Views for Explicit Semantic Analysis	31-53
31.4.18	Model Detail Views for Exponential Smoothing Models	31-55
31.4.19	Model Detail Views for Non-Negative Matrix Factorization	31-56

31.4.20	Model Detail Views for Singular Value Decomposition	31-58
31.4.21	Model Detail View for Minimum Description Length	31-61
31.4.22	Model Detail View for Binning	31-61
31.4.23	Model Detail Views for Global Information	31-62
31.4.24	Model Detail View for Normalization and Missing Value Handling	31-63

## 32 Scoring and Deployment

---

32.1	About Scoring and Deployment	32-1
32.2	Using the Data Mining SQL Functions	32-2
32.2.1	Choosing the Predictors	32-2
32.2.2	Single-Record Scoring	32-3
32.3	Prediction Details	32-4
32.3.1	Cluster Details	32-4
32.3.2	Feature Details	32-5
32.3.3	Prediction Details	32-5
32.3.4	GROUPING Hint	32-7
32.4	Real-Time Scoring	32-8
32.5	Dynamic Scoring	32-8
32.6	Cost-Sensitive Decision Making	32-10
32.7	DBMS_DATA_MINING.Apply	32-11

## 33 Mining Unstructured Text

---

33.1	About Unstructured Text	33-1
33.2	About Text Mining and Oracle Text	33-1
33.3	Data Preparation for Text Features	33-2
33.4	Creating a Model that Includes Text Mining	33-2
33.5	Creating a Text Policy	33-4
33.6	Configuring a Text Attribute	33-5

## 34 Administrative Tasks for Oracle Data Mining

---

34.1	Installing and Configuring a Database for Data Mining	34-1
34.1.1	About Installation	34-1
34.1.2	Enabling or Disabling a Database Option	34-2
34.1.3	Database Tuning Considerations for Data Mining	34-2
34.2	Upgrading or Downgrading Oracle Data Mining	34-2
34.2.1	Pre-Upgrade Steps	34-3
34.2.1.1	Dropping Models Created in Java	34-3
34.2.1.2	Dropping Mining Activities Created in Oracle Data Miner Classic	34-3
34.2.2	Upgrading Oracle Data Mining	34-3

34.2.2.1	Using Database Upgrade Assistant to Upgrade Oracle Data Mining	34-4
34.2.2.2	Using Export/Import to Upgrade Data Mining Models	34-4
34.2.3	Post Upgrade Steps	34-6
34.2.4	Downgrading Oracle Data Mining	34-6
34.3	Exporting and Importing Mining Models	34-7
34.3.1	About Oracle Data Pump	34-7
34.3.2	Options for Exporting and Importing Mining Models	34-8
34.3.3	Directory Objects for EXPORT_MODEL and IMPORT_MODEL	34-8
34.3.4	Using EXPORT_MODEL and IMPORT_MODEL	34-9
34.3.5	EXPORT and IMPORT Serialized Models	34-11
34.3.6	Importing From PMML	34-11
34.4	Controlling Access to Mining Models and Data	34-11
34.4.1	Creating a Data Mining User	34-12
34.4.1.1	Granting Privileges for Data Mining	34-13
34.4.2	System Privileges for Data Mining	34-13
34.4.3	Object Privileges for Mining Models	34-14
34.5	Auditing and Adding Comments to Mining Models	34-15
34.5.1	Adding a Comment to a Mining Model	34-15
34.5.2	Auditing Mining Models	34-16

## 35 The Data Mining Sample Programs

---

35.1	About the Data Mining Sample Programs	35-1
35.2	Installing the Data Mining Sample Programs	35-2
35.3	The Data Mining Sample Data	35-3

## Part V Oracle Data Mining API Reference

---

### 36 PL/SQL Packages

---

36.1	DBMS_DATA_MINING	36-1
36.1.1	Using DBMS_DATA_MINING	36-1
36.1.1.1	DBMS_DATA_MINING Overview	36-2
36.1.1.2	DBMS_DATA_MINING Security Model	36-3
36.1.1.3	DBMS_DATA_MINING — Mining Functions	36-3
36.1.2	DBMS_DATA_MINING — Model Settings	36-4
36.1.2.1	DBMS_DATA_MINING — Algorithm Names	36-5
36.1.2.2	DBMS_DATA_MINING — Automatic Data Preparation	36-6
36.1.2.3	DBMS_DATA_MINING — Mining Function Settings	36-7
36.1.2.4	DBMS_DATA_MINING — Global Settings	36-12
36.1.2.5	DBMS_DATA_MINING — Algorithm Settings: ALGO_EXTENSIBLE_LANG	36-16



36.1.2.6	DBMS_DATA_MINING — Algorithm Settings: CUR Matrix Decomposition	36-18
36.1.2.7	DBMS_DATA_MINING — Algorithm Settings: Decision Tree	36-19
36.1.2.8	DBMS_DATA_MINING — Algorithm Settings: Expectation Maximization	36-20
36.1.2.9	DBMS_DATA_MINING — Algorithm Settings: Explicit Semantic Analysis	36-24
36.1.2.10	DBMS_DATA_MINING — Algorithm Settings: Exponential Smoothing	36-25
36.1.2.11	DBMS_DATA_MINING — Algorithm Settings: Generalized Linear Model	36-31
36.1.2.12	DBMS_DATA_MINING — Algorithm Settings: k-Means	36-34
36.1.2.13	DBMS_DATA_MINING — Algorithm Settings: Naive Bayes	36-36
36.1.2.14	DBMS_DATA_MINING — Algorithm Settings: Neural Network	36-37
36.1.2.15	DBMS_DATA_MINING — Algorithm Settings: Non-Negative Matrix Factorization	36-41
36.1.2.16	DBMS_DATA_MINING — Algorithm Settings: O-Cluster	36-42
36.1.2.17	DBMS_DATA_MINING — Algorithm Settings: Random Forest	36-42
36.1.2.18	DBMS_DATA_MINING — Algorithm Constants and Settings: Singular Value Decomposition	36-43
36.1.2.19	DBMS_DATA_MINING — Algorithm Settings: Support Vector Machine	36-46
36.1.3	DBMS_DATA_MINING — Solver Settings	36-48
36.1.3.1	DBMS_DATA_MINING — Solver Settings: ADMM	36-48
36.1.3.2	DBMS_DATA_MINING — Solver Settings: LBFGS	36-49
36.1.4	DBMS_DATA_MINING Datatypes	36-49
36.1.4.1	Deprecated Types	36-50
36.1.5	Summary of DBMS_DATA_MINING Subprograms	36-55
36.1.5.1	ADD_COST_MATRIX Procedure	36-57
36.1.5.2	ADD_PARTITION Procedure	36-60
36.1.5.3	ALTER_REVERSE_EXPRESSION Procedure	36-60
36.1.5.4	APPLY Procedure	36-64
36.1.5.5	COMPUTE_CONFUSION_MATRIX Procedure	36-67
36.1.5.6	COMPUTE_CONFUSION_MATRIX_PART Procedure	36-73
36.1.5.7	COMPUTE_LIFT Procedure	36-79
36.1.5.8	COMPUTE_LIFT_PART Procedure	36-84
36.1.5.9	COMPUTE_ROC Procedure	36-88
36.1.5.10	COMPUTE_ROC_PART Procedure	36-93
36.1.5.11	CREATE_MODEL Procedure	36-97
36.1.5.12	CREATE_MODEL2 Procedure	36-101
36.1.5.13	Create Model Using Registration Information	36-103
36.1.5.14	DROP_ALGORITHM Procedure	36-103
36.1.5.15	DROP_PARTITION Procedure	36-104
36.1.5.16	DROP_MODEL Procedure	36-104
36.1.5.17	EXPORT_MODEL Procedure	36-105
36.1.5.18	EXPORT_SERMODEL Procedure	36-108
36.1.5.19	FETCH_JSON_SCHEMA Procedure	36-109
36.1.5.20	GET_ASSOCIATION_RULES Function	36-109

36.1.5.21	GET_FREQUENT_ITEMSETS Function	36-114
36.1.5.22	GET_MODEL_COST_MATRIX Function	36-116
36.1.5.23	GET_MODEL_DETAILS_AI Function	36-118
36.1.5.24	GET_MODEL_DETAILS_EM Function	36-119
36.1.5.25	GET_MODEL_DETAILS_EM_COMP Function	36-120
36.1.5.26	GET_MODEL_DETAILS_EM_PROJ Function	36-122
36.1.5.27	GET_MODEL_DETAILS_GLM Function	36-124
36.1.5.28	GET_MODEL_DETAILS_GLOBAL Function	36-127
36.1.5.29	GET_MODEL_DETAILS_KM Function	36-129
36.1.5.30	GET_MODEL_DETAILS_NB Function	36-131
36.1.5.31	GET_MODEL_DETAILS_NMF Function	36-133
36.1.5.32	GET_MODEL_DETAILS_OC Function	36-134
36.1.5.33	GET_MODEL_SETTINGS Function	36-136
36.1.5.34	GET_MODEL_SIGNATURE Function	36-137
36.1.5.35	GET_MODEL_DETAILS_SVD Function	36-139
36.1.5.36	GET_MODEL_DETAILS_SVM Function	36-141
36.1.5.37	GET_MODEL_DETAILS_XML Function	36-143
36.1.5.38	GET_MODEL_TRANSFORMATIONS Function	36-145
36.1.5.39	GET_TRANSFORM_LIST Procedure	36-148
36.1.5.40	IMPORT_MODEL Procedure	36-151
36.1.5.41	IMPORT_SERMODEL Procedure	36-155
36.1.5.42	JSON Schema for R Extensible Algorithm	36-156
36.1.5.43	REGISTER_ALGORITHM Procedure	36-160
36.1.5.44	RANK_APPLY Procedure	36-162
36.1.5.45	REMOVE_COST_MATRIX Procedure	36-164
36.1.5.46	RENAME_MODEL Procedure	36-165
36.2	DBMS_DATA_MINING_TRANSFORM	36-166
36.2.1	Using DBMS_DATA_MINING_TRANSFORM	36-166
36.2.1.1	DBMS_DATA_MINING_TRANSFORM Overview	36-167
36.2.1.2	DBMS_DATA_MINING_TRANSFORM Security Model	36-169
36.2.1.3	DBMS_DATA_MINING_TRANSFORM Datatypes	36-170
36.2.1.4	DBMS_DATA_MINING_TRANSFORM Constants	36-171
36.2.2	DBMS_DATA_MINING_TRANSFORM Operational Notes	36-172
36.2.2.1	DBMS_DATA_MINING_TRANSFORM — About Transformation Lists	36-174
36.2.2.2	DBMS_DATA_MINING_TRANSFORM — About Stacking and Stack Procedures	36-176
36.2.2.3	DBMS_DATA_MINING_TRANSFORM — Nested Data Transformations	36-178
36.2.3	Summary of DBMS_DATA_MINING_TRANSFORM Subprograms	36-181
36.2.3.1	CREATE_BIN_CAT Procedure	36-183
36.2.3.2	CREATE_BIN_NUM Procedure	36-184
36.2.3.3	CREATE_CLIP Procedure	36-186
36.2.3.4	CREATE_COL_REM Procedure	36-187

36.2.3.5	CREATE_MISS_CAT Procedure	36-188
36.2.3.6	CREATE_MISS_NUM Procedure	36-190
36.2.3.7	CREATE_NORM_LIN Procedure	36-191
36.2.3.8	DESCRIBE_STACK Procedure	36-192
36.2.3.9	GET_EXPRESSION Function	36-194
36.2.3.10	INSERT_AUTOBIN_NUM_EQWIDTH Procedure	36-195
36.2.3.11	INSERT_BIN_CAT_FREQ Procedure	36-199
36.2.3.12	INSERT_BIN_NUM_EQWIDTH Procedure	36-203
36.2.3.13	INSERT_BIN_NUM_QTILE Procedure	36-207
36.2.3.14	INSERT_BIN_SUPER Procedure	36-209
36.2.3.15	INSERT_CLIP_TRIM_TAIL Procedure	36-213
36.2.3.16	INSERT_CLIP_WINSOR_TAIL Procedure	36-215
36.2.3.17	INSERT_MISS_CAT_MODE Procedure	36-218
36.2.3.18	INSERT_MISS_NUM_MEAN Procedure	36-220
36.2.3.19	INSERT_NORM_LIN_MINMAX Procedure	36-223
36.2.3.20	INSERT_NORM_LIN_SCALE Procedure	36-225
36.2.3.21	INSERT_NORM_LIN_ZSCORE Procedure	36-227
36.2.3.22	SET_EXPRESSION Procedure	36-229
36.2.3.23	SET_TRANSFORM Procedure	36-231
36.2.3.24	STACK_BIN_CAT Procedure	36-232
36.2.3.25	STACK_BIN_NUM Procedure	36-234
36.2.3.26	STACK_CLIP Procedure	36-236
36.2.3.27	STACK_COL_REM Procedure	36-238
36.2.3.28	STACK_MISS_CAT Procedure	36-240
36.2.3.29	STACK_MISS_NUM Procedure	36-242
36.2.3.30	STACK_NORM_LIN Procedure	36-244
36.2.3.31	XFORM_BIN_CAT Procedure	36-246
36.2.3.32	XFORM_BIN_NUM Procedure	36-248
36.2.3.33	XFORM_CLIP Procedure	36-251
36.2.3.34	XFORM_COL_REM Procedure	36-252
36.2.3.35	XFORM_EXPR_NUM Procedure	36-254
36.2.3.36	XFORM_EXPR_STR Procedure	36-256
36.2.3.37	XFORM_MISS_CAT Procedure	36-258
36.2.3.38	XFORM_MISS_NUM Procedure	36-260
36.2.3.39	XFORM_NORM_LIN Procedure	36-262
36.2.3.40	XFORM_STACK Procedure	36-264
36.3	DBMS_PREDICTIVE_ANALYTICS	36-267
36.3.1	Using DBMS_PREDICTIVE_ANALYTICS	36-267
36.3.1.1	DBMS_PREDICTIVE_ANALYTICS Overview	36-267
36.3.1.2	DBMS_PREDICTIVE_ANALYTICS Security Model	36-268
36.3.2	Summary of DBMS_PREDICTIVE_ANALYTICS Subprograms	36-268
36.3.2.1	EXPLAIN Procedure	36-268

36.3.2.2	PREDICT Procedure	36-270
36.3.2.3	PROFILE Procedure	36-272

## 37 Data Dictionary Views

---

37.1	ALL_MINING_MODELS	37-1
37.2	ALL_MINING_MODEL_ATTRIBUTES	37-2
37.3	ALL_MINING_MODEL_PARTITIONS	37-4
37.4	ALL_MINING_MODEL_SETTINGS	37-5
37.5	ALL_MINING_MODEL_VIEWS	37-6
37.6	ALL_MINING_MODEL_XFORMS	37-6

## 38 SQL Scoring Functions

---

38.1	CLUSTER_DETAILS	38-1
38.2	CLUSTER_DISTANCE	38-5
38.3	CLUSTER_ID	38-7
38.4	CLUSTER_PROBABILITY	38-10
38.5	CLUSTER_SET	38-12
38.6	FEATURE_COMPARE	38-15
38.7	FEATURE_DETAILS	38-17
38.8	FEATURE_ID	38-20
38.9	FEATURE_SET	38-22
38.10	FEATURE_VALUE	38-25
38.11	ORA_DM_PARTITION_NAME	38-27
38.12	PREDICTION	38-28
38.13	PREDICTION_BOUNDS	38-32
38.14	PREDICTION_COST	38-34
38.15	PREDICTION_DETAILS	38-38
38.16	PREDICTION_PROBABILITY	38-42
38.17	PREDICTION_SET	38-45

# Preface

This preface contains the following topics:

- [Audience](#)
- [Documentation Accessibility](#)
- [Diversity and Inclusion](#)
- [Related Resources](#)
- [Conventions](#)

## Audience

This guide is intended for application developers and database administrators who are familiar with SQL programming and Oracle Database administration and who have a basic understanding of data mining concepts.

## Documentation Accessibility

For information about Oracle's commitment to accessibility, visit the Oracle Accessibility Program website at <http://www.oracle.com/pls/topic/lookup?ctx=acc&id=docacc>.

### **Access to Oracle Support**

Oracle customers that have purchased support have access to electronic support through My Oracle Support. For information, visit <http://www.oracle.com/pls/topic/lookup?ctx=acc&id=info> or visit <http://www.oracle.com/pls/topic/lookup?ctx=acc&id=trs> if you are hearing impaired.

## Diversity and Inclusion

Oracle is fully committed to diversity and inclusion. Oracle respects and values having a diverse workforce that increases thought leadership and innovation. As part of our initiative to build a more inclusive culture that positively impacts our employees, customers, and partners, we are working to remove insensitive terms from our products and documentation. We are also mindful of the necessity to maintain compatibility with our customers' existing technologies and the need to ensure continuity of service as Oracle's offerings and industry standards evolve. Because of these technical constraints, our effort to remove insensitive terms is ongoing and will take time and external cooperation.

## Related Resources

For more information, see these Oracle resources:

- [Oracle Public Cloud](#)

---

<http://cloud.oracle.com>

- *Oracle Data Mining Concepts*
- *Oracle Data Mining User's Guide*
- *Oracle Database PL/SQL Packages and Types Reference*
- *Oracle Database Reference*

## Conventions

The following text conventions are used in this document:

Convention	Meaning
<b>boldface</b>	Boldface type indicates graphical user interface elements associated with an action, or terms defined in text or the glossary.
<i>italic</i>	Italic type indicates book titles, emphasis, or placeholder variables for which you supply particular values.
monospace	Monospace type indicates commands within a paragraph, URLs, code in examples, text that appears on the screen, or text that you enter.

# Part I

## Introductions

Part I presents an introduction to Oracle Data Mining. The first chapter is a general, high-level overview for those who are new to data mining technology.

Part I contains the following chapters:

- [Introduction to Oracle Data Mining](#)
- [Oracle Data Mining Basics](#)

# 1

## Introduction to Oracle Data Mining

Introduces Oracle Data Mining to perform a variety of mining tasks.

- [About Oracle Data Mining](#)
- [Data Mining in the Database Kernel](#)
- [Oracle Data Mining with R Extensibility](#)
- [Data Mining in Oracle Exadata](#)
- [About Partitioned Model](#)
- [Interfaces to Oracle Data Mining](#)
- [Overview of Database Analytics](#)

### 1.1 About Oracle Data Mining

Understand the uses of Oracle Data Mining and learn about different mining techniques.

Oracle Data Mining provides a powerful, state-of-the-art data mining capability within Oracle Database. You can use Oracle Data Mining to build and deploy predictive and descriptive data mining applications, to add intelligent capabilities to existing applications, and to generate predictive queries for data exploration.

Oracle Data Mining offers a comprehensive set of in-database algorithms for performing a variety of mining tasks, such as classification, regression, anomaly detection, feature extraction, clustering, and market basket analysis. The algorithms can work on standard case data, transactional data, star schemas, and text and other forms of unstructured data. Oracle Data Mining is uniquely suited to the mining of very large data sets.

Oracle Data Mining is one of the two components of the **Oracle Advanced Analytics Option** of Oracle Database Enterprise Edition. The other component is Oracle R Enterprise, which integrates R, the open-source statistical environment, with Oracle Database. Together, Oracle Data Mining and Oracle R Enterprise constitute a comprehensive advanced analytics platform for big data analytics.

#### Related Topics

- [Oracle R Enterprise Documentation Library](#)

### 1.2 Data Mining in the Database Kernel

Learn about implementation of Data Mining.

Oracle Data Mining is implemented in the Oracle Database kernel. Data Mining models are first class database objects. Oracle Data Mining processes use built-in features of Oracle Database to maximize scalability and make efficient use of system resources.

Data mining within Oracle Database offers many advantages:



- **No Data Movement:** Some data mining products require that the data be exported from a corporate database and converted to a specialized format for mining. With Oracle Data Mining, no data movement or conversion is needed. This makes the entire mining process less complex, time-consuming, and error-prone, and it allows for the mining of very large data sets.
- **Security:** Your data is protected by the extensive security mechanisms of Oracle Database. Moreover, specific database privileges are needed for different data mining activities. Only users with the appropriate privileges can define, manipulate, or apply mining model objects.
- **Data Preparation and Administration:** Most data must be cleansed, filtered, normalized, sampled, and transformed in various ways before it can be mined. Up to 80% of the effort in a data mining project is often devoted to data preparation. Oracle Data Mining can automatically manage key steps in the data preparation process. Additionally, Oracle Database provides extensive administrative tools for preparing and managing data.
- **Ease of Data Refresh:** Mining processes within Oracle Database have ready access to refreshed data. Oracle Data Mining can easily deliver mining results based on current data, thereby maximizing its timeliness and relevance.
- **Oracle Database Analytics:** Oracle Database offers many features for advanced analytics and business intelligence. Oracle Data Mining can easily be integrated with other analytical features of the database, such as statistical analysis and OLAP.
- **Oracle Technology Stack:** You can take advantage of all aspects of Oracle's technology stack to integrate data mining within a larger framework for business intelligence or scientific inquiry.
- **Domain Environment:** Data mining models have to be built, tested, validated, managed, and deployed in their appropriate application domain environments. Data mining results may need to be post-processed as part of domain specific computations (for example, calculating estimated risks and response probabilities) and then stored into permanent repositories or data warehouses. With Oracle Data Mining, the pre- and post-mining activities can all be accomplished within the same environment.
- **Application Programming Interfaces:** The PL/SQL API and SQL language operators provide direct access to Oracle Data Mining functionality in Oracle Database.

#### **Related Topics**

- [Overview of Database Analytics](#)

## 1.3 Data Mining in Oracle Exadata

Understand scoring in Oracle Exadata.

Scoring refers to the process of applying a data mining model to data to generate predictions. The scoring process may require significant system resources. Vast amounts of data may be involved, and algorithmic processing may be very complex.

With Oracle Data Mining, scoring can be off-loaded to intelligent Oracle Exadata Storage Servers where processing is extremely performant.

Oracle Exadata Storage Servers combine Oracle's smart storage software and Oracle's industry-standard Sun hardware to deliver the industry's highest database storage performance. For more information about Oracle Exadata, visit the Oracle Technology Network.

**Related Topics**

- <http://www.oracle.com/us/products/database/exadata/index.htm>

## 1.4 About Partitioned Model

Introduces partitioned model to organise and represent multiple models.

Oracle Data Mining supports building of a persistent Oracle Data Mining partitioned model. A partitioned model organizes and represents multiple models as partitions in a single model entity, enabling a user to easily build and manage models tailored to independent slices of data. Persistent means that the partitioned model has an on-disk representation. The product manages the organization of the partitioned model and simplifies the process of scoring the partitioned model. You must include the partition columns as part of the `USING` clause when scoring.

The partition names, key values, and the structure of the partitioned model are visible in the `ALL_MINING_MODEL_PARTITIONS` view.

**Related Topics**

- *Oracle Database Reference*
- *Oracle Data Mining User's Guide*

## 1.5 Interfaces to Oracle Data Mining

The programmatic interfaces to Oracle Data Mining are PL/SQL for building and maintaining models and a family of SQL functions for scoring. Oracle Data Mining also supports a graphical user interface, which is implemented as an extension to Oracle SQL Developer.

Oracle Predictive Analytics, a set of simplified data mining routines, is built on top of Oracle Data Mining and is implemented as a PL/SQL package.

### 1.5.1 PL/SQL API

The Oracle Data Mining PL/SQL API is implemented in the `DBMS_DATA_MINING` PL/SQL package, which contains routines for building, testing, and maintaining data mining models. A batch apply operation is also included in this package.

The following example shows part of a simple PL/SQL script for creating an SVM classification model called `svmc_sh_Clas_sample`. The model build uses weights, specified in a weights table, and settings, specified in a settings table. The weights influence the weighting of target classes. The settings override default behavior. The model uses Automatic Data Preparation (`prep_auto_on` setting). The model is trained on the data in `mining_data_build_v`.

**Example 1-1 Creating a Classification Model**

```

----- CREATE AND POPULATE A CLASS WEIGHTS TABLE -----
CREATE TABLE svmc_sh_sample_class_wt (
  target_value NUMBER,
  class_weight NUMBER);
INSERT INTO svmc_sh_sample_class_wt VALUES (0,0.35);
INSERT INTO svmc_sh_sample_class_wt VALUES (1,0.65);
COMMIT;
----- CREATE AND POPULATE A SETTINGS TABLE -----
CREATE TABLE svmc_sh_sample_settings (
  setting_name VARCHAR2(30),
  setting_value VARCHAR2(4000));

```

```

BEGIN
INSERT INTO svmc_sh_sample_settings (setting_name, setting_value) VALUES
  (dbms_data_mining.algo_name, dbms_data_mining.algo_support_vector_machines);
INSERT INTO svmc_sh_sample_settings (setting_name, setting_value) VALUES
  (dbms_data_mining.svms_kernel_function, dbms_data_mining.svms_linear);
INSERT INTO svmc_sh_sample_settings (setting_name, setting_value) VALUES
  (dbms_data_mining.clas_weights_table_name, 'svmc_sh_sample_class_wt');
INSERT INTO svmc_sh_sample_settings (setting_name, setting_value) VALUES
  (dbms_data_mining.prep_auto, dbms_data_mining.prep_auto_on);
END;
/
----- CREATE THE MODEL -----
BEGIN
  DBMS_DATA_MINING.CREATE_MODEL(
    model_name          => 'SVMC_SH_Clas_sample',
    mining_function     => dbms_data_mining.classification,
    data_table_name    => 'mining_data_build_v',
    case_id_column_name => 'cust_id',
    target_column_name => 'affinity_card',
    settings_table_name => 'svmc_sh_sample_settings');
END;
/

```

## 1.5.2 SQL Functions

The Data Mining SQL functions perform prediction, clustering, and feature extraction.

The functions score data by applying a mining model object or by executing an analytic clause that performs dynamic scoring.

The following example shows a query that applies the classification model `svmc_sh_clas_sample` to the data in the view `mining_data_apply_v`. The query returns the average age of customers who are likely to use an affinity card. The results are broken out by gender.

### Example 1-2 The PREDICTION Function

```

SELECT cust_gender,
       COUNT(*) AS cnt,
       ROUND(AVG(age)) AS avg_age
  FROM mining_data_apply_v
 WHERE PREDICTION(svmc_sh_clas_sample USING *) = 1
 GROUP BY cust_gender
 ORDER BY cust_gender;

```

C	CNT	AVG_AGE
F	59	41
M	409	45

### Related Topics

- [In-Database Scoring](#)

## 1.5.3 Oracle Data Miner

Oracle Data Miner is a graphical interface to Oracle Data Mining. Oracle Data Miner is an extension to Oracle SQL Developer, which is available for download free of charge on the Oracle Technology Network.

Oracle Data Miner uses a work flow paradigm to capture, document, and automate the process of building, evaluating, and applying data mining models. Within a work flow, you can specify data transformations, build and evaluate multiple models, and score multiple data sets. You can then save work flows and share them with other users.

**Figure 1-1 An Oracle Data Miner Workflow**

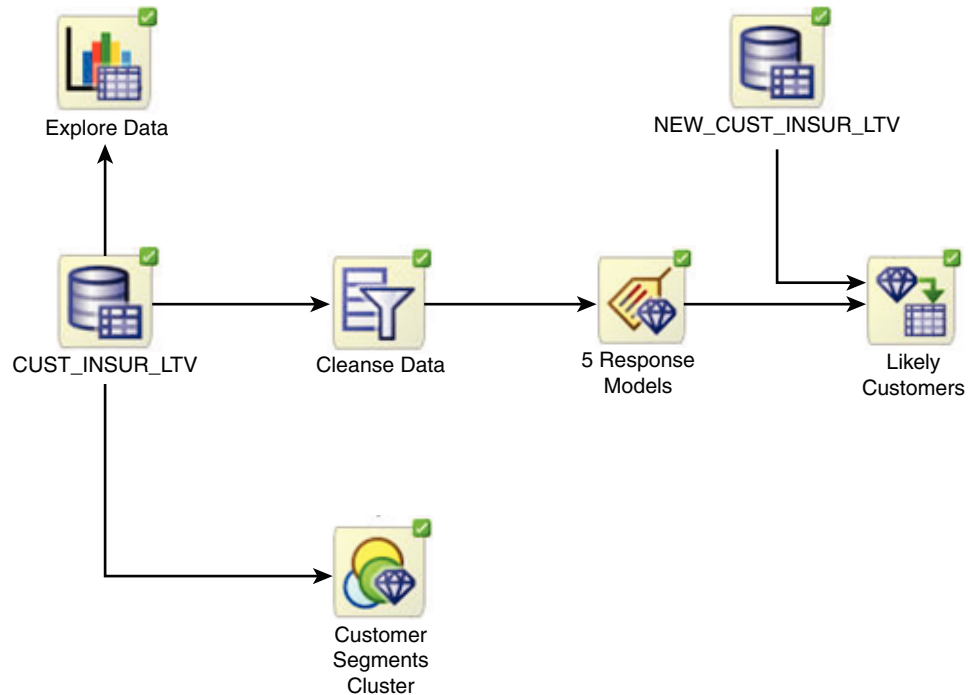

For information about Oracle Data Miner, including installation instructions, visit Oracle Technology Network.

**Related Topics**

- [Oracle Data Miner](#)

## 1.5.4 Predictive Analytics

Predictive analytics is a technology that captures data mining processes in simple routines.

Sometimes called "one-click data mining," predictive analytics simplifies and automates the data mining process.

Predictive analytics uses data mining technology, but knowledge of data mining is not needed to use predictive analytics. You can use predictive analytics simply by specifying an operation to perform on your data. You do not need to create or use mining models or understand the mining functions and algorithms summarized in "Oracle Data Mining Basics".

Oracle Data Mining predictive analytics operations are described in the following table:

**Table 1-1 Oracle Predictive Analytics Operations**

Operation	Description
EXPLAIN	Explains how individual predictors (columns) affect the variation of values in a target column
PREDICT	For each case (row), predicts the values in a target column
PROFILE	Creates a set of rules for cases (rows) that imply the same target value

The Oracle predictive analytics operations are implemented in the `DBMS_PREDICTIVE_ANALYTICS` PL/SQL package. They are also available in Oracle Data Miner.

**Related Topics**

- [Oracle Data Mining Basics](#)  
Understand the basic concepts of Oracle Data Mining.

## 1.6 Overview of Database Analytics

Oracle Database supports an array of native analytical features that are independent of the Oracle Advanced Analytics Option. Since all these features are part of a common server it is possible to combine them efficiently. The results of analytical processing can be integrated with Oracle Business Intelligence Suite Enterprise Edition and other BI tools and applications.

The possibilities for combining different analytics are virtually limitless. [Example 1-3](#) shows data mining and text processing within a single SQL query. The query selects all customers who have a high propensity to attrite (> 80% chance), are valuable customers (customer value rating > 90), and have had a recent conversation with customer services regarding a Checking Plus account. The propensity to attrite information is computed using a Data Mining model called `tree_model`. The query uses the Oracle Text `CONTAINS` operator to search call center notes for references to Checking Plus accounts.

Some of the native analytics supported by Oracle Database are described in the following table:

**Table 1-2 Oracle Database Native Analytics**

Analytical Feature	Description	Documented In...
Complex data transformations	Data transformation is a key aspect of analytical applications and ETL (extract, transform, and load). You can use SQL expressions to implement data transformations, or you can use the <code>DBMS_DATA_MINING_TRANSFORM</code> package.  <code>DBMS_DATA_MINING_TRANSFORM</code> is a flexible data transformation package that includes a variety of missing value and outlier treatments, as well as binning and normalization capabilities.	<i>Oracle Database PL/SQL Packages and Types Reference</i>
Statistical functions	Oracle Database provides a long list of SQL statistical functions with support for: hypothesis testing (such as t-test, F-test), correlation computation (such as pearson correlation), cross-tab statistics, and descriptive statistics (such as median and mode). The <code>DBMS_STAT_FUNCS</code> package adds distribution fitting procedures and a summary procedure that returns descriptive statistics for a column.	<i>Oracle Database SQL Language Reference and Oracle Database PL/SQL Packages and Types Reference</i>

**Table 1-2 (Cont.) Oracle Database Native Analytics**

Analytical Feature	Description	Documented In...
Window and analytic SQL functions	Oracle Database supports analytic and windowing functions for computing cumulative, moving, and centered aggregates. With windowing aggregate functions, you can calculate moving and cumulative versions of SUM, AVERAGE, COUNT, MAX, MIN, and many more functions.	<i>Oracle Database Data Warehousing Guide</i>
Linear algebra	The <code>UTL_NLA</code> package exposes a subset of the popular <code>BLAS</code> and <code>LAPACK</code> (Version 3.0) libraries for operations on vectors and matrices represented as <code>VARRAYs</code> . This package includes procedures to solve systems of linear equations, invert matrices, and compute eigenvalues and eigenvectors.	<i>Oracle Database PL/SQL Packages and Types Reference</i>
OLAP	Oracle OLAP supports multidimensional analysis and can be used to improve performance of multidimensional queries. Oracle OLAP provides functionality previously found only in specialized OLAP databases. Moving beyond drill-downs and roll-ups, Oracle OLAP also supports time-series analysis, modeling, and forecasting.	<i>Oracle OLAP User's Guide</i>
Spatial analytics	<p>Oracle Spatial provides advanced spatial features to support high-end GIS and LBS solutions. Oracle Spatial's analysis and mining capabilities include functions for binning, detection of regional patterns, spatial correlation, colocation mining, and spatial clustering.</p> <p>Oracle Spatial also includes support for topology and network data models and analytics. The topology data model of Oracle Spatial allows one to work with data about nodes, edges, and faces in a topology. It includes network analysis functions for computing shortest path, minimum cost spanning tree, nearest-neighbors analysis, traveling salesman problem, among others.</p>	<i>Oracle Spatial and Graph Developer's Guide</i>
Text Mining	Oracle Text uses standard SQL to index, search, and analyze text and documents stored in the Oracle database, in files, and on the web. Oracle Text also supports automatic classification and clustering of document collections. Many of the analytical features of Oracle Text are layered on top of Oracle Data Mining functionality.	<i>Oracle Text Application Developer's Guide</i>

**Example 1-3 SQL Query Combining Oracle Data Mining and Oracle Text**

```

SELECT A.cust_name, A.contact_info
  FROM customers A
 WHERE PREDICTION_PROBABILITY(tree_model,
    'attrite' USING A.*) > 0.8
    AND A.cust_value > 90
    AND A.cust_id IN
      (SELECT B.cust_id
       FROM call_center B
       WHERE B.call_date BETWEEN '01-Jan-2005'
          AND '30-Jun-2005'
          AND CONTAINS(B.notes, 'Checking Plus', 1) > 0);

```

# 2

## Oracle Data Mining Basics

Understand the basic concepts of Oracle Data Mining.

- [Mining Functions](#)
- [Algorithms](#)
- [Data Preparation](#)
- [In-Database Scoring](#)

### 2.1 Mining Functions

Introduces the concept of data mining functions.

A basic understanding of data mining functions and algorithms is required for using Oracle Data Mining.

Each data mining **function** specifies a class of problems that can be modeled and solved. Data mining functions fall generally into two categories: **supervised** and **unsupervised**. Notions of supervised and unsupervised learning are derived from the science of machine learning, which has been called a sub-area of artificial intelligence.

Artificial intelligence refers to the implementation and study of systems that exhibit autonomous intelligence or behavior of their own. Machine learning deals with techniques that enable devices to learn from their own performance and modify their own functioning. Data mining applies machine learning concepts to data.

#### Related Topics

- [Algorithms](#)

#### 2.1.1 Supervised Data Mining

Supervised learning is also known as directed learning. The learning process is directed by a previously known dependent attribute or target. Directed data mining attempts to explain the behavior of the target as a function of a set of independent attributes or predictors.

Supervised learning generally results in predictive models. This is in contrast to unsupervised learning where the goal is pattern detection.

The building of a supervised model involves **training**, a process whereby the software analyzes many cases where the target value is already known. In the training process, the model "learns" the logic for making the prediction. For example, a model that seeks to identify the customers who are likely to respond to a promotion must be trained by analyzing the characteristics of many customers who are known to have responded or not responded to a promotion in the past.

### 2.1.1.1 Supervised Learning: Testing

Separate data sets are required for building (training) and testing some predictive models. The build data (training data) and test data must have the same column structure. Typically, one large table or view is split into two data sets: one for building the model, and the other for testing the model.

The process of applying the model to test data helps to determine whether the model, built on one chosen sample, is generalizable to other data. In particular, it helps to avoid the phenomenon of overfitting, which can occur when the logic of the model fits the build data too well and therefore has little predictive power.

### 2.1.1.2 Supervised Learning: Scoring

Apply data, also called scoring data, is the actual population to which a model is applied. For example, you might build a model that identifies the characteristics of customers who frequently buy a certain product. To obtain a list of customers who shop at a certain store and are likely to buy a related product, you might apply the model to the customer data for that store. In this case, the store customer data is the scoring data.

Most supervised learning can be applied to a population of interest. The principal supervised mining techniques, **Classification** and **Regression**, can both be used for scoring.

Oracle Data Mining does not support the scoring operation for **Attribute Importance**, another supervised function. Models of this type are built on a population of interest to obtain information about that population; they cannot be applied to separate data. An attribute importance model returns and ranks the attributes that are most important in predicting a target value.

Oracle Data Mining supports the supervised data mining functions described in the following table:

**Table 2-1 Oracle Data Mining Supervised Functions**

Function	Description	Sample Problem
Attribute Importance	Identifies the attributes that are most important in predicting a target attribute	Given customer response to an affinity card program, find the most significant predictors
Classification	Assigns items to discrete classes and predicts the class to which an item belongs	Given demographic data about a set of customers, predict customer response to an affinity card program
Regression	Approximates and forecasts continuous values	Given demographic and purchasing data about a set of customers, predict customers' age

## 2.1.2 Unsupervised Data Mining

Unsupervised learning is non-directed. There is no distinction between dependent and independent attributes. There is no previously-known result to guide the algorithm in building the model.

Unsupervised learning can be used for **descriptive** purposes. It can also be used to make predictions.



### 2.1.2.1 Unsupervised Learning: Scoring

Introduces unsupervised learning, supported scoring operations, and unsupervised Oracle Data Mining functions.

Although unsupervised data mining does not specify a target, most unsupervised learning can be applied to a population of interest. For example, clustering models use descriptive data mining techniques, but they can be applied to classify cases according to their cluster assignments. **Anomaly detection**, although unsupervised, is typically used to predict whether a data point is typical among a set of cases.

Oracle Data Mining supports the scoring operation for **Clustering** and **Feature Extraction**, both unsupervised mining functions. Oracle Data Mining does not support the scoring operation for **Association Rules**, another unsupervised function. Association models are built on a population of interest to obtain information about that population; they cannot be applied to separate data. An association model returns rules that explain how items or events are associated with each other. The association rules are returned with statistics that can be used to rank them according to their probability.

Oracle Data Mining supports the unsupervised functions described in the following table:

**Table 2-2 Oracle Data Mining Unsupervised Functions**

Function	Description	Sample Problem
Anomaly Detection	Identifies items (outliers) that do not satisfy the characteristics of "normal" data	Given demographic data about a set of customers, identify customer purchasing behavior that is significantly different from the norm
Association Rules	Finds items that tend to co-occur in the data and specifies the rules that govern their co-occurrence	Find the items that tend to be purchased together and specify their relationship
Clustering	Finds natural groupings in the data	Segment demographic data into clusters and rank the probability that an individual belongs to a given cluster
Feature Extraction	Creates new attributes (features) using linear combinations of the original attributes	Given demographic data about a set of customers, group the attributes into general characteristics of the customers

#### Related Topics

- [Mining Functions](#)  
Part II provides basic conceptual information about the mining functions that the Oracle Data Mining supports.
- [In-Database Scoring](#)

## 2.2 Algorithms

An algorithm is a mathematical procedure for solving a specific kind of problem. Oracle Data Mining supports at least one algorithm for each data mining function. For some functions, you can choose among several algorithms. For example, Oracle Data Mining supports four classification algorithms.

Each data mining model is produced by a specific algorithm. Some data mining problems can best be solved by using more than one algorithm. This necessitates the development of more

than one model. For example, you might first use a feature extraction model to create an optimized set of predictors, then a classification model to make a prediction on the results.

## 2.2.1 Oracle Data Mining Supervised Algorithms

Oracle Data Mining supports the supervised data mining algorithms described in the following table. The algorithm abbreviations are used throughout this manual.

**Table 2-3 Oracle Data Mining Algorithms for Supervised Functions**

Algorithm	Function	Description
Decision Tree	Classification	Decision trees extract predictive information in the form of human-understandable rules. The rules are if-then-else expressions; they explain the decisions that lead to the prediction.
Explicit Semantic Analysis	Classification	Explicit Semantic Analysis (ESA) is designed to make predictions for text data. This algorithm can address use cases with hundreds of thousands of classes. In Oracle Database 12c Release 2, ESA was introduced as Feature Extraction algorithm.
Exponential Smoothing	Time Series	Exponential Smoothing (ESM) provides forecasts for time series data. Forecasts are made for each time period within a user-specified forecast window. ESM provides a total of 14 different time series models, including all the most popular estimates of trend and seasonal effects. Choice of model is controlled by user settings. ESM provides confidence bounds on its forecasts.
Generalized Linear Models	Classification and Regression	Generalized Linear Models (GLM) implement logistic regression for classification of binary targets and linear regression for continuous targets. GLM classification supports confidence bounds for prediction probabilities. GLM regression supports confidence bounds for predictions.
Minimum Description Length	Attribute Importance	Minimum Description Length (MDL) is an information theoretic model selection principle. MDL assumes that the simplest, most compact representation of data is the best and most probable explanation of the data.
Naive Bayes	Classification	Naive Bayes makes predictions using Bayes' Theorem, which derives the probability of a prediction from the underlying evidence, as observed in the data.
Neural Network	Classification and Regression	Neural Network in Machine Learning is an artificial algorithm inspired from biological neural network and is used to estimate or approximate functions that depend on a large number of generally unknown inputs. Neural Network is designed for Classification and Regression.
Random Forest	Classification	Random Forest is a powerful machine learning algorithm. Random Forest algorithm builds a number of decision tree models and predicts using the ensemble of trees.
Support Vector Machines	Classification and Regression	Distinct versions of Support Vector Machines (SVM) use different kernel functions to handle different types of data sets. Linear and Gaussian (nonlinear) kernels are supported. SVM classification attempts to separate the target classes with the widest possible margin. SVM regression tries to find a continuous function such that the maximum number of data points lie within an epsilon-wide tube around it.

## 2.2.2 Oracle Data Mining Unsupervised Algorithms

Learn about unsupervised algorithms that Oracle Data Mining supports.

Oracle Data Mining supports the unsupervised data mining algorithms described in the following table. The algorithm abbreviations are used throughout this manual.

**Table 2-4 Oracle Data Mining Algorithms for Unsupervised Functions**

Algorithm	Function	Description
Apriori	Association	Apriori performs market basket analysis by identifying co-occurring items (frequent itemsets) within a set. Apriori finds rules with support greater than a specified minimum support and confidence greater than a specified minimum confidence.
CUR matrix decomposition	Attribute Importance	CUR matrix decomposition is an alternative to Support Vector Machines(SVM) and Principal Component Analysis (PCA) and an important tool for exploratory data analysis. This algorithm performs analytical processing and singles out important columns and rows.
Expectation Maximization	Clustering	Expectation Maximization (EM) is a density estimation algorithm that performs probabilistic clustering. In density estimation, the goal is to construct a density function that captures how a given population is distributed. The density estimate is based on observed data that represents a sample of the population.  Oracle Data Mining supports probabilistic clustering and data frequency estimates and other applications of Expectation Maximization.
Explicit Semantic Analysis	Feature Extraction	Explicit Semantic Analysis (ESA) uses existing knowledge base as features. An attribute vector represents each feature or a concept. ESA creates a reverse index that maps every attribute to the knowledge base concepts or the concept-attribute association vector value.
<i>k</i> -Means	Clustering	<i>k</i> -Means is a distance-based clustering algorithm that partitions the data into a predetermined number of clusters. Each cluster has a centroid (center of gravity). Cases (individuals within the population) that are in a cluster are close to the centroid.  Oracle Data Mining supports an enhanced version of <i>k</i> -Means. It goes beyond the classical implementation by defining a hierarchical parent-child relationship of clusters.
Non-Negative Matrix Factorization	Feature Extraction	Non-Negative Matrix Factorization (NMF) generates new attributes using linear combinations of the original attributes. The coefficients of the linear combinations are non-negative. During model apply, an NMF model maps the original data into the new set of attributes (features) discovered by the model.
One Class Support Vector Machines	Anomaly Detection	One-class SVM builds a profile of one class. When the model is applied, it identifies cases that are somehow different from that profile. This allows for the detection of rare cases that are not necessarily related to each other.
Orthogonal Partitioning Clustering	Clustering	Orthogonal Partitioning Clustering (o-cluster) creates a hierarchical, grid-based clustering model. The algorithm creates clusters that define dense areas in the attribute space. A sensitivity parameter defines the baseline density level.
Singular Value Decomposition and Principal Component Analysis	Feature Extraction	Singular Value Decomposition (SVD) and Principal Component Analysis (PCA) are orthogonal linear transformations that are optimal at capturing the underlying variance of the data. This property is extremely useful for reducing the dimensionality of high-dimensional data and for supporting meaningful data visualization.  In addition to dimensionality reduction, SVD and PCA have a number of other important applications, such as data de-noising (smoothing), data compression, matrix inversion, and solving a system of linear equations.

**Related Topics**

- [Algorithms](#)

Part III provides basic conceptual information about the algorithms supported by Oracle Data Mining. There is at least one algorithm for each of the mining functions.

## 2.3 Data Preparation

The quality of a model depends to a large extent on the quality of the data used to build (train) it. Much of the time spent in any given data mining project is devoted to data preparation. The data must be carefully inspected, cleansed, and transformed, and algorithm-appropriate data preparation methods must be applied.

The process of data preparation is further complicated by the fact that any data to which a model is applied, whether for testing or for scoring, must undergo the same transformations as the data used to train the model.

### 2.3.1 Oracle Data Mining Simplifies Data Preparation

Oracle Data Mining offers several features that significantly simplify the process of data preparation:

- **Embedded data preparation:** The transformations used in training the model are embedded in the model and automatically executed whenever the model is applied to new data. If you specify transformations for the model, you only have to specify them once.
- **Automatic Data Preparation (ADP):** Oracle Data Mining supports an automated data preparation mode. When ADP is active, Oracle Data Mining automatically performs the data transformations required by the algorithm. The transformation instructions are embedded in the model along with any user-specified transformation instructions.
- **Automatic management of missing values and sparse data:** Oracle Data Mining uses consistent methodology across mining algorithms to handle sparsity and missing values.
- **Transparency:** Oracle Data Mining provides model details, which are a view of the attributes that are internal to the model. This insight into the inner details of the model is possible because of reverse transformations, which map the transformed attribute values to a form that can be interpreted by a user. Where possible, attribute values are reversed to the original column values. Reverse transformations are also applied to the target of a supervised model, thus the results of scoring are in the same units as the units of the original target.
- **Tools for custom data preparation:** Oracle Data Mining provides many common transformation routines in the `DBMS_DATA_MINING_TRANSFORM` PL/SQL package. You can use these routines, or develop your own routines in SQL, or both. The SQL language is well suited for implementing transformations in the database. You can use custom transformation instructions along with ADP or instead of ADP.

### 2.3.2 Case Data

Most data mining algorithms act on single-record case data, where the information for each case is stored in a separate row. The data attributes for the cases are stored in the columns.

When the data is organized in transactions, the data for one case (one transaction) is stored in many rows. An example of transactional data is market basket data. With the single exception of Association Rules, which can operate on native transactional data, Oracle Data Mining algorithms require single-record case organization.

#### 2.3.2.1 Nested Data

Oracle Data Mining supports attributes in nested columns. A transactional table can be cast as a nested column and included in a table of single-record case data. Similarly, star schemas can

be cast as nested columns. With nested data transformations, Oracle Data Mining can effectively mine data originating from multiple sources and configurations.

## 2.3.3 Text Data

Prepare and transform unstructured text data for data mining.

Oracle Data Mining interprets `CLOB` columns and long `VARCHAR2` columns automatically as unstructured text. Additionally, you can specify columns of short `VARCHAR2`, `CHAR`, `BLOB`, and `BFILE` as unstructured text. Unstructured text includes data items such as web pages, document libraries, Power Point presentations, product specifications, emails, comment fields in reports, and call center notes.

Oracle Data Mining uses Oracle Text utilities and term weighting strategies to transform unstructured text for mining. In text transformation, text terms are extracted and given numeric values in a text index. The text transformation process is configurable for the model and for individual attributes. Once transformed, the text can be mined with a data mining algorithm.

### Related Topics

- Preparing the Data
- Transforming the Data
- Mining Unstructured Text

## 2.4 In-Database Scoring

Scoring is the application of a data mining algorithm to new data. In traditional data mining, models are built using specialized software on a remote system and deployed to another system for scoring. This is a cumbersome, error-prone process open to security violations and difficulties in data synchronization.

With Oracle Data Mining, scoring is easy and secure. The scoring engine and the data both reside within the database. Scoring is an extension to the SQL language, so the results of mining can easily be incorporated into applications and reporting systems.

### 2.4.1 Parallel Execution and Ease of Administration

All Oracle Data Mining scoring routines support parallel execution for scoring large data sets.

In-database scoring provides performance advantages. All Oracle Data Mining scoring routines support parallel execution, which significantly reduces the time required for executing complex queries and scoring large data sets.

In-database mining minimizes the IT effort needed to support data mining initiatives. Using standard database techniques, models can easily be refreshed (re-created) on more recent data and redeployed. The deployment is immediate since the scoring query remains the same; only the underlying model is replaced in the database.

### Related Topics

- *Oracle Database VLDB and Partitioning Guide*

### 2.4.2 SQL Functions for Model Apply and Dynamic Scoring

In Oracle Data Mining, scoring is performed by SQL language functions. Understand the different ways involved in SQL function scoring.

The functions perform prediction, clustering, and feature extraction. The functions can be invoked in two different ways: By applying a mining model object ([Example 2-1](#)), or by executing an analytic clause that computes the mining analysis dynamically and applies it to the data ([Example 2-2](#)). Dynamic scoring, which eliminates the need for a model, can supplement, or even replace, the more traditional data mining methodology described in "The Data Mining Process".

In [Example 2-1](#), the `PREDICTION_PROBABILITY` function applies the model `svmc_sh_clas_sample`, created in [Example 1-1](#), to score the data in `mining_data_apply_v`. The function returns the ten customers in Italy who are most likely to use an affinity card.

In [Example 2-2](#), the functions `PREDICTION` and `PREDICTION_PROBABILITY` use the analytic syntax (the `OVER ()` clause) to dynamically score the data in `mining_data_apply_v`. The query returns the customers who currently do not have an affinity card with the probability that they are likely to use.

### Example 2-1 Applying a Mining Model to Score Data

```
SELECT cust_id FROM
  (SELECT cust_id,
         rank() over (order by PREDICTION_PROBABILITY(svmc_sh_clas_sample, 1
              USING *) DESC, cust_id) rnk
   FROM mining_data_apply_v
   WHERE country_name = 'Italy')
WHERE rnk <= 10
ORDER BY rnk;
```

```
  CUST_ID
-----
    101445
    100179
    100662
    100733
    100554
    100081
    100344
    100324
    100185
    101345
```

### Example 2-2 Executing an Analytic Function to Score Data

```
SELECT cust_id, pred_prob FROM
  (SELECT cust_id, affinity_card,
         PREDICTION(FOR TO_CHAR(affinity_card) USING *) OVER () pred_card,
         PREDICTION_PROBABILITY(FOR TO_CHAR(affinity_card),1 USING *) OVER () pred_prob
   FROM mining_data_build_v)
WHERE affinity_card = 0
AND pred_card = 1
ORDER BY pred_prob DESC;
```

```
  CUST_ID PRED_PROB
-----
    102434         .96
    102365         .96
    102330         .96
    101733         .95
    102615         .94
    102686         .94
    102749         .93
    .
    .
```

.  
101656 .51

# Part II

## Mining Functions

Part II provides basic conceptual information about the mining functions that the Oracle Data Mining supports.

Mining functions represent a class of mining problems that can be solved using data mining algorithms.

Part II contains these chapters:

- [Regression](#)
- [Classification](#)
- [Anomaly Detection](#)
- [Clustering](#)
- [Association](#)
- [Feature Selection and Extraction](#)
- [Time Series](#)



### Note:

The term mining function has no relationship to a SQL language function.

### Related Topics

- [Algorithms](#)  
Part III provides basic conceptual information about the algorithms supported by Oracle Data Mining. There is at least one algorithm for each of the mining functions.
- *Oracle Database SQL Language Reference*



# 3

## Regression

Learn how to predict a continuous numerical target through Regression - the supervised mining function.

- [About Regression](#)
- [Testing a Regression Model](#)
- [Regression Algorithms](#)

### Related Topics

- [Oracle Data Mining Basics](#)  
Understand the basic concepts of Oracle Data Mining.

### 3.1 About Regression

Regression is a data mining function that predicts numeric values along a continuum. Profit, sales, mortgage rates, house values, square footage, temperature, or distance can be predicted using Regression techniques. For example, a Regression model can be used to predict the value of a house based on location, number of rooms, lot size, and other factors.

A Regression task begins with a data set in which the target values are known. For example, a Regression model that predicts house values can be developed based on observed data for many houses over a period of time. In addition to the value, the data can track the age of the house, square footage, number of rooms, taxes, school district, proximity to shopping centers, and so on. House value can be the target, the other attributes are the predictors, and the data for each house constitutes a case.

In the model build (training) process, a Regression algorithm estimates the value of the target as a function of the predictors for each case in the build data. These relationships between predictors and target are summarized in a model, which can then be applied to a different data set in which the target values are unknown.

Regression models are tested by computing various statistics that measure the difference between the predicted values and the expected values. The historical data for a Regression project is typically divided into two data sets: one for building the model, the other for testing the model.

Regression modeling has many applications in trend analysis, business planning, marketing, financial forecasting, time series prediction, biomedical and drug response modeling, and environmental modeling.

#### 3.1.1 How Does Regression Work?

You do not need to understand the mathematics used in regression analysis to develop and use quality regression models for data mining. However, it is helpful to understand a few basic concepts.

Regression analysis seeks to determine the values of parameters for a function that cause the function to best fit a set of data observations that you provide. The following equation expresses these relationships in symbols. It shows that regression is the process of estimating the value of a continuous target ( $y$ ) as a function ( $F$ ) of one or more predictors ( $x_1, x_2, \dots, x_n$ ), a set of parameters ( $\theta_1, \theta_2, \dots, \theta_n$ ), and a measure of error ( $e$ ).

$$y = F(\mathbf{x}, \theta) + e$$

The predictors can be understood as independent variables and the target as a dependent variable. The error, also called the **residual**, is the difference between the expected and predicted value of the dependent variable. The regression parameters are also known as **regression coefficients**.

The process of training a regression model involves finding the parameter values that minimize a measure of the error, for example, the sum of squared errors.

There are different families of regression functions and different ways of measuring the error.

### 3.1.1.1 Linear Regression

A linear regression technique can be used if the relationship between the predictors and the target can be approximated with a straight line.

Regression with a single predictor is the easiest to visualize. Simple linear regression with a single predictor is shown in the following figure:

**Figure 3-1 Linear Regression With a Single Predictor**

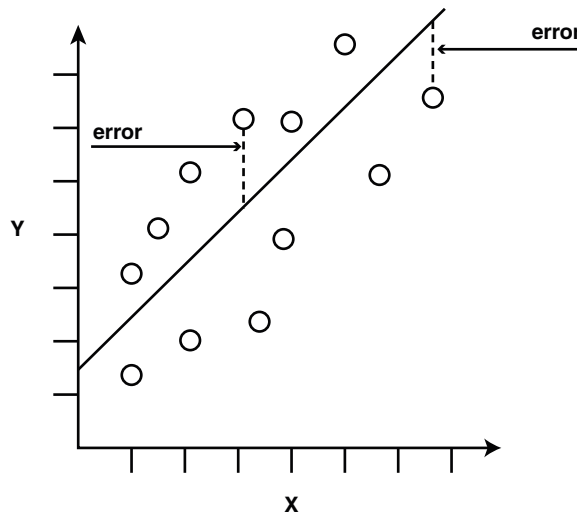

Linear regression with a single predictor can be expressed with the following equation.

$$y = \theta_2 x + \theta_1 + e$$

The regression parameters in simple linear regression are:

- The **slope** of the line ( $\theta_2$ ) — the angle between a data point and the regression line
- The **y intercept** ( $\theta_1$ ) — the point where  $x$  crosses the  $y$  axis ( $x = 0$ )

### 3.1.1.2 Multivariate Linear Regression

The term **multivariate linear regression** refers to linear regression with two or more predictors ( $x_1, x_2, \dots, x_n$ ). When multiple predictors are used, the regression line cannot be visualized in two-dimensional space. However, the line can be computed simply by expanding the equation for single-predictor linear regression to include the parameters for each of the predictors.

$$y = \theta_1 + \theta_2 x_1 + \theta_3 x_2 + \dots + \theta_n x_{n-1} + e$$

### 3.1.1.3 Regression Coefficients

In multivariate linear regression, the regression parameters are often referred to as coefficients. When you build a multivariate linear regression model, the algorithm computes a coefficient for each of the predictors used by the model. The coefficient is a measure of the impact of the predictor  $x$  on the target  $y$ . Numerous statistics are available for analyzing the regression coefficients to evaluate how well the regression line fits the data.

### 3.1.1.4 Nonlinear Regression

Often the relationship between  $x$  and  $y$  cannot be approximated with a straight line. In this case, a nonlinear regression technique can be used. Alternatively, the data can be preprocessed to make the relationship linear.

Nonlinear regression models define  $y$  as a function of  $x$  using an equation that is more complicated than the linear regression equation. In the following figure,  $x$  and  $y$  have a nonlinear relationship.

**Figure 3-2 Nonlinear Regression With a Single Predictor**

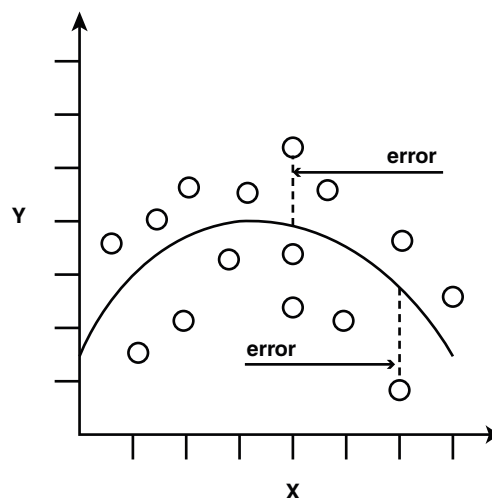

### 3.1.1.5 Multivariate Nonlinear Regression

The term **multivariate nonlinear regression** refers to nonlinear regression with two or more predictors ( $x_1, x_2, \dots, x_n$ ). When multiple predictors are used, the nonlinear relationship cannot be visualized in two-dimensional space.

### 3.1.1.6 Confidence Bounds

A Regression model predicts a numeric target value for each case in the scoring data. In addition to the predictions, some Regression algorithms can identify confidence bounds, which are the upper and lower boundaries of an interval in which the predicted value is likely to lie.

When a model is built to make predictions with a given confidence, the confidence interval is produced along with the predictions. For example, a model predicts the value of a house to be \$500,000 with a 95% confidence that the value is between \$475,000 and \$525,000.

## 3.2 Testing a Regression Model

A regression model is tested by applying it to test data with known target values and comparing the predicted values with the known values.

The test data must be compatible with the data used to build the model and must be prepared in the same way that the build data was prepared. Typically the build data and test data come from the same historical data set. A percentage of the records is used to build the model; the remaining records are used to test the model.

Test metrics are used to assess how accurately the model predicts these known values. If the model performs well and meets the business requirements, it can then be applied to new data to predict the future.

### 3.2.1 Regression Statistics

The Root Mean Squared Error and the Mean Absolute Error are commonly used statistics for evaluating the overall quality of a regression model. Different statistics may also be available depending on the regression methods used by the algorithm.

#### 3.2.1.1 Root Mean Squared Error

The Root Mean Squared Error (RMSE) is the square root of the average squared distance of a data point from the fitted line.

This SQL expression calculates the RMSE.

```
SQRT(AVG((predicted_value - actual_value) * (predicted_value - actual_value)))
```

This formula shows the RMSE in mathematical symbols. The large sigma character represents summation;  $j$  represents the current predictor, and  $n$  represents the number of predictors.

**Figure 3-3 Room Mean Squared Error**

$$\text{RMSE} = \sqrt{\frac{1}{n} \sum_{j=1}^n (y_j - \hat{y}_j)^2}$$

### 3.2.1.2 Mean Absolute Error

The Mean Absolute Error (MAE) is the average of the absolute value of the residuals (error). The MAE is very similar to the RMSE but is less sensitive to large errors.

This SQL expression calculates the MAE.

```
AVG(ABS(predicted_value - actual_value))
```

This formula shows the MAE in mathematical symbols. The large sigma character represents summation;  $j$  represents the current predictor, and  $n$  represents the number of predictors.

**Figure 3-4 Mean Absolute Error**

$$\text{MAE} = \frac{1}{n} \sum_{j=1}^n |y_j - \hat{y}_j|$$

## 3.3 Regression Algorithms

Oracle Data Mining supports three algorithms for Regression: Generalized Linear Models (GLM), Neural Network (NN), and Support Vector Machines (SVM).

Generalized Linear Models (GLM) and Support Vector Machines (SVM) algorithms are particularly suited for mining data sets that have very high dimensionality (many attributes), including transactional and unstructured data.

- **Generalized Linear Models (GLM)**

GLM is a popular statistical technique for linear modeling. Oracle Data Mining implements GLM for Regression and for binary classification. GLM provides extensive coefficient statistics and model statistics, as well as row diagnostics. GLM also supports confidence bounds.

- **Neural Network**

Neural networks are powerful algorithms that can learn arbitrary nonlinear regression functions.

- **Support Vector Machines (SVM)**

SVM is a powerful, state-of-the-art algorithm for linear and nonlinear Regression. Oracle Data Mining implements SVM for Regression, classification, and anomaly detection. SVM Regression supports two kernels: the Gaussian kernel for nonlinear Regression, and the linear kernel for Linear Regression.

 **Note:**

Oracle Data Mining uses linear kernel SVM as the default Regression algorithm.

### Related Topics

- [Generalized Linear Models](#)  
Learn how to use Generalized Linear Models (GLM) statistical technique for Linear modeling.
- [Support Vector Machines](#)  
Learn how to use Support Vector Machines, a powerful algorithm based on statistical learning theory.
- [Neural Network](#)  
Learn about Neural Network for Regression and Classification mining functions.

# 4

## Classification

Learn how to predict a categorical target through Classification - the supervised mining function.

- [About Classification](#)
- [Testing a Classification Model](#)
- [Biasing a Classification Model](#)
- [Classification Algorithms](#)

### Related Topics

- [Oracle Data Mining Basics](#)  
Understand the basic concepts of Oracle Data Mining.

### 4.1 About Classification

Classification is a data mining function that assigns items in a collection to target categories or classes. The goal of classification is to accurately predict the target class for each case in the data. For example, a classification model can be used to identify loan applicants as low, medium, or high credit risks.

A classification task begins with a data set in which the class assignments are known. For example, a classification model that predicts credit risk can be developed based on observed data for many loan applicants over a period of time. In addition to the historical credit rating, the data might track employment history, home ownership or rental, years of residence, number and type of investments, and so on. Credit rating is the target, the other attributes are the predictors, and the data for each customer constitutes a case.

Classifications are discrete and do not imply order. Continuous, floating-point values indicate a numerical, rather than a categorical, target. A predictive model with a numerical target uses a regression algorithm, not a classification algorithm.

The simplest type of classification problem is binary classification. In binary classification, the target attribute has only two possible values: for example, high credit rating or low credit rating. Multiclass targets have more than two values: for example, low, medium, high, or unknown credit rating.

In the model build (training) process, a classification algorithm finds relationships between the values of the predictors and the values of the target. Different classification algorithms use different techniques for finding relationships. These relationships are summarized in a model, which can then be applied to a different data set in which the class assignments are unknown.

Classification models are tested by comparing the predicted values to known target values in a set of test data. The historical data for a classification project is typically divided into two data sets: one for building the model; the other for testing the model.

Applying a classification model results in class assignments and probabilities for each case. For example, a model that classifies customers as low, medium, or high value also predicts the probability of each classification for each customer.

Classification has many applications in customer segmentation, business modeling, marketing, credit analysis, and biomedical and drug response modeling.

## 4.2 Testing a Classification Model

A classification model is tested by applying it to test data with known target values and comparing the predicted values with the known values.

The test data must be compatible with the data used to build the model and must be prepared in the same way that the build data was prepared. Typically the build data and test data come from the same historical data set. A percentage of the records is used to build the model; the remaining records are used to test the model.

Test metrics are used to assess how accurately the model predicts the known values. If the model performs well and meets the business requirements, it can then be applied to new data to predict the future.

### 4.2.1 Confusion Matrix

A confusion matrix displays the number of correct and incorrect predictions made by the model compared with the actual classifications in the test data. The matrix is  $n$ -by- $n$ , where  $n$  is the number of classes.

The following figure shows a confusion matrix for a binary classification model. The rows present the number of actual classifications in the test data. The columns present the number of predicted classifications made by the model.

**Figure 4-1 Confusion Matrix for a Binary Classification Model**

		PREDICTED CLASS	
		affinity_card = 1	affinity_card = 0
ACTUAL CLASS	affinity_card = 1	516	25
	affinity_card = 0	10	725

In this example, the model correctly predicted the positive class (also called true positive (TP)) for `affinity_card` 516 times and incorrectly predicted (also called false negative (FN)) it 25 times. The model correctly predicted the negative class (also called true negative (TN)) for `affinity_card` 725 times and incorrectly predicted (also called false positive (FP)) it 10 times. The following can be computed from this confusion matrix:

- The model made 1241 correct predictions, that is, TP + TN, (516 + 725).
- The model made 35 incorrect predictions, that is, FN + FP, (25 + 10).
- There are 1276 total scored cases, (516 + 25 + 10 + 725).



- The error rate is  $35/1276 = 0.0274$ . (FN+FP/Total)
- The overall accuracy rate is  $1241/1276 = 0.9725$  (TP+TN)/Total).

### Precision and Recall

Consider the same example, the accuracy rate shows 0.97. However, there are cases where the model has incorrectly predicted. **Precision** (positive predicted value) is the ability of a classification model to return only relevant cases. Precision can be calculated as  $TP/TP+FP$ . **Recall** (sensitivity or true positive rate) is the ability of a classification model to return relevant cases. Recall can be calculated as  $TP/TP+FN$ . The precision in this example is  $516/526 = 0.98$ . The recall in this example is  $516/541 = 0.95$ . Ideally, the model is good when both precision and recall are 1. This can happen when the numerator and the denominator are equal. That means, for precision, FP is zero and for recall, FN is zero.

## 4.2.2 Lift

Lift measures the degree to which the predictions of a classification model are better than randomly-generated predictions.

Lift applies to binary classification only, and it requires the designation of a positive class. If the model itself does not have a binary target, you can compute lift by designating one class as positive and combining all the other classes together as one negative class.

Numerous statistics can be calculated to support the notion of lift. Basically, lift can be understood as a ratio of two percentages: the percentage of correct positive classifications made by the model to the percentage of actual positive classifications in the test data. For example, if 40% of the customers in a marketing survey have responded favorably (the positive classification) to a promotional campaign in the past and the model accurately predicts 75% of them, the lift is obtained by dividing .75 by .40. The resulting lift is 1.875.

Lift is computed against quantiles that each contain the same number of cases. The data is divided into quantiles after it is scored. It is ranked by probability of the positive class from highest to lowest, so that the highest concentration of positive predictions is in the top quantiles. A typical number of quantiles is 10.

Lift is commonly used to measure the performance of response models in marketing applications. The purpose of a response model is to identify segments of the population with potentially high concentrations of positive responders to a marketing campaign. Lift reveals how much of the population must be solicited to obtain the highest percentage of potential responders.

### Related Topics

- [Positive and Negative Classes](#)  
Discusses the importance of positive and negative classes in a confusion matrix.

### 4.2.2.1 Lift Statistics

Learn the different Lift statistics that Oracle Data Mining can compute.

Oracle Data Mining computes the following lift statistics:

- **Probability threshold** for a quantile  $n$  is the minimum probability for the positive target to be included in this quantile or any preceding quantiles (quantiles  $n-1, n-2, \dots, 1$ ). If a cost matrix is used, a cost threshold is reported instead. The cost threshold is the maximum cost for the positive target to be included in this quantile or any of the preceding quantiles.
- **Cumulative gain** is the ratio of the cumulative number of positive targets to the total number of positive targets.

- **Target density** of a quantile is the number of true positive instances in that quantile divided by the total number of instances in the quantile.
- **Cumulative target density** for quantile  $n$  is the target density computed over the first  $n$  quantiles.
- **Quantile lift** is the ratio of the target density for the quantile to the target density over all the test data.
- **Cumulative percentage of records** for a quantile is the percentage of all cases represented by the first  $n$  quantiles, starting at the end that is most confidently positive, up to and including the given quantile.
- **Cumulative number of targets** for quantile  $n$  is the number of true positive instances in the first  $n$  quantiles.
- **Cumulative number of nontargets** is the number of actually negative instances in the first  $n$  quantiles.
- **Cumulative lift** for a quantile is the ratio of the cumulative target density to the target density over all the test data.

#### Related Topics

- [Costs](#)

## 4.2.3 Receiver Operating Characteristic (ROC)

ROC is a metric for comparing predicted and actual target values in a classification model.

ROC, like Lift, applies to Binary Classification and requires the designation of a positive class.

You can use ROC to gain insight into the decision-making ability of the model. How likely is the model to accurately predict the negative or the positive class?

ROC measures the impact of changes in the **probability threshold**. The probability threshold is the decision point used by the model for classification. The default probability threshold for binary classification is 0.5. When the probability of a prediction is 50% or more, the model predicts that class. When the probability is less than 50%, the other class is predicted. (In multiclass classification, the predicted class is the one predicted with the highest probability.)

#### Related Topics

- [Positive and Negative Classes](#)  
Discusses the importance of positive and negative classes in a confusion matrix.

### 4.2.3.1 The ROC Curve

ROC can be plotted as a curve on an X-Y axis. The **false positive rate** is placed on the X axis. The **true positive rate** is placed on the Y axis.

The top left corner is the optimal location on an ROC graph, indicating a high true positive rate and a low false positive rate.

### 4.2.3.2 Area Under the Curve

The area under the ROC curve (AUC) measures the discriminating ability of a binary classification model. The larger the AUC, the higher the likelihood that an actual positive case is assigned, and a higher probability of being positive than an actual negative case. The AUC measure is especially useful for data sets with unbalanced target distribution (one target class dominates the other).

### 4.2.3.3 ROC and Model Bias

The ROC curve for a model represents all the possible combinations of values in its confusion matrix.

Changes in the probability threshold affect the predictions made by the model. For instance, if the threshold for predicting the positive class is changed from 0.5 to 0.6, then fewer positive predictions are made. This affects the distribution of values in the confusion matrix: the number of true and false positives and true and false negatives differ.

You can use ROC to find the probability thresholds that yield the highest overall accuracy or the highest per-class accuracy. For example, if it is important to you to accurately predict the positive class, but you don't care about prediction errors for the negative class, then you can lower the threshold for the positive class. This can bias the model in favor of the positive class.

A cost matrix is a convenient mechanism for changing the probability thresholds for model scoring.

#### Related Topics

- [Costs](#)

### 4.2.3.4 ROC Statistics

Oracle Data Mining computes the following ROC statistics:

- **Probability threshold:** The minimum predicted positive class probability resulting in a positive class prediction. Different threshold values result in different hit rates and different false alarm rates.
- **True negatives:** Negative cases in the test data with predicted probabilities strictly less than the probability threshold (correctly predicted).
- **True positives:** Positive cases in the test data with predicted probabilities greater than or equal to the probability threshold (correctly predicted).
- **False negatives:** Positive cases in the test data with predicted probabilities strictly less than the probability threshold (incorrectly predicted).
- **False positives:** Negative cases in the test data with predicted probabilities greater than or equal to the probability threshold (incorrectly predicted).
- **True positive fraction:** Hit rate. ( $\text{true positives} / (\text{true positives} + \text{false negatives})$ )
- **False positive fraction:** False alarm rate. ( $\text{false positives} / (\text{false positives} + \text{true negatives})$ )

## 4.3 Biasing a Classification Model

Costs, prior probabilities, and class weights are methods for biasing classification models.

### 4.3.1 Costs

A cost matrix is a mechanism for influencing the decision making of a model. A cost matrix can cause the model to minimize costly misclassifications. It can also cause the model to maximize beneficial accurate classifications.

For example, if a model classifies a customer with poor credit as low risk, this error is costly. A cost matrix can bias the model to avoid this type of error. The cost matrix can also be used to

bias the model in favor of the correct classification of customers who have the worst credit history.

ROC is a useful metric for evaluating how a model behaves with different probability thresholds. You can use ROC to help you find optimal costs for a given classifier given different usage scenarios. You can use this information to create cost matrices to influence the deployment of the model.

### 4.3.1.1 Costs Versus Accuracy

Compares Cost matrix and Confusion matrix for costs and accuracy to evaluate model quality.

Like a confusion matrix, a cost matrix is an  $n$ -by- $n$  matrix, where  $n$  is the number of classes. Both confusion matrices and cost matrices include each possible combination of actual and predicted results based on a given set of test data.

A confusion matrix is used to measure accuracy, the ratio of correct predictions to the total number of predictions. A cost matrix is used to specify the relative importance of accuracy for different predictions. In most business applications, it is important to consider costs in addition to accuracy when evaluating model quality.

#### Related Topics

- [Confusion Matrix](#)

### 4.3.1.2 Positive and Negative Classes

Discusses the importance of positive and negative classes in a confusion matrix.

The positive class is the class that you care the most about. Designation of a positive class is required for computing Lift and ROC.

In the confusion matrix, in the following figure, the value 1 is designated as the positive class. This means that the creator of the model has determined that it is more important to accurately predict customers who increase spending with an affinity card (`affinity_card=1`) than to accurately predict non-responders (`affinity_card=0`). If you give affinity cards to some customers who are not likely to use them, there is little loss to the company since the cost of the cards is low. However, if you overlook the customers who are likely to respond, you miss the opportunity to increase your revenue.

**Figure 4-2 Positive and Negative Predictions**

		PREDICTED CLASS	
		<code>affinity_card = 1</code>	<code>affinity_card = 0</code>
ACTUAL CLASS	<code>affinity_card = 1</code>	516 (true positive)	25 (false negative)
	<code>affinity_card = 0</code>	10 (false positive)	725 (true negative)

The true and false positive rates in this confusion matrix are:

- False positive rate —  $10/(10 + 725) = .01$
- True positive rate —  $516/(516 + 25) = .95$

**Related Topics**

- [Lift](#)  
 Lift measures the degree to which the predictions of a classification model are better than randomly-generated predictions.
- [Receiver Operating Characteristic \(ROC\)](#)  
 ROC is a metric for comparing predicted and actual target values in a classification model.

### 4.3.1.3 Assigning Costs and Benefits

In a cost matrix, positive numbers (costs) can be used to influence negative outcomes. Since negative costs are interpreted as benefits, negative numbers (benefits) can be used to influence positive outcomes.

Suppose you have calculated that it costs your business \$1500 when you do not give an affinity card to a customer who can increase spending. Using the model with the confusion matrix shown in [Figure 4-2](#), each false negative (misclassification of a responder) costs \$1500. Misclassifying a non-responder is less expensive to your business. You estimate that each false positive (misclassification of a non-responder) only costs \$300.

You want to keep these costs in mind when you design a promotion campaign. You estimate that it costs \$10 to include a customer in the promotion. For this reason, you associate a benefit of \$10 with each true negative prediction, because you can simply eliminate those customers from your promotion. Each customer that you eliminate represents a savings of \$10. In your cost matrix, you specify this benefit as -10, a negative cost.

The following figure shows how you would represent these costs and benefits in a cost matrix:

**Figure 4-3 Cost Matrix Representing Costs and Benefits**

		PREDICTED	
		affinity_card = 1	affinity_card = 0
ACTUAL	affinity_card = 1	0	1500
	affinity_card = 0	300	-10

With Oracle Data Mining you can specify costs to influence the scoring of any classification model. Decision Tree models can also use a cost matrix to influence the model build.

## 4.3.2 Priors and Class Weights

Learn about Priors and Class Weights in a Classification model to produce a useful result.

With Bayesian models, you can specify **Prior** probabilities to offset differences in distribution between the build data and the real population (scoring data). With other forms of Classification, you are able to specify **Class Weights**, which have the same biasing effect as priors.

In many problems, one target value dominates in frequency. For example, the positive responses for a telephone marketing campaign is 2% or less, and the occurrence of fraud in credit card transactions is less than 1%. A classification model built on historic data of this type cannot observe enough of the rare class to be able to distinguish the characteristics of the two classes; the result can be a model that when applied to new data predicts the frequent class for every case. While such a model can be highly accurate, it is not very useful. This illustrates that it is not a good idea to rely solely on accuracy when judging the quality of a Classification model.

To correct for unrealistic distributions in the training data, you can specify priors for the model build process. Other approaches to compensating for data distribution issues include stratified sampling and anomaly detection.

### Related Topics

- [Anomaly Detection](#)  
Learn how to detect rare cases in the data through Anomaly Detection - an unsupervised function.

## 4.4 Classification Algorithms

Learn different Classification algorithms used in Oracle Data Mining.

Oracle Data Mining provides the following algorithms for classification:

- **Decision Tree**  
Decision trees automatically generate rules, which are conditional statements that reveal the logic used to build the tree.
- **Explicit Semantic Analysis**  
Explicit Semantic Analysis (ESA) is designed to make predictions for text data. This algorithm can address use cases with hundreds of thousands of classes.
- **Naive Bayes**  
Naive Bayes uses Bayes' Theorem, a formula that calculates a probability by counting the frequency of values and combinations of values in the historical data.
- **Generalized Linear Models (GLM)**  
GLM is a popular statistical technique for linear modeling. Oracle Data Mining implements GLM for binary classification and for regression. GLM provides extensive coefficient statistics and model statistics, as well as row diagnostics. GLM also supports confidence bounds.
- **Random Forest**  
Random Forest is a powerful and popular machine learning algorithm that brings significant performance and scalability benefits.

- **Support Vector Machines (SVM)**

SVM is a powerful, state-of-the-art algorithm based on linear and nonlinear regression. Oracle Data Mining implements SVM for binary and multiclass classification.



**Note:**

Oracle Data Mining uses Naive Bayes as the default classification algorithm.

**Related Topics**

- [Decision Tree](#)  
Learn how to use Decision Tree algorithm. Decision Tree is one of the Classification algorithms that the Oracle Data Mining supports.
- [Explicit Semantic Analysis](#)  
Learn how to use Explicit Semantic Analysis (ESA) as an unsupervised algorithm for Feature Extraction function and as a supervised algorithm for Classification.
- [Naive Bayes](#)  
Learn how to use Naive Bayes Classification algorithm that the Oracle Data Mining supports.
- [Generalized Linear Models](#)  
Learn how to use Generalized Linear Models (GLM) statistical technique for Linear modeling.
- [Random Forest](#)  
Learn how to use Random Forest as a classification algorithm.
- [Support Vector Machines](#)  
Learn how to use Support Vector Machines, a powerful algorithm based on statistical learning theory.

# 5

## Anomaly Detection

Learn how to detect rare cases in the data through Anomaly Detection - an unsupervised function.

- [About Anomaly Detection](#)
- [Anomaly Detection Algorithm](#)

### Related Topics

- [Oracle Data Mining Basics](#)  
Understand the basic concepts of Oracle Data Mining.

### See Also:

- Campos, M.M., Milenova, B.L., Yarmus, J.S., "Creation and Deployment of Data Mining-Based Intrusion Detection Systems in Oracle Database 10g"  
Oracle Data Mining

## 5.1 About Anomaly Detection

The goal of anomaly detection is to identify cases that are unusual within data that is seemingly homogeneous. Anomaly detection is an important tool for detecting fraud, network intrusion, and other rare events that can have great significance but are hard to find.

Anomaly detection can be used to solve problems like the following:

- A law enforcement agency compiles data about illegal activities, but nothing about legitimate activities. How can a suspicious activity be flagged?  
The law enforcement data is all of one class. There are no counter-examples.
- An insurance agency processes millions of insurance claims, knowing that a very small number are fraudulent. How can the fraudulent claims be identified?  
The claims data contains very few counter-examples. They are outliers.

### 5.1.1 One-Class Classification

Learn about Anomaly Detection as one-class Classification in training data.

Anomaly detection is a form of Classification. Anomaly detection is implemented as one-class Classification, because only one class is represented in the training data. An anomaly detection model predicts whether a data point is typical for a given distribution or not. An atypical data point can be either an outlier or an example of a previously unseen class.



Normally, a Classification model must be trained on data that includes both examples and counter-examples for each class so that the model can learn to distinguish between them. For example, a model that predicts the side effects of a medication must be trained on data that includes a wide range of responses to the medication.

A one-class classifier develops a profile that generally describes a typical case in the training data. Deviation from the profile is identified as an anomaly. One-class classifiers are sometimes referred to as positive security models, because they seek to identify "good" behaviors and assume that all other behaviors are bad.

 **Note:**

Solving a one-class classification problem can be difficult. The accuracy of one-class classifiers cannot usually match the accuracy of standard classifiers built with meaningful counterexamples.

The goal of anomaly detection is to provide some useful information where no information was previously attainable. However, if there are enough of the "rare" cases so that stratified sampling produce a training set with enough counter examples for a standard classification model, then that is generally a better solution.

**Related Topics**

- [About Classification](#)

## 5.1.2 Anomaly Detection for Single-Class Data

In single-class data, all the cases have the same classification. Counter-examples, instances of another class, are hard to specify or expensive to collect. For instance, in text document classification, it is easy to classify a document under a given topic. However, the universe of documents outside of this topic can be very large and diverse. Thus, it is not feasible to specify other types of documents as counter-examples.

Anomaly detection can be used to find unusual instances of a particular type of document.

## 5.1.3 Anomaly Detection for Finding Outliers

Outliers are cases that are unusual because they fall outside the distribution that is considered normal for the data. For example, census data shows a median household income of \$70,000 and a mean household income of \$80,000, but one or two households have an income of \$200,000. These cases can probably be identified as outliers.

The distance from the center of a normal distribution indicates how typical a given point is with respect to the distribution of the data. Each case can be ranked according to the probability that it is either typical or atypical.

The presence of outliers can have a deleterious effect on many forms of data mining. You can use Anomaly Detection to identify outliers before mining the data.

## 5.2 Anomaly Detection Algorithm

Learn about One-Class Support Vector Machines (SVM) for Anomaly Detection.

Oracle Data Mining supports One-Class Support Vector Machines (SVM) for Anomaly Detection. When used for Anomaly Detection, SVM classification does not use a target.

**Related Topics**

- [One-Class SVM](#)

# 6

## Clustering

Learn how to discover natural groupings in the data through Clustering - the unsupervised mining function.

- [About Clustering](#)
- [Evaluating a Clustering Model](#)
- [Clustering Algorithms](#)

### Related Topics

- [Oracle Data Mining Basics](#)  
Understand the basic concepts of Oracle Data Mining.

## 6.1 About Clustering

Clustering analysis finds clusters of data objects that are similar to one another. The members of a cluster are more like each other than they are like members of other clusters. Different clusters can have members in common. The goal of clustering analysis is to find high-quality clusters such that the inter-cluster similarity is low and the intra-cluster similarity is high.

Clustering, like classification, is used to segment the data. Unlike classification, clustering models segment data into groups that were not previously defined. Classification models segment data by assigning it to previously-defined classes, which are specified in a target. Clustering models do not use a target.

Clustering is useful for exploring data. You can use Clustering algorithms to find natural groupings when there are many cases and no obvious groupings.

Clustering can serve as a useful data-preprocessing step to identify homogeneous groups on which you can build supervised models.

You can also use Clustering for Anomaly Detection. Once you segment the data into clusters, you find that some cases do not fit well into any clusters. These cases are anomalies or outliers.

### 6.1.1 How are Clusters Computed?

There are several different approaches to the computation of clusters. Oracle Data Mining supports the following methods:

- **Density-based:** This type of clustering finds the underlying distribution of the data and estimates how areas of high density in the data correspond to peaks in the distribution. High-density areas are interpreted as clusters. Density-based cluster estimation is probabilistic.
- **Distance-based:** This type of clustering uses a distance metric to determine similarity between data objects. The distance metric measures the distance between actual cases in the cluster and the prototypical case for the cluster. The prototypical case is known as the **centroid**.

- **Grid-based:** This type of clustering divides the input space into hyper-rectangular cells and identifies adjacent high-density cells to form clusters.

## 6.1.2 Scoring New Data

Although clustering is an unsupervised mining function, Oracle Data Mining supports the scoring operation for clustering. New data is scored probabilistically.

## 6.1.3 Hierarchical Clustering

The clustering algorithms supported by Oracle Data Mining perform hierarchical clustering. The leaf clusters are the final clusters generated by the algorithm. Clusters higher up in the hierarchy are intermediate clusters.

### 6.1.3.1 Rules

**Rules** describe the data in each cluster. A rule is a conditional statement that captures the logic used to split a parent cluster into child clusters. A rule describes the conditions for a case to be assigned with some probability to a cluster.

### 6.1.3.2 Support and Confidence

**Support** and **confidence** are metrics that describe the relationships between clustering rules and cases. Support is the percentage of cases for which the rule holds. Confidence is the probability that a case described by this rule is actually assigned to the cluster.

## 6.2 Evaluating a Clustering Model

Since known classes are not used in clustering, the interpretation of clusters can present difficulties. How do you know if the clusters can reliably be used for business decision making?

Oracle Data Mining clustering models support a high degree of model transparency. You can evaluate the model by examining information generated by the clustering algorithm: for example, the centroid of a distance-based cluster. Moreover, because the clustering process is hierarchical, you can evaluate the rules and other information related to each cluster's position in the hierarchy.

## 6.3 Clustering Algorithms

Learn different Clustering algorithms used in Oracle Data Mining.

Oracle Data Mining supports these Clustering algorithms:

- **Expectation Maximization**  
Expectation Maximization is a probabilistic, density-estimation Clustering algorithm.
- **k-Means**  
*k*-Means is a distance-based Clustering algorithm. Oracle Data Mining supports an enhanced version of *k*-Means.
- **Orthogonal Partitioning Clustering (O-Cluster)**  
O-Cluster is a proprietary, grid-based Clustering algorithm.

 **See Also:**

Campos, M.M., Milenova, B.L., "O-Cluster: Scalable Clustering of Large High Dimensional Data Sets", Oracle Data Mining Technologies, 10 Van De Graaff Drive, Burlington, MA 01803.

The main characteristics of the two algorithms are compared in the following table.

**Table 6-1 Clustering Algorithms Compared**

Feature	k-Means	O-Cluster	Expectation Maximization
Clustering methodology	Distance-based	Grid-based	Distribution-based
Number of cases	Handles data sets of any size	More appropriate for data sets that have more than 500 cases. Handles large tables through active sampling	Handles data sets of any size
Number of attributes	More appropriate for data sets with a low number of attributes	More appropriate for data sets with a high number of attributes	Appropriate for data sets with many or few attributes
Number of clusters	User-specified	Automatically determined	Automatically determined
Hierarchical clustering	Yes	Yes	Yes
Probabilistic cluster assignment	Yes	Yes	Yes

 **Note:**

Oracle Data Mining uses *k*-Means as the default Clustering algorithm.

### Related Topics

- [Oracle Data Mining](#)
- [Expectation Maximization](#)  
Learn how to use Expectation Maximization Clustering algorithm.
- [k-Means](#)  
Learn how to use enhanced *k*-Means Clustering algorithm that the Oracle Data Mining supports.
- [O-Cluster](#)  
Learn how to use Orthogonal Partitioning Clustering (O-Cluster), an Oracle-proprietary Clustering algorithm.

# 7

## Association

Learn how to discover Association Rules through Association - an unsupervised mining function.

- [About Association](#)
- [Transactional Data](#)
- [Association Algorithm](#)

### Related Topics

- [Oracle Data Mining Basics](#)  
Understand the basic concepts of Oracle Data Mining.

## 7.1 About Association

Association is a data mining function that discovers the probability of the co-occurrence of items in a collection. The relationships between co-occurring items are expressed as **Association Rules**.

### 7.1.1 Association Rules

The results of an Association model are the rules that identify patterns of association within the data. Oracle Data Mining does not support the scoring operation for association modeling.

Association Rules can be applied as follows:

**Support:** How often do these items occur together in the data?

**Confidence:** How frequently the consequent occurs in transactions that contain the antecedent.

**Value:** How much business value is connected to item associations

### 7.1.2 Market-Basket Analysis

Association rules are often used to analyze sales transactions. For example, it is noted that customers who buy cereal at the grocery store often buy milk at the same time. In fact, association analysis find that 85% of the checkout sessions that include cereal also include milk. This relationship can be formulated as the following rule:

Cereal implies milk with 85% confidence

This application of association modeling is called **market-basket analysis**. It is valuable for direct marketing, sales promotions, and for discovering business trends. Market-basket analysis can also be used effectively for store layout, catalog design, and cross-sell.

## 7.1.3 Association Rules and eCommerce

Learn about application of Association Rules in other domains.

Association modeling has important applications in other domains as well. For example, in e-commerce applications, Association Rules may be used for Web page personalization. An association model might find that a user who visits pages A and B is 70% likely to also visit page C in the same session. Based on this rule, a dynamic link can be created for users who are likely to be interested in page C. The association rule is expressed as follows:

A and B imply C with 70% confidence

### Related Topics

- [Confidence](#)

The confidence of a rule indicates the probability of both the antecedent and the consequent appearing in the same transaction.

## 7.2 Transactional Data

Learn about transactional data, also known as market-basket data.

Unlike other data mining functions, Association is transaction-based. In transaction processing, a case includes a collection of items such as the contents of a market basket at the checkout counter. The collection of items in the transaction is an attribute of the transaction. Other attributes might be a timestamp or user ID associated with the transaction.

Transactional data, also known as **market-basket data**, is said to be in **multi-record case** format because a set of records (rows) constitute a case. For example, in the following figure, case 11 is made up of three rows while cases 12 and 13 are each made up of four rows.

**Figure 7-1 Transactional Data**

case ID	attribute1	attribute2
TRANS_ID	ITEM_ID	OPER_ID
11	B	m5203
11	D	m5203
11	E	m5203
12	A	m5203
12	B	m5203
12	C	m5203
12	E	m5203
13	B	q5597
13	C	q5597
13	D	q5597
13	E	q5597

Non transactional data is said to be in a **single-record case** format because a single record (row) constitutes a case. In Oracle Data Mining, association models can be built using either transactional or non transactional or two-dimensional data formats. If the data is non transactional, it is possible to transform to a nested column to make it transactional before association mining activities can be performed. Transactional format is the usual format but, the Association Rules model does accept two-dimensional input format. For non transactional

input format, each distinct combination of the content in all columns other than the case ID column is treated as a unique item.

**Related Topics**

- *Oracle Data Mining User's Guide*
- [Data Preparation for Apriori](#)

## 7.3 Association Algorithm

Oracle Data Mining uses the Apriori algorithm to calculate association rules for items in frequent itemsets.



# 8

## Feature Selection and Extraction

Learn how to perform Feature Selection, Feature Extraction, and Attribute Importance.

Oracle Data Mining supports attribute importance as a supervised mining function and feature extraction as an unsupervised mining function.

- [Finding the Best Attributes](#)
- [About Feature Selection and Attribute Importance](#)
- [About Feature Extraction](#)

### Related Topics

- [Oracle Data Mining Basics](#)  
Understand the basic concepts of Oracle Data Mining.

### 8.1 Finding the Best Attributes

Sometimes too much information can reduce the effectiveness of data mining. Some of the columns of data attributes assembled for building and testing a model do not contribute meaningful information to the model. Some do actually detract from the quality and accuracy of the model.

For example, you want to collect a great deal of data about a given population because you want to predict the likelihood of a certain illness within this group. Some of this information, perhaps much of it, has little or no effect on susceptibility to the illness. It is possible that attributes such as the number of cars per household do not have effect whatsoever.

Irrelevant attributes add noise to the data and affect model accuracy. Noise increases the size of the model and the time and system resources needed for model building and scoring.

Data sets with many attributes can contain groups of attributes that are correlated. These attributes actually measure the same underlying feature. Their presence together in the build data can skew the logic of the algorithm and affect the accuracy of the model.

Wide data (many attributes) generally presents processing challenges for data mining algorithms. Model attributes are the dimensions of the processing space used by the algorithm. The higher the dimensionality of the processing space, the higher the computation cost involved in algorithmic processing.

To minimize the effects of noise, correlation, and high dimensionality, some form of dimension reduction is sometimes a desirable preprocessing step for data mining. Feature selection and extraction are two approaches to dimension reduction.

- **Feature selection:** Selecting the most relevant attributes
- **Feature extraction:** Combining attributes into a new reduced set of features

### 8.2 About Feature Selection and Attribute Importance

Finding the most significant predictors is the goal of some data mining projects. For example, a model might seek to find the principal characteristics of clients who pose a high credit risk.

Oracle Data Mining supports the **Attribute Importance** mining function, which ranks attributes according to their importance in predicting a target. Attribute importance does not actually perform feature selection since all the predictors are retained in the model. In true feature selection, the attributes that are ranked below a given threshold of importance are removed from the model.

Feature selection is useful as a preprocessing step to improve computational efficiency in predictive modeling. Oracle Data Mining implements feature selection for optimization within the Decision Tree algorithm and within Naive Bayes when Automatic Data Preparation (ADP) is enabled. Generalized Linear Model (GLM) can be configured to perform feature selection as a preprocessing step.

## 8.2.1 Attribute Importance and Scoring

Oracle Data Mining does not support the scoring operation for attribute importance. The results of attribute importance are the attributes of the build data ranked according to their predictive influence. The ranking and the measure of importance can be used in selecting training data for classification models.

## 8.3 About Feature Extraction

Feature Extraction is an attribute reduction process. Unlike feature selection, which selects and retains the most significant attributes, Feature Extraction actually transforms the attributes. The transformed attributes, or **features**, are linear combinations of the original attributes.

The Feature Extraction process results in a much smaller and richer set of attributes. The maximum number of features can be user-specified or determined by the algorithm. By default, the algorithm determines it.

Models built on extracted features can be of higher quality, because fewer and more meaningful attributes describe the data.

Feature Extraction projects a data set with higher dimensionality onto a smaller number of dimensions. As such it is useful for data visualization, since a complex data set can be effectively visualized when it is reduced to two or three dimensions.

Some applications of Feature Extraction are latent semantic analysis, data compression, data decomposition and projection, and pattern recognition. Feature Extraction can also be used to enhance the speed and effectiveness of supervised learning.

Feature Extraction can be used to extract the themes of a document collection, where documents are represented by a set of key words and their frequencies. Each theme (feature) is represented by a combination of keywords. The documents in the collection can then be expressed in terms of the discovered themes.

### 8.3.1 Feature Extraction and Scoring

Oracle Data Mining supports the scoring operation for feature extraction. As an unsupervised mining function, feature extraction does not involve a target. When applied, a feature extraction model transforms the input into a set of features.

## 8.4 Algorithms for Attribute Importance and Feature Extraction

Understand the algorithms used for Attribute Importance and Feature Extraction.

Oracle Data Mining supports the following algorithms for Attribute Importance:

- Minimum Description Length
- CUR matrix decomposition

Oracle Data Mining supports these feature extraction algorithms:

- **Explicit Semantic Analysis (ESA).**
- **Non-Negative Matrix Factorization (NMF).**
- **Singular Value Decomposition (SVD) and Prediction Component Analysis (PCA).**



**Note:**

Oracle Data Mining uses NMF as the default feature extraction algorithm.

**Related Topics**

- [CUR Matrix Decomposition](#)  
Learn how to use CUR decomposition based algorithm for attribute importance.
- [Explicit Semantic Analysis](#)  
Learn how to use Explicit Semantic Analysis (ESA) as an unsupervised algorithm for Feature Extraction function and as a supervised algorithm for Classification.
- [Minimum Description Length](#)  
Learn how to use Minimum Description Length, the supervised technique for calculating Attribute Importance.
- [Non-Negative Matrix Factorization](#)  
Learn how to use Non-Negative Matrix Factorization (NMF), the unsupervised algorithm, that the Oracle Data Mining uses for Feature Extraction.
- [Singular Value Decomposition](#)  
Learn how to use Singular Value Decomposition, an unsupervised algorithm for Feature Extraction.

# 9

## Time Series

Learn about Time Series as an Oracle Data Mining Regression function.

- [About Time Series](#)
- [Choosing a Time Series Model](#)
- [Time Series Statistics](#)
- [Time Series Algorithm](#)

### 9.1 About Time Series

Time Series is a new data mining function that forecasts target value based solely on a known history of target values. It is a specialized form of Regression, known in the literature as autoregressive modeling.

The input to time series analysis is a sequence of target values. A case id column specifies the order of the sequence. The case id can be of type `NUMBER` or a date type (date, datetime, timestamp with timezone, or timestamp with local timezone). Regardless of case id type, the user can request that the model include trend, seasonal effects or both in its forecast computation. When the case id is a date type, the user must specify a time interval (for example, month) over which the target values are to be aggregated, along with an aggregation procedure (for example, sum). Aggregation is performed by the algorithm prior to constructing the model.

The time series model provide estimates of the target value for each step of a time window that can include up to 30 steps beyond the historical data. Like other Regression models, Time Series models compute various statistics that measure the goodness of fit to historical data.

Forecasting is a critical component of business and governmental decision making. It has applications at the strategic, tactical and operation level. The following are the applications of forecasting:

- Projecting return on investment, including growth and the strategic effect of innovations
- Addressing tactical issues such as projecting costs, inventory requirements and customer satisfaction
- Setting operational targets and predicting quality and conformance with standards

#### Related Topics

- [Regression](#)  
Learn how to predict a continuous numerical target through Regression - the supervised mining function.

### 9.2 Choosing a Time Series Model

Learn how to select a Time Series model.

Time Series data may contain patterns that can affect predictive accuracy. For example, during a period of economic growth, there may be an upward trend in sales. Sales may increase in

specific seasons (bathing suits in summer). To accommodate such series, it can be useful to choose a model that incorporates trend, seasonal effects, or both.

**Trend** can be difficult to estimate, when you must represent trend by a single constant. For example, if there is a grow rate of 10%, then after 7 steps, the value doubles. Local growth rates, appropriate to a few time steps can easily approach such levels, but thereafter drop.

**Damped trend** models can more accurately represent such data, by reducing cumulative trend effects. Damped trend models can better represent variability in trend effects over the historical data. Damped trend models are a good choice when the data have significant, but variable trend.

Since modeling attempts to reduce error, how error is measured can affect model predictions. For example, data that exhibit a wide range of values may be better represented by error as fraction of level. An error of a few hundred feet in the measurement of the height of a mountain may be equivalent to an error of an inch or two in the measurement of the height of a child. Errors that are measured relative to value are called **multiplicative errors**. Errors that are the same across values are called **additive errors**. If there are multiplicative effects in the model, then the error type is multiplicative. If there are no explicit multiplicative effects, error type is left to user specification. The type need not be the same across individual effects. For example, trend can be additive while seasonality is multiplicative. This particular mixed type effect combination defines the popular Holt-Winters model.

 **Note:**

Multiplicative error is not an appropriate choice for data that contain zeros or negative values. Thus, when the data contains such values, it is best not to choose a model with multiplicative effects or to set error type to be multiplicative.

## 9.3 Time Series Statistics

Learn to evaluate model quality by applying commonly used statistics.

As with other Regression functions, there are commonly used statistics for evaluating the overall model quality. An expert user can also specify one of these figures of merit as criterion to optimize by the model build process. Choosing an optimization criterion is not required because model-specific defaults are available.

### 9.3.1 Conditional Log-Likelihood

Log-likelihood is a figure of merit often used as an optimization criterion for models that provide probability estimates for predictions which depend on the values of the model's parameters.

The model probability estimates for the actual values in the training data then yields an estimate of the likelihood of the parameter values. Parameter values that yield high probabilities for the observed target values have high likelihood, and therefore indicate a good model. The calculation of log-likelihood depends on the form of the model.

Conditional log-likelihood breaks the parameters into two groups. One group is assumed to be correct and the other is assumed the source of any errors. Conditional log-likelihood is the log-likelihood of the latter group conditioned on the former group. For example, Exponential Smoothing models (ESMs) make an estimate of the initial model state. The conditional log-likelihood of an ESM is conditional on that initial model state (assumed to be correct). The ESM conditional log-likelihood is as follows:

$$L^*(\theta, X_0) = n \ln \left( \sum_{t=1}^n e_t^2 / k^2(x_{t-1}) \right) + 2 \sum_{t=1}^n \ln |k(x_{t-1})|$$

where  $e_t$  is the error at time  $t$  and  $k(x_{t-1})$  is 1 for ESM models with additive errors and is the estimated level at the previous time step in models with multiplicative error.

### 9.3.2 Mean Square Error (MSE) and Other Error Measures

Another time series figure of merit, that can also be used as an optimization criterion, is Mean Square Error (MSE).

The mean square error is computed as:

$$MSE = \sum_{t=1}^n e_t^2 / n$$

where the error at time  $t$  is the difference between the actual and model one step ahead forecast value at time  $t$  for models with additive error and that difference divided by the one-step ahead forecast for models with multiplicative error.

#### Note:

These "forecasts" are for over periods already observed and part of the input time series.

Since time series models can forecast for each of multiple steps ahead, time series can measure the error associated with such forecasts. Average Mean Square Error (AMSE), another figure of merit, does exactly that. For each period in the input time series, it computes a multi-step forecast, computes the error of those forecasts and averages the errors. AMSE computes the individual errors exactly as MSE does taking cognizance of error type (additive or multiplicative). The number of steps,  $k$ , is determined by the user (default 3). The formula is as follows:

$$AMSE = \sum_{t=1}^n \left( \sum_{i=0}^{k-1} e_{t+i}^2 / k \right) / n$$

Other figure of merit relatives of MSE include the Residual Standard Error (RMSE), which is the square root of MSE, and the Mean Absolute Error (MAE) which is the average of the absolute value of the errors.

### 9.3.3 Irregular Time Series

Irregular time series are time series data where the time intervals between observed values are not equally spaced.

One common practice is for the time intervals between adjacent steps to be equally spaced. However, it is not always convenient or realistic to force such spacing on time series. Irregular time series do not make the assumption that time series are equally spaced, but instead use the case id's date and time values to compute the intervals between observed values. Models are constructed directly on the observed values with their observed spacing. Oracle time series analysis handles irregular time series.

### 9.3.4 Build Apply

Learn about build and apply operations of Time Series function.

Many of the Oracle Data Mining functions have separate build and apply operations, because you can construct and potentially apply a model to many different sets of input data. However, time series input consists of the target value history only. Thus, there is only one set of appropriate input data. When new data arrive, good practice dictates that a new model be built. Since the model is only intended to be used once, the model statistics and forecasts are produced during model build and are available through the model views.

## 9.4 Time Series Algorithm

Oracle Data Mining uses the algorithm Exponential Smoothing to forecast from time series data.

#### Related Topics

- [Exponential Smoothing](#)  
Learn about Exponential Smoothing.

# Part III

## Algorithms

Part III provides basic conceptual information about the algorithms supported by Oracle Data Mining. There is at least one algorithm for each of the mining functions.

Part III contains these chapters:

- [Apriori](#)
- [CUR Matrix Decomposition](#)
- [Decision Tree](#)
- [Expectation Maximization](#)
- [Explicit Semantic Analysis](#)
- [Exponential Smoothing](#)
- [Generalized Linear Models](#)
- [k-Means](#)
- [Minimum Description Length](#)
- [Naive Bayes](#)
- [Neural Network](#)
- [Non-Negative Matrix Factorization](#)
- [O-Cluster](#)
- [R Extensibility](#)
- [Random Forest](#)
- [Singular Value Decomposition](#)
- [Support Vector Machines](#)

### **Related Topics**

- [Mining Functions](#)  
Part II provides basic conceptual information about the mining functions that the Oracle Data Mining supports.



# 10

## Apriori

Learn how to calculate Association Rules using Apriori algorithm.

- [About Apriori](#)
- [Association Rules and Frequent Itemsets](#)
- [Data Preparation for Apriori](#)
- [Calculating Association Rules](#)
- [Evaluating Association Rules](#)

### Related Topics

- [Association](#)  
Learn how to discover Association Rules through Association - an unsupervised mining function.

## 10.1 About Apriori

Learn about Apriori.

An association mining problem can be decomposed into the following subproblems:

- Find all combinations of items in a set of transactions that occur with a specified minimum frequency. These combinations are called **frequent itemsets**.
- Calculate rules that express the probable co-occurrence of items within frequent itemsets.

Apriori calculates the probability of an item being present in a frequent itemset, given that another item or items is present.

Association rule mining is not recommended for finding associations involving rare events in problem domains with a large number of items. Apriori discovers patterns with frequencies above the minimum support threshold. Therefore, to find associations involving rare events, the algorithm must run with very low minimum support values. However, doing so potentially explodes the number of enumerated itemsets, especially in cases with a large number of items. This increases the execution time significantly. Classification or Anomaly Detection is more suitable for discovering rare events when the data has a high number of attributes.

The build process for Apriori supports parallel execution.

### Related Topics

- [Example: Calculating Rules from Frequent Itemsets](#)  
Example to calculating rules from Frequent itemsets.
- *Oracle Database VLDB and Partitioning Guide*

## 10.2 Association Rules and Frequent Itemsets

The Apriori algorithm calculates rules that express probabilistic relationships between items in frequent itemsets. For example, a rule derived from frequent itemsets containing A, B, and C might state that if A and B are included in a transaction, then C is likely to also be included.

An association rule states that an item or group of items implies the presence of another item with some probability. Unlike decision tree rules, which predict a target, association rules simply express correlation.

### 10.2.1 Antecedent and Consequent

The IF component of an association rule is known as the **antecedent**. The THEN component is known as the **consequent**. The antecedent and the consequent are disjoint; they have no items in common.

Oracle Data Mining supports association rules that have one or more items in the antecedent and a single item in the consequent.

### 10.2.2 Confidence

Rules have an associated confidence, which is the conditional probability that the consequent occurs given the occurrence of the antecedent. You can specify the minimum confidence for rules.

## 10.3 Data Preparation for Apriori

Association models are designed to use transactional data. In transactional data, there is a one-to-many relationship between the case identifier and the values for each case. Each case ID/value pair is specified in a separate record (row).

### 10.3.1 Native Transactional Data and Star Schemas

Learn about storage format of transactional data.

Transactional data may be stored in native transactional format, with a non-unique case ID column and a values column, or it may be stored in some other configuration, such as a star schema. If the data is not stored in native transactional format, it must be transformed to a nested column for processing by the Apriori algorithm.

#### Related Topics

- [Transactional Data](#)  
Learn about transactional data, also known as market-basket data.
- *Oracle Data Mining User's Guide*

### 10.3.2 Items and Collections

In transactional data, a collection of items is associated with each case. The collection theoretically includes all possible members of the collection. For example, all products can theoretically be purchased in a single market-basket transaction. However, in actuality, only a tiny subset of all possible items are present in a given transaction; the items in the market-basket represent only a small fraction of the items available for sale in the store.

## 10.3.3 Sparse Data

Learn about missing items through sparsity.

Missing items in a collection indicate **sparsity**. Missing items may be present with a null value, or they may simply be missing.

Nulls in transactional data are assumed to represent values that are known but not present in the transaction. For example, three items out of hundreds of possible items might be purchased in a single transaction. The items that were not purchased are known but not present in the transaction.

Oracle Data Mining assumes sparsity in transactional data. The Apriori algorithm is optimized for processing sparse data.



### Note:

Apriori is not affected by Automatic Data Preparation.

### Related Topics

- *Oracle Data Mining User's Guide*

## 10.3.4 Improved Sampling

Association Rules (AR) can use a good sample size with performance guarantee, based on the work of Riondato and Upfal.

The AR algorithm computes the sample size by the following inputs:

- $d$ -index of the dataset
- Absolute error  $\epsilon$
- Confidence level  $\gamma$

**$d$ -index** is defined as the maximum integer  $d$  such that the dataset contains at least  $d$  transactions of length  $d$  at the minimum. It is the upper bound of Vapnik-Chervonenkis (VC) dimension. The AR algorithm computes  $d$ -index of the dataset by scanning the length of all transactions in the dataset.

Users specify absolute error  $\epsilon$  and confidence level  $\gamma$  parameters. A large  $d$ -index, small AR support, small  $\epsilon$  or large  $\gamma$  can cause a large sample size. The sample size theoretically guarantees that the absolute error of both the support and confidence of the approximated AR (from sampling) is less than  $\epsilon$  compared to the exact AR with probability (or confidence level) at least  $\gamma$ . In this document this sample size is called AR-specific sample size.

### 10.3.4.1 Sampling Implementation

The sample size is only computed when users turn on the sampling (ODMS\_SAMPLING is set as ODMS\_SAMPLING\_ENABLE) and do not specify the sample size (ODMS\_SAMPLE\_SIZE is unspecified).

### Usage Notes

1. If `ODMS_SAMPLING` is unspecified or set as `ODMS_SAMPLING_DISABLE`, the sampling is not performed for AR and the exact AR is obtained.
2. If `ODMS_SAMPLING` is set as `ODMS_SAMPLING_ENABLE` and if `ODMS_SAMPLE_SIZE` is specified as positive integer number then the user-specified sample size (`ODMS_SAMPLE_SIZE`) is utilized. The sampling is performed in the general data preparation stage before the AR algorithm. The AR-specific sample size is not computed. The approximated AR is obtained.
3. If `ODMS_SAMPLING` is set as `ODMS_SAMPLING_ENABLE` and `ODMS_SAMPLE_SIZE` is not specified, the AR-specified sample size is computed and then sampling is performed in the AR algorithm. The approximated AR is obtained.

 **Note:**

If the computed AR-specific sample size is larger than or equal to the total transaction size in the dataset, the sampling is not performed and the exact AR is obtained.

If users do not have a good idea on the choice of sample size for AR, it is suggested to leave `ODMS_SAMPLE_SIZE` unspecified, only specify proper values for sampling parameters and let AR algorithm compute the suitable AR-specific sample size.

### Related Topics

- *Oracle Database PL/SQL Packages and Types Reference*

## 10.4 Calculating Association Rules

The first step in association analysis is the enumeration of **itemsets**. An itemset is any combination of two or more items in a transaction.

### 10.4.1 Itemsets

Learn about itemsets.

The maximum number of items in an itemset is user-specified. If the maximum is two, then all the item pairs are counted. If the maximum is greater than two, then all the item pairs, all the item triples, and all the item combinations up to the specified maximum are counted.

The following table shows the itemsets derived from the transactions shown in the following example, assuming that maximum number of items in an itemset is set to 3.

**Table 10-1** Itemsets

Transaction	Itemsets
11	(B,D) (B,E) (D,E) (B,D,E)
12	(A,B) (A,C) (A,E) (B,C) (B,E) (C,E) (A,B,C) (A,B,E) (A,C,E) (B,C,E)
13	(B,C) (B,D) (B,E) (C,D) (C,E) (D,E) (B,C,D) (B,C,E) (B,D,E) (C,D,E)

**Example 10-1 Sample Transactional Data**

TRANS_ID	ITEM_ID
11	B
11	D
11	E
12	A
12	B
12	C
12	E
13	B
13	C
13	D
13	E

## 10.4.2 Frequent Itemsets

Learn about Frequent Itemsets and Support.

Association rules are calculated from itemsets. If rules are generated from all possible itemsets, there can be a very high number of rules and the rules may not be very meaningful. Also, the model can take a long time to build. Typically it is desirable to only generate rules from itemsets that are well-represented in the data. **Frequent itemsets** are those that occur with a minimum frequency specified by the user.

The minimum frequent itemset **Support** is a user-specified percentage that limits the number of itemsets used for association rules. An itemset must appear in at least this percentage of all the transactions if it is to be used as a basis for rules.

The following table shows the itemsets from [Table 10-1](#) that are frequent itemsets with support > 66%.

**Table 10-2 Frequent Itemsets**

Frequent Itemset	Transactions	Support
(B,C)	2 of 3	67%
(B,D)	2 of 3	67%
(B,E)	3 of 3	100%
(C,E)	2 of 3	67%
(D,E)	2 of 3	67%
(B,C,E)	2 of 3	67%
(B,D,E)	2 of 3	67%

**Related Topics**

- [Apriori](#)  
Learn how to calculate Association Rules using Apriori algorithm.

## 10.4.3 Example: Calculating Rules from Frequent Itemsets

Example to calculating rules from Frequent itemsets.

The following tables show the itemsets and frequent itemsets that were calculated in "Association". The frequent itemsets are the itemsets that occur with a minimum support of 67%; at least 2 of the 3 transactions must include the itemset.

**Table 10-3 Itemsets**

Transaction	Itemsets
11	(B,D) (B,E) (D,E) (B,D,E)
12	(A,B) (A,C) (A,E) (B,C) (B,E) (C,E) (A,B,C) (A,B,E) (A,C,E) (B,C,E)
13	(B,C) (B,D) (B,E) (C,D) (C,E) (D,E) (B,C,D) (B,C,E) (B,D,E) (C,D,E)

**Table 10-4 Frequent Itemsets with Minimum Support 67%**

Itemset	Transactions	Support
(B,C)	12 and 13	67%
(B,D)	11 and 13	67%
(B,E)	11, 12, and 13	100%
(C,E)	12 and 13	67%
(D,E)	11 and 13	67%
(B,C,E)	12 and 13	67%
(B,D,E)	11 and 13	67%

A rule expresses a conditional probability. Confidence in a rule is calculated by dividing the probability of the items occurring together by the probability of the occurrence of the antecedent.

For example, if B (antecedent) is present, what is the chance that C (consequent) is also present? What is the confidence for the rule "IF B, THEN C"?

As shown in [Table 10-3](#):

- All 3 transactions include B (3/3 or 100%)
- Only 2 transactions include both B and C (2/3 or 67%)
- Therefore, the confidence of the rule "IF B, THEN C" is 67/100 or 67%.

The following table the rules that can be derived from the frequent itemsets in [Table 10-4](#).

**Table 10-5 Frequent Itemsets and Rules**

Frequent Itemset	Rules	$\frac{\text{prob}(\text{antecedent and consequent})}{\text{prob}(\text{antecedent})}$	Confidence
(B,C)	(If B then C)	67/100	67%
	(If C then B)	67/67	100%
(B,D)	(If B then D)	67/100	67%
	(If D then B)	67/67	100%
(B,E)	(If B then E)	100/100	100%
	(If E then B)	100/100	100%
(C,E)	(If C then E)	67/67	100%
	(If E then C)	67/100	67%

**Table 10-5 (Cont.) Frequent Itemsets and Rules**

Frequent Itemset	Rules	prob(antecedent and consequent) / prob(antecedent)	Confidence
(D,E)	(If D then E)	67/67	100%
	(If E then D)	67/100	67%
(B,C,E)	(If B and C then E)	67/67	100%
	(If B and E then C)	67/100	67%
	(If C and E then B)	67/67	100%
(B,D,E)	(If B and D then E)	67/67	100%
	(If B and E then D)	67/100	67%
	(If D and E then B)	67/67	100%

If the minimum confidence is 70%, ten rules are generated for these frequent itemsets. If the minimum confidence is 60%, sixteen rules are generated.



**Tip:**

Increase the minimum confidence if you want to decrease the build time for the model and generate fewer rules.

**Related Topics**

- [Association](#)  
Learn how to discover Association Rules through Association - an unsupervised mining function.

## 10.4.4 Aggregates

Aggregates refer to the quantities associated with each item that the user opts for Association Rules Model to aggregate.

There can be more than one aggregate. For example, the user can specify the model to aggregate both profit and quantity.

## 10.4.5 Example: Calculating Aggregates

The following example shows the concept of Aggregates.

**Calculating Aggregates for Grocery Store Data**

Assume a grocery store has the following data:

**Table 10-6 Grocery Store Data**

Customer	Item A	Item B	Item C	Item D
Customer 1	Buys (Profit \$5.00)	Buys (Profit \$3.20)	Buys (Profit \$12.00)	NA
Customer 2	Buys (Profit \$4.00)	NA	Buys (Profit \$4.20)	NA

**Table 10-6 (Cont.) Grocery Store Data**

Customer	Item A	Item B	Item C	Item D
Customer 3	Buys (Profit \$3.00)	Buys (Profit \$10.00)	Buys (Profit \$14.00)	Buys (Profit \$8.00)
Customer 4	Buys (Profit \$2.00)	NA	NA	Buys (Profit \$1.00)

The basket of each customer can be viewed as a transaction. The manager of the store is interested in not only the existence of certain association rules, but also in the aggregated profit if such rules exist.

In this example, one of the association rules can be  $(A, B) \Rightarrow C$  for customer 1 and customer 3. Together with this rule, the store manager may want to know the following:

- The total profit of item A appearing in this rule
- The total profit of item B appearing in this rule
- The total profit for consequent C appearing in this rule
- The total profit of all items appearing in the rule

For this rule, the profit for item A is  $\$5.00 + \$3.00 = \$8.00$ , for item B the profit is  $\$3.20 + \$10.00 = \$13.20$ , for consequent C, the profit is  $\$12.00 + \$14.00 = \$26.00$ , for the antecedent itemset (A, B) is  $\$8.00 + \$13.20 = \$21.20$ . For the whole rule, the profit is  $\$21.20 + \$26.00 = \$47.40$ .

**Related Topics**

- *Oracle Database PL/SQL Packages and Types Reference*

## 10.4.6 Including and Excluding Rules

Explains including rules and excluding rules used in Association.

Including rules enables a user to provide a list of items such that at least one item from the list must appear in the rules that are returned. Excluding rules enables a user to provide a list of items such that no item from the list can appear in the rules that are returned.

**Note:**

Since each association rule includes both antecedent and consequent, a set of including or excluding rules can be specified for antecedent while another set of including or excluding rules can be specified for consequent. Including or excluding rules can also be defined for the association rule.

**Related Topics**

- *Oracle Data Mining User's Guide*
- *Oracle Database PL/SQL Packages and Types Reference*

## 10.4.7 Performance Impact for Aggregates

Aggregate function requires more memory usage and longer execution time.



For each item, the user may supply several columns to aggregate. It requires more memory to buffer the extra data and more time to compute the aggregate values.

## 10.5 Evaluating Association Rules

Minimum support and confidence are used to influence the build of an association model. Support and confidence are also the primary metrics for evaluating the quality of the rules generated by the model. Additionally, Oracle Data Mining supports lift for association rules. These statistical measures can be used to rank the rules and hence the usefulness of the predictions.

### 10.5.1 Support

The support of a rule indicates how frequently the items in the rule occur together. For example, cereal and milk might appear together in 40% of the transactions. If so, the following rules each have a support of 40%:

```
cereal implies milk  
milk implies cereal
```

Support is the ratio of transactions that include all the items in the antecedent and consequent to the number of total transactions.

Support can be expressed in probability notation as follows:

```
support(A implies B) = P(A, B)
```

### 10.5.2 Minimum Support Count

Minimum support Count defines minimum threshold in transactions that each rule must satisfy.

When the number of transactions is unknown, the support percentage threshold parameter can be tricky to set appropriately. For this reason, support can also be expressed as a count of transactions, with the greater of the two thresholds being used to filter out infrequent itemsets. The default is 1 indicating that this criterion is not applied.

#### Related Topics

- [Association Rules](#)
- *Oracle Data Mining User's Guide*
- [Frequent Itemsets](#)  
Learn about Frequent Itemsets and Support.

### 10.5.3 Confidence

The confidence of a rule indicates the probability of both the antecedent and the consequent appearing in the same transaction.

Confidence is the conditional probability of the consequent given the antecedent. For example, cereal appears in 50 transactions; 40 of the 50 might also include milk. The rule confidence is:

```
cereal implies milk with 80% confidence
```

Confidence is the ratio of the rule support to the number of transactions that include the antecedent.

Confidence can be expressed in probability notation as follows.

confidence (A implies B) = P (B/A), which is equal to P(A, B) / P(A)

#### Related Topics

- [Confidence](#)
- [Frequent Itemsets](#)  
Learn about Frequent Itemsets and Support.

## 10.5.4 Reverse Confidence

The Reverse Confidence of a rule is defined as the number of transactions in which the rule occurs divided by the number of transactions in which the consequent occurs.

Reverse Confidence eliminates rules that occur because the consequent is frequent. The default is 0.

#### Related Topics

- [Confidence](#)
- [Example: Calculating Rules from Frequent Itemsets](#)  
Example to calculating rules from Frequent itemsets.
- *Oracle Data Mining User's Guide*
- *Oracle Database PL/SQL Packages and Types Reference*

## 10.5.5 Lift

Both support and confidence must be used to determine if a rule is valid. However, there are times when both of these measures may be high, and yet still produce a rule that is not useful. For example:

Convenience store customers who buy orange juice also buy milk with a 75% confidence.

The combination of milk and orange juice has a support of 30%.

This at first sounds like an excellent rule, and in most cases, it would be. It has high confidence and high support. However, what if convenience store customers in general buy milk 90% of the time? In that case, orange juice customers are actually *less* likely to buy milk than customers in general.

A third measure is needed to evaluate the quality of the rule. Lift indicates the strength of a rule over the random co-occurrence of the antecedent and the consequent, given their individual support. It provides information about the improvement, the increase in probability of the consequent given the antecedent. Lift is defined as follows.

$$(\text{Rule Support}) / (\text{Support}(\text{Antecedent}) * \text{Support}(\text{Consequent}))$$

This can also be defined as the confidence of the combination of items divided by the support of the consequent. So in our milk example, assuming that 40% of the customers buy orange juice, the improvement would be:

$$30\% / (40\% * 90\%)$$

which is 0.83 – an improvement of less than 1.

Any rule with an improvement of less than 1 does not indicate a real cross-selling opportunity, no matter how high its support and confidence, because it actually offers less ability to predict a purchase than does random chance.

 **Tip:**

Decrease the maximum rule length if you want to decrease the build time for the model and generate simpler rules.

 **Tip:**

Increase the minimum support if you want to decrease the build time for the model and generate fewer rules.

# 11

## CUR Matrix Decomposition

Learn how to use CUR decomposition based algorithm for attribute importance.

- [About CUR Matrix Decomposition](#)
- [Singular Vectors](#)
- [Statistical Leverage Score](#)
- [Column \(Attribute\) Selection and Row Selection](#)
- [CUR Matrix Decomposition Algorithm Configuration](#)

### 11.1 About CUR Matrix Decomposition

CUR matrix decomposition is a low-rank matrix decomposition algorithm that is explicitly expressed in a small number of actual columns and/or actual rows of data matrix.

CUR matrix decomposition was developed as an alternative to Singular Value Decomposition (SVD) and Principal Component Analysis (PCA). CUR matrix decomposition selects columns and rows that exhibit high **statistical leverage** or large **influence** from the data matrix. By implementing the CUR matrix decomposition algorithm, a small number of most important attributes and/or rows can be identified from the original data matrix. Therefore, CUR matrix decomposition is an important tool for exploratory data analysis. CUR matrix decomposition can be applied to a variety of areas and facilitates Regression, Classification, and Clustering.

#### Related Topics

- [Data Preparation for SVD](#)  
Learn about preparing the data for Singular Value Decomposition (SVD).

### 11.2 Singular Vectors

Singular Value Decomposition (SVD) is the first step in CUR matrix decomposition.

SVD returns left and right singular vectors for calculating column and row leverage scores. Perform SVD on the following matrix:

$$A \in \mathbf{R}^{m \times n}$$

The matrix is factorized as follows:

$$A = U \Sigma V^T$$

where  $U = [u^1 \ u^2 \ \dots \ u^m]$  and  $V = [v^1 \ v^2 \ \dots \ v^n]$  are orthogonal matrices.

$\Sigma$  is a diagonal  $m \times n$  matrix with non-negative real numbers  $\sigma_1, \dots, \sigma_p$  on the diagonal, where  $p = \min\{m, n\}$  and  $\sigma_\xi$  is the  $\xi^{\text{th}}$  singular value of  $A$ .

Let  $u^\xi$  and  $v^\xi$  be the  $\xi^{\text{th}}$  left and right singular vector of  $A$ , the  $j^{\text{th}}$  column of  $A$  can thus be approximated by the top  $k$  singular vectors and corresponding singular values as:

$$A^j \approx \sum_{\xi=1}^k (\sigma_{\xi} u_{\xi}^j) v_j^{\xi}$$

where  $v_j^{\xi}$  is the  $j^{\text{th}}$  coordinate of the  $\xi^{\text{th}}$  right singular vector.

## 11.3 Statistical Leverage Score

The statistical leverage scores represent the column (or attribute) and row importance.

The normalized statistical leverage scores for all columns are computed from the top  $k$  right singular vectors as follows:

$$\pi_j = \frac{1}{k} \sum_{\xi=1}^k (v_j^{\xi})^2$$

where  $k$  is called rank parameter and  $j = 1, \dots, n$ . Given that  $\pi_j \geq 0$  and

$$\sum_{j=1}^n \pi_j = 1$$

, these scores form a probability distribution over the  $n$  columns.

Similarly, the normalized statistical leverage scores for all rows are computed from the top  $k$  left singular vectors as:

$$\pi'_i = \frac{1}{k} \sum_{\xi=1}^k (u_i^{\xi})^2$$

where  $i = 1, \dots, m$ .

## 11.4 Column (Attribute) Selection and Row Selection

Column (Attribute) selection and Row selection is the final stage in CUR matrix decomposition.

Attribute selection: Selects attributes with high leverage scores and reports their names, scores (as importance) and ranks (by importance).

Row selection: Selects rows with high leverage scores and reports their names, scores (as importance) and ranks (by importance).

1. CUR matrix decomposition first selects the  $j^{\text{th}}$  column (or attribute) of  $A$  with probability  $p_j = \min \{1, c\pi_j\}$  for all  $j \in \{1, \dots, n\}$
2. If users enable row selection, select  $i^{\text{th}}$  row of  $A$  with probability  $p'_i = \min \{1, r\pi'_i\}$  for all  $i \in \{1, \dots, m\}$

- Report the name (or ID) and leverage score (as importance) for all selected attributes (if row importance is disabled) or for all selected attributes and rows (if row importance is enabled).

$c$  is the approximated (or expected) number of columns that users want to select, and  $r$  is the approximated (or expected) number of rows that users want to select.

To realize column and row selections, you need to calculate the probability to select each column and row.

Calculate the probability for each column as follows:

$$p_j = \min\{1, c\pi_j\}$$

Calculate the probability for each row as follows:

$$p'_i = \min\{1, c\pi'_i\}.$$

A column or row is selected if the probability is greater than some threshold.

## 11.5 CUR Matrix Decomposition Algorithm Configuration

Learn about configuring CUR Matrix Decomposition algorithm.

### Example 11-1 Example

In this example you will understand how to build a CUR Matrix Decomposition algorithm. When the settings table is created and populated with CUR Matrix Decomposition related settings, insert a row in the settings table to specify the algorithm.

```
INSERT INTO SETTINGS_TABLE (setting_name, setting_value) VALUES
('ALGO_NAME', 'ALGO_CUR_DECOMPOSITION');
```

Build the model as follows:

```
BEGIN
DBMS_DATA_MINING.CREATE_MODEL(
model_name           => 'model-name',
mining_function      => dbms_data_mining.attribute_importance,
data_table_name     => 'test_table',
case_id_column_name => 'id',
settings_table_name => 'settings_table');
END;
/
```

### Row Selection

To use this feature, insert a row in the settings table to specify that the row importance is enabled:

```
INSERT INTO SETTINGS_TABLE (setting_name, setting_value) VALUES
('CURS_ROW_IMPORTANCE', 'CURS_ROW_IMP_ENABLE');
```



**Note:**

The row selection is performed only when users specify that row importance is enabled and the `CASE_ID` column is present.

**Related Topics**

- *Oracle Database PL/SQL Packages and Types Reference*

# 12

## Decision Tree

Learn how to use Decision Tree algorithm. Decision Tree is one of the Classification algorithms that the Oracle Data Mining supports.

- [About Decision Tree](#)
- [Growing a Decision Tree](#)
- [Tuning the Decision Tree Algorithm](#)
- [Data Preparation for Decision Tree](#)

### Related Topics

- [Classification](#)  
Learn how to predict a categorical target through Classification - the supervised mining function.

## 12.1 About Decision Tree

The Decision Tree algorithm, like Naive Bayes, is based on conditional probabilities. Unlike Naive Bayes, decision trees generate **rules**. A rule is a conditional statement that can be understood by humans and used within a database to identify a set of records.

In some applications of data mining, the reason for predicting one outcome or another may not be important in evaluating the overall quality of a model. In others, the ability to explain the reason for a decision can be crucial. For example, a Marketing professional requires complete descriptions of customer segments to launch a successful marketing campaign. The Decision Tree algorithm is ideal for this type of application.

Use Decision Tree rules to validate models. If the rules make sense to a subject matter expert, then this validates the model.

### 12.1.1 Decision Tree Rules

Introduces Decision Tree rules.

Oracle Data Mining supports several algorithms that provide rules. In addition to decision trees, clustering algorithms provide rules that describe the conditions shared by the members of a cluster, and association rules provide rules that describe associations between attributes.

Rules provide **model transparency**, a window on the inner workings of the model. Rules show the basis for the model's predictions. Oracle Data Mining supports a high level of model transparency. While some algorithms provide rules, *all* algorithms provide **model details**. You can examine model details to determine how the algorithm handles the attributes internally, including transformations and reverse transformations. Transparency is discussed in the context of data preparation and in the context of model building in *Oracle Data Mining User's Guide*.

The following figure shows a rule generated by a Decision Tree model. This rule comes from a decision tree that predicts the probability that customers increase spending if given a loyalty



card. A target value of 0 means not likely to increase spending; 1 means likely to increase spending.

**Figure 12-1 Sample Decision Tree Rule**

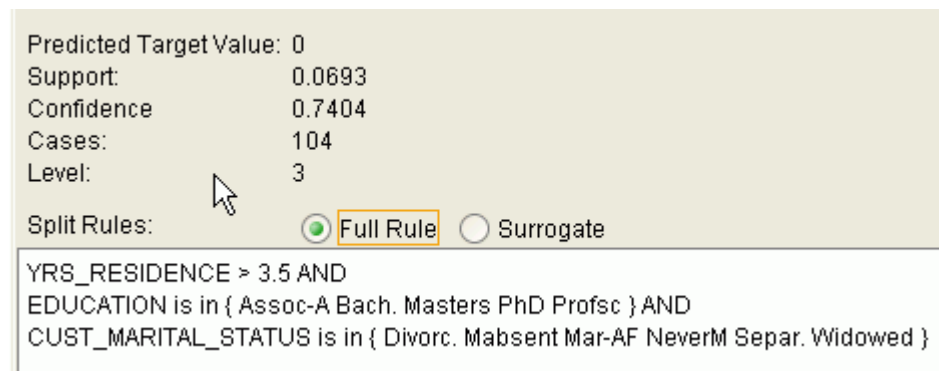

The rule shown in the figure represents the conditional statement:

```
IF
    (current residence > 3.5 and has college degree and is single)
THEN
    predicted target value = 0
```

This rule is a full rule. A surrogate rule is a related attribute that can be used at apply time if the attribute needed for the split is missing.

### Related Topics

- Understanding Reverse Transformations
- Model Detail Views for Decision Tree
- [Clustering](#)  
Learn how to discover natural groupings in the data through Clustering - the unsupervised mining function.
- [Association](#)  
Learn how to discover Association Rules through Association - an unsupervised mining function.

## 12.1.1.1 Confidence and Support

Confidence and support are properties of rules. These statistical measures can be used to rank the rules and hence the predictions.

**Support:** The number of records in the training data set that satisfy the rule.

**Confidence:** The likelihood of the predicted outcome, given that the rule has been satisfied.

For example, consider a list of 1000 customers (1000 cases). Out of all the customers, 100 satisfy a given rule. Of these 100, 75 are likely to increase spending, and 25 are not likely to increase spending. The **support of the rule** is 100/1000 (10%). The **confidence of the prediction** (likely to increase spending) for the cases that satisfy the rule is 75/100 (75%).

## 12.1.2 Advantages of Decision Trees

Learn about the advantages of Decision Tree.

The Decision Tree algorithm produces accurate and interpretable models with relatively little user intervention. The algorithm can be used for both binary and multiclass classification problems.

The algorithm is fast, both at build time and apply time. The build process for Decision Tree supports parallel execution. (Scoring supports parallel execution irrespective of the algorithm.)

Decision Tree scoring is especially fast. The tree structure, created in the model build, is used for a series of simple tests, (typically 2-7). Each test is based on a single predictor. It is a membership test: either IN or NOT IN a list of values (categorical predictor); or LESS THAN or EQUAL TO some value (numeric predictor).

**Related Topics**

- *Oracle Database VLDB and Partitioning Guide*

## 12.1.3 XML for Decision Tree Models

Learn about generating XML representation of Decision Tree models.

You can generate XML representing a Decision Tree model; the generated XML satisfies the definition specified in the Data Mining Group Predictive Model Markup Language (PMML) version 2.1 specification.

**Related Topics**

- <http://www.dmg.org>

## 12.2 Growing a Decision Tree

Predicting a target value by a sequence of questions to form or grow a Decision Tree.

A Decision Tree predicts a target value by asking a sequence of questions. At a given stage in the sequence, the question that is asked depends upon the answers to the previous questions. The goal is to ask questions that, taken together, uniquely identify specific target values. Graphically, this process forms a tree structure.

Figure 12-2 Sample Decision Tree

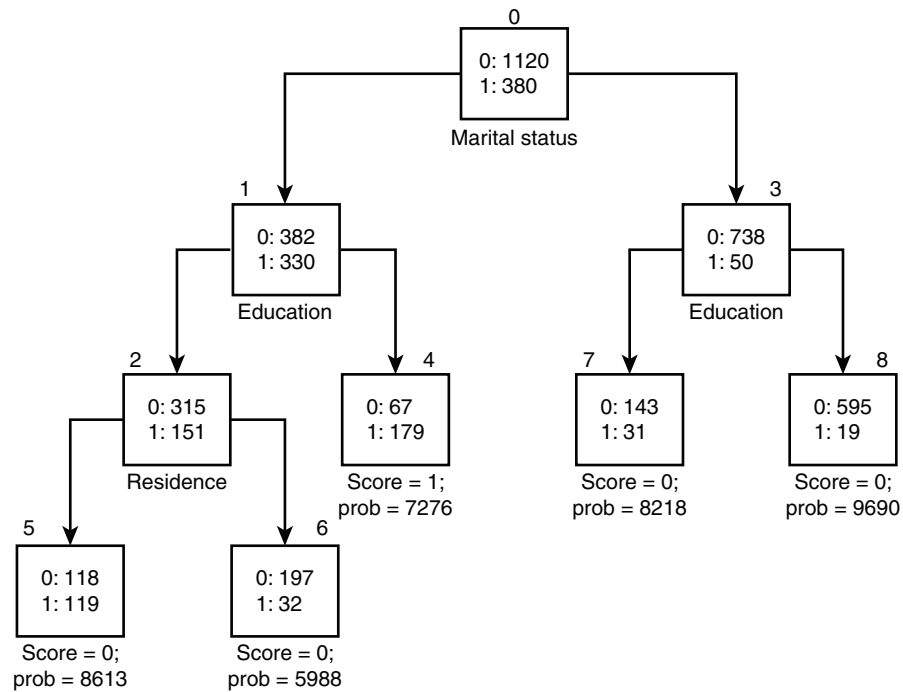

The figure is a Decision Tree with nine nodes (and nine corresponding rules). The target attribute is binary: 1 if the customer increases spending, 0 if the customer does not increase spending. The first split in the tree is based on the `CUST_MARITAL_STATUS` attribute. The root of the tree (node 0) is split into nodes 1 and 3. Married customers are in node 1; single customers are in node 3.

The rule associated with node 1 is:

```

Node 1 recordCount=712,0 Count=382, 1 Count=330
CUST_MARITAL_STATUS isIN "Married",surrogate:HOUSEHOLD_SIZE isIn "3"4-5"
  
```

Node 1 has 712 records (cases). In all 712 cases, the `CUST_MARITAL_STATUS` attribute indicates that the customer is married. Of these, 382 have a target of 0 (not likely to increase spending), and 330 have a target of 1 (likely to increase spending).

## 12.2.1 Splitting

During the training process, the Decision Tree algorithm must repeatedly find the most efficient way to split a set of cases (records) into two child nodes. Oracle Data Mining offers two homogeneity metrics, **gini** and **entropy**, for calculating the splits. The default metric is gini.

Homogeneity metrics assesses the quality of alternative split conditions and select the one that results in the most homogeneous child nodes. Homogeneity is also called **purity**; it refers to the degree to which the resulting child nodes are made up of cases with the same target value. The objective is to maximize the purity in the child nodes. For example, if the target can be either yes or no (does or does not increase spending), the objective is to produce nodes where most of the cases either increase spending or most of the cases do not increase spending.

## 12.2.2 Cost Matrix

Learn about Cost Matrix for Decision Tree.

All classification algorithms, including Decision Tree, support a cost-benefit matrix at apply time. You can use the same cost matrix for building and scoring a Decision Tree model, or you can specify a different cost/benefit matrix for scoring.

### Related Topics

- [Costs](#)
- [Priors and Class Weights](#)  
Learn about Priors and Class Weights in a Classification model to produce a useful result.

## 12.2.3 Preventing Over-Fitting

In principle, Decision Tree algorithms can grow each branch of the tree just deeply enough to perfectly classify the training examples. While this is sometimes a reasonable strategy, in fact it can lead to difficulties when there is noise in the data, or when the number of training examples is too small to produce a representative sample of the true target function. In either of these cases, this simple algorithm can produce trees that over-fit the training examples. Over-fit is a condition where a model is able to accurately predict the data used to create the model, but does poorly on new data presented to it.

To prevent over-fitting, Oracle Data Mining supports automatic **pruning** and configurable **limit conditions** that control tree growth. Limit conditions prevent further splits once the conditions have been satisfied. Pruning removes branches that have insignificant predictive power.

## 12.3 Tuning the Decision Tree Algorithm

Fine tune the Decision Tree algorithm with various parameters.

The Decision Tree algorithm is implemented with reasonable defaults for splitting and termination criteria. However several build settings are available for fine tuning.

You can specify a homogeneity metric for finding the optimal split condition for a tree. The default metric is gini. The entropy metric is also available.

Settings for controlling the growth of the tree are also available. You can specify the maximum depth of the tree, the minimum number of cases required in a child node, the minimum number of cases required in a node in order for a further split to be possible, the minimum number of cases in a child node, and the minimum number of cases required in a node in order for a further split to be possible.

The training data attributes are binned as part of the algorithm's data preparation. You can alter the number of bins used by the binning step. There is a trade-off between the number of bins used and the time required for the build.

### Related Topics

- *Oracle Database PL/SQL Packages and Types Reference*

## 12.4 Data Preparation for Decision Tree

Learn how to prepare data for Decision Tree.

The Decision Tree algorithm manages its own data preparation internally. It does not require pretreatment of the data. Decision Tree is not affected by Automatic Data Preparation.

**Related Topics**

- [Preparing the Data](#)
- [Transforming the Data](#)

# 13

## Expectation Maximization

Learn how to use Expectation Maximization Clustering algorithm.

- [About Expectation Maximization](#)
- [Algorithm Enhancements](#)
- [Configuring the Algorithm](#)
- [Data Preparation for Expectation Maximization](#)

### Related Topics

- [Clustering](#)  
Learn how to discover natural groupings in the data through Clustering - the unsupervised mining function.

### 13.1 About Expectation Maximization

Expectation Maximization (EM) estimation of mixture models is a popular probability density estimation technique that is used in a variety of applications. Oracle Data Mining uses EM to implement a distribution-based clustering algorithm (EM-clustering).

#### 13.1.1 Expectation Step and Maximization Step

Expectation Maximization is an iterative method. It starts with an initial parameter guess. The parameter values are used to compute the likelihood of the current model. This is the Expectation step. The parameter values are then recomputed to maximize the likelihood. This is the Maximization step. The new parameter estimates are used to compute a new expectation and then they are optimized again to maximize the likelihood. This iterative process continues until model convergence.

#### 13.1.2 Probability Density Estimation

In density estimation, the goal is to construct a density function that captures how a given population is distributed. In probability density estimation, the density estimate is based on observed data that represents a sample of the population. Areas of high data density in the model correspond to the peaks of the underlying distribution.

Density-based clustering is conceptually different from distance-based clustering (for example *k*-Means) where emphasis is placed on minimizing inter-cluster and maximizing the intra-cluster distances. Due to its probabilistic nature, density-based clustering can compute reliable probabilities in cluster assignment. It can also handle missing values automatically.

### 13.2 Algorithm Enhancements

Although Expectation Maximization (EM) is well established as a distribution-based clustering algorithm, it presents some challenges in its standard form. The Oracle Data Mining

implementation includes significant enhancements, such as scalable processing of large volumes of data and automatic parameter initialization. The strategies that Oracle Data Mining uses to address the inherent limitations of EM clustering are described further in this section.

**Note:**

The EM abbreviation is used here to refer to EM-clustering.

**Limitations of Standard Expectation Maximization:**

- **Scalability:** EM has linear scalability with the number of records and attributes. The number of iterations to convergence tends to increase with growing data size (both rows and columns). EM convergence can be slow for complex problems and can place a significant load on computational resources.
- **High dimensionality:** EM has limited capacity for modeling high dimensional (wide) data. The presence of many attributes slows down model convergence, and the algorithm becomes less able to distinguish between meaningful attributes and noise. The algorithm is thus compromised in its ability to find correlations.
- **Number of components:** EM typically requires the user to specify the number of components. In most cases, this is not information that the user can know in advance.
- **Parameter initialization:** The choice of appropriate initial parameter values can have a significant effect on the quality of the model. Initialization strategies that have been used for EM have generally been computationally expensive.
- **From components to clusters:** EM model components are often treated as clusters. This approach can be misleading since cohesive clusters are often modeled by multiple components. Clusters that have a complex shape need to be modeled by multiple components.

## 13.2.1 Scalability

Expectation Maximization (EM) in Oracle Data Mining, uses database parallel processing to achieve excellent scalability.

The Oracle Data Mining implementation of Expectation Maximization (EM) uses database parallel processing to achieve excellent scalability. EM computations naturally lend themselves to row parallel processing, and the partial results are easily aggregated. The parallel implementation efficiently distributes the computationally intensive work across slave processes and then combines the partial results to produce the final solution.

**Related Topics**

- *Oracle Database VLDB and Partitioning Guide*

## 13.2.2 High Dimensionality

The Oracle Data Mining implementation of Expectation Maximization (EM) can efficiently process high-dimensional data with thousands of attributes. This is achieved through a two-fold process:

- The data space of single-column (not nested) attributes is analyzed for pair-wise correlations. Only attributes that are significantly correlated with other attributes are included in the EM mixture model. The algorithm can also be configured to restrict the dimensionality to the  $M$  most correlated attributes.

- High-dimensional (nested) numerical data that measures events of similar type is projected into a set of low-dimensional features that are modeled by EM. Some examples of high-dimensional, numerical data are: text, recommendations, gene expressions, and market basket data.

### 13.2.3 Number of Components

Typical implementations of Expectation Maximization (EM) require the user to specify the number of model components. This is problematic because users do not generally know the correct number of components. Choosing too many or too few components can lead to over-fitting or under-fitting, respectively.

When model search is enabled, the number of EM components is automatically determined. The algorithm uses a held-aside sample to determine the correct number of components, except in the cases of very small data sets when Bayesian Information Criterion (BIC) regularization is used.

### 13.2.4 Parameter Initialization

Choosing appropriate initial parameter values can have a significant effect on the quality of the solution. Expectation Maximization (EM) is not guaranteed to converge to the global maximum of the likelihood function but may instead converge to a local maximum. Therefore different initial parameter values can lead to different model parameters and different model quality.

In the process of model search, the EM model is grown independently. As new components are added, their parameters are initialized to areas with poor distribution fit.

### 13.2.5 From Components to Clusters

Expectation Maximization (EM) model components are often treated as clusters. However, this approach can be misleading. Cohesive clusters are often modeled by multiple components. The shape of the probability density function used in EM effectively predetermines the shape of the identified clusters. For example, Gaussian density functions can identify single peak symmetric clusters. Clusters of more complex shape need to be modeled by multiple components.

Ideally, high density areas of arbitrary shape must be interpreted as single clusters. To accomplish this, the Oracle Data Mining implementation of EM builds a component hierarchy that is based on the overlap of the individual components' distributions. Oracle Data Mining EM uses agglomerative hierarchical clustering. Component distribution overlap is measured using the Bhattacharyya distance function. Choosing an appropriate cutoff level in the hierarchy automatically determines the number of high-level clusters.

The Oracle Data Mining implementation of EM produces an assignment of the model components to high-level clusters. Statistics like means, variances, modes, histograms, and rules additionally describe the high-level clusters. The algorithm can be configured to either produce clustering assignments at the component level or at the cluster level.

## 13.3 Configuring the Algorithm

Configure Expectation Maximization (EM).

In Oracle Data Mining, Expectation Maximization (EM) can effectively model very large data sets (both rows and columns) without requiring the user to supply initialization parameters or specify the number of model components. While the algorithm offers reasonable defaults, it also offers flexibility.



The following list describes some of the configurable aspects of EM:

- Whether or not independent non-nested column attributes are included in the model. The choice is system-determined by default.
- Whether to use Bernoulli or Gaussian distribution for numerical attributes. By default, the algorithm chooses the most appropriate distribution, and individual attributes may use different distributions. When the distribution is user-specified, it is used for all numerical attributes.
- Whether the convergence criterion is based on a held-aside data set or on Bayesian Information Criterion (BIC). The convergence criterion is system-determined by default.
- The percentage improvement in the value of the log likelihood function that is required to add a new component to the model. The default percentage is 0.001.
- Whether to define clusters as individual components or groups of components. Clusters are associated to groups of components by default.
- The maximum number of components in the model. If model search is enabled, the algorithm determines the number of components based on improvements in the likelihood function or based on regularization (BIC), up to the specified maximum.
- Whether the linkage function for the agglomerative clustering step uses the nearest distance within the branch (single linkage), the average distance within the branch (average linkage), or the maximum distance within the branch (complete linkage). By default the algorithm uses single linkage.

#### Related Topics

- [DBMS\\_DATA\\_MINING - Global Settings](#)
- [DBMS\\_DATA\\_MINING - Algorithm Settings: Expectation Maximization](#)

## 13.4 Data Preparation for Expectation Maximization

Learn how to prepare data for Expectation Maximization (EM).

If you use Automatic Data Preparation (ADP), you do not need to specify additional data preparation for Expectation Maximization. ADP normalizes numerical attributes (in non-nested columns) when they are modeled with Gaussian distributions. ADP applies a topN binning transformation to categorical attributes.

Missing value treatment is not needed since Oracle Data Mining algorithms handle missing values automatically. The Expectation Maximization algorithm replaces missing values with the mean in single-column numerical attributes that are modeled with Gaussian distributions. In other single-column attributes (categoricals and numerals modeled with Bernoulli distributions), NULLs are not replaced; they are treated as a distinct value with its own frequency count. In nested columns, missing values are treated as zeros.

#### Related Topics

- [Oracle Data Mining User's Guide](#)

# Explicit Semantic Analysis

Learn how to use Explicit Semantic Analysis (ESA) as an unsupervised algorithm for Feature Extraction function and as a supervised algorithm for Classification.

- [About Explicit Semantic Analysis](#)
- [ESA for Text Mining](#)
- [Data Preparation for ESA](#)

## Related Topics

- [Feature Selection and Extraction](#)  
Learn how to perform Feature Selection, Feature Extraction, and Attribute Importance.

## 14.1 About Explicit Semantic Analysis

In Oracle database 12c Release 2, Explicit Semantic Analysis (ESA) was introduced as an unsupervised algorithm used by Oracle Data Mining for Feature Extraction. Starting from Oracle Database 18c, ESA is enhanced as a supervised algorithm for Classification.

As a Feature Extraction algorithm, ESA does not discover latent features but instead uses explicit features represented in an existing knowledge base. As a Feature Extraction algorithm, ESA is mainly used for calculating semantic similarity of text documents and for explicit topic modeling. As a Classification algorithm, ESA is primarily used for categorizing text documents. Both the Feature Extraction and Classification versions of ESA can be applied to numeric and categorical input data as well.

The input to ESA is a set of attributes vectors. Every attribute vector is associated with a concept. The concept is a feature in the case of Feature Extraction or a target class in the case of Classification. For Feature Extraction, only one attribute vector may be associated with any feature. For Classification, the training set may contain multiple attribute vectors associated with any given target class. These rows related to one target class are aggregated into one by the ESA algorithm.

The output of ESA is a sparse attribute-concept matrix that contains the most important attribute-concept associations. The strength of the association is captured by the weight value of each attribute-concept pair. The attribute-concept matrix is stored as a reverse index that lists the most important concepts for each attribute.

### Note:

For Feature Extraction the ESA algorithm does not project the original feature space and does not reduce its dimensionality. ESA algorithm filters out features with limited or uninformative set of attributes.

The scope of Classification tasks that ESA handles is different than the Classification algorithms such as Naive Bayes and Support Vector Machines. ESA can perform large scale Classification with the number of distinct classes up to hundreds of thousands. The large scale

classification requires gigantic training data sets with some classes having significant number of training samples whereas others are sparsely represented in the training data set.

### 14.1.1 Scoring with ESA

Learn to score with Explicit Semantic Analysis (ESA).

A typical Feature Extraction application of ESA is to identify the most relevant features of a given input and score their relevance. Scoring an ESA model produces data projections in the concept feature space. If an ESA model is built from an arbitrary collection of documents, then each one is treated as a feature. It is then easy to identify the most relevant documents in the collection. The feature extraction functions are: `FEATURE_DETAILS`, `FEATURE_ID`, `FEATURE_SET`, `FEATURE_VALUE`, and `FEATURE_COMPARE`.

A typical Classification application of ESA is to predict classes of a given document and estimate the probabilities of the predictions. As a Classification algorithm, ESA implements the following scoring functions: `PREDICTION`, `PREDICTION_PROBABILITY`, `PREDICTION_SET`, `PREDICTION_DETAILS`, and `PREDICTION_COST`.

#### Related Topics

- *Oracle Data Mining User's Guide*
- *Oracle Database SQL Language Reference*

### 14.1.2 Scoring Large ESA Models

Building an Explicit Semantic Analysis (ESA) model on a large collection of text documents can result in a model with many features or titles. The model information for scoring is loaded into System Global Area (SGA) as a shared (shared pool size) library cache object. Different SQL predictive queries can reference this object. When the model size is large, it is necessary to set the SGA parameter in the database to a sufficient size that accommodates large objects.

If the SGA is too small, the model may need to be re-loaded every time it is referenced which is likely to lead to performance degradation.

## 14.2 ESA for Text Mining

Learn how Explicit Semantic Analysis (ESA) can be used for Text mining.

Explicit knowledge often exists in text form. Multiple knowledge bases are available as collections of text documents. These knowledge bases can be generic, for example, Wikipedia, or domain-specific. Data preparation transforms the text into vectors that capture attribute-concept associations. ESA is able to quantify semantic relatedness of documents even if they do not have any words in common. The function `FEATURE_COMPARE` can be used to compute semantic relatedness.

#### Related Topics

- *Oracle Database SQL Language Reference*

## 14.3 Data Preparation for ESA

Automatic Data Preparation normalizes input vectors to a unit length for Explicit Semantic Analysis (ESA).

When there are missing values in columns with simple data types (not nested), ESA replaces missing categorical values with the mode and missing numerical values with the mean. When there are missing values in nested columns, ESA interprets them as sparse. The algorithm replaces sparse numeric data with zeros and sparse categorical data with zero vectors. The Oracle Data Mining data preparation transforms the input text into a vector of real numbers. These numbers represent the importance of the respective words in the text.

## 14.4 Terminologies in Explicit Semantic Analysis

Discusses the terms associated with Explicit Semantic Analysis (ESA).

### Multi-target Classification

The training items in these large scale classifications belong to several classes. The goal of classification in such case is to detect possible multiple target classes for one item. This kind of classification is called multi-target classification. The target column for ESA-based classification is extended. Collections are allowed as target column values. The collection type for the target in ESA-based classification is `ORA_MINING_VARCHAR2_NT`.

### Large-scale classification

Large-scale classification applies to ontologies that contain gigantic numbers of categories, usually ranging in tens or hundreds of thousands. This large-scale classification also requires gigantic training datasets which are usually unbalanced, that is, some classes may have significant number of training samples whereas others may be sparsely represented in the training dataset. Large-scale classification normally results in multiple target class assignments for a given test case.

### Topic modeling

Topic modelling refers to derivation of the most important topics of a document. Topic modeling can be explicit or latent. Explicit topic modeling results in the selection of the most relevant topics from a pre-defined set, for a given document. Explicit topics have names and can be verbalized. Latent topic modeling identifies a set of latent topics characteristic for a collection of documents. A subset of these latent topics is associated with every document under examination. Latent topics do not have verbal descriptions or meaningful interpretation.

### Related Topics

- *Oracle Database PL/SQL Packages and Types Reference*

# 15

## Exponential Smoothing

Learn about Exponential Smoothing.

- [About Exponential Smoothing](#)
- [Data Preparation for Exponential Smoothing Models](#)

### 15.1 About Exponential Smoothing

Exponential Smoothing methods are widely used for forecasting.

Exponential Smoothing methods have been widely used in forecasting for over half a century. It has applications at the strategic, tactical, and operation level. For example, at a strategic level, forecasting is used for projecting return on investment, growth and the effect of innovations. At a tactical level, forecasting is used for projecting costs, inventory requirements, and customer satisfaction. At an operational level, forecasting is used for setting targets and predicting quality and conformance with standards.

In its simplest form, Exponential Smoothing is a moving average method with a single parameter which models an exponentially decreasing effect of past levels on future values. With a variety of extensions, Exponential Smoothing covers a broader class of models than competitors, such as the Box-Jenkins auto-regressive integrated moving average (ARIMA) approach. Oracle Data Mining implements Exponential Smoothing using a state of the art state space method that incorporates a single source of error (SSOE) assumption which provides theoretical and performance advantages.

Exponential Smoothing is extended to the following:

- A matrix of models that mix and match error type (additive or multiplicative), trend (additive, multiplicative, or none), and seasonality (additive, multiplicative, or none)
- Models with damped trends.
- Models that directly handle irregular time series and time series with missing values.

#### Note:

For more information, see Ord, J.K., et al, *Time Series Forecasting: The Case for the Single Source of Error State Space Approach, Working Paper*, Department of Econometrics and Business Statistics, Monash University, VIC 3800, Australia, April 2, 2005.

#### 15.1.1 Exponential Smoothing Models

Exponential Smoothing models are a broad class of forecasting models that are intuitive, flexible, and extensible.

Members of this class include simple, single parameter models that predict the future as a linear combination of a previous level and a current shock. Extensions can include parameters

for linear or non-linear trend, trend damping, simple or complex seasonality, related series, various forms of non-linearity in the forecasting equations, and handling of irregular time series.

Exponential Smoothing assumes that a series extends infinitely into the past, but that influence of past on future, decays smoothly and exponentially fast. The smooth rate of decay is expressed by one or more smoothing constants. The **smoothing constants** are parameters that the model estimates. The assumption is made practical for modeling real world data by using an equivalent recursive formulation that is only expressed in terms of an estimate of the current level based on prior history and a shock to that estimate dependent on current conditions only. The procedure requires an estimate for the time period just prior to the first observation, that encapsulates all prior history. This initial observation is an additional model parameter whose value is estimated by the modeling procedure.

Components of ESM such as trend and seasonality extensions, can have an additive or multiplicative form. The simpler additive models assume that shock, trend, and seasonality are linear effects within the recursive formulation.

## 15.1.2 Simple Exponential Smoothing

Simple Exponential Smoothing assumes the data fluctuates around a stationary mean, with no trend or seasonal pattern.

In simple exponential smoothing model, each forecast (smoothed value) is computed as the weighted average of the previous observations, where the weights decrease exponentially depending on the value of smoothing constant  $\alpha$ . Values of the smoothing constant,  $\alpha$ , near one, put almost all weight on the most recent observations. Values of  $\alpha$  near zero allows the distant past observations to have a large influence.

## 15.1.3 Models with Trend but No Seasonality

The preferred form of additive (linear) trend is sometimes called Holt's method or double exponential smoothing.

Models with trend add a smoothing parameter  $\gamma$  and optionally a damping parameter  $\phi$ . The damping parameter smoothly dampens the influence of past linear trend on future estimates of level, often improving accuracy.

## 15.1.4 Models with Seasonality but No Trend

When the time series average does not change over time (stationary), but is subject to seasonal fluctuations, the appropriate model has seasonal parameters but no trend.

Seasonal fluctuations are assumed to balance out over periods of length  $m$ , where  $m$  is the number of seasons. For example,  $m=4$  might be used when the input data are aggregated quarterly. For models with additive errors, the seasonal parameters must sum to zero. For models with multiplicative errors, the product of seasonal parameters must be one.

## 15.1.5 Models with Trend and Seasonality

Holt and Winters introduced both trend and seasonality in Exponential Smoothing Model (ESM). The original model, also known as Holt-Winters or triple exponential smoothing, considered an additive trend and multiplicative seasonality. Extensions include models with various combinations of additive and multiplicative trend, seasonality and error, with and without trend damping.

## 15.1.6 Prediction Intervals

To compute prediction intervals, Exponential Smoothing Model (ESM) is divided into three classes.

The simplest class is the class of linear models, which include, among others, simple ESM, Holt's method, and additive Holt-Winters. Class 2 models (multiplicative error, additive components) make an approximate correction for violations of the Normality assumption. Class 3 models use a simple simulation approach to calculate prediction intervals.

## 15.2 Data Preparation for Exponential Smoothing Models

Learn about preparing the data for Exponential Smoothing Model.

To build an ESM model, you must supply the following :

- Input data
- An aggregation level and method, if the case id is a date type
- Partitioning column, if the data are partitioned

In addition, for a greater control over the build process, the user may optionally specify model build parameters, all of which have defaults:

- Model
- Error type
- Optimization criterion
- Forecast Window
- Confidence level for forecast bounds
- Missing value handling
- Whether the input series is evenly spaced

### Related Topics

- *Oracle Data Mining User's Guide*

### See Also:

The Exponential Smoothing Model settings are described in *Oracle Database PL/SQL Packages and Types Reference*.

### 15.2.1 Input Data

Time Series analysis, requires ordered input data. Hence, each data row must consist of an [index, value] pair, where the index specifies the ordering.

When the `CREATE_MODEL` procedure is used to initiate an Exponential Smoothing (ESM) model build, the `CASE_ID_COLUMN_NAME` specifies the column used to compute the indices of the input and the `TARGET_COLUMN_NAME` specifies the column used to compute the observed time series values. The time column bears Oracle number, or Oracle date, timestamp, timestamp with time

zone, or timestamp with local time zone. The input time series are sorted according to the values of `CASE_ID` (time label). The case id column cannot contain missing values. The value column can contain missing values indicated as `NULL`. ESM also supports partitioned models and in such cases, the input table contains an extra column specifying the partition. All [index, value] pairs with the same partition ID form one complete time series. Exponential Smoothing constructs models for each partition independently, although all models use the same model settings.

Properties of the data can result in a warning message or settings are ignored. Settings are ignored when if the user specifies a model with either multiplicative trend, multiplicative seasonality or both and the data contains values  $Y_t \leq 0$ , then the model type is set to the default. If the series contain fewer values than the number of user-specified seasons, then the seasonality specifications are ignored with a warning.

## 15.2.2 Accumulation

For Exponential Smoothing algorithms, the accumulation procedure is applied when the column is a date type (date, datetime, timestamp, timestamp with timezone, or timestamp with local timezone).

The case id can be a `NUMBER` column whose sort index represents the position of the value in the time series sequence of values. The case id column can also be a date type. A date type is accumulated in accordance with a user specified accumulation window. Regardless of type, the case id is used to transform the column into an equally spaced time series. No accumulation is applied for a case id of type `NUMBER`. As an example, consider a time series about promotion events. The time column contains the date of each event, and the dates can be unequally spaced. The user must specify the spacing interval, which is the spacing of the accumulated or transformed equally spaced time series. In the example, if the user specifies the interval to be month, then an equally spaced time series with profit for each calendar month is generated from the original time series. Setting `EXSM_INTERVAL` is used to specify the spacing interval. The user must also specify a value for `EXSM_ACCUMULATE`, for example, `EXSM_ACCU_MAX`, in which case the equally spaced monthly series would contain the maximum profit over all events that month as the observed time series value.

## 15.2.3 Missing Value

Input time series can contain missing values. A `NULL` entry in the target column indicates a missing value. When the time column is of the type `datetime`, the accumulation procedure can also introduce missing values. The setting `EXSM_SETMISSING` can be used to specify how to handle missing values. The special value `EXSM_MISS_AUTO` indicates that, if the series contains missing values it is to be treated as an irregular time series.



### Note:

Missing value handling setting must be compatible with model setting, otherwise an error is thrown.

## 15.2.4 Prediction

Exponential Smoothing Model (ESM) can be applied to make predictions by specifying the prediction window.



Setting `EXSM_PREDICTION_STEP` can be used to specify the prediction window. The prediction window is expressed in terms of number of intervals (setting `EXSM_INTERVAL`), when the time column is of the type `datetime`. If the time column is a number then the prediction window is the number of steps to forecast. Regardless of whether the time series is regular or irregular, `EXSM_PREDICTION_STEP` specifies the prediction window.

## 15.2.5 Parallellism by Partition

Oracle Advanced Analytics supports parallellism by partition.

For example, a user can choose `PRODUCT_ID` as one partition column and can generate forecasts for different products in a model build. Although a distinct smoothing model is built for each partition, all partitions share the same model settings. For example, if setting `EXSM_MODEL` is set to `EXSM_SIMPLE`, all partition models will be simple exponential smoothing models. Time series from different partitions can be distributed to different processes and processed in parallel. The model for each time series is built serially.

# 16

## Generalized Linear Models

Learn how to use Generalized Linear Models (GLM) statistical technique for Linear modeling.

Oracle Data Mining supports GLM for Regression and Binary Classification.

- [About Generalized Linear Models](#)
- [GLM in Oracle Data Mining](#)
- [Scalable Feature Selection](#)
- [Tuning and Diagnostics for GLM](#)
- [GLM Solvers](#)
- [Data Preparation for GLM](#)
- [Linear Regression](#)
- [Logistic Regression](#)

### Related Topics

- [Regression](#)  
Learn how to predict a continuous numerical target through Regression - the supervised mining function.
- [Classification](#)  
Learn how to predict a categorical target through Classification - the supervised mining function.

## 16.1 About Generalized Linear Models

Introduces Generalized Linear Models (GLM).

GLM include and extend the class of linear models.

Linear models make a set of restrictive assumptions, most importantly, that the target (dependent variable  $y$ ) is normally distributed conditioned on the value of predictors with a constant variance regardless of the predicted response value. The advantage of linear models and their restrictions include computational simplicity, an interpretable model form, and the ability to compute certain diagnostic information about the quality of the fit.

Generalized linear models relax these restrictions, which are often violated in practice. For example, binary (yes/no or 0/1) responses do not have same variance across classes. Furthermore, the sum of terms in a linear model typically can have very large ranges encompassing very negative and very positive values. For the binary response example, we would like the response to be a probability in the range  $[0,1]$ .

Generalized linear models accommodate responses that violate the linear model assumptions through two mechanisms: a link function and a variance function. The link function transforms the target range to potentially  $-\infty$  to  $+\infty$  so that the simple form of linear models can be maintained. The variance function expresses the variance as a function of the predicted response, thereby accommodating responses with non-constant variances (such as the binary responses).

Oracle Data Mining includes two of the most popular members of the GLM family of models with their most popular link and variance functions:

- **Linear regression** with the identity link and variance function equal to the constant 1 (constant variance over the range of response values).
- **Logistic regression** with the logit link and binomial variance functions.

#### Related Topics

- [Linear Regression](#)
- [Linear Regression](#)
- [Logistic Regression](#)

## 16.2 GLM in Oracle Data Mining

Generalized Linear Models (GLM) is a parametric modeling technique. Parametric models make assumptions about the distribution of the data. When the assumptions are met, parametric models can be more efficient than non-parametric models.

The challenge in developing models of this type involves assessing the extent to which the assumptions are met. For this reason, quality diagnostics are key to developing quality parametric models.

### 16.2.1 Interpretability and Transparency

Learn how to interpret, and understand data transparency through model details and global details.

Oracle Data Mining Generalized Linear Models (GLM) are easy to interpret. Each model build generates many statistics and diagnostics. Transparency is also a key feature: model details describe key characteristics of the coefficients, and global details provide high-level statistics.

#### Related Topics

- [Tuning and Diagnostics for GLM](#)

### 16.2.2 Wide Data

Oracle Data Mining Generalized Linear Model (GLM) is uniquely suited for handling wide data. The algorithm can build and score quality models that use a virtually limitless number of predictors (attributes). The only constraints are those imposed by system resources.

### 16.2.3 Confidence Bounds

Predict confidence bounds through Generalized Linear Models (GLM).

GLM have the ability to predict confidence bounds. In addition to predicting a best estimate and a probability (Classification only) for each row, GLM identifies an interval wherein the prediction (Regression) or probability (Classification) lies. The width of the interval depends upon the precision of the model and a user-specified confidence level.

The confidence level is a measure of how sure the model is that the true value lies within a confidence interval computed by the model. A popular choice for confidence level is 95%. For example, a model might predict that an employee's income is \$125K, and that you can be 95% sure that it lies between \$90K and \$160K. Oracle Data Mining supports 95% confidence by default, but that value can be configured.

**Note:**

Confidence bounds are returned with the coefficient statistics. You can also use the `PREDICTION_BOUNDS` SQL function to obtain the confidence bounds of a model prediction.

**Related Topics**

- [Oracle Database SQL Language Reference](#)

## 16.2.4 Ridge Regression

Understand the use of Ridge regression for singularity (exact multicollinearity) in data.

The best regression models are those in which the predictors correlate highly with the target, but there is very little correlation between the predictors themselves. **Multicollinearity** is the term used to describe multivariate regression with correlated predictors.

**Ridge regression** is a technique that compensates for multicollinearity. Oracle Data Mining supports ridge regression for both Regression and Classification mining functions. The algorithm automatically uses ridge if it detects singularity (exact multicollinearity) in the data.

Information about singularity is returned in the global model details.

**Related Topics**

- [Global Model Statistics for Linear Regression](#)
- [Global Model Statistics for Logistic Regression](#)

### 16.2.4.1 Configuring Ridge Regression

Configure Ridge Regression through build settings.

You can choose to explicitly enable ridge regression by specifying a build setting for the model. If you explicitly enable ridge, you can use the system-generated ridge parameter or you can supply your own. If ridge is used automatically, the ridge parameter is also calculated automatically.

The configuration choices are summarized as follows:

- Whether or not to override the automatic choice made by the algorithm regarding ridge regression
- The value of the ridge parameter, used only if you specifically enable ridge regression.

**Related Topics**

- [Oracle Database SQL Language Reference](#)

### 16.2.4.2 Ridge and Confidence Bounds

Models built with Ridge Regression do not support confidence bounds.

**Related Topics**

- [Confidence Bounds](#)  
Predict confidence bounds through Generalized Linear Models (GLM).

### 16.2.4.3 Ridge and Data Preparation

Learn about preparing data for Ridge Regression.

When Ridge Regression is enabled, different data preparation is likely to produce different results in terms of model coefficients and diagnostics. Oracle recommends that you enable Automatic Data Preparation for Generalized Linear Models, especially when Ridge Regression is used.

#### Related Topics

- [Data Preparation for GLM](#)  
Learn about preparing data for Generalized Linear Models (GLM).

## 16.3 Scalable Feature Selection

Oracle Data Mining supports a highly scalable and automated version of feature selection and generation for Generalized Linear Models. This capability can enhance the performance of the algorithm and improve accuracy and interpretability. Feature selection and generation are available for both Linear Regression and binary Logistic Regression.

### 16.3.1 Feature Selection

Feature selection is the process of choosing the terms to be included in the model. The fewer terms in the model, the easier it is for human beings to interpret its meaning. In addition, some columns may not be relevant to the value that the model is trying to predict. Removing such columns can enhance model accuracy.

#### 16.3.1.1 Configuring Feature Selection

Feature selection is a build setting for Generalized Linear Models. It is not enabled by default. When configured for feature selection, the algorithm automatically determines appropriate default behavior, but the following configuration options are available:

- The feature selection criteria can be AIC, SBIC, RIC, or  $\alpha$ -investing. When the feature selection criteria is  $\alpha$ -investing, feature acceptance can be either strict or relaxed.
- The maximum number of features can be specified.
- Features can be pruned in the final model. Pruning is based on t-statistics for linear regression or wald statistics for logistic regression.

#### 16.3.1.2 Feature Selection and Ridge Regression

Feature selection and ridge regression are mutually exclusive. When feature selection is enabled, the algorithm can not use ridge.

 **Note:**

If you configure the model to use both feature selection and ridge regression, then you get an error.

## 16.3.2 Feature Generation

Feature generation is the process of adding transformations of terms into the model. Feature generation enhances the power of models to fit more complex relationships between target and predictors.

### 16.3.2.1 Configuring Feature Generation

Learn about configuring Feature Generation.

Feature generation is only possible when feature selection is enabled. Feature generation is a build setting. By default, feature generation is not enabled.

The feature generation method can be either quadratic or cubic. By default, the algorithm chooses the appropriate method. You can also explicitly specify the feature generation method.

The following options for feature selection also affect feature generation:

- Maximum number of features
- Model pruning

#### Related Topics

- *Oracle Database PL/SQL Packages and Types Reference*

## 16.4 Tuning and Diagnostics for GLM

The process of developing a Generalized Linear Model typically involves a number of model builds. Each build generates many statistics that you can evaluate to determine the quality of your model. Depending on these diagnostics, you may want to try changing the model settings or making other modifications.

### 16.4.1 Build Settings

Specify the build settings for Generalized Linear Model (GLM).

You can use specify build settings.

Additional build settings are available to:

- Control the use of ridge regression.
- Specify the handling of missing values in the training data.
- Specify the target value to be used as a reference in a logistic regression model.

#### Related Topics

- [Ridge Regression](#)  
Understand the use of Ridge regression for singularity (exact multicollinearity) in data.
- [Data Preparation for GLM](#)  
Learn about preparing data for Generalized Linear Models (GLM).
- [Logistic Regression](#)
- *Oracle Database PL/SQL Packages and Types Reference*

## 16.4.2 Diagnostics

Generalized Linear Models generate many metrics to help you evaluate the quality of the model.

### 16.4.2.1 Coefficient Statistics

Learn about coefficient statistics for Linear and Logistic Regression.

The same set of statistics is returned for both linear and logistic regression, but statistics that do not apply to the mining function are returned as NULL.

Coefficient statistics are returned by the Model Detail Views for Generalized Linear Model.

#### Related Topics

- [Coefficient Statistics for Linear Regression](#)
- [Coefficient Statistics for Logistic Regression](#)
- *Oracle Data Mining User's Guide*

### 16.4.2.2 Global Model Statistics

Learn about high-level statistics describing the model.

Separate high-level statistics describing the model as a whole, are returned for linear and logistic regression. When ridge regression is enabled, fewer global details are returned.

Global statistics are returned by the Model Detail Views for Generalized Linear Model.

#### Related Topics

- [Global Model Statistics for Linear Regression](#)
- [Global Model Statistics for Logistic Regression](#)
- [Ridge Regression](#)  
Understand the use of Ridge regression for singularity (exact multicollinearity) in data.
- *Oracle Data Mining User's Guide*

### 16.4.2.3 Row Diagnostics

Generate row-statistics by configuring Generalized Linear Models (GLM).

GLM to generate per-row statistics by specifying the name of a diagnostics table in the build setting `GLMS_DIAGNOSTICS_TABLE_NAME`.

GLM requires a case ID to generate row diagnostics. If you provide the name of a diagnostic table but the data does not include a case ID column, an exception is raised.

#### Related Topics

- [Row Diagnostics for Linear Regression](#)
- [Row Diagnostics for Logistic Regression](#)

## 16.5 GLM Solvers

Learn about the different solvers for Generalized Linear Models (GLM).

The GLM algorithm supports four different solvers: Cholesky, QR, Stochastic Gradient Descent (SGD), and Alternating Direction Method of Multipliers (ADMM) (on top of L-BFGS). The Cholesky and QR solvers employ classical decomposition approaches. The Cholesky solver is faster compared to the QR solver but less stable numerically. The QR solver handles better rank deficient problems without the help of regularization.

The SGD and ADMM (on top of L-BFGS) solvers are best suited for large scale data. The SGD solver employs the stochastic gradient descent optimization algorithm while ADMM (on top of L-BFGS) uses the Broyden-Fletcher-Goldfarb-Shanno optimization algorithm within an Alternating Direction Method of Multipliers framework. The SGD solver is fast but is sensitive to parameters and requires suitable scaled data to achieve good convergence. The L-BFGS algorithm solves unconstrained optimization problems and is more stable and robust than SGD. Also, L-BFGS uses ADMM in conjunction, which, results in an efficient distributed optimization approach with low communication cost.

#### Related Topics

- [DBMS\\_DATA\\_MINING - Algorithm Settings: Neural Network](#)
- [DBMS\\_DATA\\_MINING — Algorithm Settings: Generalized Linear Models](#)
- [DBMS\\_DATA\\_MINING — Algorithm Settings: ADMM](#)
- [DBMS\\_DATA\\_MINING — Algorithm Settings: LBFSG](#)

## 16.6 Data Preparation for GLM

Learn about preparing data for Generalized Linear Models (GLM).

Automatic Data Preparation (ADP) implements suitable data transformations for both linear and logistic regression.



#### Note:

Oracle recommends that you use Automatic Data Preparation with GLM.

#### Related Topics

- [Oracle Data Mining User's Guide](#)

### 16.6.1 Data Preparation for Linear Regression

Learn about Automatic Data Preparation (ADP) for Generalized Linear Model (GLM).

When Automatic Data Preparation (ADP) is enabled, the algorithm chooses a transformation based on input data properties and other settings. The transformation can include one or more of the following for numerical data: subtracting the mean, scaling by the standard deviation, or performing a correlation transformation (Neter, et. al, 1990). If the correlation transformation is applied to numeric data, it is also applied to categorical attributes.

Prior to standardization, categorical attributes are exploded into N-1 columns where N is the attribute cardinality. The most frequent value (mode) is omitted during the explosion transformation. In the case of highest frequency ties, the attribute values are sorted alpha-numerically in ascending order, and the first value on the list is omitted during the explosion. This explosion transformation occurs whether or not ADP is enabled.



In the case of high cardinality categorical attributes, the described transformations (explosion followed by standardization) can increase the build data size because the resulting data representation is dense. To reduce memory, disk space, and processing requirements, use an alternative approach. Under these circumstances, the VIF statistic must be used with caution.

### Related Topics

- [Ridge and Data Preparation](#)  
Learn about preparing data for Ridge Regression.
- *Oracle Data Mining User's Guide*

#### See Also:

- Neter, J., Wasserman, W., and Kutner, M.H., "Applied Statistical Models", Richard D. Irwin, Inc., Burr Ridge, IL, 1990.

## 16.6.2 Data Preparation for Logistic Regression

Categorical attributes are exploded into  $N-1$  columns where  $N$  is the attribute cardinality. The most frequent value (mode) is omitted during the explosion transformation. In the case of highest frequency ties, the attribute values are sorted alpha-numerically in ascending order and the first value on the list is omitted during the explosion. This explosion transformation occurs whether or not Automatic Data Preparation (ADP) is enabled.

When ADP is enabled, numerical attributes are scaled by the standard deviation. This measure of variability is computed as the standard deviation per attribute with respect to the origin (not the mean) (Marquardt, 1980).

#### See Also:

- Marquardt, D.W., "A Critique of Some Ridge Regression Methods: Comment", Journal of the American Statistical Association, Vol. 75, No. 369, 1980, pp. 87-91.

## 16.6.3 Missing Values

When building or applying a model, Oracle Data Mining automatically replaces missing values of numerical attributes with the mean and missing values of categorical attributes with the mode.

You can configure a Generalized Linear Models to override the default treatment of missing values. With the `ODMS_MISSING_VALUE_TREATMENT` setting, you can cause the algorithm to delete rows in the training data that have missing values instead of replacing them with the mean or the mode. However, when the model is applied, Oracle Data Mining performs the usual mean/mode missing value replacement. As a result, it is possible that the statistics generated from scoring does not match the statistics generated from building the model.

If you want to delete rows with missing values in the scoring the model, you must perform the transformation explicitly. To make build and apply statistics match, you must remove the rows with NULLs from the scoring data before performing the apply operation. You can do this by creating a view.

```
CREATE VIEW viewname AS SELECT * from tablename
WHERE column_name1 is NOT NULL
AND column_name2 is NOT NULL
AND column_name3 is NOT NULL .....
```

 **Note:**

In Oracle Data Mining, missing values in nested data indicate sparsity, not values missing at random.

The value `ODMS_MISSING_VALUE_DELETE_ROW` is only valid for tables without nested columns. If this value is used with nested data, an exception is raised.

## 16.7 Linear Regression

Linear regression is the Generalized Linear Models' Regression algorithm supported by Oracle Data Mining. The algorithm assumes no target transformation and constant variance over the range of target values.

### 16.7.1 Coefficient Statistics for Linear Regression

Generalized Linear Model Regression models generate the following coefficient statistics:

- Linear coefficient estimate
- Standard error of the coefficient estimate
- t-value of the coefficient estimate
- Probability of the t-value
- Variance Inflation Factor (VIF)
- Standardized estimate of the coefficient
- Lower and upper confidence bounds of the coefficient

### 16.7.2 Global Model Statistics for Linear Regression

Generalized Linear Model Regression models generate the following statistics that describe the model as a whole:

- Model degrees of freedom
- Model sum of squares
- Model mean square
- Model *F* statistic
- Model *F* value probability
- Error degrees of freedom
- Error sum of squares
- Error mean square
- Corrected total degrees of freedom

- Corrected total sum of squares
- Root mean square error
- Dependent mean
- Coefficient of variation
- R-Square
- Adjusted R-Square
- Akaike's information criterion
- Schwarz's Bayesian information criterion
- Estimated mean square error of the prediction
- Hocking Sp statistic
- JP statistic (the final prediction error)
- Number of parameters (the number of coefficients, including the intercept)
- Number of rows
- Whether or not the model converged
- Whether or not a covariance matrix was computed

### 16.7.3 Row Diagnostics for Linear Regression

For Linear Regression, the diagnostics table has the columns described in the following table. All the columns are `NUMBER`, except the `CASE_ID` column, which preserves the type from the training data.

**Table 16-1 Diagnostics Table for GLM Regression Models**

Column	Description
<code>CASE_ID</code>	Value of the case ID column
<code>TARGET_VALUE</code>	Value of the target column
<code>PREDICTED_VALUE</code>	Value predicted by the model for the target
<code>HAT</code>	Value of the diagonal element of the hat matrix
<code>RESIDUAL</code>	Measure of error
<code>STD_ERR_RESIDUAL</code>	Standard error of the residual
<code>STUDENTIZED_RESIDUAL</code>	Studentized residual
<code>PRED_RES</code>	Predicted residual
<code>COOKS_D</code>	Cook's D influence statistic

## 16.8 Logistic Regression

Binary Logistic Regression is the Generalized Linear Model Classification algorithm supported by Oracle Data Mining. The algorithm uses the logit link function and the binomial variance function.

## 16.8.1 Reference Class

You can use the build setting `GLMS_REFERENCE_CLASS_NAME` to specify the target value to be used as a reference in a binary logistic regression model. Probabilities are produced for the other (non-reference) class. By default, the algorithm chooses the value with the highest prevalence. If there are ties, the attributes are sorted alpha-numerically in an ascending order.

## 16.8.2 Class Weights

You can use the build setting `CLAS_WEIGHTS_TABLE_NAME` to specify the name of a class weights table. Class weights influence the weighting of target classes during the model build.

## 16.8.3 Coefficient Statistics for Logistic Regression

Generalized Linear Model Classification models generate the following coefficient statistics:

- Name of the predictor
- Coefficient estimate
- Standard error of the coefficient estimate
- Wald chi-square value of the coefficient estimate
- Probability of the Wald chi-square value
- Standardized estimate of the coefficient
- Lower and upper confidence bounds of the coefficient
- Exponentiated coefficient
- Exponentiated coefficient for the upper and lower confidence bounds of the coefficient

## 16.8.4 Global Model Statistics for Logistic Regression

Generalized Linear Model Classification models generate the following statistics that describe the model as a whole:

- Akaike's criterion for the fit of the intercept only model
- Akaike's criterion for the fit of the intercept and the covariates (predictors) model
- Schwarz's criterion for the fit of the intercept only model
- Schwarz's criterion for the fit of the intercept and the covariates (predictors) model
- -2 log likelihood of the intercept only model
- -2 log likelihood of the model
- Likelihood ratio degrees of freedom
- Likelihood ratio chi-square probability value
- Pseudo R-square Cox an Snell
- Pseudo R-square Nagelkerke
- Dependent mean
- Percent of correct predictions
- Percent of incorrect predictions

- Percent of ties (probability for two cases is the same)
- Number of parameters (the number of coefficients, including the intercept)
- Number of rows
- Whether or not the model converged
- Whether or not a covariance matrix was computed.

## 16.8.5 Row Diagnostics for Logistic Regression

For Logistic Regression, the diagnostics table has the columns described in the following table. All the columns are NUMBER, except the CASE\_ID and TARGET\_VALUE columns, which preserve the type from the training data.

**Table 16-2 Row Diagnostics Table for Logistic Regression**

Column	Description
CASE_ID	Value of the case ID column
TARGET_VALUE	Value of the target value
TARGET_VALUE_PROB	Probability associated with the target value
HAT	Value of the diagonal element of the hat matrix
WORKING_RESIDUAL	Residual with respect to the adjusted dependent variable
PEARSON_RESIDUAL	The raw residual scaled by the estimated standard deviation of the target
DEVIANC_RESIDUAL	Contribution to the overall goodness of fit of the model
C	Confidence interval displacement diagnostic
CBAR	Confidence interval displacement diagnostic
DIFDEV	Change in the deviance due to deleting an individual observation
DIFCHISQ	Change in the Pearson chi-square

# 17

## k-Means

Learn how to use enhanced *k*-Means Clustering algorithm that the Oracle Data Mining supports.

- [About \*k\*-Means](#)
- [k-Means Algorithm Configuration](#)
- [Data Preparation for \*k\*-Means](#)

### Related Topics

- [Clustering](#)  
Learn how to discover natural groupings in the data through Clustering - the unsupervised mining function.

## 17.1 About *k*-Means

The *k*-Means algorithm is a distance-based clustering algorithm that partitions the data into a specified number of clusters.

Distance-based algorithms rely on a distance function to measure the similarity between cases. Cases are assigned to the nearest cluster according to the distance function used.

### 17.1.1 Oracle Data Mining Enhanced *k*-Means

Oracle Data Mining implements an enhanced version of the *k*-Means algorithm with the following features:

- **Distance function:** The algorithm supports Euclidean and Cosine distance functions. The default is Euclidean.
- **Scalable Parallel Model build:** The algorithm uses a very efficient method of initialization based on *Bahmani, Bahman, et al. "Scalable k-means++." Proceedings of the VLDB Endowment 5.7 (2012): 622-633.*
- **Cluster properties:** For each cluster, the algorithm returns the centroid, a histogram for each attribute, and a rule describing the hyperbox that encloses the majority of the data assigned to the cluster. The centroid reports the mode for categorical attributes and the mean and variance for numerical attributes.

This approach to *k*-Means avoids the need for building multiple *k*-Means models and provides clustering results that are consistently superior to the traditional *k*-Means.

### 17.1.2 Centroid

The **centroid** represents the most typical case in a cluster. For example, in a data set of customer ages and incomes, the centroid of each cluster would be a customer of average age and average income in that cluster. The centroid is a prototype. It does not necessarily describe any given case assigned to the cluster.

The attribute values for the centroid are the mean of the numerical attributes and the mode of the categorical attributes.

## 17.2 *k*-Means Algorithm Configuration

Learn about configuring *k*-means algorithm.

The Oracle Data Mining enhanced *k*-Means algorithm supports several build-time settings. All the settings have default values. There is no reason to override the defaults unless you want to influence the behavior of the algorithm in some specific way.

You can configure *k*-Means by specifying the following considerations:

- Number of clusters
- Distance Function. The default distance function is Euclidean.

### Related Topics

- *Oracle Database PL/SQL Packages and Types Reference*

## 17.3 Data Preparation for *k*-Means

Learn about preparing data for *k*-means algorithm.

Normalization is typically required by the *k*-Means algorithm. Automatic Data Preparation performs normalization for *k*-Means. If you do not use ADP, you must normalize numeric attributes before creating or applying the model.

When there are missing values in columns with simple data types (not nested), *k*-Means interprets them as missing at random. The algorithm replaces missing categorical values with the mode and missing numerical values with the mean.

When there are missing values in nested columns, *k*-Means interprets them as sparse. The algorithm replaces sparse numerical data with zeros and sparse categorical data with zero vectors.

### Related Topics

- *Oracle Database PL/SQL Packages and Types Reference*
- Preparing the Data
- Transforming the Data

# 18

## Minimum Description Length

Learn how to use Minimum Description Length, the supervised technique for calculating Attribute Importance.

- [About MDL](#)
- [Data Preparation for MDL](#)

### Related Topics

- [About Feature Selection and Attribute Importance](#)

### 18.1 About MDL

Introduces Minimum Description Length (MDL) algorithm.

MDL is an information theoretic model selection principle. It is an important concept in information theory (the study of the quantification of information) and in learning theory (the study of the capacity for generalization based on empirical data).

MDL assumes that the simplest, most compact representation of the data is the best and most probable explanation of the data. The MDL principle is used to build Oracle Data Mining attribute importance models.

The build process for attribute importance supports parallel execution.

### Related Topics

- [Oracle Database VLDB and Partitioning Guide](#)

#### 18.1.1 Compression and Entropy

**Data compression** is the process of encoding information using fewer **bits** than what the original representation uses. The MDL Principle is based on the notion that the shortest description of the data is the most probable. In typical instantiations of this principle, a model is used to compress the data by reducing the uncertainty (entropy) as discussed below. The description of the data includes a description of the model and the data as described by the model.

**Entropy** is a measure of uncertainty. It quantifies the uncertainty in a random variable as the information required to specify its value. **Information** in this sense is defined as the number of yes/no questions known as **bits** (encoded as 0 or 1) that must be answered for a complete specification. Thus, the information depends upon the number of values that variable can assume.

For example, if the variable represents the sex of an individual, then the number of possible values is two: female and male. If the variable represents the salary of individuals expressed in whole dollar amounts, then the values can be in the range \$0-\$10B, or billions of unique values. Clearly it takes more information to specify an exact salary than to specify an individual's sex.



### 18.1.1.1 Values of a Random Variable: Statistical Distribution

Information (the number of bits) depends on the statistical distribution of the values of the variable as well as the number of values of the variable. If we are judicious in the choice of Yes/No questions, then the amount of information for salary specification cannot be as much as it first appears. Most people do not have billion dollar salaries. If most people have salaries in the range \$32000-\$64000, then most of the time, it requires only 15 questions to discover their salary, rather than the 30 required, if every salary from \$0-\$1000000000 were equally likely. In the former example, if the persons were known to be pregnant, then their sex is known to be female. There is no uncertainty, no Yes/No questions need be asked. The entropy is 0.

### 18.1.1.2 Values of a Random Variable: Significant Predictors

Suppose that for some random variable there is a predictor that when its values are known reduces the uncertainty of the random variable. For example, knowing whether a person is pregnant or not, reduces the uncertainty of the random variable sex-of-individual. This predictor seems like a valuable feature to include in a model. How about name? Imagine that if you knew the name of the person, you would also know the person's sex. If so, the name predictor would seemingly reduce the uncertainty to zero. However, if names are unique, then what was gained? Is the person named Sally? Is the person named George?... We would have as many Yes/No predictors in the name model as there are people. Therefore, specifying the name model would require as many bits as specifying the sex of each person.

### 18.1.1.3 Total Entropy

For a random variable,  $X$ , the **total entropy** is defined as minus the  $\text{Probability}(X)$  multiplied by the log to the base 2 of the  $\text{Probability}(X)$ . This can be shown to be the variable's most efficient encoding.

## 18.1.2 Model Size

Minimum Description Length (MDL) takes into consideration the size of the model as well as the reduction in uncertainty due to using the model. Both model size and entropy are measured in bits. For our purposes, both numeric and categorical predictors are binned. Thus the size of each single predictor model is the number of predictor bins. The uncertainty is reduced to the within-bin target distribution.

## 18.1.3 Model Selection

Minimum Description Length (MDL) considers each attribute as a simple predictive model of the target class. **Model selection** refers to the process of comparing and ranking the single-predictor models.

MDL uses a communication model for solving the model selection problem. In the communication model there is a sender, a receiver, and data to be transmitted.

These single predictor models are compared and ranked with respect to the MDL metric, which is the relative compression in bits. MDL penalizes model complexity to avoid over-fit. It is a principled approach that takes into account the complexity of the predictors (as models) to make the comparisons fair.

## 18.1.4 The MDL Metric

Attribute importance uses a two-part code as the metric for transmitting each unit of data. The first part (preamble) transmits the model. The parameters of the model are the target probabilities associated with each value of the prediction.

For a target with  $j$  values and a predictor with  $k$  values,  $n_i$  ( $i=1, \dots, k$ ) rows per value, there are  $C_i$ , the combination of  $j-1$  things taken  $n_i-1$  at a time possible conditional probabilities. The size of the preamble in bits can be shown to be  $\text{Sum}(\log_2(C_i))$ , where the sum is taken over  $k$ . Computations like this represent the penalties associated with each single prediction model. The second part of the code transmits the target values using the model.

It is well known that the most compact encoding of a sequence is the encoding that best matches the probability of the symbols (target class values). Thus, the model that assigns the highest probability to the sequence has the smallest target class value transmission cost. In bits, this is the  $\text{Sum}(\log_2(p_i))$ , where the  $p_i$  are the predicted probabilities for row  $i$  associated with the model.

The predictor rank is the position in the list of associated description lengths, smallest first.

## 18.2 Data Preparation for MDL

Learn about preparing data for Minimum Description Length (MDL).

Automatic Data Preparation performs supervised binning for MDL. Supervised binning uses decision trees to create the optimal bin boundaries. Both categorical and numerical attributes are binned.

MDL handles missing values naturally as missing at random. The algorithm replaces sparse numerical data with zeros and sparse categorical data with zero vectors. Missing values in nested columns are interpreted as sparse. Missing values in columns with simple data types are interpreted as missing at random.

If you choose to manage your own data preparation, keep in mind that MDL usually benefits from binning. However, the discriminating power of an attribute importance model can be significantly reduced when there are outliers in the data and external equal-width binning is used. This technique can cause most of the data to concentrate in a few bins (a single bin in extreme cases). In this case, quantile binning is a better solution.

### Related Topics

- [Preparing the Data](#)
- [Transforming the Data](#)

# 19

## Naive Bayes

Learn how to use Naive Bayes Classification algorithm that the Oracle Data Mining supports.

- [About Naive Bayes](#)
- [Tuning a Naive Bayes Model](#)
- [Data Preparation for Naive Bayes](#)

### Related Topics

- [Classification](#)  
Learn how to predict a categorical target through Classification - the supervised mining function.

## 19.1 About Naive Bayes

Learn about Naive Bayes algorithm.

The Naive Bayes algorithm is based on conditional probabilities. It uses Bayes' theorem, a formula that calculates a probability by counting the frequency of values and combinations of values in the historical data.

Bayes' theorem finds the probability of an event occurring given the probability of another event that has already occurred. If  $B$  represents the dependent event and  $A$  represents the prior event, Bayes' theorem can be stated as follows.



### Note:

$$\text{Prob}(B \text{ given } A) = \text{Prob}(A \text{ and } B) / \text{Prob}(A)$$

To calculate the probability of  $B$  given  $A$ , the algorithm counts the number of cases where  $A$  and  $B$  occur together and divides it by the number of cases where  $A$  occurs alone.

### Example 19-1 Use Bayes' Theorem to Predict an Increase in Spending

Suppose you want to determine the likelihood that a customer under 21 increases spending. In this case, the prior condition ( $A$ ) is "under 21," and the dependent condition ( $B$ ) is "increase spending."

If there are 100 customers in the training data and 25 of them are customers under 21 who have increased spending, then:

$$\text{Prob}(A \text{ and } B) = 25\%$$

If 75 of the 100 customers are under 21, then:

$$\text{Prob}(A) = 75\%$$

Bayes' theorem predicts that 33% of customers under 21 are likely to increase spending (25/75).

The cases where both conditions occur together are referred to as **pairwise**. In [Example 19-1](#), 25% of all cases are pairwise.

The cases where only the prior event occurs are referred to as **singleton**. In [Example 19-1](#), 75% of all cases are singleton.

A visual representation of the conditional relationships used in Bayes' theorem is shown in the following figure.

**Figure 19-1 Conditional Probabilities in Bayes' Theorem**

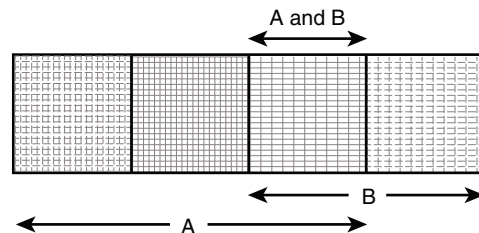

$$\begin{aligned}
 P(A) &= 3/4 \\
 P(B) &= 2/4 \\
 P(A \text{ and } B) &= P(AB) = 1/4 \\
 P(A|B) &= P(AB) / P(B) = (1/4) / (2/4) = 1/2 \\
 P(B|A) &= P(AB) / P(A) = (1/4) / (3/4) = 1/3
 \end{aligned}$$

For purposes of illustration, [Example 19-1](#) and [Figure 19-1](#) show a dependent event based on a single independent event. In reality, the Naive Bayes algorithm must usually take many independent events into account. In [Example 19-1](#), factors such as income, education, gender, and store location might be considered in addition to age.

Naive Bayes makes the assumption that each predictor is conditionally independent of the others. For a given target value, the distribution of each predictor is independent of the other predictors. In practice, this assumption of independence, even when violated, does not degrade the model's predictive accuracy significantly, and makes the difference between a fast, computationally feasible algorithm and an intractable one.

Sometimes the distribution of a given predictor is clearly not representative of the larger population. For example, there might be only a few customers under 21 in the training data, but in fact there are many customers in this age group in the wider customer base. To compensate for this, you can specify **prior probabilities** when training the model.

#### Related Topics

- [Priors and Class Weights](#)  
Learn about Priors and Class Weights in a Classification model to produce a useful result.

## 19.1.1 Advantages of Naive Bayes

Learn about the advantages of Naive Bayes.

The Naive Bayes algorithm affords fast, highly scalable model building and scoring. It scales linearly with the number of predictors and rows.

The build process for Naive Bayes supports parallel execution. (Scoring supports parallel execution irrespective of the algorithm.)

Naive Bayes can be used for both binary and multiclass classification problems.

**Related Topics**

- *Oracle Database VLDB and Partitioning Guide*

## 19.2 Tuning a Naive Bayes Model

Introduces about probability calculation of pairwise occurrences and percentage of singleton occurrences.

Naive Bayes calculates a probability by dividing the percentage of pairwise occurrences by the percentage of singleton occurrences. If these percentages are very small for a given predictor, they probably do not contribute to the effectiveness of the model. Occurrences below a certain threshold can usually be ignored.

The following build settings are available for adjusting the probability thresholds. You can specify:

- The minimum percentage of pairwise occurrences required for including a predictor in the model.
- The minimum percentage of singleton occurrences required for including a predictor in the model .

The default thresholds work well for most models, so you need not adjust these settings.

**Related Topics**

- *Oracle Database PL/SQL Packages and Types Reference*

## 19.3 Data Preparation for Naive Bayes

Learn about preparing the data for Naive Bayes.

Automatic Data Preparation performs supervised binning for Naive Bayes. Supervised binning uses decision trees to create the optimal bin boundaries. Both categorical and numeric attributes are binned.

Naive Bayes handles missing values naturally as missing at random. The algorithm replaces sparse numerical data with zeros and sparse categorical data with zero vectors. Missing values in nested columns are interpreted as sparse. Missing values in columns with simple data types are interpreted as missing at random.

If you choose to manage your own data preparation, keep in mind that Naive Bayes usually requires binning. Naive Bayes relies on counting techniques to calculate probabilities. Columns must be binned to reduce the cardinality as appropriate. Numerical data can be binned into ranges of values (for example, low, medium, and high), and categorical data can be binned into meta-classes (for example, regions instead of cities). Equi-width binning is not recommended, since outliers cause most of the data to concentrate in a few bins, sometimes a single bin. As a result, the discriminating power of the algorithms is significantly reduced

**Related Topics**

- [Preparing the Data](#)
- [Transforming the Data](#)

# 20

## Neural Network

Learn about Neural Network for Regression and Classification mining functions.

- [About Neural Network](#)
- [Data Preparation for Neural Network](#)
- [Neural Network Algorithm Configuration](#)
- [Scoring with Neural Network](#)

### 20.1 About Neural Network

Neural Network in Oracle Data Mining is designed for mining functions like Classification and Regression.

In machine learning, an artificial neural network is an algorithm inspired from biological neural network and is used to estimate or approximate functions that depend on a large number of generally unknown inputs. An artificial neural network is composed of a large number of interconnected neurons which exchange messages between each other to solve specific problems. They learn by examples and tune the weights of the connections among the neurons during the learning process. Neural Network is capable of solving a wide variety of tasks such as computer vision, speech recognition, and various complex business problems.

#### Related Topics

- [Regression](#)  
Learn how to predict a continuous numerical target through Regression - the supervised mining function.
- [Classification](#)  
Learn how to predict a categorical target through Classification - the supervised mining function.

#### 20.1.1 Neuron and activation function

Neurons are the building blocks of a Neural Network.

A neuron takes one or more inputs having different weights and has an output which depends on the inputs. The output is achieved by adding up inputs of each neuron with weights and feeding the sum into the activation function.

A Sigmoid function is usually the most common choice for activation function but other non-linear functions, piecewise linear functions or step functions are also used. The following are some examples of activation functions:

- Logistic Sigmoid function
- Linear function
- Tanh function
- Arctan function
- Bipolar sigmoid function

## 20.1.2 Loss or Cost function

A loss function or cost function is a function that maps an event or values of one or more variables onto a real number intuitively representing some "cost" associated with the event.

An optimization problem seeks to minimize a loss function. The form of loss function is chosen based on the nature of the problem and mathematical needs.

The following are the different loss functions for different scenarios:

- Binary classification: cross entropy function.
- Multi-class classification: softmax function.
- Regression: squared error function.

## 20.1.3 Forward-Backward Propagation

Understand forward-backward propagation.

Forward propagation computes the loss function value by weighted summing the previous layer neuron values and applying activation functions. Backward propagation calculates the gradient of a loss function with respect to all the weights in the network. The weights are initialized with a set of random numbers uniformly distributed within a region specified by user (by setting weights boundaries), or region defined by the number of nodes in the adjacent layers (data driven). The gradients are fed to an optimization method which in turn uses them to update the weights, in an attempt to minimize the loss function.

## 20.1.4 Optimization Solver

Understand optimization solver.

An optimization solver is used to search for the optimal solution of the loss function to find the extreme value (maximum or minimum) of the loss (cost) function.

Oracle Data Mining implements Limited-memory Broyden–Fletcher–Goldfarb–Shanno (L-BFGS) together with line search. L-BFGS is a Quasi-Newton method. This method uses rank-one updates specified by gradient evaluations to approximate Hessian matrix. This method only needs limited amount of memory. L-BFGS is used to find the descent direction and line search is used to find the appropriate step size. The number of historical copies kept in L-BFGS solver is defined by `L_BFGS_HISTORY_DEPTH`. When the number of iterations is smaller than the history depth, the Hessian computed by L-BFGS is accurate. When the number of iterations is larger than the history depth, the Hessian computed by L-BFGS is an approximation. Therefore, the history depth cannot be too small or too large as the computation can be too slow. Typically, the value is between 3 and 10.

## 20.1.5 Regularization

Understand regularization.

Regularization refers to a process of introducing additional information to solve an ill-posed problem or to prevent over-fitting. Ill-posed or over-fitting can occur when a statistical model describes random error or noise instead of the underlying relationship. Typical regularization techniques include L1-norm regularization, L2-norm regularization, and held-aside.

Held-aside is usually used for large training data set whereas L1-norm regularization and L2-norm regularization are mostly used for small training data set.

## 20.1.6 Convergence Check

This checks if the optimal solution has been reached and if the iterations of the optimization has come to an end.

In L-BFGS solver, the convergence criteria includes maximum number of iterations, infinity norm of gradient, and relative error tolerance. For held-aside regularization, the convergence criteria checks the loss function value of the test data set, as well as the best model learned so far. The training is terminated when the model becomes worse for a specific number of iterations (specified by `NNET_HELDASIDE_MAX_FAIL`), or the loss function is close to zero, or the relative error on test data is less than the tolerance.

## 20.1.7 LBFGS\_SCALE\_HESSIAN

Defines `LBFGS_SCALE_HESSIAN`.

It specifies how to set the initial approximation of the inverse Hessian at the beginning of each iteration. If the value is set to be `LBFGS_SCALE_HESSIAN_ENABLE`, then we approximate the initial inverse Hessian with Oren-Luenberger scaling. If it is set to be `LBFGS_SCALE_HESSIAN_DISABLE`, then we use identity as the approximation of the inverse Hessian at the beginning of each iteration.

### Related Topics

- *Oracle Database PL/SQL Packages and Types Reference*

## 20.1.8 NNET\_HELDASIDE\_MAX\_FAIL

Defines `NNET_HELDASIDE_MAX_FAIL`.

Validation data (held-aside) is used to stop training early if the network performance on the validation data fails to improve or remains the same for `NNET_HELDASIDE_MAX_FAIL` epochs in a row.

### Related Topics

- *Oracle Database PL/SQL Packages and Types Reference*

## 20.2 Data Preparation for Neural Network

Learn about preparing data for Neural Network.

The algorithm automatically "explodes" categorical data into a set of binary attributes, one per category value. Oracle Data Mining algorithms automatically handle missing values and therefore, missing value treatment is not necessary.

The algorithm automatically replaces missing categorical values with the mode and missing numerical values with the mean. Neural Network requires the normalization of numeric input. The algorithm uses z-score normalization. The normalization occurs only for two-dimensional numeric columns (not nested). Normalization places the values of numeric attributes on the same scale and prevents attributes with a large original scale from biasing the solution. Neural Network scales the numeric values in nested columns by the maximum absolute value seen in the corresponding columns.



**Related Topics**

- Preparing the Data
- Transforming the Data

## 20.3 Neural Network Algorithm Configuration

Learn about configuring Neural Network algorithm.

**Specify Nodes Per Layer**

```
INSERT INTO SETTINGS_TABLE (setting_name, setting_value) VALUES
    ('NNET_NODES_PER_LAYER', '2,3');
```

**Specify Activation Functions Per Layer**

```
INSERT INTO SETTINGS_TABLE (setting_name, setting_value) VALUES
    ('NNET_ACTIVATIONS', ' ' ' NNET_ACTIVATIONS_TANH ' ', ' '
    NNET_ACTIVATIONS_LOG_SIG ' ' ');
```

**Example 20-1 Example**

In this example you will understand how to build a Neural Network. When the settings table is created and populated, insert a row in the settings table to specify the algorithm.

```
INSERT INTO SETTINGS_TABLE (setting_name, setting_value) VALUES
    ('ALGO_NAME', 'ALGO_NEURAL_NETWORK');
```

Build the model as follows:

```
BEGIN
DBMS_DATA_MINING.CREATE_MODEL(
model_name          => 'model-name',
mining_function     => dbms_data_mining.classification/regression,
data_table_name    => 'test_table',
case_id_column_name => 'case_id',
target_column_name => 'test_target',
settings_table_name => 'settings_table');
END;
/
```

## 20.4 Scoring with Neural Network

Learn to score with Neural Network.

Scoring with Neural Network is the same as any other Classification or Regression algorithm. The following functions are supported: PREDICTION, PREDICTION\_PROBABILITY, PREDICTION\_COST, PREDICTION\_SET, and PREDICTION\_DETAILS.

**Related Topics**

- *Oracle Database SQL Language Reference*

# 21

## Non-Negative Matrix Factorization

Learn how to use Non-Negative Matrix Factorization (NMF), the unsupervised algorithm, that the Oracle Data Mining uses for Feature Extraction.

- [About NMF](#)
- [Tuning the NMF Algorithm](#)
- [Data Preparation for NMF](#)

### Related Topics

- [Feature Selection and Extraction](#)  
Learn how to perform Feature Selection, Feature Extraction, and Attribute Importance.

### See Also:

Paper "Learning the Parts of Objects by Non-Negative Matrix Factorization" by D. D. Lee and H. S. Seung in *Nature* (401, pages 788-791, 1999)

## 21.1 About NMF

Non-Negative Matrix Factorization is a state of the art feature extraction algorithm. NMF is useful when there are many attributes and the attributes are ambiguous or have weak predictability. By combining attributes, NMF can produce meaningful patterns, topics, or themes.

Each feature created by NMF is a linear combination of the original attribute set. Each feature has a set of coefficients, which are a measure of the weight of each attribute on the feature. There is a separate coefficient for each numerical attribute and for each distinct value of each categorical attribute. The coefficients are all non-negative.

### 21.1.1 Matrix Factorization

Non-Negative Matrix Factorization uses techniques from multivariate analysis and linear algebra. It decomposes the data as a matrix  $M$  into the product of two lower ranking matrices  $W$  and  $H$ . The sub-matrix  $W$  contains the NMF basis; the sub-matrix  $H$  contains the associated coefficients (weights).

The algorithm iteratively modifies of the values of  $W$  and  $H$  so that their product approaches  $M$ . The technique preserves much of the structure of the original data and guarantees that both basis and weights are non-negative. The algorithm terminates when the approximation error converges or a specified number of iterations is reached.

The NMF algorithm must be initialized with a seed to indicate the starting point for the iterations. Because of the high dimensionality of the processing space and the fact that there is no global minimization algorithm, the appropriate initialization can be critical in obtaining

meaningful results. Oracle Data Mining uses a random seed that initializes the values of W and H based on a uniform distribution. This approach works well in most cases.

## 21.1.2 Scoring with NMF

Learn about scoring with Non-Negative Matrix Factorization (NMF).

NMF can be used as a pre-processing step for dimensionality reduction in Classification, Regression, Clustering, and other mining tasks. Scoring an NMF model produces data projections in the new feature space. The magnitude of a projection indicates how strongly a record maps to a feature.

The SQL scoring functions for feature extraction support NMF models. When the functions are invoked with the analytical syntax, the functions build and apply a transient NMF model. The feature extraction functions are: `FEATURE_DETAILS`, `FEATURE_ID`, `FEATURE_SET`, and `FEATURE_VALUE`.

### Related Topics

- *Oracle Data Mining User's Guide*

## 21.1.3 Text Mining with NMF

Learn about mining text with Non-Negative Matrix Factorization (NMF).

NMF is especially well-suited for text mining. In a text document, the same word can occur in different places with different meanings. For example, "hike" can be applied to the outdoors or to interest rates. By combining attributes, NMF introduces context, which is essential for explanatory power:

- "hike" + "mountain" -> "outdoor sports"
- "hike" + "interest" -> "interest rates"

### Related Topics

- *Oracle Data Mining User's Guide*

## 21.2 Tuning the NMF Algorithm

Learn about configuring parameters for Non-Negative Matrix Factorization (NMF).

Oracle Data Mining supports five configurable parameters for NMF. All of them have default values which are appropriate for most applications of the algorithm. The NMF settings are:

- Number of features. By default, the number of features is determined by the algorithm.
- Convergence tolerance. The default is .05.
- Number of iterations. The default is 50.
- Random seed. The default is -1.
- Non-negative scoring. You can specify whether negative numbers must be allowed in scoring results. By default they are allowed.

### Related Topics

- *Oracle Database PL/SQL Packages and Types Reference*

## 21.3 Data Preparation for NMF

Learn about preparing the data for Non-Negative Matrix Factorization (NMF).

Automatic Data Preparation normalizes numerical attributes for NMF.

When there are missing values in columns with simple data types (not nested), NMF interprets them as missing at random. The algorithm replaces missing categorical values with the mode and missing numerical values with the mean.

When there are missing values in nested columns, NMF interprets them as sparse. The algorithm replaces sparse numerical data with zeros and sparse categorical data with zero vectors.

If you choose to manage your own data preparation, keep in mind that outliers can significantly impact NMF. Use a clipping transformation before binning or normalizing. NMF typically benefits from normalization. However, outliers with min-max normalization cause poor matrix factorization. To improve the matrix factorization, you need to decrease the error tolerance. This in turn leads to longer build times.

### Related Topics

- [Preparing the Data](#)
- [Transforming the Data](#)

# O-Cluster

Learn how to use Orthogonal Partitioning Clustering (O-Cluster), an Oracle-proprietary Clustering algorithm.

- [About O-Cluster](#)
- [Tuning the O-Cluster Algorithm](#)
- [Data Preparation for O-Cluster](#)

## Related Topics

- [Clustering](#)  
Learn how to discover natural groupings in the data through Clustering - the unsupervised mining function.



### See Also:

Campos, M.M., Milenova, B.L., "Clustering Large Databases with Numeric and Nominal Values Using Orthogonal Projections", Oracle Data Mining Technologies, Oracle Corporation.

Oracle Data Mining

## 22.1 About O-Cluster

O-Cluster is a fast, scalable grid-based clustering algorithm well-suited for mining large, high-dimensional data sets. The algorithm can produce high quality clusters without relying on user-defined parameters.

The objective of O-Cluster is to identify areas of high density in the data and separate the dense areas into clusters. It uses axis-parallel uni-dimensional (orthogonal) data projections to identify the areas of density. The algorithm looks for splitting points that result in distinct clusters that do not overlap and are balanced in size.

O-Cluster operates recursively by creating a binary tree hierarchy. The number of leaf clusters is determined automatically. The algorithm can be configured to limit the maximum number of clusters.

### 22.1.1 Partitioning Strategy

Partitioning strategy refers to the process of discovering areas of density in the attribute histograms. The process differs for numerical and categorical data. When both are present in the data, the algorithm performs the searches separately and then compares the results.

In choosing a partition, the algorithm balances two objectives: finding well separated clusters, and creating clusters that are balanced in size. The following paragraphs detail how partitions for numerical and categorical attributes are identified.

### 22.1.1.1 Partitioning Numerical Attributes

To find the best valid cutting plane, O-Cluster searches the attribute histograms for bins of low density (valleys) between bins of high density (peaks). O-Cluster attempts to find a pair of peaks with a valley between them where the difference between the peak and valley histogram counts is statistically significant.

A **sensitivity** level parameter specifies the lowest density that may be considered a peak. Sensitivity is an optional parameter for numeric data. It may be used to filter the splitting point candidates.

### 22.1.1.2 Partitioning Categorical Attributes

Categorical values do not have an intrinsic order associated with them. Therefore it is impossible to apply the notion of histogram peaks and valleys that is used to partition numerical values.

Instead the counts of individual values form a histogram. Bins with large counts are interpreted as regions with high density. The clustering objective is to separate these high-density areas and effectively decrease the entropy (randomness) of the data.

O-Cluster identifies the histogram with highest entropy along the individual projections. Entropy is measured as the number of bins above **sensitivity** level. O-Cluster places the two largest bins into separate partitions, thereby creating a splitting predicate. The remainder of the bins are assigned randomly to the two resulting partitions.

## 22.1.2 Active Sampling

The O-Cluster algorithm operates on a data buffer of a limited size. It uses an active sampling mechanism to handle data sets that do not fit into memory.

After processing an initial random sample, O-Cluster identifies cases that are of no further interest. Such cases belong to *frozen* partitions where further splitting is highly unlikely. These cases are replaced with examples from *ambiguous* regions where further information (additional cases) is needed to find good splitting planes and continue partitioning. A partition is considered ambiguous if a valid split can only be found at a lower confidence level.

Cases associated with frozen partitions are marked for deletion from the buffer. They are replaced with cases belonging to ambiguous partitions. The histograms of the ambiguous partitions are updated and splitting points are reevaluated.

## 22.1.3 Process Flow

The O-Cluster algorithm evaluates possible splitting points for all projections in a partition, selects the best one, and splits the data into two new partitions. The algorithm proceeds by searching for good cutting planes inside the newly created partitions. Thus, O-Cluster creates a binary tree structure that divides the input space into rectangular regions with no overlaps or gaps.

The main processing stages are:

1. Load the buffer. Assign all cases from the initial buffer to a single active root partition.

2. Compute histograms along the orthogonal uni-dimensional projections for each active partition.
3. Find the best splitting points for active partitions.
4. Flag ambiguous and frozen partitions.
5. When a valid separator exists, split the active partition into two new active partitions and start over at step 2.
6. Reload the buffer after all recursive partitioning on the current buffer is completed. Continue loading the buffer until either the buffer is filled again, or the end of the data set is reached, or until the number of cases is equal to the data buffer size.

 **Note:**

O-Cluster requires at most one pass through the data

## 22.1.4 Scoring

The clusters discovered by O-Cluster are used to generate a Bayesian probability model that can be used to score new data. The generated probability model is a mixture model where the mixture components are represented by a product of independent normal distributions for numerical attributes and multinomial distributions for categorical attributes.

## 22.2 Tuning the O-Cluster Algorithm

Learn about configuring build settings for O-Cluster.

The O-Cluster algorithm supports two build-time settings. Both settings have default values. There is no reason to override the defaults unless you want to influence the behavior of the algorithm in some specific way.

You can configure O-Cluster by specifying any of the following:

- **Buffer size** — Size of the processing buffer.
- **Sensitivity factor** — A fraction that specifies the peak density required for separating a new cluster.

### Related Topics

- [Active Sampling](#)
- [Partitioning Strategy](#)
- *Oracle Database PL/SQL Packages and Types Reference*

## 22.3 Data Preparation for O-Cluster

Learn about preparing the data for O-Cluster.

Automatic Data Preparation bins numerical attributes for O-Cluster. It uses a specialized form of equi-width binning that computes the number of bins per attribute automatically. Numerical columns with all nulls or a single value are removed. O-Cluster handles missing values naturally as missing at random.



**Note:**

O-Cluster does not support nested columns, sparse data, or unstructured text.

**Related Topics**

- Preparing the Data
- Transforming the Data

## 22.3.1 User-Specified Data Preparation for O-Cluster

Learn about preparing the user-specified data for O-Cluster.

Keep the following in mind if you choose to prepare the data for O-Cluster:

- O-Cluster does not necessarily use all the input data when it builds a model. It reads the data in batches (the default batch size is 50000). It only reads another batch if it believes, based on statistical tests, that uncovered clusters can still exist.
- Binary attributes must be declared as categorical.
- Automatic equi-width binning is highly recommended. The bin identifiers are expected to be positive consecutive integers starting at 1.
- The presence of outliers can significantly impact clustering algorithms. Use a clipping transformation before binning or normalizing. Outliers with equi-width binning can prevent O-Cluster from detecting clusters. As a result, the whole population appears to fall within a single cluster.

**Related Topics**

- *Oracle Database PL/SQL Packages and Types Reference*



# 23

## R Extensibility

Learn how to built analytics model and scored in R with ease. R extensible algorithms are enhanced to support and register additional algorithms for SQL users and graphical user interface users.

- [Oracle Data Mining with R Extensibility](#)
- [Scoring with R](#)
- [About Algorithm Meta Data Registration](#)

### 23.1 Oracle Data Mining with R Extensibility

Learn how you can use Oracle Data Mining to build, score, and view Oracle Data Mining models as well as R models.

The Oracle Data Mining framework is enhanced extending the data mining algorithm set with algorithms from the open source R ecosystem. Oracle Data Mining is implemented in the Oracle Database kernel. The mining models are Database schema objects. With the extensibility enhancement, the data mining framework can build, score, and view both Oracle Data Mining models and R models.

#### Registration of R scripts

The R engine on the database server executes the R scripts to build, score, and view R models. These R scripts must be registered with the database beforehand by a privileged user with `rqAdmin` role. You must first install Oracle R Enterprise to register the R scripts.

#### Functions of Oracle Data Mining with R Model

The following functions are supported for an R model:

- Oracle Data Mining `DBMS_DATA_MINING` package is enhanced to support R model. For example, `CREATE_MODEL` and `DROP_MODEL`.
- `MODEL VIEW` to get the R model details about a single model and a partitioned model.
- Oracle Data Mining SQL functions are enhanced to operate with the R model functions. For example, `PREDICTION` and `CLUSTER_ID`.

R model extensibility supports the following data mining functions:

- Association
- Attribute Importance
- Regression
- Classification
- Clustering
- Feature Extraction

## 23.2 Scoring with R

Learn how to build and score with R Mining model.

For more information, see *Oracle Data Mining User's Guide*

## 23.3 About Algorithm Meta Data Registration

Algorithm Meta Data Registration allows for a uniform and consistent approach of registering new algorithm functions and their settings.

Users have the ability to add new R-based algorithms through the registration process. The new algorithms appear as available within Oracle R Enterprise and within the appropriate mining functions. Based on the registration meta data, the settings page is dynamically rendered. The advantages are as follows:

- Manage R-based algorithms more easily
- Easy to specify R-based algorithm for model build
- Clean individual properties in JSON structure
- Share R-based algorithm across user

Algorithm meta data registration extends the mining model capability of Oracle Data Mining.

### Related Topics

- *Oracle Database PL/SQL Packages and Types Reference*
- FETCH\_JSON\_SCHEMA Procedure
- REGISTER\_ALGORITHM Procedure
- JSON Schema for R Extensible Algorithm

### 23.3.1 Algorithm Meta Data Registration

Algorithm Meta Data Registration allows for a uniform and consistent approach of registering new algorithm functions and their settings.

User have the ability to add new algorithms through the registration process. The new algorithms can appear as available within Oracle Data Mining R within their appropriate mining functions. Based on the registration meta data, the settings page is dynamically rendered. Algorithm meta data registration extends the mining model capability of Oracle Data Mining.

### Related Topics

- *Oracle Database PL/SQL Packages and Types Reference*
- FETCH\_JSON\_SCHEMA Procedure
- REGISTER\_ALGORITHM Procedure
- JSON Schema for R Extensible Algorithm

# 24

## Random Forest

Learn how to use Random Forest as a classification algorithm.

- [About Random Forest](#)
- [Building a Random Forest](#)
- [Scoring with Random Forest](#)

### Related Topics

- [Feature Selection and Extraction](#)  
Learn how to perform Feature Selection, Feature Extraction, and Attribute Importance.

### 24.1 About Random Forest

Random Forest is a classification algorithm used by Oracle Data Mining. The algorithm builds an **ensemble** (also called **forest**) of trees.

The algorithm builds a number of decision tree models and predicts using the ensemble. An individual decision tree is built by choosing a random sample from the training data set as the input. At each node of the tree, only a random sample of predictors is chosen for computing the split point. This introduces variation in the data used by the different trees in the forest. The parameters `RFOR_SAMPLING_RATIO` and `RFOR_MTRY` are used to specify the sample size and number of predictors chosen at each node. Users can use `ODMS_RANDOM_SEED` to set the random seed value before running the algorithm.

### Related Topics

- [Decision Tree](#)  
Learn how to use Decision Tree algorithm. Decision Tree is one of the Classification algorithms that the Oracle Data Mining supports.
- [Splitting](#)
- [Data Preparation for Decision Tree](#)  
Learn how to prepare data for Decision Tree.

### 24.2 Building a Random Forest

The Random Forest is built upon existing infrastructure and Application Programming Interfaces (APIs) of Oracle Data Mining.

The model is built by specifying parameters in the existing APIs. The scoring is performed using the same SQL queries and APIs as the existing Classification algorithms. Oracle Data Mining implements a variant of Classical Random Forest algorithm. This implementation supports big data sets. The implementation of the algorithm differs in the following ways:

- Oracle Data Mining does not support bagging and instead provides sampling without replacement
- Users have the ability to specify the depth of the tree. Trees are not built to maximum depth.

**Example 24-1 Example**

In this example you will understand how to build a Random Forest. When the settings table is created and populated, insert a row in the settings table to specify the algorithm and the variant.

```
INSERT INTO SETTINGS_TABLE (setting_name, setting_value) VALUES ('ALGO_NAME',  
'ALGO_RANDOM_FOREST');
```

Build the model as follows:

```
BEGIN  DBMS_DATA_MINING.CREATE_MODEL(  
model_name          => 'model-name',  
mining_function     => dbms_data_mining.classification,  
data_table_name     => 'test_table',  
case_id_column_name => '',  
target_column_name  => 'test_target',  
settings_table_name => 'settings_table');  
END;  
/
```

## 24.3 Scoring with Random Forest

Learn to score with Random Forest.

Scoring with Random Forest is the same as any other Classification algorithm. The following functions are supported: PREDICTION, PREDICTION\_PROBABILITY, PREDICTION\_COST, PREDICTION\_SET, and PREDICTION\_DETAILS.

**Related Topics**

- *Oracle Database SQL Language Reference*

# 25

## Singular Value Decomposition

Learn how to use Singular Value Decomposition, an unsupervised algorithm for Feature Extraction.

- [About Singular Value Decomposition](#)
- [Configuring the Algorithm](#)
- [Data Preparation for SVD](#)

### Related Topics

- [Feature Selection and Extraction](#)  
Learn how to perform Feature Selection, Feature Extraction, and Attribute Importance.

## 25.1 About Singular Value Decomposition

Singular Value Decomposition (SVD) and the closely-related Principal Component Analysis (PCA) are well established feature extraction methods that have a wide range of applications. Oracle Data Mining implements SVD as a feature extraction algorithm and PCA as a special scoring method for SVD models.

SVD and PCA are orthogonal linear transformations that are optimal at capturing the underlying variance of the data. This property is very useful for reducing the dimensionality of high-dimensional data and for supporting meaningful data visualization.

SVD and PCA have a number of important applications in addition to dimensionality reduction. These include matrix inversion, data compression, and the imputation of unknown data values.

### 25.1.1 Matrix Manipulation

Singular Value Decomposition (SVD) is a factorization method that decomposes a rectangular matrix **X** into the product of three matrices:

**Figure 25-1 Matrix Manipulation**

$$\mathbf{X} = \mathbf{U}\mathbf{S}\mathbf{V}'$$

The **U** matrix consists of a set of 'left' orthonormal bases

The **S** matrix is a diagonal matrix

The **V** matrix consists of set of 'right' orthonormal bases

The values in **S** are called singular values. They are non-negative, and their magnitudes indicate the importance of the corresponding bases (components). The singular values reflect the amount of data variance captured by the bases. The first basis (the one with largest singular value) lies in the direction of the greatest data variance. The second basis captures the orthogonal direction with the second greatest variance, and so on.

SVD essentially performs a coordinate rotation that aligns the transformed axes with the directions of maximum variance in the data. This is a useful procedure under the assumption that the observed data has a high signal-to-noise ratio and that a large variance corresponds to interesting data content while a lower variance corresponds to noise.

SVD makes the assumption that the underlying data is Gaussian distributed and can be well described in terms of means and covariances.

## 25.1.2 Low Rank Decomposition

To reduce dimensionality, Singular Value Decomposition (SVD) keeps lower-order bases (the ones with the largest singular values) and ignores higher-order bases (the ones with the smallest singular values). The rationale behind this strategy is that the low-order bases retain the characteristics of the data that contribute most to its variance and are likely to capture the most important aspects of the data.

Given a data set  $\mathbf{X}$  ( $n \times m$ ), where  $n$  is the number of rows and  $m$  is the number of attributes, a low-rank SVD uses only  $k$  components ( $k \leq \min(m, n)$ ). In typical implementations of SVD, the value of  $k$  requires a visual inspection of the ranked singular values associated with the individual components. In Oracle Data Mining, SVD automatically estimates the cutoff point, which corresponds to a significant drop in the explained variance.

SVD produces two sets of orthonormal bases ( $\mathbf{U}$  and  $\mathbf{V}$ ). Either of these bases can be used as a new coordinate system. In Oracle Data Mining SVD,  $\mathbf{V}$  is the new coordinate system, and  $\mathbf{U}$  represents the projection of  $\mathbf{X}$  in this coordinate system. The algorithm computes the projection of new data as follows:

**Figure 25-2 Computing Projection of New Data**

$$\tilde{\mathbf{X}} = \mathbf{X}\mathbf{V}_k\mathbf{S}_k^{-1}$$

where  $\mathbf{X}$  ( $n \times k$ ) is the projected data in the reduced data space, defined by the first  $k$  components, and  $\mathbf{V}_k$  and  $\mathbf{S}_k$  define the reduced component set.

## 25.1.3 Scalability

In Oracle Data Mining, Singular Value Decomposition (SVD) can process data sets with millions of rows and thousands of attributes. Oracle Data Mining automatically recommends an appropriate number of features, based on the data, for dimensionality reduction.

SVD has linear scalability with the number of rows and cubic scalability with the number of attributes when a full decomposition is computed. A low-rank decomposition is typically linear with the number of rows and linear with the number of columns. The scalability with the reduced rank depends on how the rank compares to the number of rows and columns. It can be linear when the rank is significantly smaller or cubic when it is on the same scale.

## 25.2 Configuring the Algorithm

Learn about configuring Singular Value Decomposition (SVD).

Several options are available for configuring the SVD algorithm. Among them are settings to control model size and performance, and whether to score with SVD projections or Principal Component Analysis (PCA) projections.

**Related Topics**

- *Oracle Database PL/SQL Packages and Types Reference*

## 25.2.1 Model Size

The **U** matrix in Singular Value Decomposition has as many rows as the number of rows in the build data. To avoid creating a large model, the **U** matrix persists only when an algorithm-specific setting is enabled. By default the **U** matrix does not persist.

## 25.2.2 Performance

Singular Value Decomposition can use approximate computations to improve performance. Approximation may be appropriate for data sets with many columns. An approximate low-rank decomposition provides good solutions at a reasonable computational cost. The quality of the approximation is dependent on the characteristics of the data.

## 25.2.3 PCA scoring

Learn about configuring Singular Value Decomposition (SVD) to perform Principal Component Analysis (PCA) projections.

SVD models can be configured to perform PCA projections. PCA is closely related to SVD. PCA computes a set of orthonormal bases (principal components) that are ranked by their corresponding explained variance. The main difference between SVD and PCA is that the PCA projection is not scaled by the singular values. The PCA projection to the new coordinate system is given by:

**Figure 25-3 PCA Projection Calculation**

$$\tilde{\mathbf{X}} = \mathbf{X}\mathbf{V}_k$$

where

$$\tilde{\mathbf{X}}$$

( $n \times k$ ) is the projected data in the reduced data space, defined by the first  $k$  components, and  $\mathbf{V}_k$  defines the reduced component set.

**Related Topics**

- *Oracle Database PL/SQL Packages and Types Reference*

## 25.3 Data Preparation for SVD

Learn about preparing the data for Singular Value Decomposition (SVD).

Oracle Data Mining implements SVD for numerical data and categorical data.

When the build data is scored with SVD, Automatic Data Preparation does nothing. When the build data is scored with Principal Component Analysis (PCA), Automatic Data Preparation shifts the numerical data by mean.

Missing value treatment is not needed, because Oracle Data Mining algorithms handle missing values automatically. SVD replaces numerical missing values with the mean and categorical

missing values with the mode. For sparse data (missing values in nested columns), SVD replaces missing values with zeros.

**Related Topics**

- [Preparing the Data](#)
- [Transforming the Data](#)



# 26

## Support Vector Machines

Learn how to use Support Vector Machines, a powerful algorithm based on statistical learning theory.

Oracle Data Mining implements Support Vector Machines for Classification, Regression, and Anomaly Detection.

- [About Support Vector Machines](#)
- [Tuning an SVM Model](#)
- [Data Preparation for SVM](#)
- [SVM Classification](#)
- [One-Class SVM](#)
- [SVM Regression](#)

### Related Topics

- [Regression](#)  
Learn how to predict a continuous numerical target through Regression - the supervised mining function.
- [Anomaly Detection](#)  
Learn how to detect rare cases in the data through Anomaly Detection - an unsupervised function.
- [Oracle Data Mining](#)

### See Also:

Milenova, B.L., Yarmus, J.S., Campos, M.M., "Support Vector Machines in Oracle Database 10g: Removing the Barriers to Widespread Adoption of Support Vector Machines", Proceedings of the 31st VLDB Conference, Trondheim, Norway, 2005.

## 26.1 About Support Vector Machines

Support Vector Machine (SVM) is a powerful, state-of-the-art algorithm with strong theoretical foundations based on the Vapnik-Chervonenkis theory. SVM has strong **regularization** properties. Regularization refers to the generalization of the model to new data.

### 26.1.1 Advantages of SVM

Oracle Data Mining SVM implementation includes two types of solvers, an Interior Point Method (IPM) solver and a Sub-Gradient Descent (SGD) solver. The IPM solver provides stable and accurate solutions, however, it may not be able to handle data of high dimensionality. For high-dimensional and/or large data, for example, text, ratings, and so on,

the SGD solver is a better choice. Both solvers have highly scalable parallel implementations and can handle large volumes of data.

## 26.1.2 Advantages of SVM in Oracle Data Mining

Oracle Data Mining has its own proprietary implementation of Support Vector Machines (SVM), which exploits the many benefits of the algorithm while compensating for some of the limitations inherent in the SVM framework. Oracle Data Mining SVM provides the scalability and usability that are needed in a production quality data mining system.

### 26.1.2.1 Usability

Explains usability for Support Vector Machines (SVM) in Oracle Data Mining.

Usability is a major enhancement, because SVM has often been viewed as a tool for experts. The algorithm typically requires data preparation, tuning, and optimization. Oracle Data Mining minimizes these requirements. You do not need to be an expert to build a quality SVM model in Oracle Data Mining. For example:

- Data preparation is not required in most cases.
- Default tuning parameters are generally adequate.

#### Related Topics

- [Data Preparation for SVM](#)
- [Tuning an SVM Model](#)  
Learn about configuring settings for Support Vector Machines (SVM).

### 26.1.2.2 Scalability

Learn how to scale the data for Support Vector Machines (SVM).

When dealing with very large data sets, sampling is often required. However, sampling is not required with Oracle Data Mining SVM, because the algorithm itself uses stratified sampling to reduce the size of the training data as needed.

Oracle Data Mining SVM is highly optimized. It builds a model incrementally by optimizing small working sets toward a global solution. The model is trained until convergence on the current working set, then the model adapts to the new data. The process continues iteratively until the convergence conditions are met. The Gaussian kernel uses caching techniques to manage the working sets.

#### Related Topics

- [Kernel-Based Learning](#)  
Learn about kernel-based functions to transform the input data for Support Vector Machines (SVM).

## 26.1.3 Kernel-Based Learning

Learn about kernel-based functions to transform the input data for Support Vector Machines (SVM).

SVM is a kernel-based algorithm. A **kernel** is a function that transforms the input data to a high-dimensional space where the problem is solved. Kernel functions can be linear or nonlinear.

Oracle Data Mining supports linear and Gaussian (nonlinear) kernels.

In Oracle Data Mining, the **linear kernel** function reduces to a linear equation on the original attributes in the training data. A linear kernel works well when there are many attributes in the training data.

The **Gaussian kernel** transforms each case in the training data to a point in an  $n$ -dimensional space, where  $n$  is the number of cases. The algorithm attempts to separate the points into subsets with homogeneous target values. The Gaussian kernel uses nonlinear separators, but within the kernel space it constructs a linear equation.

**Note:**

Active Learning is not relevant in Oracle Database 12c Release 2 and later. A setting similar to Active Learning is `ODMS_SAMPLING`.

**Related Topics**

- *Oracle Database PL/SQL Packages and Types Reference*

## 26.2 Tuning an SVM Model

Learn about configuring settings for Support Vector Machines (SVM).

SVM have built-in mechanisms that automatically choose appropriate settings based on the data. You may need to override the system-determined settings for some domains.

Settings pertain to regression, classification, and anomaly detection unless otherwise specified.

**Related Topics**

- *Oracle Database PL/SQL Packages and Types Reference*

## 26.3 Data Preparation for SVM

The SVM algorithm operates natively on numeric attributes. SVM uses z-score normalization on numeric attributes. The normalization occurs only for two-dimensional numeric columns (not nested). The algorithm automatically "explodes" categorical data into a set of binary attributes, typically one per category value. For example, a character column for marital status with values `married` or `single` is transformed to two numeric attributes: `married` and `single`. The new attributes can have the value 1 (true) or 0 (false).

When there are missing values in columns with simple data types (not nested), SVM interprets them as missing at random. The algorithm automatically replaces missing categorical values with the mode and missing numerical values with the mean.

When there are missing values in the nested columns, SVM interprets them as sparse. The algorithm automatically replaces sparse numerical data with zeros and sparse categorical data with zero vectors.

### 26.3.1 Normalization

Support Vector Machines require the normalization of numeric input. Normalization places the values of numeric attributes on the same scale and prevents attributes with a large original

scale from biasing the solution. Normalization also minimizes the likelihood of overflows and underflows.

## 26.3.2 SVM and Automatic Data Preparation

Learn about treating and transforming data manually or through Automatic Data Preparation (ADP) for Support Vector Machines (SVM).

The SVM algorithm automatically handles missing value treatment and the transformation of categorical data, but normalization and outlier detection must be handled by Automatic Data Preparation (ADP) or prepared manually. ADP performs min-max normalization for SVM.

 **Note:**

Oracle recommends that you use Automatic Data Preparation with SVM. The transformations performed by ADP are appropriate for most models.

### Related Topics

- [Oracle Data Mining User's Guide](#)

## 26.4 SVM Classification

Support Vector Machines (SVM) Classification is based on the concept of decision planes that define decision boundaries. A decision plane is one that separates between a set of objects having different class memberships. SVM finds the vectors ("support vectors") that define the separators giving the widest separation of classes.

SVM classification supports both binary, multiclass, and multitarget Classification. Multitarget allows multiple class labels to be associated with a single row. The target type is a collection of type `ORA_MINING_VARCHAR2_NT`.

### Related Topics

- [Oracle Database PL/SQL Packages and Types Reference](#)

### 26.4.1 Class Weights

Learn when to implement class weights to a data in Support Vector Machines (SVM).

In SVM classification, weights are a biasing mechanism for specifying the relative importance of target values (classes).

SVM models are automatically initialized to achieve the best average prediction across all classes. However, if the training data does not represent a realistic distribution, you can bias the model to compensate for class values that are under-represented. If you increase the weight for a class, then the percent of correct predictions for that class must increase.

### Related Topics

- [Priors and Class Weights](#)  
Learn about Priors and Class Weights in a Classification model to produce a useful result.

## 26.5 One-Class SVM

Oracle Data Mining uses Support Vector Machines (SVM) as the one-class classifier for anomaly detection. When SVM is used for anomaly detection, it has the classification mining function but no target.

One-class SVM models, when applied, produce a prediction and a probability for each case in the scoring data. If the prediction is 1, the case is considered typical. If the prediction is 0, the case is considered anomalous. This behavior reflects the fact that the model is trained with normal data.

You can specify the percentage of the data that you expect to be anomalous with the `SVMS_OUTLIER_RATE` build setting. If you have some knowledge that the number of "suspicious" cases is a certain percentage of your population, then you can set the outlier rate to that percentage. The model approximately identifies that many "rare" cases when applied to the general population.

## 26.6 SVM Regression

Learn how to use epsilon-insensitivity loss function to solve regression problems in Support Vector Machines (SVM).

SVM uses an epsilon-insensitive loss function to solve regression problems.

SVM regression tries to find a continuous function such that the maximum number of data points lie within the epsilon-wide insensitivity tube. Predictions falling within epsilon distance of the true target value are not interpreted as errors.

The epsilon factor is a regularization setting for SVM regression. It balances the margin of error with model robustness to achieve the best generalization to new data.

### Related Topics

- [Tuning an SVM Model](#)  
Learn about configuring settings for Support Vector Machines (SVM).

# Part IV

## Using the Data Mining API

Learn how to use Oracle Data Mining application programming interface.

- [Data Mining With SQL](#)
- [About the Data Mining API](#)
- [Preparing the Data](#)
- [Transforming the Data](#)
- [Creating a Model](#)
- [Scoring and Deployment](#)
- [Mining Unstructured Text](#)
- [Administrative Tasks for Oracle Data Mining](#)
- [The Data Mining Sample Programs](#)

# Data Mining With SQL

Learn how to solve business problems using the Oracle Data Mining application programming interface (API).

- [Highlights of the Data Mining API](#)
- [Example: Targeting Likely Candidates for a Sales Promotion](#)
- [Example: Analyzing Preferred Customers](#)
- [Example: Segmenting Customer Data](#)
- [Example : Building an ESA Model with a Wiki Dataset](#)

## 27.1 Highlights of the Data Mining API

Learn about the advantages of Data Mining application programming interface (API).

Data mining is a valuable technology in many application domains. It has become increasingly indispensable in the private sector as a tool for optimizing operations and maintaining a competitive edge. Data mining also has critical applications in the public sector and in scientific research. However, the complexities of data mining application development and the complexities inherent in managing and securing large stores of data can limit the adoption of data mining technology.

Oracle Data Mining is uniquely suited to addressing these challenges. The data mining engine is implemented in the Database kernel, and the robust administrative features of Oracle Database are available for managing and securing the data. While supporting a full range of data mining algorithms and procedures, the API also has features that simplify the development of data mining applications.

The Oracle Data Mining API consists of extensions to Oracle SQL, the native language of the Database. The API offers the following advantages:

- Scoring in the context of SQL queries. Scoring can be performed dynamically or by applying data mining models.
- Automatic Data Preparation (ADP) and embedded transformations.
- Model transparency. Algorithm-specific queries return details about the attributes that were used to create the model.
- Scoring transparency. Details about the prediction, clustering, or feature extraction operation can be returned with the score.
- Simple routines for predictive analytics.
- A workflow-based graphical user interface (GUI) within Oracle SQL Developer. You can download SQL Developer free of charge from the following site:

`Oracle Data Miner`

**Note:**

A set of sample data mining programs ship with Oracle Database. The examples in this manual are taken from these samples.

**Related Topics**

- [The Data Mining Sample Programs](#)  
Describes the data mining sample programs that ship with Oracle Database.
- [Oracle Data Mining Concepts](#)

## 27.2 Example: Targeting Likely Candidates for a Sales Promotion

This example targets customers in Brazil for a special promotion that offers coupons and an affinity card.

The query uses data on marital status, education, and income to predict the customers who are most likely to take advantage of the incentives. The query applies a decision tree model called `dt_sh_clas_sample` to score the customer data.

**Example 27-1 Predict Best Candidates for an Affinity Card**

```
SELECT cust_id
FROM mining_data_apply_v
WHERE
    PREDICTION(dt_sh_clas_sample
               USING cust_marital_status, education, cust_income_level ) = 1
AND country_name IN 'Brazil';

CUST_ID
-----
100404
100607
101113
```

The same query, but with a bias to favor false positives over false negatives, is shown here.

```
SELECT cust_id
FROM mining_data_apply_v
WHERE
    PREDICTION(dt_sh_clas_sample COST MODEL
               USING cust_marital_status, education, cust_income_level ) = 1
AND country_name IN 'Brazil';

CUST_ID
-----
100139
100163
100275
100404
100607
101113
101170
101463
```

The `COST MODEL` keywords cause the cost matrix associated with the model to be used in making the prediction. The cost matrix, stored in a table called `dt_sh_sample_costs`, specifies



that a false negative is eight times more costly than a false positive. Overlooking a likely candidate for the promotion is far more costly than including an unlikely candidate.

```
SELECT * FROM dt_sh_sample_cost;
```

ACTUAL_TARGET_VALUE	PREDICTED_TARGET_VALUE	COST
0	0	0
0	1	1
1	0	8
1	1	0

## 27.3 Example: Analyzing Preferred Customers

The examples in this section reveal information about customers who use affinity cards or are likely to use affinity cards.

### Example 27-2 Find Demographic Information About Preferred Customers

This query returns the gender, age, and length of residence of typical affinity card holders. The anomaly detection model, `SVMO_SH_Clas_sample`, returns 1 for typical cases and 0 for anomalies. The demographics are predicted for typical customers only; outliers are not included in the sample.

```
SELECT cust_gender, round(avg(age)) age,
       round(avg(yrs_residence)) yrs_residence,
       count(*) cnt
FROM mining_data_one_class_v
WHERE PREDICTION(SVMO_SH_Clas_sample using *) = 1
GROUP BY cust_gender
ORDER BY cust_gender;
```

CUST_GENDER	AGE	YRS_RESIDENCE	CNT
F	40	4	36
M	45	5	304

### Example 27-3 Dynamically Identify Customers Who Resemble Preferred Customers

This query identifies customers who do not currently have an affinity card, but who share many of the characteristics of affinity card holders. The `PREDICTION` and `PREDICTION_PROBABILITY` functions use an `OVER` clause instead of a predefined model to classify the customers. The predictions and probabilities are computed dynamically.

```
SELECT cust_id, pred_prob
FROM
  (SELECT cust_id, affinity_card,
         PREDICTION(FOR TO_CHAR(affinity_card) USING *) OVER () pred_card,
         PREDICTION_PROBABILITY(FOR TO_CHAR(affinity_card),1 USING *) OVER () pred_prob
   FROM mining_data_build_v)
WHERE affinity_card = 0
   AND pred_card = 1
ORDER BY pred_prob DESC;
```

CUST_ID	PRED_PROB
102434	.96
102365	.96
102330	.96
101733	.95
102615	.94

```

102686      .94
102749      .93
.
.
.
.
102580      .52
102269      .52
102533      .51
101604      .51
101656      .51
  
```

226 rows selected.

### Example 27-4 Predict the Likelihood that a New Customer Becomes a Preferred Customer

This query computes the probability of a first-time customer becoming a preferred customer (an affinity card holder). This query can be executed in real time at the point of sale.

The new customer is a 44-year-old American executive who has a bachelors degree and earns more than \$300,000/year. He is married, lives in a household of 3, and has lived in the same residence for the past 6 years. The probability of this customer becoming a typical affinity card holder is only 5.8%.

```

SELECT PREDICTION_PROBABILITY(SVMO_SH_Clas_sample, 1 USING
                               44 AS age,
                               6 AS yrs_residence,
                               'Bach.' AS education,
                               'Married' AS cust_marital_status,
                               'Exec.' AS occupation,
                               'United States of America' AS country_name,
                               'M' AS cust_gender,
                               'L: 300,000 and above' AS cust_income_level,
                               '3' AS household_size
                               ) prob_typical

FROM DUAL;

PROB_TYPICAL
-----
5.8
  
```

### Example 27-5 Use Predictive Analytics to Find Top Predictors

The DBMS\_PREDICTIVE\_ANALYTICS PL/SQL package contains routines that perform simple data mining operations without a predefined model. In this example, the EXPLAIN routine computes the top predictors for affinity card ownership. The results show that household size, marital status, and age are the top three predictors.

```

BEGIN
  DBMS_PREDICTIVE_ANALYTICS.EXPLAIN(
    data_table_name      => 'mining_data_test_v',
    explain_column_name  => 'affinity_card',
    result_table_name    => 'cust_explain_result');
END;
/

SELECT * FROM cust_explain_result
       WHERE rank < 4;

ATTRIBUTE_NAME          ATTRIBUTE_SUBNAME    EXPLANATORY_VALUE    RANK
-----
  
```

HOUSEHOLD_SIZE	.209628541	1
CUST_MARITAL_STATUS	.199794636	2
AGE	.111683067	3

## 27.4 Example: Segmenting Customer Data

The examples in this section use an Expectation Maximization clustering model to segment the customer data based on common characteristics.

### Example 27-6 Compute Customer Segments

This query computes natural groupings of customers and returns the number of customers in each group.

```
SELECT CLUSTER_ID(em_sh_clus_sample USING *) AS clus, COUNT(*) AS cnt
FROM mining_data_apply_v
GROUP BY CLUSTER_ID(em_sh_clus_sample USING *)
ORDER BY cnt DESC;
```

CLUS	CNT
9	311
3	294
7	215
12	201
17	123
16	114
14	86
19	64
15	56
18	36

### Example 27-7 Find the Customers Who Are Most Likely To Be in the Largest Segment

The query in [Example 27-6](#) shows that segment 9 has the most members. The following query lists the five customers who are most likely to be in segment 9.

```
SELECT cust_id
FROM (SELECT cust_id, RANK() over (ORDER BY prob DESC, cust_id) rnk_clus2
FROM (SELECT cust_id,
ROUND(CLUSTER_PROBABILITY(em_sh_clus_sample, 9 USING *),3) prob
FROM mining_data_apply_v))
WHERE rnk_clus2 <= 5
ORDER BY rnk_clus2;
```

CUST_ID
100002
100012
100016
100019
100021

### Example 27-8 Find Key Characteristics of the Most Representative Customer in the Largest Cluster

The query in [Example 27-7](#) lists customer 100002 first in the list of likely customers for segment 9. The following query returns the five characteristics that are most significant in determining the assignment of customer 100002 to segments with probability > 20% (only segment 9 for this customer).

```
SELECT S.cluster_id, probability prob,
CLUSTER_DETAILS(em_sh_clus_sample, S.cluster_id, 5 using T.*) det
```

```

FROM
  (SELECT v.*, CLUSTER_SET(em_sh_clus_sample, NULL, 0.2 USING *) pset
   FROM mining_data_apply_v v
   WHERE cust_id = 100002) T,
TABLE(T.pset) S
ORDER BY 2 desc;

```

```

CLUSTER_ID    PROB DET
-----
9  1.0000 <Details algorithm="Expectation Maximization" cluster="9">
      <Attribute name="YRS_RESIDENCE" actualValue="4" weight="1" rank="1"/>
      <Attribute name="EDUCATION" actualValue="Bach." weight="0" rank="2"/>
      <Attribute name="AFFINITY_CARD" actualValue="0" weight="0" rank="3"/>
      <Attribute name="BOOKKEEPING_APPLICATION" actualValue="1" weight="0" rank="4"/>
      <Attribute name="Y_BOX_GAMES" actualValue="0" weight="0" rank="5"/>
      </Details>

```

## 27.5 Example : Building an ESA Model with a Wiki Dataset

The examples shows `FEATURE_COMPARE` function with Explicit Semantic Analysis (ESA) model, which compares a similar set of texts and then a dissimilar set of texts.

The example shows an ESA model built against a 2005 Wiki dataset rendering over 200,000 features. The documents are mined as text and the document titles are given as the feature IDs.

### Similar Texts

```

SELECT 1-FEATURE_COMPARE(esa_wiki_mod USING 'There are several PGA tour
golfers from South Africa' text AND USING 'Nick Price won the 2002 Mastercard
Colonial Open' text) similarity FROM DUAL;

```

```

SIMILARITY
-----
      .258

```

The output metric shows distance calculation. Therefore, smaller number represent more similar texts. So, 1 minus the distance in the queries result in similarity.

### Dissimilar Texts

```

SELECT 1-FEATURE_COMPARE(esa_wiki_mod USING 'There are several PGA tour
golfers from South Africa' text AND USING 'John Elway played quarterback for
the Denver Broncos' text) similarity FROM DUAL;

```

```

SIMILARITY
-----
      .007

```

# About the Data Mining API

Overview of the Oracle Data Mining application programming interface (API) components.

- [About Mining Models](#)
- [Data Mining Data Dictionary Views](#)
- [Data Mining PL/SQL Packages](#)
- [Data Mining SQL Scoring Functions](#)

## 28.1 About Mining Models

Mining models are database schema objects that perform data mining.

As with all schema objects, access to mining models is controlled by database privileges. Models can be exported and imported. They support comments, and they can be tracked in the Database auditing system.

Mining models are created by the `CREATE_MODEL` procedure in the `DBMS_DATA_MINING` PL/SQL package. Models are created for a specific mining function, and they use a specific algorithm to perform that function. **Mining function** is a data mining term that refers to a class of mining problems to be solved. Examples of mining functions are: regression, classification, attribute importance, clustering, anomaly detection, and feature extraction. Oracle Data Mining supports one or more algorithms for each mining function.



### Note:

Most types of mining models can be used to score data. However, it is possible to score data without applying a model. Dynamic scoring and predictive analytics return scoring results without a user-supplied model. They create and apply transient models that are not visible to you.

### Related Topics

- [Dynamic Scoring](#)
- [DBMS\\_PREDICTIVE\\_ANALYTICS](#)  
Understand the routines of `DBMS_PREDICTIVE_ANALYTICS` package.
- [Creating a Model](#)  
Explains how to create data mining models and query model details.
- [Administrative Tasks for Oracle Data Mining](#)  
Explains how to perform administrative tasks related to Oracle Data Mining.

## 28.2 Data Mining Data Dictionary Views

Lists Oracle Data Mining data dictionary views.

The data dictionary views for Oracle Data Mining are listed in the following table. A database administrator (DBA) and USER versions of the views are also available.

**Table 28-1 Data Dictionary Views for Oracle Data Mining**

View Name	Description
ALL_MINING_MODELS	Provides information about all accessible mining models
ALL_MINING_MODEL_ATTRIBUTES	Provides information about the attributes of all accessible mining models
ALL_MINING_MODEL_PARTITIONS	Provides information about the partitions of all accessible partitioned mining models
ALL_MINING_MODEL_SETTINGS	Provides information about the configuration settings for all accessible mining models
ALL_MINING_MODEL_VIEWS	Provides information about the model views for all accessible mining models
ALL_MINING_MODEL_XFORMS	Provides the user-specified transformations embedded in all accessible mining models.

### 28.2.1 ALL\_MINING\_MODELS

Describes an example of ALL\_MINING\_MODELS and shows a sample query.

The following example describes ALL\_MINING\_MODELS and shows a sample query.

**Example 28-1 ALL\_MINING\_MODELS**

```
describe ALL_MINING_MODELS
Name                                     Null?   Type
-----
OWNER                                    NOT NULL VARCHAR2(128)
MODEL_NAME                               NOT NULL VARCHAR2(128)
MINING_FUNCTION                           VARCHAR2(30)
ALGORITHM                                 VARCHAR2(30)
CREATION_DATE                             NOT NULL DATE
BUILD_DURATION                             NUMBER
MODEL_SIZE                                NUMBER
PARTITIONED                               VARCHAR2(3)
COMMENTS                                  VARCHAR2(4000)
```

The following query returns the models accessible to you that use the Support Vector Machine algorithm.

```
SELECT mining_function, model_name
       FROM all_mining_models
       WHERE algorithm = 'SUPPORT_VECTOR_MACHINES'
       ORDER BY mining_function, model_name;

MINING_FUNCTION           MODEL_NAME
```

```

-----
CLASSIFICATION      PART2_CLAS_SAMPLE
CLASSIFICATION      PART_CLAS_SAMPLE
CLASSIFICATION      SVMC_SH_CLAS_SAMPLE
CLASSIFICATION      SVMO_SH_CLAS_SAMPLE
CLASSIFICATION      T_SVM_CLAS_SAMPLE
REGRESSION          SVMR_SH_REGR_SAMPLE
  
```

### Related Topics

- [Creating a Model](#)  
Explains how to create data mining models and query model details.
- [Oracle Database Reference](#)

## 28.2.2 ALL\_MINING\_MODEL\_ATTRIBUTES

Describes an example of ALL\_MINING\_MODEL\_ATTRIBUTES and shows a sample query.

The following example describes ALL\_MINING\_MODEL\_ATTRIBUTES and shows a sample query. Attributes are the predictors or conditions that are used to create models and score data.

### Example 28-2 ALL\_MINING\_MODEL\_ATTRIBUTES

```

describe ALL_MINING_MODEL_ATTRIBUTES
Name                                     Null?   Type
-----
OWNER                                    NOT NULL  VARCHAR2 (128)
MODEL_NAME                               NOT NULL  VARCHAR2 (128)
ATTRIBUTE_NAME                           NOT NULL  VARCHAR2 (128)
ATTRIBUTE_TYPE                            VARCHAR2 (11)
DATA_TYPE                                 VARCHAR2 (106)
DATA_LENGTH                               NUMBER
DATA_PRECISION                           NUMBER
DATA_SCALE                               NUMBER
USAGE_TYPE                                VARCHAR2 (8)
TARGET                                    VARCHAR2 (3)
ATTRIBUTE_SPEC                            VARCHAR2 (4000)
  
```

The following query returns the attributes of an SVM classification model named T\_SVM\_CLAS\_SAMPLE. The model has both categorical and numerical attributes and includes one attribute that is unstructured text.

```

SELECT attribute_name, attribute_type, target
   FROM all_mining_model_attributes
  WHERE model_name = 'T_SVM_CLAS_SAMPLE'
 ORDER BY attribute_name;
  
```

```

ATTRIBUTE_NAME      ATTRIBUTE_TYPE      TAR
-----
AFFINITY_CARD       CATEGORICAL        YES
AGE                 NUMERICAL           NO
BOOKKEEPING_APPLICATION NUMERICAL           NO
BULK_PACK_DISKETTES NUMERICAL           NO
COMMENTS           TEXT                NO
COUNTRY_NAME       CATEGORICAL        NO
CUST_GENDER        CATEGORICAL        NO
CUST_INCOME_LEVEL  CATEGORICAL        NO
CUST_MARITAL_STATUS CATEGORICAL        NO
EDUCATION          CATEGORICAL        NO
FLAT_PANEL_MONITOR NUMERICAL           NO
HOME_THEATER_PACKAGE NUMERICAL           NO
  
```

HOUSEHOLD_SIZE	CATEGORICAL	NO
OCCUPATION	CATEGORICAL	NO
OS_DOC_SET_KANJI	NUMERICAL	NO
PRINTER_SUPPLIES	NUMERICAL	NO
YRS_RESIDENCE	NUMERICAL	NO
Y_BOX_GAMES	NUMERICAL	NO

### Related Topics

- [About the Data Mining API](#)  
Overview of the Oracle Data Mining application programming interface (API) components.
- *Oracle Database Reference*

## 28.2.3 ALL\_MINING\_MODEL\_PARTITIONS

Describes an example of ALL\_MINING\_MODEL\_PARTITIONS and shows a sample query.

The following example describes ALL\_MINING\_MODEL\_PARTITIONS and shows a sample query.

### Example 28-3 ALL\_MINING\_MODEL\_PARTITIONS

```
describe ALL_MINING_MODEL_PARTITIONS
```

Name	Null?	Type
OWNER	NOT NULL	VARCHAR2 (128)
MODEL_NAME	NOT NULL	VARCHAR2 (128)
PARTITION_NAME		VARCHAR2 (128)
POSITION		NUMBER
COLUMN_NAME	NOT NULL	VARCHAR2 (128)
COLUMN_VALUE		VARCHAR2 (4000)

The following query returns the partition names and partition key values for two partitioned models. Model PART2\_CLAS\_SAMPLE has a two column partition key with system-generated partition names.

```
SELECT model_name, partition_name, position, column_name, column_value
FROM all_mining_model_partitions
ORDER BY model_name, partition_name, position;
```

MODEL_NAME	PARTITION_	POSITION	COLUMN_NAME
COLUMN_VALUE			
PART2_CLAS_SAMPLE	DM\$\$_P0	1	CUST_GENDER
F			
PART2_CLAS_SAMPLE	DM\$\$_P0	2	CUST_INCOME_LEVEL
HIGH			
PART2_CLAS_SAMPLE	DM\$\$_P1	1	CUST_GENDER
F			
PART2_CLAS_SAMPLE	DM\$\$_P1	2	CUST_INCOME_LEVEL
LOW			
PART2_CLAS_SAMPLE	DM\$\$_P2	1	CUST_GENDER
F			
PART2_CLAS_SAMPLE	DM\$\$_P2	2	CUST_INCOME_LEVEL
MEDIUM			
PART2_CLAS_SAMPLE	DM\$\$_P3	1	CUST_GENDER
M			
PART2_CLAS_SAMPLE	DM\$\$_P3	2	CUST_INCOME_LEVEL



HIGH	PART2_CLAS_SAMPLE	DM\$\$_P4	1	CUST_GENDER	
M	PART2_CLAS_SAMPLE	DM\$\$_P4	2	CUST_INCOME_LEVEL	
LOW	PART2_CLAS_SAMPLE	DM\$\$_P5	1	CUST_GENDER	
M	PART2_CLAS_SAMPLE	DM\$\$_P5	2	CUST_INCOME_LEVEL	
MEDIUM	PART_CLAS_SAMPLE	F	1	CUST_GENDER	
F	PART_CLAS_SAMPLE	M	1	CUST_GENDER	
M	PART_CLAS_SAMPLE	U	1	CUST_GENDER	U

### Related Topics

- [Oracle Database Reference](#)

## 28.2.4 ALL\_MINING\_MODEL\_SETTINGS

Describes an example of ALL\_MINING\_MODEL\_SETTINGS and shows a sample query.

The following example describes ALL\_MINING\_MODEL\_SETTINGS and shows a sample query. Settings influence model behavior. Settings may be specific to an algorithm or to a mining function, or they may be general.

### Example 28-4 ALL\_MINING\_MODEL\_SETTINGS

```
describe ALL_MINING_MODEL_SETTINGS
```

Name	Null?	Type
OWNER	NOT NULL	VARCHAR2 (128)
MODEL_NAME	NOT NULL	VARCHAR2 (128)
SETTING_NAME	NOT NULL	VARCHAR2 (30)
SETTING_VALUE		VARCHAR2 (4000)
SETTING_TYPE		VARCHAR2 (7)

The following query returns the settings for a model named SVD\_SH\_SAMPLE. The model uses the Singular Value Decomposition algorithm for feature extraction.

```
SELECT setting_name, setting_value, setting_type
FROM all_mining_model_settings
WHERE model_name = 'SVD_SH_SAMPLE'
ORDER BY setting_name;
```

SETTING_NAME	SETTING_VALUE	SETTING
ALGO_NAME	ALGO_SINGULAR_VALUE_DECOMP	INPUT
ODMS_MISSING_VALUE_TREATMENT	ODMS_MISSING_VALUE_AUTO	DEFAULT
ODMS_SAMPLING	ODMS_SAMPLING_DISABLE	DEFAULT
PREP_AUTO	OFF	INPUT
SVDS_SCORING_MODE	SVDS_SCORING_SVD	DEFAULT
SVDS_U_MATRIX_OUTPUT	SVDS_U_MATRIX_ENABLE	INPUT

### Related Topics

- [Specifying Model Settings](#)  
Understand how to configure data mining models at build time.

- *Oracle Database Reference*

## 28.2.5 ALL\_MINING\_MODEL\_VIEWS

Describes an example of ALL\_MINING\_MODEL\_VIEWS and shows a sample query.

The following example describes ALL\_MINING\_MODEL\_VIEWS and shows a sample query. Model views provide details on the models.

### Example 28-5 ALL\_MINING\_MODEL\_VIEWS

```
describe ALL_MINING_MODEL_VIEWS
Name
-----
OWNER                                NOT NULL VARCHAR2(128)
MODEL_NAME                           NOT NULL VARCHAR2(128)
VIEW_NAME                             NOT NULL VARCHAR2(128)
VIEW_TYPE                             VARCHAR2(128)
```

The following query returns the model views for a model SVD\_SH\_SAMPLE. The model uses the Singular Value Decomposition algorithm for feature extraction.

```
SELECT view_name, view_type
       FROM all_mining_model_views
       WHERE model_name = 'SVD_SH_SAMPLE'
       ORDER BY view_name;

VIEW_NAME
VIEW_TYPE
-----
DM$VESVD_SH_SAMPLE      Singular Value Decomposition S
Matrix
DM$VGSVD_SH_SAMPLE      Global Name-Value
Pairs
DM$VNSVD_SH_SAMPLE      Normalization and Missing Value
Handling
DM$VSSVD_SH_SAMPLE      Computed
Settings
DM$VUSVD_SH_SAMPLE      Singular Value Decomposition U
Matrix
DM$VVSVD_SH_SAMPLE      Singular Value Decomposition V
Matrix
DM$VWSVD_SH_SAMPLE      Model Build Alerts
```

### Related Topics

- *Oracle Database Reference*

## 28.2.6 ALL\_MINING\_MODEL\_XFORMS

Describes an example of ALL\_MINING\_MODEL\_XFORMS and provides a sample query.

The following example describes ALL\_MINING\_MODEL\_XFORMS and provides a sample query.

**Example 28-6 ALL\_MINING\_MODEL\_XFORMS**

```
describe ALL_MINING_MODEL_XFORMS
```

Name	Null?	Type
OWNER	NOT NULL	VARCHAR2 (128)
MODEL_NAME	NOT NULL	VARCHAR2 (128)
ATTRIBUTE_NAME		VARCHAR2 (128)
ATTRIBUTE_SUBNAME		VARCHAR2 (4000)
ATTRIBUTE_SPEC		VARCHAR2 (4000)
EXPRESSION		CLOB
REVERSE		VARCHAR2 (3)

The following query returns the embedded transformations for a model PART2\_CLAS\_SAMPLE.

```
SELECT attribute_name, expression
       FROM all_mining_model_xforms
       WHERE model_name = 'PART2_CLAS_SAMPLE'
       ORDER BY attribute_name;
```

```
ATTRIBUTE_NAME
```

```
-----
```

```
EXPRESSION
```

```
-----
```

```
--
CUST_INCOME_LEVEL
```

```
CASE CUST_INCOME_LEVEL WHEN 'A: Below 30,000' THEN
'LOW'
      WHEN 'L: 300,000 and above' THEN
'HIGH'
      ELSE 'MEDIUM' END
```

**Related Topics**

- [Oracle Database Reference](#)

## 28.3 Data Mining PL/SQL Packages

The PL/SQL interface to Oracle Data Mining is implemented in three packages.

The following table displays the PL/SQL packages.

**Table 28-2 Data Mining PL/SQL Packages**

Package Name	Description
DBMS_DATA_MINING	Routines for creating and managing mining models
DBMS_DATA_MINING_TRANSFORM	Routines for transforming the data for mining
DBMS_PREDICTIVE_ANALYTICS	Routines that perform predictive analytics

**Related Topics**

- [DBMS\\_DATA\\_MINING](#)
- [DBMS\\_DATA\\_MINING\\_TRANSFORM](#)
- [DBMS\\_PREDICTIVE\\_ANALYTICS](#)

## 28.3.1 DBMS\_DATA\_MINING

Understand the routines of `DBMS_DATA_MINING` package.

The `DBMS_DATA_MINING` package contains routines for creating mining models, for performing operations on mining models, and for querying mining models. The package includes routines for:

- Creating, dropping, and performing other DDL operations on mining models
- Obtaining detailed information about model attributes, rules, and other information internal to the model (model details)
- Computing test metrics for classification models
- Specifying costs for classification models
- Exporting and importing models
- Building models using Oracle's native algorithms as well as algorithms written in R

**Related Topics**

- *Oracle Database PL/SQL Packages and Types Reference*

## 28.3.2 DBMS\_DATA\_MINING\_TRANSFORM

Understand the routines of `DBMS_DATA_MINING_TRANSFORM` package.

The `DBMS_DATA_MINING_TRANSFORM` package contains routines that perform data transformations such as binning, normalization, and outlier treatment. The package includes routines for:

- Specifying transformations in a format that can be embedded in a mining model.
- Specifying transformations as relational views (external to mining model objects).
- Specifying distinct properties for columns in the build data. For example, you can specify that the column must be interpreted as unstructured text, or that the column must be excluded from Automatic Data Preparation.

**Related Topics**

- [Transforming the Data](#)  
Understand how to transform data for building a model or for scoring.
- *Oracle Database PL/SQL Packages and Types Reference*

### 28.3.2.1 Transformation Methods in DBMS\_DATA\_MINING\_TRANSFORM

Summarizes the methods for transforming data in `DBMS_DATA_MINING_TRANSFORM` package.

**Table 28-3 DBMS\_DATA\_MINING\_TRANSFORM Transformation Methods**

Transformation Method	Description
XFORM interface	CREATE, INSERT, and XFORM routines specify transformations in external views
STACK interface	CREATE, INSERT, and XFORM routines specify transformations for embedding in a model
SET_TRANSFORM	Specifies transformations for embedding in a model

The statements in the following example create an Support Vector Machine (SVM) Classification model called `T_SVM_Clas_sample` with an embedded transformation that causes the comments attribute to be treated as unstructured text data.

**Example 28-7 Sample Embedded Transformation**

```

DECLARE
  xformlist dbms_data_mining_transform.TRANSFORM_LIST;
BEGIN
  dbms_data_mining_transform.SET_TRANSFORM(
    xformlist, 'comments', null, 'comments', null, 'TEXT');
  DBMS_DATA_MINING.CREATE_MODEL(
    model_name          => 'T_SVM_Clas_sample',
    mining_function     => dbms_data_mining.classification,
    data_table_name     => 'mining_build_text',
    case_id_column_name => 'cust_id',
    target_column_name  => 'affinity_card',
    settings_table_name => 't_svmc_sample_settings',
    xform_list => xformlist);
END;
/

```

## 28.3.3 DBMS\_PREDICTIVE\_ANALYTICS

Understand the routines of `DBMS_PREDICTIVE_ANALYTICS` package.

The `DBMS_PREDICTIVE_ANALYTICS` package contains routines that perform an automated form of data mining known as predictive analytics. With predictive analytics, you do not need to be aware of model building or scoring. All mining activities are handled internally by the procedure. The `DBMS_PREDICTIVE_ANALYTICS` package includes these routines:

- **EXPLAIN** ranks attributes in order of influence in explaining a target column.
- **PREDICT** predicts the value of a target column based on values in the input data.
- **PROFILE** generates rules that describe the cases from the input data.

The `EXPLAIN` statement in the following example lists attributes in the view `mining_data_build_v` in order of their importance in predicting `affinity_card`.

**Example 28-8 Sample EXPLAIN Statement**

```

BEGIN
  DBMS_PREDICTIVE_ANALYTICS.EXPLAIN(
    data_table_name      => 'mining_data_build_v',
    explain_column_name  => 'affinity_card',
    result_table_name    => 'explain_results');
END;
/

```

**Related Topics**

- *Oracle Database PL/SQL Packages and Types Reference*

## 28.4 Data Mining SQL Scoring Functions

Understand the different data mining SQL scoring functions.

The Data Mining SQL language functions use Oracle Data Mining to score data. The functions can apply a mining model schema object to the data, or they can dynamically mine the data by executing an analytic clause. SQL functions are available for all the data mining algorithms that support the scoring operation. All Data Mining SQL functions, as listed in the following table can operate on R Mining Model with the corresponding mining function. However, the functions are not limited to the ones listed here.

**Table 28-4 Data Mining SQL Functions**

Function	Description
CLUSTER_ID	Returns the ID of the predicted cluster
CLUSTER_DETAILS	Returns detailed information about the predicted cluster
CLUSTER_DISTANCE	Returns the distance from the centroid of the predicted cluster
CLUSTER_PROBABILITY	Returns the probability of a case belonging to a given cluster
CLUSTER_SET	Returns a list of all possible clusters to which a given case belongs along with the associated probability of inclusion
FEATURE_COMPARE	Compares two similar and dissimilar set of texts from two different documents or keyword phrases or a combination of both
FEATURE_ID	Returns the ID of the feature with the highest coefficient value
FEATURE_DETAILS	Returns detailed information about the predicted feature
FEATURE_SET	Returns a list of objects containing all possible features along with the associated coefficients
FEATURE_VALUE	Returns the value of the predicted feature
ORA_DM_PARTITION_NAME	Returns the partition names for a partitioned model
PREDICTION	Returns the best prediction for the target
PREDICTION_BOUNDS	(GLM only) Returns the upper and lower bounds of the interval wherein the predicted values (linear regression) or probabilities (logistic regression) lie.
PREDICTION_COST	Returns a measure of the cost of incorrect predictions
PREDICTION_DETAILS	Returns detailed information about the prediction
PREDICTION_PROBABILITY	Returns the probability of the prediction
PREDICTION_SET	Returns the results of a classification model, including the predictions and associated probabilities for each case

The following example shows a query that returns the results of the `CLUSTER_ID` function. The query applies the model `em_sh_clus_sample`, which finds groups of customers that share certain characteristics. The query returns the identifiers of the clusters and the number of customers in each cluster.

**Example 28-9 CLUSTER\_ID Function**

```
-- -List the clusters into which the customers in this
-- -data set have been grouped.
--
SELECT CLUSTER_ID(em_sh_clus_sample USING *) AS clus, COUNT(*) AS cnt
  FROM mining_data_apply_v
GROUP BY CLUSTER_ID(em_sh_clus_sample USING *)
ORDER BY cnt DESC;
```

```
SQL> -- List the clusters into which the customers in this
SQL> -- data set have been grouped.
SQL> --
SQL> SELECT CLUSTER_ID(em_sh_clus_sample USING *) AS clus, COUNT(*) AS cnt
  2   FROM mining_data_apply_v
  3  GROUP BY CLUSTER_ID(em_sh_clus_sample USING *)
  4  ORDER BY cnt DESC;
```

CLUS	CNT
9	311
3	294
7	215
12	201
17	123
16	114
14	86
19	64
15	56
18	36

**Related Topics**

- [Scoring and Deployment](#)  
Explains the scoring and deployment features of Oracle Data Mining.
- *Oracle Database SQL Language Reference*

# 29

## Preparing the Data

Learn how to create a table or view that can be used to build a model.

- [Data Requirements](#)
- [About Attributes](#)
- [Using Nested Data](#)
- [Using Market Basket Data](#)
- [Using Retail Analysis Data](#)
- [Handling Missing Values](#)

### 29.1 Data Requirements

Understand how data is stored and viewed for data mining.

Data mining activities require data that is defined within a single table or view. The information for each record must be stored in a separate row. The data records are commonly called **cases**. Each case can optionally be identified by a unique **case ID**. The table or view itself can be referred to as a **case table**.

The `CUSTOMERS` table in the `SH` schema is an example of a table that could be used for mining. All the information for each customer is contained in a single row. The case ID is the `CUST_ID` column. The rows listed in the following example are selected from `SH.CUSTOMERS`.



#### Note:

Oracle Data Mining requires single-record case data for all types of models except association models, which can be built on native transactional data.

#### Example 29-1 Sample Case Table

```
SQL> select cust_id, cust_gender, cust_year_of_birth,  
           cust_main_phone_number from sh.customers where cust_id < 11;
```

CUST_ID	CUST_GENDER	CUST_YEAR_OF_BIRTH	CUST_MAIN_PHONE_NUMBER
1	M	1946	127-379-8954
2	F	1957	680-327-1419
3	M	1939	115-509-3391
4	M	1934	577-104-2792
5	M	1969	563-667-7731
6	F	1925	682-732-7260
7	F	1986	648-272-6181
8	F	1964	234-693-8728
9	F	1936	697-702-2618
10	F	1947	601-207-4099



### Related Topics

- [Using Market Basket Data](#)

## 29.1.1 Column Data Types

Understand the different types of column data in a case table.

The columns of the case table hold the attributes that describe each case. In [Example 29-1](#), the attributes are: `CUST_GENDER`, `CUST_YEAR_OF_BIRTH`, and `CUST_MAIN_PHONE_NUMBER`. The attributes are the predictors in a supervised model or the descriptors in an unsupervised model. The case ID, `CUST_ID`, can be viewed as a special attribute; it is not a predictor or a descriptor.

Oracle Data Mining supports standard Oracle data types as well as the following collection types:

```
DM_NESTED_CATEGORICALS
DM_NESTED_NUMERICALS
DM_NESTED_BINARY_DOUBLES
DM_NESTED_BINARY_FLOATS
```

### Related Topics

- [Using Nested Data](#)  
A join between the tables for one-to-many relationship is represented through nested columns.
- [Mining Unstructured Text](#)  
Explains how to use Oracle Data Mining to mine unstructured text.
- *Oracle Database SQL Language Reference*

## 29.1.2 Data Sets for Classification and Regression

Understand how data sets are used for training and testing the model.

You need two case tables to build and validate classification and regression models. One set of rows is used for training the model, another set of rows is used for testing the model. It is often convenient to derive the build data and test data from the same data set. For example, you could randomly select 60% of the rows for training the model; the remaining 40% could be used for testing the model.

Models that implement other mining functions, such as attribute importance, clustering, association, or feature extraction, do not use separate test data.

## 29.1.3 Scoring Requirements

Most data mining models can be applied to separate data in a process known as **scoring**. Oracle Data Mining supports the scoring operation for classification, regression, anomaly detection, clustering, and feature extraction.

The scoring process matches column names in the scoring data with the names of the columns that were used to build the model. The scoring process does not require all the columns to be present in the scoring data. If the data types do not match, Oracle Data Mining attempts to perform type coercion. For example, if a column called `PRODUCT_RATING` is `VARCHAR2` in the training data but `NUMBER` in the scoring data, Oracle Data Mining effectively applies a `TO_CHAR()` function to convert it.

The column in the test or scoring data must undergo the same transformations as the corresponding column in the build data. For example, if the `AGE` column in the build data was transformed from numbers to the values `CHILD`, `ADULT`, and `SENIOR`, then the `AGE` column in the scoring data must undergo the same transformation so that the model can properly evaluate it.

 **Note:**

Oracle Data Mining can embed user-specified transformation instructions in the model and reapply them whenever the model is applied. When the transformation instructions are embedded in the model, you do not need to specify them for the test or scoring data sets.

Oracle Data Mining also supports Automatic Data Preparation (ADP). When ADP is enabled, the transformations required by the algorithm are performed automatically and embedded in the model along with any user-specified transformations.

 **See Also:**

[Transforming the Data](#) for more information on automatic and embedded data transformations

## 29.2 About Attributes

Attributes are the items of data that are used in data mining. In predictive models, attributes are the predictors that affect a given outcome. In descriptive models, attributes are the items of information being analyzed for natural groupings or associations. For example, a table of employee data that contains attributes such as job title, date of hire, salary, age, gender, and so on.

### 29.2.1 Data Attributes and Model Attributes

**Data attributes** are columns in the data set used to build, test, or score a model. **Model attributes** are the data representations used internally by the model.

Data attributes and model attributes can be the same. For example, a column called `SIZE`, with values `S`, `M`, and `L`, are attributes used by an algorithm to build a model. Internally, the model attribute `SIZE` is most likely be the same as the data attribute from which it was derived.

On the other hand, a nested column `SALES_PROD`, containing the sales figures for a group of products, does not correspond to a model attribute. The data attribute can be `SALES_PROD`, but each product with its corresponding sales figure (each row in the nested column) is a model attribute.

Transformations also cause a discrepancy between data attributes and model attributes. For example, a transformation can apply a calculation to two data attributes and store the result in a new attribute. The new attribute is a model attribute that has no corresponding data attribute. Other transformations such as binning, normalization, and outlier treatment, cause the model's representation of an attribute to be different from the data attribute in the case table.

**Related Topics**

- [Using Nested Data](#)  
A join between the tables for one-to-many relationship is represented through nested columns.
- [Transforming the Data](#)  
Understand how to transform data for building a model or for scoring.

 **See Also:**

## 29.2.2 Target Attribute

Understand what a **target** means in data mining and understand the different target data types.

The **target** of a supervised model is a special kind of attribute. The target column in the training data contains the historical values used to train the model. The target column in the test data contains the historical values to which the predictions are compared. The act of scoring produces a prediction for the target.

Clustering, Feature Extraction, Association, and Anomaly Detection models do not use a target.

Nested columns and columns of unstructured data (such as `BFILE`, `CLOB`, or `BLOB`) cannot be used as targets.

**Table 29-1 Target Data Types**

Mining Function	Target Data Types
Classification	<code>VARCHAR2</code> , <code>CHAR</code>
	<code>NUMBER</code> , <code>FLOAT</code>
	<code>BINARY_DOUBLE</code> , <code>BINARY_FLOAT</code> , <code>ORA_MINING_VARCHAR2_NT</code>
Regression	<code>NUMBER</code> , <code>FLOAT</code>
	<code>BINARY_DOUBLE</code> , <code>BINARY_FLOAT</code>

You can query the `*_MINING_MODEL_ATTRIBUTES` view to find the target for a given model.

**Related Topics**

- [ALL\\_MINING\\_MODEL\\_ATTRIBUTES](#)  
Describes an example of `ALL_MINING_MODEL_ATTRIBUTES` and shows a sample query.
- *Oracle Database PL/SQL Packages and Types Reference*

## 29.2.3 Numericals, Categoricals, and Unstructured Text

Explains numeric, categorical, and unstructured text attributes.

Model attributes are numerical, categorical, or unstructured (text). Data attributes, which are columns in a case table, have Oracle data types, as described in "Column Data Types".

Numerical attributes can theoretically have an infinite number of values. The values have an implicit order, and the differences between them are also ordered. Oracle Data Mining

interprets `NUMBER`, `FLOAT`, `BINARY_DOUBLE`, `BINARY_FLOAT`, `DM_NESTED_NUMERICALS`, `DM_NESTED_BINARY_DOUBLES`, and `DM_NESTED_BINARY_FLOATS` as numerical.

Categorical attributes have values that identify a finite number of discrete categories or classes. There is no implicit order associated with the values. Some categoricals are binary: they have only two possible values, such as yes or no, or male or female. Other categoricals are multi-class: they have more than two values, such as small, medium, and large.

Oracle Data Mining interprets `CHAR` and `VARCHAR2` as categorical by default, however these columns may also be identified as columns of unstructured data (text). Oracle Data Mining interprets columns of `DM_NESTED_CATEGORICALS` as categorical. Columns of `CLOB`, `BLOB`, and `BFILE` always contain unstructured data.

The target of a classification model is categorical. (If the target of a classification model is numeric, it is interpreted as categorical.) The target of a regression model is numerical. The target of an attribute importance model is either categorical or numerical.

### Related Topics

- [Column Data Types](#)  
Understand the different types of column data in a case table.
- [Mining Unstructured Text](#)  
Explains how to use Oracle Data Mining to mine unstructured text.

## 29.2.4 Model Signature

The model signature is the set of data attributes that are used to build a model. Some or all of the attributes in the signature must be present for scoring. The model accounts for any missing columns on a best-effort basis. If columns with the same names but different data types are present, the model attempts to convert the data type. If extra, unused columns are present, they are disregarded.

The model signature does not necessarily include all the columns in the build data. Algorithm-specific criteria can cause the model to ignore certain columns. Other columns can be eliminated by transformations. Only the data attributes actually used to build the model are included in the signature.

The target and case ID columns are not included in the signature.

## 29.2.5 Scoping of Model Attribute Name

The model attribute name consists of two parts: a column name, and a subcolumn name.

```
column_name[.subcolumn_name]
```

The `column_name` component is the name of the data attribute. It is present in all model attribute names. Nested attributes and text attributes also have a `subcolumn_name` component as shown in the following example.

### Example 29-2 Model Attributes Derived from a Nested Column

The nested column `SALESPROD` has three rows.

```
SALESPROD(ATTRIBUTE_NAME, VALUE)
-----
((PROD1, 300),
 (PROD2, 245),
 (PROD3, 679))
```

The name of the data attribute is `SALESPROD`. Its associated model attributes are:

```
SALESPROD.PROD1  
SALESPROD.PROD2  
SALESPROD.PROD3
```

## 29.2.6 Model Details

Model details reveal information about model attributes and their treatment by the algorithm. Oracle recommends that users leverage the model detail views for the respective algorithm.

Transformation and reverse transformation expressions are associated with model attributes. Transformations are applied to the data attributes before the algorithmic processing that creates the model. Reverse transformations are applied to the model attributes after the model has been built, so that the model details are expressed in the form of the original data attributes, or as close to it as possible.

Reverse transformations support model transparency. They provide a view of the data that the algorithm is working with internally but in a format that is meaningful to a user.

### Deprecated `GET_MODEL_DETAILS`

There is a separate `GET_MODEL_DETAILS` routine for each algorithm. Starting from Oracle Database 12c Release 2, the `GET_MODEL_DETAILS` are deprecated. Oracle recommends to use Model Detail Views for the respective algorithms.

### Related Topics

- [Model Detail Views](#)  
The `GET_*` interfaces are replaced by model views, and Oracle recommends that users leverage the views instead.

## 29.3 Using Nested Data

A join between the tables for one-to-many relationship is represented through nested columns.

Oracle Data Mining requires a case table in single-record case format, with each record in a separate row. What if some or all of your data is in multi-record case format, with each record in several rows? What if you want one attribute to represent a series or collection of values, such as a student's test scores or the products purchased by a customer?

This kind of one-to-many relationship is usually implemented as a join between tables. For example, you can join your customer table to a sales table and thus associate a list of products purchased with each customer.

Oracle Data Mining supports dimensioned data through nested columns. To include dimensioned data in your case table, create a view and cast the joined data to one of the Data Mining nested table types. Each row in the nested column consists of an attribute name/value pair. Oracle Data Mining internally processes each nested row as a separate attribute.



### Note:

O-Cluster is the only algorithm that does not support nested data.

**Related Topics**

- [Example: Creating a Nested Column for Market Basket Analysis](#)  
The example shows how to define a nested column for market basket analysis.

## 29.3.1 Nested Object Types

Nested tables are object data types that can be used in place of other data types.

Oracle Database supports user-defined data types that make it possible to model real-world entities as objects in the database. **Collection types** are object data types for modeling multi-valued attributes. Nested tables are collection types. Nested tables can be used anywhere that other data types can be used.

Oracle Data Mining supports the following nested object types:

```
DM_NESTED_BINARY_DOUBLES
DM_NESTED_BINARY_FLOATS
DM_NESTED_NUMERICALS
DM_NESTED_CATEGORICALS
```

Descriptions of the nested types are provided in this example.

**Example 29-3 Oracle Data Mining Nested Data Types**

```
describe dm_nested_binary_double
Name                                     Null?   Type
-----
ATTRIBUTE_NAME                           VARCHAR2(4000)
VALUE                                     BINARY_DOUBLE

describe dm_nested_binary_doubles
DM_NESTED_BINARY_DOUBLES TABLE OF SYS.DM_NESTED_BINARY_DOUBLE
Name                                     Null?   Type
-----
ATTRIBUTE_NAME                           VARCHAR2(4000)
VALUE                                     BINARY_DOUBLE

describe dm_nested_binary_float
Name                                     Null?   Type
-----
ATTRIBUTE_NAME                           VARCHAR2(4000)
VALUE                                     BINARY_FLOAT

describe dm_nested_binary_floats
DM_NESTED_BINARY_FLOATS TABLE OF SYS.DM_NESTED_BINARY_FLOAT
Name                                     Null?   Type
-----
ATTRIBUTE_NAME                           VARCHAR2(4000)
VALUE                                     BINARY_FLOAT

describe dm_nested_numerical
Name                                     Null?   Type
-----
ATTRIBUTE_NAME                           VARCHAR2(4000)
VALUE                                     NUMBER

describe dm_nested_numericals
DM_NESTED_NUMERICALS TABLE OF SYS.DM_NESTED_NUMERICAL
Name                                     Null?   Type
```

```

-----
ATTRIBUTE_NAME          VARCHAR2 (4000)
VALUE                   NUMBER

describe dm_nested_categorical
Name                    Null?    Type
-----
ATTRIBUTE_NAME          VARCHAR2 (4000)
VALUE                   VARCHAR2 (4000)

describe dm_nested_categoricals
DM_NESTED_CATEGORICALS TABLE OF SYS.DM_NESTED_CATEGORICAL
Name                    Null?    Type
-----
ATTRIBUTE_NAME          VARCHAR2 (4000)
VALUE                   VARCHAR2 (4000)

```

### Related Topics

- *Oracle Database Object-Relational Developer's Guide*

## 29.3.2 Example: Transforming Transactional Data for Mining

[Example 29-4](#) shows data from a view of a sales table. It includes sales for three of the many products sold in four regions. This data is not suitable for mining at the product level because sales for each case (product), is stored in several rows.

[Example 29-5](#) shows how this data can be transformed for mining. The case ID column is PRODUCT. SALES\_PER\_REGION, a nested column of type DM\_NESTED\_NUMERICALS, is a data attribute. This table is suitable for mining at the product case level, because the information for each case is stored in a single row.

Oracle Data Mining treats each nested row as a separate model attribute, as shown in [Example 29-6](#).



### Note:

The presentation in this example is conceptual only. The data is not actually pivoted before being processed.

### Example 29-4 Product Sales per Region in Multi-Record Case Format

PRODUCT	REGION	SALES
Prod1	NE	556432
Prod2	NE	670155
Prod3	NE	3111
.		
Prod1	NW	90887
Prod2	NW	100999
Prod3	NW	750437
.		
Prod1	SE	82153
Prod2	SE	57322
Prod3	SE	28938
.		

```
.
Prod1      SW      3297551
Prod2      SW      4972019
Prod3      SW      884923
.
```

**Example 29-5 Product Sales per Region in Single-Record Case Format**

```
PRODUCT      SALES_PER_REGION
              (ATTRIBUTE_NAME, VALUE)
-----
Prod1      ('NE' ,      556432)
              ('NW' ,      90887)
              ('SE' ,      82153)
              ('SW' ,      3297551)
Prod2      ('NE' ,      670155)
              ('NW' ,      100999)
              ('SE' ,      57322)
              ('SW' ,      4972019)
Prod3      ('NE' ,      3111)
              ('NW' ,      750437)
              ('SE' ,      28938)
              ('SW' ,      884923)
.
```

**Example 29-6 Model Attributes Derived From SALES\_PER\_REGION**

```
PRODUCT      SALES_PER_REGION.NE      SALES_PER_REGION.NW      SALES_PER_REGION.SE      SALES_PER_REGION.SW
-----
Prod1      556432      90887      82153      3297551
Prod2      670155      100999      57322      4972019
Prod3      3111      750437      28938      884923
.
```

## 29.4 Using Market Basket Data

Market basket data identifies the items sold in a set of baskets or transactions. Oracle Data Mining provides the association mining function for market basket analysis.

Association models use the Apriori algorithm to generate association rules that describe how items tend to be purchased in groups. For example, an association rule can assert that people who buy peanut butter are 80% likely to also buy jelly.

Market basket data is usually **transactional**. In transactional data, a case is a transaction and the data for a transaction is stored in multiple rows. Oracle Data Mining association models can be built on transactional data or on single-record case data. The `ODMS_ITEM_ID_COLUMN_NAME` and `ODMS_ITEM_VALUE_COLUMN_NAME` settings specify whether the data for association rules is in transactional format.

 **Note:**

Association models are the only type of model that can be built on native transactional data. For all other types of models, Oracle Data Mining requires that the data be presented in single-record case format.



The Apriori algorithm assumes that the data is transactional and that it has many missing values. Apriori interprets all missing values as sparse data, and it has its own native mechanisms for handling sparse data.

### See Also:

*Oracle Database PL/SQL Packages and Types Reference* for information on the `ODMS_ITEM_ID_COLUMN_NAME` and `ODMS_ITEM_VALUE_COLUMN_NAME` settings.

## 29.4.1 Example: Creating a Nested Column for Market Basket Analysis

The example shows how to define a nested column for market basket analysis.

Association models can be built on native transactional data or on nested data. The following example shows how to define a nested column for market basket analysis.

The following SQL statement transforms this data to a column of type `DM_NESTED_NUMERICALS` in a view called `SALES_TRANS_CUST_NESTED`. This view can be used as a case table for mining.

```
CREATE VIEW sales_trans_cust_nested AS
  SELECT trans_id,
         CAST(COLLECT(DM_NESTED_NUMERICAL(
                     prod_name, 1))
              AS DM_NESTED_NUMERICALS) custprods
  FROM sales_trans_cust
  GROUP BY trans_id;
```

This query returns two rows from the transformed data.

```
SELECT * FROM sales_trans_cust_nested
  WHERE trans_id < 101000
     AND trans_id > 100997;

TRANS_ID  CUSTPRODS(ATTRIBUTE_NAME, VALUE)
-----
100998    DM_NESTED_NUMERICALS
          (DM_NESTED_NUMERICAL('O/S Documentation Set - English', 1)
100999    DM_NESTED_NUMERICALS
          (DM_NESTED_NUMERICAL('CD-RW, High Speed Pack of 5', 1),
           DM_NESTED_NUMERICAL('External 8X CD-ROM', 1),
           DM_NESTED_NUMERICAL('SIMM- 16MB PCMCIAII card', 1))
```

### Example 29-7 Convert to a Nested Column

The view `SALES_TRANS_CUST` provides a list of transaction IDs to identify each market basket and a list of the products in each basket.

```
describe sales_trans_cust
Name                                                    Null?    Type
-----
TRANS_ID                                               NOT NULL NUMBER
PROD_NAME                                              NOT NULL VARCHAR2(50)
QUANTITY                                               NUMBER
```

### Related Topics

- [Handling Missing Values](#)

## 29.5 Using Retail Analysis Data

Retail analysis often makes use of Association Rules and Association models.

The Association Rules are enhanced to calculate aggregates along with rules or itemsets.

### Related Topics

- *Oracle Data Mining Concepts*

### 29.5.1 Example: Calculating Aggregates

The following example shows the concept of Aggregates.

#### Calculating Aggregates for Grocery Store Data

Assume a grocery store has the following data:

**Table 29-2 Grocery Store Data**

Customer	Item A	Item B	Item C	Item D
Customer 1	Buys (Profit \$5.00)	Buys (Profit \$3.20)	Buys (Profit \$12.00)	NA
Customer 2	Buys (Profit \$4.00)	NA	Buys (Profit \$4.20)	NA
Customer 3	Buys (Profit \$3.00)	Buys (Profit \$10.00)	Buys (Profit \$14.00)	Buys (Profit \$8.00)
Customer 4	Buys (Profit \$2.00)	NA	NA	Buys (Profit \$1.00)

The basket of each customer can be viewed as a transaction. The manager of the store is interested in not only the existence of certain association rules, but also in the aggregated profit if such rules exist.

In this example, one of the association rules can be  $(A, B) \Rightarrow C$  for customer 1 and customer 3. Together with this rule, the store manager may want to know the following:

- The total profit of item A appearing in this rule
- The total profit of item B appearing in this rule
- The total profit for consequent C appearing in this rule
- The total profit of all items appearing in the rule

For this rule, the profit for item A is  $\$5.00 + \$3.00 = \$8.00$ , for item B the profit is  $\$3.20 + \$10.00 = \$13.20$ , for consequent C, the profit is  $\$12.00 + \$14.00 = \$26.00$ , for the antecedent itemset (A, B) is  $\$8.00 + \$13.20 = \$21.20$ . For the whole rule, the profit is  $\$21.20 + \$26.00 = \$47.40$ .

### Related Topics

- *Oracle Database PL/SQL Packages and Types Reference*

## 29.6 Handling Missing Values

Oracle Data Mining distinguishes between **sparse data** and data that contains **random missing values**. The latter means that some attribute values are unknown. Sparse data, on

the other hand, contains values that are assumed to be known, although they are not represented in the data.

A typical example of sparse data is market basket data. Out of hundreds or thousands of available items, only a few are present in an individual case (the basket or transaction). All the item values are known, but they are not all included in the basket. Present values have a quantity, while the items that are not represented are sparse (with a known quantity of zero).

Oracle Data Mining interprets missing data as follows:

- Missing at random: Missing values in columns with a simple data type (not nested) are assumed to be missing at random.
- Sparse: Missing values in nested columns indicate sparsity.

## 29.6.1 Examples: Missing Values or Sparse Data?

The examples in this section illustrate how Oracle Data Mining identifies data as either sparse or missing at random.

### 29.6.1.1 Sparsity in a Sales Table

A sales table contains point-of-sale data for a group of products that are sold in several stores to different customers over a period of time. A particular customer buys only a few of the products. The products that the customer does not buy do not appear as rows in the sales table.

If you were to figure out the amount of money a customer has spent for each product, the unpurchased products have an inferred amount of zero. The value is not random or unknown; it is zero, even though no row appears in the table.

Note that the sales data is dimensioned (by product, stores, customers, and time) and are often represented as nested data for mining.

Since missing values in a nested column always indicate sparsity, you must ensure that this interpretation is appropriate for the data that you want to mine. For example, when trying to mine a multi-record case data set containing movie ratings from users of a large movie database, the missing ratings are unknown (missing at random), but Oracle Data Mining treats the data as sparse and infer a rating of zero for the missing value.

### 29.6.1.2 Missing Values in a Table of Customer Data

A table of customer data contains demographic data about customers. The case ID column is the customer ID. The attributes are age, education, profession, gender, house-hold size, and so on. Not all the data is available for each customer. Any missing values are considered to be missing at random. For example, if the age of customer 1 and the profession of customer 2 are not present in the data, that information is simply unknown. It does not indicate sparsity.

Note that the customer data is not dimensioned. There is a one-to-one mapping between the case and each of its attributes. None of the attributes are nested.

## 29.6.2 Missing Value Treatment in Oracle Data Mining

Missing value treatment depends on the algorithm and on the nature of the data (categorical or numerical, sparse or missing at random). Missing value treatment is summarized in the following table.



**Note:**

Oracle Data Mining performs the same missing value treatment whether or not Automatic Data Preparation is being used.

**Table 29-3 Missing Value Treatment by Algorithm**

Missing Data	EM, GLM, NMF, k-Means, SVD, SVM	DT, MDL, NB, OC	Apriori
NUMERICAL missing at random	The algorithm replaces missing numerical values with the mean. For Expectation Maximization (EM), the replacement only occurs in columns that are modeled with Gaussian distributions.	The algorithm handles missing values naturally as missing at random.	The algorithm interprets all missing data as sparse.
CATEGORICAL missing at random	Generalized Linear Models (GLM), Non-Negative Matrix Factorization (NMF), <i>k</i> -Means, and Support Vector Machine (SVM) replaces missing categorical values with the mode. Singular Value Decomposition (SVD) does not support categorical data. EM does not replace missing categorical values. EM treats NULLs as a distinct value with its own frequency count.	The algorithm handles missing values naturally as missing random.	The algorithm interprets all missing data as sparse.
NUMERICAL sparse	The algorithm replaces sparse numerical data with zeros.	O-Cluster does not support nested data and therefore does not support sparse data. Decision Tree (DT), Minimum Description Length (MDL), and Naive Bayes (NB) and replace sparse numerical data with zeros.	The algorithm handles sparse data.
CATEGORICAL sparse	All algorithms except SVD replace sparse categorical data with zero vectors. SVD does not support categorical data.	O-Cluster does not support nested data and therefore does not support sparse data. DT, MDL, and NB replace sparse categorical data with the special value <code>DM\$SPARSE</code> .	The algorithm handles sparse data.

### 29.6.3 Changing the Missing Value Treatment

Transform the missing data as sparse or missing at random.

If you want Oracle Data Mining to treat missing data as sparse instead of missing at random or missing at random instead of sparse, transform it before building the model.

If you want missing values to be treated as sparse, but Oracle Data Mining interprets them as missing at random, you can use a SQL function like `NVL` to replace the nulls with a value such

as "NA". Oracle Data Mining does not perform missing value treatment when there is a specified value.

If you want missing nested attributes to be treated as missing at random, you can transform the nested rows into physical attributes in separate columns — as long as the case table stays within the 1000 column limitation imposed by the Database. Fill in all of the possible attribute names, and specify them as null. Alternatively, insert rows in the nested column for all the items that are not present and assign a value such as the mean or mode to each one.

**Related Topics**

- *Oracle Database SQL Language Reference*

# Transforming the Data

Understand how to transform data for building a model or for scoring.

- [About Transformations](#)
- [Preparing the Case Table](#)
- [Understanding Automatic Data Preparation](#)
- [Embedding Transformations in a Model](#)
- [Understanding Reverse Transformations](#)

## 30.1 About Transformations

Understand how you can transform data by using Automatic Data Preparation (ADP) and embedded data transformation.

A transformation is a SQL expression that modifies the data in one or more columns. Data must typically undergo certain transformations before it can be used to build a model. Many data mining algorithms have specific transformation requirements. Before data can be scored, it must be transformed in the same way that the training data was transformed.

Oracle Data Mining supports Automatic Data Preparation (ADP), which automatically implements the transformations required by the algorithm. The transformations are embedded in the model and automatically executed whenever the model is applied.

If additional transformations are required, you can specify them as SQL expressions and supply them as input when you create the model. These transformations are embedded in the model just as they are with ADP.

With automatic and embedded data transformation, most of the work of data preparation is handled for you. You can create a model and score multiple data sets in just a few steps:

1. Identify the columns to include in the case table.
2. Create nested columns if you want to include transactional data.
3. Write SQL expressions for any transformations not handled by ADP.
4. Create the model, supplying the SQL expressions (if specified) and identifying any columns that contain text data.
5. Ensure that some or all of the columns in the scoring data have the same name and type as the columns used to train the model.

### Related Topics

- [Scoring Requirements](#)

## 30.2 Preparing the Case Table

Understand why you have to prepare a case table.

The first step in preparing data for mining is the creation of a case table. If all the data resides in a single table and all the information for each case (record) is included in a single row (single-record case), this process is already taken care of. If the data resides in several tables, creating the data source involves the creation of a view. For the sake of simplicity, the term "case table" is used here to refer to either a table or a view.

### Related Topics

- [Preparing the Data](#)  
Learn how to create a table or view that can be used to build a model.

### 30.2.1 Creating Nested Columns

Learn when to create nested columns.

When the data source includes transactional data (multi-record case), the transactions must be aggregated to the case level in nested columns. In transactional data, the information for each case is contained in multiple rows. An example is sales data in a star schema when mining at the product level. Sales is stored in many rows for a single product (the case) since the product is sold in many stores to many customers over a period of time.



#### See Also:

[Using Nested Data](#) for information about converting transactional data to nested columns

### 30.2.2 Converting Column Data Types

You must convert the data type of a column if its type causes Oracle Data Mining to interpret it incorrectly. For example, zip codes identify different postal zones; they do not imply order. If the zip codes are stored in a numeric column, they are interpreted as a numeric attribute. You must convert the data type so that the column data can be used as a categorical attribute by the model. You can do this using the `TO_CHAR` function to convert the digits 1-9 and the `LPAD` function to retain the leading 0, if there is one.

```
LPAD(TO_CHAR(ZIPCODE), 5, '0')
```

### 30.2.3 Text Transformation

You can use Oracle Data Mining to mine text. Columns of text in the case table can be mined once they have undergone the proper transformation.

The text column must be in a table, not a view. The transformation process uses several features of Oracle Text; it treats the text in each row of the table as a separate document. Each document is transformed to a set of text tokens known as **terms**, which have a numeric value and a text label. The text column is transformed to a nested column of `DM_NESTED_NUMERICALS`.

## 30.2.4 About Business and Domain-Sensitive Transformations

Understand why you need to transform data according to business problems.

Some transformations are dictated by the definition of the business problem. For example, you want to build a model to predict high-revenue customers. Since your revenue data for current customers is in dollars you need to define what "high-revenue" means. Using some formula that you have developed from past experience, you can recode the revenue attribute into ranges Low, Medium, and High before building the model.

Another common business transformation is the conversion of date information into elapsed time. For example, date of birth can be converted to age.

Domain knowledge can be very important in deciding how to prepare the data. For example, some algorithms produce unreliable results if the data contains values that fall far outside of the normal range. In some cases, these values represent errors or abnormalities. In others, they provide meaningful information.

### Related Topics

- [Outlier Treatment](#)

## 30.3 Understanding Automatic Data Preparation

Understand data transformation using Automatic Data Preparation (ADP).

Most algorithms require some form of data transformation. During the model build process, Oracle Data Mining can automatically perform the transformations required by the algorithm. You can choose to supplement the automatic transformations with additional transformations of your own, or you can choose to manage all the transformations yourself.

In calculating automatic transformations, Oracle Data Mining uses heuristics that address the common requirements of a given algorithm. This process results in reasonable model quality in most cases.

Binning and normalization are transformations that are commonly needed by data mining algorithms.

### Related Topics

- *Oracle Database PL/SQL Packages and Types Reference*

### 30.3.1 Binning

Binning, also called discretization, is a technique for reducing the cardinality of continuous and discrete data. Binning groups related values together in bins to reduce the number of distinct values.

Binning can improve resource utilization and model build response time dramatically without significant loss in model quality. Binning can improve model quality by strengthening the relationship between attributes.

Supervised binning is a form of intelligent binning in which important characteristics of the data are used to determine the bin boundaries. In supervised binning, the bin boundaries are identified by a single-predictor decision tree that takes into account the joint distribution with the target. Supervised binning can be used for both numerical and categorical attributes.



## 30.3.2 Normalization

Normalization is the most common technique for reducing the range of numerical data. Most normalization methods map the range of a single variable to another range (often 0,1).

## 30.3.3 How ADP Transforms the Data

The following table shows how ADP prepares the data for each algorithm.

**Table 30-1 Oracle Data Mining Algorithms With ADP**

Algorithm	Mining Function	Treatment by ADP
Apriori	Association Rules	ADP has no effect on association rules.
Decision Tree	Classification	ADP has no effect on Decision Tree. Data preparation is handled by the algorithm.
Expectation Maximization	Clustering	Single-column (not nested) numerical columns that are modeled with Gaussian distributions are normalized. ADP has no effect on the other types of columns.
GLM	Classification and Regression	Numerical attributes are normalized.
k-Means	Clustering	Numerical attributes are normalized.
MDL	Attribute Importance	All attributes are binned with supervised binning.
Naive Bayes	Classification	All attributes are binned with supervised binning.
NMF	Feature Extraction	Numerical attributes are normalized.
O-Cluster	Clustering	Numerical attributes are binned with a specialized form of equi-width binning, which computes the number of bins per attribute automatically. Numerical columns with all nulls or a single value are removed.
SVD	Feature Extraction	Numerical attributes are normalized.
SVM	Classification, Anomaly Detection, and Regression	Numerical attributes are normalized.



### See Also:

- *Oracle Database PL/SQL Packages and Types Reference*
- Part III of *Oracle Data Mining Concepts* for more information about algorithm-specific data preparation

## 30.4 Embedding Transformations in a Model

You can specify your own transformations and embed them in a model by creating a transformation list and passing it to `DBMS_DATA_MINING.CREATE_MODEL`.

```
PROCEDURE create_model(
    model_name           IN VARCHAR2,
    mining_function      IN VARCHAR2,
    data_table_name      IN VARCHAR2,
    case_id_column_name  IN VARCHAR2,
    target_column_name   IN VARCHAR2 DEFAULT NULL,
```

```
settings_table_name IN VARCHAR2 DEFAULT NULL,
data_schema_name   IN VARCHAR2 DEFAULT NULL,
settings_schema_name IN VARCHAR2 DEFAULT NULL,
xform_list        IN TRANSFORM_LIST DEFAULT NULL);
```

## 30.4.1 Specifying Transformation Instructions for an Attribute

Learn what is a transformation instruction for an attribute and learn about the fields in a transformation record.

A transformation list is defined as a table of transformation records. Each record (`transform_rec`) specifies the transformation instructions for an attribute.

```
TYPE transform_rec IS RECORD (
  attribute_name      VARCHAR2(30),
  attribute_subname   VARCHAR2(4000),
  expression          EXPRESSION_REC,
  reverse_expression  EXPRESSION_REC,
  attribute_spec      VARCHAR2(4000));
```

The fields in a transformation record are described in this table.

**Table 30-2 Fields in a Transformation Record for an Attribute**

Field	Description
<code>attribute_name</code> and <code>attribute_subname</code>	These fields identify the attribute, as described in "Scoping of Model Attribute Name"
<code>expression</code>	<p>A SQL expression for transforming the attribute. For example, this expression transforms the age attribute into two categories: child and adult:[0,19) for 'child' and [19,) for adult</p> <pre>CASE WHEN age &lt; 19 THEN 'child' ELSE 'adult'</pre> <p>Expression and reverse expressions are stored in <code>expression_rec</code> objects. See "Expression Records" for details.</p>
<code>reverse_expression</code>	<p>A SQL expression for reversing the transformation. For example, this expression reverses the transformation of the age attribute:</p> <pre>DECODE(age, 'child', '(-Inf,19)', '[19,Inf)')</pre>
<code>attribute_spec</code>	<p>Specifies special treatment for the attribute. The <code>attribute_spec</code> field can be null or it can have one or more of these values:</p> <ul style="list-style-type: none"> <li><b>FORCE_IN</b> — For GLM, forces the inclusion of the attribute in the model build when the <code>ftr_selection_enable</code> setting is enabled. (<code>ftr_selection_enable</code> is disabled by default.) If the model is not using GLM, this value has no effect. <b>FORCE_IN</b> cannot be specified for nested attributes or text.</li> <li><b>NOPREP</b> — When ADP is on, prevents automatic transformation of the attribute. If ADP is not on, this value has no effect. You can specify <b>NOPREP</b> for a nested attribute, but not for an individual subname (row) in the nested attribute.</li> <li><b>TEXT</b> — Indicates that the attribute contains unstructured text. ADP has no effect on this setting. <b>TEXT</b> may optionally include subsettings <code>POLICY_NAME</code>, <code>TOKEN_TYPE</code>, and <code>MAX_FEATURES</code>.</li> </ul> <p>See <a href="#">Example 30-1</a> and <a href="#">Example 30-2</a>.</p>

**Related Topics**

- [Scoping of Model Attribute Name](#)
- [Expression Records](#)

### 30.4.1.1 Expression Records

The transformation expressions in a transformation record are `expression_rec` objects.

```
TYPE expression_rec IS RECORD (
    lstmt          DBMS_SQL.VARCHAR2A,
    lb             BINARY_INTEGER DEFAULT 1,
    ub             BINARY_INTEGER DEFAULT 0);
```

```
TYPE varchar2a IS TABLE OF VARCHAR2(32767)
INDEX BY BINARY_INTEGER;
```

The `lstmt` field stores a `VARCHAR2A`, which allows transformation expressions to be very long, as they can be broken up across multiple rows of `VARCHAR2`. Use the `DBMS_DATA_MINING_TRANSFORM.SET_EXPRESSION` procedure to create an `expression_rec`.

### 30.4.1.2 Attribute Specifications

Learn how to define the characteristics specific to an attribute through attribute specification.

The attribute specification in a transformation record defines characteristics that are specific to this attribute. If not null, the attribute specification can include values `FORCE_IN`, `NOPREP`, or `TEXT`, as described in [Table 30-2](#).

**Example 30-1 An Attribute Specification with Multiple Keywords**

If more than one attribute specification keyword is applicable, you can provide them in a comma-delimited list. The following expression is the specification for an attribute in a GLM model. Assuming that the `ftr_selection_enable` setting is enabled, this expression forces the attribute to be included in the model. If ADP is on, automatic transformation of the attribute is not performed.

```
"FORCE_IN,NOPREP"
```

**Example 30-2 A Text Attribute Specification**

For text attributes, you can optionally specify subsettings `POLICY_NAME`, `TOKEN_TYPE`, and `MAX_FEATURES`. The subsettings provide configuration information that is specific to text transformation. In this example, the transformation instructions for the text content are defined in a text policy named `my_policy` with token type is `THEME`. The maximum number of extracted features is 3000.

```
"TEXT(POLICY_NAME:my_policy)(TOKEN_TYPE:THEME)(MAX_FEATURES:3000)"
```

**Related Topics**

- [Configuring a Text Attribute](#)  
Learn how to identify a column as a text attribute and provide transformation instructions for any text attribute.

## 30.4.2 Building a Transformation List

A transformation list is a collection of transformation records. When a new transformation record is added, it is appended to the top of the transformation list. You can use any of the following methods to build a transformation list:

- The `SET_TRANSFORM` procedure in `DBMS_DATA_MINING_TRANSFORM`
- The `STACK` interface in `DBMS_DATA_MINING_TRANSFORM`
- The `GET_MODEL_TRANSFORMATIONS` and `GET_TRANSFORM_LIST` functions in `DBMS_DATA_MINING`

### 30.4.2.1 SET\_TRANSFORM

The `SET_TRANSFORM` procedure adds a single transformation record to a transformation list.

```
DBMS_DATA_MINING_TRANSFORM.SET_TRANSFORM (  
    xform_list           IN OUT NOCOPY TRANSFORM_LIST,  
    attribute_name      VARCHAR2,  
    attribute_subname   VARCHAR2,  
    expression          VARCHAR2,  
    reverse_expression  VARCHAR2,  
    attribute_spec      VARCHAR2 DEFAULT NULL);
```

SQL expressions that you specify with `SET_TRANSFORM` must fit within a `VARCHAR2`. To specify a longer expression, you can use the `SET_EXPRESSION` procedure, which builds an expression by appending rows to a `VARCHAR2` array.

### 30.4.2.2 The STACK Interface

The `STACK` interface creates transformation records from a table of transformation instructions and adds them to a transformation list.

The `STACK` interface specifies that all or some of the attributes of a given type must be transformed in the same way. For example, `STACK_BIN_CAT` appends binning instructions for categorical attributes to a transformation list. The `STACK` interface consists of three steps:

1. A `CREATE` procedure creates a transformation definition table. For example, `CREATE_BIN_CAT` creates a table to hold categorical binning instructions. The table has columns for storing the name of the attribute, the value of the attribute, and the bin assignment for the value.
2. An `INSERT` procedure computes the bin boundaries for one or more attributes and populates the definition table. For example, `INSERT_BIN_CAT_FREQ` performs frequency-based binning on some or all of the categorical attributes in the data source and populates a table created by `CREATE_BIN_CAT`.
3. A `STACK` procedure creates transformation records from the information in the definition table and appends the transformation records to a transformation list. For example, `STACK_BIN_CAT` creates transformation records for the information stored in a categorical binning definition table and appends the transformation records to a transformation list.

### 30.4.2.3 GET\_MODEL\_TRANSFORMATIONS and GET\_TRANSFORM\_LIST

Use the functions to create a new transformation list.

These two functions can be used to create a new transformation list from the transformations embedded in an existing model.

The `GET_MODEL_TRANSFORMATIONS` function returns a list of embedded transformations.

```
DBMS_DATA_MINING.GET_MODEL_TRANSFORMATIONS (
    model_name      IN VARCHAR2)
RETURN DM_TRANSFORMS PIPELINED;
```

`GET_MODEL_TRANSFORMATIONS` returns a table of `dm_transform` objects. Each `dm_transform` has these fields

```
attribute_name      VARCHAR2(4000)
attribute_subname   VARCHAR2(4000)
expression          CLOB
reverse_expression  CLOB
```

The components of a transformation list are `transform_rec`, not `dm_transform`. The fields of a `transform_rec` are described in [Table 30-2](#). You can call `GET_MODEL_TRANSFORMATIONS` to convert a list of `dm_transform` objects to `transform_rec` objects and append each `transform_rec` to a transformation list.

```
DBMS_DATA_MINING.GET_TRANSFORM_LIST (
    xform_list      OUT NOCOPY TRANSFORM_LIST,
    model_xforms    IN  DM_TRANSFORMS);
```

#### See Also:

"DBMS\_DATA\_MINING\_TRANSFORM Operational Notes", "SET\_TRANSFORM Procedure", "CREATE\_MODEL Procedure", and "GET\_MODEL\_TRANSFORMATIONS Function" in *Oracle Database PL/SQL Packages and Types Reference*

## 30.4.3 Transformation Lists and Automatic Data Preparation

If you enable ADP and you specify a transformation list, the transformation list is embedded with the automatic, system-generated transformations. The transformation list is executed before the automatic transformations.

If you enable ADP and do not specify a transformation list, only the automatic transformations are embedded in the model.

If ADP is disabled (the default) and you specify a transformation list, your custom transformations are embedded in the model. No automatic transformations are performed.

If ADP is disabled (the default) and you do not specify a transformation list, no transformations are embedded in the model. You have to transform the training, test, and scoring data sets yourself if necessary. You must take care to apply the same transformations to each data set.

## 30.4.4 Oracle Data Mining Transformation Routines

Learn about transformation routines.

Oracle Data Mining provides routines that implement various transformation techniques in the `DBMS_DATA_MINING_TRANSFORM` package.

### Related Topics

- [Oracle Database SQL Language Reference](#)

### 30.4.4.1 Binning Routines

Explains Binning techniques in Oracle Data Mining.

A number of factors go into deciding a binning strategy. Having fewer values typically leads to a more compact model and one that builds faster, but it can also lead to some loss in accuracy.

Model quality can improve significantly with well-chosen bin boundaries. For example, an appropriate way to bin ages is to separate them into groups of interest, such as children 0-13, teenagers 13-19, youth 19-24, working adults 24-35, and so on.

The following table lists the binning techniques provided by Oracle Data Mining:

**Table 30-3 Binning Methods in DBMS\_DATA\_MINING\_TRANSFORM**

Binning Method	Description
Top-N Most Frequent Items	You can use this technique to bin categorical attributes. You specify the number of bins. The value that occurs most frequently is labeled as the first bin, the value that appears with the next frequency is labeled as the second bin, and so on. All remaining values are in an additional bin.
Supervised Binning	Supervised binning is a form of intelligent binning, where bin boundaries are derived from important characteristics of the data. Supervised binning builds a single-predictor decision tree to find the interesting bin boundaries with respect to a target. It can be used for numerical or categorical attributes.
Equi-Width Binning	You can use equi-width binning for numerical attributes. The range of values is computed by subtracting the minimum value from the maximum value, then the range of values is divided into equal intervals. You can specify the number of bins or it can be calculated automatically. Equi-width binning must usually be used with outlier treatment.
Quantile Binning	Quantile binning is a numerical binning technique. Quantiles are computed using the SQL analytic function <code>NTILE</code> . The bin boundaries are based on the minimum values for each quantile. Bins with equal left and right boundaries are collapsed, possibly resulting in fewer bins than requested.

### Related Topics

- [Routines for Outlier Treatment](#)

### 30.4.4.2 Normalization Routines

Learn about Normalization routines in Oracle Data Mining.

Most normalization methods map the range of a single attribute to another range, typically 0 to 1 or -1 to +1.

Normalization is very sensitive to outliers. Without outlier treatment, most values are mapped to a tiny range, resulting in a significant loss of information.

**Table 30-4 Normalization Methods in DBMS\_DATA\_MINING\_TRANSFORM**

Transformation	Description
Min-Max Normalization	This technique computes the normalization of an attribute using the minimum and maximum values. The shift is the minimum value, and the scale is the difference between the maximum and minimum values.
Scale Normalization	This normalization technique also uses the minimum and maximum values. For scale normalization, shift = 0, and scale = $\max\{\text{abs}(\text{max}), \text{abs}(\text{min})\}$ .
Z-Score Normalization	This technique computes the normalization of an attribute using the mean and the standard deviation. Shift is the mean, and scale is the standard deviation.

#### Related Topics

- [Routines for Outlier Treatment](#)

### 30.4.4.3 Outlier Treatment

A value is considered an outlier if it deviates significantly from most other values in the column. The presence of outliers can have a skewing effect on the data and can interfere with the effectiveness of transformations such as normalization or binning.

Outlier treatment methods such as trimming or clipping can be implemented to minimize the effect of outliers.

Outliers represent problematic data, for example, a bad reading due to the abnormal condition of an instrument. However, in some cases, especially in the business arena, outliers are perfectly valid. For example, in census data, the earnings for some of the richest individuals can vary significantly from the general population. Do not treat this information as an outlier, since it is an important part of the data. You need domain knowledge to determine outlier handling.

### 30.4.4.4 Routines for Outlier Treatment

**Outliers** are extreme values, typically several standard deviations from the mean. To minimize the effect of outliers, you can Winsorize or trim the data.

**Winsorizing** involves setting the tail values of an attribute to some specified value. For example, for a 90% Winsorization, the bottom 5% of values are set equal to the minimum value in the 5th percentile, while the upper 5% of values are set equal to the maximum value in the 95th percentile.

**Trimming** sets the tail values to NULL. The algorithm treats them as missing values.

Outliers affect the different algorithms in different ways. In general, outliers cause distortion with equi-width binning and min-max normalization.

**Table 30-5 Outlier Treatment Methods in DBMS\_DATA\_MINING\_TRANSFORM**

Transformation	Description
Trimming	This technique trims the outliers in numeric columns by sorting the non-null values, computing the tail values based on some fraction, and replacing the tail values with nulls.
Windsorizing	This technique trims the outliers in numeric columns by sorting the non-null values, computing the tail values based on some fraction, and replacing the tail values with some specified value.

## 30.5 Understanding Reverse Transformations

Understand why you need reverse transformations.

Reverse transformations ensure that information returned by the model is expressed in a format that is similar to or the same as the format of the data that was used to train the model. Internal transformation are reversed in the model details and in the results of scoring.

Some of the attributes used by the model correspond to columns in the build data. However, because of logic specific to the algorithm, nested data, and transformations, some attributes donot correspond to columns.

For example, a nested column in the training data is not interpreted as an attribute by the model. During the model build, Oracle Data Mining explodes nested columns, and each row (an attribute name/value pair) becomes an attribute.

Some algorithms, for example Support Vector Machines (SVM) and Generalized Linear Models (GLM), only operate on numeric attributes. Any non-numeric column in the build data is exploded into binary attributes, one for each distinct value in the column (SVM). GLM does not generate a new attribute for the most frequent value in the original column. These binary attributes are set to one only if the column value for the case is equal to the value associated with the binary attribute.

Algorithms that generate coefficients present challenges in regards to interpretability of results. Examples are SVM and Non-Negative Matrix Factorization (NMF). These algorithms produce coefficients that are used in combination with the transformed attributes. The coefficients are relevant to the data on the transformed scale, not the original data scale.

For all these reasons, the attributes listed in the model details donot resemble the columns of data used to train the model. However, attributes that undergo embedded transformations, whether initiated by Automatic Data Preparation (ADP) or by a user-specified transformation list, appear in the model details in their pre-transformed state, as close as possible to the original column values. Although the attributes are transformed when they are used by the model, they are visible in the model details in a form that can be interpreted by a user.

### Related Topics

- ALTER\_REVERSE\_EXPRESSION Procedure
- GET\_MODEL\_TRANSFORMATIONS Function
- [Model Detail Views](#)

The `GET_*` interfaces are replaced by model views, and Oracle recommends that users leverage the views instead.



# 31

## Creating a Model

Explains how to create data mining models and query model details.

- [Before Creating a Model](#)
- [The CREATE\\_MODEL Procedure](#)
- [Specifying Model Settings](#)
- [Model Detail Views](#)

### 31.1 Before Creating a Model

Explains the preparation steps before creating a model.

Models are database schema objects that perform data mining. The `DBMS_DATA_MINING` PL/SQL package is the API for creating, configuring, evaluating, and querying mining models (model details).

Before you create a model, you must decide what you want the model to do. You must identify the training data and determine if transformations are required. You can specify model settings to influence the behavior of the model behavior. The preparation steps are summarized in the following table.

**Table 31-1 Preparation for Creating a Mining Model**

Preparation Step	Description
Choose the mining function	See " <a href="#">Choosing the Mining Function</a> "
Choose the algorithm	See " <a href="#">Choosing the Algorithm</a> "
Identify the build (training) data	See " <a href="#">Preparing the Data</a> "
For classification models, identify the test data	See " <a href="#">Data Sets for Classification and Regression</a> "
Determine your data transformation strategy	See " <a href="#">Transforming the Data</a> "
Create and populate a settings tables (if needed)	See " <a href="#">Specifying Model Settings</a> "

#### Related Topics

- [About Mining Models](#)  
Mining models are database schema objects that perform data mining.
- [DBMS\\_DATA\\_MINING](#)  
Understand the routines of `DBMS_DATA_MINING` package.

### 31.2 The CREATE\_MODEL Procedure

The `CREATE_MODEL` procedure in the `DBMS_DATA_MINING` package uses the specified data to create a mining model with the specified name and mining function. The model can be created with configuration settings and user-specified transformations.

```
PROCEDURE CREATE_MODEL(
    model_name          IN VARCHAR2,
    mining_function     IN VARCHAR2,
    data_table_name     IN VARCHAR2,
    case_id_column_name IN VARCHAR2,
    target_column_name  IN VARCHAR2 DEFAULT NULL,
    settings_table_name IN VARCHAR2 DEFAULT NULL,
    data_schema_name    IN VARCHAR2 DEFAULT NULL,
    settings_schema_name IN VARCHAR2 DEFAULT NULL,
    xform_list          IN TRANSFORM_LIST DEFAULT NULL);
```

## 31.2.1 Choosing the Mining Function

Explains about providing mining function to CREATE\_MODEL.

The mining function is a required argument to the CREATE\_MODEL procedure. A data mining function specifies a class of problems that can be modeled and solved.

Data mining functions implement either **supervised** or **unsupervised** learning. Supervised learning uses a set of independent attributes to predict the value of a dependent attribute or **target**. Unsupervised learning does not distinguish between dependent and independent attributes. Supervised functions are predictive. Unsupervised functions are descriptive.



### Note:

In data mining terminology, a **function** is a general type of problem to be solved by a given approach to data mining. In SQL language terminology, a **function** is an operator that returns a value.

In Oracle Data Mining documentation, the term **function**, or **mining function** refers to a data mining function; the term **SQL function** or **SQL Data Mining function** refers to a SQL function for scoring (applying data mining models).

You can specify any of the values in the following table for the *mining\_function* parameter to CREATE\_MODEL.

**Table 31-2 Mining Model Functions**

<i>Mining_Function Value</i>	Description
ASSOCIATION	Association is a descriptive mining function. An association model identifies relationships and the probability of their occurrence within a data set. (association rules) Association models use the Apriori algorithm.
ATTRIBUTE_IMPORTANCE	Attribute Importance is a predictive mining function. An attribute importance model identifies the relative importance of attributes in predicting a given outcome. Attribute Importance models use the Minimum Description Length algorithm and CUR Matrix Decomposition.

**Table 31-2 (Cont.) Mining Model Functions**

<i>Mining_Function</i> Value	Description
CLASSIFICATION	<p>Classification is a predictive mining function. A classification model uses historical data to predict a categorical target.</p> <p>Classification models can use Naive Bayes, Neural Network, Decision Tree, Logistic Regression, Random Forest, Support Vector Machines, or Explicit Semantic Analysis. The default is Naive Bayes.</p> <p>The classification function can also be used for anomaly detection. In this case, the SVM algorithm with a null target is used (One-Class SVM).</p>
CLUSTERING	<p>Clustering is a descriptive mining function. A clustering model identifies natural groupings within a data set.</p> <p>Clustering models can use k-Means, O-Cluster, or Expectation Maximization. The default is k-Means.</p>
FEATURE_EXTRACTION	<p>Feature Extraction is a descriptive mining function. A feature extraction model creates a set of optimized attributes.</p> <p>Feature extraction models can use Non-Negative Matrix Factorization, Singular Value Decomposition (which can also be used for Principal Component Analysis) or Explicit Semantic Analysis. The default is Non-Negative Matrix Factorization.</p>
REGRESSION	<p>Regression is a predictive mining function. A regression model uses historical data to predict a numerical target.</p> <p>Regression models can use Support Vector Machines or Linear Regression. The default is Support Vector Machine.</p>
TIME_SERIES	<p>Time series is a predictive mining function. A time series model forecasts the future values of a time-ordered series of historical numeric data over a user-specified time window. Time series models use the Exponential Smoothing algorithm. The default is Exponential Smoothing.</p>

**Related Topics**

- [Oracle Data Mining Concepts](#)

## 31.2.2 Choosing the Algorithm

Learn about providing the algorithm settings for a model.

The `ALGO_NAME` setting specifies the algorithm for a model. If you use the default algorithm for the mining function, or if there is only one algorithm available for the mining function, you do not need to specify the `ALGO_NAME` setting. Instructions for specifying model settings are in "Specifying Model Settings".

**Table 31-3 Data Mining Algorithms**

<i>ALGO_NAME</i> Value	Algorithm	Default?	Mining Model Function
<code>ALGO_AI_MDL</code>	Minimum Description Length	—	attribute importance
<code>ALGO_APRIORI_ASSOCIATION_RULES</code>	Apriori	—	association
<code>ALGO_CUR_DECOMPOSITION</code>	CUR Decomposition		Attribute Importance

**Table 31-3 (Cont.) Data Mining Algorithms**

ALGO_NAME Value	Algorithm	Default?	Mining Model Function
ALGO_DECISION_TREE	Decision Tree	—	classification
ALGO_EXPECTATION_MAXIMIZATION	Expectation Maximization		
ALGO_EXPLICIT_SEMANTIC_ANALYS	Explicit Semantic Analysis	—	feature extraction classification
ALGO_EXPONENTIAL_SMOOTHING	Exponential Smoothing	—	time series
ALGO_EXTENSIBLE_LANG	Language used for extensible algorithm	—	All mining functions are supported
ALGO_GENERALIZED_LINEAR_MODEL	Generalized Linear Model	—	classification and regression
ALGO_KMEANS	<i>k</i> -Means	yes	clustering
ALGO_NAIVE_BAYES	Naive Bayes	yes	classification
ALGO_NEURAL_NETWORK	Neural Network	—	classification
ALGO_NONNEGATIVE_MATRIX_FACTO R	Non-Negative Matrix Factorization	yes	feature extraction
ALGO_O_CLUSTER	O-Cluster	—	clustering
ALGO_RANDOM_FOREST	Random Forest	—	classification
ALGO_SINGULAR_VALUE_DECOMP	Singular Value Decomposition (can also be used for Principal Component Analysis)	—	feature extraction
ALGO_SUPPORT_VECTOR_MACHINES	Support Vector Machine	yes	default regression algorithm regression, classification, and anomaly detection (classification with no target)

**Related Topics**

- [Specifying Model Settings](#)  
Understand how to configure data mining models at build time.
- *Oracle Data Mining Concepts*

## 31.2.3 Supplying Transformations

You can optionally specify transformations for the build data in the *xform\_list* parameter to CREATE\_MODEL. The transformation instructions are embedded in the model and reapplied whenever the model is applied to new data.

### 31.2.3.1 Creating a Transformation List

The following are the ways to create a transformation list:

- The STACK interface in DBMS\_DATA\_MINING\_TRANSFORM.  
The STACK interface offers a set of pre-defined transformations that you can apply to an attribute or to a group of attributes. For example, you can specify supervised binning for all categorical attributes.
- The SET\_TRANSFORM procedure in DBMS\_DATA\_MINING\_TRANSFORM.

The `SET_TRANSFORM` procedure applies a specified SQL expression to a specified attribute. For example, the following statement appends a transformation instruction for `country_id` to a list of transformations called `my_xforms`. The transformation instruction divides `country_id` by 10 before algorithmic processing begins. The reverse transformation multiplies `country_id` by 10.

```
dbms_data_mining_transform.SET_TRANSFORM (my_xforms,  
    'country_id', NULL, 'country_id/10', 'country_id*10');
```

The reverse transformation is applied in the model details. If `country_id` is the target of a supervised model, the reverse transformation is also applied to the scored target.

### 31.2.3.2 Transformation List and Automatic Data Preparation

Understand the interaction between transformation list and Automatic Data Preparation (ADP).

The transformation list argument to `CREATE_MODEL` interacts with the `PREP_AUTO` setting, which controls ADP:

- When ADP is on and you specify a transformation list, your transformations are applied with the automatic transformations and embedded in the model. The transformations that you specify are executed before the automatic transformations.
- When ADP is off and you specify a transformation list, your transformations are applied and embedded in the model, but no system-generated transformations are performed.
- When ADP is on and you do not specify a transformation list, the system-generated transformations are applied and embedded in the model.
- When ADP is off and you do not specify a transformation list, no transformations are embedded in the model; you must separately prepare the data sets you use for building, testing, and scoring the model.

#### Related Topics

- [Embedding Transformations in a Model](#)
- *Oracle Database PL/SQL Packages and Types Reference*

### 31.2.4 About Partitioned Model

Introduces partitioned model to organise and represent multiple models.

Oracle Data Mining supports building of a persistent Oracle Data Mining partitioned model. A partitioned model organizes and represents multiple models as partitions in a single model entity, enabling a user to easily build and manage models tailored to independent slices of data. Persistent means that the partitioned model has an on-disk representation. The product manages the organization of the partitioned model and simplifies the process of scoring the partitioned model. You must include the partition columns as part of the `USING` clause when scoring.

The partition names, key values, and the structure of the partitioned model are visible in the `ALL_MINING_MODEL_PARTITIONS` view.

#### Related Topics

- *Oracle Database Reference*
- *Oracle Data Mining User's Guide*

### 31.2.4.1 Partitioned Model Build Process

To build a Partitioned Model, Oracle Data Mining requires a partitioning key. The partition key is set through a build setting in the settings table.

The partitioning key is a comma-separated list of one or more columns (up to 16) from the input data set. The partitioning key horizontally slices the input data based on discrete values of the partitioning key. That is, partitioning is performed as list values as opposed to range partitioning against a continuous value. The partitioning key supports only columns of the data type `NUMBER` and `VARCHAR2`.

During the build process the input data set is partitioned based on the distinct values of the specified key. Each data slice (unique key value) results in its own model partition. This resultant model partition is not separate and is not visible to you as a standalone model. The default value of the maximum number of partitions for partitioned models is 1000 partitions. You can also set a different maximum partitions value. If the number of partitions in the input data set exceed the defined maximum, Oracle Data Mining throws an exception.

The Partitioned Model organizes features common to all partitions and the partition specific features. The common features consist of the following metadata:

- The model name
- The mining function
- The mining algorithm
- A super set of all mining model attributes referenced by all partitions (signature)
- A common set of user-defined column transformations
- Any user-specified or default build settings that are interpreted as global. For example, the Auto Data Preparation (ADP) setting

### 31.2.4.2 DDL in Partitioned model

Partitioned models are maintained through the following DDL operations:

- [Drop model or drop partition](#)
- [Add partition](#)

#### 31.2.4.2.1 Drop Model or Drop Partition

Oracle Data Mining supports dropping a single model partition for a given partition name.

If only a single partition remains, you cannot explicitly drop that partition. Instead, you must either add additional partitions prior to dropping the partition or you may choose to drop the model itself. When dropping a partitioned model, all partitions are dropped in a single atomic operation. From a performance perspective, Oracle recommends `DROP_PARTITION` followed by an `ADD_PARTITION` instead of leveraging the `REPLACE` option due to the efficient behavior of the `DROP_PARTITION` option.

#### 31.2.4.2.2 Add Partition

Oracle Data Mining supports adding a single partition or multiple partitions to an existing partitioned model.

The addition occurs based on the input data set and the name of the existing partitioned model. The operation takes the input data set and the existing partitioned model as

parameters. The partition keys are extracted from the input data set and the model partitions are built against the input data set. These partitions are added to the partitioned model. In the case where partition keys for new partitions conflict with the existing partitions in the model, you can select from the following three approaches to resolve the conflicts:

- **ERROR:** Terminates the ADD operation without adding any partitions.
- **REPLACE:** Replaces the existing partition for which the conflicting keys are found.
- **IGNORE:** Eliminates the rows having the conflicting keys.

If the input data set contains multiple keys, then the operation creates multiple partitions. If the total number of partitions in the model increases to more than the user-defined maximum specified when the model was created, then you get an error. The default threshold value for the number of partitions is 1000.

### 31.2.4.3 Partitioned Model scoring

Learn about scoring of a partitioned model.

The scoring of the partitioned model is the same as that of the non-partitioned model. The syntax of the data mining function remains the same but is extended to provide an optional hint to you. The optional hint can impact the performance of a query which involves scoring a partitioned model.

For scoring a partitioned model, the signature columns used during the build for the partitioning key must be present in the scoring data set. These columns are combined to form a unique partition key. The unique key is then mapped to a specific underlying model partition, and the identified model partition is used to score that row.

The partitioned objects that are necessary for scoring are loaded on demand during the query execution and are aged out depending on the System Global Area (SGA) memory.

#### Related Topics

- *Oracle Database SQL Language Reference*

## 31.3 Specifying Model Settings

Understand how to configure data mining models at build time.

Numerous configuration settings are available for configuring data mining models at build time. To specify settings, create a settings table with the columns shown in the following table and pass the table to `CREATE_MODEL`.

**Table 31-4 Settings Table Required Columns**

Column Name	Data Type
setting_name	VARCHAR2 (30)
setting_value	VARCHAR2 (4000)

**Example 31-1** creates a settings table for an Support Vector Machine (SVM) Classification model. Since SVM is not the default classifier, the `ALGO_NAME` setting is used to specify the algorithm. Setting the `SVMS_KERNEL_FUNCTION` to `SVMS_LINEAR` causes the model to be built with a linear kernel. If you do not specify the kernel function, the algorithm chooses the kernel based on the number of attributes in the data.

Some settings apply generally to the model, others are specific to an algorithm. Model settings are referenced in [Table 31-5](#) and [Table 31-6](#).

**Table 31-5 General Model Settings**

Settings	Description
Mining function settings	See "Mining Function Settings" in <i>Oracle Database PL/SQL Packages and Types Reference</i>
Algorithm names	See "Algorithm Names" in <i>Oracle Database PL/SQL Packages and Types Reference</i>
Global model characteristics	See "Global Settings" in <i>Oracle Database PL/SQL Packages and Types Reference</i>
Automatic Data Preparation	See "Automatic Data Preparation" in <i>Oracle Database PL/SQL Packages and Types Reference</i>

**Table 31-6 Algorithm-Specific Model Settings**

Algorithm	Description
CUR Matrix Decomposition	See "DBMS_DATA_MINING —Algorithm Settings: CUR Matrix Decomposition" in <i>Oracle Database PL/SQL Packages and Types Reference</i>
Decision Tree	See "DBMS_DATA_MINING —Algorithm Settings: Decision Tree" in <i>Oracle Database PL/SQL Packages and Types Reference</i>
Expectation Maximization	See "DBMS_DATA_MINING —Algorithm Settings: Expectation Maximization" in <i>Oracle Database PL/SQL Packages and Types Reference</i>
Explicit Semantic Analysis	See "DBMS_DATA_MINING —Algorithm Settings: Explicit Semantic Analysis" in <i>Oracle Database PL/SQL Packages and Types Reference</i>
Exponential Smoothing	See "DBMS_DATA_MINING —Algorithm Settings: Exponential Smoothing Models" in <i>Oracle Database PL/SQL Packages and Types Reference</i>
Generalized Linear Models	See "DBMS_DATA_MINING —Algorithm Settings: Generalized Linear Models" in <i>Oracle Database PL/SQL Packages and Types Reference</i>
k-Means	See "DBMS_DATA_MINING —Algorithm Settings: k-Means" in <i>Oracle Database PL/SQL Packages and Types Reference</i>
Naive Bayes	See "Algorithm Settings: Naive Bayes" in <i>Oracle Database PL/SQL Packages and Types Reference</i>
Neural Network	See "DBMS_DATA_MINING —Algorithm Settings: Neural Network" in <i>Oracle Database PL/SQL Packages and Types Reference</i>
Non-Negative Matrix Factorization	See "DBMS_DATA_MINING —Algorithm Settings: Non-Negative Matrix Factorization" in <i>Oracle Database PL/SQL Packages and Types Reference</i>
O-Cluster	See "Algorithm Settings: O-Cluster" in <i>Oracle Database PL/SQL Packages and Types Reference</i>
Random Forest	See "DBMS_DATA_MINING — Algorithm Settings: Random Forest" in <i>Oracle Database PL/SQL Packages and Types Reference</i>
Singular Value Decomposition	See "DBMS_DATA_MINING —Algorithm Settings: Singular Value Decomposition" in <i>Oracle Database PL/SQL Packages and Types Reference</i>
Support Vector Machine	See "DBMS_DATA_MINING —Algorithm Settings: Support Vector Machine" in <i>Oracle Database PL/SQL Packages and Types Reference</i>

**Example 31-1 Creating a Settings Table for an SVM Classification Model**

```
CREATE TABLE svmc_sh_sample_settings (
  setting_name VARCHAR2(30),
  setting_value VARCHAR2(4000));
```



```

BEGIN
  INSERT INTO svmc_sh_sample_settings (setting_name, setting_value) VALUES
    (dbms_data_mining.algo_name, dbms_data_mining.algo_support_vector_machines);
  INSERT INTO svmc_sh_sample_settings (setting_name, setting_value) VALUES
    (dbms_data_mining.svms_kernel_function, dbms_data_mining.svms_linear);
  COMMIT;
END;
/

```

**Related Topics**

- *Oracle Database PL/SQL Packages and Types Reference*

## 31.3.1 Specifying Costs

Specify a cost matrix table to build a Decision Tree model.

The `CLAS_COST_TABLE_NAME` setting specifies the name of a cost matrix table to be used in building a Decision Tree model. A cost matrix biases a classification model to minimize costly misclassifications. The cost matrix table must have the columns shown in the following table:

**Table 31-7 Cost Matrix Table Required Columns**

Column Name	Data Type
<code>actual_target_value</code>	valid target data type
<code>predicted_target_value</code>	valid target data type
<code>cost</code>	NUMBER

Decision Tree is the only algorithm that supports a cost matrix at build time. However, you can create a cost matrix and associate it with any classification model for scoring.

If you want to use costs for scoring, create a table with the columns shown in [Table 31-7](#), and use the `DBMS_DATA_MINING.ADD_COST_MATRIX` procedure to add the cost matrix table to the model. You can also specify a cost matrix inline when invoking a `PREDICTION` function.

[Table 29-1](#) has details for valid target data types.

**Related Topics**

- *Oracle Data Mining Concepts*

## 31.3.2 Specifying Prior Probabilities

Prior probabilities can be used to offset differences in distribution between the build data and the actual population.

The `CLAS_PRIORS_TABLE_NAME` setting specifies the name of a table of prior probabilities to be used in building a Naive Bayes model. The priors table must have the columns shown in the following table.

**Table 31-8 Priors Table Required Columns**

Column Name	Data Type
<code>target_value</code>	valid target data type
<code>prior_probability</code>	NUMBER

**Related Topics**

- [Target Attribute](#)  
Understand what a **target** means in data mining and understand the different target data types.
- [Oracle Data Mining Concepts](#)

### 31.3.3 Specifying Class Weights

Specify class weights table settings in Logistic Regression or Support Vector Machine (SVM) Classification to favour higher weighted classes.

The `CLAS_WEIGHTS_TABLE_NAME` setting specifies the name of a table of class weights to be used to bias a logistic regression (Generalized Linear Model Classification) or SVM Classification model to favor higher weighted classes. The weights table must have the columns shown in the following table.

**Table 31-9 Class Weights Table Required Columns**

Column Name	Data Type
<code>target_value</code>	valid target data type
<code>class_weight</code>	NUMBER

**Related Topics**

- [Target Attribute](#)  
Understand what a **target** means in data mining and understand the different target data types.
- [Oracle Data Mining Concepts](#)

### 31.3.4 Model Settings in the Data Dictionary

Explains about `ALL/USER/DBA_MINING_MODEL_SETTINGS` in data dictionary view.

Information about mining model settings can be obtained from the data dictionary view `ALL/USER/DBA_MINING_MODEL_SETTINGS`. When used with the `ALL` prefix, this view returns information about the settings for the models accessible to the current user. When used with the `USER` prefix, it returns information about the settings for the models in the user's schema. The `DBA` prefix is only available for DBAs.

The columns of `ALL_MINING_MODEL_SETTINGS` are described as follows and explained in the following table.

```
SQL> describe all_mining_model_settings
```

Name	Null?	Type
OWNER	NOT NULL	VARCHAR2 (30)
MODEL_NAME	NOT NULL	VARCHAR2 (30)
SETTING_NAME	NOT NULL	VARCHAR2 (30)
SETTING_VALUE		VARCHAR2 (4000)
SETTING_TYPE		VARCHAR2 (7)

**Table 31-10 ALL\_MINING\_MODEL\_SETTINGS**

Column	Description
owner	Owner of the mining model.
model_name	Name of the mining model.
setting_name	Name of the setting.
setting_value	Value of the setting.
setting_type	INPUT if the value is specified by a user. DEFAULT if the value is system-generated.

The following query lists the settings for the Support Vector Machine (SVM) Classification model `svmc_sh_clas_sample`. The `ALGO_NAME`, `CLAS_WEIGHTS_TABLE_NAME`, and `SVMS_KERNEL_FUNCTION` settings are user-specified. These settings have been specified in a settings table for the model.

**Example 31-2 ALL\_MINING\_MODEL\_SETTINGS**

```
SQL> COLUMN setting_value FORMAT A35
SQL> SELECT setting_name, setting_value, setting_type
       FROM all_mining_model_settings
       WHERE model_name in 'svmc_sh_clas_sample';
```

SETTING_NAME	SETTING_VALUE	SETTING
SVMS_ACTIVE_LEARNING	SVMS_AL_ENABLE	DEFAULT
PREP_AUTO	OFF	DEFAULT
SVMS_COMPLEXITY_FACTOR	0.244212	DEFAULT
SVMS_KERNEL_FUNCTION	SVMS_LINEAR	INPUT
CLAS_WEIGHTS_TABLE_NAME	svmc_sh_sample_class_wt	INPUT
SVMS_CONV_TOLERANCE	.001	DEFAULT
ALGO_NAME	ALGO_SUPPORT_VECTOR_MACHINES	INPUT

**Related Topics**

- [Oracle Database PL/SQL Packages and Types Reference](#)

### 31.3.5 Specifying Mining Model Settings for R Model

The mining model settings for R model determine the characteristics of the model. You can specify the mining model settings in the `mining_model_table`.

You can build R models with the mining model settings by combining together generic settings that do not require an algorithm, such as `ODMS_PARTITION_COLUMNS` and `ODMS_SAMPLING`. The following settings are exclusive to R mining model, and they allow you to specify the R Mining model:

- [ALGO\\_EXTENSIBLE\\_LANG](#)
- [RALG\\_BUILD\\_FUNCTION](#)
- [RALG\\_BUILD\\_PARAMETER](#)
- [RALG\\_DETAILS\\_FORMAT](#)
- [RALG\\_DETAILS\\_FUNCTION](#)
- [RALG\\_SCORE\\_FUNCTION](#)
- [RALG\\_WEIGHT\\_FUNCTION](#)

**Related Topics**

- [Registered R Scripts](#)  
The `RALG_*_FUNCTION` must specify R scripts that exist in the R script repository. You can register the R scripts using Oracle R Enterprise.

### 31.3.5.1 ALGO\_EXTENSIBLE\_LANG

Use the `ALGO_EXTENSIBLE_LANG` setting to specify the Oracle Data Mining framework with extensible algorithms.

Currently, `R` is the only valid value for `ALGO_EXTENSIBLE_LANG`. When the value for `ALGO_EXTENSIBLE_LANG` is set to `R`, the mining models are built using the R language. You can use the following settings in the `model_setting_table` to specify the build, score, and view of the R model.

- [RALG\\_BUILD\\_FUNCTION](#)
- [RALG\\_BUILD\\_PARAMETER](#)
- [RALG\\_DETAILS\\_FUNCTION](#)
- [RALG\\_DETAILS\\_FORMAT](#)
- [RALG\\_SCORE\\_FUNCTION](#)
- [RALG\\_WEIGHT\\_FUNCTION](#)

**Related Topics**

- [Registered R Scripts](#)  
The `RALG_*_FUNCTION` must specify R scripts that exist in the R script repository. You can register the R scripts using Oracle R Enterprise.

### 31.3.5.2 RALG\_BUILD\_FUNCTION

Use the `RALG_BUILD_FUNCTION` to specify the name of an existing registered R script for R algorithm mining model build.

You must specify both `RALG_BUILD_FUNCTION` and `ALGO_EXTENSIBLE_LANG` in the `model_setting_table`. The R script defines an R function that has the first input argument of `data.frame` for training data, and it returns an R model object. The first data argument is mandatory. The `RALG_BUILD_FUNCTION` can accept additional model build parameters.

**Note:**

The valid inputs for input parameters are numeric and string scalar data types.

**Example 31-3 Example of RALG\_BUILD\_FUNCTION**

This example shows how to specify the name of the R script `MY_LM_BUILD_SCRIPT` that is used to build the model in the `model_setting_table`.

```
Begin
insert into model_setting_table values
(dbms_data_mining.ralg_build_function, 'MY_LM_BUILD_SCRIPT');
```

```
End;
/
```

The R script `MY_LM_BUILD_SCRIPT` defines an R function that builds the LM model. You must register the script `MY_LM_BUILD_SCRIPT` in the R script repository which uses the existing ORE security restrictions. You can use Oracle R Enterprise API `sys.rqScriptCreate` to register the script. Oracle R Enterprise requires the `RQADMIN` role to register R scripts.

For example:

```
Begin
sys.rqScriptCreate('MY_LM_BUILD_SCRIPT', 'function(data, formula,
model.frame) {lm(formula = formula, data=data, model =
as.logical(model.frame))}');
End;
/
```

For Clustering and Feature Extraction mining function model build, the R attributes `dm$nclus` and `dm$nfeat` must be set on the return R model to indicate the number of clusters and features respectively.

The R script `MY_KM_BUILD_SCRIPT` defines an R function that builds the *k*-Means model for Clustering. R attribute `dm$nclus` is set with the number of clusters for the return Clustering model.

```
'function(dat) {dat.scaled <- scale(dat)
  set.seed(6543); mod <- list()
  fit <- kmeans(dat.scaled, centers = 3L)
  mod[[1L]] <- fit
  mod[[2L]] <- attr(dat.scaled, "scaled:center")
  mod[[3L]] <- attr(dat.scaled, "scaled:scale")
  attr(mod, "dm$nclus") <- nrow(fit$centers)
  mod}'
```

The R script `MY_PCA_BUILD_SCRIPT` defines an R function that builds the PCA model. R attribute `dm$nfeat` is set with the number of features for the return feature extraction model.

```
'function(dat) {
  mod <- prcomp(dat, retx = FALSE)
  attr(mod, "dm$nfeat") <- ncol(mod$rotation)
  mod}'
```

### Related Topics

- [RALG\\_BUILD\\_PARAMETER](#)  
The `RALG_BUILD_FUNCTION` input parameter specifies a list of numeric and string scalar values in SQL `SELECT` query statement format.
- [Registered R Scripts](#)  
The `RALG_*_FUNCTION` must specify R scripts that exist in the R script repository. You can register the R scripts using Oracle R Enterprise.

### 31.3.5.2.1 RALG\_BUILD\_PARAMETER

The `RALG_BUILD_FUNCTION` input parameter specifies a list of numeric and string scalar values in SQL `SELECT` query statement format.

#### Example 31-4 Example of RALG\_BUILD\_PARAMETER

The `RALG_BUILD_FUNCTION` input parameters must be a list of numeric and string scalar values. The input parameters are optional.

The syntax of the parameter is:

```
'SELECT value parameter name ...FROM dual'
```

This example shows how to specify a formula for the input argument 'formula' and a numeric value zero for input argument 'model.frame' using the `RALG_BUILD_PARAMETER`. These input arguments must match with the function signature of the R script used in `RALG_BUILD_FUNCTION` Parameter.

```
Begin
insert into model_setting_table values
(dbms_data_mining.ralg_build_parameter, 'select ''AGE ~ .'' as "formula", 0
as "model.frame" from dual');
End;
/
```

#### Related Topics

- [RALG\\_BUILD\\_FUNCTION](#)  
Use the `RALG_BUILD_FUNCTION` to specify the name of an existing registered R script for R algorithm mining model build.

### 31.3.5.3 RALG\_DETAILS\_FUNCTION

The `RALG_DETAILS_FUNCTION` specifies the R model metadata that is returned in the `data.frame`.

Use the `RALG_DETAILS_FUNCTION` to specify an existing registered R script that generates model information. The specified R script defines an R function that contains the first input argument for the R model object. The output of the R function must be a `data.frame`. The columns of the `data.frame` are defined by `RALG_DETAILS_FORMAT`, and can contain only numeric or string scalar types.

#### Example 31-5 Example of RALG\_DETAILS\_FUNCTION

This example shows how to specify the name of the R script `MY_LM_DETAILS_SCRIPT` in the `model_setting_table`. This script defines the R function that is used to provide the model information.

```
Begin
insert into model_setting_table values
(dbms_data_mining.ralg_details_function, 'MY_LM_DETAILS_SCRIPT');
End;
/
```

In the R script repository, the script `MY_LM_DETAILS_SCRIPT` is registered as:

```
'function(mod) data.frame(name=names(mod$coefficients),
  coef=mod$coefficients)'
```

### Related Topics

- [Registered R Scripts](#)  
The `RALG_*_FUNCTION` must specify R scripts that exist in the R script repository. You can register the R scripts using Oracle R Enterprise.
- [RALG\\_DETAILS\\_FORMAT](#)  
Use the `RALG_DETAILS_FORMAT` parameter to specify the names and column types in the model view. It is a string that contains a `SELECT` query to specify a list of numeric and string scalar data types for the name and type of the model view columns.

#### 31.3.5.3.1 RALG\_DETAILS\_FORMAT

Use the `RALG_DETAILS_FORMAT` parameter to specify the names and column types in the model view. It is a string that contains a `SELECT` query to specify a list of numeric and string scalar data types for the name and type of the model view columns.

When `RALG_DETAILS_FORMAT` and `RALG_DETAILS_FUNCTION` are both specified, a model view by the name `DM$VD <model_name>` is created along with an R model in the current schema. The first column of the model view is `PARTITION_NAME`. It has `NULL` value for non-partitioned models. The other columns of the model view are defined by `RALG_DETAILS_FORMAT`.

#### Example 31-6 Example of RALG\_DETAILS\_FORMAT

This example shows how to specify the name and type of the columns for the generated model view. The model view contains `varchar2` column `attr_name` and number column `coef_value` after the first column `partition_name`.

```
Begin
insert into model_setting_table values
(dbms_data_mining.ralg_details_format, 'select cast(''a'' as varchar2(20)) as
attr_name, 0 as coef_value from dual');
End;
/
```

### Related Topics

- [RALG\\_DETAILS\\_FUNCTION](#)  
The `RALG_DETAILS_FUNCTION` specifies the R model metadata that is returned in the `data.frame`.

#### 31.3.5.4 RALG\_SCORE\_FUNCTION

Use the `RALG_SCORE_FUNCTION` to specify an existing registered R script for R algorithm mining model score in the `mining_model_table`.

The specified R script defines an R function. The first input argument defines the model object. The second input argument defines the `data.frame` that is used for scoring data.

**Example 31-7 Example of RALG\_SCORE\_FUNCTION**

This example shows how the function takes the R model and scores the data in the `data.frame`. The argument `object` is the R Linear Model. The argument `newdata` contains scoring data in the `data.frame`.

```
function(object, newdata) {res <- predict.lm(object, newdata = newdata,
se.fit = TRUE); data.frame(fit=res$fit, se=res$se.fit,
df=summary(object)$df[1L])}
```

In this example,

- `object` indicates the LM model
- `newdata` indicates the scoring `data.frame`

The output of the specified R function must be a `data.frame`. Each row represents the prediction for the corresponding scoring data from the input `data.frame`. The columns of the `data.frame` are specific to mining functions, such as:

**Regression:** A single numeric column for predicted target value, with two optional columns containing standard error of model fit, and the degrees of freedom number. The optional columns are needed for query function `PREDICTION_BOUNDS` to work.

**Example 31-8 Example of RALG\_SCORE\_FUNCTION for Regression**

This example shows how to specify the name of the R script `MY_LM_PREDICT_SCRIPT` that is used to score the model in the `model_setting_table`.

```
Begin
insert into model_setting_table values
(dbms_data_mining.ralg_score_function, 'MY_LM_PREDICT_SCRIPT');
End;
/
```

In the R script repository, the script `MY_LM_PREDICT_SCRIPT` is registered as:

```
function(object, newdata) {data.frame(pre = predict(object, newdata =
newdata))}
```

**Classification:** Each column represents the predicted probability of one target class. The column name is the target class name.

**Example 31-9 Example of RALG\_SCORE\_FUNCTION for Classification**

This example shows how to specify the name of the R script `MY_LOGITGLM_PREDICT_SCRIPT` that is used to score the logit Classification model in the `model_setting_table`.

```
Begin
insert into model_setting_table values
(dbms_data_mining.ralg_score_function, 'MY_LOGITGLM_PREDICT_SCRIPT');
End;
/
```



In the R script repository, *MY\_LOGITGLM\_PREDICT\_SCRIPT* is registered as follows. It is a logit Classification with two target class "0" and "1".

```
'function(object, newdata) {
  pred <- predict(object, newdata = newdata, type="response");
  res <- data.frame(1-pred, pred);
  names(res) <- c("0", "1");
  res}'
```

**Clustering:** Each column represents the predicted probability of one cluster. The columns are arranged in order of cluster ID. Each cluster is assigned a cluster ID, and they are consecutive values starting from 1. To support *CLUSTER\_DISTANCE* in the R model, the output of R score function returns extra column containing the value of the distance to each cluster in order of cluster ID after the columns for the predicted probability.

### Example 31-10 Example of RALG\_SCORE\_FUNCTION for Clustering

This example shows how to specify the name of the R script *MY\_CLUSTER\_PREDICT\_SCRIPT* that is used to score the model in the *model\_setting\_table*.

```
Begin
insert into model_setting_table values
(dbms_data_mining.ralg_score_function, 'MY_CLUSTER_PREDICT_SCRIPT');
End;
/
```

In the R script repository, the script *MY\_CLUSTER\_PREDICT\_SCRIPT* is registered as:

```
'function(object, dat){
  mod <- object[[1L]]; ce <- object[[2L]]; sc <- object[[3L]];
  newdata = scale(dat, center = ce, scale = sc);
  centers <- mod$centers;
  ss <- sapply(as.data.frame(t(centers)),
  function(v) rowSums(scale(newdata, center=v, scale=FALSE)^2));
  if (!is.matrix(ss)) ss <- matrix(ss, ncol=length(ss));
  disp <- -1 / (2* mod$tot.withinss/length(mod$cluster));
  distr <- exp(disp*ss);
  prob <- distr / rowSums(distr);
  as.data.frame(cbind(prob, sqrt(ss)))}'
```

**Feature Extraction:** Each column represents the coefficient value of one feature. The columns are arranged in order of feature ID. Each feature is assigned a feature ID, and they are consecutive values starting from 1.

### Example 31-11 Example of RALG\_SCORE\_FUNCTION for Feature Extraction

This example shows how to specify the name of the R script *MY\_FEATURE\_EXTRACTION\_SCRIPT* that is used to score the model in the *model\_setting\_table*.

```
Begin
insert into model_setting_table values
(dbms_data_mining.ralg_score_function, 'MY_FEATURE_EXTRACTION_SCRIPT');
End;
/
```

In the R script repository, the script `MY_FEATURE_EXTRACTION_SCRIPT` is registered as:

```
'function(object, dat) { as.data.frame(predict(object, dat)) }'
```

The function fetches the centers of the features from the R model, and computes the feature coefficient based on the distance of the score data to the corresponding feature center.

### Related Topics

- [Registered R Scripts](#)  
The `RALG_*_FUNCTION` must specify R scripts that exist in the R script repository. You can register the R scripts using Oracle R Enterprise.

## 31.3.5.5 RALG\_WEIGHT\_FUNCTION

Use the `RALG_WEIGHT_FUNCTION` to specify the name of an existing registered R script that computes weight or contribution for each attribute in scoring. The specified R script is used in the query function `PREDICTION_DETAILS` to evaluate attribute contribution.

The specified R script defines an R function containing the first input argument for model object, and the second input argument of `data.frame` for scoring data. When the mining function is Classification, Clustering, or Feature Extraction, the target class name or cluster ID or feature ID is passed by the third input argument to compute the weight for that particular class or cluster or feature. The script returns a `data.frame` containing the contributing weight for each attribute in a row. Each row corresponds to that input scoring `data.frame`.

### Example 31-12 Example of RALG\_WEIGHT\_FUNCTION

This example shows how to specify the name of the R script `MY_PREDICT_WEIGHT_SCRIPT` that computes weight or contribution of R model attributes in the `model_setting_table`.

```
Begin
insert into model_setting_table values
(dbms_data_mining.ralg_weight_function, 'MY_PREDICT_WEIGHT_SCRIPT');
End;
/
```

In the R script repository, the script `MY_PREDICT_WEIGHT_SCRIPT` for Regression is registered as:

```
'function(mod, data) { coef(mod)[-1L]*data }'
```

In the R script repository, the script `MY_PREDICT_WEIGHT_SCRIPT` for logit Classification is registered as:

```
'function(mod, dat, clas) {
  v <- predict(mod, newdata=dat, type = "response");
  v0 <- data.frame(v, 1-v); names(v0) <- c("0", "1");
  res <- data.frame(lapply(seq_along(dat),
    function(x, dat) {
      if(is.numeric(dat[[x]])) dat[,x] <- as.numeric(0)
      else dat[,x] <- as.factor(NA);
      vv <- predict(mod, newdata = dat, type = "response");
      vv = data.frame(vv, 1-vv); names(vv) <- c("0", "1");
      v0[[clas]] / vv[[clas]]}, dat = dat));
```

```
names(res) <- names(dat);  
res}'
```

### Related Topics

- [Registered R Scripts](#)  
The `RALG_*_FUNCTION` must specify R scripts that exist in the R script repository. You can register the R scripts using Oracle R Enterprise.

## 31.3.5.6 Registered R Scripts

The `RALG_*_FUNCTION` must specify R scripts that exist in the R script repository. You can register the R scripts using Oracle R Enterprise.

The `RALG_*_FUNCTION` includes the following functions:

- `RALG_BUILD_FUNCTION`
- `RALG_DETAILS_FUNCTION`
- `RALG_SCORE_FUNCTION`
- `RALG_WEIGHT_FUNCTION`

### Note:

The R scripts must exist in the R script repository for an R model to function.

You can register the R scripts through Oracle Enterprise R (ORE). To register R scripts, you must have the `RQADMIN` role. After an R model is built, the names of these specified R scripts become model settings. These R scripts must exist in the R script repository for an R model to remain functional.

You can manage the R memory that is used to build, score, and view the R models through Oracle Enterprise R as well.

## 31.3.5.7 R Model Demonstration Scripts

You can access R model demonstration scripts under `rdbms/demo`

```
dmraidemo.sql  dmrglmdemo.sql  dmrpcademo.sql  
dmrardemo.sql  dmrkmdemo.sql  dmrrfdemo.sql  
dmrdtdemo.sql  dmrnndemo.sql
```

## 31.4 Model Detail Views

The `GET_*` interfaces are replaced by model views, and Oracle recommends that users leverage the views instead.

The following are the new model views:

### Association:

- [Model Detail Views for Association Rules](#)
- [Model Detail View for Frequent Itemsets](#)

- [Model Detail View for Transactional Itemsets](#)
- [Model Detail View for Transactional Rule](#)

**Classification, Regression, and Anomaly Detection:**

- [Model Detail Views for Classification Algorithms](#)
- [Model Detail Views for CUR Matrix Decomposition](#)
- [Model Detail Views for Decision Tree](#)
- [Model Detail Views for Generalized Linear Model](#)
- [Model Detail Views for Naive Bayes](#)
- [Model Detail Views for Neural Network](#)
- [Model Detail Views for Random Forest](#)
- [Model Detail View for Support Vector Machine](#)

**Clustering:**

- [Model Detail Views for Clustering Algorithms](#)
- [Model Detail Views for Expectation Maximization](#)
- [Model Detail Views for \*k\*-Means](#)
- [Model Detail Views for O-Cluster](#)

**Feature Extraction:**

- [Model Detail Views for Explicit Semantic Analysis](#)
- [Model Detail Views for Non-Negative Matrix Factorization](#)
- [Model Detail Views for Singular Value Decomposition](#)

**Feature Selection:**

- [Model Detail View for Minimum Description Length](#)

**Data Preparation and Other:**

- [Model Detail View for Binning](#)
- [Model Detail Views for Global Information](#)
- [Model Detail View for Normalization and Missing Value Handling](#)

**Time Series:**

[Model Detail Views for Exponential Smoothing Models](#)

## 31.4.1 Model Detail Views for Association Rules

Model detail views for Association Rules describe the rule view for Association Rules. Oracle recommends that users leverage the model details views instead of the `GET_ASSOCIATION_RULES` function.

The rule view `DM$VRmodel_name` describes the generated rules for Association Rules. Depending on the settings of the model, the rule view has different set of columns. Settings `ODMS_ITEM_ID_COLUMN_NAME` and `ODMS_ITEM_VALUE_COLUMN_NAME` determine how each item is defined. If `ODMS_ITEM_ID_COLUMN_NAME` is set, the input format is called transactional input, otherwise, the input format is called 2-Dimensional input. With transactional input, if setting `ODMS_ITEM_VALUE_COLUMN_NAME` is not set, each item is defined by `ITEM_NAME`, otherwise, each

item is defined by `ITEM_NAME` and `ITEM_VALUE`. With 2-Dimensional input, each item is defined by `ITEM_NAME`, `ITEM_SUBNAME` and `ITEM_VALUE`. Setting `ASSO_AGGREGATES` specifies the columns to aggregate, which is displayed in the view.

**Note:**

Setting `ASSO_AGGREGATES` is not allowed for 2-dimensional input.

The following shows the views with different settings.

**Transactional Input Without ASSO\_AGGREGATES Setting**

When setting `ITEM_NAME` (`ODMS_ITEM_ID_COLUMN_NAME`) is set and `ITEM_VALUE` (`ODMS_ITEM_VALUE_COLUMN_NAME`) is not set, the following is the view. Here the consequent item is defined with only name field. If `ITEM_VALUE` setting is also set, the view will have one extra column `CONSEQUENT_VALUE` to specify the value field.

Name	Type
PARTITION_NAME	VARCHAR2 (128)
RULE_ID	NUMBER
RULE_SUPPORT	NUMBER
RULE_CONFIDENCE	NUMBER
RULE_LIFT	NUMBER
RULE_REVCONFIDENCE	NUMBER
ANTECEDENT_SUPPORT	NUMBER
NUMBER_OF_ITEMS	NUMBER
CONSEQUENT_SUPPORT	NUMBER
CONSEQUENT_NAME	VARCHAR2 (4000)
ANTECEDENT	SYS.XMLTYPE

**Table 31-11 Rule View Columns for Transactional Inputs**

Column Name	Description
PARTITION_NAME	A partition in a partitioned model to retrieve details
RULE_ID	Identifier of the rule
RULE_SUPPORT	The number of transactions that satisfy the rule.
RULE_CONFIDENCE	The likelihood of a transaction satisfying the rule.
RULE_LIFT	The degree of improvement in the prediction over random chance when the rule is satisfied.
RULE_REVCONFIDENCE	The number of transactions in which the rule occurs divided by the number of transactions in which the consequent occurs.
ANTECEDENT_SUPPORT	The ratio of the number of transactions that satisfy the antecedent to the total number of transactions.
NUMBER_OF_ITEMS	The total number of attributes referenced in the antecedent and consequent of the rule.
CONSEQUENT_SUPPORT	The ratio of the number of transactions that satisfy the consequent to the total number of transactions.
CONSEQUENT_NAME	Name of the consequent

**Table 31-11 (Cont.) Rule View Columns for Transactional Inputs**

Column Name	Description
CONSEQUENT_VALUE	<p>Value of the consequent when setting <code>Item_value</code> (<code>ODMS_ITEM_VALUE_COLUMN_NAME</code>) is set with <code>TYPE</code> as numerical, the view has a <code>CONSEQUENT_VALUE</code> column.</p> <p>When setting <code>Item_value</code> (<code>ODMS_ITEM_VALUE_COLUMN_NAME</code>) is set with <code>TYPE</code> as categorical, the view has a <code>CONSEQUENT_VALUE</code> column.</p>
ANTECEDENT	<p>The antecedent is described as an itemset. At the itemset level, it specifies the number of aggregates, and if not zero, the names of the columns to be aggregated (as well as the mapping to <code>ASSO_AGG*</code>). The itemset contains <math>\geq 1</math> items.</p> <ul style="list-style-type: none"> <li>When setting <code>ODMS_ITEM_VALUE_COLUMN_NAME</code> is not set, each item is defined by <code>item_name</code>. As an example, assume the antecedent contains one item B, it is represented as follows: <pre>&lt;itemset NUMAGGR="0"&gt;&lt;item&gt;&lt;item_name&gt;B&lt;/item_name&gt;&lt;/item&gt;&lt;/itemset&gt;</pre> </li> </ul> <p>As another example, assume the antecedent contains two items, A and C, it is represented as follows: <pre>&lt;itemset NUMAGGR="0"&gt;&lt;item&gt;&lt;item_name&gt;A&lt;/item_name&gt;&lt;/item&gt;&lt;item&gt;&lt;item_name&gt;C&lt;/item_name&gt;&lt;/item&gt;&lt;/itemset&gt;</pre> </p> <ul style="list-style-type: none"> <li>When setting <code>ODMS_ITEM_VALUE_COLUMN_NAME</code> is set, each item is defined by <code>item_name</code> and <code>item_value</code>. As an example, assume the antecedent contains two items, (name A, value 1) and (name C, value 1), then it is represented as follows: <pre>&lt;itemset NUMAGGR="0"&gt;&lt;item&gt;&lt;item_name&gt;A&lt;/item_name&gt;&lt;item_value&gt;1&lt;/item_value&gt;&lt;/item&gt;&lt;item&gt;&lt;item_name&gt;C&lt;/item_name&gt;&lt;item_value&gt;1&lt;/item_value&gt;&lt;/item&gt;&lt;/itemset&gt;</pre> </li> </ul>

### Transactional Input With `ASSO_AGGREGATES` Setting

Similar to the view without aggregates setting, there are three cases:

- Rule view when `ODMS_ITEM_ID_COLUMN_NAME` is set and `Item_value` (`ODMS_ITEM_VALUE_COLUMN_NAME`) is not set.
- Rule view when `ODMS_ITEM_ID_COLUMN_NAME` is set and `Item_value` (`ODMS_ITEM_VALUE_COLUMN_NAME`) is set with `TYPE` as numerical, the view has a `CONSEQUENT_VALUE` column.
- Rule view when `ODMS_ITEM_ID_COLUMN_NAME` is set and `Item_value` (`ODMS_ITEM_VALUE_COLUMN_NAME`) is set with `TYPE` as categorical, the view has a `CONSEQUENT_VALUE` column.

For example, refer “Example: Calculating Aggregates” in *Oracle Data Mining Concepts*.

The view reports two sets of aggregates results:

- `ANT_RULE_PROFIT` refers to the total profit for the antecedent itemset with respect to the rule, the profit for each individual item of the antecedent itemset is shown in the

ANTECEDENT (XMLtype) column, CON\_RULE\_PROFIT refers to the total profit for the consequent item with respect to the rule.

In the example, for rule (A, B) => C, the rule itemset (A, B, C) occurs in the transactions of customer 1 and customer 3. The ANT\_RULE\_PROFIT is \$21.20, The ANTECEDENT is shown as follow, which tells that item A has profit 5.00 + 3.00 = \$8.00 and item B has profit 3.20 + 10.00 = \$13.20, which sum up to ANT\_RULE\_PROFIT.

```
<itemset NUMAGGR="1" ASSO_AGG0="profit"><item><item_name>A</
item_name><ASSO_AGG0>8.0E+000</ASSO_AGG0></item><item><item_name>B</
item_name><ASSO_AGG0>1.32E+001</ASSO_AGG0></item></itemset>
The CON_RULE_PROFIT is 12.00 + 14.00 = $26.00
```

2. ANT\_PROFIT refers to the total profit for the antecedent itemset, while CON\_PROFIT refers to the total profit for the consequent item. The difference between CON\_PROFIT and CON\_RULE\_PROFIT (the same applies to ANT\_PROFIT and ANT\_RULE\_PROFIT) is that CON\_PROFIT counts all profit for the consequent item across all transactions where the consequent occurs, while CON\_RULE\_PROFIT only counts across transactions where the rule itemset occurs.

For example, item C occurs in transactions for customer 1, 2 and 3, CON\_PROFIT is 12.00 + 4.20 + 14.00 = \$30.20, while CON\_RULE\_PROFIT only counts transactions for customer 1 and 3 where the rule itemset (A, B, C) occurs.

Similarly, ANT\_PROFIT counts all transactions where itemset (A, B) occurs, while ANT\_RULE\_PROFIT counts only transactions where the rule itemset (A, B, C) occurs. In this example, by coincidence, both count transactions for customer 1 and 3, and have the same value.

### Example 31-13 Examples

The following example shows the view when setting ASSO\_AGGREGATES specifies column profit and column sales to be aggregated. In this example, ITEM\_VALUE column is not specified.

Name	Type
PARTITION_NAME	VARCHAR2 (128)
RULE_ID	NUMBER
RULE_SUPPORT	NUMBER
RULE_CONFIDENCE	NUMBER
RULE_LIFT	NUMBER
RULE_REVCONFIDENCE	NUMBER
ANTECEDENT_SUPPORT	NUMBER
NUMBER_OF_ITEMS	NUMBER
CONSEQUENT_SUPPORT	NUMBER
CONSEQUENT_NAME	VARCHAR2 (4000)
ANTECEDENT	SYS.XMLTYPE
ANT_RULE_PROFIT	BINARY_DOUBLE
CON_RULE_PROFIT	BINARY_DOUBLE
ANT_PROFIT	BINARY_DOUBLE
CON_PROFIT	BINARY_DOUBLE
ANT_RULE_SALES	BINARY_DOUBLE
CON_RULE_SALES	BINARY_DOUBLE
ANT_SALES	BINARY_DOUBLE
CON_SALES	BINARY_DOUBLE

Rule view when `ODMS_ITEM_ID_COLUMN_NAME` is set and `Item_value` (`ODMS_ITEM_VALUE_COLUMN_NAME`) is set with `TYPE` as numerical, the view has a `CONSEQUENT_VALUE` column.

Rule view when `ODMS_ITEM_ID_COLUMN_NAME` is set and `Item_value` (`ODMS_ITEM_VALUE_COLUMN_NAME`) is set with `TYPE` as categorical, the view has a `CONSEQUENT_VALUE` column.

## 2-Dimensional Inputs

In Oracle Data Mining, association models can be built using either transactional or two-dimensional data formats. For two-dimensional input, each item is defined by three fields: `NAME`, `VALUE` and `SUBNAME`. The `NAME` field is the name of the column. The `VALUE` field is the content of the column. The `SUBNAME` field is used when input data table contains nested table. In such case, the `SUBNAME` is the name of the nested table's column. See, [Example: Creating a Nested Column for Market Basket Analysis](#). In this example, there is a nested column. The `CONSEQUENT_SUBNAME` is the `ATTRIBUTE_NAME` part of the nested column. That is, 'O/S Documentation Set - English' and `CONSEQUENT_VALUE` is the value part of the nested column, which is, 1.

The view uses three columns for consequent. The rule view has the following columns:

Name	Type
PARTITION_NAME	VARCHAR2 (128)
RULE_ID	NUMBER
RULE_SUPPORT	NUMBER
RULE_CONFIDENCE	NUMBER
RULE_LIFT	NUMBER
RULE_REVCONFIDENCE	NUMBER
ANTECEDENT_SUPPORT	NUMBER
NUMBER_OF_ITEMS	NUMBER
CONSEQUENT_SUPPORT	NUMBER
CONSEQUENT_NAME	VARCHAR2 (4000)
CONSEQUENT_SUBNAME	VARCHAR2 (4000)
CONSEQUENT_VALUE	VARCHAR2 (4000)
ANTECEDENT	SYS.XMLTYPE



### Note:

All the types for three parts are `VARCHAR2`. `ASSO_AGGREGATES` is not applicable for 2-Dimensional input format.

The following table displays rule view columns for 2-Dimensional input with the descriptions of only the fields which are specific to 2-D inputs.

**Table 31-12 Rule View for 2-Dimensional Input**

Column Name	Description
<code>CONSEQUENT_SUBNAME</code>	For two-dimensional inputs, <code>CONSEQUENT_SUBNAME</code> is used for nested column in the input data table.



**Table 31-12 (Cont.) Rule View for 2-Dimensional Input**

Column Name	Description
CONSEQUENT_VALUE	Value of the consequent when setting Item_value is set with TYPE as numerical, the view has a CONSEQUENT_VALUE column.  When setting Item_value is set with TYPE as categorical, the view has a CONSEQUENT_VALUE column.
ANTECEDENT	The antecedent is described as an itemset. The itemset contains $\geq 1$ items. Each item is defined using ITEM_NAME, ITEM_SUBNAME, and ITEM_VALUE:  As an example, assuming that this is not a nested table input, and the antecedent contains one item: (name ADDR, value MA). The antecedent (XMLtype) is as follows:  <pre>&lt;itemset NUMAGGR="0"&gt;&lt;item&gt;&lt;item_name&gt;ADDR&lt;/item_name&gt;&lt;item_subname&gt;&lt;/item_subname&gt;&lt;item_value&gt;MA&lt;/item_value&gt;&lt;/item&gt;&lt;/itemset&gt;</pre> For 2-Dimensional input with nested table, the subname field is filled.

**Global Detail for Association Rules**

A single global detail is produced by an Association model. The following table describes a global detail returned for Association Rules model.

**Table 31-13 Global Detail for Association Rules**

Name	Description
ITEMSET_COUNT	The number of itemsets generated
MAX_SUPPORT	The maximum support
NUM_ROWS	The total number of rows used in the build
RULE_COUNT	The number of association rules in the model generated
TRANSACTION_COUNT	The number of the transactions in input data

## 31.4.2 Model Detail View for Frequent Itemsets

Model detail view for Frequent Itemsets describes the frequent itemsets view. Oracle recommends that you leverage model details view instead of the GET\_FREQUENT\_ITEMSETS function.

The frequent itemsets view `DM$VIModel_name` has the following schema:

Name	Type
PARTITION_NAME	VARCHAR2 (128)
ITEMSET_ID	NUMBER
SUPPORT	NUMBER
NUMBER_OF_ITEMS	NUMBER
ITEMSET	SYS.XMLTYPE

**Table 31-14 Frequent Itemsets View**

Column Name	Description
PARTITION_NAME	A partition in a partitioned model
ITEMSET_ID	Itemset identifier
SUPPORT	Support of the itemset
NUMBER_OF_ITEMS	Number of items in the itemset
ITEMSET	Frequent itemset The structure of the SYS.XMLTYPE column itemset is the same as the corresponding Antecedent column of the rule view.

### 31.4.3 Model Detail View for Transactional Itemsets

Model detail view for Transactional Itemsets describes the transactional itemsets view. Oracle recommends that users leverage the model details views.

For the very common case of transactional data without aggregates, `DM$VTmodel_name` view provides the itemsets information in transactional format. This view can help improve performance for some queries as compared to the view with the XML column. The transactional itemsets view has the following schema:

Name	Type
PARTITION_NAME	VARCHAR2 (128)
ITEMSET_ID	NUMBER
ITEM_ID	NUMBER
SUPPORT	NUMBER
NUMBER_OF_ITEMS	NUMBER
ITEM_NAME	VARCHAR2 (4000)

**Table 31-15 Transactional Itemsets View**

Column Name	Description
PARTITION_NAME	A partition in a partitioned model
ITEMSET_ID	Itemset identifier
ITEM_ID	Item identifier
SUPPORT	Support of the itemset
NUMBER_OF_ITEMS	Number of items in the itemset
ITEM_NAME	The name of the item

## 31.4.4 Model Detail View for Transactional Rule

Model detail view for Transactional Rule describes the transactional rule view and transactional itemsets view. Oracle recommends that you leverage model details views.

Transactional data without aggregates also has a transactional rule view `DM$V $\backslash$ model_name`. This view can improve performance for some queries as compared to the view with the XML column. The transactional rule view has the following schema:

Name	Type
PARTITION_NAME	VARCHAR2 (128)
RULE_ID	NUMBER
ANTECEDENT_PREDICATE	VARCHAR2 (4000)
CONSEQUENT_PREDICATE	VARCHAR2 (4000)
RULE_SUPPORT	NUMBER
RULE_CONFIDENCE	NUMBER
RULE_LIFT	NUMBER
RULE_REVCONFIDENCE	NUMBER
RULE_ITEMSET_ID	NUMBER
ANTECEDENT_SUPPORT	NUMBER
CONSEQUENT_SUPPORT	NUMBER
NUMBER_OF_ITEMS	NUMBER

**Table 31-16 Transactional Rule View**

Column Name	Description
PARTITION_NAME	A partition in a partitioned model
RULE_ID	Rule identifier
ANTECEDENT_PREDICATE	Name of the Antecedent item.
CONSEQUENT_PREDICATE	Name of the Consequent item
RULE_SUPPORT	Support of the rule
RULE_CONFIDENCE	The likelihood a transaction satisfies the rule when it contains the Antecedent.
RULE_LIFT	The degree of improvement in the prediction over random chance when the rule is satisfied
RULE_REVCONFIDENCE	The number of transactions in which the rule occurs divided by the number of transactions in which the consequent occurs
RULE_ITEMSET_ID	Itemset identifier
ANTECEDENT_SUPPORT	The ratio of the number of transactions that satisfy the antecedent to the total number of transactions
CONSEQUENT_SUPPORT	The ratio of the number of transactions that satisfy the consequent to the total number of transactions
NUMBER_OF_ITEMS	Number of items in the rule

## 31.4.5 Model Detail Views for Classification Algorithms

Model detail view for Classification algorithms describe target map view and scoring cost view which are applicable to all Classification algorithms. Oracle recommends that users leverage the model details views instead of the `GET_*` function.

The target map view `DM$VTmodel_name` describes the target distribution for Classification models. The view has the following schema:

Name	Type
PARTITION_NAME	VARCHAR2 (128)
TARGET_VALUE	NUMBER/VARCHAR2
TARGET_COUNT	NUMBER
TARGET_WEIGHT	NUMBER

**Table 31-17 Target Map View**

Column Name	Description
PARTITION_NAME	Partition name in a partitioned model
TARGET_VALUE	Target value, numerical or categorical
TARGET_COUNT	Number of rows for a given TARGET_VALUE
TARGET_WEIGHT	Weight for a given TARGET_VALUE

The scoring cost view `DM$VCmodel_name` describes the scoring cost matrix for Classification models. The view has the following schema:

Name	Type
PARTITION_NAME	VARCHAR2 (128)
ACTUAL_TARGET_VALUE	NUMBER/VARCHAR2
PREDICTED_TARGET_VALUE	NUMBER/VARCHAR2
COST	NUMBER

**Table 31-18 Scoring Cost View**

Column Name	Description
PARTITION_NAME	Partition name in a partitioned model
ACTUAL_TARGET_VALUE	A valid target value
PREDICTED_TARGET_VALUE	Predicted target value
COST	Associated cost for the actual and predicted target value pair

## 31.4.6 Model Detail Views for Decision Tree

Model detail view for Decision Tree describes the split information view, node statistics view, node description view, and the cost matrix view. Oracle recommends that users leverage the model details views instead of `GET_MODEL_DETAILS_XML` function.

The split information view `DM$VPMODEL_name` describes the decision tree hierarchy and the split information for each level in the Decision Tree. The view has the following schema:

Name	Type
PARTITION_NAME	VARCHAR2(128)
PARENT	NUMBER
SPLIT_TYPE	VARCHAR2
NODE	NUMBER
ATTRIBUTE_NAME	VARCHAR2(128)
ATTRIBUTE_SUBNAME	VARCHAR2(4000)
OPERATOR	VARCHAR2
VALUE	SYS.XMLTYPE

**Table 31-19 Split Information View**

Column Name	Description
PARTITION_NAME	Partition name in a partitioned model
PARENT	Node ID of the parent
SPLIT_TYPE	The main or surrogate split
NODE	The node ID
ATTRIBUTE_NAME	The attribute used as the splitting criterion at the parent node to produce this node.
ATTRIBUTE_SUBNAME	Split attribute subname. The value is null for non-nested columns.
OPERATOR	Split operator
VALUE	Value used as the splitting criterion. This is an XML element described using the <code>&lt;Element&gt;</code> tag. For example, <code>&lt;Element&gt;Windy&lt;/Element&gt;&lt;Element&gt;Hot&lt;/Element&gt;</code> .

The node statistics view `DM$VIMODEL_name` describes the statistics associated with individual tree nodes. The statistics include a target histogram for the data in the node. The view has the following schema:

Name	Type
PARTITION_NAME	VARCHAR2(128)
NODE	NUMBER
NODE_SUPPORT	NUMBER
PREDICTED_TARGET_VALUE	NUMBER/VARCHAR2
TARGET_VALUE	NUMBER/VARCHAR2
TARGET_SUPPORT	NUMBER

**Table 31-20 Node Statistics View**

Parameter	Description
PARTITION_NAME	Partition name in a partitioned model
NODE	The node ID
NODE_SUPPORT	Number of records in the training set that belong to the node
PREDICTED_TARGET_VALUE	Predicted Target value
TARGET_VALUE	A target value seen in the training data
TARGET_SUPPORT	The number of records that belong to the node and have the value specified in the TARGET_VALUE column

Higher level node description can be found in `DM$VOMODEL_NAME` view. The `DM$VOMODEL_NAME` has the following schema:

Parameter	Type
PARTITION_NAME	VARCHAR2 (128)
NODE	NUMBER
NODE_SUPPORT	NUMBER
PREDICTED_TARGET_VALUE	NUMBER/VARCHAR2
PARENT	NUMBER
ATTRIBUTE_NAME	VARCHAR2 (128)
ATTRIBUTE_SUBNAME	VARCHAR2 (4000)
OPERATOR	VARCHAR2
VALUE	SYS.XMLTYPE

**Table 31-21 Node Description View**

Parameter	Description
PARTITION_NAME	Partition name in a partitioned model
NODE	The node ID
NODE_SUPPORT	Number of records in the training set that belong to the node
PREDICTED_TARGET_VALUE	Predicted Target value
PARENT	The ID of the parent
ATTRIBUTE_NAME	Specifies the attribute name
ATTRIBUTE_SUBNAME	Specifies the attribute subname
OPERATOR	Attribute predicate operator - a conditional operator taking the following values: <i>IN</i> , =, <>, <, >, <=, and >=
VALUE	Value used as the description criterion. This is an XML element described using the <Element> tag. For example, <Element>Windy</Element><Element>Hot</Element>.

The `DM$VMmodel_name` view describes the cost matrix used by the Decision Tree build. The `DM$VMmodel_name` view has the following schema:

Name	Type
PARTITION_NAME	VARCHAR2 (128)
ACTUAL_TARGET_VALUE	NUMBER/VARCHAR2
PREDICTED_TARGET_VALUE	NUMBER/VARCHAR2
COST	NUMBER

**Table 31-22 Cost Matrix View**

Parameter	Description
PARTITION_NAME	Partition name in a partitioned model
ACTUAL_TARGET_VALUE	Valid target value
PREDICTED_TARGET_VALUE	Predicted Target value
COST	Associated cost for the actual and predicted target value pair

The following table describes the global view for Decision Tree.

**Table 31-23 Decision Tree Statistics Information In Model Global View**

Name	Description
NUM_ROWS	The total number of rows used in the build

## 31.4.7 Model Detail Views for Generalized Linear Model

Model details views for Generalized Linear Model (GLM) describes the model details view and row diagnostic view for Linear and Logistic Regression. Oracle recommends that users leverage model details views than the `GET_MODEL_DETAILS_GLM` function.

The model details view `DM$VDmodel_name` describes the final model information for both Linear Regression models and Logistic Regression models.

For Linear Regression, the view `DM$VDmodel_name` has the following schema:

Name	Type
PARTITION_NAME	VARCHAR2 (128)
ATTRIBUTE_NAME	VARCHAR2 (128)
ATTRIBUTE_SUBNAME	VARCHAR2 (4000)
ATTRIBUTE_VALUE	VARCHAR2 (4000)
FEATURE_EXPRESSION	VARCHAR2 (4000)
COEFFICIENT	BINARY_DOUBLE
STD_ERROR	BINARY_DOUBLE
TEST_STATISTIC	BINARY_DOUBLE
P_VALUE	BINARY_DOUBLE
VIF	BINARY_DOUBLE
STD_COEFFICIENT	BINARY_DOUBLE
LOWER_COEFF_LIMIT	BINARY_DOUBLE
UPPER_COEFF_LIMIT	BINARY_DOUBLE

For Logistic Regression, the view `DM$VDMODEL_model_name` has the following schema:

Name	Type
PARTITION_NAME	VARCHAR2 (128)
TARGET_VALUE	NUMBER/VARCHAR2
ATTRIBUTE_NAME	VARCHAR2 (128)
ATTRIBUTE_SUBNAME	VARCHAR2 (4000)
ATTRIBUTE_VALUE	VARCHAR2 (4000)
FEATURE_EXPRESSION	VARCHAR2 (4000)
COEFFICIENT	BINARY_DOUBLE
STD_ERROR	BINARY_DOUBLE
TEST_STATISTIC	BINARY_DOUBLE
P_VALUE	BINARY_DOUBLE
STD_COEFFICIENT	BINARY_DOUBLE
LOWER_COEFF_LIMIT	BINARY_DOUBLE
UPPER_COEFF_LIMIT	BINARY_DOUBLE
EXP_COEFFICIENT	BINARY_DOUBLE
EXP_LOWER_COEFF_LIMIT	BINARY_DOUBLE
EXP_UPPER_COEFF_LIMIT	BINARY_DOUBLE

**Table 31-24 Model View for Linear and Logistic Regression Models**

Column Name	Description
PARTITION_NAME	The name of a feature in the model
TARGET_VALUE	Valid target value
ATTRIBUTE_NAME	The attribute name when there is no subname, or first part of the attribute name when there is a subname. <code>ATTRIBUTE_NAME</code> is the name of a column in the source table or view. If the column is a non-nested, numeric column, then <code>ATTRIBUTE_NAME</code> is the name of the mining attribute. For the intercept, <code>ATTRIBUTE_NAME</code> is null. Intercepts are equivalent to the bias term in SVM models.
ATTRIBUTE_SUBNAME	Nested column subname. The value is null for non-nested columns. When the nested column is numeric, the mining attribute is identified by the combination <code>ATTRIBUTE_NAME - ATTRIBUTE_SUBNAME</code> . If the column is not nested, <code>ATTRIBUTE_SUBNAME</code> is null. If the attribute is an intercept, both the <code>ATTRIBUTE_NAME</code> and the <code>ATTRIBUTE_SUBNAME</code> are null.
ATTRIBUTE_VALUE	A unique value that can be assumed by a categorical column or nested categorical column. For categorical columns, a mining attribute is identified by a unique <code>ATTRIBUTE_NAME.ATTRIBUTE_VALUE</code> pair. For nested categorical columns, a mining attribute is identified by the combination: <code>ATTRIBUTE_NAME.ATTRIBUTE_SUBNAME.ATTRIBUTE_VALUE</code> . For numerical attributes, <code>ATTRIBUTE_VALUE</code> is null.



**Table 31-24 (Cont.) Model View for Linear and Logistic Regression Models**

Column Name	Description
FEATURE_EXPRESSION	<p>The feature name constructed by the algorithm when feature selection is enabled. If feature selection is not enabled, the feature name is simply the fully-qualified attribute name (<i>attribute_name.attribute_subname</i> if the attribute is in a nested column). For categorical attributes, the algorithm constructs a feature name that has the following form: <i>fully-qualified_attribute_name.attribute_value</i></p> <p>When feature generation is enabled, a term in the model can be a single mining attribute or the product of up to 3 mining attributes. Component mining attributes can be repeated within a single term. If feature generation is not enabled or, if feature generation is enabled, but no multiple component terms are discovered by the CREATE model process, then FEATURE_EXPRESSION is null.</p>
	<div style="border: 1px solid #0070C0; padding: 10px; background-color: #E6F2FF;"> <p> <b>Note:</b></p> <p>In 12c Release 2, the algorithm does not subtract the mean from numerical components.</p> </div>
COEFFICIENT	The estimated coefficient.
STD_ERROR	Standard error of the coefficient estimate.
TEST_STATISTIC	<p>For Linear Regression, the t-value of the coefficient estimate.</p> <p>For Logistic Regression, the Wald chi-square value of the coefficient estimate.</p>
P_VALUE	Probability of the TEST_STATISTIC under the (NULL) hypothesis that the term in the model is not statistically significant. A low probability indicates that the term is significant, while a high probability indicates that the term can be better discarded. Used to analyze the significance of specific attributes in the model.
VIF	Variance Inflation Factor. The value is zero for the intercept. For Logistic Regression, VIF is null.
STD_COEFFICIENT	Standardized estimate of the coefficient.
LOWER_COEFF_LIMIT	Lower confidence bound of the coefficient.
UPPER_COEFF_LIMIT	Upper confidence bound of the coefficient.
EXP_COEFFICIENT	Exponentiated coefficient for Logistic Regression. For linear regression, EXP_COEFFICIENT is null.
EXP_LOWER_COEFF_LIMIT	Exponentiated coefficient for lower confidence bound of the coefficient for Logistic Regression. For Linear Regression, EXP_LOWER_COEFF_LIMIT is null.
EXP_UPPER_COEFF_LIMIT	Exponentiated coefficient for upper confidence bound of the coefficient for Logistic Regression. For Linear Regression, EXP_UPPER_COEFF_LIMIT is null.

The row diagnostic view `DM$VAmodeI_name` describes row level information for both Linear Regression models and Logistic Regression models. For Linear Regression, the view `DM$VAmodeI_name` has the following schema:

Name	Type
PARTITION_NAME	VARCHAR2 (128)
CASE_ID	NUMBER/VARHCAR2, DATE, TIMESTAMP, TIMESTAMP WITH TIME ZONE, TIMESTAMP WITH LOCAL TIME ZONE
TARGET_VALUE	BINARY_DOUBLE
PREDICTED_TARGET_VALUE	BINARY_DOUBLE
Hat	BINARY_DOUBLE
RESIDUAL	BINARY_DOUBLE
STD_ERR_RESIDUAL	BINARY_DOUBLE
STUDENTIZED_RESIDUAL	BINARY_DOUBLE
PRED_RES	BINARY_DOUBLE
COOKS_D	BINARY_DOUBLE

**Table 31-25 Row Diagnostic View for Linear Regression**

Column Name	Description
PARTITION_NAME	Partition name in a partitioned model
CASE_ID	Name of the case identifier
TARGET_VALUE	The actual target value as taken from the input row
PREDICTED_TARGET_VALUE	The model predicted target value for the row
HAT	The diagonal element of the $n \times n$ ( $n$ =number of rows) that the Hat matrix identifies with a specific input row. The model predictions for the input data are the product of the Hat matrix and vector of input target values. The diagonal elements (Hat values) represent the influence of the $i^{\text{th}}$ row on the $i^{\text{th}}$ fitted value. Large Hat values are indicators that the $i^{\text{th}}$ row is a point of high leverage, a potential outlier.
RESIDUAL	The difference between the predicted and actual target value for a specific input row.
STD_ERR_RESIDUAL	The standard error residual, sometimes called the Studentized residual, re-scales the residual to have constant variance across all input rows in an effort to make the input row residuals comparable. The process multiplies the residual by square root of the row weight divided by the product of the model mean square error and 1 minus the Hat value.
STUDENTIZED_RESIDUAL	Studentized deletion residual adjusts the standard error residual for the influence of the current row.
PRED_RES	The predictive residual is the weighted square of the deletion residuals, computed as the row weight multiplied by the square of the residual divided by 1 minus the Hat value.
COOKS_D	Cook's distance is a measure of the combined impact of the $i^{\text{th}}$ case on all of the estimated regression coefficients.

For Logistic Regression, the view `DM$VAmodeI_name` has the following schema:

Name	Type
PARTITION_NAME	VARCHAR2 (128)

CASE_ID	NUMBER/VARHCAR2, DATE, TIMESTAMP, TIMESTAMP WITH TIME ZONE, TIMESTAMP WITH LOCAL TIME ZONE
TARGET_VALUE	NUMBER/VARCHAR2
TARGET_VALUE_PROB	BINARY_DOUBLE
Hat	BINARY_DOUBLE
WORKING_RESIDUAL	BINARY_DOUBLE
PEARSON_RESIDUAL	BINARY_DOUBLE
DEVIANCCE_RESIDUAL	BINARY_DOUBLE
C	BINARY_DOUBLE
CBAR	BINARY_DOUBLE
DIFDEV	BINARY_DOUBLE
DIFCHISQ	BINARY_DOUBLE

**Table 31-26 Row Diagnostic View for Logistic Regression**

Column Name	Description
PARTITION_NAME	Partition name in a partitioned model
CASE_ID	Name of the case identifier
TARGET_VALUE	The actual target value as taken from the input row
TARGET_VALUE_PROB	Model estimate of the probability of the predicted target value.
Hat	The Hat value concept from Linear Regression is extended to Logistic Regression by multiplying the Linear Regression Hat value by the variance function for Logistic Regression, the predicted probability multiplied by 1 minus the predicted probability.
WORKING_RESIDUAL	The working residual is the residual of the working response. The working response is the response on the linearized scale. For Logistic Regression it has the form: the $i^{\text{th}}$ row residual divided by the variance of the $i^{\text{th}}$ row prediction. The variance of the prediction is the predicted probability multiplied by 1 minus the predicted probability.  $WORKING\_RESIDUAL$ is the difference between the working response and the linear predictor at convergence.
PEARSON_RESIDUAL	The Pearson residual is a re-scaled version of the working residual, accounting for the weight. For Logistic Regression, the Pearson residual multiplies the residual by a factor that is computed as square root of the weight divided by the variance of the predicted probability for the $i^{\text{th}}$ row.  $RESIDUAL$ is 1 minus the predicted probability of the actual target value for the row.
DEVIANCCE_RESIDUAL	The $DEVIANCCE\_RESIDUAL$ is the contribution to the model deviance of the $i^{\text{th}}$ observation. For Logistic Regression it has the form the square root of 2 times the $\log(1 + e^{\eta}) - \eta$ for the non-reference class and -square root of 2 time the $\log(1 + \eta)$ for the reference class, where $\eta$ is the linear prediction (the prediction as if the model were a Linear Regression).
C	Measures the overall change in the fitted logits due to the deletion of the $i^{\text{th}}$ observation for all points including the one deleted (the $i^{\text{th}}$ point). It is computed as the square of the Pearson residual multiplied by the Hat value divided by the square of 1 minus the Hat value.  Confidence interval displacement diagnostics that provides scalar measure of the influence of individual observations.

**Table 31-26 (Cont.) Row Diagnostic View for Logistic Regression**

Column Name	Description
CBAR	C and CBAR are extensions of Cooks' distance for Logistic Regression. CBAR measures the overall change in the fitted logits due to the deletion of the $i^{\text{th}}$ observation for all points excluding the one deleted (the $i^{\text{th}}$ point). It is computed as the square of the Pearson residual multiplied by the Hat value divided by (1 minus the Hat value) Confidence interval displacement diagnostic which measures the influence of deleting an individual observation.
DIFDEV	A statistic that measures the change in deviance that occurs when an observation is deleted from the input. It is computed as the square of the deviance residual plus CBAR.
DIFCHISQ	A statistic that measures the change in the Pearson chi-square statistic that occurs when an observation is deleted from the input. It is computed as CBAR divided by the Hat value.

**Global Details for GLM: Linear Regression**

The following table describes global details returned by a Linear Regression model.

**Table 31-27 Global Details for Linear Regression**

Name	Description
ADJUSTED_R_SQUARE	Adjusted R-Square
AIC	Akaike's information criterion
COEFF_VAR	Coefficient of variation
CONVERGED	Indicates whether the model build process has converged to specified tolerance. The following are the possible values: <ul style="list-style-type: none"> <li>• YES</li> <li>• NO</li> </ul>
CORRECTED_TOTAL_DF	Corrected total degrees of freedom
CORRECTED_TOT_SS	Corrected total sum of squares
DEPENDENT_MEAN	Dependent mean
ERROR_DF	Error degrees of freedom
ERROR_MEAN_SQUARE	Error mean square
ERROR_SUM_SQUARES	Error sum of squares
F_VALUE	Model $F$ value statistic
GMSEP	Estimated mean square error of the prediction, assuming multivariate normality
HOCKING_SP	Hocking $S_p$ statistic
ITERATIONS	Tracks the number of SGD iterations. Applicable only when the solver is SGD.
J_P	JP statistic (the final prediction error)
MODEL_DF	Model degrees of freedom
MODEL_F_P_VALUE	Model $F$ value probability
MODEL_MEAN_SQUARE	Model mean square error

**Table 31-27 (Cont.) Global Details for Linear Regression**

Name	Description
MODEL_SUM_SQUARES	Model sum of square errors
NUM_PARAMS	Number of parameters (the number of coefficients, including the intercept)
NUM_ROWS	Number of rows
R_SQ	R-Square
RANK_DEFICIENCY	The number of predictors excluded from the model due to multi-collinearity
ROOT_MEAN_SQ	Root mean square error
SBIC	Schwarz's Bayesian information criterion

**Global Details for GLM: Logistic Regression**

The following table returns global details returned by a Logistic Regression model.

**Table 31-28 Global Details for Logistic Regression**

Name	Description
AIC_INTERCEPT	Akaike's criterion for the fit of the baseline, intercept-only, model
AIC_MODEL	Akaike's criterion for the fit of the intercept and the covariates (predictors) mode
CONVERGED	Indicates whether the model build process has converged to specified tolerance. The following are the possible values: <ul style="list-style-type: none"> <li>• YES</li> <li>• NO</li> </ul>
DEPENDENT_MEAN	Dependent mean
ITERATIONS	Tracks the number of SGD iterations (number of IRLS iterations). Applicable only when the solver is SGD.
LR_DF	Likelihood ratio degrees of freedom
LR_CHI_SQ	Likelihood ratio chi-square value
LR_CHI_SQ_P_VALUE	Likelihood ratio chi-square probability value
NEG2_LL_INTERCEPT	-2 log likelihood of the baseline, intercept-only, model
NEG2_LL_MODEL	-2 log likelihood of the model
NUM_PARAMS	Number of parameters (the number of coefficients, including the intercept)
NUM_ROWS	Number of rows
PCT_CORRECT	Percent of correct predictions
PCT_INCORRECT	Percent of incorrectly predicted rows
PCT_TIED	Percent of cases where the estimated probabilities are equal for both target classes
PSEUDO_R_SQ_CS	Pseudo R-square Cox and Snell
PSEUDO_R_SQ_N	Pseudo R-square Nagelkerke

**Table 31-28 (Cont.) Global Details for Logistic Regression**

Name	Description
RANK_DEFICIENCY	The number of predictors excluded from the model due to multi-collinearity
SC_INTERCEPT	Schwarz's Criterion for the fit of the baseline, intercept-only, model
SC_MODEL	Schwarz's Criterion for the fit of the intercept and the covariates (predictors) model

 **Note:**

- When Ridge Regression is enabled, fewer global details are returned. For information about ridge, see *Oracle Data Mining Concepts*.
- When the value is `NULL` for a partitioned model, an exception is thrown. When the value is not null, it must contain the desired partition name.

**Related Topics**

- *Oracle Database PL/SQL Packages and Types Reference*
- [Model Detail Views for Global Information](#)  
Model detail views for Global Information describes global statistics view, alert view, and computed settings view. Oracle recommends that users leverage the model details views instead of `GET_MODEL_DETAILS_GLOBAL` function.

## 31.4.8 Model Detail Views for Naive Bayes

Model Detail Views for Naive Bayes describes prior view and result view. Oracle recommends that users leverage the model details views instead of the `GET_MODEL_DETAILS_NB` function.

The prior view `DM$VPmodel_name` describes the priors of the targets for Naïve Bayes. The view has the following schema:

Name	Type
PARTITION_NAME	VARCHAR2 (128)
TARGET_NAME	VARCHAR2 (128)
TARGET_VALUE	NUMBER/VARCHAR2
PRIOR_PROBABILITY	BINARY_DOUBLE
COUNT	NUMBER

**Table 31-29 Prior View for Naive Bayes**

Column Name	Description
PARTITION_NAME	The name of a feature in the model
TARGET_NAME	Name of the target column
TARGET_VALUE	Target value, numerical or categorical

**Table 31-29 (Cont.) Prior View for Naive Bayes**

Column Name	Description
PRIOR_PROBABILITY	Prior probability for a given TARGET_VALUE
COUNT	Number of rows for a given TARGET_VALUE

The Naïve Bayes result view `DM$VVMODEL_VIEW` describes the conditional probabilities of the Naïve Bayes model. The view has the following schema:

Name	Type
PARTITION_NAME	VARCHAR2 (128)
TARGET_NAME	VARCHAR2 (128)
TARGET_VALUE	NUMBER/VARCHAR2
ATTRIBUTE_NAME	VARCHAR2 (128)
ATTRIBUTE_SUBNAME	VARCHAR2 (4000)
ATTRIBUTE_VALUE	VARCHAR2 (4000)
CONDITIONAL_PROBABILITY	BINARY_DOUBLE
COUNT	NUMBER

**Table 31-30 Result View for Naive Bayes**

Column Name	Description
PARTITION_NAME	The name of a feature in the model
TARGET_NAME	Name of the target column
TARGET_VALUE	Target value, numerical or categorical
ATTRIBUTE_NAME	Column name
ATTRIBUTE_SUBNAME	Nested column subname. The value is null for non-nested columns.
ATTRIBUTE_VALUE	Mining attribute value for the column ATTRIBUTE_NAME or the nested column ATTRIBUTE_SUBNAME (if any).
CONDITIONAL_PROBABILITY	Conditional probability of a mining attribute for a given target
COUNT	Number of rows for a given mining attribute and a given target

The following table describes the global view for Naive Bayes.

**Table 31-31 Naive Bayes Statistics Information In Model Global View**

Name	Description
NUM_ROWS	The total number of rows used in the build

## 31.4.9 Model Detail Views for Neural Network

Model Detail Views for Neural Network describes the weights of the neurons: input layer and hidden layers. Oracle recommends that users leverage the model details views.

Neural Network algorithm has the following views:

Weights: `DM$VAModel_name`

The view `DM$VAModel_name` has the following schema:

Name	Type
PARTITION_NAME	VARCHAR2 (128)
LAYER	NUMBER
IDX_FROM	NUMBER
ATTRIBUTE_NAME	VARCHAR2 (128)
ATTRIBUTE_SUBNAME	VARCHAR2 (4000)
ATTRIBUTE_VALUE	VARCHAR2 (4000)
IDX_TO	NUMBER
TARGET_VALUE	NUMBER/VARCHAR2
WEIGHT	BINARY_DOUBLE

**Table 31-32 Weights View**

Column Name	Description
PARTITION_NAME	Partition name in a partitioned model
LAYER	Layer ID, 0 as an input layer
IDX_FROM	Node index that the weight connects from (attribute id for input layer)
ATTRIBUTE_NAME	Attribute name (only for the input layer)
ATTRIBUTE_SUBNAME	Attribute subname. The value is null for non-nested columns.
ATTRIBUTE_VALUE	Categorical attribute value
IDX_TO	Node index that the weights connects to
TARGET_VALUE	Target value. The value is null for regression.
WEIGHT	Value of the weight

The view `DM$VGModel_name` is a pre-existing view. The following name-value pairs are added to the view.

**Table 31-33 Neural Networks Statistics Information In Model Global View**

Name	Description
CONVERGED	Indicates whether the model build process has converged to specified tolerance. The following are the possible values: <ul style="list-style-type: none"> <li>• YES</li> <li>• NO</li> </ul>
ITERATIONS	Number of iterations
LOSS_VALUE	Loss function value (if it is with <code>NNET_REGULARIZER_HELDASIDE</code> regularization, it is the loss function value on test data)
NUM_ROWS	Number of rows in the model (or partitioned model)



## 31.4.10 Model Detail Views for Random Forest

Model Detail Views for Random Forest describes variable importance measures and statistics in global view. Oracle recommends that users leverage the model details views.

Random Forest algorithm has the following statistics views:

- Variable importance statistics `DM$VAmodeI_name`
- Random Forest statistics in model global view `DM$VGmodeI_name`

One of the important outputs from the Random Forest model build is a ranking of attributes based on their relative importance. This is measured using Mean Decrease Gini. The view `DM$VAmodeI_name` has the following schema:

Name	Type
-----	-----
PARTITION_NAME	VARCHAR2 (128)
ATTRIBUTE_NAME	VARCHAR2 (128)
ATTRIBUTE_SUBNAME	VARCHAR2 (128)
ATTRIBUTE_IMPORTANCE	BINARY_DOUBLE

**Table 31-34 Variable Importance Model View**

Column Name	Description
PARTITION_NAME	Partition name. The value is null for models which are not partitioned.
ATTRIBUTE_NAME	Column name
ATTRIBUTE_SUBNAME	Nested column subname. The value is null for non-nested columns.
ATTRIBUTE_IMPORTANCE	Measure of importance for an attribute in the forest (mean Decrease Gini value)

The view `DM$VGmodeI_name` is a pre-existing view. The following name-value pairs are added to the view.

**Table 31-35 Random Forest Statistics Information In Model Global View**

Name	Description
AVG_DEPTH	Average depth of the trees in the forest
AVG_NODECOUNT	Average number of nodes per tree
MAX_DEPTH	Maximum depth of the trees in the forest
MAX_NODECOUNT	Maximum number of nodes per tree
MIN_DEPTH	Minimum depth of the trees in the forest
MIN_NODECOUNT	Minimum number of nodes per tree
NUM_ROWS	The total number of rows used in the build

## 31.4.11 Model Detail View for Support Vector Machine

Model Detail View for Support Vector Machine describes linear coefficient view. Oracle recommends that users leverage the model details views instead of the `GET_MODEL_DETAILS_SVM` function.

The linear coefficient view `DM$VLmodel_name` describes the coefficients of a linear SVM algorithm. The `target_value` field in the view is present only for Classification and has the type of the target. Regression models do not have a `target_value` field.

The `reversed_coefficient` field shows the value of the coefficient after reversing the automatic data preparation transformations. If data preparation is disabled, then `coefficient` and `reversed_coefficient` have the same value. The view has the following schema:

Name	Type
PARTITION_NAME	VARCHAR2 (128)
TARGET_VALUE	NUMBER/VARCHAR2
ATTRIBUTE_NAME	VARCHAR2 (128)
ATTRIBUTE_SUBNAME	VARCHAR2 (4000)
ATTRIBUTE_VALUE	VARCHAR2 (4000)
COEFFICIENT	BINARY_DOUBLE
REVERSED_COEFFICIENT	BINARY_DOUBLE

**Table 31-36 Linear Coefficient View for Support Vector Machine**

Column Name	Description
PARTITION_NAME	Partition name in a partitioned model
TARGET_VALUE	Target value, numerical or categorical
ATTRIBUTE_NAME	Column name
ATTRIBUTE_SUBNAME	Nested column subname. The value is null for non-nested columns.
ATTRIBUTE_VALUE	Value of a categorical attribute
COEFFICIENT	Projection coefficient value
REVERSED_COEFFICIENT	Coefficient transformed on the original scale

The following table describes the Support Vector statistics global view.

**Table 31-37 Support Vector Statistics Information In Model Global View**

Name	Description
CONVERGED	Indicates whether the model build process has converged to specified tolerance: <ul style="list-style-type: none"> <li>• YES</li> <li>• NO</li> </ul>
ITERATIONS	Number of iterations performed during build
NUM_ROWS	Number of rows used for the build
REMOVED_ROWS_ZERO_NORM	Number of rows removed due to 0 norm. This applies to one-class linear models only.

## 31.4.12 Model Detail Views for Clustering Algorithms

Oracle Data Mining supports these clustering algorithms: Expectation Maximization, *k*-Means, and Orthogonal Partitioning Clustering (O-Cluster).

All clustering algorithms share the following views:

- Cluster description `DM$VDM $\textit{model\_name}$`
- Attribute statistics `DM$VAM $\textit{model\_name}$`
- Histogram statistics `DM$VHM $\textit{model\_name}$`
- Rule statistics `DM$VRM $\textit{model\_name}$`

The cluster description view `DM$VDM $\textit{model\_name}$`  describes cluster level information about a clustering model. The view has the following schema:

Name	Type
PARTITION_NAME	VARCHAR2 (128)
CLUSTER_ID	NUMBER
CLUSTER_NAME	NUMBER/VARCHAR2
RECORD_COUNT	NUMBER
PARENT	NUMBER
TREE_LEVEL	NUMBER
LEFT_CHILD_ID	NUMBER
RIGHT_CHILD_ID	NUMBER

**Table 31-38 Cluster Description View for Clustering Algorithm**

Column Name	Description
PARTITION_NAME	Partition name in a partitioned model
CLUSTER_ID	The ID of a cluster in the model
CLUSTER_NAME	Specifies the label of the cluster
RECORD_COUNT	Specifies the number of records
PARENT	The ID of the parent
TREE_LEVEL	Specifies the number of splits from the root
LEFT_CHILD_ID	The ID of the child cluster on the left side of the split
RIGHT_CHILD_ID	The ID of the child cluster on the right side of the split

The attribute view `DM$VAM $\textit{model\_name}$`  describes attribute level information about a Clustering model. The values of the mean, variance, and mode for a particular cluster can be obtained from this view. The view has the following schema:

Name	Type
PARTITION_NAME	VARCHAR2 (128)
CLUSTER_ID	NUMBER
CLUSTER_NAME	NUMBER/VARCHAR2
ATTRIBUTE_NAME	VARCHAR2 (128)
ATTRIBUTE_SUBNAME	VARCHAR2 (4000)

MEAN	BINARY_DOUBLE
VARIANCE	BINARY_DOUBLE
MODE_VALUE	VARCHAR2(4000)

**Table 31-39 Attribute View for Clustering Algorithm**

Column Name	Description
PARTITION_NAME	A partition in a partitioned model
CLUSTER_ID	The ID of a cluster in the model
CLUSTER_NAME	Specifies the label of the cluster
ATTRIBUTE_NAME	Specifies the attribute name
ATTRIBUTE_SUBNAME	Specifies the attribute subname
MEAN	The field returns the average value of a numeric attribute
VARIANCE	The variance of a numeric attribute
MODE_VALUE	The mode is the most frequent value of a categorical attribute

The histogram view `DM$VHmodel_name` describes histogram level information about a Clustering model. The bin information as well as bin counts can be obtained from this view. The view has the following schema:

Name	Type
PARTITION_NAME	VARCHAR2(128)
CLUSTER_ID	NUMBER
CLUSTER_NAME	NUMBER/VARCHAR2
ATTRIBUTE_NAME	VARCHAR2(128)
ATTRIBUTE_SUBNAME	VARCHAR2(4000)
BIN_ID	NUMBER
LOWER_BIN_BOUNDARY	BINARY_DOUBLE
UPPER_BIN_BOUNDARY	BINARY_DOUBLE
ATTRIBUTE_VALUE	VARCHAR2(4000)
COUNT	NUMBER

**Table 31-40 Histogram View for Clustering Algorithm**

Column Name	Description
PARTITION_NAME	A partition in a partitioned model
CLUSTER_ID	The ID of a cluster in the model
CLUSTER_NAME	Specifies the label of the cluster
ATTRIBUTE_NAME	Specifies the attribute name
ATTRIBUTE_SUBNAME	Specifies the attribute subname
BIN_ID	Bin ID
LOWER_BIN_BOUNDARY	Numeric lower bin boundary
UPPER_BIN_BOUNDARY	Numeric upper bin boundary
ATTRIBUTE_VALUE	Categorical attribute value
COUNT	Histogram count

The rule view `DM$VRmodel_name` describes the rule level information about a Clustering model. The information is provided at attribute predicate level. The view has the following schema:

Name	Type
PARTITION_NAME	VARCHAR2 (128)
CLUSTER_ID	NUMBER
CLUSTER_NAME	NUMBER/VARCHAR2
ATTRIBUTE_NAME	VARCHAR2 (128)
ATTRIBUTE_SUBNAME	VARCHAR2 (4000)
OPERATOR	VARCHAR2 (2)
NUMERIC_VALUE	NUMBER
ATTRIBUTE_VALUE	VARCHAR2 (4000)
SUPPORT	NUMBER
CONFIDENCE	BINARY_DOUBLE
RULE_SUPPORT	NUMBER
RULE_CONFIDENCE	BINARY_DOUBLE

**Table 31-41 Rule View for Clustering Algorithm**

Column Name	Description
PARTITION_NAME	A partition in a partitioned model
CLUSTER_ID	The ID of a cluster in the model
CLUSTER_NAME	Specifies the label of the cluster
ATTRIBUTE_NAME	Specifies the attribute name
ATTRIBUTE_SUBNAME	Specifies the attribute subname
OPERATOR	Attribute predicate operator - a conditional operator taking the following values: <i>IN</i> , =, <>, <, >, <=, and >=
NUMERIC_VALUE	Numeric lower bin boundary
ATTRIBUTE_VALUE	Categorical attribute value
SUPPORT	Attribute predicate support
CONFIDENCE	Attribute predicate confidence
RULE_SUPPORT	Rule level support
RULE_CONFIDENCE	Rule level confidence

### 31.4.13 Model Detail Views for Expectation Maximization

Model detail views for Expectation Maximization (EM) describes the differences in the views for EM against those of Clustering views. Oracle recommends that user leverage the model details views instead of the `GET_MODEL_DETAILS_EM` function.

The following views are the differences in the views for Expectation Maximization against Clustering views. For an overview of the different Clustering views, refer to "Model Detail Views for Clustering Algorithms".

The component view `DM$VOModel_name` describes the EM components. The component view contains information about their prior probabilities and what cluster they map to. The view has the following schema:

Name	Type
PARTITION_NAME	VARCHAR2 (128)
COMPONENT_ID	NUMBER
CLUSTER_ID	NUMBER
PRIOR_PROBABILITY	BINARY_DOUBLE

**Table 31-42 Component View**

Column Name	Description
PARTITION_NAME	Partition name in a partitioned model
COMPONENT_ID	Unique identifier of a component
CLUSTER_ID	The ID of a cluster in the model
PRIOR_PROBABILITY	Component prior probability

The mean and variance component view `DM$VMModel_name` provides information about the mean and variance parameters for the attributes by Gaussian distribution models. The view has the following schema:

Name	Type
PARTITION_NAME	VARCHAR2 (128)
COMPONENT_ID	NUMBER
ATTRIBUTE_NAME	VARCHAR2 (4000)
MEAN	BINARY_DOUBLE
VARIANCE	BINARY_DOUBLE

The frequency component view `DM$VFModel_name` provides information about the parameters of the multi-valued Bernoulli distributions used by the EM model. The view has the following schema:

Name	Type
PARTITION_NAME	VARCHAR2 (128)
COMPONENT_ID	NUMBER
ATTRIBUTE_NAME	VARCHAR2 (4000)
ATTRIBUTE_VALUE	VARCHAR2 (4000)
FREQUENCY	BINARY_DOUBLE

**Table 31-43 Frequency Component View**

Column Name	Description
PARTITION_NAME	Partition name in a partitioned model
COMPONENT_ID	Unique identifier of a component
ATTRIBUTE_NAME	Column name

**Table 31-43 (Cont.) Frequency Component View**

Column Name	Description
ATTRIBUTE_VALUE	Categorical attribute value
FREQUENCY	The frequency of the multivalued Bernoulli distribution for the attribute/value combination specified by ATTRIBUTE_NAME and ATTRIBUTE_VALUE.

For 2-Dimensional columns, EM provides an attribute ranking similar to that of Attribute Importance. This ranking is based on a rank-weighted average over Kullback–Leibler divergence computed for pairs of columns. This unsupervised Attribute Importance is shown in the `DM$VI $\textit{model\_name}$`  view and has the following schema:

Name	Type
-----	-----
PARTITION_NAME	VARCHAR2 (128)
ATTRIBUTE_NAME	VARCHAR2 (128)
ATTRIBUTE_IMPORTANCE_VALUE	BINARY_DOUBLE
ATTRIBUTE_RANK	NUMBER

**Table 31-44 2-Dimensional Attribute Ranking for Expectation Maximization**

Column Name	Description
PARTITION_NAME	Partition name in a partitioned model
ATTRIBUTE_NAME	Column name
ATTRIBUTE_IMPORTANCE_VALUE	Importance value
ATTRIBUTE_RANK	An attribute rank based on the importance value

The pairwise Kullback–Leibler divergence is reported in the `DM$VB $\textit{model\_name}$`  view. This metric evaluates how much the observed joint distribution of two attributes diverges from the expected distribution under the assumption of independence. That is, the higher the value, the more dependent the two attributes are. The dependency value is scaled based on the size of the grid used for each pairwise computation. That ensures that all values fall within the [0; 1] range and are comparable. The view has the following schema:

Name	Type
-----	-----
PARTITION_NAME	VARCHAR2 (128)
ATTRIBUTE_NAME_1	VARCHAR2 (128)
ATTRIBUTE_NAME_2	VARCHAR2 (128)
DEPENDENCY	BINARY_DOUBLE

**Table 31-45 Kullback-Leibler Divergence for Expectation Maximization**

Column Name	Description
PARTITION_NAME	Partition name in a partitioned model
ATTRIBUTE_NAME_1	Name of an attribute 1
ATTRIBUTE_NAME_2	Name of an attribute 2

**Table 31-45 (Cont.) Kullback-Leibler Divergence for Expectation Maximization**

Column Name	Description
DEPENDENCY	Scaled pairwise Kullback-Leibler divergence

The projection table `DM$VPmodel_name` shows the coefficients used by random projections to map nested columns to a lower dimensional space. The view has rows only when nested or text data is present in the build data. The view has the following schema:

Name	Type
PARTITION_NAME	VARCHAR2 (128)
FEATURE_NAME	VARCHAR2 (4000)
ATTRIBUTE_NAME	VARCHAR2 (128)
ATTRIBUTE_SUBNAME	VARCHAR2 (4000)
ATTRIBUTE_VALUE	VARCHAR2 (4000)
COEFFICIENT	NUMBER

**Table 31-46 Projection table for Expectation Maximization**

Column Name	Description
PARTITION_NAME	Partition name in a partitioned model
FEATURE_NAME	Name of feature
ATTRIBUTE_NAME	Column name
ATTRIBUTE_SUBNAME	Nested column subname. The value is null for non-nested columns.
ATTRIBUTE_VALUE	Categorical attribute value
COEFFICIENT	Projection coefficient. The representation is sparse; only the non-zero coefficients are returned.

### Global Details for Expectation Maximization

The following table describes global details for Expectation Maximization.

**Table 31-47 Global Details for Expectation Maximization**

Name	Description
CONVERGED	Indicates whether the model build process has converged to specified tolerance. The possible values are: <ul style="list-style-type: none"> <li>• YES</li> <li>• NO</li> </ul>
LOGLIKELIHOOD	Loglikelihood on the build data
NUM_COMPONENTS	Number of components produced by the model
NUM_CLUSTERS	Number of clusters produced by the model
NUM_ROWS	Number of rows used in the build
RANDOM_SEED	The random seed value used for the model build
REMOVED_COMPONENTS	The number of empty components excluded from the model



**Related Topics**

- [Model Detail Views for Clustering Algorithms](#)  
Oracle Data Mining supports these clustering algorithms: Expectation Maximization, *k*-Means, and Orthogonal Partitioning Clustering (O-Cluster).

## 31.4.14 Model Detail Views for *k*-Means

Model detail views for *k*-Means (KM) describes cluster description view and scoring view. Oracle recommends that you leverage model details view instead of `GET_MODEL_DETAILS_KM` function.

This section describes the differences in the views for *k*-Means against the Clustering views. For an overview of the different views, refer to "Model Detail Views for Clustering Algorithms". For *k*-Means, the cluster description view `DM$VDMmodel_name` has an additional column:

Name	Type
DISPERSION	BINARY_DOUBLE

**Table 31-48 Cluster Description for *k*-Means**

Column Name	Description
DISPERSION	A measure used to quantify whether a set of observed occurrences are dispersed compared to a standard statistical model.

The scoring view `DM$VCmodel_name` describes the centroid of each leaf clusters:

Name	Type
PARTITION_NAME	VARCHAR2(128)
CLUSTER_ID	NUMBER
CLUSTER_NAME	NUMBER/VARCHAR2
ATTRIBUTE_NAME	VARCHAR2(128)
ATTRIBUTE_SUBNAME	VARCHAR2(4000)
ATTRIBUTE_VALUE	VARCHAR2(4000)
VALUE	BINARY_DOUBLE

**Table 31-49 Scoring View for *k*-Means**

Column Name	Description
PARTITION_NAME	Partition name in a partitioned model
CLUSTER_ID	The ID of a cluster in the model
CLUSTER_NAME	Specifies the label of the cluster
ATTRIBUTE_NAME	Column name
ATTRIBUTE_SUBNAME	Nested column subname. The value is null for non-nested columns.
ATTRIBUTE_VALUE	Categorical attribute value
VALUE	Specifies the centroid value

The following table describes global view for *k*-Means.

**Table 31-50** *k*-Means Statistics Information In Model Global View

Name	Description
CONVERGED	Indicates whether the model build process has converged to specified tolerance. The following are the possible values: <ul style="list-style-type: none"> <li>• YES</li> <li>• NO</li> </ul>
NUM_ROWS	Number of rows used in the build
REMOVED_ROWS_ZERO_NORM	Number of rows removed due to 0 norm. This applies only to models using cosine distance.

#### Related Topics

- [Model Detail Views for Clustering Algorithms](#)  
Oracle Data Mining supports these clustering algorithms: Expectation Maximization, *k*-Means, and Orthogonal Partitioning Clustering (O-Cluster).

## 31.4.15 Model Detail Views for O-Cluster

Model Detail Views for O-Cluster describes the statistics views. Oracle recommends that user leverage the model details views instead of the `GET_MODEL_DETAILS_OC` function.

The following are the differences in the views for O-Cluster against Clustering views. For an overview of the different clustering views, refer to "Model Detail Views for Clustering Algorithms". The OC algorithm uses the same descriptive statistics views as Expectation Maximization (EM) and *k*-Means (KM). The following are the statistics views:

- Cluster description `DM$VDMmodel_name`
- Attribute statistics `DM$VAModel_name`
- Rule statistics `DM$VRmodel_name`
- Histogram statistics `DM$VHmodel_name`

The Cluster description view `DM$VDMmodel_name` describes the O-Cluster components. The cluster description view has additional fields that specify the split predicate. The view has the following schema:

Name	Type
ATTRIBUTE_NAME	VARCHAR2(128)
ATTRIBUTE_SUBNAME	VARCHAR2(4000)
OPERATOR	VARCHAR2(2)
VALUE	SYS.XMLTYPE

**Table 31-51** Description View

Column Name	Description
ATTRIBUTE_NAME	Column name

**Table 31-51 (Cont.) Description View**

Column Name	Description
ATTRIBUTE_SUBNAME	Nested column subname. The value is null for non-nested columns.
OPERATOR	Split operator
VALUE	List of split values

The structure of the SYS.XMLTYPE is as follows:

```
<Element>splitval1</Element>
```

The OC algorithm uses a histogram view `DM$VHmodel_name` with a different schema than EM and k-Means (KM). The view has the following schema:

Name	Type
PARTITON_NAME	VARCHAR2 (128)
CLUSTER_ID	NUMBER
ATTRIBUTE_NAME	VARCHAR2 (128)
ATTRIBUTE_SUBNAME	VARCHAR2 (4000)
BIN_ID	NUMBER
LABEL	VARCHAR2 (4000)
COUNT	NUMBER

**Table 31-52 Histogram Component View**

Column Name	Description
PARTITION_NAME	Partition name in a partitioned model
CLUSTER_ID	Unique identifier of a component
ATTRIBUTE_NAME	Column name
ATTRIBUTE_SUBNAME	Nested column subname. The value is null for non-nested columns.
BIN_ID	Unique identifier
LABEL	Bin label
COUNT	Bin histogram count

The following table describes the global view for O-Cluster.

**Table 31-53 O-Cluster Statistics Information In Model Global View**

Name	Description
NUM_ROWS	The total number of rows used in the build

**Related Topics**

- [Model Detail Views for Clustering Algorithms](#)  
Oracle Data Mining supports these clustering algorithms: Expectation Maximization, *k*-Means, and Orthogonal Partitioning Clustering (O-Cluster).

## 31.4.16 Model Detail Views for CUR Matrix Decomposition

Model Detail Views for CUR matrix decomposition describe scores and ranks of attributes and rows.

CUR matrix decomposition algorithm has the following views:

Attribute importance and rank: `DM$VCmodel_name`

Row importance and rank: `DM$VRmodel_name`

Global statistics: `DM$VG`

The Attribute Importance and Rank view `DM$VCmodel_name` has the following schema:

Name	Type
-----	-----
PARTITION_NAME	VARCHAR2 (128)
ATTRIBUTE_NAME	VARCHAR2 (128)
ATTRIBUTE_SUBNAME	VARCHAR2 (4000)
ATTRIBUTE_VALUE	VARCHAR2 (4000)
ATTRIBUTE_IMPORTANCE	NUMBER
ATTRIBUTE_RANK	NUMBER

**Table 31-54 Attribute Importance and Rank View**

Column Name	Description
PARTITION_NAME	Partition name in a partitioned model
ATTRIBUTE_NAME	Attribute name
ATTRIBUTE_SUBNAME	Attribute subname. The value is null for non-nested columns.
ATTRIBUTE_VALUE	Value of the attribute
ATTRIBUTE_IMPORTANCE	Attribute leverage score
ATTRIBUTE_RANK	Attribute rank based on leverage score

The view `DM$VRmodel_name` exposes the leverage scores and ranks of all selected rows through a view. This view is created when users decide to perform row importance and the `CASE_ID` column is present. The view has the following schema:

Name	Type
-----	-----
PARTITION_NAME	VARCHAR2 (128)
CASE_ID	Original cid data types, including NUMBER, VARCHAR2, DATE, TIMESTAMP, TIMESTAMP WITH TIME ZONE, TIMESTAMP WITH LOCAL TIME ZONE

ROW_IMPORTANCE	NUMBER
ROW_RANK	NUMBER

**Table 31-55 Row Importance and Rank View**

Column Name	Description
PARTITION_NAME	Partition name in a partitioned model
CASE_ID	Case ID. The supported case ID types are the same as that supported for GLM, SVD, and ESA algorithms.
ROW_IMPORTANCE	Row leverage score
ROW_RANK	Row rank based on leverage score

The following table describes global statistics for CUR Matrix Decomposition.

**Table 31-56 CUR Matrix Decomposition Statistics Information In Model Global View.**

Name	Description
NUM_COMPONENTS	Number of SVD components (SVD rank)
NUM_ROWS	Number of rows used in the model build

## 31.4.17 Model Detail Views for Explicit Semantic Analysis

Model Detail Views for Explicit Semantic Analysis (ESA) describes attribute statistics view and feature view. Oracle recommends that users leverage the model details view.

ESA algorithm has the following views:

- Explicit Semantic Analysis Matrix `DM$VAmodeI_name`: This view has different schemas for Feature Extraction and Classification. For Feature Extraction, this view contains model attribute coefficients per feature. For Classification, this view contains model attribute coefficients per target class.
- Explicit Semantic Analysis Features `DM$VFmodeI_name`: This view is applicable for only Feature Extraction.

The view `DM$VAmodeI_name` has the following schema for Feature Extraction:

PARTITION_NAME	VARCHAR2(128)
FEATURE_ID	NUMBER/VARHCAR2, DATE, TIMESTAMP, TIMESTAMP WITH TIME ZONE, TIMESTAMP WITH LOCAL TIME ZONE
ATTRIBUTE_NAME	VARCHAR2(128)
ATTRIBUTE_SUBNAME	VARCHAR2(4000)
ATTRIBUTE_VALUE	VARCHAR2(4000)
COEFFICIENT	BINARY_DOUBLE

**Table 31-57 Explicit Semantic Analysis Matrix for Feature Extraction**

Column Name	Description
PARTITION_NAME	Partition name in a partitioned model

**Table 31-57 (Cont.) Explicit Semantic Analysis Matrix for Feature Extraction**

Column Name	Description
FEATURE_ID	Unique identifier of a feature as it appears in the training data
ATTRIBUTE_NAME	Column name
ATTRIBUTE_SUBNAME	Nested column subname. The value is null for non-nested columns.
ATTRIBUTE_VALUE	Categorical attribute value
COEFFICIENT	A measure of the weight of the attribute with respect to the feature

The `DM$VAmodeI_name` view comprises attribute coefficients for all target classes.

The view `DM$VAmodeI_name` has the following schema for Classification:

Name	Type
PARTITION_NAME	VARCHAR2 (128)
TARGET_VALUE	NUMBER/VARCHAR2
ATTRIBUTE_NAME	VARCHAR2 (128)
ATTRIBUTE_SUBNAME	VARCHAR2 (4000)
ATTRIBUTE_VALUE	VARCHAR2 (4000)
COEFFICIENT	BINARY_DOUBLE

**Table 31-58 Explicit Semantic Analysis Matrix for Classification**

Column Name	Description
PARTITION_NAME	Partition name in a partitioned model
TARGET_VALUE	Value of the target
ATTRIBUTE_NAME	Column name
ATTRIBUTE_SUBNAME	Nested column subname. The value is null for non-nested columns.
ATTRIBUTE_VALUE	Categorical attribute value
COEFFICIENT	A measure of the weight of the attribute with respect to the feature

The view `DM$VFmodeI_name` has a unique row for every feature in one view. This feature is helpful if the model was pre-built and the source training data are not available. The view has the following schema:

Name	Type
PARTITION_NAME	VARCHAR2 (128)
FEATURE_ID	NUMBER/VARHCAR2, DATE, TIMESTAMP, TIMESTAMP WITH TIME ZONE, TIMESTAMP WITH LOCAL TIME ZONE

**Table 31-59 Explicit Semantic Analysis Features for Explicit Semantic Analysis**

Column Name	Description
PARTITION_NAME	Partition name in a partitioned model
FEATURE_ID	Unique identifier of a feature as it appears in the training data

The following table describes the global view for Explicit Semantic Analysis.

**Table 31-60 Explicit Semantic Analysis Statistics Information In Model Global View**

Name	Description
NUM_ROWS	The total number of input rows
REMOVED_ROWS_BY_FILTERS	Number of rows removed by filters

## 31.4.18 Model Detail Views for Exponential Smoothing Models

Model Detail Views for Exponential Smoothing Model (ESM) describes the views for model output and global information. Oracle recommends that users leverage the model details views.

Exponential Smoothing Model algorithm has the following views:

Model output: `DM$VPEmodel_name`

Model global information: `DM$VGMmodel_name`

Model output: This view gives the result of ESM model. The output has a set of records such as `partition`, `CASE_ID`, `value`, `prediction`, `lower`, `upper`, and so on and ordered by `partition` and `CASE_ID` (time). Each partition has a separate smoothing model. For a given partition, for each time (`CASE_ID`) point that the input time series covers, the value is the observed or accumulated value at the time point, and the prediction is the one-step-ahead forecast at that time point. For each time point (future prediction) beyond the range of input time series, the value is `NULL`, and the prediction is the model forecast for that time point. Lower and upper are the lower bound and upper bound of the user specified confidence interval for the prediction.

Model global Information: This view gives the global information of the model along with the estimated smoothing constants, the estimated initial state, and global diagnostic measures.

Depending on the type of model, the global diagnostics include some or all of the following for Exponential Smoothing.

**Table 31-61 Exponential Smoothing Model Statistics Information In Model Global View**

Name	Description
-2 LOG-LIKELIHOOD	Negative log-likelihood of model
ALPHA	Smoothing constant
AIC	Akaike information criterion
AICC	Corrected Akaike information criterion
AMSE	Average mean square error over user-specified time window

**Table 31-61 (Cont.) Exponential Smoothing Model Statistics Information In Model Global View**

Name	Description
BETA	Trend smoothing constant
BIC	Bayesian information criterion
GAMMA	Seasonal smoothing constant
INITIAL LEVEL	Model estimate of value one time interval prior to start of observed series
INITIAL SEASON <i>i</i>	Model estimate of seasonal effect for season <i>i</i> one time interval prior to start of observed series
INITIAL TREND	Model estimate of trend one time interval prior to start of observed series
MAE	Model mean absolute error
MSE	Model mean square error
PHI	Damping parameter
STD	Model standard error
SIGMA	Model standard deviation of residuals

### 31.4.19 Model Detail Views for Non-Negative Matrix Factorization

Model detail views for Non-Negative Matrix Factorization (NMF) describes encoding H matrix view and H inverse matrix view. Oracle recommends that users leverage the model details views instead of the `GET_MODEL_DETAILS_NMF` function.

The NMF algorithm has two matrix content views:

- Encoding (H) matrix `DM$VEmodel_name`
- H inverse matrix `DM$VImodel_name`

The view `DM$VEmodel_name` describes the encoding (H) matrix of an NMF model. The `FEATURE_NAME` column type may be either `NUMBER` or `VARCHAR2`. The view has the following schema definition.

Name	Type
PARTITION_NAME	VARCHAR2(128)
FEATURE_ID	NUMBER
FEATURE_NAME	NUMBER/VARCHAR2
ATTRIBUTE_NAME	VARCHAR2(128)
ATTRIBUTE_SUBNAME	VARCHAR2(4000)
ATTRIBUTE_VALUE	VARCHAR2(4000)
COEFFICIENT	BINARY_DOUBLE

**Table 31-62 Encoding H Matrix View for Non-Negative Matrix Factorization**

Column Name	Description
PARTITION_NAME	Partition name in a partitioned model



**Table 31-62 (Cont.) Encoding H Matrix View for Non-Negative Matrix Factorization**

Column Name	Description
FEATURE_ID	The ID of a feature in the model
FEATURE_NAME	The name of a feature in the model
ATTRIBUTE_NAME	Column name
ATTRIBUTE_SUBNAME	Nested column subname. The value is null for non-nested columns.
ATTRIBUTE_VALUE	Specifies the value of attribute
COEFFICIENT	The attribute encoding that represents its contribution to the feature

The view `DM$VIModel_view` describes the inverse H matrix of an NMF model. The `FEATURE_NAME` column type may be either `NUMBER` or `VARCHAR2`. The view has the following schema:

Name	Type
PARTITION_NAME	VARCHAR2(128)
FEATURE_ID	NUMBER
FEATURE_NAME	NUMBER/VARCHAR2
ATTRIBUTE_NAME	VARCHAR2(128)
ATTRIBUTE_SUBNAME	VARCHAR2(4000)
ATTRIBUTE_VALUE	VARCHAR2(4000)
COEFFICIENT	BINARY_DOUBLE

**Table 31-63 Inverse H Matrix View for Non-Negative Matrix Factorization**

Column Name	Description
PARTITION_NAME	Partition name in a partitioned model
FEATURE_ID	The ID of a feature in the model
FEATURE_NAME	The name of a feature in the model
ATTRIBUTE_NAME	Column name
ATTRIBUTE_SUBNAME	Nested column subname. The value is null for non-nested columns.
ATTRIBUTE_VALUE	Specifies the value of attribute
COEFFICIENT	The attribute encoding that represents its contribution to the feature

The following table describes the global statistics for Non-Negative Matrix Factorization.

**Table 31-64 Non-Negative Matrix Factorization Statistics Information In Model Global View**

Name	Description
CONV_ERROR	Convergence error

**Table 31-64 (Cont.) Non-Negative Matrix Factorization Statistics Information In Model Global View**

Name	Description
CONVERGED	Indicates whether the model build process has converged to specified tolerance. The following are the possible values: <ul style="list-style-type: none"> <li>• YES</li> <li>• NO</li> </ul>
ITERATIONS	Number of iterations performed during build
NUM_ROWS	Number of rows used in the build input dataset
SAMPLE_SIZE	Number of rows used by the build

## 31.4.20 Model Detail Views for Singular Value Decomposition

Model detail views for Singular Value Decomposition (SVD) describes S Matrix view, right-singular vectors view, and left-singular vector view. Oracle recommends that users leverage the model details views instead of the `GET_MODEL_DETAILS_SVD` function.

The `DM$VEmodel_name` view leverages the fact that each singular value in the SVD model has a corresponding principal component in the associated Principal Components Analysis (PCA) model to relate a common set of information for both classes of models. For a SVD model, it describes the content of the S matrix. When PCA scoring is selected as a build setting, the variance and percentage cumulative variance for the corresponding principal components are shown as well. The view has the following schema:

Name	Type
PARTITION_NAME	VARCHAR2(128)
FEATURE_ID	NUMBER
FEATURE_NAME	NUMBER/VARCHAR2
VALUE	BINARY_DOUBLE
VARIANCE	BINARY_DOUBLE
PCT_CUM_VARIANCE	BINARY_DOUBLE

**Table 31-65 S Matrix View**

Column Name	Description
PARTITION_NAME	Partition name in a partitioned model
FEATURE_ID	The ID of a feature in the model
FEATURE_NAME	The name of a feature in the model
VALUE	The matrix entry value

**Table 31-65 (Cont.) S Matrix View**

Column Name	Description
VARIANCE	<p>The variance explained by a component. This column is only present for SVD models with setting <code>dbms_data_mining.svds_scoring_mode</code> set to <code>dbms_data_mining.svds_scoring_pca</code>.</p> <p>This column is non-null only if the build data is centered, either manually or because of the following setting: <code>dbms_data_mining.prep_auto</code> is set to <code>dbms_data_mining.prep_auto_on</code>.</p>
PCT_CUM_VARIANCE	<p>The percent cumulative variance explained by the components thus far. The components are ranked by the explained variance in descending order.</p> <p>This column is only present for SVD models with setting <code>dbms_data_mining.svds_scoring_mode</code> set to <code>dbms_data_mining.svds_scoring_pca</code>.</p> <p>This column is non-null only if the build data is centered, either manually or because of the following setting: <code>dbms_data_mining.prep_auto</code> is set to <code>dbms_data_mining.prep_auto_on</code>.</p>

The SVD `DM$VVmodel_view` describes the right-singular vectors of SVD model. For a PCA model it describes the principal components (eigenvectors). The view has the following schema:

Name	Type
PARTITION_NAME	VARCHAR2(128)
FEATURE_ID	NUMBER
FEATURE_NAME	NUMBER/VARCHAR2
ATTRIBUTE_NAME	VARCHAR2(128)
ATTRIBUTE_SUBNAME	VARCHAR2(4000)
ATTRIBUTE_VALUE	VARCHAR2(4000)
VALUE	BINARY_DOUBLE

**Table 31-66 Right-singular Vectors of Singular Value Decomposition**

Column Name	Description
PARTITION_NAME	Partition name in a partitioned model
FEATURE_ID	The ID of a feature in the model
FEATURE_NAME	The name of a feature in the model
ATTRIBUTE_NAME	Column name
ATTRIBUTE_SUBNAME	Nested column subname. The value is null for non-nested columns.
ATTRIBUTE_VALUE	Categorical attribute value. For numerical attributes, <code>ATTRIBUTE_VALUE</code> is null.
VALUE	The matrix entry value

The view `DM$VUModel_name` describes the left-singular vectors of a SVD model. For a PCA model, it describes the projection of the data in the principal components. This view does not exist unless the settings `dbms_data_mining.svds_u_matrix_output` is set to `dbms_data_mining.svds_u_matrix_enable`. The view has the following schema:

Name	Type
PARTITION_NAME	VARCHAR2(128)
CASE_ID	NUMBER/VARCHAR2, DATE, TIMESTAMP, TIMESTAMP WITH TIME ZONE, TIMESTAMP WITH LOCAL TIME ZONE
FEATURE_ID	NUMBER
FEATURE_NAME	NUMBER/VARCHAR2
VALUE	BINARY_DOUBLE

**Table 31-67 Left-singular Vectors of Singular Value Decomposition or Projection Data in Principal Components**

Column Name	Description
PARTITION_NAME	Partition name in a partitioned model
CASE_ID	Unique identifier of the row in the build data described by the <b>U</b> matrix projection.
FEATURE_ID	The ID of a feature in the model
FEATURE_NAME	The name of a feature in the model
VALUE	The matrix entry value

### Global Details for Singular Value Decomposition

The following table describes a global detail for Singular Value Decomposition.

**Table 31-68 Global Details for Singular Value Decomposition**

Name	Description
NUM_COMPONENTS	Number of features (components) produced by the model
NUM_ROWS	The total number of rows used in the build
SUGGESTED_CUTOFF	Suggested cutoff that indicates how many of the top computed features capture most of the variance in the model. Using only the features below this cutoff would be a reasonable strategy for dimensionality reduction.

### Related Topics

- [Oracle Database PL/SQL Packages and Types Reference](#)

## 31.4.21 Model Detail View for Minimum Description Length

Model detail view for Minimum Description Length (for calculating Attribute Importance) describes Attribute Importance view. Oracle recommends that users leverage the model details views instead of the `GET_MODEL_DETAILS_AI` function.

The Attribute Importance view `DM$VAmode1_name` describes the Attribute Importance as well as the Attribute Importance rank. The view has the following schema:

Name	Type
-----	-----
PARTITION_NAME	VARCHAR2 (128)
ATTRIBUTE_NAME	VARCHAR2 (128)
ATTRIBUTE_SUBNAME	VARCHAR2 (4000)
ATTRIBUTE_IMPORTANCE_VALUE	BINARY_DOUBLE
ATTRIBUTE_RANK	NUMBER

**Table 31-69 Attribute Importance View for Minimum Description Length**

Column Name	Description
PARTITION_NAME	Partition name in a partitioned model
ATTRIBUTE_NAME	Column name
ATTRIBUTE_SUBNAME	Nested column subname. The value is null for non-nested columns.
ATTRIBUTE_IMPORTANCE_VALUE	Importance value
ATTRIBUTE_RANK	Rank based on importance

The following table describes the global view for Minimum Description Length.

**Table 31-70 Minimum Description Length Statistics Information In Model Global View**

Name	Description
NUM_ROWS	The total number of rows used in the build

## 31.4.22 Model Detail View for Binning

The binning view `DM$VB` describes the bin boundaries used in the automatic data preparation.

The view has the following schema:

Name	Type
-----	-----
PARTITION_NAME	VARCHAR2 (128)
ATTRIBUTE_NAME	VARCHAR2 (128)
ATTRIBUTE_SUBNAME	VARCHAR2 (4000)
BIN_ID	NUMBER
LOWER_BIN_BOUNDARY	BINARY_DOUBLE
UPPER_BIN_BOUNDARY	BINARY_DOUBLE
ATTRIBUTE_VALUE	VARCHAR2 (4000)

**Table 31-71 Model Details View for Binning**

Column Name	Description
PARTITION_NAME	Partition name in a partitioned model
ATTRIBUTE_NAME	Specifies the attribute name
ATTRIBUTE_SUBNAME	Specifies the attribute subname
BIN_ID	Bin ID (or bin identifier)
LOWER_BIN_BOUNDARY	Numeric lower bin boundary
UPPER_BIN_BOUNDARY	Numeric upper bin boundary
ATTRIBUTE_VALUE	Categorical value

### 31.4.23 Model Detail Views for Global Information

Model detail views for Global Information describes global statistics view, alert view, and computed settings view. Oracle recommends that users leverage the model details views instead of `GET_MODEL_DETAILS_GLOBAL` function.

The global statistics view `DM$VGMmodel_name` describes global statistics related to the model build. Examples include the number of rows used in the build, the convergence status, and the model quality metrics. The view has the following schema:

Name	Type
-----	-----
PARTITION_NAME	VARCHAR2(128)
NAME	VARCHAR2(30)
NUMERIC_VALUE	NUMBER
STRING_VALUE	VARCHAR2(4000)

**Table 31-72 Global Statistics View**

Column Name	Description
PARTITION_NAME	Partition name in a partitioned model
NAME	Name of the statistic
NUMERIC_VALUE	Numeric value of the statistic
STRING_VALUE	Categorical value of the statistic

The alert view `DM$VVMmodel_name` lists alerts issued during the model build. The view has the following schema:

Name	Type
-----	-----
PARTITION_NAME	VARCHAR2(128)
ERROR_NUMBER	BINARY_DOUBLE
ERROR_TEXT	VARCHAR2(4000)

**Table 31-73 Alert View**

Column Name	Description
PARTITION_NAME	Partition name in a partitioned model
ERROR_NUMBER	Error number (valid when event is Error)
ERROR_TEXT	Error message

The computed settings view `DM$VSMODEL_name` lists the algorithm computed settings. The view has the following schema:

Name	Type
-----	-----
PARTITION_NAME	VARCHAR2 (128)
SETTING_NAME	VARCHAR2 (30)
SETTING_VALUE	VARCHAR2 (4000)

**Table 31-74 Computed Settings View**

Column Name	Description
PARTITION_NAME	Partition name in a partitioned model
SETTING_NAME	Name of the setting
SETTING_VALUE	Value of the setting

## 31.4.24 Model Detail View for Normalization and Missing Value Handling

The Normalization and Missing Value Handling View `DM$VN` describes the normalization parameters used in Automatic Data Preparation (ADP) and the missing value replacement when a `NULL` value is encountered. Missing value replacement applies only to the two-dimensional columns and does not apply to the nested columns.

The view has the following schema:

Name	Type
-----	-----
PARTITION_NAME	VARCHAR2 (128)
ATTRIBUTE_NAME	VARCHAR2 (128)
ATTRIBUTE_SUBNAME	VARCHAR2 (4000)
NUMERIC_MISSING_VALUE	BINARY_DOUBLE
CATEGORICAL_MISSING_VALUE	VARCHAR2 (4000)
NORMALIZATION_SHIFT	BINARY_DOUBLE
NORMALIZATION_SCALE	BINARY_DOUBLE

**Table 31-75 Normalization and Missing Value Handling View**

Column Name	Description
PARTITION_NAME	A partition in a partitioned model
ATTRIBUTE_NAME	Column name

**Table 31-75 (Cont.) Normalization and Missing Value Handling View**

<b>Column Name</b>	<b>Description</b>
ATTRIBUTE_SUBNAME	Nested column subname. The value is null for non-nested columns.
NUMERIC_MISSING_VALUE	Numeric missing value replacement
CATEGORICAL_MISSING_VALUE	Categorical missing value replacement
NORMALIZATION_SHIFT	Normalization shift value
NORMALIZATION_SCALE	Normalization scale value



# 32

## Scoring and Deployment

Explains the scoring and deployment features of Oracle Data Mining.

- [About Scoring and Deployment](#)
- [Using the Data Mining SQL Functions](#)
- [Prediction Details](#)
- [Real-Time Scoring](#)
- [Dynamic Scoring](#)
- [Cost-Sensitive Decision Making](#)
- [DBMS\\_DATA\\_MINING.Apply](#)

### 32.1 About Scoring and Deployment

**Scoring** is the application of models to new data. In Oracle Data Mining, scoring is performed by SQL language functions.

Predictive functions perform Classification, Regression, or Anomaly detection. Clustering functions assign rows to clusters. Feature Extraction functions transform the input data to a set of higher order predictors. A scoring procedure is also available in the `DBMS_DATA_MINING` PL/SQL package.

**Deployment** refers to the use of models in a target environment. Once the models have been built, the challenges come in deploying them to obtain the best results, and in maintaining them within a production environment. Deployment can be any of the following:

- Scoring data either for batch or real-time results. Scores can include predictions, probabilities, rules, and other statistics.
- Extracting model details to produce reports. For example: clustering rules, decision tree rules, or attribute rankings from an Attribute Importance model.
- Extending the business intelligence infrastructure of a data warehouse by incorporating mining results in applications or operational systems.
- Moving a model from the database where it was built to the database where it used for scoring (export/import)

Oracle Data Mining supports all of these deployment scenarios.

 **Note:**

Oracle Data Mining scoring operations support parallel execution. When parallel execution is enabled, multiple CPU and I/O resources are applied to the execution of a single database operation.

Parallel execution offers significant performance improvements, especially for operations that involve complex queries and large databases typically associated with decision support systems (DSS) and data warehouses.

**Related Topics**

- *Oracle Database VLDB and Partitioning Guide*
- *Oracle Data Mining Concepts*
- [Exporting and Importing Mining Models](#)  
You can export data mining models to flat files to back up work in progress or to move models to a different instance of Oracle Database Enterprise Edition (such as from a development database to a test database).

## 32.2 Using the Data Mining SQL Functions

Learn about the benefits of SQL functions in data mining.

The data mining SQL functions provide the following benefits:

- Models can be easily deployed within the context of existing SQL applications.
- Scoring operations take advantage of existing query execution functionality. This provides performance benefits.
- Scoring results are pipelined, enabling the rows to be processed without requiring materialization.

The data mining functions produce a score for each row in the selection. The functions can apply a mining model schema object to compute the score, or they can score dynamically without a pre-defined model, as described in "Dynamic Scoring".

**Related Topics**

- [Dynamic Scoring](#)
- [Scoring Requirements](#)
- [Table 28-4](#)
- *Oracle Database SQL Language Reference*

### 32.2.1 Choosing the Predictors

The data mining functions support a `USING` clause that specifies which attributes to use for scoring. You can specify some or all of the attributes in the selection and you can specify expressions. The following examples all use the `PREDICTION` function to find the customers who are likely to use an affinity card, but each example uses a different set of predictors.

The query in [Example 32-1](#) uses all the predictors.

The query in [Example 32-2](#) uses only gender, marital status, occupation, and income as predictors.

The query in [Example 32-3](#) uses three attributes and an expression as predictors. The prediction is based on gender, marital status, occupation, and the assumption that all customers are in the highest income bracket.

### Example 32-1 Using All Predictors

```
SELECT cust_gender, COUNT(*) AS cnt, ROUND(AVG(age)) AS avg_age
   FROM mining_data_apply_v
   WHERE PREDICTION(dt_sh_clas_sample USING *) = 1
   GROUP BY cust_gender
   ORDER BY cust_gender;
```

C	CNT	AVG_AGE
F	25	38
M	213	43

### Example 32-2 Using Some Predictors

```
SELECT cust_gender, COUNT(*) AS cnt, ROUND(AVG(age)) AS avg_age
   FROM mining_data_apply_v
   WHERE PREDICTION(dt_sh_clas_sample USING
                    cust_gender,cust_marital_status,
                    occupation, cust_income_level) = 1
   GROUP BY cust_gender
   ORDER BY cust_gender;
```

C	CNT	AVG_AGE
F	30	38
M	186	43

### Example 32-3 Using Some Predictors and an Expression

```
SELECT cust_gender, COUNT(*) AS cnt, ROUND(AVG(age)) AS avg_age
   FROM mining_data_apply_v
   WHERE PREDICTION(dt_sh_clas_sample USING
                    cust_gender, cust_marital_status, occupation,
                    'L: 300,000 and above' AS cust_income_level) = 1
   GROUP BY cust_gender
   ORDER BY cust_gender;
```

C	CNT	AVG_AGE
F	30	38
M	186	43

## 32.2.2 Single-Record Scoring

The data mining functions can produce a score for a single record, as shown in [Example 32-4](#) and [Example 32-5](#).

[Example 32-4](#) returns a prediction for customer 102001 by applying the classification model `NB_SH_Clas_sample`. The resulting score is 0, meaning that this customer is unlikely to use an affinity card.

**Example 32-5** returns a prediction for 'Affinity card is great' as the comments attribute by applying the text mining model `T_SVM_Clas_sample`. The resulting score is 1, meaning that this customer is likely to use an affinity card.

#### Example 32-4 Scoring a Single Customer or a Single Text Expression

```
SELECT PREDICTION (NB_SH_Clas_Sample USING *)
      FROM sh.customers where cust_id = 102001;

PREDICTION(NB_SH_CLAS_SAMPLEUSING*)
-----
                                0
```

#### Example 32-5 Scoring a Single Text Expression

```
SELECT
      PREDICTION(T_SVM_Clas_sample USING 'Affinity card is great' AS comments)
FROM DUAL;

PREDICTION(T_SVM_CLAS_SAMPLEUSING'AFFINITYCARDISGREAT'ASCOMMENTS)
-----
                                                                1
```

## 32.3 Prediction Details

Prediction details are XML strings that provide information about the score. Details are available for all types of scoring: clustering, feature extraction, classification, regression, and anomaly detection. Details are available whether scoring is dynamic or the result of model apply.

The details functions, `CLUSTER_DETAILS`, `FEATURE_DETAILS`, and `PREDICTION_DETAILS` return the actual value of attributes used for scoring and the relative importance of the attributes in determining the score. By default, the functions return the five most important attributes in descending order of importance.

### 32.3.1 Cluster Details

For the most likely cluster assignments of customer 100955 (probability of assignment > 20%), the query in the following example produces the five attributes that have the most impact for each of the likely clusters. The clustering functions apply an Expectation Maximization model named `em_sh_clus_sample` to the data selected from `mining_data_apply_v`. The "5" specified in `CLUSTER_DETAILS` is not required, because five attributes are returned by default.

#### Example 32-6 Cluster Details

```
SELECT S.cluster_id, probability prob,
      CLUSTER_DETAILS(em_sh_clus_sample, S.cluster_id, 5 USING T.*) det
FROM
      (SELECT v.*, CLUSTER_SET(em_sh_clus_sample, NULL, 0.2 USING *) pset
       FROM mining_data_apply_v v
       WHERE cust_id = 100955) T,
      TABLE(T.pset) S
ORDER BY 2 DESC;

CLUSTER_ID  PROB  DET
-----
14 .6761 <Details algorithm="Expectation Maximization" cluster="14">
      <Attribute name="AGE" actualValue="51" weight=".676" rank="1"/>
      <Attribute name="HOME_THEATER_PACKAGE" actualValue="1" weight=".557" rank="2"/>
      <Attribute name="FLAT_PANEL_MONITOR" actualValue="0" weight=".412" rank="3"/>
```

```

<Attribute name="Y_BOX_GAMES" actualValue="0" weight=".171" rank="4"/>
<Attribute name="BOOKKEEPING_APPLICATION" actualValue="1" weight="-.003"
rank="5"/>
</Details>

```

```

3 .3227 <Details algorithm="Expectation Maximization" cluster="3">
<Attribute name="YRS_RESIDENCE" actualValue="3" weight=".323" rank="1"/>
<Attribute name="BULK_PACK_DISKETTES" actualValue="1" weight=".265" rank="2"/>
<Attribute name="EDUCATION" actualValue="HS-grad" weight=".172" rank="3"/>
<Attribute name="AFFINITY_CARD" actualValue="0" weight=".125" rank="4"/>
<Attribute name="OCCUPATION" actualValue="Crafts" weight=".055" rank="5"/>
</Details>

```

## 32.3.2 Feature Details

The query in the following example returns the three attributes that have the greatest impact on the top Principal Components Analysis (PCA) projection for customer 101501. The `FEATURE_DETAILS` function applies a Singular Value Decomposition model named `svd_sh_sample` to the data selected from `svd_sh_sample_build_num`.

### Example 32-7 Feature Details

```

SELECT FEATURE_DETAILS(svd_sh_sample, 1, 3 USING *) projldet
FROM svd_sh_sample_build_num
WHERE CUST_ID = 101501;

```

```

PROJIDET
-----

```

```

<Details algorithm="Singular Value Decomposition" feature="1">
<Attribute name="HOME_THEATER_PACKAGE" actualValue="1" weight=".352" rank="1"/>
<Attribute name="Y_BOX_GAMES" actualValue="0" weight=".249" rank="2"/>
<Attribute name="AGE" actualValue="41" weight=".063" rank="3"/>
</Details>

```

## 32.3.3 Prediction Details

The query in the following example returns the attributes that are most important in predicting the age of customer 100010. The prediction functions apply a Generalized Linear Model Regression model named `GLMR_SH_Regr_sample` to the data selected from `mining_data_apply_v`.

### Example 32-8 Prediction Details for Regression

```

SELECT cust_id,
       PREDICTION(GLMR_SH_Regr_sample USING *) pr,
       PREDICTION_DETAILS(GLMR_SH_Regr_sample USING *) pd
FROM mining_data_apply_v
WHERE CUST_ID = 100010;

```

```

CUST_ID  PR PD
-----

```

```

100010 25.45 <Details algorithm="Generalized Linear Model">
<Attribute name="FLAT_PANEL_MONITOR" actualValue="1" weight=".025" rank="1"/>
<Attribute name="OCCUPATION" actualValue="Crafts" weight=".019" rank="2"/>
<Attribute name="AFFINITY_CARD" actualValue="0" weight=".01" rank="3"/>
<Attribute name="OS_DOC_SET_KANJI" actualValue="0" weight="0" rank="4"/>
<Attribute name="BOOKKEEPING_APPLICATION" actualValue="1" weight="-.004" rank="5"/>
</Details>

```

The query in the following example returns the customers who work in Tech Support and are likely to use an affinity card (with more than 85% probability). The prediction functions apply an Support Vector Machine (SVM) Classification model named `svmc_sh_clas_sample`. to the data selected from `mining_data_apply_v`. The query includes the prediction details, which show that education is the most important predictor.

### Example 32-9 Prediction Details for Classification

```
SELECT cust_id, PREDICTION_DETAILS(svmc_sh_clas_sample, 1 USING *) PD
   FROM mining_data_apply_v
  WHERE PREDICTION_PROBABILITY(svmc_sh_clas_sample, 1 USING *) > 0.85
     AND occupation = 'TechSup'
  ORDER BY cust_id;
```

CUST\_ID PD

```
-----
100029 <Details algorithm="Support Vector Machines" class="1">
  <Attribute name="EDUCATION" actualValue="Assoc-A" weight=".199" rank="1"/>
  <Attribute name="CUST_INCOME_LEVEL" actualValue="I: 170\,000 - 189\,999" weight=".044"
    rank="2"/>
  <Attribute name="HOME_THEATER_PACKAGE" actualValue="1" weight=".028" rank="3"/>
  <Attribute name="BULK_PACK_DISKETTES" actualValue="1" weight=".024" rank="4"/>
  <Attribute name="BOOKKEEPING_APPLICATION" actualValue="1" weight=".022" rank="5"/>
</Details>

100378 <Details algorithm="Support Vector Machines" class="1">
  <Attribute name="EDUCATION" actualValue="Assoc-A" weight=".21" rank="1"/>
  <Attribute name="CUST_INCOME_LEVEL" actualValue="B: 30\,000 - 49\,999" weight=".047"
    rank="2"/>
  <Attribute name="FLAT_PANEL_MONITOR" actualValue="0" weight=".043" rank="3"/>
  <Attribute name="HOME_THEATER_PACKAGE" actualValue="1" weight=".03" rank="4"/>
  <Attribute name="BOOKKEEPING_APPLICATION" actualValue="1" weight=".023" rank="5"/>
</Details>

100508 <Details algorithm="Support Vector Machines" class="1">
  <Attribute name="EDUCATION" actualValue="Bach." weight=".19" rank="1"/>
  <Attribute name="CUST_INCOME_LEVEL" actualValue="L: 300\,000 and above" weight=".046"
    rank="2"/>
  <Attribute name="HOME_THEATER_PACKAGE" actualValue="1" weight=".031" rank="3"/>
  <Attribute name="BULK_PACK_DISKETTES" actualValue="1" weight=".026" rank="4"/>
  <Attribute name="BOOKKEEPING_APPLICATION" actualValue="1" weight=".024" rank="5"/>
</Details>

100980 <Details algorithm="Support Vector Machines" class="1">
  <Attribute name="EDUCATION" actualValue="Assoc-A" weight=".19" rank="1"/>
  <Attribute name="FLAT_PANEL_MONITOR" actualValue="0" weight=".038" rank="2"/>
  <Attribute name="HOME_THEATER_PACKAGE" actualValue="1" weight=".026" rank="3"/>
  <Attribute name="BULK_PACK_DISKETTES" actualValue="1" weight=".022" rank="4"/>
  <Attribute name="BOOKKEEPING_APPLICATION" actualValue="1" weight=".02" rank="5"/>
</Details>
```

The query in the following example returns the two customers that differ the most from the rest of the customers. The prediction functions apply an anomaly detection model named `SVMO_SH_Clas_sample` to the data selected from `mining_data_apply_v`. Anomaly Detection uses a one-class SVM classifier.

### Example 32-10 Prediction Details for Anomaly Detection

```
SELECT cust_id, pd FROM
  (SELECT cust_id,
         PREDICTION_DETAILS(SVMO_SH_Clas_sample, 0 USING *) pd,
         RANK() OVER (ORDER BY prediction_probability(
```

```

        SVM0_SH_Clas_sample, 0 USING *) DESC, cust_id) rnk
FROM mining_data_one_class_v)
WHERE rnk <= 2
ORDER BY rnk;

```

CUST\_ID PD

```

-----
102366 <Details algorithm="Support Vector Machines" class="0">
  <Attribute name="COUNTRY_NAME" actualValue="United Kingdom" weight=".078" rank="1"/>
  <Attribute name="CUST_MARITAL_STATUS" actualValue="Divorc." weight=".027" rank="2"/>
  <Attribute name="CUST_GENDER" actualValue="F" weight=".01" rank="3"/>
  <Attribute name="HOUSEHOLD_SIZE" actualValue="9+" weight=".009" rank="4"/>
  <Attribute name="AGE" actualValue="28" weight=".006" rank="5"/>
</Details>

101790 <Details algorithm="Support Vector Machines" class="0">
  <Attribute name="COUNTRY_NAME" actualValue="Canada" weight=".068" rank="1"/>
  <Attribute name="HOUSEHOLD_SIZE" actualValue="4-5" weight=".018" rank="2"/>
  <Attribute name="EDUCATION" actualValue="7th-8th" weight=".015" rank="3"/>
  <Attribute name="CUST_GENDER" actualValue="F" weight=".013" rank="4"/>
  <Attribute name="AGE" actualValue="38" weight=".001" rank="5"/>
</Details>

```

## 32.3.4 GROUPING Hint

Data mining functions consist of SQL functions such as PREDICTION\*, CLUSTER\*, FEATURE\*, and ORA\_DM\_\*. The GROUPING hint is an optional hint which applies to data mining scoring functions when scoring partitioned models.

This hint results in partitioning the input data set into distinct data slices so that each partition is scored in its entirety before advancing to the next partition. However, parallelism by partition is still available. Data slices are determined by the partitioning key columns used when the model was built. This method can be used with any data mining function against a partitioned model. The hint may yield a query performance gain when scoring large data that is associated with many partitions but may negatively impact performance when scoring large data with few partitions on large systems. Typically, there is no performance gain if you use the hint for single row queries.

### Enhanced PREDICTION Function Command Format

```

<prediction function> ::=
  PREDICTION <left paren> /*+ GROUPING */ <prediction model>
    [ <comma> <class value> [ <comma> <top N> ] ]
  USING <mining attribute list> <right paren>

```

The syntax for only the PREDICTION function is given but it is applicable to any Data mining function where PREDICTION, CLUSTERING, and FEATURE\_EXTRACTION scoring functions occur.

### Example 32-11 Example

```

SELECT PREDICTION(/*+ GROUPING */my_model USING *) pred FROM <input table>;

```

### Related Topics

- [Oracle Database SQL Language Reference](#)

## 32.4 Real-Time Scoring

Oracle Data Mining SQL functions enable prediction, clustering, and feature extraction analysis to be easily integrated into live production and operational systems. Because mining results are returned within SQL queries, mining can occur in real time.

With real-time scoring, point-of-sales database transactions can be mined. Predictions and rule sets can be generated to help front-line workers make better analytical decisions. Real-time scoring enables fraud detection, identification of potential liabilities, and recognition of better marketing and selling opportunities.

The query in the following example uses a Decision Tree model named `dt_sh_clas_sample` to predict the probability that customer 101488 uses an affinity card. A customer representative can retrieve this information in real time when talking to this customer on the phone. Based on the query result, the representative can offer an extra-value card, since there is a 73% chance that the customer uses a card.

### Example 32-12 Real-Time Query with Prediction Probability

```
SELECT PREDICTION_PROBABILITY(dt_sh_clas_sample, 1 USING *) cust_card_prob
       FROM mining_data_apply_v
       WHERE cust_id = 101488;
```

```
CUST_CARD_PROB
-----
          .72764
```

## 32.5 Dynamic Scoring

The Data Mining SQL functions operate in two modes: by applying a pre-defined model, or by executing an analytic clause. If you supply an analytic clause instead of a model name, the function builds one or more transient models and uses them to score the data.

The ability to score data dynamically without a pre-defined model extends the application of basic embedded data mining techniques into environments where models are not available. Dynamic scoring, however, has limitations. The transient models created during dynamic scoring are not available for inspection or fine tuning. Applications that require model inspection, the correlation of scoring results with the model, special algorithm settings, or multiple scoring queries that use the same model, require a predefined model.

The following example shows a dynamic scoring query. The example identifies the rows in the input data that contain unusual customer age values.

### Example 32-13 Dynamic Prediction

```
SELECT cust_id, age, pred_age, age-pred_age age_diff, pred_det FROM
  (SELECT cust_id, age, pred_age, pred_det,
    RANK() OVER (ORDER BY ABS(age-pred_age) DESC) rnk FROM
    (SELECT cust_id, age,
      PREDICTION(FOR age USING *) OVER () pred_age,
      PREDICTION_DETAILS(FOR age ABS USING *) OVER () pred_det
    FROM mining_data_apply_v))
  WHERE rnk <= 5;
```

```
CUST_ID  AGE  PRED_AGE  AGE_DIFF  PRED_DET
-----
100910   80  40.6686505  39.33 <Details algorithm="Support Vector Machines">
                                     <Attribute name="HOME_THEATER_PACKAGE" actualValue="1">
```



```
weight=".059" rank="1"/>
<Attribute name="Y_BOX_GAMES" actualValue="0"
weight=".059" rank="2"/>
<Attribute name="AFFINITY_CARD" actualValue="0"
weight=".059" rank="3"/>
<Attribute name="FLAT_PANEL_MONITOR" actualValue="1"
weight=".059" rank="4"/>
<Attribute name="YRS_RESIDENCE" actualValue="4"
weight=".059" rank="5"/>
</Details>

101285 79 42.1753571 36.82 <Details algorithm="Support Vector Machines">
<Attribute name="HOME_THEATER_PACKAGE" actualValue="1"
weight=".059" rank="1"/>
<Attribute name="HOUSEHOLD_SIZE" actualValue="2" weight=".059"
rank="2"/>
<Attribute name="CUST_MARITAL_STATUS" actualValue="Mabsent"
weight=".059" rank="3"/>
<Attribute name="Y_BOX_GAMES" actualValue="0" weight=".059"
rank="4"/>
<Attribute name="OCCUPATION" actualValue="Prof." weight=".059"
rank="5"/>
</Details>

100694 77 41.0396722 35.96 <Details algorithm="Support Vector Machines">
<Attribute name="HOME_THEATER_PACKAGE" actualValue="1"
weight=".059" rank="1"/>
<Attribute name="EDUCATION" actualValue="&lt; Bach."
weight=".059" rank="2"/>
<Attribute name="Y_BOX_GAMES" actualValue="0" weight=".059"
rank="3"/>
<Attribute name="CUST_ID" actualValue="100694" weight=".059"
rank="4"/>
<Attribute name="COUNTRY_NAME" actualValue="United States of
America" weight=".059" rank="5"/>
</Details>

100308 81 45.3252491 35.67 <Details algorithm="Support Vector Machines">
<Attribute name="HOME_THEATER_PACKAGE" actualValue="1"
weight=".059" rank="1"/>
<Attribute name="Y_BOX_GAMES" actualValue="0" weight=".059"
rank="2"/>
<Attribute name="HOUSEHOLD_SIZE" actualValue="2" weight=".059"
rank="3"/>
<Attribute name="FLAT_PANEL_MONITOR" actualValue="1"
weight=".059" rank="4"/>
<Attribute name="CUST_GENDER" actualValue="F" weight=".059"
rank="5"/>
</Details>

101256 90 54.3862214 35.61 <Details algorithm="Support Vector Machines">
<Attribute name="YRS_RESIDENCE" actualValue="9" weight=".059"
rank="1"/>
<Attribute name="HOME_THEATER_PACKAGE" actualValue="1"
weight=".059" rank="2"/>
<Attribute name="EDUCATION" actualValue="&lt; Bach."
weight=".059" rank="3"/>
<Attribute name="Y_BOX_GAMES" actualValue="0" weight=".059"
rank="4"/>
<Attribute name="COUNTRY_NAME" actualValue="United States of
America" weight=".059" rank="5"/>
</Details>
```

## 32.6 Cost-Sensitive Decision Making

Costs are user-specified numbers that bias Classification. The algorithm uses positive numbers to penalize more expensive outcomes over less expensive outcomes. Higher numbers indicate higher costs.

The algorithm uses negative numbers to favor more beneficial outcomes over less beneficial outcomes. Lower negative numbers indicate higher benefits.

All classification algorithms can use costs for scoring. You can specify the costs in a cost matrix table, or you can specify the costs inline when scoring. If you specify costs inline and the model also has an associated cost matrix, only the inline costs are used. The `PREDICTION`, `PREDICTION_SET`, and `PREDICTION_COST` functions support costs.

Only the Decision Tree algorithm can use costs to bias the model build. If you want to create a Decision Tree model with costs, create a cost matrix table and provide its name in the `CLAS_COST_TABLE_NAME` setting for the model. If you specify costs when building the model, the cost matrix used to create the model is used when scoring. If you want to use a different cost matrix table for scoring, first remove the existing cost matrix table then add the new one.

A sample cost matrix table is shown in the following table. The cost matrix specifies costs for a binary target. The matrix indicates that the algorithm must treat a misclassified 0 as twice as costly as a misclassified 1.

**Table 32-1 Sample Cost Matrix**

ACTUAL_TARGET_VALUE	PREDICTED_TARGET_VALUE	COST
0	0	0
0	1	2
1	0	1
1	1	0

### Example 32-14 Sample Queries With Costs

The table `nbmodel_costs` contains the cost matrix described in [Table 32-1](#).

```
SELECT * from nbmodel_costs;
```

```

ACTUAL_TARGET_VALUE  PREDICTED_TARGET_VALUE  COST
-----
                0                0                0
                0                1                2
                1                0                1
                1                1                0

```

The following statement associates the cost matrix with a Naive Bayes model called `nbmodel`.

```

BEGIN
  dbms_data_mining.add_cost_matrix('nbmodel', 'nbmodel_costs');
END;
/

```

The following query takes the cost matrix into account when scoring `mining_data_apply_v`. The output is restricted to those rows where a prediction of 1 is less costly than a prediction of 0.

```

SELECT cust_gender, COUNT(*) AS cnt, ROUND(AVG(age)) AS avg_age
       FROM mining_data_apply_v
       WHERE PREDICTION (nbmodel COST MODEL
       USING cust_marital_status, education, household_size) = 1
       GROUP BY cust_gender
       ORDER BY cust_gender;

```

C	CNT	AVG_AGE
F	25	38
M	208	43

You can specify costs inline when you invoke the scoring function. If you specify costs inline and the model also has an associated cost matrix, only the inline costs are used. The same query is shown below with different costs specified inline. Instead of the "2" shown in the cost matrix table (Table 32-1), "10" is specified in the inline costs.

```

SELECT cust_gender, COUNT(*) AS cnt, ROUND(AVG(age)) AS avg_age
       FROM mining_data_apply_v
       WHERE PREDICTION (nbmodel
       COST (0,1) values ((0, 10),
       (1, 0))
       USING cust_marital_status, education, household_size) = 1
       GROUP BY cust_gender
       ORDER BY cust_gender;

```

C	CNT	AVG_AGE
F	74	39
M	581	43

The same query based on probability instead of costs is shown below.

```

SELECT cust_gender, COUNT(*) AS cnt, ROUND(AVG(age)) AS avg_age
       FROM mining_data_apply_v
       WHERE PREDICTION (nbmodel
       USING cust_marital_status, education, household_size) = 1
       GROUP BY cust_gender
       ORDER BY cust_gender;

```

C	CNT	AVG_AGE
F	73	39
M	577	44

### Related Topics

- [Example 27-1](#)

## 32.7 DBMS\_DATA\_MINING.Apply

The `APPLY` procedure in `DBMS_DATA_MINING` is a batch apply operation that writes the results of scoring directly to a table.

The columns in the table are mining function-dependent.

Scoring with `APPLY` generates the same results as scoring with the SQL scoring functions. Classification produces a prediction and a probability for each case; clustering produces a cluster ID and a probability for each case, and so on. The difference lies in the way that scoring results are captured and the mechanisms that can be used for retrieving them.

APPLY creates an output table with the columns shown in the following table:

**Table 32-2 APPLY Output Table**

Mining Function	Output Columns
classification	CASE_ID
	PREDICTION
	PROBABILITY
regression	CASE_ID
	PREDICTION
anomaly detection	CASE_ID
	PREDICTION
	PROBABILITY
clustering	CASE_ID
	CLUSTER_ID
	PROBABILITY
feature extraction	CASE_ID
	FEATURE_ID
	MATCH_QUALITY

Since APPLY output is stored separately from the scoring data, it must be joined to the scoring data to support queries that include the scored rows. Thus any model that is used with APPLY must have a case ID.

A case ID is not required for models that is applied with SQL scoring functions. Likewise, storage and joins are not required, since scoring results are generated and consumed in real time within a SQL query.

The following example illustrates Anomaly Detection with APPLY. The query of the APPLY output table returns the ten first customers in the table. Each has a a probability for being typical (1) and a probability for being anomalous (0).

**Example 32-15 Anomaly Detection with DBMS\_DATA\_MINING.APPLY**

```
EXEC dbms_data_mining.apply
      ('SVMO_SH_Clas_sample','svmo_sh_sample_prepared',
       'cust_id', 'one_class_output');
```

```
SELECT * from one_class_output where rownum < 11;
```

```

CUST_ID PREDICTION PROBABILITY
-----
101798      1 .567389309
101798      0 .432610691
102276      1 .564922469
102276      0 .435077531
102404      1 .51213544
102404      0 .48786456
101891      1 .563474346
101891      0 .436525654
102815      0 .500663683
102815      1 .499336317
```

### **Related Topics**

- *Oracle Database PL/SQL Packages and Types Reference*

# 33

## Mining Unstructured Text

Explains how to use Oracle Data Mining to mine unstructured text.

- [About Unstructured Text](#)
- [About Text Mining and Oracle Text](#)
- [Data Preparation for Text Features](#)
- [Creating a Model that Includes Text Mining](#)
- [Creating a Text Policy](#)
- [Configuring a Text Attribute](#)

### 33.1 About Unstructured Text

Data mining algorithms act on data that is numerical or categorical. Numerical data is ordered. It is stored in columns that have a numeric data type, such as `NUMBER` or `FLOAT`. Categorical data is identified by category or classification. It is stored in columns that have a character data type, such as `VARCHAR2` or `CHAR`.

Unstructured text data is neither numerical nor categorical. Unstructured text includes items such as web pages, document libraries, Power Point presentations, product specifications, emails, comment fields in reports, and call center notes. It has been said that unstructured text accounts for more than three quarters of all enterprise data. Extracting meaningful information from unstructured text can be critical to the success of a business.

### 33.2 About Text Mining and Oracle Text

Understand what is text mining and oracle text.

Text mining is the process of applying data mining techniques to text terms, also called text features or tokens. Text terms are words or groups of words that have been extracted from text documents and assigned numeric weights. Text terms are the fundamental unit of text that can be manipulated and analyzed.

Oracle Text is a Database technology that provides term extraction, word and theme searching, and other utilities for querying text. When columns of text are present in the training data, Oracle Data Mining uses Oracle Text utilities and term weighting strategies to transform the text for mining. Oracle Data Mining passes configuration information supplied by you to Oracle Text and uses the results in the model creation process.

#### Related Topics

- *[Oracle Text Application Developer's Guide](#)*

## 33.3 Data Preparation for Text Features

The model details view for text features is `DM$VXmodel_name`.

The text feature view `DM$VXmodel_name` describes the extracted text features if there are text attributes present. The view has the following schema:

Name	Type
PARTITION_NAME	VARCHAR2 (128)
COLUMN_NAME	VARCHAR2 (128)
TOKEN	VARCHAR2 (4000)
DOCUMENT_FREQUENCY	NUMBER

**Table 33-1 Text Feature View for Extracted Text Features**

Column Name	Description
PARTITION_NAME	A partition in a partitioned model to retrieve details
COLUMN_NAME	Name of the identifier column
TOKEN	Text token which is usually a word or stemmed word
DOCUMENT_FREQUENCY	A measure of token frequency in the entire training set

## 33.4 Creating a Model that Includes Text Mining

Learn how to create a model that includes text mining.

Oracle Data Mining supports unstructured text within columns of `VARCHAR2`, `CHAR`, `CLOB`, `BLOB`, and `BFILE`, as described in the following table:

**Table 33-2 Column Data Types That May Contain Unstructured Text**

Data Type	Description
BFILE and BLOB	Oracle Data Mining interprets <code>BLOB</code> and <code>BFILE</code> as text <i>only if you identify the columns as text when you create the model</i> . If you do not identify the columns as text, then <code>CREATE_MODEL</code> returns an error.
CLOB	Oracle Data Mining interprets <code>CLOB</code> as text.
CHAR	Oracle Data Mining interprets <code>CHAR</code> as categorical by default. You can identify columns of <code>CHAR</code> as text when you create the model.
VARCHAR2	Oracle Data Mining interprets <code>VARCHAR2</code> with data length > 4000 as text. Oracle Data Mining interprets <code>VARCHAR2</code> with data length <= 4000 as categorical by default. You can identify these columns as text when you create the model.



**Note:**

Text is not supported in nested columns or as a target in supervised data mining.

The settings described in the following table control the term extraction process for text attributes in a model. Instructions for specifying model settings are in "Specifying Model Settings".

**Table 33-3 Model Settings for Text**

Setting Name	Data Type	Setting Value	Description
ODMS_TEXT_POLICY_NAME	VARCHAR2 (4000)	Name of an Oracle Text policy object created with CTX_DDL.CREATE_POLICY	Affects how individual tokens are extracted from unstructured text. See " <a href="#">Creating a Text Policy</a> ".
ODMS_TEXT_MAX_FEATURES	INTEGER	1 <= value <= 100000	Maximum number of features to use from the document set (across all documents of each text column) passed to CREATE_MODEL. Default is 3000.

A model can include one or more text attributes. A model with text attributes can also include categorical and numerical attributes.

**To create a model that includes text attributes:**

1. Create an Oracle Text policy object..
2. Specify the model configuration settings that are described in "[Table 33-3](#)".
3. Specify which columns must be treated as text and, optionally, provide text transformation instructions for individual attributes.
4. Pass the model settings and text transformation instructions to DBMS\_DATA\_MINING.CREATE\_MODEL.

 **Note:**

All algorithms except O-Cluster can support columns of unstructured text. The use of unstructured text is not recommended for association rules (Apriori).

**Related Topics**

- [Specifying Model Settings](#)  
Understand how to configure data mining models at build time.
- [Creating a Text Policy](#)  
An Oracle Text policy specifies how text content must be interpreted. You can provide a text policy to govern a model, an attribute, or both the model and individual attributes.
- [Configuring a Text Attribute](#)  
Learn how to identify a column as a text attribute and provide transformation instructions for any text attribute.
- [Embedding Transformations in a Model](#)



## 33.5 Creating a Text Policy

An Oracle Text policy specifies how text content must be interpreted. You can provide a text policy to govern a model, an attribute, or both the model and individual attributes.

If a model-specific policy is present and one or more attributes have their own policies, Oracle Data Mining uses the attribute policies for the specified attributes and the model-specific policy for the other attributes.

The `CTX_DDL.CREATE_POLICY` procedure creates a text policy.

```
CTX_DDL.CREATE_POLICY(
    policy_name    IN VARCHAR2,
    filter         IN VARCHAR2 DEFAULT NULL,
    section_group IN VARCHAR2 DEFAULT NULL,
    lexer         IN VARCHAR2 DEFAULT NULL,
    stoplist      IN VARCHAR2 DEFAULT NULL,
    wordlist      IN VARCHAR2 DEFAULT NULL);
```

The parameters of `CTX_DDL.CREATE_POLICY` are described in the following table.

**Table 33-4 CTX\_DDL.CREATE\_POLICY Procedure Parameters**

Parameter Name	Description
<code>policy_name</code>	Name of the new policy object. Oracle Text policies and text indexes share the same namespace.
<code>filter</code>	Specifies how the documents must be converted to plain text for indexing. Examples are: <code>CHARSET_FILTER</code> for character sets and <code>NULL_FILTER</code> for plain text, HTML and XML. For <code>filter</code> values, see "Filter Types" in <i>Oracle Text Reference</i> .
<code>section_group</code>	Identifies sections within the documents. For example, <code>HTML_SECTION_GROUP</code> defines sections in HTML documents. For <code>section_group</code> values, see "Section Group Types" in <i>Oracle Text Reference</i> . Note: You can specify any section group that is supported by <code>CONTEXT</code> indexes.
<code>lexer</code>	Identifies the language that is being indexed. For example, <code>BASIC_LEXER</code> is the lexer for extracting terms from text in languages that use white space delimited words (such as English and most western European languages). For <code>lexer</code> values, see "Lexer Types" in <i>Oracle Text Reference</i> .
<code>stoplist</code>	Specifies words and themes to exclude from term extraction. For example, the word "the" is typically in the stoplist for English language documents. The system-supplied stoplist is used by default. See "Stoplists" in <i>Oracle Text Reference</i> .
<code>wordlist</code>	Specifies how stems and fuzzy queries must be expanded. A stem defines a root form of a word so that different grammatical forms have a single representation. A fuzzy query includes common misspellings in the representation of a word. See " <code>BASIC_WORDLIST</code> " in <i>Oracle Text Reference</i> .

### Related Topics

- *Oracle Text Reference*

## 33.6 Configuring a Text Attribute

Learn how to identify a column as a text attribute and provide transformation instructions for any text attribute.

As shown in [Table 33-2](#), you can identify columns of `CHAR`, shorter `VARCHAR2` (`<=4000`), `BFILE`, and `BLOB` as text attributes. If `CHAR` and shorter `VARCHAR2` columns are not explicitly identified as unstructured text, then `CREATE_MODEL` processes them as categorical attributes. If `BFILE` and `BLOB` columns are not explicitly identified as unstructured text, then `CREATE_MODEL` returns an error.

To identify a column as a text attribute, supply the keyword `TEXT` in an **Attribute specification**. The attribute specification is a field (`attribute_spec`) in a transformation record (`transform_rec`). Transformation records are components of transformation lists (`xform_list`) that can be passed to `CREATE_MODEL`.

### Note:

An attribute specification can also include information that is not related to text. Instructions for constructing an attribute specification are in "Embedding Transformations in a Model".

You can provide transformation instructions for any text attribute by qualifying the `TEXT` keyword in the attribute specification with the subsettings described in the following table.

**Table 33-5 Attribute-Specific Text Transformation Instructions**

Subsetting Name	Description	Example
BIGRAM	A sequence of two adjacent elements from a string of tokens, which are typically letters, syllables, or words.  Here, <code>NORMAL</code> tokens are mixed with their bigrams.	<code>(TOKEN_TYPE:BIGRAM)</code>
POLICY_NAME	Name of an Oracle Text policy object created with <code>CTX_DDL.CREATE_POLICY</code>	<code>(POLICY_NAME:my_policy)</code>
STEM_BIGRAM	Here, <code>STEM</code> tokens are extracted first and then stem bigrams are formed.	<code>(TOKEN_TYPE:STEM_BIGRAM)</code>
SYNONYM	Oracle Data Mining supports synonyms. The following is an optional parameter: <code>&lt;thesaurus&gt;</code> where <code>&lt;thesaurus&gt;</code> is the name of the thesaurus defining synonyms. If <code>SYNONYM</code> is used without this parameter, then the default thesaurus is used.	<code>(TOKEN_TYPE:SYNONYM)</code> <code>(TOKEN_TYPE:SYNONYM[NAMES])</code>
TOKEN_TYPE	The following values are supported:  <code>NORMAL</code> (the default) <code>STEM</code> <code>THEME</code>  See " <a href="#">Token Types in an Attribute Specification</a> "	<code>(TOKEN_TYPE:THEME)</code>

**Table 33-5 (Cont.) Attribute-Specific Text Transformation Instructions**

Subsetting Name	Description	Example
MAX_FEATURES	Maximum number of features to use from the attribute.	(MAX_FEATURES:3000)

 **Note:**

The `TEXT` keyword is only required for `CLOB` and longer `VARCHAR2` (>4000) when you specify transformation instructions. The `TEXT` keyword is *always* required for `CHAR`, shorter `VARCHAR2`, `BFILE`, and `BLOB` — whether or not you specify transformation instructions.

 **Tip:**

You can view attribute specifications in the data dictionary view `ALL_MINING_MODEL_ATTRIBUTES`, as shown in *Oracle Database Reference*.

**Token Types in an Attribute Specification**

When stems or themes are specified as the token type, the lexer preference for the text policy must support these types of tokens.

The following example adds themes and English stems to `BASIC_LEXER`.

```
BEGIN
  CTX_DDL.CREATE_PREFERENCE('my_lexer', 'BASIC_LEXER');
  CTX_DDL.SET_ATTRIBUTE('my_lexer', 'index_stems', 'ENGLISH');
  CTX_DDL.SET_ATTRIBUTE('my_lexer', 'index_themes', 'YES');
END;
```

**Example 33-1 A Sample Attribute Specification for Text**

This expression specifies that text transformation for the attribute must use the text policy named `my_policy`. The token type is `THEME`, and the maximum number of features is 3000.

```
"TEXT(POLICY_NAME:my_policy)(TOKEN_TYPE:THEME)(MAX_FEATURES:3000)"
```

**Related Topics**

- [Embedding Transformations in a Model](#)
- [Specifying Transformation Instructions for an Attribute](#)  
Learn what is a transformation instruction for an attribute and learn about the fields in a transformation record.
- *Oracle Database PL/SQL Packages and Types Reference*
- `ALL_MINING_MODEL_ATTRIBUTES`

# Administrative Tasks for Oracle Data Mining

Explains how to perform administrative tasks related to Oracle Data Mining.

- [Installing and Configuring a Database for Data Mining](#)
- [Upgrading or Downgrading Oracle Data Mining](#)
- [Exporting and Importing Mining Models](#)
- [Controlling Access to Mining Models and Data](#)
- [Auditing and Adding Comments to Mining Models](#)

## 34.1 Installing and Configuring a Database for Data Mining

Learn how to install and configure a database for Data Mining.

- [About Installation](#)
- [Enabling or Disabling a Database Option](#)
- [Database Tuning Considerations for Data Mining](#)

### 34.1.1 About Installation

Oracle Data Mining is a component of the Oracle Advanced Analytics option to Oracle Database Enterprise Edition.

To install Oracle Database, follow the installation instructions for your platform. Choose a Data Warehousing configuration during the installation.

Oracle Data Miner, the graphical user interface to Oracle Data Mining, is an extension to Oracle SQL Developer. Instructions for downloading SQL Developer and installing the Data Miner repository are available on the Oracle Technology Network.

To perform data mining activities, you must be able to log on to the Oracle database, and your user ID must have the database privileges described in [Example 34-7](#).

#### Related Topics

- [Oracle Data Miner](#)

#### See Also:

**Install and Upgrade** page of the Oracle Database online documentation library for your platform-specific installation instructions: Oracle Database 18c Release

## 34.1.2 Enabling or Disabling a Database Option

Learn how you can enable or disable Oracle Advanced Analytics option after the installation.

The Oracle Advanced Analytics option is enabled by default during installation of Oracle Database Enterprise Edition. After installation, you can use the command-line utility `chopt` to enable or disable a database option. For instructions, see "Enabling and Disabling Database Options After Installation" in the installation guide for your platform.

### Related Topics

- [Oracle Database Installation Guide for Linux](#)
- [Oracle Database Installation Guide for Microsoft Windows](#)

## 34.1.3 Database Tuning Considerations for Data Mining

Understand the Database tuning considerations for Data Mining.

DBAs managing production databases that support Oracle Data Mining must follow standard administrative practices as described in *Oracle Database Administrator's Guide*.

Building data mining models and batch scoring of mining models tend to put a DSS-like workload on the system. Single-row scoring tends to put an OLTP-like workload on the system.

Database memory management can have a major impact on data mining. The correct sizing of Program Global Area (PGA) memory is very important for model building, complex queries, and batch scoring. From a data mining perspective, the System Global Area (SGA) is generally less of a concern. However, the SGA must be sized to accommodate real-time scoring, which loads models into the shared cursor in the SGA. In most cases, you can configure the database to manage memory automatically. To do so, specify the total maximum memory size in the tuning parameter `MEMORY_TARGET`. With automatic memory management, Oracle Database dynamically exchanges memory between the SGA and the instance PGA as needed to meet processing demands.

Most data mining algorithms can take advantage of parallel execution when it is enabled in the database. Parameters in `INIT.ORA` control the behavior of parallel execution.

### Related Topics

- [Oracle Database Administrator's Guide](#)
- [Scoring and Deployment](#)  
Explains the scoring and deployment features of Oracle Data Mining.
- [Oracle Database Administrator's Guide](#)
- [Part I Database Performance Fundamentals](#)
- [Tuning Database Memory](#)
- [Oracle Database VLDB and Partitioning Guide](#)

## 34.2 Upgrading or Downgrading Oracle Data Mining

Understand how to upgrade and downgrade Oracle Data Mining.

- [Pre-Upgrade Steps](#)
- [Upgrading Oracle Data Mining](#)

- [Post Upgrade Steps](#)
- [Downgrading Oracle Data Mining](#)

## 34.2.1 Pre-Upgrade Steps

Before upgrading, you must drop any data mining models that were created in Java and any mining activities that were created in Oracle Data Miner Classic (the earlier version of Oracle Data Miner).

### **Caution:**

In Oracle Database 12c, Oracle Data Mining does not support a Java API, and Oracle Data Miner Classic cannot run against Oracle Database 12c .

### 34.2.1.1 Dropping Models Created in Java

If your 10g or 11g database contains models created in Java, use the `DBMS_DATA_MINING.DROP_MODEL` routine to drop the models before upgrading the database.

### 34.2.1.2 Dropping Mining Activities Created in Oracle Data Miner Classic

If your database contains mining activities from Oracle Data Miner Classic, delete the mining activities and drop the repository before upgrading the database. Follow these steps:

1. Use the Data Miner Classic user interface to delete the mining activities.
2. In SQL\*Plus or SQL Developer, drop these tables:

```
DM4J$ACTIVITIES  
DM4J$RESULTS  
DM4J$TRANSFORMS
```

and these views:

```
DM4J$MODEL_RESULTS_V  
DM4J$RESULTS_STATE_V
```

There must be no tables or views with the prefix `DM4J$` in any schema in the database after you complete these steps.

## 34.2.2 Upgrading Oracle Data Mining

Learn how to upgrade Oracle Data Mining.

After you complete the "Pre-Upgrade Steps", all models and mining metadata are fully integrated with the Oracle Database upgrade process whether you are upgrading from 11g or from 10g releases.

Upgraded models continue to work as they did in prior releases. Both upgraded models and new models that you create in the upgraded environment can make use of the new mining functionality introduced in the new release.

To upgrade a database, you can use Database Upgrade Assistant (DBUA) or you can perform a manual upgrade using export/import utilities.

**Related Topics**

- [Pre-Upgrade Steps](#)
- *Oracle Database Upgrade Guide*

### 34.2.2.1 Using Database Upgrade Assistant to Upgrade Oracle Data Mining

Oracle Database Upgrade Assistant provides a graphical user interface that guides you interactively through the upgrade process.

On Windows platforms, follow these steps to start the Upgrade Assistant:

1. Go to the Windows **Start** menu and choose the Oracle home directory.
2. Choose the **Configuration and Migration Tools** menu.
3. Launch the **Upgrade Assistant**.

On Linux platforms, run the `DBUA` utility to upgrade Oracle Database.

#### 34.2.2.1.1 Upgrading from Release 10g

In Oracle Data Mining 10g, data mining metadata and PL/SQL packages are stored in the `DMSYS` schema. In Oracle Data Mining 11g and 12c, `DMSYS` no longer exists; data mining metadata objects are stored in `SYS`.

When Oracle Database 10g is upgraded to 12c, all data mining metadata objects and PL/SQL packages are migrated from `DMSYS` to `SYS`. The `DMSYS` schema and its associated objects are removed after a successful migration. When `DMSYS` is removed, the `SYS.DBA_REGISTRY` view no longer lists Oracle Data Mining as a component.

After upgrading to Oracle Database 12c, you can no longer switch to the Data Mining Scoring Engine (DMSE). The Scoring Engine does not exist in Oracle Database 11g or 12c.

#### 34.2.2.1.2 Upgrading from Release 11g

If you upgrade Oracle Database 11g to Oracle Database 12c, and the database was previously upgraded from Oracle Database 10g, then the `DMSYS` schema may still be present. If the upgrade process detects `DMSYS`, it displays a warning message and drops `DMSYS` during the upgrade.

### 34.2.2.2 Using Export/Import to Upgrade Data Mining Models

If required, you can use a less automated approach to upgrading data mining models. You can export the models created in a previous version of Oracle Database and import them into an instance of Oracle Database 12c.

 **Caution:**

Do not import data mining models that were created in Java. They are not supported in Oracle Database 12c.

### 34.2.2.2.1 Export/Import Release 10g Data Mining Models

Follow the instructions for exporting and importing Data Mining models.

To export models from an instance of Oracle Database 10g to a dump file, follow the instructions in "Exporting and Importing Mining Models". Before importing the models from the dump file, run the `DMEIDMSYS` script to create the `DMSYS` schema in Oracle Database 12c.

```
SQL>CONNECT / as sysdba;
SQL>@ORACLE_HOME\RDBMS\admin\dmeidmsys.sql
SQL>EXIT;
```

 **Note:**

The `TEMP` tablespace must already exist in the Oracle Database 12g database. The `DMEIDMSYS` script uses the `TEMP` and `SYSAUX` tablespaces to create the `DMSYS` schema.

To import the dump file into the Oracle Database 12c database:

```
%ORACLE_HOME\bin\impdp system\<password>
    dumpfile=<dumpfile_name>
    directory=<directory_name>
    logfile=<logfile_name> .....
SQL>CONNECT / as sysdba;
SQL>EXECUTE dmp_sys.upgrade_models();
SQL>ALTER SYSTEM FLUSH SHARED_POOL;
SQL>ALTER SYSTEM FLUSH BUFFER_CACHE;
SQL>EXIT;
```

The `upgrade_models` script migrates all data mining metadata objects and PL/SQL packages from `DMSYS` to `SYS` and then drops `DMSYS` before upgrading the models.

#### ALTER SYSTEM Statement

You can flush the Database Smart Flash Cache by issuing an `ALTER SYSTEM FLUSH FLASH_CACHE` statement. Flushing the Database Smart Flash Cache can be useful if you need to measure the performance of rewritten queries or a suite of queries from identical starting points.

#### Related Topics

- [Exporting and Importing Mining Models](#)  
You can export data mining models to flat files to back up work in progress or to move models to a different instance of Oracle Database Enterprise Edition (such as from a development database to a test database).

### 34.2.2.2.2 Export/Import Release 11g Data Mining Models

To export models from an instance of Oracle Database 11g to a dump file, follow the instructions in [Exporting and Importing Mining Models](#).



 **Caution:**

Do not import data mining models that were created in Java. They are not supported in Oracle Database 12c.

To import the dump file into the Oracle Database 12c database:

```
%ORACLE_HOME\bin\impdp system\<password>
  dumpfile=<dumpfile_name>
  directory=<directory_name>
  logfile=<logfile_name> .....
SQL>CONNECT / as sysdba;
SQL>EXECUTE dmp_sys.upgrade_models();
SQL>ALTER SYSTEM flush shared_pool;
SQL>ALTER SYSTEM flush buffer_cache;
SQL>EXIT;
```

**ALTER SYSTEM Statement**

You can flush the Database Smart Flash Cache by issuing an `ALTER SYSTEM FLUSH FLASH_CACHE` statement. Flushing the Database Smart Flash Cache can be useful if you need to measure the performance of rewritten queries or a suite of queries from identical starting points.

### 34.2.3 Post Upgrade Steps

Perform steps to view the upgraded database.

After upgrading the database, check the `DBA_MINING_MODELS` view in the upgraded database. The newly upgraded mining models must be listed in this view.

After you have verified the upgrade and confirmed that there is no need to downgrade, you must set the initialization parameter `COMPATIBLE` to 12.1.

 **Note:**

The `CREATE MINING MODEL` privilege must be granted to Data Mining user accounts that are used to create mining models.

**Related Topics**

- [Creating a Data Mining User](#)  
Explains how to create a Data Mining user.
- [Controlling Access to Mining Models and Data](#)  
Understand how to create a Data Mining user and grant necessary privileges.

### 34.2.4 Downgrading Oracle Data Mining

Before downgrading the Oracle Database 12c database back to the previous version, ensure that no Singular Value Decomposition models or Expectation Maximization models are present. These algorithms are only available in Oracle Database 12c. Use the

`DBMS_DATA_MINING.DROP_MODEL` routine to drop these models before downgrading. If you do not do this, the database downgrade process terminates.

Issue the following SQL statement in `SYS` to verify the downgrade:

```
SQL>SELECT o.name FROM sys.model$ m, sys.obj$ o
        WHERE m.obj#=o.obj# AND m.version=2;
```

## 34.3 Exporting and Importing Mining Models

You can export data mining models to flat files to back up work in progress or to move models to a different instance of Oracle Database Enterprise Edition (such as from a development database to a test database).

All methods for exporting and importing models are based on Oracle Data Pump technology.

The `DBMS_DATA_MINING` package includes the `EXPORT_MODEL` and `IMPORT_MODEL` procedures for exporting and importing individual mining models. `EXPORT_MODEL` and `IMPORT_MODEL` use the export and import facilities of Oracle Data Pump.

- [About Oracle Data Pump](#)
- [Options for Exporting and Importing Mining Models](#)
- [Directory Objects for EXPORT\\_MODEL and IMPORT\\_MODEL](#)
- [Using EXPORT\\_MODEL and IMPORT\\_MODEL](#)
- [EXPORT and IMPORT Serialized Models](#)
- [Importing From PMML](#)

### Related Topics

- [EXPORT\\_MODEL](#)
- [IMPORT\\_MODEL](#)

### 34.3.1 About Oracle Data Pump

Oracle Data Pump consists of two command-line clients and two PL/SQL packages. The command-line clients, `expdp` and `impdp`, provide an easy-to-use interface to the Data Pump export and import utilities. You can use `expdp` and `impdp` to export and import entire schemas or databases.

The Data Pump export utility writes the schema objects, including the tables and metadata that constitute mining models, to a dump file set. The Data Pump import utility retrieves the schema objects, including the model tables and metadata, from the dump file set and restores them in the target database.

`expdp` and `impdp` cannot be used to export/import individual mining models.

#### See Also:

*Oracle Database Utilities* for information about Oracle Data Pump and the `expdp` and `impdp` utilities

## 34.3.2 Options for Exporting and Importing Mining Models

Lists options for exporting and importing mining models.

Options for exporting and importing mining models are described in the following table.

**Table 34-1 Export and Import Options for Oracle Data Mining**

Task	Description
Export or import a full database	(DBA only) Use <code>expdp</code> to export a full database and <code>impdp</code> to import a full database. All mining models in the database are included.
Export or import a schema	Use <code>expdp</code> to export a schema and <code>impdp</code> to import a schema. All mining models in the schema are included.
Export or import individual models within a database	Use <code>DBMS_DATA_MINING.EXPORT_MODEL</code> to export individual models and <code>DBMS_DATA_MINING.IMPORT_MODEL</code> to import individual models. These procedures can export and import a single mining model, all mining models, or mining models that match specific criteria. By default, <code>IMPORT_MODEL</code> imports models back into the schema from which they were exported. You can specify the <code>schema_remap</code> parameter to import models into a different schema. You can specify <code>tablespace_remap</code> with <code>schema_remap</code> to import models into a schema that uses a different tablespace. You may need special privileges in the database to import models into a different schema. These privileges are granted by the <code>EXP_FULL_DATABASE</code> and <code>IMP_FULL_DATABASE</code> roles, which are only available to privileged users (such as <code>SYS</code> or a user with the <code>DBA</code> role). You do not need these roles to export or import models within your own schema. To import models, you must have the same database privileges as the user who created the dump file set. Otherwise, a <code>DBA</code> with full system privileges must import the models.
Export or import individual models to or from a remote database	Use a database link to export individual models to a remote database or import individual models from a remote database. A database link is a schema object in one database that enables access to objects in a different database. The link must be created before you execute <code>EXPORT_MODEL</code> or <code>IMPORT_MODEL</code> . To create a private database link, you must have the <code>CREATE DATABASE LINK</code> system privilege. To create a public database link, you must have the <code>CREATE PUBLIC DATABASE LINK</code> system privilege. Also, you must have the <code>CREATE SESSION</code> system privilege on the remote Oracle Database. Oracle Net must be installed on both the local and remote Oracle Databases.

### Related Topics

- [IMPORT\\_MODEL Procedure](#)
- [EXPORT\\_MODEL Procedure](#)
- [Oracle Database SQL Language Reference](#)

## 34.3.3 Directory Objects for EXPORT\_MODEL and IMPORT\_MODEL

Learn how to use directory objects to identify the location of the dump file set.

`EXPORT_MODEL` and `IMPORT_MODEL` use a directory object to identify the location of the dump file set. A directory object is a logical name in the database for a physical directory on the host computer.

To export data mining models, you must have write access to the directory object and to the file system directory that it represents. To import data mining models, you must have read access to the directory object and to the file system directory. Also, the database itself must have access to file system directory. You must have the `CREATE ANY DIRECTORY` privilege to create directory objects.

The following SQL command creates a directory object named `dmuser_dir`. The file system directory that it represents must already exist and have shared read/write access rights granted by the operating system.

```
CREATE OR REPLACE DIRECTORY dmuser_dir AS '/dm_path/dm_mining';
```

The following SQL command gives user `dmuser` both read and write access to `dmuser_dir`.

```
GRANT READ,WRITE ON DIRECTORY dmuser_dir TO dmuser;
```

### Related Topics

- *Oracle Database SQL Language Reference*

## 34.3.4 Using EXPORT\_MODEL and IMPORT\_MODEL

The examples illustrate various export and import scenarios with `EXPORT_MODEL` and `IMPORT_MODEL`.

The examples use the directory object `dmdir` shown in [Example 34-1](#) and two schemas, `dm1` and `dm2`. Both schemas have data mining privileges. `dm1` has two models. `dm2` has one model.

```
SELECT owner, model_name, mining_function, algorithm FROM all_mining_models;
```

OWNER	MODEL_NAME	MINING_FUNCTION	ALGORITHM
DM1	EM_SH_CLUS_SAMPLE	CLUSTERING	EXPECTATION_MAXIMIZATION
DM1	DT_SH_CLAS_SAMPLE	CLASSIFICATION	DECISION_TREE
DM2	SVD_SH_SAMPLE	FEATURE_EXTRACTION	SINGULAR_VALUE_DECOMP

### Example 34-1 Creating the Directory Object

```
-- connect as system user
CREATE OR REPLACE DIRECTORY dmdir AS '/scratch/dmuser/expimp';
GRANT READ,WRITE ON DIRECTORY dmdir TO dm1;
GRANT READ,WRITE ON DIRECTORY dmdir TO dm2;
SELECT * FROM all_directories WHERE directory_name IN 'DMDIR';
```

OWNER	DIRECTORY_NAME	DIRECTORY_PATH
SYS	DMDIR	/scratch/dmuser/expimp

### Example 34-2 Exporting All Models From DM1

```
-- connect as dm1
BEGIN
  dbms_data_mining.export_model (
    filename => 'all_dm1',
    directory => 'dmdir');
END;
/
```

A log file and a dump file are created in `/scratch/dmuser/expimp`, the physical directory associated with `dmdir`. The name of the log file is `dm1_exp_11.log`. The name of the dump file is `all_dm101.dmp`.

**Example 34-3 Importing the Models Back Into DM1**

The models that were exported in [Example 34-2](#) still exist in `dm1`. Since an import does not overwrite models with the same name, you must drop the models before importing them back into the same schema.

```
BEGIN
  dbms_data_mining.drop_model('EM_SH_CLUS_SAMPLE');
  dbms_data_mining.drop_model('DT_SH_CLAS_SAMPLE');
  dbms_data_mining.import_model(
    filename => 'all_dm101.dmp',
    directory => 'DMDIR');
END;
/
SELECT model_name FROM user_mining_models;

MODEL_NAME
-----
DT_SH_CLAS_SAMPLE
EM_SH_CLUS_SAMPLE
```

**Example 34-4 Importing Models Into a Different Schema**

In this example, the models that were exported from `dm1` in [Example 34-2](#) are imported into `dm2`. The `dm1` schema uses the `example` tablespace; the `dm2` schema uses the `sysaux` tablespace.

```
-- CONNECT as sysdba
BEGIN
  dbms_data_mining.import_model (
    filename => 'all_d101.dmp',
    directory => 'DMDIR',
    schema_remap => 'DM1:DM2',
    tablespace_remap => 'EXAMPLE:SYS AUX');
END;
/
-- CONNECT as dm2
SELECT model_name from user_mining_models;

MODEL_NAME
-----
SVD_SH_SAMPLE
EM_SH_CLUS_SAMPLE
DT_SH_CLAS_SAMPLE
```

**Example 34-5 Exporting Specific Models**

You can export a single model, a list of models, or a group of models that share certain characteristics.

```
-- Export the model named dt_sh_clas_sample
EXECUTE dbms_data_mining.export_model (
  filename => 'one_model',
  directory => 'DMDIR',
  model_filter => 'name in ('DT_SH_CLAS_SAMPLE')');
-- one_model01.dmp and dm1_exp_37.log are created in /scratch/dmuser/expimp

-- Export Decision Tree models
EXECUTE dbms_data_mining.export_model(
  filename => 'algo_models',
  directory => 'DMDIR',
  model_filter => 'ALGORITHM_NAME IN ('DECISION_TREE')');
```

```
-- algo_model01.dmp and dml_exp_410.log are created in /scratch/dmuser/expimp

-- Export clustering models
EXECUTE dbms_data_mining.export_model(
    filename =>'func_models',
    directory => 'DMDIR',
    model_filter => 'FUNCTION_NAME = ''CLUSTERING''');
-- func_model01.dmp and dml_exp_513.log are created in /scratch/dmuser/expimp
```

**Related Topics**

- *Oracle Database PL/SQL Packages and Types Reference*

## 34.3.5 EXPORT and IMPORT Serialized Models

From Oracle Database Release 18c onwards, `EXPORT_SERMODEL` and `IMPORT_SERMODEL` procedures are available to export and import serialized models.

The serialized format allows the models to be moved to another platform (outside the database) for scoring. The model is exported in a `BLOB` that can be saved in a `BFILE`. The import routine takes the serialized content in the `BLOB` and the name of the model to be created with the content.

**Related Topics**

- `EXPORT_SERMODEL` Procedure
- `IMPORT_SERMODEL` Procedure

## 34.3.6 Importing From PMML

You can import Regression models represented in Predictive Model Markup Language (PMML).

PMML is an XML-based standard specified by the Data Mining Group (<http://www.dmg.org>). Applications that are PMML-compliant can deploy PMML-compliant models that were created by any vendor. Oracle Data Mining supports the core features of PMML 3.1 for regression models.

You can import regression models represented in PMML. The models must be of type `RegressionModel`, either linear regression or binary logistic regression.

**Related Topics**

- *Oracle Database PL/SQL Packages and Types Reference*

## 34.4 Controlling Access to Mining Models and Data

Understand how to create a Data Mining user and grant necessary privileges.

- [Creating a Data Mining User](#)
- [System Privileges for Data Mining](#)
- [Object Privileges for Mining Models](#)

## 34.4.1 Creating a Data Mining User

Explains how to create a Data Mining user.

A Data Mining user is a database user account that has privileges for performing data mining activities. [Example 34-6](#) shows how to create a database user. [Example 34-7](#) shows how to assign data mining privileges to the user.

 **Note:**

To create a user for the Data Mining sample programs, you must run two configuration scripts as described in "The Data Mining Sample Programs".

### Example 34-6 Creating a Database User in SQL\*Plus

1. Log in to SQL\*Plus with system privileges.

```
Enter user-name: sys as sysdba
Enter password: password
```

2. To create a user named `dmuser`, type these commands. Specify a password of your choosing.

```
CREATE USER dmuser IDENTIFIED BY password
DEFAULT TABLESPACE USERS
TEMPORARY TABLESPACE TEMP
QUOTA UNLIMITED ON USERS;
Commit;
```

The `USERS` and `TEMP` tablespace are included in the pre-configured database that Oracle ships with the database media. `USERS` is used mostly by demo users; it is appropriate for running the sample programs described in "The Data Mining Sample Programs". `TEMP` is the temporary tablespace that is shared by most database users.

 **Note:**

Tablespaces for Data Mining users must be assigned according to standard DBA practices, depending on system load and system resources.

3. To login as `dmuser`, type the following.

```
CONNECT dmuser
Enter password: password
```

### Related Topics

- [The Data Mining Sample Programs](#)  
Describes the data mining sample programs that ship with Oracle Database.

**See Also:**

*Oracle Database SQL Language Reference* for the complete syntax of the `CREATE USER` statement

### 34.4.1.1 Granting Privileges for Data Mining

You must have the `CREATE MINING MODEL` privilege to create models in your own schema. You can perform any operation on models that you own. This includes applying the model, adding a cost matrix, renaming the model, and dropping the model.

The `GRANT` statements in the following example assign a set of basic data mining privileges to the `dmuser` account. Some of these privileges are not required for all mining activities, however it is prudent to grant them all as a group.

Additional system and object privileges are required for enabling or restricting specific mining activities.

#### Example 34-7 Privileges Required for Data Mining

```
GRANT CREATE MINING MODEL TO dmuser;
GRANT CREATE SESSION TO dmuser;
GRANT CREATE TABLE TO dmuser;
GRANT CREATE VIEW TO dmuser;
GRANT EXECUTE ON CTXSYS.CTX_DDL TO dmuser;
```

`READ` or `SELECT` privileges are required for data that is not in your schema. For example, the following statement grants `SELECT` access to the `sh.customers` table.

```
GRANT SELECT ON sh.customers TO dmuser;
```

### 34.4.2 System Privileges for Data Mining

Learn different privileges to control operations on mining models.

A system privilege confers the right to perform a particular action in the database or to perform an action on a type of schema objects. For example, the privileges to create tablespaces and to delete the rows of any table in a database are system privileges.

You can perform specific operations on mining models in other schemas if you have the appropriate system privileges. For example, `CREATE ANY MINING MODEL` enables you to create models in other schemas. `SELECT ANY MINING MODEL` enables you to apply models that reside in other schemas. You can add comments to models if you have the `COMMENT ANY MINING MODEL` privilege.

To grant a system privilege, you must either have been granted the system privilege with the `ADMIN OPTION` or have been granted the `GRANT ANY PRIVILEGE` system privilege.

The system privileges listed in the following table control operations on mining models.

**Table 34-2 System Privileges for Data Mining**

System Privilege	Allows you to....
<code>CREATE MINING MODEL</code>	Create mining models in your own schema.



**Table 34-2 (Cont.) System Privileges for Data Mining**

System Privilege	Allows you to....
CREATE ANY MINING MODEL	Create mining models in any schema.
ALTER ANY MINING MODEL	Change the name or cost matrix of any mining model in any schema.
DROP ANY MINING MODEL	Drop any mining model in any schema.
SELECT ANY MINING MODEL	Apply a mining model in any schema, also view model details in any schema.
COMMENT ANY MINING MODEL	Add a comment to any mining model in any schema.)
AUDIT_ADMIN role	Generate an audit trail for any mining model in any schema. (See <i>Oracle Database Security Guide</i> for details.)

**Example 34-8 Grant System Privileges for Data Mining**

The following statements allow `dmuser` to score data and view model details in any schema as long as `SELECT` access has been granted to the data. However, `dmuser` can only create models in the `dmuser` schema.

```
GRANT CREATE MINING MODEL TO dmuser;
GRANT SELECT ANY MINING MODEL TO dmuser;
```

The following statement revokes the privilege of scoring or viewing model details in other schemas. When this statement is executed, `dmuser` can only perform data mining activities in the `dmuser` schema.

```
REVOKE SELECT ANY MINING MODEL FROM dmuser;
```

**Related Topics**

- [Adding a Comment to a Mining Model](#)
- *Oracle Database Security Guide*

### 34.4.3 Object Privileges for Mining Models

An object privilege confers the right to perform a particular action on a specific schema object. For example, the privilege to delete rows from the `SH.PRODUCTS` table is an example of an object privilege.

You automatically have all object privileges for schema objects in your own schema. You can grant object privilege on objects in your own schema to other users or roles.

The object privileges listed in the following table control operations on specific mining models.

**Table 34-3 Object Privileges for Mining Models**

Object Privilege	Allows you to....
ALTER MINING MODEL	Change the name or cost matrix of the specified mining model object.
SELECT MINING MODEL	Apply the specified mining model object and view its model details.

**Example 34-9 Grant Object Privileges on Mining Models**

The following statements allow `dmuser` to apply the model `testmodel` to the `sales` table, specifying different cost matrixes with each apply. The user `dmuser` can also rename the model `testmodel`. The `testmodel` model and `sales` table are in the `sh` schema, not in the `dmuser` schema.

```
GRANT SELECT ON MINING MODEL sh.testmodel TO dmuser;
GRANT ALTER ON MINING MODEL sh.testmodel TO dmuser;
GRANT SELECT ON sh.sales TO dmuser;
```

The following statement prevents `dmuser` from renaming or changing the cost matrix of `testmodel`. However, `dmuser` can still apply `testmodel` to the `sales` table.

```
REVOKE ALTER ON MINING MODEL sh.testmodel FROM dmuser;
```

## 34.5 Auditing and Adding Comments to Mining Models

Mining model objects support SQL `COMMENT` and `AUDIT` statements.

### 34.5.1 Adding a Comment to a Mining Model

Comments can be used to associate descriptive information with a database object. You can associate a comment with a mining model using a SQL `COMMENT` statement.

```
COMMENT ON MINING MODEL schema_name.model_name IS string;
```

**Note:**

To add a comment to a model in another schema, you must have the `COMMENT ANY MINING MODEL` system privilege.

To drop a comment, set it to the empty `''` string.

The following statement adds a comment to the model `DT_SH_CLAS_SAMPLE` in your own schema.

```
COMMENT ON MINING MODEL dt_sh_clas_sample IS
'Decision Tree model predicts promotion response';
```

You can view the comment by querying the catalog view `USER_MINING_MODELS`.

```
SELECT model_name, mining_function, algorithm, comments FROM user_mining_models;
```

MODEL_NAME	MINING_FUNCTION	ALGORITHM	COMMENTS
DT_SH_CLAS_SAMPLE	CLASSIFICATION	DECISION_TREE	Decision Tree model predicts promotion response

To drop this comment from the database, issue the following statement:

```
COMMENT ON MINING MODEL dt_sh_clas_sample '';
```

 **See Also:**

- [Table 34-2](#)
- *Oracle Database SQL Language Reference* for details about SQL COMMENT statements

## 34.5.2 Auditing Mining Models

The Oracle Database auditing system is a powerful, highly configurable tool for tracking operations on schema objects in a production environment. The auditing system can be used to track operations on data mining models.

 **Note:**

To audit mining models, you must have the `AUDIT_ADMIN` role.

Unified auditing is documented in *Oracle Database Security Guide*. However, the full unified auditing system is not enabled by default. Instructions for migrating to unified auditing are provided in *Oracle Database Upgrade Guide*.

 **See Also:**

- "Auditing Oracle Data Mining Events" in *Oracle Database Security Guide* for details about auditing mining models
- "Monitoring Database Activity with Auditing" in *Oracle Database Security Guide* for a comprehensive discussion of unified auditing in Oracle Database
- "About the Unified Auditing Migration Process for Oracle Database" in *Oracle Database Upgrade Guide* for information about migrating to unified auditing
- *Oracle Database Upgrade Guide*

# The Data Mining Sample Programs

Describes the data mining sample programs that ship with Oracle Database.

- [About the Data Mining Sample Programs](#)
- [Installing the Data Mining Sample Programs](#)
- [The Data Mining Sample Data](#)

## 35.1 About the Data Mining Sample Programs

You can learn a great deal about the Oracle Data Mining application programming interface (API) from the data mining sample programs. The programs illustrate typical approaches to data preparation, algorithm selection, algorithm tuning, testing, and scoring.

The programs are easy to use. They include extensive inline comments to help you understand the code. They delete all temporary objects on exit; you can run the programs repeatedly without setup or cleanup.

The data mining sample programs are installed with Oracle Database Examples in the demo directory under Oracle Home. The demo directory contains sample programs that illustrate many features of Oracle Database. You can locate the data mining files by doing a directory listing of `dm*.sql`. The following example shows this directory listing on a Linux system.

Note that the directory listing in the following example includes one file, `dmhpdemo.sql`, that is *not* a data mining program.

### Example 35-1 Directory Listing of the Data Mining Sample Programs

```
> cd $ORACLE_HOME/rdbms/demo
> ls dm*.sql
dmaidemo.sql      dmkmdemo.sql      dmsvddemo.sql
dmardemo.sql      dmnbdemo.sql      dmsvodem.sql
dmdtdemo.sql      dnmmdemo.sql      dmsvrдем.sql
dmdtxvlddemo.sql dmocdemo.sql      dmtxtnmf.sql
dmemdemo.sql      dmsh.sql          dmtxtsvm.sql
dmglcdem.sql      dmshgrants.sql
dmglrdem.sql      dmstardemo.sql
dmhpdemo.sql      dmsvcdem.sql
```

The data mining sample programs create a set of mining models in the user's schema. After executing the programs, you can list the models with a query like the one in the following example.

### Example 35-2 Models Created by the Sample Programs

```
SELECT mining_function, algorithm, model_name FROM user_mining_models
       ORDER BY mining_function;
```

MINING_FUNCTION	ALGORITHM	MODEL_NAME
ASSOCIATION_RULES	APRIORI_ASSOCIATION_RULES	AR_SH_SAMPLE

CLASSIFICATION	GENERALIZED_LINEAR_MODEL	GLMC_SH_CLAS_SAMPLE
CLASSIFICATION	SUPPORT_VECTOR_MACHINES	T_SVM_CLAS_SAMPLE
CLASSIFICATION	SUPPORT_VECTOR_MACHINES	SVMC_SH_CLAS_SAMPLE
CLASSIFICATION	SUPPORT_VECTOR_MACHINES	SVMO_SH_CLAS_SAMPLE
CLASSIFICATION	NAIVE_BAYES	NB_SH_CLAS_SAMPLE
CLASSIFICATION	DECISION_TREE	DT_SH_CLAS_SAMPLE
CLUSTERING	EXPECTATION_MAXIMIZATION	EM_SH_CLUS_SAMPLE
CLUSTERING	O_CLUSTER	OC_SH_CLUS_SAMPLE
CLUSTERING	KMEANS	KM_SH_CLUS_SAMPLE
CLUSTERING	KMEANS	DM_STAR_CLUSTER
FEATURE_EXTRACTION	SINGULAR_VALUE_DECOMP	SVD_SH_SAMPLE
FEATURE_EXTRACTION	NONNEGATIVE_MATRIX_FACTOR	NMF_SH_SAMPLE
FEATURE_EXTRACTION	NONNEGATIVE_MATRIX_FACTOR	T_NMF_SAMPLE
REGRESSION	SUPPORT_VECTOR_MACHINES	SVMR_SH_REGR_SAMPLE
REGRESSION	GENERALIZED_LINEAR_MODEL	GLMR_SH_REGR_SAMPLE

## 35.2 Installing the Data Mining Sample Programs

Learn how to install Data Mining sample programs.

The data mining sample programs require:

- Oracle Database Enterprise Edition with the Advanced Analytics option
- Oracle Database sample schemas
- Oracle Database Examples
- A data mining user account
- Execution of `dmsgrants.sql` by a system administrator
- Execution of `dmsh.sql` by the data mining user

Follow these steps to install the data mining sample programs:

1. Install or obtain access to Oracle Database 12c Enterprise Edition with the Advanced Analytics option. To install the Database, see the installation instructions for your platform at Oracle Database 18c Release.
2. Ensure that the sample schemas are installed in the database. The sample schemas are installed by default with Oracle Database. See *Oracle Database Sample Schemas* for details about the sample schemas.
3. Verify that Oracle Database Examples has been installed with the database, or install it locally. Oracle Database Examples loads the Database sample programs into the `rdbms/demo` directory under Oracle home. See *Oracle Database Examples Installation Guide* for installation instructions.
4. Verify that a data mining user account has been created, or create it yourself if you have administrative privileges. See "Creating a Data Mining User".
5. Ask your system administrator to run `dmsgrants.sql`, or run it yourself if you have administrative privileges. `dmsgrants` grants the privileges that are required for running the sample programs. These include `SELECT` access to tables in the `SH` schema as described in "The Data Mining Sample Data" and the system privileges listed in the following table.

Pass the name of the data mining user to `dmsgrants`.

```
SQL> CONNECT sys / as sysdba
Enter password: sys_password
Connected.
SQL> @ $ORACLE_HOME/rdbms/demo/dmsgrants dmuser
```

**Table 35-1 System Privileges Granted by dmshgrants.sql to the Data Mining User**

Privilege	Allows the data mining user to
CREATE SESSION	log in to a database session
CREATE TABLE	create tables, such as the settings tables for CREATE_MODEL
CREATE VIEW	create views, such as the views of tables in the SH schema
CREATE MINING MODEL	create data mining models
EXECUTE ON ctxsys.ctx_ddl	execute procedures in the ctxsys.ctx_ddl PL/SQL package; required for text mining

6. Connect to the database as the data mining user and run `dmsh.sql`. This script creates views of the sample data in the schema of the data mining user.

```
SQL> CONNECT dmuser
Enter password: dmuser_password
Connected.
SQL> @ $ORACLE_HOME/rdbms/demo/dmsh
```

#### Related Topics

- [Oracle Database Sample Schemas](#)
- [Oracle Database Examples Installation Guide](#)
- [Creating a Data Mining User](#)  
Explains how to create a Data Mining user.

## 35.3 The Data Mining Sample Data

The data used by the sample data mining programs is based on these tables in the SH schema:

```
SH.CUSTOMERS
SH.SALES
SH.PRODUCTS
SH.SUPPLEMENTARY_DEMOGRAPHICS
SH.COUNTRIES
```

The `dmshgrants` script grants `SELECT` access to the tables in SH. The `dmsh.sql` script creates views of the SH tables in the schema of the data mining user. The views are described in the following table:

**Table 35-2 The Data Mining Sample Data**

View Name	Description
MINING_DATA	Joins and filters data
MINING_DATA_BUILD_V	Data for building models
MINING_DATA_TEST_V	Data for testing models
MINING_DATA_APPLY_V	Data to be scored
MINING_BUILD_TEXT	Data for building models that include text
MINING_TEST_TEXT	Data for testing models that include text
MINING_APPLY_TEXT	Data, including text columns, to be scored
MINING_DATA_ONE_CLASS_V	Data for anomaly detection

The association rules program creates its own transactional data.

# Part V

## Oracle Data Mining API Reference

Learn about Oracle Data Mining PL/SQL packages, data dictionary views, and data mining SQL scoring functions.

- [PL/SQL Packages](#)
- [Data Dictionary Views](#)
- [SQL Scoring Functions](#)



# 36

## PL/SQL Packages

Learn how to create, evaluate, and query data mining models through Data Mining PL/SQL packages.

- [DBMS\\_DATA\\_MINING](#)
- [DBMS\\_DATA\\_MINING\\_TRANSFORM](#)
- [DBMS\\_PREDICTIVE\\_ANALYTICS](#)

### 36.1 DBMS\_DATA\_MINING

The `DBMS_DATA_MINING` package is the application programming interface for creating, evaluating, and querying data mining models.

This chapter contains the following topics:

- [Overview](#)
- [Security Model](#)
- [Mining Functions](#)
- [Model Settings](#)
- [Solver Settings](#)
- [Datatypes](#)
- [Summary of DBMS\\_DATA\\_MINING Subprograms](#)



#### See Also:

- [Oracle Data Mining Concepts](#)
- [Oracle Data Mining User's Guide](#)
- [DBMS\\_DATA\\_MINING\\_TRANSFORM](#)
- [DBMS\\_PREDICTIVE\\_ANALYTICS](#)

#### 36.1.1 Using DBMS\_DATA\_MINING

This section contains topics that relate to using the `DBMS_DATA_MINING` package.

- [Overview](#)
- [Security Model](#)
- [Mining Functions](#)
- [Model Settings](#)
- [Datatypes](#)

### 36.1.1.1 DBMS\_DATA\_MINING Overview

Oracle Data Mining supports both supervised and unsupervised data mining. Supervised data mining predicts a target value based on historical data. Unsupervised data mining discovers natural groupings and does not use a target. You can use Oracle Data Mining to mine structured data and unstructured text.

Supervised data mining functions include:

- Classification
- Regression
- Feature Selection (Attribute Importance)

Unsupervised data mining functions include:

- Clustering
- Association
- Feature Extraction
- Anomaly Detection

The steps you use to build and apply a mining model depend on the data mining function and the algorithm being used. The algorithms supported by Oracle Data Mining are listed in [Table 36-1](#).

**Table 36-1 Oracle Data Mining Algorithms**

Algorithm	Abbreviation	Function
Apriori	AR	Association
CUR Matrix Decomposition	CUR	Attribute Importance
Decision Tree	DT	Classification
Expectation Maximization	EM	Clustering
Explicit Semantic Analysis	ESA	Feature Extraction, Classification
Exponential Smoothing	ESM	Time Series
Generalized Linear Model	GLM	Classification, Regression
<i>k</i> -Means	KM	Clustering
Minimum Descriptor Length	MDL	Attribute Importance
Naive Bayes	NB	Classification
Neural Networks	NN	Classification, Regression
Non-Negative Matrix Factorization	NMF	Feature Extraction
Orthogonal Partitioning Clustering	O-Cluster	Clustering
Random Forest	RF	Classification
Singular Value Decomposition and Principal Component Analysis	SVD and PCA	Feature Extraction
Support Vector Machine	SVM	Classification, Regression, Anomaly Detection

Oracle Data Mining supports more than one algorithm for the classification, regression, clustering, and feature extraction mining functions. Each of these mining functions has a default algorithm, as shown in [Table 36-2](#).

**Table 36-2 Oracle Data Mining Default Algorithms**

Mining Function	Default Algorithm
Classification	Naive Bayes
Clustering	<i>k</i> -Means
Feature Extraction	Non-Negative Matrix Factorization
Feature Selection	Minimum Descriptor Length
Regression	Support Vector Machine

### 36.1.1.2 DBMS\_DATA\_MINING Security Model

The `DBMS_DATA_MINING` package is owned by user `SYS` and is installed as part of database installation. Execution privilege on the package is granted to `public`. The routines in the package are run with invokers' rights (run with the privileges of the current user).

The `DBMS_DATA_MINING` package exposes APIs that are leveraged by the Oracle Data Mining component of the Advanced Analytics Option. Users who wish to create mining models in their own schema require the `CREATE MINING MODEL` system privilege. Users who wish to create mining models in other schemas require the `CREATE ANY MINING MODEL` system privilege.

Users have full control over managing models that exist within their own schema. Additional system privileges necessary for managing data mining models in other schemas include `ALTER ANY MINING MODEL`, `DROP ANY MINING MODEL`, `SELECT ANY MINING MODEL`, `COMMENT ANY MINING MODEL`, and `AUDIT ANY`.

Individual object privileges on mining models, `ALTER MINING MODEL` and `SELECT MINING MODEL`, can be used to selectively grant privileges on a model to a different user.



#### See Also:

*Oracle Data Mining User's Guide* for more information about the security features of Oracle Data Mining

### 36.1.1.3 DBMS\_DATA\_MINING — Mining Functions

A data mining **function** refers to the methods for solving a given class of data mining problems.

The mining function must be specified when a model is created. (See [CREATE\\_MODEL Procedure](#).)

**Table 36-3 Mining Functions**

Value	Description
ASSOCIATION	Association is a descriptive mining function. An association model identifies relationships and the probability of their occurrence within a data set. Association models use the Apriori algorithm.

**Table 36-3 (Cont.) Mining Functions**

Value	Description
ATTRIBUTE_IMPORTANCE	<p>Attribute importance is a predictive mining function, also known as feature selection. An attribute importance model identifies the relative importance of an attribute in predicting a given outcome.</p> <p>Attribute importance models can use Minimum Description Length, or CUR Matrix Decomposition. Minimum Description Length is the default.</p>
CLASSIFICATION	<p>Classification is a predictive mining function. A classification model uses historical data to predict a categorical target.</p> <p>Classification models can use: Naive Bayes, Decision Tree, Logistic Regression, or Support Vector Machine. The default is Naive Bayes.</p> <p>The classification function can also be used for <b>anomaly detection</b>. In this case, the SVM algorithm with a null target is used (One-Class SVM).</p>
CLUSTERING	<p>Clustering is a descriptive mining function. A clustering model identifies natural groupings within a data set.</p> <p>Clustering models can use <i>k</i>-Means, O-Cluster, or Expectation Maximization. The default is <i>k</i>-Means.</p>
FEATURE_EXTRACTION	<p>Feature Extraction is a descriptive mining function. A feature extraction model creates an optimized data set on which to base a model.</p> <p>Feature extraction models can use Explicit Semantic Analysis, Non-Negative Matrix Factorization, Singular Value Decomposition, or Principal Component Analysis. Non-Negative Matrix Factorization is the default.</p>
REGRESSION	<p>Regression is a predictive mining function. A regression model uses historical data to predict a numerical target.</p> <p>Regression models can use Support Vector Machine or Linear Regression. The default is Support Vector Machine.</p>
TIME_SERIES	<p>Time series is a predictive mining function. A time series model forecasts the future values of a time-ordered series of historical numeric data over a user-specified time window. Time series models use the Exponential Smoothing algorithm.</p>

**See Also:**

*Oracle Data Mining Concepts* for more information about mining functions

## 36.1.2 DBMS\_DATA\_MINING — Model Settings

Oracle Data Mining uses settings to specify the algorithm and other characteristics of a model. Some settings are general, some are specific to a mining function, and some are specific to an algorithm.

All settings have default values. If you want to override one or more of the settings for a model, you must create a settings table. The settings table must have the column names and datatypes shown in the following table.

**Table 36-4 Required Columns in the Model Settings Table**

Column Name	Datatype
SETTING_NAME	VARCHAR2 (30)
SETTING_VALUE	VARCHAR2 (4000)

The information you provide in the settings table is used by the model at build time. The name of the settings table is an optional argument to the [CREATE\\_MODEL Procedure](#).

You can find the settings used by a model by querying the data dictionary view `ALL_MINING_MODEL_SETTINGS`. This view lists the model settings used by the mining models to which you have access. All the setting values are included in the view, whether default or user-specified.

 **See Also:**

- `ALL_MINING_MODEL_SETTINGS` in *Oracle Database Reference*
- *Oracle Data Mining User's Guide* for information about specifying model settings

### 36.1.2.1 DBMS\_DATA\_MINING — Algorithm Names

The `ALGO_NAME` setting specifies the model algorithm.

The values for the `ALGO_NAME` setting are listed in the following table.

**Table 36-5 Algorithm Names**

ALGO_NAME Value	Description	Mining Function
ALGO_AI_MDL	Minimum Description Length	Attribute Importance
ALGO_APRIORI_ASSOCIATION_RULES	Apriori	Association Rules
ALGO_CUR_DECOMPOSITION	CUR Decomposition	Attribute Importance
ALGO_DECISION_TREE	Decision Tree	Classification
ALGO_EXPECTATION_MAXIMIZATION	Expectation Maximization	Clustering
ALGO_EXPLICIT_SEMANTIC_ANALYS	Explicit Semantic Analysis	Feature Extraction Classification
ALGO_EXPONENTIAL_SMOOTHING	Exponential Smoothing	Time Series
ALGO_EXTENSIBLE_LANG	Language used for extensible algorithm	All mining functions supported
ALGO_GENERALIZED_LINEAR_MODEL	Generalized Linear Model	Classification, Regression; also Feature Selection and Generation
ALGO_KMEANS	Enhanced <i>k</i> _Means	Clustering
ALGO_NAIVE_BAYES	Naive Bayes	Classification
ALGO_NEURAL_NETWORK	Neural Network	Classification
ALGO_NONNEGATIVE_MATRIX_FACTOR	Non-Negative Matrix Factorization	Feature Extraction

Table 36-5 (Cont.) Algorithm Names

ALGO_NAME Value	Description	Mining Function
ALGO_O_CLUSTER	O-Cluster	Clustering
ALGO_RANDOM_FOREST	Random Forest	Classification
ALGO_SINGULAR_VALUE_DECOMP	Singular Value Decomposition	Feature Extraction
ALGO_SUPPORT_VECTOR_MACHINES	Support Vector Machine	Classification and Regression

**See Also:**

*Oracle Data Mining Concepts* for information about algorithms

### 36.1.2.2 DBMS\_DATA\_MINING — Automatic Data Preparation

Oracle Machine Learning for SQL supports fully Automatic Data Preparation (ADP), user-directed general data preparation, and user-specified embedded data preparation. The `PREP_*` settings enable the user to request fully automated or user-directed general data preparation. By default, fully Automatic Data Preparation (`PREP_AUTO_ON`) is enabled.

When you enable ADP, the model uses heuristics to transform the build data according to the requirements of the algorithm. Instead of fully ADP, the user can request that the data be shifted and/or scaled with the `PREP_SCALE*` and `PREP_SHIFT*` settings. The transformation instructions are stored with the model and reused whenever the model is applied. The model settings can be viewed in `USER_MINING_MODEL_SETTINGS`.

You can choose to supplement Automatic Data Preparations by specifying additional transformations in the `xform_list` parameter when you build the model. See "[CREATE\\_MODEL Procedure](#)" and "[CREATE\\_MODEL2 Procedure](#)".

If you do not use ADP *and* do not specify transformations in the `xform_list` parameter to `CREATE_MODEL`, you must implement your own transformations separately in the build, test, and scoring data. You must take special care to implement the exact same transformations in each data set.

If you do not use ADP, but you *do* specify transformations in the `xform_list` parameter to `CREATE_MODEL`, OML4SQL embeds the transformation definitions in the model and prepares the test and scoring data to match the build data.

The values for the `PREP_*` setting are described in the following table.

The **Constant Value** column specifies constants using the prefix `DBMS_DATA_MINING`. For example, `DBMS_DATA_MINING.PREP_AUTO_ON`. Alternatively, you can specify the corresponding string value from the **String Value Equivalent** column without the `DBMS_DATA_MINING` prefix, in single quotes. For example, `'ON'`.

**Note:**

The distinction between **Constant Value** and **String Value Equivalent** for this algorithm is applicable to Oracle Database 19c and Oracle Database 21c.

**Table 36-6 PREP\_\* Setting**

Setting Name	Constant Value	String Value Equivalent	Description
PREP_AUTO	PREP_AUTO_ON	ON	This setting enables fully automated data preparation. The default is PREP_AUTO_ON.
	PREP_AUTO_OFF	OFF	Disables fully automated data preparation.
PREP_SCALE_2DNUM	PREP_SCALE_STDD	PREP_SCALE_STDD	This setting enables scaling data preparation for two-dimensional numeric columns. PREP_AUTO must be OFF for this setting to take effect. PREP_SCALE_STDDEV: A request to divide the column values by the standard deviation of the column and is often provided together with PREP_SHIFT_MEAN to yield z-score normalization.
	EV	EV	
	PREP_SCALE_RANGE	PREP_SCALE_RANGE	A request to divide the column values by the range of values and is often provided together with PREP_SHIFT_MIN to yield a range of [0,1].
	E	E	
PREP_SCALE_NNUM	PREP_SCALE_MAXABS	PREP_SCALE_MAXABS	This setting enables scaling data preparation for nested numeric columns. PREP_AUTO must be OFF for this setting to take effect. If specified, then the valid value for this setting is PREP_SCALE_MAXABS, which yields data in the range of [-1,1].
PREP_SHIFT_2DNUM	PREP_SHIFT_MEAN	PREP_SHIFT_MEAN	This setting enables centering data preparation for two-dimensional numeric columns. PREP_AUTO must be OFF for this setting to take effect. PREP_SHIFT_MEAN: Results in subtracting the average of the column from each value.
	PREP_SHIFT_MIN	PREP_SHIFT_MIN	Results in subtracting the minimum of the column from each value.

**See Also:**

[Oracle® Machine Learning for SQL](#) for information about data transformations

### 36.1.2.3 DBMS\_DATA\_MINING — Mining Function Settings

The settings described in this table apply to a mining function.

Table 36-7 Mining Function Settings

Mining Function	Setting Name	Setting Value	Description
Association	ASSO_MAX_RULE_LENGTH	TO_CHAR( 2<= numeric_expr <=20)	Maximum rule length for Association Rules. Default is 4.
Association	ASSO_MIN_CONFIDENCE	TO_CHAR( 0<= numeric_expr <=1)	Minimum confidence for Association Rules. Default is 0.1.
Association	ASSO_MIN_SUPPORT	TO_CHAR( 0<= numeric_expr <=1)	Minimum support for Association Rules. Default is 0.1.
Association	ASSO_MIN_SUPPORT_INT	a positive integer	Minimum absolute support that each rule must satisfy. The value must be an integer. Default is 1.
Association	ASSO_MIN_REV_CONFIDENCE	TO_CHAR( 0<= numeric_expr <=1)	Sets the Minimum Reverse Confidence that each rule should satisfy. The Reverse Confidence of a rule is defined as the number of transactions in which the rule occurs divided by the number of transactions in which the consequent occurs. The value is real number between 0 and 1. The default is 0.
Association	ASSO_IN_RULES	NULL	Sets Including Rules applied for each association rule: it specifies the list of items that at least one of them must appear in each reported association rule, either as antecedent or as consequent. It is a comma separated string containing the list of including items. If not set, the default behavior is, the filtering is not applied. For example,  <pre>INSERT INTO sett_tab (setting_name, setting_value) VALUES (dbms_data_mining.asso_in_rules, ''a'', 'b'');</pre>
Association	ASSO_EX_RULES	NULL	Sets Excluding Rules applied for each association rule: it specifies the list of items that none of them can appear in each reported Association Rules. It is a comma separated string containing the list of excluding items. No rule can contain any item in the list. The default is NULL. For example,  <pre>INSERT INTO sett_tab (setting_name, setting_value) VALUES (dbms_data_mining.asso_ex_rules, ''a'', 'b'');</pre>



Table 36-7 (Cont.) Mining Function Settings

Mining Function	Setting Name	Setting Value	Description
Association	ASSO_ANT_IN_RULES	NULL	<p>Sets Including Rules for the antecedent: it specifies the list of items that at least one of them must appear in the antecedent part of each reported association rule. It is a comma separated string containing the list of including items. The antecedent part of each rule must contain at least one item in the list.</p> <p>The default is NULL.</p> <p>For example,</p> <pre>INSERT INTO sett_tab (setting_name, setting_value) VALUES  (dbms_data_mining.asso_ant_in_rules, '''a','b''');</pre>
Association	ASSO_ANT_EX_RULES	NULL	<p>Sets Excluding Rules for the antecedent: it specifies the list of items that none of them can appear in the antecedent part of each reported association rule. It is a comma separated string containing the list of excluding items. No rule can contain any item in the list in its antecedent part.</p> <p>The default is NULL.</p> <p>For example,</p> <pre>INSERT INTO sett_tab (setting_name, setting_value) VALUES  (dbms_data_mining.asso_ant_ex_rules, '''a','b''');</pre>
Association	ASSO_CONS_IN_RULES	NULL	<p>Sets Including Rules for the consequent: it specifies the list of items that at least one of them must appear in the consequent part of each reported association rule. It is a comma separated string containing the list of including items. The consequent of each rule must be an item in the list.</p> <p>The default is NULL.</p> <p>For example,</p> <pre>INSERT INTO sett_tab (setting_name, setting_value) VALUES  (dbms_data_mining.asso_cons_in_rules, '''a','b''');</pre>

**Table 36-7 (Cont.) Mining Function Settings**

Mining Function	Setting Name	Setting Value	Description
Association	ASSO_CONS_EX_RULES	NULL	<p>Sets Excluding Rules for the consequent: it specifies the list of items that none of them can appear in the consequent part of each reported association rule. It is a comma separated string containing the list of excluding items. No rule can have any item in the list as its consequent.</p> <p>The excluding rule can be used to reduce the data that must be stored, but the user may be required to build extra model for executing different including or Excluding Rules.</p> <p>The default is NULL.</p> <p>For example,</p> <pre>INSERT INTO sett_tab (setting_name, setting_value) VALUES (dbms_data_mining.asso_cons_ex_rules, ''a'', 'b'');</pre>
Association	ASSO_AGGREGATES	NULL	<p>Specifies the columns to be aggregated. It is a comma separated string containing the names of the columns for aggregation. Number of columns in the list must be &lt;= 10.</p> <p>You can set ASSO_AGGREGATES if ODMS_ITEM_ID_COLUMN_NAME is set indicating transactional input data. See <a href="#">DBMS_DATA_MINING - Global Settings</a>. The data table must have valid column names such as ITEM_ID and CASE_ID which are derived from ODMS_ITEM_ID_COLUMN_NAME and case_id_column_name respectively.</p> <p>ITEM_VALUE is not a mandatory value.</p> <p>The default is NULL.</p> <p>For each item, the user may supply several columns to aggregate. It requires more memory to buffer the extra data. Also, the performance impact can be seen because of the larger input data set and more operation.</p>
Association	ASSO_ABS_ERROR	0<ASSO_ABS_ERRORMAX(ASSO_MIN_SUPPORT, ASSO_MIN_CONFIDENCE).	<p>Specifies the absolute error for the Association Rules sampling.</p> <p>A smaller value of ASSO_ABS_ERROR obtains a larger sample size which gives accurate results but takes longer computational time. "Set a reasonable value for ASSO_ABS_ERROR, such as its default value, to avoid large sample size. The default value is 0.5 * MAX(ASSO_MIN_SUPPORT, ASSO_MIN_CONFIDENCE).</p>

Table 36-7 (Cont.) Mining Function Settings

Mining Function	Setting Name	Setting Value	Description
Association	ASSO_CONF_LEVEL	0 ASSO_CONF_LEVEL 1	Specifies the confidence level for an Association Rules sample. A larger value of ASSO_CONF_LEVEL obtains a larger sample size. Any value between 0.9 and 1 is suitable. The default value is 0.95.
Classification	CLAS_COST_TABLE_NAME	<i>table_name</i>	(Decision Tree only) Name of a table that stores a cost matrix to be used by the algorithm in building the model. The cost matrix specifies the costs associated with misclassifications.  Only Decision Tree models can use a cost matrix at build time. All classification algorithms can use a cost matrix at apply time.  The cost matrix table is user-created. See <a href="#">"ADD_COST_MATRIX Procedure"</a> for the column requirements.  See <i>Oracle Data Mining Concepts</i> for information about costs.
Classification	CLAS_PRIORS_TABLE_NAME	<i>table_name</i>	(Naive Bayes) Name of a table that stores prior probabilities to offset differences in distribution between the build data and the scoring data.  The priors table is user-created. See <i>Oracle Data Mining User's Guide</i> for the column requirements. See <i>Oracle Data Mining Concepts</i> for additional information about priors.
Classification	CLAS_WEIGHTS_TABLE_NAME	<i>table_name</i>	(GLM and SVM only) Name of a table that stores weighting information for individual target values in SVM classification and GLM logistic regression models. The weights are used by the algorithm to bias the model in favor of higher weighted classes.  The class weights table is user-created. See <i>Oracle Data Mining User's Guide</i> for the column requirements. See <i>Oracle Data Mining Concepts</i> for additional information about class weights.
Classification	CLAS_WEIGHTS_BALANCED	ON OFF	This setting indicates that the algorithm must create a model that balances the target distribution. This setting is most relevant in the presence of rare targets, as balancing the distribution may enable better average accuracy (average of per-class accuracy) instead of overall accuracy (which favors the dominant class). The default value is OFF.
Classification	CLAS_MAX_SUP_BINS	For Decision Tree: 2 <= a <i>number</i> <=2147483647  For Random Forest: 2 <= a <i>number</i> <=254	This parameter specifies the maximum number of bins for each attribute. Default value is 32. See, <a href="#">DBMS_DATA_MINING — Automatic Data Preparation</a>

Table 36-7 (Cont.) Mining Function Settings

Mining Function	Setting Name	Setting Value	Description
Clustering	CLUS_NUM_CLUSTERS	<code>TO_CHAR( num eric_expr &gt;=1)</code>	<p>Maximum number of leaf clusters generated by a clustering algorithm. The algorithm may return fewer clusters, depending on the data.</p> <p>Enhanced <i>k</i>-Means usually produces the exact number of clusters specified by <code>CLUS_NUM_CLUSTERS</code>, unless there are fewer distinct data points.</p> <p>Expectation Maximization (EM) may return fewer clusters than the number specified by <code>CLUS_NUM_CLUSTERS</code> depending on the data. The number of clusters returned by EM cannot be greater than the number of components, which is governed by algorithm-specific settings. (See <i>Expectation Maximization Settings for Learning</i> table) Depending on these settings, there may be fewer clusters than components. If component clustering is disabled, the number of clusters equals the number of components.</p> <p>For EM, the default value of <code>CLUS_NUM_CLUSTERS</code> is system-determined. For <i>k</i>-Means and <i>O</i>-Cluster, the default is 10.</p>
Feature Extraction	FEAT_NUM_FEATURES	<code>TO_CHAR( num eric_expr &gt;=1)</code>	<p>Number of features to be extracted by a feature extraction model.</p> <p>The default is estimated from the data by the algorithm. If the matrix rank is smaller than this number, fewer features will be returned.</p> <p>For CUR Matrix Decomposition, the <code>FEAT_NUM_FEATURES</code> value is same as the <code>CURS_SVD_RANK</code> value.</p>

 **See Also:**

*Oracle Data Mining Concepts* for information about mining functions

### 36.1.2.4 DBMS\_DATA\_MINING — Global Settings

The configuration settings in this table are applicable to any type of model, but are currently only implemented for specific algorithms.

The **Constant Value** column specifies constants using the prefix `DBMS_DATA_MINING`. For example, `DBMS_DATA_MINING.ODMS_MISSING_VALUE_MEAN_MODE`. Alternatively, you can specify the corresponding string value from the **String Value Equivalent** column without the `DBMS_DATA_MINING` prefix, in single quotes. For example, `'ODMS_MISSING_VALUE_MEAN_MODE'`.

 **Note:**

The distinction between **Constant Value** and **String Value Equivalent** for this algorithm is applicable to Oracle Database 19c and Oracle Database 21c.

Table 36-8 Global Settings

Setting Name	Setting Value	String Value Equivalent	Description
ODMS_ITEM_ID_COLUMN_NAME	<i>column_name</i>	<i>column_name</i>	<p>(Association rules only) Name of a column that contains the items in a transaction. When this setting is specified, the algorithm expects the data to be presented in a native transactional format, consisting of two columns:</p> <ul style="list-style-type: none"> <li>• Case ID, either categorical or numeric</li> <li>• Item ID, either categorical or numeric</li> </ul> <p>A typical example of transactional data is market basket data, wherein a case represents a basket that may contain many items. Each item is stored in a separate row, and many rows may be needed to represent a case. The case ID values do not uniquely identify each row. Transactional data is also called multi-record case data.</p> <p>Association rules function is normally used with transactional data, but it can also be applied to single-record case data (similar to other algorithms).</p> <p>For more information about single-record and multi-record case data, see <i>Oracle SQL Developer Data Modeler User's Guide</i>.</p>
ODMS_ITEM_VALUE_COLUMN_NAME	<i>column_name</i>	<i>column_name</i>	<p>(Association rules only) Name of a column that contains a value associated with each item in a transaction. This setting is only used when a value has been specified for <code>ODMS_ITEM_ID_COLUMN_NAME</code> indicating that the data is presented in native transactional format.</p> <p>If <code>ASSO_AGGREGATES</code> is used, then the build data must include the following three columns and the columns specified in the <code>AGGREGATES</code> setting.</p> <ul style="list-style-type: none"> <li>• Case ID, either categorical or numeric</li> <li>• Item ID, either categorical or numeric, specified by <code>ODMS_ITEM_ID_COLUMN_NAME</code></li> <li>• Item value, either categorical or numeric, specified by <code>ODMS_ITEM_VALUE_COLUMN_NAME</code></li> </ul> <p>If <code>ASSO_AGGREGATES</code>, <code>Case ID</code>, and <code>Item ID</code> column are present, then the <code>Item Value</code> column may or may not appear.</p> <p>The <code>Item Value</code> column may specify information such as the number of items (for example, three apples) or the type of the item (for example, macintosh apples).</p> <p>For details on <code>ASSO_AGGREGATES</code>, see <a href="#">DBMS_DATA_MINING - Mining Function Settings</a>.</p>

**Table 36-8 (Cont.) Global Settings**

Setting Name	Setting Value	String Value Equivalent	Description
ODMS_MISSING_VALUE_TREATMENT	ODMS_MISSING_VALUE_MEAN_MODE	ODMS_MISSING_VALUE_MEAN_MODE	<p>Indicates how to treat missing values in the training data. This setting does not affect the scoring data. The default value is ODMS_MISSING_VALUE_AUTO.</p> <p>ODMS_MISSING_VALUE_MEAN_MODE replaces missing values with the mean (numeric attributes) or the mode (categorical attributes) both at build time and apply time where appropriate.</p> <p>When ODMS_MISSING_VALUE_TREATMENT is set to ODMS_MISSING_VALUE_DELETE_ROW, the rows in the training data that contain missing values are deleted. However, if you want to replicate this missing value treatment in the scoring data, then you must perform the transformation explicitly.</p>
	ODMS_MISSING_VALUE_DELETE_ROW	ODMS_MISSING_VALUE_DELETE_ROW	The value ODMS_MISSING_VALUE_DELETE_ROW applies to all algorithms.
	ODMS_MISSING_VALUE_AUTO	ODMS_MISSING_VALUE_AUTO	ODMS_MISSING_VALUE_AUTO performs different strategies for different algorithms.
ODMS_ROW_WEIGHT_COLUMN_NAME	<i>column_name</i>	<i>column_name</i>	<p>(GLM only) Name of a column in the training data that contains a weighting factor for the rows. The column data type must be NUMBER.</p> <p>Row weights can be used as a compact representation of repeated rows, as in the design of experiments where a specific configuration is repeated several times. Row weights can also be used to emphasize certain rows during model construction. For example, to bias the model towards rows that are more recent and away from potentially obsolete data.</p>
ODMS_TEXT_POLICY_NAME	The name of an Oracle Text POLICY created using CTX_DDL.CREATE_POLICY.	The name of an Oracle Text POLICY created using CTX_DDL.CREATE_POLICY.	<p>Affects how individual tokens are extracted from unstructured text.</p> <p>For details about CTX_DDL.CREATE_POLICY, see <i>Oracle Text Reference</i>.</p>
ODMS_TEXT_MAX_FEATURES	1 <= <i>value</i>	1 <= <i>value</i>	The maximum number of distinct features, across all text attributes, to use from a document set passed to CREATE_MODEL. The default is 3000. ESA has the default value of 300000.
ODMS_TEXT_MIN_DOCUMENTS	Non-negative value	Non-negative value	<p>This is a text processing setting the controls how in how many documents a token needs to appear to be used as a feature.</p> <p>The default is 1. ESA has a default of 3.</p>

**Table 36-8 (Cont.) Global Settings**

Setting Name	Setting Value	String Value Equivalent	Description
ODMS_PARTITION_COLUMNS	Comma separated list of machine learning attributes	Comma separated list of machine learning attributes	This setting indicates a request to build a partitioned model. The setting value is a comma-separated list of the machine learning attributes to be used to determine the in-list partition key values. These machine learning attributes are taken from the input columns unless an XFORM_LIST parameter is passed to CREATE_MODEL. If the XFORM_LIST parameter is passed to CREATE_MODEL, then the machine learning attributes are taken from the attributes produced by these transformations.
ODMS_MAX_PARTITIONS	1 < value <= 1000000	1 < value <= 1000000	This setting indicates the maximum number of partitions allowed for the model. The default is 1000.
ODMS_SAMPLING	ODMS_SAMPLING_ENABLE	ODMS_SAMPLING_ENABLE	This setting allows the user to request a sampling of the build data. The default is ODMS_SAMPLING_DISABLE.
	ODMS_SAMPLING_DISABLE	ODMS_SAMPLING_DISABLE	Disables sampling of the build data.
ODMS_SAMPLE_SIZE	0 < Value	0 < Value	This setting determines how many rows will be sampled (approximately). It can be set only if ODMS_SAMPLING is enabled. The default value is the system determined.
ODMS_PARTITION_BUILD_TYPE	ODMS_PARTITION_BUILD_INTRA	ODMS_PARTITION_BUILD_INTRA	This setting controls the parallel build of partitioned models. ODMS_PARTITION_BUILD_INTRA — Each partition is built in parallel using all slaves. The default mode is ODMS_PARTITION_BUILD_HYBRID
	ODMS_PARTITION_BUILD_INTER	ODMS_PARTITION_BUILD_INTER	Each partition is built entirely in a single slave, but multiple partitions may be built at the same time since multiple slaves are active.
	ODMS_PARTITION_BUILD_HYBRID	ODMS_PARTITION_BUILD_HYBRID	It is a combination of the other two types and is recommended for most situations to adapt to dynamic environments.
ODMS_TABLESPACE_NAME	<i>tablespace_name</i>	<i>tablespace_name</i>	This setting controls the storage specifications. If you explicitly sets this to the name of a tablespace (for which you have sufficient quota), then the specified tablespace storage creates the resulting model content. If you do not provide this setting, then the default tablespace of the user creates the resulting model content.
ODMS_RANDOM_SEED	Non-negative integer	Non-negative integer	The hash function with a random number seed generates a random number with uniform distribution. Users can control the random number seed by this setting. The default is 0.  This setting is used by Random Forest, Neural Network, and CUR Matrix Decomposition.

Table 36-8 (Cont.) Global Settings

Setting Name	Setting Value	String Value Equivalent	Description
ODMS_DETAILS	ODMS_ENABLE	ODMS_ENABLE	This setting reduces the space that is used while creating a model, especially a partitioned model. The default value is ODMS_ENABLE.  When the setting is ODMS_ENABLE, it creates model tables and views when the model is created. You can query the model with SQL. The reduction in space depends on the model. Reduction on the order of 10x can be achieved.
	ODMS_DISABLE	ODMS_DISABLE	When the setting is ODMS_DISABLE, model views are not created and tables relevant to model details are not created either.

 **See Also:**

*Oracle Data Mining Concepts* for information about GLM

*Oracle Data Mining Concepts* for information about Association Rules

*Oracle Data Mining User's Guide* for information about mining unstructured text

### 36.1.2.5 DBMS\_DATA\_MINING — Algorithm Settings: ALGO\_EXTENSIBLE\_LANG

The settings listed in the following table configure the behavior of the mining model with an Extensible algorithm. The mining model is built in R language.

The `RALG_*_FUNCTION` specifies the R script that is used to build, score, and view an R model and must be registered in the Oracle R Enterprise script repository. The R scripts are registered through Oracle R Enterprise with special privileges. When `ALGO_EXTENSIBLE_LANG` is set to R in the `MINING_MODEL_SETTING` table, the mining model is built in the R language. After the R model is built, the names of the R scripts are recorded in `MINING_MODEL_SETTING` table in the `SYS` schema. The scripts must exist in the script repository for the R model to function. The amount of R memory used to build, score, and view the R model through these R scripts can be controlled by Oracle R Enterprise.

All algorithm-independent `DBMS_DATA_MINING` subprograms can operate on an R model for mining functions such as Association, Attribute Importance, Classification, Clustering, Feature Extraction, and Regression.

The supported `DBMS_DATA_MINING` subprograms include, but are not limited, to the following:

- `ADD_COST_MATRIX` Procedure
- `COMPUTE_CONFUSION_MATRIX` Procedure
- `COMPUTE_LIFT` Procedure
- `COMPUTE_ROC` Procedure
- `CREATE_MODEL` Procedure



- DROP\_MODEL Procedure
- EXPORT\_MODEL Procedure
- GET\_MODEL\_COST\_MATRIX Function
- IMPORT\_MODEL Procedure
- REMOVE\_COST\_MATRIX Procedure
- RENAME\_MODEL Procedure

**Table 36-9 ALGO\_EXTENSIBLE\_LANG Settings**

Setting Name	Setting Value	Description
RALG_BUILD_FUNCTION	R_BUILD_FUNCTION_SCRIPT_NAME	Specifies the name of an existing registered R script for R algorithm mining model build function. The R script defines an R function for the first input argument for training data and returns an R model object. For Clustering and Feature Extraction mining function model build, the R attributes <code>dm\$nclus</code> and <code>dm\$nfeat</code> must be set on the R model to indicate the number of clusters and features respectively. The RALG_BUILD_FUNCTION must be set along with ALGO_EXTENSIBLE_LANG in the model_setting_table.
RALG_BUILD_PARAMETER	SELECT <i>value</i> param_name, ... FROM DUAL	Specifies a list of numeric and string scalar for optional input parameters of the model build function.
RALG_SCORE_FUNCTION	R_SCORE_FUNCTION_SCRIPT_NAME	Specifies the name of an existing registered R script to score data. The script returns a <code>data.frame</code> containing the corresponding prediction results. The setting is used to score data for mining functions such as Regression, Classification, Clustering, and Feature Extraction. This setting does not apply to Association and Attribute Importance functions
RALG_WEIGHT_FUNCTION	R_WEIGHT_FUNCTION_SCRIPT_NAME	Specifies the name of an existing registered R script for R algorithm that computes the weight (contribution) for each attribute in scoring. The script returns a <code>data.frame</code> containing the contributing weight for each attribute in a row. This function setting is needed for PREDICTION_DETAILS SQL function.
RALG_DETAILS_FUNCTION	R_DETAILS_FUNCTION_SCRIPT_NAME	Specifies the name of an existing registered R script for R algorithm that produces the model information. This setting is required to generate a model view.
RALG_DETAILS_FORMAT	SELECT <i>type_value</i> <i>column_name</i> , ... FROM DUAL	Specifies the SELECT query for the list of numeric and string scalars for the output column type and the column name of the generated model view. This setting is required to generate a model view.

**See Also:***Oracle Data Mining User's Guide*

### 36.1.2.6 DBMS\_DATA\_MINING — Algorithm Settings: CUR Matrix Decomposition

The following settings configure the behavior of the CUR Matrix Decomposition algorithm.

The **Constant Value** column specifies constants using the prefix `DBMS_DATA_MINING`. For example, `DBMS_DATA_MINING.CURS_ROW_IMP_DISABLE`. Alternatively, you can specify the corresponding string value from the **String Value Equivalent** column without the `DBMS_DATA_MINING` prefix, in single quotes. For example, `'CURS_ROW_IMP_DISABLE'`.

**Note:**

The distinction between **Constant Value** and **String Value Equivalent** for this algorithm is applicable to Oracle Database 19c and Oracle Database 21c.

**Table 36-10 CUR Matrix Decomposition Settings**

Setting Name	Constant Value	String Value Equivalent	Description
<code>CURS_APPROX_ATTR_NUM</code>	The value must be a positive integer	The value must be a positive integer	Defines the approximate number of attributes to be selected. The default value is the number of attributes.
<code>CURS_ROW_IMPORTANCE</code>	<code>CURS_ROW_IMP_ENABLE</code>  <code>CURS_ROW_IMP_DISABLE</code>	<code>CURS_ROW_IMP_ENABLE</code>  <code>CURS_ROW_IMP_DISABLE</code>	Defines the flag indicating whether or not to perform row selection. Enables row selection. The default value is <code>CURS_ROW_IMP_DISABLE</code> . Disables row selection.
<code>CURS_APPROX_ROW_NUM</code>	The value must be a positive integer	The value must be a positive integer	Defines the approximate number of rows to be selected. This parameter is only used when users decide to perform row selection ( <code>CURS_ROW_IMP_ENABLE</code> ). The default value is the total number of rows.
<code>CURS_SVD_RANK</code>	The value must be a positive integer	The value must be a positive integer	Defines the rank parameter used in the column/row leverage score calculation. If users do not provide an input value, the value is determined by the system.

**See Also:***Oracle Data Mining Concepts*

### 36.1.2.7 DBMS\_DATA\_MINING — Algorithm Settings: Decision Tree

These settings configure the behavior of the Decision Tree algorithm. Note that the Decision Tree settings are also used to configure the behavior of Random Forest as it constructs each individual Decision Tree.

The **Constant Value** column specifies constants using the prefix `DBMS_DATA_MINING`. For example, `DBMS_DATA_MINING.TREE_IMPURITY_ENTROPY`. Alternatively, you can specify the corresponding string value from the **String Value Equivalent** column without the `DBMS_DATA_MINING` prefix, in single quotes. For example, `'TREE_IMPURITY_ENTROPY'`.

 **Note:**

The distinction between **Constant Value** and **String Value Equivalent** for this algorithm is applicable to Oracle Database 19c and Oracle Database 21c.

**Table 36-11 Decision Tree Settings**

Setting Name	Constant Value	String Value Equivalent	Description
TREE_IMPURITY_METRIC	TREE_IMPURITY_ENTROPY	TREE_IMPURITY_ENTROPY	Tree impurity metric for Decision Tree.
	TREE_IMPURITY_GINI	TREE_IMPURITY_GINI	Tree algorithms seek the best test question for splitting data at each node. The best splitter and split values are those that result in the largest increase in target value homogeneity (purity) for the entities in the node. Purity is by a metric. By default, the algorithm uses <code>TREE_IMPURITY_GINI</code> .
TREE_TERM_MAX_DEPTH	For Decision Tree: $2 \leq a \text{ number} \leq 20$ For Random Forest: $2 \leq a \text{ number} \leq 100$	For Decision Tree: $2 \leq a \text{ number} \leq 20$ For Random Forest: $2 \leq a \text{ number} \leq 100$	Criteria for splits: maximum tree depth (the maximum number of nodes between the root and any leaf node, including the leaf node). For Decision Tree, the default is 7. For Random Forest, the default is 16.
TREE_TERM_MINPCT_NODE	$0 \leq a \text{ number} \leq 10$	$0 \leq a \text{ number} \leq 10$	The minimum number of training rows in a node expressed as a percentage of the rows in the training data. Default is 0.05, indicating 0.05%.
TREE_TERM_MINPCT_SPLIT	$0 < a \text{ number} \leq 20$	$0 < a \text{ number} \leq 20$	The minimum number of rows required to consider splitting a node expressed as a percentage of the training rows. Default is 0.1, indicating 0.1%.
TREE_TERM_MINREC_NODE	$a \text{ number} \geq 0$	$a \text{ number} \geq 0$	The minimum number of rows in a node. Default is 10.

Table 36-11 (Cont.) Decision Tree Settings

Setting Name	Constant Value	String Value Equivalent	Description
TREE_TERM_MINREC_SPLIT	a number > 1	a number > 1	Criteria for splits: minimum number of records in a parent node expressed as a value. No split is attempted if the number of records is below this value. Default is 20.

**See Also:**

*Oracle Data Mining Concepts* for information about Decision Tree

### 36.1.2.8 DBMS\_DATA\_MINING — Algorithm Settings: Expectation Maximization

These algorithm settings configure the behavior of the Expectation Maximization algorithm.

The **Constant Value** column specifies constants using the prefix `DBMS_DATA_MINING`. For example, `DBMS_DATA_MINING.EMCS_ATTR_FILTER_ENABLE`. Alternatively, you can specify the corresponding string value from the **String Value Equivalent** column without the `DBMS_DATA_MINING` prefix, in single quotes. For example, `'EMCS_ATTR_FILTER_ENABLE'`.

**Note:**

The distinction between **Constant Value** and **String Value Equivalent** for this algorithm is applicable to Oracle Database 19c and Oracle Database 21c.

**See Also:**

*Oracle Data Mining Concepts* for information about Expectation Maximization

**Table 36-12 Expectation Maximization Settings for Data Preparation and Analysis**

Setting Name	Constant Value	String Value Equivalent	Description
EMCS_ATTRIBUTE_FILTER	EMCS_ATTR_FILTER_ENABLE	EMCS_ATTR_FILTER_ENABLE	Whether or not to include uncorrelated attributes in the model. When EMCS_ATTRIBUTE_FILTER is enabled, uncorrelated attributes are not included.
			Default is system-determined.
	EMCS_ATTR_FILTER_DISABLE	EMCS_ATTR_FILTER_DISABLE	Includes uncorrelated attributes in the model.
EMCS_MAX_NUM_ATTR_2D	TO_CHAR( numeric_expr >=1)	TO_CHAR( numeric_expr >=1)	Maximum number of correlated attributes to include in the model. Note: This setting applies only to attributes that are not nested (2D). Default is 50.
EMCS_NUM_DISTRIBUTION	EMCS_NUM_DISTR_BERNOULLI	EMCS_NUM_DISTR_BERNOULLI	The distribution for modeling numeric attributes. Applies to the input table or view as a whole and does not allow per-attribute specifications. The options include Bernoulli, Gaussian, or system-determined distribution. When Bernoulli or Gaussian distribution is chosen, all numeric attributes are modeled using the same type of distribution. Default is EMCS_NUM_DISTR_SYSTEM.
	EMCS_NUM_DISTR_GAUSSIAN	EMCS_NUM_DISTR_GAUSSIAN	Models all numeric attributes using Gaussian distribution.
	EMCS_NUM_DISTR_SYSTEM	EMCS_NUM_DISTR_SYSTEM	When the distribution is system-determined, individual attributes may use different distributions (either Bernoulli or Gaussian), depending on the data.
EMCS_NUM_EQUIWIDTH_BINS	TO_CHAR( 1 <numeric_expr <=255)	TO_CHAR( 1 <numeric_expr <=255)	Number of equi-width bins that will be used for gathering cluster statistics for numeric columns. Default is 11.
EMCS_NUM_PROJECTIONS	TO_CHAR( numeric_expr >=1)	TO_CHAR( numeric_expr >=1)	Specifies the number of projections that will be used for each nested column. If a column has fewer distinct attributes than the specified number of projections, the data will not be projected. The setting applies to all nested columns. Default is 50.
EMCS_NUM_QUANTILE_BINS	TO_CHAR( 1 <numeric_expr <=255)	TO_CHAR( 1 <numeric_expr <=255)	Specifies the number of quantile bins that will be used for modeling numeric columns with multivalued Bernoulli distributions. Default is system-determined.



**Note:**

This setting applies only to attributes that are not nested.

**Table 36-12 (Cont.) Expectation Maximization Settings for Data Preparation and Analysis**

Setting Name	Constant Value	String Value Equivalent	Description
EMCS_NUM_TOPN_BINS	TO_CHAR( 1   <numeric_expr <=255)	TO_CHAR( 1   <numeric_ex   pr <=255)	Specifies the number of top-N bins that will be used for modeling categorical columns with multivalued Bernoulli distributions.  Default is system-determined.

**Table 36-13 Expectation Maximization Settings for Learning**

Setting Name	Constant Value	String Value Equivalent	Description
EMCS_CONVERGENCE_CRITERION	EMCS_CONV_CRIT_HEL   DASIDE	EMCS_CONV_CRIT_HEL   DASIDE	The convergence criterion for EM. The convergence criterion may be based on a held-aside data set, or it may be Bayesian Information Criterion.  EMCS_CONV_CRIT_HEL DASIDE: Uses a held-aside data set for convergence criterion.  Default is system determined.
	EMCS_CONV_CRIT_BIC	EMCS_CONV_CRIT_BIC	Uses the Bayesian Information Criterion (BIC) for convergence.
EMCS_LOGLIKE_IMPROVEMENT	TO_CHAR( 0 <   numeric_expr < 1)	TO_CHAR( 0 <   numeric_expr < 1)	When the convergence criterion is based on a held-aside data set (EMCS_CONVERGENCE_CRITERION = EMCS_CONV_CRIT_HEL DASIDE), this setting specifies the percentage improvement in the value of the log likelihood function that is required for adding a new component to the model.  Default value is 0.001.
EMCS_NUM_COMPONENTS	TO_CHAR( numeric_ex   pr >=1)	TO_CHAR( numeric_ex   pr >=1)	Maximum number of components in the model. If model search is enabled, the algorithm automatically determines the number of components based on improvements in the likelihood function or based on regularization, up to the specified maximum.  The number of components must be greater than or equal to the number of clusters.  Default is 20.
EMCS_NUM_ITERATIONS	TO_CHAR( numeric_ex   pr >=1)	TO_CHAR( numeric_ex   pr >=1)	Specifies the maximum number of iterations in the EM algorithm.  Default is 100.
EMCS_MODEL_SEARCH	EMCS_MODEL_SEARCH_   ENABLE	EMCS_MODEL_SEARCH_   ENABLE	This setting enables model search in EM where different model sizes are explored and a best size is selected.  The default is EMCS_MODEL_SEARCH_DISABLE.
	EMCS_MODEL_SEARCH_   DISABLE (default).	EMCS_MODEL_SEARCH_   DISABLE (default).	Deactivates model search.

**Table 36-13 (Cont.) Expectation Maximization Settings for Learning**

Setting Name	Constant Value	String Value Equivalent	Description
EMCS_REMOVE_COMPONENTS	EMCS_REMOVE_COMPS_ENABLE (default)	EMCS_REMOVE_COMPS_ENABLE (default)	This setting allows the EM algorithm to remove a small component from the solution. The default is EMCS_REMOVE_COMPS_ENABLE.
	EMCS_REMOVE_COMPS_DISABLE	EMCS_REMOVE_COMPS_DISABLE	Prevents the EM algorithm from removing small components.
EMCS_RANDOM_SEED	Non-negative integer	Non-negative integer	This setting controls the seed of the random generator used in EM. The default is 0.

**Table 36-14 Expectation Maximization Settings for Component Clustering**

Setting Name	Constant Value	String Value Equivalent	Description
EMCS_CLUSTER_COMPONENTS	EMCS_CLUSTER_COMP_ENABLE	EMCS_CLUSTER_COMP_ENABLE	Enables or disables the grouping of EM components into high-level clusters. When disabled, the components themselves are treated as clusters. When component clustering is enabled, model scoring through the SQL CLUSTER function will produce assignments to the higher level clusters. Default is EMCS_CLUSTER_COMP_ENABLE.
	EMCS_CLUSTER_COMP_DISABLE	EMCS_CLUSTER_COMP_DISABLE	When clustering is disabled, the CLUSTER function will produce assignments to the original components.
EMCS_CLUSTER_THRESHOLD	TO_CHAR( numeric_expr >=1)	TO_CHAR( numeric_expr >=1)	Dissimilarity threshold that controls the clustering of EM components. When the dissimilarity measure is less than the threshold, the components are combined into a single cluster. A lower threshold may produce more clusters that are more compact. A higher threshold may produce fewer clusters that are more spread out. Default is 2.
EMCS_LINKAGE_FUNCTION	EMCS_LINKAGE_SINGLE	EMCS_LINKAGE_SINGLE	Allows the specification of a linkage function for the agglomerative clustering step. EMCS_LINKAGE_SINGLE uses the nearest distance within the branch. The clusters tend to be larger and have arbitrary shapes. Default is EMCS_LINKAGE_SINGLE.
	EMCS_LINKAGE_AVERAGE	EMCS_LINKAGE_AVERAGE	EMCS_LINKAGE_AVERAGE uses the average distance within the branch. There is less chaining effect and the clusters are more compact.
	EMCS_LINKAGE_COMPLETE	EMCS_LINKAGE_COMPLETE	EMCS_LINKAGE_COMPLETE uses the maximum distance within the branch. The clusters are smaller and require strong component overlap.

**Table 36-15 Expectation Maximization Settings for Cluster Statistics**

Setting Name	Constant Value	String Value Equivalents	Description
EMCS_CLUSTER_STATISTICS	EMCS_CLUS_STATS_ENABLE	EMCS_CLUS_STATS_ENABLE	Enables or disables the gathering of descriptive statistics for clusters (centroids, histograms, and rules). Default is EMCS_CLUS_STATS_ENABLE.
	EMCS_CLUS_STATS_DISABLE	EMCS_CLUS_STATS_DISABLE	When statistics are disabled, model size is reduced, and GET_MODEL_DETAILS_EM only returns taxonomy (hierarchy) and cluster counts.
EMCS_MIN_PCT_ATTR_SUPPORT	TO_CHAR( 0 < numeric_expr < 1)	TO_CHAR( 0 < numeric_expr < 1)	Minimum support required for including an attribute in the cluster rule. The support is the percentage of the data rows assigned to a cluster that must have non-null values for the attribute. Default is 0.1.

### 36.1.2.9 DBMS\_DATA\_MINING — Algorithm Settings: Explicit Semantic Analysis

Explicit Semantic Analysis (ESA) is a useful technique for extracting meaningful and interpretable features.

The settings listed in the following table configure the ESA values.

**Table 36-16 Explicit Semantic Analysis Settings**

Setting Name	Constant Value	String Value Equivalent	Description
ESAS_VALUE_THRESHOLD	Non-negative number	Non-negative number	This setting thresholds a small value for attribute weights in the transformed build data. The default is 1e-8.
ESAS_MIN_ITEMS	Text input 100 Non-text input is 0	Text input 100 Non-text input is 0	This setting determines the minimum number of non-zero entries that need to be present in an input row. The default is 100 for text input and 0 for non-text input.
ESAS_TOPN_FEATURES	A positive integer	A positive integer	This setting controls the maximum number of features per attribute. The default is 1000.



**See Also:**

*Oracle Data Mining Concepts* for information about ESA.



### 36.1.2.10 DBMS\_DATA\_MINING — Algorithm Settings: Exponential Smoothing

These settings configure the behavior of the Exponential Smoothing (ESM) algorithm.

The **Constant Value** column specifies constants using the prefix `DBMS_DATA_MINING`. For example, `DBMS_DATA_MINING.EXSM_SIMPLE`. Alternatively, you can specify the corresponding string value from the **String Value Equivalent** column without the `DBMS_DATA_MINING` prefix, in single quotes. For example, `'EXSM_SIMPLE'`.

 **Note:**

The distinction between **Constant Value** and **String Value Equivalent** for this algorithm is applicable to Oracle Database 19c and Oracle Database 21c.

The settings listed in the following table configure Exponential Smoothing values.

**Table 36-17 Exponential Smoothing Settings**

Setting Name	Constant Value	String Value Equivalent	Description
EXSM_MODEL	EXSM_SIMPLE	EXSM_SIMPLE	This setting specifies the model.  EXSM_SIMPLE: Forecasts data as a weighted moving average, with the influence of past observations declining exponentially with the length of time since the observation occurred. Errors in estimation are assumed to be normally distributed, with constant mean and variance. It is appropriate for data with no clear trend or seasonal pattern.  The default value is EXSM_SIMPLE.
	EXSM_SIMPLE_MULT	EXSM_SIMPLE_MULT_ERR	Forecasts data as a weighted moving average, with the influence of past observations declining exponentially with the length of time since the observation occurred. Errors in estimation are assumed to be proportional to the level of the prior estimate.
	EXSM_HOLT	EXSM_HOLT	Applies Holt's linear exponential smoothing method, designed to forecast data with an underlying linear trend.
	EXSM_HOLT_DAMP	EXSM_HOLT_DAMPED	Applies Holt's linear exponential smoothing with a damping factor to progressively reduce the strength of the trend over time.
	EXSM_MULT_TRND	EXSM_MULT_TREND	Applies an exponential smoothing framework with a multiplicative trend component, effectively capturing data where trends are not linear but grow or decay over time.

Table 36-17 (Cont.) Exponential Smoothing Settings

Setting Name	Constant Value	String Value Equivalent	Description
	EXSM_MULTRD_DMP	EXSM_MULT_TREND_DAMPED	Applies an exponential smoothing algorithm with a multiplicative trend that diminishes over time, providing a conservative approach to trend estimation.
	EXSM_SEAS_ADD	EXSM_SEASON_ADD	Applies an exponential smoothing with an additive seasonal component, isolating and accounting for seasonal variations without incorporating a trend.
	EXSM_SEAS_MUL	EXSM_SEASON_MUL	Executes exponential smoothing with a multiplicative seasonal component, capturing seasonal effects that increase or decrease in proportion to the level of the series.
	EXSM_HW	EXSM_WINTERS	Applies the Holt-Winters method with additive trends and multiplicative seasonality, offering a robust model for data with both linear trend and proportional seasonal variation.
	EXSM_HW_DMP	EXSM_WINTERS_DAMPED	Applies the Holt-Winters method with a damped trend and multiplicative seasonality, moderating the linear trend over time while still capturing proportional seasonal changes.
	EXSM_HW_ADDSEA	EXSM_ADDWINTERS	Applies the Holt-Winters additive model to simultaneously smooth data with linear trends and additive seasonal effects.
	EXSM_DHW_ADDSEA	EXSM_ADDWINTERS_DAMPED	Applies the Holt-Winters additive approach with a damping mechanism, reducing the impact of the trend and seasonal components over time.
	EXSM_HWMT	EXSM_WINTERS_MULT_TREND	Applies the Holt-Winters model with both trend and seasonality components being multiplicative, suited for series where the seasonal variations and trends are both increasing or decreasing proportional to level.
	EXSM_HWMT_DMP	EXSM_WINTERS_MULT_TREND_DAMPED	Applies the Holt-Winters model with a damped multiplicative trend, effectively moderating the exponential increase or decrease of both trend and seasonal components over time.

Table 36-17 (Cont.) Exponential Smoothing Settings

Setting Name	Constant Value	String Value Equivalent	Description
EXSM_SEASONALITY	positive integer > 1	positive integer > 1	<p>This setting specifies a positive integer value as the length of seasonal cycle. The value it takes must be larger than 1. For example, setting value 4 means that every group of four observations forms a seasonal cycle.</p> <p>This setting is only applicable and must be provided for models with seasonality, otherwise the model throws an error.</p> <p>When EXSM_INTERVAL is not set, this setting applies to the original input time series. When EXSM_INTERVAL is set, this setting applies to the accumulated time series.</p>
EXSM_INTERVAL	EXSM_INTERVAL_Y EAR	EXSM_INTERVAL_Y EAR	<p>This setting only applies and must be provided when the time column (case_id column) has datetime type. It specifies the spacing interval of the accumulated equally spaced time series. The model throws an error if the time column of input table is of datetime type and setting EXSM_INTERVAL is not provided.</p> <p>EXSM_INTERVAL_YEAR: This option sets the spacing interval of the accumulated time series to one year. When selected, the data is aggregated or summarized on a yearly basis.</p>
	EXSM_INTERVAL_Q TR	EXSM_INTERVAL_Q TR	<p>This option sets the spacing interval to a quarter, aggregating the data for every three months.</p>
	EXSM_INTERVAL_M ONTH	EXSM_INTERVAL_M ONTH	<p>This option adjusts the spacing interval to one month. The accumulated time series represent aggregated or summarized data for each month.</p>
	EXSM_INTERVAL_W EEK	EXSM_INTERVAL_W EEK	<p>With this option data is aggregated or summarized on a weekly basis, setting the spacing interval to one week.</p>
	EXSM_INTERVAL_D AY	EXSM_INTERVAL_D AY	<p>This option adjusts the spacing interval to one day. It's suitable for scenarios where daily aggregated insights are required.</p>
	EXSM_INTERVAL_H OUR	EXSM_INTERVAL_H OUR	<p>For more granular insights, this option sets the spacing interval to one hour. It's especially useful when analyzing data that changes significantly within a day.</p>
	EXSM_INTERVAL_M IN	EXSM_INTERVAL_M INUTE	<p>With this option the spacing is set to one minute. This provides a very detailed view of data, suitable for applications like high-frequency trading or real-time monitoring systems.</p>

**Table 36-17 (Cont.) Exponential Smoothing Settings**

Setting Name	Constant Value	String Value Equivalent	Description
	EXSM_INTERVAL_S EC	EXSM_INTERVAL_S ECOND	For most granular details, this options sets the spacing interval to one second. It's tailored for scenarios requiring real-time or near-real-time analysis.
EXSM_INITVL_OPTIMIZE	EXSM_INITVL_OPTIMIZE_ENABLE	EXSM_INITVL_OPTIMIZE_ENABLE	The setting EXSM_INITVL_OPTIMIZE determines whether initial values are optimized during model build. The default value is EXSM_INITVL_OPTIMIZE_ENABLE.
	EXSM_INITVL_OPTIMIZE_DISABLE	EXSM_INITVL_OPTIMIZE_DISABLE	<b>Note:</b> EXSM_INITVL_OPTIMIZE can only be set to EXSM_INITVL_OPTIMIZE_DISABLE if the user has set EXSM_MODEL to EXSM_HW or EXSM_HW_ADDSEA. If EXSM_MODEL is set to another model type or is not specified, you get an error 40213 (conflicting settings) and the model is not built.
EXSM_ACCUMULATE	EXSM_ACCU_TOTAL	EXSM_ACCU_TOTAL	This setting only applies and must be provided when the time column has datetime type. It specifies how to generate the value of the accumulated time series from the input time series. EXSM_ACCU_TOTAL: This option calculates the total sum of the time series values within a specified interval. When selected, it will aggregate the data by summing up all the individual values in the datetime range. The default value is EXSM_ACCU_TOTAL.
	EXSM_ACCU_STD	EXSM_ACCU_STD	This option computes the standard deviation of the time series values within a specified interval. It helps you understand the amount of variation or dispersion in your data.
	EXSM_ACCU_MAX	EXSM_ACCU_MAX	By selecting this option, the maximum value of the time series within a specified interval will be determined. It helps in identifying the peak value in the given range.
	EXSM_ACCU_MIN	EXSM_ACCU_MIN	This option focuses on determining the minimum value of the time series within a specified interval. It is useful for identifying the lowest value in the time series for the given datetime range.
	EXSM_ACCU_AVG	EXSM_ACCU_AVG	This specifies the average value of your time series within a specified interval. It calculates the mean value of all data points in the specified range.

Table 36-17 (Cont.) Exponential Smoothing Settings

Setting Name	Constant Value	String Value Equivalent	Description
	EXSM_ACCU_MEDIAN	EXSM_ACCU_MEDIAN	This option provides the median of the time series values within the given interval. The median gives a central value, which can be especially useful if your data contains outliers.
	EXSM_ACCU_COUNT	EXSM_ACCU_COUNT	This option counts the number of time series values within the specified interval. It is helpful if you want to know how many data points are present in a certain datetime range.
EXSM_SETMISSING	Specify an option: EXSM_MISS_MIN	EXSM_MISS_MIN	This setting specifies how to handle missing values, which may come from input data and/or the accumulation process of time series. You can specify either a number or an option. If a number is specified, all the missing values are set to that number.  EXSM_MISS_MIN: Replaces missing value with minimum of the accumulated time series.
	EXSM_MISS_MAX	EXSM_MISS_MAX	Replaces missing value with maximum of the accumulated time series.
	EXSM_MISS_AVG	EXSM_MISS_AVG	Replaces missing value with average of the accumulated time series.
	EXSM_MISS_MEDIAN	EXSM_MISS_MEDIAN	Replaces missing value with median of the accumulated time series.
	EXSM_MISS_LAST	EXSM_MISS_LAST	Replaces missing value with last non-missing value of the accumulated time series.
	EXSM_MISS_FIRST	EXSM_MISS_FIRST	Replaces missing value with first non-missing value of the accumulated time series.
	EXSM_MISS_PREV	EXSM_MISS_PREV	Replaces missing value with the previous non-missing value of the accumulated time series.
	EXSM_MISS_NEXT	EXSM_MISS_NEXT	Replaces missing value with the next non-missing value of the accumulated time series.
	EXSM_MISS_AUTO	EXSM_MISS_AUTO	EXSM model treats the input data as an irregular (non-uniformly spaced) time series.  If this setting is not provided, EXSM_MISS_AUTO is the default value. In such a case, the model treats the input time series as irregular time series, viewing missing values as gaps.

Table 36-17 (Cont.) Exponential Smoothing Settings

Setting Name	Constant Value	String Value Equivalent	Description
EXSM_PREDICTION_STEP	It must be set to a number between 1-30.	It must be set to a number between 1-30.	This setting specifies how many steps ahead the predictions are to be made. If it is not set, the default value is 1: the model gives one-step-ahead prediction. A value greater than 30 results in an error.
EXSM_CONFIDENCE_LEVEL	It must be a number between 0 and 1, exclusive.	It must be a number between 0 and 1, exclusive.	This setting specifies the desired confidence level for prediction. The lower and upper bounds of the specified confidence interval is reported. If this setting is not specified, the default confidence level is 95%.
EXSM_OPT_CRITERION	EXSM_OPT_CRIT_L IK	EXSM_OPT_CRIT_L IK	This setting specifies the desired optimization criterion. The optimization criterion is useful as a diagnostic for comparing models' fit to the same data.  EXSM_OPT_CRIT_LIK: This represents the negative double of the logarithm of the likelihood associated with a given model.  The default value is EXSM_OPT_CRIT_LIK.
	EXSM_OPT_CRIT_M SE	EXSM_OPT_CRIT_M SE	This provides the mean squared error pertaining to the model.
	EXSM_OPT_CRIT_A MSE	EXSM_OPT_CRIT_A MSE	This denotes the average of the mean squared error over a time window as specified by the user.
	EXSM_OPT_CRIT_S IG	EXSM_OPT_CRIT_S IG	This metric captures the standard deviation of the residuals of the model.
	EXSM_OPT_CRIT_M AE	EXSM_OPT_CRIT_M AE	This metric conveys the average absolute error associated with the model. It measures the size of the error.
EXSM_NMSE	positive integer	positive integer	This setting specifies the length of the window used in computing the error metric Average Mean Square Error (AMSE).

 **See Also:**

*Oracle Data Mining Concepts* for information about ESM.

<https://github.com/oracle-samples/oracle-db-examples/tree/main/machine-learning/sql> browse to the release folder and click the `oml4sql-time-series-exponential-smoothing.sql` example.

### 36.1.2.11 DBMS\_DATA\_MINING — Algorithm Settings: Generalized Linear Model

The settings listed in the following table configure the behavior of the Generalized Linear Model algorithm.

The **Constant Value** column specifies constants using the prefix `DBMS_DATA_MINING`. For example, `DBMS_DATA_MINING.GLMS_FTR_GEN_QUADRATIC`. Alternatively, you can specify the corresponding string value from the **String Value Equivalent** column without the `DBMS_DATA_MINING` prefix, in single quotes. For example, `'GLMS_FTR_GEN_QUADRATIC'`.

 **Note:**

The distinction between **Constant Value** and **String Value Equivalent** for this algorithm is applicable to Oracle Database 19c and Oracle Database 21c.

**Table 36-18 DBMS\_DATA\_MINING GLM Settings**

Setting Name	Constant Value	String Value Equivalent	Description
GLMS_CONF_LEVEL	TO_CHAR(0 < numeric_expr < 1)	TO_CHAR(0 < numeric_expr < 1)	The confidence level for coefficient confidence intervals. The default confidence level is 0.95.
GLMS_FTR_GEN_METHOD	GLMS_FTR_GEN_QUADRATIC	GLMS_FTR_GEN_QUADRATIC	Whether feature generation is quadratic or cubic. When feature generation is enabled, the algorithm automatically chooses the most appropriate feature generation method based on the data. GLMS_FTR_GEN_QUADRATIC: Generates features using a quadratic method.
	GLMS_FTR_GEN_CUBIC	GLMS_FTR_GEN_CUBIC	Generates features using a cubic method.
GLMS_FTR_GENERATION	GLMS_FTR_GENERATION_ENABLE	GLMS_FTR_GENERATION_ENABLE	Whether or not feature generation is enabled for GLM. By default, feature generation is not enabled. <b>Note:</b> Feature generation can only be enabled when feature selection is also enabled.
	GLMS_FTR_GENERATION_DISABLE	GLMS_FTR_GENERATION_DISABLE	Disables feature generation for GLM (default).
GLMS_FTR_SEL_CRITERION	GLMS_FTR_SEL_AIC	GLMS_FTR_SEL_AIC	Feature selection penalty criterion for adding a feature to the model. When feature selection is enabled, the algorithm automatically chooses the penalty criterion based on the data. GLMS_FTR_SEL_AIC: Uses Akaike Information Criterion for feature selection.
	GLMS_FTR_SEL_SBIC	GLMS_FTR_SEL_SBIC	Uses Schwarz Bayesian Information Criterion for feature selection.
	GLMS_FTR_SEL_RIC	GLMS_FTR_SEL_RIC	Uses Risk Inflation Criterion for feature selection.
	GLMS_FTR_SEL_ALPHA_INV	GLMS_FTR_SEL_ALPHA_INV	Uses Alpha Inverse Criterion for feature selection.

Table 36-18 (Cont.) DBMS\_DATA\_MINING GLM Settings

Setting Name	Constant Value	String Value Equivalent	Description
GLMS_FTR_SELECTION	GLMS_FTR_SELECTION_ENABLE	GLMS_FTR_SELECTION_ENABLE	Whether or not feature selection is enabled for GLM. By default, feature selection is not enabled.
	GLMS_FTR_SELECTION_DISABLE	GLMS_FTR_SELECTION_DISABLE	Disables feature selection.
GLMS_MAX_FEATURES	TO_CHAR(0 < numeric_expr <= 2000)	TO_CHAR(0 < numeric_expr <= 2000)	When feature selection is enabled, this setting specifies the maximum number of features that can be selected for the final model. By default, the algorithm limits the number of features to ensure sufficient memory.
GLMS_PRUNE_MODEL	GLMS_PRUNE_MODEL_ENABLE	GLMS_PRUNE_MODEL_ENABLE	Enables or disables pruning of features in the final model. Pruning is based on T-Test statistics for linear regression, or Wald Test statistics for logistic regression. Features are pruned in a loop until all features are statistically significant with respect to the full data. When feature selection is enabled, the algorithm automatically prunes as described. When feature selection is disabled, you cannot specify pruning.
	GLMS_PRUNE_MODEL_DISABLE	GLMS_PRUNE_MODEL_DISABLE	Disables pruning of features.
GLMS_REFERENCE_CLASS_NAME	<i>target_value</i>	<i>target_value</i>	The target value used as the reference class in a binary logistic regression model. Probabilities are produced for the other class. By default, the algorithm chooses the value with the highest prevalence (the most cases) for the reference class.
GLMS_RIDGE_REGRESSION	GLMS_RIDGE_REG_ENABLE	GLMS_RIDGE_REG_ENABLE	Enable or disable ridge regression. Ridge applies to both regression and classification machine learning techniques. When ridge is enabled, prediction bounds are not produced by the PREDICTION_BOUNDS SQL function. <b>Note:</b> Ridge may only be enabled when feature selection is not specified, or has been explicitly disabled. If ridge regression is enabled, you cannot enable feature selection and an exception is raised.
	GLMS_RIDGE_REG_DISABLE	GLMS_RIDGE_REG_DISABLE	Disables ridge regression.
GLMS_RIDGE_VALUE	TO_CHAR (numeric_expr > 0)	TO_CHAR (numeric_expr > 0)	The value of the ridge parameter. This setting is only used when the algorithm is configured to use ridge regression. If ridge regression is enabled internally by the algorithm, then the ridge parameter is determined by the algorithm.



**Table 36-18 (Cont.) DBMS\_DATA\_MINING GLM Settings**

Setting Name	Constant Value	String Value Equivalent	Description
GLMS_ROW_DIAGNOSTICS	GLMS_ROW_DIAG_ENABLE	GLMS_ROW_DIAG_ENABLE	Enables or disables row diagnostics. GLMS_ROW_DIAG_ENABLE: Enables row diagnostics.
	GLMS_ROW_DIAG_DISABLE (default).	GLMS_ROW_DIAG_DISABLE (default).	Disables row diagnostics (default).
GLMS_CONV_TOLERANCE	The range is (0, 1) non-inclusive.	The range is (0, 1) non-inclusive.	Convergence Tolerance setting of the GLM algorithm The default value is system-determined.
GLMS_NUM_ITERATIONS	Positive integer	Positive integer	Maximum number of iterations for the GLM algorithm. The default value is system-determined.
GLMS_BATCH_ROWS	0 or Positive integer	0 or Positive integer	Number of rows in a batch used by the SGD solver. The value of this parameter sets the size of the batch for the SGD solver. An input of 0 triggers a data driven batch size estimate. The default is 2000
GLMS_SOLVER	GLMS_SOLVER_SGD (StochasticGradient Descent)	GLMS_SOLVER_SGD (StochasticGradient Descent)	This setting allows the user to choose the GLM solver. The solver cannot be selected if GLMS_FTR_SELECTION setting is enabled. GLMS_SOLVER_SGD: Optimizes generalized linear models by iteratively updating parameters using a subset of the data to minimize errors. The default value is system determined.
	GLMS_SOLVER_CHOL (Cholesky)	GLMS_SOLVER_CHOL (Cholesky)	Solves generalized linear models using the Cholesky decomposition method, which provides a stable and efficient solution by transforming the right-hand of the equation into a lower triangular matrix and its conjugate transpose.
	GLMS_SOLVER_QR	GLMS_SOLVER_QR	Utilizes the QR decomposition technique to solve generalized linear models, ensuring numerical stability and accuracy by decomposing the problem into an orthonormal matrix Q and upper triangular matrix R.
	GLMS_SOLVER_LBFGS_ADMM	GLMS_SOLVER_LBFGS_ADMM	Combines L-BFGS, an approximation of the Broyden-Fletcher-Goldfarb-Shanno optimization algorithm, with ADMM for solving large-scale generalized linear model problems efficiently.
	GLMS_SPARSE_SOLVER_ENABLE	GLMS_SPARSE_SOLVER_ENABLE	This setting allows the user to use sparse solver if it is available. The default value is GLMS_SPARSE_SOLVER_DISABLE.



**See Also:**

GLM Solvers

Table 36-18 (Cont.) DBMS\_DATA\_MINING GLM Settings

Setting Name	Constant Value	String Value Equivalent	Description
	GLMS_SPARSE_SOLVER_DISABLE (default).	GLMS_SPARSE_SOLVER_DISABLE (default).	Disables sparse solver.

**Related Topics**

- [DBMS\\_DATA\\_MINING — Algorithm Settings: Neural Network](#)  
The settings listed in the following table configure the behavior of the Neural Network algorithm.
- [DBMS\\_DATA\\_MINING — Solver Settings: LBFGS](#)  
The settings listed in the following table configure the behavior of L-BFGS. Neural Network and Generalized Linear Models (GLM) use these settings.
- [DBMS\\_DATA\\_MINING — Solver Settings: ADMM](#)  
The settings listed in the following table configure the behavior of Alternating Direction Method of Multipliers (ADMM). Generalized Linear Models (GLM) use these settings.
- *Oracle Data Mining Concepts*

 **See Also:**

*Oracle Data Mining Concepts* for information about GLM.

36.1.2.12 DBMS\_DATA\_MINING — Algorithm Settings: *k*-Means

The settings listed in the following table configure the behavior of the *k*-Means algorithm.

/

The **Constant Value** column specifies constants using the prefix `DBMS_DATA_MINING`. For example, `DBMS_DATA_MINING.KMNS_COSINE`. Alternatively, you can specify the corresponding string value from the **String Value Equivalent** column without the `DBMS_DATA_MINING` prefix, in single quotes. For example, `'KMNS_COSINE'`.

 **Note:**

The distinction between **Constant Value** and **String Value Equivalent** for this algorithm is applicable to Oracle Database 19c and Oracle Database 21c.

Table 36-19 k-Means Settings

Setting Name	Constant Value	String Value Equivalent	Description
KMNS_CONV_TOLERANCE	TO_CHAR(0<numeric_expr<1)	TO_CHAR(0<numeric_expr<1)	<p>Minimum Convergence Tolerance for <i>k</i>-Means. The algorithm iterates until the minimum Convergence Tolerance is satisfied or until the maximum number of iterations, specified in KMNS_ITERATIONS, is reached.</p> <p>Decreasing the Convergence Tolerance produces a more accurate solution but may result in longer run times.</p> <p>The default Convergence Tolerance is 0.001.</p>
KMNS_DISTANCE	KMNS_COSINE	KMNS_COSINE	<p>Distance function for <i>k</i>-Means.</p> <p>KMNS_COSINE: Uses cosine distance for <i>k</i>-Means.</p> <p>The default distance function is KMNS_EUCLIDEAN.</p>
	KMNS_EUCLIDEAN	KMNS_EUCLIDEAN	Uses Euclidean distance for <i>k</i> -Means.
KMNS_ITERATIONS	TO_CHAR(positive_numeric_expr)	TO_CHAR(positive_numeric_expr)	<p>Maximum number of iterations for <i>k</i>-Means. The algorithm iterates until either the maximum number of iterations is reached or the minimum Convergence Tolerance, specified in KMNS_CONV_TOLERANCE, is satisfied.</p> <p>The default number of iterations is 20.</p>
KMNS_MIN_PCT_ATTR_SUPPORT	TO_CHAR(0<=numeric_expr<=1)	TO_CHAR(0<=numeric_expr<=1)	<p>Minimum percentage of attribute values that must be non-null in order for the attribute to be included in the rule description for the cluster.</p> <p>If the data is sparse or includes many missing values, a minimum support that is too high can cause very short rules or even empty rules.</p> <p>The default minimum support is 0.1.</p>
KMNS_NUM_BINS	TO_CHAR(numeric_expr>0)	TO_CHAR(numeric_expr>0)	<p>Number of bins in the attribute histogram produced by <i>k</i>-means. The bin boundaries for each attribute are computed globally on the entire training data set. The binning method is equi-width. All attributes have the same number of bins with the exception of attributes with a single value that have only one bin.</p> <p>The default number of histogram bins is 11.</p>
KMNS_SPLIT_CRITERION	KMNS_SIZE	KMNS_SIZE	<p>Split criterion for <i>k</i>-means. The split criterion controls the initialization of new <i>k</i>-Means clusters. The algorithm builds a binary tree and adds one new cluster at a time.</p> <p>When the split criterion is based on size, the new cluster is placed in the area where the largest current cluster is located.</p> <p>The default split criterion is the KMNS_VARIANCE.</p>
	KMNS_VARIANCE	KMNS_VARIANCE	When the split criterion is based on the variance, the new cluster is placed in the area of the most spread-out cluster.

Table 36-19 (Cont.) k-Means Settings

Setting Name	Constant Value	String Value Equivalent	Description
KMNS_RANDOM_SEED	Non-negative integer	Non-negative integer	This setting controls the seed of the random generator used during the <i>k</i> -Means initialization. It must be a non-negative integer value. The default is 0.
KMNS_DETAILS	KMNS_DETAILS_NONE	KMNS_DETAILS_NONE	This setting determines the level of cluster detail that are computed during the build. KMNS_DETAILS_NONE: No cluster details are computed. Only the scoring information is persisted.
	KMNS_DETAILS_HIERARCHY	KMNS_DETAILS_HIERARCHY	Cluster hierarchy and cluster record counts are computed.
	KMNS_DETAILS_ALL	KMNS_DETAILS_ALL	Cluster hierarchy, record counts, descriptive statistics (means, variances, modes, histograms, and rules) are computed. This is the default value.

**See Also:**

*Oracle Data Mining Concepts* for information about *k*-Means

### 36.1.2.13 DBMS\_DATA\_MINING — Algorithm Settings: Naive Bayes

The settings listed in the following table configure the behavior of the Naive Bayes algorithm.

The **Constant Value** column specifies constants using the prefix `DBMS_DATA_MINING`. For example, `DBMS_DATA_MINING.NABS_PAIRWISE_THRESHOLD`. Alternatively, you can specify the corresponding string value from the **String Value Equivalent** column without the `DBMS_DATA_MINING` prefix, in single quotes. For example, `'NABS_PAIRWISE_THRESHOLD'`.

**Note:**

The distinction between **Constant Value** and **String Value Equivalent** for this algorithm is applicable to Oracle Database 19c and Oracle Database 21c.

Table 36-20 Naive Bayes Settings

Setting Name	Setting Value	String Value Equivalent	Description
NABS_PAIRWISE_THRESHOLD	<code>TO_CHAR(0 &lt;= numeric_expr &lt;=1)</code>	<code>TO_CHAR(0 &lt;= numeric_expr &lt;=1)</code>	Value of pairwise threshold for NB algorithm Default is 0.
NABS_SINGLETON_THRESHOLD	<code>TO_CHAR(0 &lt;= numeric_expr &lt;=1)</code>	<code>TO_CHAR(0 &lt;= numeric_expr &lt;=1)</code>	Value of singleton threshold for NB algorithm Default value is 0.

**See Also:**

*Oracle Data Mining Concepts* for information about Naive Bayes

### 36.1.2.14 DBMS\_DATA\_MINING — Algorithm Settings: Neural Network

The settings listed in the following table configure the behavior of the Neural Network algorithm.

The **Constant Value** column specifies constants using the prefix `DBMS_DATA_MINING`. For example, `DBMS_DATA_MINING.NNET_SOLVER_ADAM`. Alternatively, you can specify the corresponding string value from the **String Value Equivalent** column without the `DBMS_DATA_MINING` prefix, in single quotes. For example, `'NNET_SOLVER_ADAM'`.

**Note:**

The distinction between **Constant Value** and **String Value Equivalent** for this algorithm is applicable to Oracle Database 19c and Oracle Database 21c.

**Table 36-21 DBMS\_DATA\_MINING Neural Network Settings**

Setting Name	Constant Value	String Value Equivalents	Description
NNET_SOLVER	One of the following strings: NNET_SOLVER_ADAM	NNET_SOLVER_ADAM	Specifies the method of optimization. The default value is system determined. NNET_SOLVER_ADAM: Uses the Adam optimization method.
	NNET_SOLVER_LBFGS	NNET_SOLVER_LBFGS	Uses the Limited-memory Broyden-Fletcher-Goldfarb-Shanno (LBFGS) optimization method.

**Table 36-21 (Cont.) DBMS\_DATA\_MINING Neural Network Settings**

Setting Name	Constant Value	String Value Equivalents	Description
NNET_ACTIVATIONS	One or more of the following strings: NNET_ACTIVATIONS_A RCTAN	NNET_ACTIVATIONS_A RCTAN	<p>Specifies the activation functions for the hidden layers. You can specify a single activation function, which is then applied to each hidden layer, or you can specify an activation function for each layer individually. Different layers can have different activation functions.</p> <p>To apply a different activation function to one or more of the layers, you must specify an activation function for each layer. The number of activation functions you specify must be consistent with the NNET_HIDDEN_LAYERS and NNET_NODES_PER_LAYER values.</p> <p>For example, if you have three hidden layers, you could specify the use of the same activation function for all three layers with the following settings value:</p> <pre>( 'NNET_ACTIVATIONS',   'NNET_ACTIVATIONS_TANH' )</pre> <p>The following settings value specifies a different activation function for each layer:</p> <pre>( 'NNET_ACTIVATIONS',   'NNET_ACTIVATIONS_TANH',   'NNET_ACTIVATIONS_LOG_SIG',   'NNET_ACTIVATIONS_ARCTAN' )</pre> <div data-bbox="1149 1241 1468 1703" style="border: 1px solid #0070C0; padding: 10px; background-color: #E6F2FF;"> <p> <b>Note:</b></p> <p>You specify the different activation functions as strings within a single string. All quotes are single and two single quotes are used to escape a single quote in SQL statements and PL/SQL blocks.</p> </div> <p>NNET_ACTIVATIONS_ARCTAN: Uses the arctangent activation function. The default value is NNET_ACTIVATIONS_LOG_SIG.</p>

**Table 36-21 (Cont.) DBMS\_DATA\_MINING Neural Network Settings**

Setting Name	Constant Value	String Value Equivalents	Description
	NNET_ACTIVATIONS_B IPOLAR_SIG	NNET_ACTIVATIONS_B IPOLAR_SIG	Uses the bipolar sigmoid activation function.
	NNET_ACTIVATIONS_L INEAR	NNET_ACTIVATIONS_L INEAR	Uses the linear activation function.
	NNET_ACTIVATIONS_L OG_SIG	NNET_ACTIVATIONS_L OG_SIG	Uses the logistic sigmoid activation function.
	NNET_ACTIVATIONS_R ELU	NNET_ACTIVATIONS_R ELU	Uses the rectified linear unit activation function.
	NNET_ACTIVATIONS_T ANH	NNET_ACTIVATIONS_T ANH	Uses the hyperbolic tangent activation function.
NNET_HELDASIDE_MAX_FAIL	A positive integer	A positive integer	With NNET_REGULARIZER_HELDASIDE, the training process is stopped early if the network performance on the validation data fails to improve or remains the same for NNET_HELDASIDE_MAX_FAIL epochs in a row. The default value is 6.
NNET_HELDASIDE_RATIO	0 <= numeric_expr <=1	0 <= numeric_expr <=1	Define the held ratio for the held-aside method. The default value is 0.25.
NNET_HIDDEN_LAYERS	A positive integer	A positive integer	Defines the topology by the number of hidden layers. The default value is 1.
NNET_ITERATIONS	A positive integer	A positive integer	Specifies the maximum number of iterations in the Neural Network algorithm. For the DMSSET_NN_SOLVER_LBFGS solver, the default value is 200. For the DMSSET_NN_SOLVER_ADAM solver, the default value is 10000.
NNET_NODES_PER_LAYER	A positive integer or a list of positive integers	A positive integer or a list of positive integers	Defines the topology by the number of nodes per layer. Different layers can have different numbers of nodes. To specify the same number of nodes for each layer, you can provide a single value, which is then applied to each layer. To specify a different number of nodes for one or more layers, provide a list of comma-separated positive integers, one for each layer. For example, '10, 20, 5' for three layers. The setting values must be consistent with the NNET_HIDDEN_LAYERS value. The default number of nodes per layer is the number of attributes or 50 (if the number of attributes > 50).
NNET_REG_LAMBDA	TO_CHAR(numeric_expr >=0)	TO_CHAR(numeric_expr >=0)	Defines the L2 regularization parameter lambda. This can not be set together with NNET_REGULARIZER_HELDASIDE. The default value is 1.

Table 36-21 (Cont.) DBMS\_DATA\_MINING Neural Network Settings

Setting Name	Constant Value	String Value Equivalents	Description
NNET_REGULARIZER	One of the following strings: NNET_REGULARIZER_H ELDASIDE	NNET_REGULARIZER_H ELDASIDE	Regularization setting for Neural Network algorithm.  NNET_REGULARIZER_HELDASIDE: Uses a held-side method for regularization. If the total number of training rows is greater than 50000, the default is NNET_REGULARIZER_HELDASIDE.
	NNET_REGULARIZER_L 2	NNET_REGULARIZER_L 2	Applies L2 regularization, which penalizes the sum of squared weights.
	NNET_REGULARIZER_N ONE	NNET_REGULARIZER_N ONE	Disables regularization. If the total number of training rows is less than or equal to 50000, the default is NNET_REGULARIZER_NONE.
NNET_TOLERANCE	TO_CHAR(0< numeric_expr <1)	TO_CHAR(0< numeric_expr <1)	Defines the convergence tolerance setting of the Neural Network algorithm.  The default value is 0.000001.
NNET_WEIGHT_LOWER_BOUND	A real number	A real number	The setting specifies the lower bound of the region where weights are randomly initialized. NNET_WEIGHT_LOWER_BOUND and NNET_WEIGHT_UPPER_BOUND must be set together. Setting one and not setting the other raises an error. NNET_WEIGHT_LOWER_BOUND must not be greater than NNET_WEIGHT_UPPER_BOUND. The default value is $-\sqrt{6/(l\_nodes+r\_nodes)}$ . The value of <i>l_nodes</i> for: <ul style="list-style-type: none"> <li>input layer dense attributes is (1+number of dense attributes)</li> <li>input layer sparse attributes is number of sparse attributes</li> <li>each hidden layer is (1+number of nodes in that hidden layer)</li> </ul> The value of <i>r_nodes</i> is the number of nodes in the layer that the weight is connecting to.
NNET_WEIGHT_UPPER_BOUND	A real number	A real number	This setting specifies the upper bound of the region where weights are initialized. It should be set in pairs with NNET_WEIGHT_LOWER_BOUND and its value must not be smaller than the value of NNET_WEIGHT_LOWER_BOUND. If not specified, the values of NNET_WEIGHT_LOWER_BOUND and NNET_WEIGHT_UPPER_BOUND are system determined.  The default value is $\sqrt{6/(l\_nodes+r\_nodes)}$ . See NNET_WEIGHT_LOWER_BOUND.

**Related Topics**

- [DBMS\\_DATA\\_MINING — Solver Settings: LBFGS](#)

The settings listed in the following table configure the behavior of L-BFGS. Neural Network and Generalized Linear Models (GLM) use these settings.



**See Also:**

*Oracle Data Mining Concepts* for information about Neural Network.

### 36.1.2.15 DBMS\_DATA\_MINING — Algorithm Settings: Non-Negative Matrix Factorization

The settings listed in the following table configure the behavior of the Non-Negative Matrix Factorization algorithm.

The **Constant Value** column specifies constants using the prefix `DBMS_DATA_MINING`. For example, `DBMS_DATA_MINING.NMFS_NONNEG_SCORING_ENABLE`. Alternatively, you can specify the corresponding string value from the **String Value Equivalent** column without the `DBMS_DATA_MINING` prefix, in single quotes. For example, `'NMFS_NONNEG_SCORING_ENABLE'`.

**Note:**

The distinction between **Constant Value** and **String Value Equivalent** for this algorithm is applicable to Oracle Database 19c and Oracle Database 21c.

You can query the data dictionary view `*_MINING_MODEL_SETTINGS` (using the `ALL`, `USER`, or `DBA` prefix) to find the setting values for a model. See *Oracle Database Reference* for information about `*_MINING_MODEL_SETTINGS`.

**Table 36-22 NMF Settings**

Setting Name	Constant Value	String Value Equivalent	Description
NMFS_CONV_TOLERANCE	<code>TO_CHAR(0 &lt; numeric_expr &lt;= 0.5)</code>	<code>TO_CHAR(0 &lt; numeric_expr &lt;= 0.5)</code>	Convergence tolerance for NMF algorithm Default is 0.05
NMFS_NONNEGATIVE_SCORING	<code>NMFS_NONNEG_SCORING_ENABLE</code>	<code>NMFS_NONNEG_SCORING_ENABLE</code>	Whether negative numbers should be allowed in scoring results. When set to <code>NMFS_NONNEG_SCORING_ENABLE</code> , negative feature values will be replaced with zeros. Default is <code>NMFS_NONNEG_SCORING_ENABLE</code>
	<code>NMFS_NONNEG_SCORING_DISABLE</code>	<code>NMFS_NONNEG_SCORING_DISABLE</code>	When set to <code>NMFS_NONNEG_SCORING_DISABLE</code> , negative feature values will be allowed.
NMFS_NUM_ITERATIONS	<code>TO_CHAR(1 &lt;= numeric_expr &lt;= 500)</code>	<code>TO_CHAR(1 &lt;= numeric_expr &lt;= 500)</code>	Number of iterations for NMF algorithm Default is 50
NMFS_RANDOM_SEED	<code>TO_CHAR(numeric_expr)</code>	<code>TO_CHAR(numeric_expr)</code>	Random seed for NMF algorithm. Default is -1.

**See Also:**

*Oracle Data Mining Concepts* for information about NMF

### 36.1.2.16 DBMS\_DATA\_MINING — Algorithm Settings: O-Cluster

The settings in the table configure the behavior of the O-Cluster algorithm.

The **Constant Value** column specifies constants using the prefix `DBMS_DATA_MINING`. For example, `DBMS_DATA_MINING.OCLT_SENSITIVITY`. Alternatively, you can specify the corresponding string value from the **String Value Equivalent** column without the `DBMS_DATA_MINING` prefix, in single quotes. For example, `'OCLT_SENSITIVITY'`.

**Note:**

The distinction between **Constant Value** and **String Value Equivalent** for this algorithm is applicable to Oracle Database 19c and Oracle Database 21c.

**Table 36-23 O-Cluster Settings**

Setting Name	Constant Value	String Value Equivalent	Description
<code>OCLT_SENSITIVITY</code>	<code>TO_CHAR(0 &lt;=numeric_expr &lt;=1)</code>	<code>TO_CHAR(0 &lt;=numeric_expr &lt;=1)</code>	A fraction that specifies the peak density required for separating a new cluster. The fraction is related to the global uniform density. Default is 0.5.

**See Also:**

*Oracle Data Mining Concepts* for information about O-Cluster

### 36.1.2.17 DBMS\_DATA\_MINING — Algorithm Settings: Random Forest

These settings configure the behavior of the Random Forest algorithm. Random Forest makes use of the Decision Tree settings to configure the construction of individual trees.

The **Constant Value** column specifies constants using the prefix `DBMS_DATA_MINING`. For example, `DBMS_DATA_MINING.RFOR_MTRY`. Alternatively, you can specify the corresponding string value from the **String Value Equivalent** column without the `DBMS_DATA_MINING` prefix, in single quotes. For example, `'RFOR_MTRY'`.

**Note:**

The distinction between **Constant Value** and **String Value Equivalent** for this algorithm is applicable to Oracle Database 19c and Oracle Database 21c.

**Table 36-24 Random Forest Settings**

Setting Name	Constant Value	String Value Equivalent	Description
RFOR_MTRY	a number $\geq 0$	a number $\geq 0$	Size of the random subset of columns to be considered when choosing a split at a node. For each node, the size of the pool remains the same, but the specific candidate columns change. The default is half of the columns in the model signature. The special value 0 indicates that the candidate pool includes all columns.
RFOR_NUM_TREES	$1 \leq a \text{ number} \leq 65535$	$1 \leq a \text{ number} \leq 65535$	Number of trees in the forest Default is 20.
RFOR_SAMPLING_RATIO	$0 < a \text{ fraction} \leq 1$ 0	$0 < a \text{ fraction} \leq 1$	Fraction of the training data to be randomly sampled for use in the construction of an individual tree. The default is half of the number of rows in the training data.

**Related Topics**

- [DBMS\\_DATA\\_MINING — Algorithm Settings: Decision Tree](#)  
These settings configure the behavior of the Decision Tree algorithm. Note that the Decision Tree settings are also used to configure the behavior of Random Forest as it constructs each individual Decision Tree.

**See Also:**

*Oracle Data Mining Concepts* for information about Random Forest

### 36.1.2.18 DBMS\_DATA\_MINING — Algorithm Constants and Settings: Singular Value Decomposition

The following constant affects the behavior of the Singular Value Decomposition algorithm.

The **Constant Value** column specifies constants using the prefix `DBMS_DATA_MINING`. For example, `DBMS_DATA_MINING.SVDS_MAX_NUM_FEATURES`. Alternatively, you can specify the corresponding string value from the **String Value Equivalent** column without the `DBMS_DATA_MINING` prefix, in single quotes. For example, `'SVDS_MAX_NUM_FEATURES'`.

**Note:**

The distinction between **Constant Value** and **String Value Equivalent** for this algorithm is applicable to Oracle Database 19c and Oracle Database 21c.

**Table 36-25 Singular Value Decomposition Constant**

Constant Name	Constant Value	Description
SVDS_MAX_NUM_FEATURES	2500	The maximum number of features supported by SVD.

The following settings configure the behavior of the Singular Value Decomposition algorithm.

**Table 36-26 Singular Value Decomposition Settings**

Setting Name	Constant Value	String Value Equivalent	Description
SVDS_U_MATRIX_OUTPUT	SVDS_U_MATRIX_ENABLE	SVDS_U_MATRIX_ENABLE	Specifies whether to persist the <b>U</b> Matrix produced by SVD.  SVDS_U_MATRIX_ENABLE: The U matrix in SVD has as many rows as the number of rows in the build data. To avoid creating a large model, the U matrix is persisted only when SVDS_U_MATRIX_OUTPUT is enabled.  When SVDS_U_MATRIX_OUTPUT is enabled, the build data must include a case ID. An exception is raised if no case ID is present.  Default is SVDS_U_MATRIX_DISABLE.
	SVDS_U_MATRIX_DISABLE	SVDS_U_MATRIX_DISABLE	Does not persist the U Matrix.
SVDS_SCORING_MODE	SVDS_SCORING_SVD	SVDS_SCORING_SVD	Whether to use SVD or PCA scoring for the model.  When the build data is scored with SVD, the projections will be the same as the U matrix.  Default is SVDS_SCORING_SVD.
	SVDS_SCORING_PCA	SVDS_SCORING_PCA	When the build data is scored with PCA, the projections will be the product of the U and S matrices.

**Table 36-26 (Cont.) Singular Value Decomposition Settings**

Setting Name	Constant Value	String Value Equivalent	Description
SVDS_SOLVER	SVDS_SOLVER_TSSVD	SVDS_SOLVER_TSSVD	<p>This setting indicates the solver to be used for computing SVD of the data. In the case of PCA, the solver setting indicates the type of SVD solver used to compute the PCA for the data. When this setting is not specified the solver type selection is data driven. If the number of attributes is greater than 3240, then the default wide solver is used. Otherwise, the default narrow solver is selected.</p> <p>The following are the group of solvers:</p> <ul style="list-style-type: none"> <li>Narrow data solvers: for matrices with up to 11500 attributes (TSEIGEN) or up to 8100 attributes (TSSVD).</li> <li>Wide data solvers: for matrices up to 1 million attributes.</li> </ul> <p>For narrow data solvers:</p> <ul style="list-style-type: none"> <li>Tall-Skinny SVD uses QR computation TSVD (SVDS_SOLVER_TSSVD)</li> <li>Tall-Skinny SVD uses eigenvalue computation, TSEIGEN (SVDS_SOLVER_TSEIGEN), is the default solver for narrow data.</li> </ul> <p>For wide data solvers:</p> <ul style="list-style-type: none"> <li>Stochastic SVD uses QR computation SSVD (SVDS_SOLVER_SSVD), is the default solver for wide data solvers.</li> <li>Stochastic SVD uses eigenvalue computations, STEIGEN (SVDS_SOLVER_STEIGEN).</li> </ul>
	SVDS_SOLVER_TSEIGEN	SVDS_SOLVER_TSEIGEN	Tall-Skinny SVD using eigenvalue computation for matrices with up to 11500 attributes. This is the default solver for narrow data.
	SVDS_SOLVER_SSVD	SVDS_SOLVER_SSVD	Stochastic SVD using QR computation for matrices with up to 1 million attributes. This is the default solver for wide data.
	SVDS_SOLVER_STEIGEN	SVDS_SOLVER_STEIGEN	Stochastic SVD using eigenvalue computations for matrices with up to 1 million attributes.
SVDS_TOLERANCE	Range [0, 1]	Range [0, 1]	This setting is used to prune features. Define the minimum value the eigenvalue of a feature as a share of the first eigenvalue to not to prune. Default value is data driven.
SVDS_RANDOM_SEED	Range [0 - 4,294,967,296]	Range [0 - 4,294,967,296]	The random seed value is used for initializing the sampling matrix used by the Stochastic SVD solver. The default is 0. The SVD Solver must be set to SSVD or STEIGEN.

Table 36-26 (Cont.) Singular Value Decomposition Settings

Setting Name	Constant Value	String Value Equivalent	Description
SVDS_OVER_SAMPLING	Range [1, 5000].	Range [1, 5000].	This setting is configured the number of columns in the sampling matrix used by the Stochastic SVD solver. The number of columns in this matrix is equal to the requested number of features plus the oversampling setting. The SVD Solver must be set to SSVD or STEIGEN.
SVDS_POWER_ITERATIONS	Range [0, 20].	Range [0, 20].	The power iteration setting improves the accuracy of the SSVD solver. The default is 2. The SVD Solver must be set to SSVD or STEIGEN.

**See Also:**

*Oracle Data Mining Concepts*

### 36.1.2.19 DBMS\_DATA\_MINING — Algorithm Settings: Support Vector Machine

The settings listed in the following table configure the behavior of the Support Vector Machine algorithm.

The **Constant Value** column specifies constants using the prefix `DBMS_DATA_MINING`. For example, `DBMS_DATA_MINING.SVMS_GAUSSIAN`. Alternatively, you can specify the corresponding string value from the **String Value Equivalent** column without the `DBMS_DATA_MINING` prefix, in single quotes. For example, `'SVMS_GAUSSIAN'`.

**Note:**

The distinction between **Constant Value** and **String Value Equivalent** for this algorithm is applicable to Oracle Database 19c and Oracle Database 21c.

Table 36-27 SVM Settings

Setting Name	Constant Value	String Value Equivalent	Description
SVMS_COMPLEXITY_FACTOR	<code>TO_CHAR(numeric_expression &gt; 0)</code>	<code>TO_CHAR(numeric_expression &gt; 0)</code>	Regularization setting that balances the complexity of the model against model robustness to achieve good generalization on new data. SVM uses a data-driven approach to finding the complexity factor.  Value of complexity factor for SVM algorithm (both classification and regression).  Default value estimated from the data by the algorithm.

**Table 36-27 (Cont.) SVM Settings**

Setting Name	Constant Value	String Value Equivalent	Description
SVMS_CONV_TOLERANCE	TO_CHAR(numeric_expr >0)	TO_CHAR(numeric_expr >0)	Convergence tolerance for SVM algorithm. Default is 0.0001.
SVMS_EPSILON	TO_CHAR(numeric_expr >0)	TO_CHAR(numeric_expr >0)	Regularization setting for regression, similar to complexity factor. Epsilon specifies the allowable residuals, or noise, in the data. Value of epsilon factor for SVM regression. Default is 0.1.
SVMS_KERNEL_FUNCTION	SVMS_GAUSSIAN	SVMS_GAUSSIAN	Kernel for Support Vector Machine. Linear or Gaussian. SVMS_GAUSSIAN: Uses the Gaussian kernel for SVM. The default value is SVMS_LINEAR.
	SVMS_LINEAR	SVMS_LINEAR	Uses the Linear kernel for SVM. This is the default option.
SVMS_OUTLIER_RATE	TO_CHAR(0 < numeric_expr < 1)	TO_CHAR(0 < numeric_expr < 1)	The desired rate of outliers in the training data. Valid for One-Class SVM models only (anomaly detection). Default is 0.01.
SVMS_STD_DEV	TO_CHAR(numeric_expr >0)	TO_CHAR(numeric_expr >0)	Controls the spread of the Gaussian kernel function. SVM uses a data-driven approach to find a standard deviation value that is on the same scale as distances between typical cases. Value of standard deviation for SVM algorithm. This is applicable only for Gaussian kernel. Default value estimated from the data by the algorithm.
SVMS_NUM_ITERATIONS	Positive integer	Positive integer	This setting sets an upper limit on the number of SVM iterations. The default is system determined because it depends on the SVM solver.
SVMS_NUM_PIVOTS	Range [1; 10000]	Range [1; 10000]	This setting sets an upper limit on the number of pivots used in the Incomplete Cholesky decomposition. It can be set only for non-linear kernels. The default value is 200.
SVMS_BATCH_ROWS	Positive integer	Positive integer	This setting applies to SVM models with linear kernel. This setting sets the size of the batch for the SGD solver. An input of 0 triggers a data driven batch size estimate. The default is 20000.
SVMS_REGULARIZER	SVMS_REGULARIZER_L1	SVMS_REGULARIZER_L1	This setting controls the type of regularization that the SGD SVM solver uses. The setting can be used only for linear SVM models. The default is system determined because it depends on the potential model size. SVMS_REGULARIZER_L1: Uses L1 regularization.
	SVMS_REGULARIZER_L2	SVMS_REGULARIZER_L2	Uses L2 regularization.

Table 36-27 (Cont.) SVM Settings

Setting Name	Constant Value	String Value Equivalent	Description
SVMS_SOLVER	SVMS_SOLVER_SGD (Sub-Gradient Descend)	SVMS_SOLVER_SGD (Sub-Gradient Descend)	Enables to choose the SVM solver. The SGD solver cannot be selected if the kernel is non-linear. The default value is system determined. SVMS_SOLVER_SGD: Uses Sub-Gradient Descent solver.
	SVMS_SOLVER_IPM (Interior Point Method)	SVMS_SOLVER_IPM (Interior Point Method)	Uses Interior Point Method solver.

**See Also:**

*Oracle Data Mining Concepts* for information about SVM

### 36.1.3 DBMS\_DATA\_MINING — Solver Settings

Oracle Data Mining algorithms can use different solvers. Solver settings can be provided at build time in the setting table.

#### Related Topics

- [DBMS\\_DATA\\_MINING — Solver Settings: ADMM](#)  
The settings listed in the following table configure the behavior of Alternating Direction Method of Multipliers (ADMM). Generalized Linear Models (GLM) use these settings.
- [DBMS\\_DATA\\_MINING — Solver Settings: LBFGS](#)  
The settings listed in the following table configure the behavior of L-BFGS. Neural Network and Generalized Linear Models (GLM) use these settings.

#### 36.1.3.1 DBMS\_DATA\_MINING — Solver Settings: ADMM

The settings listed in the following table configure the behavior of Alternating Direction Method of Multipliers (ADMM). Generalized Linear Models (GLM) use these settings.

Table 36-28 DBMS\_DATA\_MINING ADMM Settings

Settings Name	Setting Value	Description
ADMM_CONSENSUS	A positive integer	It is a ADMM's consensus parameter. The value must be a positive number. The default value is 0.1.
ADMM_ITERATIONS	A positive integer	The number of ADMM iterations. The value must be a positive integer. The default value is 50.
ADMM_TOLERANCE	A positive integer	It is a tolerance parameter. The value must be a positive number. The default value is 0.0001



**Related Topics**

- [Oracle Data Mining Concepts](#)

**See Also:**

[Oracle Data Mining Concepts](#) for information about Neural Network

### 36.1.3.2 DBMS\_DATA\_MINING — Solver Settings: LBFGS

The settings listed in the following table configure the behavior of L-BFGS. Neural Network and Generalized Linear Models (GLM) use these settings.

**Table 36-29 DBMS\_DATA\_MINING L-BFGS Settings**

Setting Name	Setting Value	Description
LBFGS_GRADIENT_TOLERANCE	TO_CHAR ( <i>numeric_expr</i> >0)	Defines gradient infinity norm tolerance for L-BFGS. Default value is 1E-9.
LBFGS_HISTORY_DEPTH	The value must be a positive integer.	Defines the number of historical copies kept in L-BFGS solver. The default value is 20.
LBFGS_SCALE_HESSIAN	LBFGS_SCALE_HESSIAN_ENABLE LBFGS_SCALE_HESSIAN_DISABLE	Defines whether to scale Hessian in L-BFGS or not. Default value is LBFGS_SCALE_HESSIAN_ENABLE.

**See Also:**

[Oracle Data Mining Concepts](#) for information about Neural Network

### 36.1.4 DBMS\_DATA\_MINING Datatypes

The DBMS\_DATA\_MINING package defines object datatypes for mining transactional data. The package also defines a type for user-specified transformations. These types are called DM\_NESTED\_*n*, where *n* identifies the Oracle datatype of the nested attributes.

The Data Mining object datatypes are described in the following table:

**Table 36-30 DBMS\_DATA\_MINING Summary of Datatypes**

Datatype	Description
DM_NESTED_BINARY_DOUBLE	The name and value of a numerical attribute of type BINARY_DOUBLE.
DM_NESTED_BINARY_DOUBLES	A collection of DM_NESTED_BINARY_DOUBLE.
DM_NESTED_BINARY_FLOAT	The name and value of a numerical attribute of type BINARY_FLOAT.

**Table 36-30 (Cont.) DBMS\_DATA\_MINING Summary of Datatypes**

Datatype	Description
DM_NESTED_BINARY_FLOATS	A collection of DM_NESTED_BINARY_FLOAT.
DM_NESTED_CATEGORICAL	The name and value of a categorical attribute of type CHAR, VARCHAR, or VARCHAR2.
DM_NESTED_CATEGORICALS	A collection of DM_NESTED_CATEGORICAL.
DM_NESTED_NUMERICAL	The name and value of a numerical attribute of type NUMBER or FLOAT.
DM_NESTED_NUMERICALS	A collection of DM_NESTED_NUMERICAL.
ORA_MINING_VARCHAR2_NT	A table of VARCHAR2 (4000).
TRANSFORM_LIST	A list of user-specified transformations for a model. Accepted as a parameter by the <a href="#">CREATE_MODEL Procedure</a> . This collection type is defined in the <a href="#">DBMS_DATA_MINING_TRANSFORM</a> package.

For more information about mining nested data, see *Oracle Data Mining User's Guide*.

**Note:**

Starting from Oracle Database 12c Release 2, \*GET\_MODEL\_DETAILS are deprecated and are replaced with *Model Detail Views*. See *Oracle Data Mining User's Guide*.

### 36.1.4.1 Deprecated Types

This topic contains tables listing deprecated types.

The DBMS\_DATA\_MINING package defines object datatypes for storing information about model attributes. Most of these types are returned by the table functions GET\_n, where n identifies the type of information to return. These functions take a model name as input and return the requested information as a collection of rows.

For a list of the GET functions, see "[Summary of DBMS\\_DATA\\_MINING Subprograms](#)".

All the table functions use pipelining, which causes each row of output to be materialized as it is read from model storage, without waiting for the generation of the complete table object. For more information on pipelined, parallel table functions, consult the *Oracle Database PL/SQL Language Reference*.

**Table 36-31 DBMS\_DATA\_MINING Summary of Deprecated Datatypes**

Datatype	Description
DM_CENTROID	The centroid of a cluster.
DM_CENTROIDS	A collection of DM_CENTROID. A member of DM_CLUSTER.
DM_CHILD	A child node of a cluster.
DM_CHILDREN	A collection of DM_CHILD. A member of DM_CLUSTER.

**Table 36-31 (Cont.) DBMS\_DATA\_MINING Summary of Deprecated Datatypes**

Datatype	Description
DM_CLUSTER	A cluster. A cluster includes DM_PREDICATES, DM_CHILDREN, DM_CENTROIDS, and DM_HISTOGRAMS. It also includes a DM_RULE. See also, <a href="#">DM_CLUSTER Fields</a> .
DM_CLUSTERS	A collection of DM_CLUSTER. Returned by <a href="#">GET_MODEL_DETAILS_KM Function</a> , <a href="#">GET_MODEL_DETAILS_OC Function</a> , and <a href="#">GET_MODEL_DETAILS_EM Function</a> . See also, <a href="#">DM_CLUSTER Fields</a> .
DM_CONDITIONAL	The conditional probability of an attribute in a Naive Bayes model.
DM_CONDITIONALS	A collection of DM_CONDITIONAL. Returned by <a href="#">GET_MODEL_DETAILS_NB Function</a> .
DM_COST_ELEMENT	The actual and predicted values in a cost matrix.
DM_COST_MATRIX	A collection of DM_COST_ELEMENT. Returned by <a href="#">GET_MODEL_COST_MATRIX Function</a> .
DM_EM_COMPONENT	A component of an Expectation Maximization model.
DM_EM_COMPONENT_SET	A collection of DM_EM_COMPONENT. Returned by <a href="#">GET_MODEL_DETAILS_EM_COMP Function</a> .
DM_EM_PROJECTION	A projection of an Expectation Maximization model.
DM_EM_PROJECTION_SET	A collection of DM_EM_PROJECTION. Returned by <a href="#">GET_MODEL_DETAILS_EM_PROJ Function</a> .
DM_GLM_COEFF	The coefficient and associated statistics of an attribute in a Generalized Linear Model.
DM_GLM_COEFF_SET	A collection of DM_GLM_COEFF. Returned by <a href="#">GET_MODEL_DETAILS_GLM Function</a> .
DM_HISTOGRAM_BIN	A histogram associated with a cluster.
DM_HISTOGRAMS	A collection of DM_HISTOGRAM_BIN. A member of DM_CLUSTER. See also, <a href="#">DM_CLUSTER Fields</a> .
DM_ITEM	An item in an association rule.
DM_ITEMS	A collection of DM_ITEM.
DM_ITEMSET	A collection of DM_ITEMS.
DM_ITEMSETS	A collection of DM_ITEMSET. Returned by <a href="#">GET_FREQUENT_ITEMSETS Function</a> .
DM_MODEL_GLOBAL_DETAIL	High-level statistics about a model.
DM_MODEL_GLOBAL_DETAILS	A collection of DM_MODEL_GLOBAL_DETAIL. Returned by <a href="#">GET_MODEL_DETAILS_GLOBAL Function</a> .
DM_NB_DETAIL	Information about an attribute in a Naive Bayes model.
DM_NB_DETAILS	A collection of DM_NB_DETAIL. Returned by <a href="#">GET_MODEL_DETAILS_NB Function</a> .
DM_NMF_ATTRIBUTE	An attribute in a feature of a Non-Negative Matrix Factorization model.
DM_NMF_ATTRIBUTE_SET	A collection of DM_NMF_ATTRIBUTE. A member of DM_NMF_FEATURE.

**Table 36-31 (Cont.) DBMS\_DATA\_MINING Summary of Deprecated Datatypes**

Datatype	Description
DM_NMF_FEATURE	A feature in a Non-Negative Matrix Factorization model.
DM_NMF_FEATURE_SET	A collection of DM_NMF_FEATURE. Returned by <a href="#">GET_MODEL_DETAILS_NMF Function</a> .
DM_PREDICATE	Antecedent and consequent in a rule.
DM_PREDICATES	A collection of DM_PREDICATE. A member of DM_RULE and DM_CLUSTER. Predicates are returned by <a href="#">GET_ASSOCIATION_RULES Function</a> , <a href="#">GET_MODEL_DETAILS_EM Function</a> , <a href="#">GET_MODEL_DETAILS_KM Function</a> , and <a href="#">GET_MODEL_DETAILS_OC Function</a> . See also, <a href="#">DM_CLUSTER Fields</a> .
DM_RANKED_ATTRIBUTE	An attribute ranked by its importance in an Attribute Importance model.
DM_RANKED_ATTRIBUTES	A collection of DM_RANKED_ATTRIBUTE. Returned by <a href="#">GET_MODEL_DETAILS_AI Function</a> .
DM_RULE	A rule that defines a conditional relationship. The rule can be one of the association rules returned by <a href="#">GET_ASSOCIATION_RULES Function</a> , or it can be a rule associated with a cluster in the collection of clusters returned by <a href="#">GET_MODEL_DETAILS_KM Function</a> and <a href="#">GET_MODEL_DETAILS_OC Function</a> . See also, <a href="#">DM_CLUSTER Fields</a> .
DM_RULES	A collection of DM_RULE. Returned by <a href="#">GET_ASSOCIATION_RULES Function</a> . See also, <a href="#">DM_CLUSTER Fields</a> .
DM_SVD_MATRIX	A factorized matrix S, V, or U returned by a Singular Value Decomposition model.
DM_SVD_MATRIX_SET	A collection of DM_SVD_MATRIX. Returned by <a href="#">GET_MODEL_DETAILS_SVD Function</a> .
DM_SVM_ATTRIBUTE	The name, value, and coefficient of an attribute in a Support Vector Machine model.
DM_SVM_ATTRIBUTE_SET	A collection of DM_SVM_ATTRIBUTE. Returned by <a href="#">GET_MODEL_DETAILS_SVM Function</a> . Also a member of DM_SVM_LINEAR_COEFF.
DM_SVM_LINEAR_COEFF	The linear coefficient of each attribute in a Support Vector Machine model.
DM_SVM_LINEAR_COEFF_SET	A collection of DM_SVM_LINEAR_COEFF. Returned by <a href="#">GET_MODEL_DETAILS_SVM Function</a> for an SVM model built using the linear kernel.
DM_TRANSFORM	The transformation and reverse transformation expressions for an attribute.
DM_TRANSFORMS	A collection of DM_TRANSFORM. Returned by <a href="#">GET_MODEL_TRANSFORMATIONS Function</a> .

## Return Values for Clustering Algorithms

The table contains description of `DM_CLUSTER` return value columns, nested table columns, and rows.

**Table 36-32 DM\_CLUSTER Return Values for Clustering Algorithms**

Return Value	Description
<code>DM_CLUSTERS</code>	<p>A set of rows of type <code>DM_CLUSTER</code>. The rows have the following columns:</p> <pre>(id          NUMBER,  cluster_id  VARCHAR2(4000),  record_count NUMBER,  parent      NUMBER,  tree_level  NUMBER,  dispersion  NUMBER,  split_predicate DM_PREDICATES,  child       DM_CHILDREN,  centroid    DM_CENTROIDS,  histogram   DM_HISTOGRAMS,  rule        DM_RULE)</pre>
<code>DM_PREDICATE</code>	<p>The antecedent and consequent columns each return nested tables of type <code>DM_PREDICATES</code>. The rows, of type <code>DM_PREDICATE</code>, have the following columns:</p> <pre>(attribute_name  VARCHAR2(4000),  attribute_subname VARCHAR2(4000),  conditional_operator CHAR(2) /*=, &lt;&gt;, &lt;, &gt;, &lt;=, &gt;=*/,  attribute_num_value NUMBER,  attribute_str_value VARCHAR2(4000),  attribute_support NUMBER,  attribute_confidence NUMBER)</pre>

## DM\_CLUSTER Fields

The following table describes `DM_CLUSTER` fields.

**Table 36-33 DM\_CLUSTER Fields**

Column Name	Description
<code>id</code>	Cluster identifier
<code>cluster_id</code>	The ID of a cluster in the model
<code>record_count</code>	Specifies the number of records
<code>parent</code>	Parent ID
<code>tree_level</code>	Specifies the number of splits from the root
<code>dispersion</code>	A measure used to quantify whether a set of observed occurrences are dispersed compared to a standard statistical model.

Table 36-33 (Cont.) DM\_CLUSTER Fields

Column Name	Description
split_predicate	<p>The split_predicate column of DM_CLUSTER returns a nested table of type DM_PREDICATES. Each row, of type DM_PREDICATE, has the following columns:</p> <pre> (attribute_name      VARCHAR2(4000),  attribute_subname   VARCHAR2(4000),  conditional_operator CHAR(2) /  *=,&lt;&gt;,&lt;,&gt;,&lt;=,&gt;=*/  attribute_num_value NUMBER,  attribute_str_value VARCHAR2(4000),  attribute_support   NUMBER,  attribute_confidence NUMBER) </pre> <p>Note: The Expectation Maximization algorithm uses all the fields except dispersion and split_predicate.</p>
child	<p>The child column of DM_CLUSTER returns a nested table of type DM_CHILDREN. The rows, of type DM_CHILD, have a single column of type NUMBER, which contains the identifiers of each child.</p>
centroid	<p>The centroid column of DM_CLUSTER returns a nested table of type DM_CENTROIDS. The rows, of type DM_CENTROID, have the following columns:</p> <pre> (attribute_name      VARCHAR2(4000),  attribute_subname   VARCHAR2(4000),  mean                NUMBER,  mode_value          VARCHAR2(4000),  variance            NUMBER) </pre>
histogram	<p>The histogram column of DM_CLUSTER returns a nested table of type DM_HISTOGRAMS. The rows, of type DM_HISTOGRAM_BIN, have the following columns:</p> <pre> (attribute_name      VARCHAR2(4000),  attribute_subname   VARCHAR2(4000),  bin_id              NUMBER,  lower_bound         NUMBER,  upper_bound         NUMBER,  label                VARCHAR2(4000),  count                NUMBER) </pre>
rule	<p>The rule column of DM_CLUSTER returns a single row of type DM_RULE. The columns are:</p> <pre> (rule_id              INTEGER,  antecedent           DM_PREDICATES,  consequent           DM_PREDICATES,  rule_support         NUMBER,  rule_confidence      NUMBER,  rule_lift            NUMBER,  antecedent_support   NUMBER,  consequent_support   NUMBER,  number_of_items      INTEGER) </pre>

**Usage Notes**

- The table function pipes out rows of type `DM_CLUSTER`. For information on Data Mining datatypes and piped output from table functions, see "Datatypes".
- For descriptions of predicates (`DM_PREDICATE`) and rules (`DM_RULE`), see [GET\\_ASSOCIATION\\_RULES Function](#).

## 36.1.5 Summary of DBMS\_DATA\_MINING Subprograms

This table summarizes the subprograms included in the `DBMS_DATA_MINING` package.

The `GET_*` interfaces are replaced by model views. Oracle recommends that users leverage model detail views instead. For more information, refer to "Model Detail Views" in *Oracle Data Mining User's Guide* and "Static Data Dictionary Views: `ALL_ALL_TABLES` to `ALL_OUTLINES`" in *Oracle Database Reference*.

**Table 36-34 DBMS\_DATA\_MINING Package Subprograms**

Subprogram	Purpose
<a href="#">ADD_COST_MATRIX Procedure</a>	Adds a cost matrix to a classification model
<a href="#">ADD_PARTITION Procedure</a>	Adds single or multiple partitions in an existing partition model
<a href="#">ALTER_REVERSE_EXPRESSION Procedure</a>	Changes the reverse transformation expression to an expression that you specify
<a href="#">APPLY Procedure</a>	Applies a model to a data set (scores the data)
<a href="#">COMPUTE_CONFUSION_MATRIX Procedure</a>	Computes the confusion matrix for a classification model
<a href="#">COMPUTE_CONFUSION_MATRIX_PART Procedure</a>	Computes the evaluation matrix for partitioned models
<a href="#">COMPUTE_LIFT Procedure</a>	Computes lift for a classification model
<a href="#">COMPUTE_LIFT_PART Procedure</a>	Computes lift for partitioned models
<a href="#">COMPUTE_ROC Procedure</a>	Computes Receiver Operating Characteristic (ROC) for a classification model
<a href="#">COMPUTE_ROC_PART Procedure</a>	Computes Receiver Operating Characteristic (ROC) for a partitioned model
<a href="#">CREATE_MODEL Procedure</a>	Creates a model
<a href="#">CREATE_MODEL2 Procedure</a>	Creates a model without extra persistent stages
<a href="#">Create Model Using Registration Information</a>	Fetches setting information from JSON object
<a href="#">DROP_ALGORITHM Procedure</a>	Drops the registered algorithm information.
<a href="#">DROP_PARTITION Procedure</a>	Drops a single partition
<a href="#">DROP_MODEL Procedure</a>	Drops a model
<a href="#">EXPORT_MODEL Procedure</a>	Exports a model to a dump file
<a href="#">EXPORT_SERMODEL Procedure</a>	Exports a model in a serialized format
<a href="#">FETCH_JSON_SCHEMA Procedure</a>	Fetches and reads JSON schema from <code>all_mining_algorithms</code> view
<a href="#">GET_MODEL_COST_MATRIX Function</a>	Returns the cost matrix for a model
<a href="#">IMPORT_MODEL Procedure</a>	Imports a model into a user schema
<a href="#">IMPORT_SERMODEL Procedure</a>	Imports a serialized model back into the database

**Table 36-34 (Cont.) DBMS\_DATA\_MINING Package Subprograms**

Subprogram	Purpose
<a href="#">JSON Schema for R Extensible Algorithm</a>	Displays flexibility in creating JSON schema for R Extensible Algorithm
<a href="#">REGISTER_ALGORITHM Procedure</a>	Registers a new algorithm
<a href="#">RANK_APPLY Procedure</a>	Ranks the predictions from the APPLY results for a classification model
<a href="#">REMOVE_COST_MATRIX Procedure</a>	Removes a cost matrix from a model
<a href="#">RENAME_MODEL Procedure</a>	Renames a model

**Deprecated GET\_MODEL\_DETAILS**

Starting from Oracle Database 12c Release 2, the following GET\_MODEL\_DETAILS are deprecated:

**Table 36-35 Deprecated GET\_MODEL\_DETAILS Functions**

Subprogram	Purpose
<a href="#">GET_ASSOCIATION_RULES Function</a>	Returns the rules from an association model
<a href="#">GET_FREQUENT_ITEMSETS Function</a>	Returns the frequent itemsets for an association model
<a href="#">GET_MODEL_DETAILS_AI Function</a>	Returns details about an Attribute Importance model
<a href="#">GET_MODEL_DETAILS_EM Function</a>	Returns details about an Expectation Maximization model
<a href="#">GET_MODEL_DETAILS_EM_COMP Function</a>	Returns details about the parameters of an Expectation Maximization model
<a href="#">GET_MODEL_DETAILS_EM_PROJ Function</a>	Returns details about the projects of an Expectation Maximization model
<a href="#">GET_MODEL_DETAILS_GLM Function</a>	Returns details about a Generalized Linear Model
<a href="#">GET_MODEL_DETAILS_GLOBAL Function</a>	Returns high-level statistics about a model
<a href="#">GET_MODEL_DETAILS_KM Function</a>	Returns details about a <i>k</i> -Means model
<a href="#">GET_MODEL_DETAILS_NB Function</a>	Returns details about a Naive Bayes model
<a href="#">GET_MODEL_DETAILS_NMF Function</a>	Returns details about a Non-Negative Matrix Factorization model
<a href="#">GET_MODEL_DETAILS_OC Function</a>	Returns details about an O-Cluster model
<a href="#">GET_MODEL_SETTINGS Function</a>	Returns the settings used to build the given model This function is replaced with USER/ALL/ DBA_MINING_MODEL_SETTINGS
<a href="#">GET_MODEL_SIGNATURE Function</a>	Returns the list of columns from the build input table This function is replaced with USER/ALL/ DBA_MINING_MODEL_ATTRIBUTES
<a href="#">GET_MODEL_DETAILS_SVD Function</a>	Returns details about a Singular Value Decomposition model



**Table 36-35 (Cont.) Deprecated GET\_MODEL\_DETAILS Functions**

Subprogram	Purpose
<a href="#">GET_MODEL_DETAILS_SVM Function</a>	Returns details about a Support Vector Machine model with a linear kernel
<a href="#">GET_MODEL_TRANSFORMATIONS Function</a>	Returns the transformations embedded in a model This function is replaced with <code>USER/ALL/DBA_MINING_MODEL_XFORMS</code>
<a href="#">GET_MODEL_DETAILS_XML Function</a>	Returns details about a Decision Tree model
<a href="#">GET_TRANSFORM_LIST Procedure</a>	Converts between two different transformation specification formats

**Related Topics**

- *Oracle Data Mining User's Guide*
- *Oracle Database Reference*

### 36.1.5.1 ADD\_COST\_MATRIX Procedure

The `ADD_COST_MATRIX` procedure associates a cost matrix table with a Classification model. The cost matrix biases the model by assigning costs or benefits to specific model outcomes.

The cost matrix is stored with the model and taken into account when the model is scored.

You can also specify a cost matrix inline when you invoke a Data Mining SQL function for scoring. To view the scoring matrix for a model, query the `DM$VC` prefixed model view. Refer to Model Detail View for Classification Algorithm.

To obtain the default scoring matrix for a model, query the `DM$VC` prefixed model view. To remove the default scoring matrix from a model, use the `REMOVE_COST_MATRIX` procedure. See "[GET\\_MODEL\\_COST\\_MATRIX Function](#)" and "[REMOVE\\_COST\\_MATRIX Procedure](#)".

** See Also:**

- "Biasing a Classification Model" in *Oracle Data Mining Concepts* for more information about costs
- *Oracle Database SQL Language Reference* for syntax of inline cost matrix
- *Oracle Data Mining User's Guide*

**Syntax**

```
DBMS_DATA_MINING.ADD_COST_MATRIX (
    model_name           IN VARCHAR2,
    cost_matrix_table_name IN VARCHAR2,
    cost_matrix_schema_name IN VARCHAR2 DEFAULT NULL);
partition_name         IN VARCHAR2 DEFAULT NULL);
```

## Parameters

**Table 36-36 ADD\_COST\_MATRIX Procedure Parameters**

Parameter	Description
<code>model_name</code>	Name of the model in the form <code>[schema_name.]model_name</code> . If you do not specify a schema, then your own schema is assumed.
<code>cost_matrix_table_name</code>	Name of the cost matrix table (described in <a href="#">Table 36-37</a> ).
<code>cost_matrix_schema_name</code>	Schema of the cost matrix table. If no schema is specified, then the current schema is used.
<code>partition_name</code>	Name of the partition in a partitioned model

## Usage Notes

1. If the model is not in your schema, then `ADD_COST_MATRIX` requires the `ALTER ANY MINING MODEL` system privilege or the `ALTER` object privilege for the mining model.
2. The cost matrix table must have the columns shown in [Table 36-37](#).

**Table 36-37 Required Columns in a Cost Matrix Table**

Column Name	Datatype
<code>ACTUAL_TARGET_VALUE</code>	Valid target data type
<code>PREDICTED_TARGET_VALUE</code>	Valid target data type
<code>COST</code>	NUMBER, FLOAT, BINARY_DOUBLE, or BINARY_FLOAT

### See Also:

*Oracle Data Mining User's Guide* for valid target datatypes

3. The types of the actual and predicted target values must be the same as the type of the model target. For example, if the target of the model is `BINARY_DOUBLE`, then the actual and predicted values must be `BINARY_DOUBLE`. If the actual and predicted values are `CHAR` or `VARCHAR`, then `ADD_COST_MATRIX` treats them as `VARCHAR2` internally.

If the types do not match, or if the actual or predicted value is not a valid target value, then the `ADD_COST_MATRIX` procedure raises an error.

### Note:

If a reverse transformation is associated with the target, then the actual and predicted values must be consistent with the target after the reverse transformation has been applied.

See “Reverse Transformations and Model Transparency” under the “About Transformation Lists” section in [DBMS\\_DATA\\_MINING\\_TRANSFORM Operational Notes](#) for more information.

4. Since a benefit can be viewed as a negative cost, you can specify a benefit for a given outcome by providing a negative number in the `costs` column of the cost matrix table.
5. All Classification algorithms can use a cost matrix for scoring. The Decision Tree algorithm can also use a cost matrix at build time. If you want to build a Decision Tree model with a cost matrix, specify the cost matrix table name in the `CLAS_COST_TABLE_NAME` setting in the settings table for the model. See [Table 36-7](#).

The cost matrix used to create a Decision Tree model becomes the default scoring matrix for the model. If you want to specify different costs for scoring, use the `REMOVE_COST_MATRIX` procedure to remove the cost matrix and the `ADD_COST_MATRIX` procedure to add a new one.

6. Scoring on a partitioned model is partition-specific. Scoring cost matrices can be added to or removed from an individual partition in a partitioned model. If `PARTITION_NAME` is NOT NULL, then the model must be a partitioned model. The `COST_MATRIX` is added to that partition of the partitioned model.

If the `PARTITION_NAME` is NULL, but the model is a partitioned model, then the `COST_MATRIX` table is added to every partition in the model.

### Example

This example creates a cost matrix table called `COSTS_NB` and adds it to a Naive Bayes model called `NB_SH_CLAS_SAMPLE`. The model has a binary target: 1 means that the customer responds to a promotion; 0 means that the customer does not respond. The cost matrix assigns a cost of .25 to misclassifications of customers who do not respond and a cost of .75 to misclassifications of customers who do respond. This means that it is three times more costly to misclassify responders than it is to misclassify non-responders.

```
CREATE TABLE costs_nb (
  actual_target_value      NUMBER,
  predicted_target_value   NUMBER,
  cost                     NUMBER);
INSERT INTO costs_nb values (0, 0, 0);
INSERT INTO costs_nb values (0, 1, .25);
INSERT INTO costs_nb values (1, 0, .75);
INSERT INTO costs_nb values (1, 1, 0);
COMMIT;

EXEC dbms_data_mining.add_cost_matrix('nb_sh_clas_sample', 'costs_nb');

SELECT cust_gender, COUNT(*) AS cnt, ROUND(AVG(age)) AS avg_age
  FROM mining_data_apply_v
 WHERE PREDICTION(nb_sh_clas_sample COST MODEL
    USING cust_marital_status, education, household_size) = 1
 GROUP BY cust_gender
 ORDER BY cust_gender;
```

C	CNT	AVG_AGE
F	72	39
M	555	44

## 36.1.5.2 ADD\_PARTITION Procedure

ADD\_PARTITION procedure supports a single or multiple partition addition to an existing partitioned model.

The ADD\_PARTITION procedure derives build settings and user-defined expressions from the existing model. The target column must exist in the input data query when adding partitions to a supervised model.

### Syntax

```
DBMS_DATA_MINING.ADD_PARTITION (
    model_name           IN VARCHAR2,
    data_query           IN CLOB,
    add_options          IN VARCHAR2 DEFAULT ERROR);
```

### Parameters

**Table 36-38 ADD\_PARTITION Procedure Parameters**

Parameter	Description
model_name	Name of the model in the form [ <i>schema_name</i> .] <i>model_name</i> . If you do not specify a schema, then your own schema is used.
data_query	An arbitrary SQL statement that provides data to the model build. The user must have privilege to evaluate this query.
add_options	Allows users to control the conditional behavior of ADD for cases where rows in the input dataset conflict with existing partitions in the model. The following are the possible values: <ul style="list-style-type: none"> <li>REPLACE: Replaces the existing partition for which the conflicting keys are found.</li> <li>ERROR: Terminates the ADD operation without adding any partitions.</li> <li>IGNORE: Eliminates the rows having the conflicting keys.</li> </ul>

#### Note:

For better performance, Oracle recommends using DROP\_PARTITION followed by the ADD\_PARTITION instead of using the REPLACE option.

## 36.1.5.3 ALTER\_REVERSE\_EXPRESSION Procedure

This procedure replaces a reverse transformation expression with an expression that you specify. If the attribute does not have a reverse expression, the procedure creates one from the specified expression.

You can also use this procedure to customize the output of clustering, feature extraction, and anomaly detection models.

### Syntax

```
DBMS_DATA_MINING.ALTER_REVERSE_EXPRESSION (
    model_name          VARCHAR2,
```

```

expression          CLOB,
attribute_name      VARCHAR2 DEFAULT NULL,
attribute_subname   VARCHAR2 DEFAULT NULL);

```

## Parameters

**Table 36-39 ALTER\_REVERSE\_EXPRESSION Procedure Parameters**

Parameter	Description
model_name	Name of the model in the form [ <i>schema_name</i> .] <i>model_name</i> . If you do not specify a schema, your own schema is used.
expression	An expression to replace the reverse transformation associated with the attribute.
attribute_name	Name of the attribute. Specify NULL if you wish to apply <i>expression</i> to a cluster, feature, or One-Class SVM prediction.
attribute_subname	Name of the nested attribute if <i>attribute_name</i> is a nested column, otherwise NULL.

## Usage Notes

- For purposes of model transparency, Oracle Data Mining provides reverse transformations for transformations that are embedded in a model. Reverse transformations are applied to the attributes returned in model details (`GET_MODEL_DETAILS_*` functions) and to the scored target of predictive models.

### See Also:

"About Transformation Lists" under [DBMS\\_DATA\\_MINING\\_TRANSFORM Operational Notes](#)

- If you alter the reverse transformation for the target of a model that has a cost matrix, you must specify a transformation expression that has the same type as the actual and predicted values in the cost matrix. Also, the reverse transformation that you specify must result in values that are present in the cost matrix.

### See Also:

"[ADD\\_COST\\_MATRIX Procedure](#)" and *Oracle Data Mining Concepts* for information about cost matrixes.

- To prevent reverse transformation of an attribute, you can specify NULL for *expression*.
- The reverse transformation expression can contain a reference to a PL/SQL function that returns a valid Oracle datatype. For example, you could define a function like the following for a categorical attribute named `blood_pressure` that has values 'Low', 'Medium' and 'High'.

```

CREATE OR REPLACE FUNCTION numx(c char) RETURN NUMBER IS
BEGIN
  CASE c WHEN 'Low' THEN RETURN 1;
         WHEN 'Medium' THEN RETURN 2;
         WHEN 'High' THEN RETURN 3;

```

```

        ELSE RETURN null;
    END CASE;
END numx;

```

Then you could invoke `ALTER_REVERSE_EXPRESSION` for `blood_pressure` as follows.

```

EXEC dbms_data_mining.alter_reverse_expression(
    '<model_name>', 'NUMX(blood_pressure)', 'blood_pressure');

```

5. You can use `ALTER_REVERSE_EXPRESSION` to label clusters produced by clustering models and features produced by feature extraction.

You can use `ALTER_REVERSE_EXPRESSION` to replace the zeros and ones returned by anomaly-detection models. By default, anomaly-detection models label anomalous records with 0 and all other records with 1.

### See Also:

*Oracle Data Mining Concepts* for information about anomaly detection

## Examples

1. In this example, the target (`affinity_card`) of the model `CLASS_MODEL` is manipulated internally as `yes` or `no` instead of 1 or 0 but returned as 1s and 0s when scored. The `ALTER_REVERSE_EXPRESSION` procedure causes the target values to be returned as `TRUE` or `FALSE`.

The data sets `MINING_DATA_BUILD` and `MINING_DATA_TEST` are included with the Oracle Data Mining sample programs. See *Oracle Data Mining User's Guide* for information about the sample programs.

```

DECLARE
    v_xlst dbms_data_mining_transform.TRANSFORM_LIST;
BEGIN
    dbms_data_mining_transform.SET_TRANSFORM(v_xlst,
        'affinity_card', NULL,
        'decode(affinity_card, 1, 'yes', 'no')',
        'decode(affinity_card, 'yes', 1, 0)');
    dbms_data_mining.CREATE_MODEL(
        model_name           => 'CLASS_MODEL',
        mining_function       => dbms_data_mining.classification,
        data_table_name      => 'mining_data_build',
        case_id_column_name  => 'cust_id',
        target_column_name   => 'affinity_card',
        settings_table_name  => NULL,
        data_schema_name     => 'dmuser',
        settings_schema_name => NULL,
        xform_list           => v_xlst );
END;
/
SELECT cust_income_level, occupation,
       PREDICTION(CLASS_MODEL USING *) predict_response
FROM   mining_data_test WHERE age = 60 AND cust_gender IN 'M'
ORDER BY cust_income_level;

```

CUST_INCOME_LEVEL	OCCUPATION	PREDICT_RESPONSE
A: Below 30,000	Transp.	1
E: 90,000 - 109,999	Transp.	1

```

E: 90,000 - 109,999      Sales      1
G: 130,000 - 149,999   Handler   0
G: 130,000 - 149,999   Crafts    0
H: 150,000 - 169,999   Prof.     1
J: 190,000 - 249,999   Prof.     1
J: 190,000 - 249,999   Sales     1

```

```

BEGIN
  dbms_data_mining.ALTER_REVERSE_EXPRESSION (
    model_name      => 'CLASS_MODEL',
    expression      => 'decode(affinity_card, 'yes', 'TRUE', 'FALSE')',
    attribute_name  => 'affinity_card');
END;
/
column predict_response on
column predict_response format a20
SELECT cust_income_level, occupation,
       PREDICTION(CLASS_MODEL USING *) predict_response
FROM mining_data_test WHERE age = 60 AND cust_gender IN 'M'
ORDER BY cust_income_level;

```

CUST_INCOME_LEVEL	OCCUPATION	PREDICT_RESPONSE
A: Below 30,000	Transp.	TRUE
E: 90,000 - 109,999	Transp.	TRUE
E: 90,000 - 109,999	Sales	TRUE
G: 130,000 - 149,999	Handler	FALSE
G: 130,000 - 149,999	Crafts	FALSE
H: 150,000 - 169,999	Prof.	TRUE
J: 190,000 - 249,999	Prof.	TRUE
J: 190,000 - 249,999	Sales	TRUE

2. This example specifies labels for the clusters that result from the `sh_clus` model. The labels consist of the word "Cluster" and the internal numeric identifier for the cluster.

```

BEGIN
  dbms_data_mining.ALTER_REVERSE_EXPRESSION('sh_clus', ''Cluster '||value');
END;
/

SELECT cust_id, cluster_id(sh_clus using *) cluster_id
FROM sh_aprep_num
WHERE cust_id < 100011
ORDER by cust_id;

```

CUST_ID	CLUSTER_ID
100001	Cluster 18
100002	Cluster 14
100003	Cluster 14
100004	Cluster 18
100005	Cluster 19
100006	Cluster 7
100007	Cluster 18
100008	Cluster 14
100009	Cluster 8
100010	Cluster 8

### 36.1.5.4 APPLY Procedure

The `APPLY` procedure applies a mining model to the data of interest, and generates the results in a table. The `APPLY` procedure is also referred to as **scoring**.

For predictive mining functions, the `APPLY` procedure generates predictions in a target column. For descriptive mining functions such as Clustering, the `APPLY` process assigns each case to a cluster with a probability.

In Oracle Data Mining, the `APPLY` procedure is not applicable to Association models and Attribute Importance models.



#### Note:

Scoring can also be performed directly in SQL using the Data Mining functions. See

- "Data Mining Functions" in *Oracle Database SQL Language Reference*
- "Scoring and Deployment" in *Oracle Data Mining User's Guide*

#### Syntax

```
DBMS_DATA_MINING.APPLY (
    model_name          IN VARCHAR2,
    data_table_name     IN VARCHAR2,
    case_id_column_name IN VARCHAR2,
    result_table_name   IN VARCHAR2,
    data_schema_name    IN VARCHAR2 DEFAULT NULL);
```

#### Parameters

**Table 36-40** *APPLY Procedure Parameters*

Parameter	Description
<code>model_name</code>	Name of the model in the form <code>[schema_name.]model_name</code> . If you do not specify a schema, then your own schema is used.
<code>data_table_name</code>	Name of table or view containing the data to be scored
<code>case_id_column_name</code>	Name of the case identifier column
<code>result_table_name</code>	Name of the table in which to store apply results
<code>data_schema_name</code>	Name of the schema containing the data to be scored

#### Usage Notes

1. The data provided for `APPLY` must undergo the same preprocessing as the data used to create and test the model. When you use Automatic Data Preparation, the preprocessing required by the algorithm is handled for you by the model: both at build time and apply time. (See "[Automatic Data Preparation](#)".)
2. `APPLY` creates a table in the user's schema to hold the results. The columns are algorithm-specific.



The columns in the results table are listed in [Table 36-41](#) through [Table 36-45](#). The case ID column name in the results table will match the case ID column name provided by you. The type of the incoming case ID column is also preserved in `APPLY` output.

 **Note:**

Make sure that the case ID column does not have the same name as one of the columns that will be created by `APPLY`. For example, when applying a Classification model, the case ID in the scoring data must not be `PREDICTION` or `PROBABILITY` (See [Table 36-41](#)).

3. The datatype for the `PREDICTION`, `CLUSTER_ID`, and `FEATURE_ID` output columns is influenced by any reverse expression that is embedded in the model by the user. If the user does not provide a reverse expression that alters the scored value type, then the types will conform to the descriptions in the following tables. See "[ALTER\\_REVERSE\\_EXPRESSION Procedure](#)".
4. If the model is partitioned, the `result_table_name` can contain results from different partitions depending on the data from the input data table. An additional column called `PARTITION_NAME` is added to the result table indicating the partition name that is associated with each row.

For a non-partitioned model, the behavior does not change.

### Classification

The results table for Classification has the columns described in [Table 36-41](#). If the target of the model is categorical, the `PREDICTION` column will have a `VARCHAR2` datatype. If the target has a binary type, the `PREDICTION` column will have the binary type of the target.

**Table 36-41** `APPLY` Results Table for Classification

Column Name	Datatype
<i>Case ID column name</i>	Type of the case ID
<code>PREDICTION</code>	Type of the target
<code>PROBABILITY</code>	<code>BINARY_DOUBLE</code>

### Anomaly Detection

The results table for Anomaly Detection has the columns described in [Table 36-42](#).

**Table 36-42** `APPLY` Results Table for Anomaly Detection

Column Name	Datatype
<i>Case ID column name</i>	Type of the case ID
<code>PREDICTION</code>	<code>NUMBER</code>
<code>PROBABILITY</code>	<code>BINARY_DOUBLE</code>

### Regression

The results table for Regression has the columns described in [APPLY Procedure](#).

**Table 36-43 APPLY Results Table for Regression**

Column Name	Datatype
<i>Case ID column name</i>	Type of the case ID
PREDICTION	Type of the target

### Clustering

Clustering is an unsupervised mining function, and hence there are no targets. The results of an `APPLY` procedure will contain simply the cluster identifier corresponding to a case, and the associated probability. The results table has the columns described in [Table 36-44](#).

**Table 36-44 APPLY Results Table for Clustering**

Column Name	Datatype
<i>Case ID column name</i>	Type of the case ID
CLUSTER_ID	NUMBER
PROBABILITY	BINARY_DOUBLE

### Feature Extraction

Feature Extraction is also an unsupervised mining function, and hence there are no targets. The results of an `APPLY` procedure will contain simply the feature identifier corresponding to a case, and the associated match quality. The results table has the columns described in [Table 36-45](#).

**Table 36-45 APPLY Results Table for Feature Extraction**

Column Name	Datatype
<i>Case ID column name</i>	Type of the case ID
FEATURE_ID	NUMBER
MATCH_QUALITY	BINARY_DOUBLE

### Examples

This example applies the GLM Regression model `GLMR_SH_REGR_SAMPLE` to the data in the `MINING_DATA_APPLY_V` view. The `APPLY` results are output of the table `REGRESSION_APPLY_RESULT`.

```
SQL> BEGIN
      DBMS_DATA_MINING.APPLY (
        model_name      => 'glmr_sh_regr_sample',
        data_table_name => 'mining_data_apply_v',
        case_id_column_name => 'cust_id',
        result_table_name => 'regression_apply_result');
      END;
      /

SQL> SELECT * FROM regression_apply_result WHERE cust_id > 101485;

      CUST_ID PREDICTION
      -----
```

```
101486 22.8048824
101487 25.0261101
101488 48.6146619
101489 51.82595
101490 22.6220714
101491 61.3856816
101492 24.1400748
101493 58.034631
101494 45.7253149
101495 26.9763318
101496 48.1433425
101497 32.0573434
101498 49.8965531
101499 56.270656
101500 21.1153047
```

### 36.1.5.5 COMPUTE\_CONFUSION\_MATRIX Procedure

This procedure computes a confusion matrix, stores it in a table in the user's schema, and returns the model accuracy.

A confusion matrix is a test metric for classification models. It compares the predictions generated by the model with the actual target values in a set of test data. The confusion matrix lists the number of times each class was correctly predicted and the number of times it was predicted to be one of the other classes.

COMPUTE\_CONFUSION\_MATRIX accepts three input streams:

- The predictions generated on the test data. The information is passed in three columns:
  - Case ID column
  - Prediction column
  - Scoring criterion column containing either probabilities or costs
- The known target values in the test data. The information is passed in two columns:
  - Case ID column
  - Target column containing the known target values
- (Optional) A cost matrix table with predefined columns. See the Usage Notes for the column requirements.

#### See Also:

*Oracle Data Mining Concepts* for more details about confusion matrixes and other test metrics for classification

["COMPUTE\\_LIFT Procedure"](#)

["COMPUTE\\_ROC Procedure"](#)

#### Syntax

```
DBMS_DATA_MINING.COMPUTE_CONFUSION_MATRIX (  
    accuracy                OUT NUMBER,  
    apply_result_table_name IN VARCHAR2,  
    target_table_name       IN VARCHAR2,
```

```

case_id_column_name      IN  VARCHAR2,
target_column_name       IN  VARCHAR2,
confusion_matrix_table_name IN  VARCHAR2,
score_column_name        IN  VARCHAR2 DEFAULT 'PREDICTION',
score_criterion_column_name IN VARCHAR2 DEFAULT 'PROBABILITY',
cost_matrix_table_name   IN  VARCHAR2 DEFAULT NULL,
apply_result_schema_name IN  VARCHAR2 DEFAULT NULL,
target_schema_name       IN  VARCHAR2 DEFAULT NULL,
cost_matrix_schema_name  IN  VARCHAR2 DEFAULT NULL,
score_criterion_type     IN  VARCHAR2 DEFAULT 'PROBABILITY');

```

## Parameters

**Table 36-46 COMPUTE\_CONFUSION\_MATRIX Procedure Parameters**

Parameter	Description
accuracy	Output parameter containing the overall percentage accuracy of the predictions.
apply_result_table_name	Table containing the predictions.
target_table_name	Table containing the known target values from the test data.
case_id_column_name	Case ID column in the apply results table. Must match the case identifier in the targets table.
target_column_name	Target column in the targets table. Contains the known target values from the test data.
confusion_matrix_table_name	Table containing the confusion matrix. The table will be created by the procedure in the user's schema. The columns in the confusion matrix table are described in the Usage Notes.
score_column_name	Column containing the predictions in the apply results table. The default column name is <code>PREDICTION</code> , which is the default name created by the <code>APPLY</code> procedure (See " <a href="#">APPLY Procedure</a> ").
score_criterion_column_name	Column containing the scoring criterion in the apply results table. Contains either the probabilities or the costs that determine the predictions. By default, scoring is based on probability; the class with the highest probability is predicted for each case. If scoring is based on cost, the class with the lowest cost is predicted. The <code>score_criterion_type</code> parameter indicates whether probabilities or costs will be used for scoring. The default column name is <code>'PROBABILITY'</code> , which is the default name created by the <code>APPLY</code> procedure (See " <a href="#">APPLY Procedure</a> "). See the Usage Notes for additional information.
cost_matrix_table_name	(Optional) Table that defines the costs associated with misclassifications. If a cost matrix table is provided and the <code>score_criterion_type</code> parameter is set to <code>'COSTS'</code> , the costs in this table will be used as the scoring criteria. The columns in a cost matrix table are described in the Usage Notes.
apply_result_schema_name	Schema of the apply results table. If null, the user's schema is assumed.

**Table 36-46 (Cont.) COMPUTE\_CONFUSION\_MATRIX Procedure Parameters**

Parameter	Description
target_schema_name	Schema of the table containing the known targets. If null, the user's schema is assumed.
cost_matrix_schema_name	Schema of the cost matrix table, if one is provided. If null, the user's schema is assumed.
score_criterion_type	Whether to use probabilities or costs as the scoring criterion. Probabilities or costs are passed in the column identified in the <code>score_criterion_column_name</code> parameter. The default value of <code>score_criterion_type</code> is 'PROBABILITY'. To use costs as the scoring criterion, specify 'COST'. If <code>score_criterion_type</code> is set to 'COST' but no cost matrix is provided and if there is a scoring cost matrix associated with the model, then the associated costs are used for scoring. See the Usage Notes and the Examples.

**Usage Notes**

- The predictive information you pass to `COMPUTE_CONFUSION_MATRIX` may be generated using SQL `PREDICTION` functions, the `DBMS_DATA_MINING.APPLY` procedure, or some other mechanism. As long as you pass the appropriate data, the procedure can compute the confusion matrix.
- Instead of passing a cost matrix to `COMPUTE_CONFUSION_MATRIX`, you can use a scoring cost matrix associated with the model. A scoring cost matrix can be embedded in the model or it can be defined dynamically when the model is applied. To use a scoring cost matrix, invoke the SQL `PREDICTION_COST` function to populate the score criterion column.
- The predictions that you pass to `COMPUTE_CONFUSION_MATRIX` are in a table or view specified in `apply_result_table_name`.

```
CREATE TABLE apply_result_table_name AS (
    case_id_column_name          VARCHAR2,
    score_column_name           VARCHAR2,
    score_criterion_column_name VARCHAR2);
```

- A cost matrix must have the columns described in [Table 36-47](#).

**Table 36-47 Columns in a Cost Matrix**

Column Name	Datatype
actual_target_value	Type of the target column in the build data
predicted_target_value	Type of the predicted target in the test data. The type of the predicted target must be the same as the type of the actual target unless the predicted target has an associated reverse transformation.
cost	BINARY_DOUBLE

 **See Also:**

*Oracle Data Mining User's Guide* for valid target datatypes

*Oracle Data Mining Concepts* for more information about cost matrixes

- The confusion matrix created by `COMPUTE_CONFUSION_MATRIX` has the columns described in [Table 36-48](#).

**Table 36-48 Columns in a Confusion Matrix**

Column Name	Datatype
<code>actual_target_value</code>	Type of the target column in the build data
<code>predicted_target_value</code>	Type of the predicted target in the test data. The type of the predicted target is the same as the type of the actual target unless the predicted target has an associated reverse transformation.
<code>value</code>	<code>BINARY_DOUBLE</code>

 **See Also:**

*Oracle Data Mining Concepts* for more information about confusion matrixes

**Examples**

These examples use the Naive Bayes model `nb_sh_clas_sample`, which is created by one of the Oracle Data Mining sample programs.

**Compute a Confusion Matrix Based on Probabilities**

The following statement applies the model to the test data and stores the predictions and probabilities in a table.

```
CREATE TABLE nb_apply_results AS
  SELECT cust_id,
         PREDICTION(nb_sh_clas_sample USING *) prediction,
         PREDICTION_PROBABILITY(nb_sh_clas_sample USING *) probability
  FROM mining_data_test_v;
```

Using probabilities as the scoring criterion, you can compute the confusion matrix as follows.

```
DECLARE
  v_accuracy NUMBER;
BEGIN
  DBMS_DATA_MINING.COMPUTE_CONFUSION_MATRIX (
    accuracy                => v_accuracy,
    apply_result_table_name => 'nb_apply_results',
    target_table_name       => 'mining_data_test_v',
    case_id_column_name     => 'cust_id',
    target_column_name      => 'affinity_card',
    confusion_matrix_table_name => 'nb_confusion_matrix',
    score_column_name       => 'PREDICTION',
    score_criterion_column_name => 'PROBABILITY',
    cost_matrix_table_name  => null,
    apply_result_schema_name => null,
```

```

        target_schema_name      => null,
        cost_matrix_schema_name => null,
        score_criterion_type    => 'PROBABILITY';
    DBMS_OUTPUT.PUT_LINE('**** MODEL ACCURACY ****: ' || ROUND(v_accuracy,4));
END;
/

```

The confusion matrix and model accuracy are shown as follows.

```
**** MODEL ACCURACY ****: .7847
```

```
SQL>SELECT * from nb_confusion_matrix;
ACTUAL_TARGET_VALUE PREDICTED_TARGET_VALUE      VALUE
-----
                1                0                60
                0                0               891
                1                1               286
                0                1               263

```

### Compute a Confusion Matrix Based on a Cost Matrix Table

The confusion matrix in the previous example shows a high rate of false positives. For 263 cases, the model predicted 1 when the actual value was 0. You could use a cost matrix to minimize this type of error.

The cost matrix table `nb_cost_matrix` specifies that a false positive is 3 times more costly than a false negative.

```
SQL> SELECT * from nb_cost_matrix;
ACTUAL_TARGET_VALUE PREDICTED_TARGET_VALUE      COST
-----
                0                0                0
                0                1                .75
                1                0                .25
                1                1                0

```

This statement shows how to generate the predictions using `APPLY`.

```

BEGIN
    DBMS_DATA_MINING.APPLY(
        model_name      => 'nb_sh_clas_sample',
        data_table_name => 'mining_data_test_v',
        case_id_column_name => 'cust_id',
        result_table_name => 'nb_apply_results');
END;
/

```

This statement computes the confusion matrix using the cost matrix table. The score criterion column is named 'PROBABILITY', which is the name generated by `APPLY`.

```

DECLARE
    v_accuracy    NUMBER;
BEGIN
    DBMS_DATA_MINING.COMPUTE_CONFUSION_MATRIX (
        accuracy                => v_accuracy,
        apply_result_table_name => 'nb_apply_results',
        target_table_name       => 'mining_data_test_v',
        case_id_column_name     => 'cust_id',
        target_column_name      => 'affinity_card',
        confusion_matrix_table_name => 'nb_confusion_matrix',
        score_column_name       => 'PREDICTION',
        score_criterion_column_name => 'PROBABILITY',
        cost_matrix_table_name  => 'nb_cost_matrix',

```

```

        apply_result_schema_name => null,
        target_schema_name      => null,
        cost_matrix_schema_name => null,
        score_criterion_type     => 'COST');
    DBMS_OUTPUT.PUT_LINE('**** MODEL ACCURACY ****: ' || ROUND(v_accuracy,4));
END;
/

```

The resulting confusion matrix shows a decrease in false positives (212 instead of 263).

```
**** MODEL ACCURACY ****: .798
```

```
SQL> SELECT * FROM nb_confusion_matrix;
ACTUAL_TARGET_VALUE PREDICTED_TARGET_VALUE      VALUE
-----
                1                0            91
                0                0           942
                1                1           255
                0                1           212
```

### Compute a Confusion Matrix Based on Embedded Costs

You can use the `ADD_COST_MATRIX` procedure to embed a cost matrix in a model. The embedded costs can be used instead of probabilities for scoring. This statement adds the previously-defined cost matrix to the model.

```
BEGIN    DBMS_DATA_MINING.ADD_COST_MATRIX ('nb_sh_clas_sample', 'nb_cost_matrix');END;/
```

The following statement applies the model to the test data using the embedded costs and stores the results in a table.

```
CREATE TABLE nb_apply_results AS
    SELECT cust_id,
           PREDICTION(nb_sh_clas_sample COST MODEL USING *) prediction,
           PREDICTION_COST(nb_sh_clas_sample COST MODEL USING *) cost
    FROM mining_data_test_v;
```

You can compute the confusion matrix using the embedded costs.

```
DECLARE
    v_accuracy          NUMBER;
BEGIN
    DBMS_DATA_MINING.COMPUTE_CONFUSION_MATRIX (
        accuracy                => v_accuracy,
        apply_result_table_name => 'nb_apply_results',
        target_table_name       => 'mining_data_test_v',
        case_id_column_name     => 'cust_id',
        target_column_name      => 'affinity_card',
        confusion_matrix_table_name => 'nb_confusion_matrix',
        score_column_name       => 'PREDICTION',
        score_criterion_column_name => 'COST',
        cost_matrix_table_name   => null,
        apply_result_schema_name => null,
        target_schema_name      => null,
        cost_matrix_schema_name => null,
        score_criterion_type    => 'COST');
END;
/

```

The results are:

```
**** MODEL ACCURACY ****: .798
```



```
SQL> SELECT * FROM nb_confusion_matrix;
ACTUAL_TARGET_VALUE PREDICTED_TARGET_VALUE      VALUE
-----
                1                0            91
                0                0           942
                1                1           255
                0                1           212
```

### 36.1.5.6 COMPUTE\_CONFUSION\_MATRIX\_PART Procedure

The `COMPUTE_CONFUSION_MATRIX_PART` procedure computes a confusion matrix, stores it in a table in the user's schema, and returns the model accuracy.

`COMPUTE_CONFUSION_MATRIX_PART` provides support to computation of evaluation metrics per-partition for partitioned models. For non-partitioned models, refer to [COMPUTE\\_CONFUSION\\_MATRIX Procedure](#).

A confusion matrix is a test metric for Classification models. It compares the predictions generated by the model with the actual target values in a set of test data. The confusion matrix lists the number of times each class was correctly predicted and the number of times it was predicted to be one of the other classes.

`COMPUTE_CONFUSION_MATRIX_PART` accepts three input streams:

- The predictions generated on the test data. The information is passed in three columns:
  - Case ID column
  - Prediction column
  - Scoring criterion column containing either probabilities or costs
- The known target values in the test data. The information is passed in two columns:
  - Case ID column
  - Target column containing the known target values
- (Optional) A cost matrix table with predefined columns. See the Usage Notes for the column requirements.



#### See Also:

*Oracle Data Mining Concepts* for more details about confusion matrixes and other test metrics for classification

["COMPUTE\\_LIFT\\_PART Procedure"](#)

["COMPUTE\\_ROC\\_PART Procedure"](#)

#### Syntax

```
DBMS_DATA_MINING.compute_confusion_matrix_part(
  accuracy                OUT DM_NESTED_NUMERICALS,
  apply_result_table_name IN  VARCHAR2,
  target_table_name       IN  VARCHAR2,
  case_id_column_name     IN  VARCHAR2,
  target_column_name      IN  VARCHAR2,
  confusion_matrix_table_name IN VARCHAR2,
  score_column_name       IN  VARCHAR2 DEFAULT 'PREDICTION',
```

```

score_criterion_column_name IN VARCHAR2 DEFAULT 'PROBABILITY',
score_partition_column_name IN VARCHAR2 DEFAULT 'PARTITION_NAME',
cost_matrix_table_name     IN VARCHAR2 DEFAULT NULL,
apply_result_schema_name   IN VARCHAR2 DEFAULT NULL,
target_schema_name        IN VARCHAR2 DEFAULT NULL,
cost_matrix_schema_name    IN VARCHAR2 DEFAULT NULL,
score_criterion_type       IN VARCHAR2 DEFAULT NULL);

```

## Parameters

**Table 36-49 COMPUTE\_CONFUSION\_MATRIX\_PART Procedure Parameters**

Parameter	Description
accuracy	Output parameter containing the overall percentage accuracy of the predictions  The output argument is changed from NUMBER to DM_NESTED_NUMERICALS
apply_result_table_name	Table containing the predictions
target_table_name	Table containing the known target values from the test data
case_id_column_name	Case ID column in the apply results table. Must match the case identifier in the targets table.
target_column_name	Target column in the targets table. Contains the known target values from the test data.
confusion_matrix_table_name	Table containing the confusion matrix. The table will be created by the procedure in the user's schema.  The columns in the confusion matrix table are described in the Usage Notes.
score_column_name	Column containing the predictions in the apply results table.  The default column name is PREDICTION, which is the default name created by the APPLY procedure (See " <a href="#">APPLY Procedure</a> ").
score_criterion_column_name	Column containing the scoring criterion in the apply results table. Contains either the probabilities or the costs that determine the predictions.  By default, scoring is based on probability; the class with the highest probability is predicted for each case. If scoring is based on cost, then the class with the lowest cost is predicted.  The score_criterion_type parameter indicates whether probabilities or costs will be used for scoring.  The default column name is PROBABILITY, which is the default name created by the APPLY procedure (See " <a href="#">APPLY Procedure</a> ").  See the Usage Notes for additional information.
score_partition_column_name	(Optional) Parameter indicating the column which contains the name of the partition. This column slices the input test results such that each partition has independent evaluation matrices computed.

**Table 36-49 (Cont.) COMPUTE\_CONFUSION\_MATRIX\_PART Procedure Parameters**

Parameter	Description
<code>cost_matrix_table_name</code>	(Optional) Table that defines the costs associated with misclassifications. If a cost matrix table is provided and the <code>score_criterion_type</code> parameter is set to <code>COSTS</code> , the costs in this table will be used as the scoring criteria. The columns in a cost matrix table are described in the Usage Notes.
<code>apply_result_schema_name</code>	Schema of the apply results table. If null, then the user's schema is assumed.
<code>target_schema_name</code>	Schema of the table containing the known targets. If null, then the user's schema is assumed.
<code>cost_matrix_schema_name</code>	Schema of the cost matrix table, if one is provided. If null, then the user's schema is assumed.
<code>score_criterion_type</code>	Whether to use probabilities or costs as the scoring criterion. Probabilities or costs are passed in the column identified in the <code>score_criterion_column_name</code> parameter. The default value of <code>score_criterion_type</code> is <code>PROBABILITY</code> . To use costs as the scoring criterion, specify <code>COST</code> .  If <code>score_criterion_type</code> is set to <code>COST</code> but no cost matrix is provided and if there is a scoring cost matrix associated with the model, then the associated costs are used for scoring.  See the Usage Notes and the Examples.

### Usage Notes

- The predictive information you pass to `COMPUTE_CONFUSION_MATRIX_PART` may be generated using SQL `PREDICTION` functions, the `DBMS_DATA_MINING.APPLY` procedure, or some other mechanism. As long as you pass the appropriate data, the procedure can compute the confusion matrix.
- Instead of passing a cost matrix to `COMPUTE_CONFUSION_MATRIX_PART`, you can use a scoring cost matrix associated with the model. A scoring cost matrix can be embedded in the model or it can be defined dynamically when the model is applied. To use a scoring cost matrix, invoke the `SQL_PREDICTION_COST` function to populate the score criterion column.
- The predictions that you pass to `COMPUTE_CONFUSION_MATRIX_PART` are in a table or view specified in `apply_result_table_name`.

```
CREATE TABLE apply_result_table_name AS (
    case_id_column_name          VARCHAR2,
    score_column_name            VARCHAR2,
    score_criterion_column_name  VARCHAR2);
```

- A cost matrix must have the columns described in [Table 36-47](#).

**Table 36-50 Columns in a Cost Matrix**

Column Name	Datatype
actual_target_value	Type of the target column in the test data
predicted_target_value	Type of the predicted target in the test data. The type of the predicted target must be the same as the type of the actual target unless the predicted target has an associated reverse transformation.
cost	BINARY_DOUBLE

 **See Also:**

*Oracle Data Mining User's Guide* for valid target datatypes

*Oracle Data Mining Concepts* for more information about cost matrixes

- The confusion matrix created by `COMPUTE_CONFUSION_MATRIX_PART` has the columns described in [Table 36-48](#).

**Table 36-51 Columns in a Confusion Matrix Part**

Column Name	Datatype
actual_target_value	Type of the target column in the test data
predicted_target_value	Type of the predicted target in the test data. The type of the predicted target is the same as the type of the actual target unless the predicted target has an associated reverse transformation.
value	BINARY_DOUBLE

 **See Also:**

*Oracle Data Mining Concepts* for more information about confusion matrixes

**Examples**

These examples use the Naive Bayes model `nb_sh_clas_sample`, which is created by one of the Oracle Data Mining sample programs.

**Compute a Confusion Matrix Based on Probabilities**

The following statement applies the model to the test data and stores the predictions and probabilities in a table.

```
CREATE TABLE nb_apply_results AS
  SELECT cust_id,
         PREDICTION(nb_sh_clas_sample USING *) prediction,
         PREDICTION_PROBABILITY(nb_sh_clas_sample USING *) probability
  FROM mining_data_test_v;
```

Using probabilities as the scoring criterion, you can compute the confusion matrix as follows.

```
DECLARE
  v_accuracy NUMBER;
```

```

BEGIN
  DBMS_DATA_MINING.COMPUTE_CONFUSION_MATRIX_PART (
    accuracy => v_accuracy,
    apply_result_table_name => 'nb_apply_results',
    target_table_name => 'mining_data_test_v',
    case_id_column_name => 'cust_id',
    target_column_name => 'affinity_card',
    confusion_matrix_table_name => 'nb_confusion_matrix',
    score_column_name => 'PREDICTION',
    score_criterion_column_name => 'PROBABILITY'
    score_partition_column_name => 'PARTITION_NAME'
    cost_matrix_table_name => null,
    apply_result_schema_name => null,
    target_schema_name => null,
    cost_matrix_schema_name => null,
    score_criterion_type => 'PROBABILITY');
  DBMS_OUTPUT.PUT_LINE('**** MODEL ACCURACY ****: ' || ROUND(v_accuracy,4));
END;
/

```

The confusion matrix and model accuracy are shown as follows.

```
**** MODEL ACCURACY ****: .7847
```

```

SELECT * FROM NB_CONFUSION_MATRIX;
ACTUAL_TARGET_VALUE PREDICTED_TARGET_VALUE      VALUE
-----
                1                0                60
                0                0               891
                1                1               286
                0                1               263

```

### Compute a Confusion Matrix Based on a Cost Matrix Table

The confusion matrix in the previous example shows a high rate of false positives. For 263 cases, the model predicted 1 when the actual value was 0. You could use a cost matrix to minimize this type of error.

The cost matrix table `nb_cost_matrix` specifies that a false positive is 3 times more costly than a false negative.

```

SELECT * from NB_COST_MATRIX;
ACTUAL_TARGET_VALUE PREDICTED_TARGET_VALUE      COST
-----
                0                0                0
                0                1               .75
                1                0               .25
                1                1                0

```

This statement shows how to generate the predictions using `APPLY`.

```

BEGIN
  DBMS_DATA_MINING.APPLY(
    model_name => 'nb_sh_clas_sample',
    data_table_name => 'mining_data_test_v',
    case_id_column_name => 'cust_id',
    result_table_name => 'nb_apply_results');
END;
/

```

This statement computes the confusion matrix using the cost matrix table. The score criterion column is named 'PROBABILITY', which is the name generated by `APPLY`.

```

DECLARE
  v_accuracy    NUMBER;
BEGIN
  DBMS_DATA_MINING.COMPUTE_CONFUSION_MATRIX_PART (
    accuracy          => v_accuracy,
    apply_result_table_name => 'nb_apply_results',
    target_table_name   => 'mining_data_test_v',
    case_id_column_name => 'cust_id',
    target_column_name  => 'affinity_card',
    confusion_matrix_table_name => 'nb_confusion_matrix',
    score_column_name   => 'PREDICTION',
    score_criterion_column_name => 'PROBABILITY',
    score_partition_column_name => 'PARTITION_NAME',
    cost_matrix_table_name => 'nb_cost_matrix',
    apply_result_schema_name => null,
    target_schema_name   => null,
    cost_matrix_schema_name => null,
    score_criterion_type => 'COST');
  DBMS_OUTPUT.PUT_LINE('**** MODEL ACCURACY ****: ' || ROUND(v_accuracy,4));
END;
/

```

The resulting confusion matrix shows a decrease in false positives (212 instead of 263).

```
**** MODEL ACCURACY ****: .798
```

```

SELECT * FROM NB_CONFUSION_MATRIX;
ACTUAL_TARGET_VALUE PREDICTED_TARGET_VALUE      VALUE
-----
                1                0                91
                0                0                942
                1                1                255
                0                1                212

```

### Compute a Confusion Matrix Based on Embedded Costs

You can use the `ADD_COST_MATRIX` procedure to embed a cost matrix in a model. The embedded costs can be used instead of probabilities for scoring. This statement adds the previously-defined cost matrix to the model.

```

BEGIN
DBMS_DATA_MINING.ADD_COST_MATRIX ('nb_sh_clas_sample', 'nb_cost_matrix');
END;/

```

The following statement applies the model to the test data using the embedded costs and stores the results in a table.

```

CREATE TABLE nb_apply_results AS
  SELECT cust_id,
         PREDICTION(nb_sh_clas_sample COST MODEL USING *) prediction,
         PREDICTION_COST(nb_sh_clas_sample COST MODEL USING *) cost
  FROM mining_data_test_v;

```

You can compute the confusion matrix using the embedded costs.

```

DECLARE
  v_accuracy    NUMBER;
BEGIN
  DBMS_DATA_MINING.COMPUTE_CONFUSION_MATRIX_PART (
    accuracy          => v_accuracy,
    apply_result_table_name => 'nb_apply_results',
    target_table_name   => 'mining_data_test_v',
    case_id_column_name => 'cust_id',

```

```

target_column_name          => 'affinity_card',
confusion_matrix_table_name => 'nb_confusion_matrix',
score_column_name           => 'PREDICTION',
score_criterion_column_name => 'COST',
score_partition_column_name => 'PARTITION_NAME'
cost_matrix_table_name      => null,
apply_result_schema_name    => null,
target_schema_name          => null,
cost_matrix_schema_name     => null,
score_criterion_type        => 'COST');

END;
/

```

The results are:

```
**** MODEL ACCURACY ****: .798
```

```

SELECT * FROM NB_CONFUSION_MATRIX;
ACTUAL_TARGET_VALUE PREDICTED_TARGET_VALUE      VALUE
-----
                1                0                91
                0                0               942
                1                1               255
                0                1               212

```

### 36.1.5.7 COMPUTE\_LIFT Procedure

This procedure computes lift and stores the results in a table in the user's schema.

Lift is a test metric for binary classification models. To compute lift, one of the target values must be designated as the positive class. `COMPUTE_LIFT` compares the predictions generated by the model with the actual target values in a set of test data. Lift measures the degree to which the model's predictions of the positive class are an improvement over random chance.

Lift is computed on scoring results that have been ranked by probability (or cost) and divided into quantiles. Each quantile includes the scores for the same number of cases.

`COMPUTE_LIFT` calculates quantile-based and cumulative statistics. The number of quantiles and the positive class are user-specified. Additionally, `COMPUTE_LIFT` accepts three input streams:

- The predictions generated on the test data. The information is passed in three columns:
  - Case ID column
  - Prediction column
  - Scoring criterion column containing either probabilities or costs associated with the predictions
- The known target values in the test data. The information is passed in two columns:
  - Case ID column
  - Target column containing the known target values
- (Optional) A cost matrix table with predefined columns. See the Usage Notes for the column requirements.

 **See Also:**

*Oracle Data Mining Concepts* for more details about lift and test metrics for classification

["COMPUTE\\_CONFUSION\\_MATRIX Procedure"](#)

["COMPUTE\\_ROC Procedure"](#)

**Syntax**

```
DBMS_DATA_MINING.COMPUTE_LIFT (
  apply_result_table_name      IN VARCHAR2,
  target_table_name           IN VARCHAR2,
  case_id_column_name         IN VARCHAR2,
  target_column_name          IN VARCHAR2,
  lift_table_name             IN VARCHAR2,
  positive_target_value       IN VARCHAR2,
  score_column_name           IN VARCHAR2 DEFAULT 'PREDICTION',
  score_criterion_column_name IN VARCHAR2 DEFAULT 'PROBABILITY',
  num_quantiles               IN NUMBER DEFAULT 10,
  cost_matrix_table_name      IN VARCHAR2 DEFAULT NULL,
  apply_result_schema_name    IN VARCHAR2 DEFAULT NULL,
  target_schema_name          IN VARCHAR2 DEFAULT NULL,
  cost_matrix_schema_name     IN VARCHAR2 DEFAULT NULL,
  score_criterion_type        IN VARCHAR2 DEFAULT 'PROBABILITY');
```

**Parameters****Table 36-52 COMPUTE\_LIFT Procedure Parameters**

Parameter	Description
<code>apply_result_table_name</code>	Table containing the predictions.
<code>target_table_name</code>	Table containing the known target values from the test data.
<code>case_id_column_name</code>	Case ID column in the apply results table. Must match the case identifier in the targets table.
<code>target_column_name</code>	Target column in the targets table. Contains the known target values from the test data.
<code>lift_table_name</code>	Table containing the lift statistics. The table will be created by the procedure in the user's schema. The columns in the lift table are described in the Usage Notes.
<code>positive_target_value</code>	The positive class. This should be the class of interest, for which you want to calculate lift. If the target column is a NUMBER, you can use the <code>TO_CHAR()</code> operator to provide the value as a string.
<code>score_column_name</code>	Column containing the predictions in the apply results table. The default column name is 'PREDICTION', which is the default name created by the <code>APPLY</code> procedure (See " <a href="#">APPLY Procedure</a> ").



**Table 36-52 (Cont.) COMPUTE\_LIFT Procedure Parameters**

Parameter	Description
<code>score_criterion_column_name</code>	<p>Column containing the scoring criterion in the apply results table. Contains either the probabilities or the costs that determine the predictions.</p> <p>By default, scoring is based on probability; the class with the highest probability is predicted for each case. If scoring is based on cost, the class with the lowest cost is predicted.</p> <p>The <code>score_criterion_type</code> parameter indicates whether probabilities or costs will be used for scoring.</p> <p>The default column name is 'PROBABILITY', which is the default name created by the <code>APPLY</code> procedure (See "<a href="#">APPLY Procedure</a>").</p> <p>See the Usage Notes for additional information.</p>
<code>num_quantiles</code>	Number of quantiles to be used in calculating lift. The default is 10.
<code>cost_matrix_table_name</code>	<p>(Optional) Table that defines the costs associated with misclassifications. If a cost matrix table is provided and the <code>score_criterion_type</code> parameter is set to 'COST', the costs will be used as the scoring criteria.</p> <p>The columns in a cost matrix table are described in the Usage Notes.</p>
<code>apply_result_schema_name</code>	<p>Schema of the apply results table.</p> <p>If null, the user's schema is assumed.</p>
<code>target_schema_name</code>	<p>Schema of the table containing the known targets.</p> <p>If null, the user's schema is assumed.</p>
<code>cost_matrix_schema_name</code>	<p>Schema of the cost matrix table, if one is provided.</p> <p>If null, the user's schema is assumed.</p>
<code>score_criterion_type</code>	<p>Whether to use probabilities or costs as the scoring criterion. Probabilities or costs are passed in the column identified in the <code>score_criterion_column_name</code> parameter.</p> <p>The default value of <code>score_criterion_type</code> is 'PROBABILITY'. To use costs as the scoring criterion, specify 'COST'.</p> <p>If <code>score_criterion_type</code> is set to 'COST' but no cost matrix is provided and if there is a scoring cost matrix associated with the model, then the associated costs are used for scoring.</p> <p>See the Usage Notes and the Examples.</p>

**Usage Notes**

- The predictive information you pass to `COMPUTE_LIFT` may be generated using SQL `PREDICTION` functions, the `DBMS_DATA_MINING.APPLY` procedure, or some other mechanism. As long as you pass the appropriate data, the procedure can compute the lift.
- Instead of passing a cost matrix to `COMPUTE_LIFT`, you can use a scoring cost matrix associated with the model. A scoring cost matrix can be embedded in the model or it can be defined dynamically when the model is applied. To use a scoring cost matrix, invoke the `SQL_PREDICTION_COST` function to populate the score criterion column.

- The predictions that you pass to `COMPUTE_LIFT` are in a table or view specified in `apply_results_table_name`.

```
CREATE TABLE apply_result_table_name AS (
    case_id_column_name          VARCHAR2,
    score_column_name            VARCHAR2,
    score_criterion_column_name  VARCHAR2);
```

- A cost matrix must have the columns described in [Table 36-53](#).

**Table 36-53 Columns in a Cost Matrix**

Column Name	Datatype
<code>actual_target_value</code>	Type of the target column in the build data
<code>predicted_target_value</code>	Type of the predicted target in the test data. The type of the predicted target must be the same as the type of the actual target unless the predicted target has an associated reverse transformation.
<code>cost</code>	NUMBER

 **See Also:**

*Oracle Data Mining Concepts* for more information about cost matrixes

- The table created by `COMPUTE_LIFT` has the columns described in [Table 36-54](#)

**Table 36-54 Columns in a Lift Table**

Column Name	Datatype
<code>quantile_number</code>	NUMBER
<code>probability_threshold</code>	NUMBER
<code>gain_cumulative</code>	NUMBER
<code>quantile_total_count</code>	NUMBER
<code>quantile_target_count</code>	NUMBER
<code>percent_records_cumulative</code>	NUMBER
<code>lift_cumulative</code>	NUMBER
<code>target_density_cumulative</code>	NUMBER
<code>targets_cumulative</code>	NUMBER
<code>non_targets_cumulative</code>	NUMBER
<code>lift_quantile</code>	NUMBER
<code>target_density</code>	NUMBER

 **See Also:**

*Oracle Data Mining Concepts* for details about the information in the lift table

- When a cost matrix is passed to `COMPUTE_LIFT`, the cost threshold is returned in the `probability_threshold` column of the lift table.

### Examples

This example uses the Naive Bayes model `nb_sh_clas_sample`, which is created by one of the Oracle Data Mining sample programs.

The example illustrates lift based on probabilities. For examples that show computation based on costs, see "[COMPUTE\\_CONFUSION\\_MATRIX Procedure](#)".

The following statement applies the model to the test data and stores the predictions and probabilities in a table.

```
CREATE TABLE nb_apply_results AS
  SELECT cust_id, t.prediction, t.probability
  FROM mining_data_test_v, TABLE(PREDICTION_SET(nb_sh_clas_sample USING *)) t;
```

Using probabilities as the scoring criterion, you can compute lift as follows.

```
BEGIN
  DBMS_DATA_MINING.COMPUTE_LIFT (
    apply_result_table_name      => 'nb_apply_results',
    target_table_name           => 'mining_data_test_v',
    case_id_column_name         => 'cust_id',
    target_column_name          => 'affinity_card',
    lift_table_name              => 'nb_lift',
    positive_target_value       => to_char(1),
    score_column_name           => 'PREDICTION',
    score_criterion_column_name => 'PROBABILITY',
    num_quantiles                => 10,
    cost_matrix_table_name      => null,
    apply_result_schema_name    => null,
    target_schema_name          => null,
    cost_matrix_schema_name     => null,
    score_criterion_type        => 'PROBABILITY');
END;
/
```

This query displays some of the statistics from the resulting lift table.

```
SQL>SELECT quantile_number, probability_threshold, gain_cumulative,
  quantile_total_count
  FROM nb_lift;
```

QUANTILE_NUMBER	PROBABILITY_THRESHOLD	GAIN_CUMULATIVE	QUANTILE_TOTAL_COUNT
1	.989335775	.15034965	55
2	.980534911	.26048951	55
3	.968506098	.374125874	55
4	.958975196	.493006993	55
5	.946705997	.587412587	55
6	.927454174	.66958042	55
7	.904403627	.748251748	55
8	.836482525	.839160839	55
10	.500184953	1	54

### 36.1.5.8 COMPUTE\_LIFT\_PART Procedure

The `COMPUTE_LIFT_PART` procedure computes Lift and stores the results in a table in the user's schema. This procedure provides support to the computation of evaluation metrics per-partition for partitioned models.

Lift is a test metric for binary Classification models. To compute Lift, one of the target values must be designated as the positive class. `COMPUTE_LIFT_PART` compares the predictions generated by the model with the actual target values in a set of test data. Lift measures the degree to which the model's predictions of the positive class are an improvement over random chance.

Lift is computed on scoring results that have been ranked by probability (or cost) and divided into quantiles. Each quantile includes the scores for the same number of cases.

`COMPUTE_LIFT_PART` calculates quantile-based and cumulative statistics. The number of quantiles and the positive class are user-specified. Additionally, `COMPUTE_LIFT_PART` accepts three input streams:

- The predictions generated on the test data. The information is passed in three columns:
  - Case ID column
  - Prediction column
  - Scoring criterion column containing either probabilities or costs associated with the predictions
- The known target values in the test data. The information is passed in two columns:
  - Case ID column
  - Target column containing the known target values
- (Optional) A cost matrix table with predefined columns. See the Usage Notes for the column requirements.

#### See Also:

*Oracle Data Mining Concepts* for more details about Lift and test metrics for classification

["COMPUTE\\_LIFT Procedure"](#)

["COMPUTE\\_CONFUSION\\_MATRIX Procedure"](#)

["COMPUTE\\_CONFUSION\\_MATRIX\\_PART Procedure"](#)

["COMPUTE\\_ROC Procedure"](#)

["COMPUTE\\_ROC\\_PART Procedure"](#)

#### Syntax

```
DBMS_DATA_MINING.COMPUTE_LIFT_PART (  
    apply_result_table_name    IN VARCHAR2,  
    target_table_name          IN VARCHAR2,  
    case_id_column_name        IN VARCHAR2,  
    target_column_name         IN VARCHAR2,
```

```

lift_table_name          IN VARCHAR2,
positive_target_value    IN VARCHAR2,
score_column_name        IN VARCHAR2 DEFAULT 'PREDICTION',
score_criterion_column_name IN VARCHAR2 DEFAULT 'PROBABILITY',
score_partition_column_name IN VARCHAR2 DEFAULT 'PARTITION_NAME',
num_quantiles            IN NUMBER   DEFAULT 10,
cost_matrix_table_name   IN VARCHAR2 DEFAULT NULL,
apply_result_schema_name IN VARCHAR2 DEFAULT NULL,
target_schema_name       IN VARCHAR2 DEFAULT NULL,
cost_matrix_schema_name  IN VARCHAR2 DEFAULT NULL,
score_criterion_type     IN VARCHAR2 DEFAULT NULL);

```

## Parameters

**Table 36-55 COMPUTE\_LIFT\_PART Procedure Parameters**

Parameter	Description
apply_result_table_name	Table containing the predictions
target_table_name	Table containing the known target values from the test data
case_id_column_name	Case ID column in the apply results table. Must match the case identifier in the targets table.
target_column_name	Target column in the targets table. Contains the known target values from the test data.
lift_table_name	Table containing the Lift statistics. The table will be created by the procedure in the user's schema. The columns in the Lift table are described in the Usage Notes.
positive_target_value	The positive class. This should be the class of interest, for which you want to calculate Lift. If the target column is a NUMBER, then you can use the TO_CHAR() operator to provide the value as a string.
score_column_name	Column containing the predictions in the apply results table. The default column name is PREDICTION, which is the default name created by the APPLY procedure (See " <a href="#">APPLY Procedure</a> ").
score_criterion_column_name	Column containing the scoring criterion in the apply results table. Contains either the probabilities or the costs that determine the predictions. By default, scoring is based on probability; the class with the highest probability is predicted for each case. If scoring is based on cost, then the class with the lowest cost is predicted. The score_criterion_type parameter indicates whether probabilities or costs will be used for scoring. The default column name is PROBABILITY, which is the default name created by the APPLY procedure (See " <a href="#">APPLY Procedure</a> "). See the Usage Notes for additional information.
score_partition_column_name	Optional parameter indicating the column containing the name of the partition. This column slices the input test results such that each partition has independent evaluation matrices computed.

**Table 36-55 (Cont.) COMPUTE\_LIFT\_PART Procedure Parameters**

Parameter	Description
num_quantiles	Number of quantiles to be used in calculating Lift. The default is 10.
cost_matrix_table_name	(Optional) Table that defines the costs associated with misclassifications. If a cost matrix table is provided and the <code>score_criterion_type</code> parameter is set to <code>COST</code> , then the costs will be used as the scoring criteria.  The columns in a cost matrix table are described in the Usage Notes.
apply_result_schema_name	Schema of the apply results table If null, then the user's schema is assumed.
target_schema_name	Schema of the table containing the known targets If null, then the user's schema is assumed.
cost_matrix_schema_name	Schema of the cost matrix table, if one is provided If null, then the user's schema is assumed.
score_criterion_type	Whether to use probabilities or costs as the scoring criterion. Probabilities or costs are passed in the column identified in the <code>score_criterion_column_name</code> parameter.  The default value of <code>score_criterion_type</code> is <code>PROBABILITY</code> . To use costs as the scoring criterion, specify <code>COST</code> .  If <code>score_criterion_type</code> is set to <code>COST</code> but no cost matrix is provided and if there is a scoring cost matrix associated with the model, then the associated costs are used for scoring.  See the Usage Notes and the Examples.

**Usage Notes**

- The predictive information you pass to `COMPUTE_LIFT_PART` may be generated using SQL `PREDICTION` functions, the `DBMS_DATA_MINING.APPLY` procedure, or some other mechanism. As long as you pass the appropriate data, the procedure can compute the Lift.
- Instead of passing a cost matrix to `COMPUTE_LIFT_PART`, you can use a scoring cost matrix associated with the model. A scoring cost matrix can be embedded in the model or it can be defined dynamically when the model is applied. To use a scoring cost matrix, invoke the `SQL_PREDICTION_COST` function to populate the score criterion column.
- The predictions that you pass to `COMPUTE_LIFT_PART` are in a table or view specified in `apply_results_table_name`.

```
CREATE TABLE apply_result_table_name AS (
    case_id_column_name          VARCHAR2,
    score_column_name            VARCHAR2,
    score_criterion_column_name  VARCHAR2);
```

- A cost matrix must have the columns described in [Table 36-53](#).

**Table 36-56 Columns in a Cost Matrix**

Column Name	Datatype
actual_target_value	Type of the target column in the test data
predicted_target_value	Type of the predicted target in the test data. The type of the predicted target must be the same as the type of the actual target unless the predicted target has an associated reverse transformation.
cost	NUMBER

 **See Also:**

*Oracle Data Mining Concepts* for more information about cost matrixes

- The table created by `COMPUTE_LIFT_PART` has the columns described in [Table 36-54](#)

**Table 36-57 Columns in a COMPUTE\_LIFT\_PART Table**

Column Name	Datatype
quantile_number	NUMBER
probability_threshold	NUMBER
gain_cumulative	NUMBER
quantile_total_count	NUMBER
quantile_target_count	NUMBER
percent_records_cumulative	NUMBER
lift_cumulative	NUMBER
target_density_cumulative	NUMBER
targets_cumulative	NUMBER
non_targets_cumulative	NUMBER
lift_quantile	NUMBER
target_density	NUMBER

 **See Also:**

*Oracle Data Mining Concepts* for details about the information in the Lift table

- When a cost matrix is passed to `COMPUTE_LIFT_PART`, the cost threshold is returned in the `probability_threshold` column of the Lift table.

**Examples**

This example uses the Naive Bayes model `nb_sh_clas_sample`, which is created by one of the Oracle Data Mining sample programs.

The example illustrates Lift based on probabilities. For examples that show computation based on costs, see "[COMPUTE\\_CONFUSION\\_MATRIX Procedure](#)".

For a partitioned model example, see "[COMPUTE\\_CONFUSION\\_MATRIX\\_PART Procedure](#)".

The following statement applies the model to the test data and stores the predictions and probabilities in a table.

```
CREATE TABLE nb_apply_results AS
  SELECT cust_id, t.prediction, t.probability
  FROM mining_data_test_v, TABLE(PREDICTION_SET(nb_sh_clas_sample USING *)) t;
```

Using probabilities as the scoring criterion, you can compute Lift as follows.

```
BEGIN
  DBMS_DATA_MINING.COMPUTE_LIFT_PART (
    apply_result_table_name => 'nb_apply_results',
    target_table_name      => 'mining_data_test_v',
    case_id_column_name    => 'cust_id',
    target_column_name     => 'affinity_card',
    lift_table_name        => 'nb_lift',
    positive_target_value  => to_char(1),
    score_column_name      => 'PREDICTION',
    score_criterion_column_name => 'PROBABILITY',
    score_partition_column_name => 'PARTITION_NAME',
    num_quantiles          => 10,
    cost_matrix_table_name => null,
    apply_result_schema_name => null,
    target_schema_name     => null,
    cost_matrix_schema_name => null,
    score_criterion_type   => 'PROBABILITY');
END;
/
```

This query displays some of the statistics from the resulting Lift table.

```
SELECT quantile_number, probability_threshold, gain_cumulative,
       quantile_total_count
  FROM nb_lift;
```

QUANTILE_NUMBER	PROBABILITY_THRESHOLD	GAIN_CUMULATIVE	QUANTILE_TOTAL_COUNT
1	.989335775	.15034965	55
2	.980534911	.26048951	55
3	.968506098	.374125874	55
4	.958975196	.493006993	55
5	.946705997	.587412587	55
6	.927454174	.66958042	55
7	.904403627	.748251748	55
8	.836482525	.839160839	55
10	.500184953	1	54

### 36.1.5.9 COMPUTE\_ROC Procedure

This procedure computes the receiver operating characteristic (ROC), stores the results in a table in the user's schema, and returns a measure of the model accuracy.

ROC is a test metric for binary classification models. To compute ROC, one of the target values must be designated as the positive class. `COMPUTE_ROC` compares the predictions generated by the model with the actual target values in a set of test data.



ROC measures the impact of changes in the probability threshold. The probability threshold is the decision point used by the model for predictions. In binary classification, the default probability threshold is 0.5. The value predicted for each case is the one with a probability greater than 50%.

ROC can be plotted as a curve on an X-Y axis. The false positive rate is placed on the X axis. The true positive rate is placed on the Y axis. A false positive is a positive prediction for a case that is negative in the test data. A true positive is a positive prediction for a case that is positive in the test data.

COMPUTE\_ROC accepts two input streams:

- The predictions generated on the test data. The information is passed in three columns:
  - Case ID column
  - Prediction column
  - Scoring criterion column containing probabilities
- The known target values in the test data. The information is passed in two columns:
  - Case ID column
  - Target column containing the known target values

#### See Also:

*Oracle Data Mining Concepts* for more details about ROC and test metrics for classification

["COMPUTE\\_CONFUSION\\_MATRIX Procedure"](#)

["COMPUTE\\_LIFT Procedure"](#)

## Syntax

```
DBMS_DATA_MINING.COMPUTE_ROC (
    roc_area_under_curve          OUT NUMBER,
    apply_result_table_name      IN  VARCHAR2,
    target_table_name            IN  VARCHAR2,
    case_id_column_name          IN  VARCHAR2,
    target_column_name           IN  VARCHAR2,
    roc_table_name               IN  VARCHAR2,
    positive_target_value        IN  VARCHAR2,
    score_column_name            IN  VARCHAR2 DEFAULT 'PREDICTION',
    score_criterion_column_name  IN  VARCHAR2 DEFAULT 'PROBABILITY',
    apply_result_schema_name     IN  VARCHAR2 DEFAULT NULL,
    target_schema_name           IN  VARCHAR2 DEFAULT NULL);
```

## Parameters

**Table 36-58 COMPUTE\_ROC Procedure Parameters**

Parameter	Description
<code>roc_area_under_the_curve</code>	Output parameter containing the area under the ROC curve (AUC). The AUC measures the likelihood that an actual positive will be predicted as positive.  The greater the AUC, the greater the flexibility of the model in accommodating trade-offs between positive and negative class predictions. AUC can be especially important when one target class is rarer or more important to identify than another.
<code>apply_result_table_name</code>	Table containing the predictions.
<code>target_table_name</code>	Table containing the known target values from the test data.
<code>case_id_column_name</code>	Case ID column in the apply results table. Must match the case identifier in the targets table.
<code>target_column_name</code>	Target column in the targets table. Contains the known target values from the test data.
<code>roc_table_name</code>	Table containing the ROC output. The table will be created by the procedure in the user's schema.  The columns in the ROC table are described in the Usage Notes.
<code>positive_target_value</code>	The positive class. This should be the class of interest, for which you want to calculate ROC.  If the target column is a <code>NUMBER</code> , you can use the <code>TO_CHAR()</code> operator to provide the value as a string.
<code>score_column_name</code>	Column containing the predictions in the apply results table. The default column name is 'PREDICTION', which is the default name created by the <code>APPLY</code> procedure (See " <a href="#">APPLY Procedure</a> ").
<code>score_criterion_column_name</code>	Column containing the scoring criterion in the apply results table. Contains the probabilities that determine the predictions.  The default column name is 'PROBABILITY', which is the default name created by the <code>APPLY</code> procedure (See " <a href="#">APPLY Procedure</a> ").
<code>apply_result_schema_name</code>	Schema of the apply results table.  If null, the user's schema is assumed.
<code>target_schema_name</code>	Schema of the table containing the known targets.  If null, the user's schema is assumed.

## Usage Notes

- The predictive information you pass to `COMPUTE_ROC` may be generated using SQL `PREDICTION` functions, the `DBMS_DATA_MINING.APPLY` procedure, or some other mechanism. As long as you pass the appropriate data, the procedure can compute the receiver operating characteristic.
- The predictions that you pass to `COMPUTE_ROC` are in a table or view specified in `apply_results_table_name`.

```
CREATE TABLE apply_result_table_name AS (
    case_id_column_name          VARCHAR2,
    score_column_name            VARCHAR2,
    score_criterion_column_name  VARCHAR2);
```

- The table created by COMPUTE\_ROC has the columns shown in [Table 36-59](#).

**Table 36-59 COMPUTE\_ROC Output**

Column	Datatype
probability	BINARY_DOUBLE
true_positives	NUMBER
false_negatives	NUMBER
false_positives	NUMBER
true_negatives	NUMBER
true_positive_fraction	NUMBER
false_positive_fraction	NUMBER

 **See Also:**

*Oracle Data Mining Concepts* for details about the output of COMPUTE\_ROC

- ROC is typically used to determine the most desirable probability threshold. This can be done by examining the true positive fraction and the false positive fraction. The true positive fraction is the percentage of all positive cases in the test data that were correctly predicted as positive. The false positive fraction is the percentage of all negative cases in the test data that were incorrectly predicted as positive.

Given a probability threshold, the following statement returns the positive predictions in an apply result table ordered by probability.

```
SELECT case_id_column_name
       FROM apply_result_table_name
       WHERE probability > probability_threshold
       ORDER BY probability DESC;
```

- There are two approaches to identifying the most desirable probability threshold. Which approach you use depends on whether or not you know the relative cost of positive versus negative class prediction errors.

If the costs are known, you can apply the relative costs to the ROC table to compute the minimum cost probability threshold. Suppose the relative cost ratio is: Positive Class Error Cost / Negative Class Error Cost = 20. Then execute a query like this.

```
WITH cost AS (
    SELECT probability_threshold, 20 * false_negatives + false_positives cost
    FROM ROC_table
    GROUP BY probability_threshold),
minCost AS (
    SELECT min(cost) minCost
    FROM cost)
SELECT max(probability_threshold) probability_threshold
       FROM cost, minCost
       WHERE cost = minCost;
```

If relative costs are not well known, you can simply scan the values in the ROC table (in sorted order) and make a determination about which of the displayed trade-offs (misclassified positives versus misclassified negatives) is most desirable.

```
SELECT * FROM ROC_table
       ORDER BY probability_threshold;
```

### Examples

This example uses the Naive Bayes model `nb_sh_clas_sample`, which is created by one of the Oracle Data Mining sample programs.

The following statement applies the model to the test data and stores the predictions and probabilities in a table.

```
CREATE TABLE nb_apply_results AS
  SELECT cust_id, t.prediction, t.probability
  FROM mining_data_test_v, TABLE(PREDICTION_SET(nb_sh_clas_sample USING *)) t;
```

Using the predictions and the target values from the test data, you can compute ROC as follows.

```
DECLARE
  v_area_under_curve NUMBER;
BEGIN
  DBMS_DATA_MINING.COMPUTE_ROC (
    roc_area_under_curve      => v_area_under_curve,
    apply_result_table_name   => 'nb_apply_results',
    target_table_name         => 'mining_data_test_v',
    case_id_column_name       => 'cust_id',
    target_column_name        => 'mining_data_test_v',
    roc_table_name            => 'nb_roc',
    positive_target_value     => '1',
    score_column_name         => 'PREDICTION',
    score_criterion_column_name => 'PROBABILITY');
  DBMS_OUTPUT.PUT_LINE('**** AREA UNDER ROC CURVE ****: ' ||
    ROUND(v_area_under_curve,4));
END;
/
```

The resulting AUC and a selection of columns from the ROC table are shown as follows.

```
**** AREA UNDER ROC CURVE ****: .8212

SELECT PROBABILITY, TRUE_POSITIVE_FRACTION, FALSE_POSITIVE_FRACTION
       FROM NB_ROC;
```

PROBABILITY	TRUE_POSITIVE_FRACTION	FALSE_POSITIVE_FRACTION
.00000	1	1
.50018	.826589595	.227902946
.53851	.823699422	.221837088
.54991	.820809249	.217504333
.55628	.815028902	.215771231
.55628	.817919075	.215771231
.57563	.800578035	.214904679
.57563	.812138728	.214904679
.	.	.
.	.	.

### 36.1.5.10 COMPUTE\_ROC\_PART Procedure

The `COMPUTE_ROC_PART` procedure computes Receiver Operating Characteristic (ROC), stores the results in a table in the user's schema, and returns a measure of the model accuracy. This procedure provides support to computation of evaluation metrics per-partition for partitioned models.

ROC is a test metric for binary classification models. To compute ROC, one of the target values must be designated as the positive class. `COMPUTE_ROC_PART` compares the predictions generated by the model with the actual target values in a set of test data.

ROC measures the impact of changes in the probability threshold. The probability threshold is the decision point used by the model for predictions. In binary classification, the default probability threshold is 0.5. The value predicted for each case is the one with a probability greater than 50%.

ROC can be plotted as a curve on an x-y axis. The false positive rate is placed on the x-axis. The true positive rate is placed on the y-axis. A false positive is a positive prediction for a case that is negative in the test data. A true positive is a positive prediction for a case that is positive in the test data.

`COMPUTE_ROC_PART` accepts two input streams:

- The predictions generated on the test data. The information is passed in three columns:
  - Case ID column
  - Prediction column
  - Scoring criterion column containing probabilities
- The known target values in the test data. The information is passed in two columns:
  - Case ID column
  - Target column containing the known target values

#### See Also:

*Oracle Data Mining Concepts* for more details about ROC and test metrics for Classification

["COMPUTE\\_ROC Procedure"](#)

["COMPUTE\\_CONFUSION\\_MATRIX Procedure"](#)

["COMPUTE\\_LIFT\\_PART Procedure"](#)

["COMPUTE\\_LIFT Procedure"](#)

#### Syntax

```
DBMS_DATA_MINING.compute_roc_part(  
    roc_area_under_curve      OUT DM_NESTED_NUMERICALS,  
    apply_result_table_name  IN  VARCHAR2,  
    target_table_name        IN  VARCHAR2,
```

```

case_id_column_name      IN  VARCHAR2,
target_column_name      IN  VARCHAR2,
roc_table_name          IN  VARCHAR2,
positive_target_value   IN  VARCHAR2,
score_column_name       IN  VARCHAR2 DEFAULT 'PREDICTION',
score_criterion_column_name IN VARCHAR2 DEFAULT 'PROBABILITY',
score_partition_column_name IN VARCHAR2 DEFAULT 'PARTITION_NAME',
apply_result_schema_name IN  VARCHAR2 DEFAULT NULL,
target_schema_name      IN  VARCHAR2 DEFAULT NULL);

```

## Parameters

**Table 36-60 COMPUTE\_ROC\_PART Procedure Parameters**

Parameter	Description
roc_area_under_the_curve	Output parameter containing the area under the ROC curve (AUC). The AUC measures the likelihood that an actual positive will be predicted as positive.  The greater the AUC, the greater the flexibility of the model in accommodating trade-offs between positive and negative class predictions. AUC can be especially important when one target class is rarer or more important to identify than another.  The output argument is changed from NUMBER to DM_NESTED_NUMERICALS.
apply_result_table_name	Table containing the predictions.
target_table_name	Table containing the known target values from the test data.
case_id_column_name	Case ID column in the apply results table. Must match the case identifier in the targets table.
target_column_name	Target column in the targets table. Contains the known target values from the test data.
roc_table_name	Table containing the ROC output. The table will be created by the procedure in the user's schema.  The columns in the ROC table are described in the Usage Notes.
positive_target_value	The positive class. This should be the class of interest, for which you want to calculate ROC.  If the target column is a NUMBER, then you can use the TO_CHAR() operator to provide the value as a string.
score_column_name	Column containing the predictions in the apply results table.  The default column name is PREDICTION, which is the default name created by the APPLY procedure (See " <a href="#">APPLY Procedure</a> ").
score_criterion_column_name	Column containing the scoring criterion in the apply results table. Contains the probabilities that determine the predictions.  The default column name is PROBABILITY, which is the default name created by the APPLY procedure (See " <a href="#">APPLY Procedure</a> ").
score_partition_column_name	Optional parameter indicating the column which contains the name of the partition. This column slices the input test results such that each partition has independent evaluation matrices computed.

**Table 36-60 (Cont.) COMPUTE\_ROC\_PART Procedure Parameters**

Parameter	Description
apply_result_schema_name	Schema of the apply results table. If null, then the user's schema is assumed.
target_schema_name	Schema of the table containing the known targets. If null, then the user's schema is assumed.

**Usage Notes**

- The predictive information you pass to `COMPUTE_ROC_PART` may be generated using SQL `PREDICTION` functions, the `DBMS_DATA_MINING.APPLY` procedure, or some other mechanism. As long as you pass the appropriate data, the procedure can compute the receiver operating characteristic.
- The predictions that you pass to `COMPUTE_ROC_PART` are in a table or view specified in `apply_results_table_name`.

```
CREATE TABLE apply_result_table_name AS (
    case_id_column_name          VARCHAR2,
    score_column_name            VARCHAR2,
    score_criterion_column_name VARCHAR2);
```

- The `COMPUTE_ROC_PART` table has the following columns:

**Table 36-61 COMPUTE\_ROC\_PART Output**

Column	Datatype
probability	BINARY_DOUBLE
true_positives	NUMBER
false_negatives	NUMBER
false_positives	NUMBER
true_negatives	NUMBER
true_positive_fraction	NUMBER
false_positive_fraction	NUMBER

 **See Also:**

*Oracle Data Mining Concepts* for details about the output of `COMPUTE_ROC_PART`

- ROC is typically used to determine the most desirable probability threshold. This can be done by examining the true positive fraction and the false positive fraction. The true positive fraction is the percentage of all positive cases in the test data that were correctly predicted as positive. The false positive fraction is the percentage of all negative cases in the test data that were incorrectly predicted as positive.

Given a probability threshold, the following statement returns the positive predictions in an apply result table ordered by probability.

```
SELECT case_id_column_name
       FROM apply_result_table_name
       WHERE probability > probability_threshold
       ORDER BY probability DESC;
```

- There are two approaches to identify the most desirable probability threshold. The approach you use depends on whether you know the relative cost of positive versus negative class prediction errors.

If the costs are known, then you can apply the relative costs to the ROC table to compute the minimum cost probability threshold. Suppose the relative cost ratio is: Positive Class Error Cost / Negative Class Error Cost = 20. Then execute a query as follows:

```
WITH cost AS (
  SELECT probability_threshold, 20 * false_negatives + false_positives cost
  FROM ROC_table
  GROUP BY probability_threshold),
  minCost AS (
  SELECT min(cost) minCost
  FROM cost)
  SELECT max(probability_threshold)probability_threshold
  FROM cost, minCost
  WHERE cost = minCost;
```

If relative costs are not well known, then you can simply scan the values in the ROC table (in sorted order) and make a determination about which of the displayed trade-offs (misclassified positives versus misclassified negatives) is most desirable.

```
SELECT * FROM ROC_table
       ORDER BY probability_threshold;
```

## Examples

This example uses the Naive Bayes model `nb_sh_clas_sample`, which is created by one of the Oracle Data Mining sample programs.

The following statement applies the model to the test data and stores the predictions and probabilities in a table.

```
CREATE TABLE nb_apply_results AS
  SELECT cust_id, t.prediction, t.probability
  FROM mining_data_test_v, TABLE(PREDICTION_SET(nb_sh_clas_sample USING *)) t;
```

Using the predictions and the target values from the test data, you can compute ROC as follows.

```
DECLARE
  v_area_under_curve NUMBER;
BEGIN
  DBMS_DATA_MINING.COMPUTE_ROC_PART (
    roc_area_under_curve      => v_area_under_curve,
    apply_result_table_name   => 'nb_apply_results',
    target_table_name         => 'mining_data_test_v',
    case_id_column_name       => 'cust_id',
    target_column_name        => 'affinity_card',
    roc_table_name            => 'nb_roc',
    positive_target_value     => '1',
    score_column_name         => 'PREDICTION',
    score_criterion_column_name => 'PROBABILITY');
    score_partition_column_name => 'PARTITION_NAME'
```



```

        DBMS_OUTPUT.PUT_LINE('**** AREA UNDER ROC CURVE ****: ' ||
        ROUND(v_area_under_curve,4));
END;
/

```

The resulting AUC and a selection of columns from the ROC table are shown as follows.

```

**** AREA UNDER ROC CURVE ****: .8212

SELECT PROBABILITY, TRUE_POSITIVE_FRACTION, FALSE_POSITIVE_FRACTION
       FROM NB_ROC;

```

PROBABILITY	TRUE_POSITIVE_FRACTION	FALSE_POSITIVE_FRACTION
.00000	1	1
.50018	.826589595	.227902946
.53851	.823699422	.221837088
.54991	.820809249	.217504333
.55628	.815028902	.215771231
.55628	.817919075	.215771231
.57563	.800578035	.214904679
.57563	.812138728	.214904679
.	.	.
.	.	.
.	.	.

### 36.1.5.11 CREATE\_MODEL Procedure

This procedure creates a mining model with a given mining function.

#### Syntax

```

DBMS_DATA_MINING.CREATE_MODEL (
    model_name          IN VARCHAR2,
    mining_function     IN VARCHAR2,
    data_table_name     IN VARCHAR2,
    case_id_column_name IN VARCHAR2,
    target_column_name  IN VARCHAR2 DEFAULT NULL,
    settings_table_name IN VARCHAR2 DEFAULT NULL,
    data_schema_name    IN VARCHAR2 DEFAULT NULL,
    settings_schema_name IN VARCHAR2 DEFAULT NULL,
    xform_list          IN TRANSFORM_LIST DEFAULT NULL);

```

#### Parameters

**Table 36-62 CREATE\_MODEL Procedure Parameters**

Parameter	Description
model_name	Name of the model in the form [ <i>schema_name</i> .] <i>model_name</i> . If you do not specify a schema, then your own schema is used. See the Usage Notes for model naming restrictions.
mining_function	The mining function. Values are listed in <a href="#">Table 36-3</a> .
data_table_name	Table or view containing the build data
case_id_column_name	Case identifier column in the build data.

**Table 36-62 (Cont.) CREATE\_MODEL Procedure Parameters**

Parameter	Description
target_column_name	For supervised models, the target column in the build data. NULL for unsupervised models.
settings_table_name	Table containing build settings for the model. NULL if there is no settings table (only default settings are used).
data_schema_name	Schema hosting the build data. If NULL, then the user's schema is assumed.
settings_schema_name	Schema hosting the settings table. If NULL then the user's schema is assumed.
xform_list	<p>A list of transformations to be used in addition to or instead of automatic transformations, depending on the value of the PREP_AUTO setting. (See <a href="#">"Automatic Data Preparation"</a>.)</p> <p>The datatype of xform_list is TRANSFORM_LIST, which consists of records of type TRANSFORM_REC. Each TRANSFORM_REC specifies the transformation information for a single attribute.</p> <pre> TYPE   TRANSFORM_REC      IS RECORD (     attribute_name    VARCHAR2(4000),     attribute_subname VARCHAR2(4000),     expression        EXPRESSION_REC,     reverse_expression EXPRESSION_REC,     attribute_spec    VARCHAR2(4000)); </pre> <p>The expression field stores a SQL expression for transforming the attribute. The reverse_expression field stores a SQL expression for reversing the transformation in model details and, if the attribute is a target, in the results of scoring. The SQL expressions are manipulated by routines in the DBMS_DATA_MINING_TRANSFORM package:</p> <ul style="list-style-type: none"> <li>• <a href="#">SET_EXPRESSION Procedure</a></li> <li>• <a href="#">GET_EXPRESSION Function</a></li> <li>• <a href="#">SET_TRANSFORM Procedure</a></li> </ul> <p>The attribute_spec field identifies individualized treatment for the attribute. See the Usage Notes for details.</p> <p>See <a href="#">Table 36-114</a> for details about the TRANSFORM_REC type.</p>

### Usage Notes

- You can use the attribute\_spec field of the xform\_list argument to identify an attribute as unstructured text or to disable Automatic Data Preparation for the attribute. The attribute\_spec can have the following values:
  - TEXT: Indicates that the attribute contains unstructured text. The TEXT value may optionally be followed by POLICY\_NAME, TOKEN\_TYPE, MAX\_FEATURES, and MIN\_DOCUMENTS parameters.

TOKEN\_TYPE has the following possible values: NORMAL, STEM, THEME, SYNONYM, BIGRAM, STEM\_BIGRAM. SYNONYM may be optionally followed by a thesaurus name in square brackets.

MAX\_FEATURES specifies the maximum number of tokens extracted from the text.

`MIN_DOCUMENTS` specifies the minimal number of documents in which every selected token shall occur. (For information about creating a text policy, see `CTX_DDL.CREATE_POLICY` in *Oracle Text Reference*).

Oracle Data Mining can process columns of `VARCHAR2/CHAR`, `CLOB`, `BLOB`, and `BFILE` as text. If the column is `VARCHAR2` or `CHAR` and you do not specify `TEXT`, Oracle Data Mining will process the column as categorical data. If the column is `CLOB`, then Oracle Data Mining will process it as text by default (You do not need to specify it as `TEXT`. However, you do need to provide an Oracle Text Policy in the settings). If the column is `BLOB` or `BFILE`, you must specify it as `TEXT`, otherwise `CREATE_MODEL` will return an error.

If you specify `TEXT` for a nested column or for an attribute in a nested column, `CREATE_MODEL` will return an error.

- `NOPREP`: Disables ADP for the attribute. When ADP is `OFF`, the `NOPREP` value is ignored.

You can specify `NOPREP` for a nested column, but not for an attribute in a nested column. If you specify `NOPREP` for an attribute in a nested column when ADP is on, `CREATE_MODEL` will return an error.

2. You can obtain information about a model by querying the Data Dictionary views.

```
ALL/USER/DBA_MINING_MODELS
ALL/USER/DBA_MINING_MODEL_ATTRIBUTES
ALL/USER/DBA_MINING_MODEL_SETTINGS
ALL/USER/DBA_MINING_MODEL_VIEWS
ALL/USER/DBA_MINING_MODEL_PARTITIONS
ALL/USER/DBA_MINING_MODEL_XFORMS
```

You can obtain information about model attributes by querying the model details through model views. Refer to *Oracle Data Mining User's Guide*.

3. The naming rules for models are more restrictive than the naming rules for most database schema objects. A model name must satisfy the following additional requirements:

- It must be 123 or fewer characters long.
- It must be a nonquoted identifier. Oracle requires that nonquoted identifiers contain only alphanumeric characters, the underscore (`_`), dollar sign (`$`), and pound sign (`#`); the initial character must be alphabetic. Oracle strongly discourages the use of the dollar sign and pound sign in nonquoted literals.

Naming requirements for schema objects are fully documented in *Oracle Database SQL Language Reference*.

4. To build a partitioned model, you must provide additional settings.

The setting for partitioning columns are as follows:

```
INSERT INTO settings_table VALUES ('ODMS_PARTITION_COLUMNS', 'GENDER,
AGE');
```

To set user-defined partition number for a model, the setting is as follows:

```
INSERT INTO settings_table VALUES ('ODMS_MAX_PARTITIONS', '10');
```

The default value for maximum number of partitions is 1000.

5. By passing an `xform_list` to `CREATE_MODEL`, you can specify a list of transformations to be performed on the input data. If the `PREP_AUTO` setting is `ON`, the transformations are used in addition to the automatic transformations. If the `PREP_AUTO` setting is `OFF`, the specified

transformations are the only ones implemented by the model. In both cases, transformation definitions are embedded in the model and executed automatically whenever the model is applied. See "[Automatic Data Preparation](#)". Other transforms that can be specified with `xform_list` include `FORCE_IN`. Refer to *Oracle Data Mining User's Guide*.

## Examples

The first example builds a Classification model using the Support Vector Machine algorithm.

```
-- Create the settings table
CREATE TABLE svm_model_settings (
  setting_name VARCHAR2(30),
  setting_value VARCHAR2(30));

-- Populate the settings table
-- Specify SVM. By default, Naive Bayes is used for classification.
-- Specify ADP. By default, ADP is not used.
BEGIN
  INSERT INTO svm_model_settings (setting_name, setting_value) VALUES
    (dbms_data_mining.algo_name, dbms_data_mining.algo_support_vector_machines);
  INSERT INTO svm_model_settings (setting_name, setting_value) VALUES
    (dbms_data_mining.prep_auto, dbms_data_mining.prep_auto_on);
  COMMIT;
END;
/

-- Create the model using the specified settings
BEGIN
  DBMS_DATA_MINING.CREATE_MODEL(
    model_name          => 'svm_model',
    mining_function     => dbms_data_mining.classification,
    data_table_name     => 'mining_data_build_v',
    case_id_column_name => 'cust_id',
    target_column_name  => 'affinity_card',
    settings_table_name => 'svm_model_settings');
END;
/
```

You can display the model settings with the following query:

```
SELECT * FROM user_mining_model_settings
       WHERE model_name IN 'SVM_MODEL';
```

MODEL_NAME	SETTING_NAME	SETTING_VALUE	SETTING
SVM_MODEL	ALGO_NAME	ALGO_SUPPORT_VECTOR_MACHINES	INPUT
SVM_MODEL	SVMS_STD_DEV	3.004524	DEFAULT
SVM_MODEL	PREP_AUTO	ON	INPUT
SVM_MODEL	SVMS_COMPLEXITY_FACTOR	1.887389	DEFAULT
SVM_MODEL	SVMS_KERNEL_FUNCTION	SVMS_LINEAR	DEFAULT
SVM_MODEL	SVMS_CONV_TOLERANCE	.001	DEFAULT

The following is an example of querying a model view instead of the older `GEL_MODEL_DETAILS_SVM` routine.

```
SELECT target_value, attribute_name, attribute_value, coefficient FROM
DM$VLSVM_MODEL;
```

The second example creates an Anomaly Detection model. Anomaly Detection uses SVM Classification without a target. This example uses the same settings table created for the SVM Classification model in the first example.

```
BEGIN
  DBMS_DATA_MINING.CREATE_MODEL(
    model_name          => 'anomaly_detect_model',
    mining_function     => dbms_data_mining.classification,
    data_table_name     => 'mining_data_build_v',
    case_id_column_name => 'cust_id',
    target_column_name  => null,
    settings_table_name => 'svm_model_settings');
END;
/
```

This query shows that the models created in these examples are the only ones in your schema.

```
SELECT model_name, mining_function, algorithm FROM user_mining_models;
```

MODEL_NAME	MINING_FUNCTION	ALGORITHM
SVM_MODEL	CLASSIFICATION	SUPPORT_VECTOR_MACHINES
ANOMALY_DETECT_MODEL	CLASSIFICATION	SUPPORT_VECTOR_MACHINES

This query shows that only the SVM Classification model has a target.

```
SELECT model_name, attribute_name, attribute_type, target
       FROM user_mining_model_attributes
       WHERE target = 'YES';
```

MODEL_NAME	ATTRIBUTE_NAME	ATTRIBUTE_TYPE	TARGET
SVM_MODEL	AFFINITY_CARD	CATEGORICAL	YES

### 36.1.5.12 CREATE\_MODEL2 Procedure

The `CREATE_MODEL2` procedure is an alternate procedure to the `CREATE_MODEL` procedure, which enables creating a model without extra persistence stages. In the `CREATE_MODEL` procedure, the input is a table or a view and if such an object is not already present, the user must create it. By using the `CREATE_MODEL2` procedure, the user does not need to create such transient database objects.

#### Syntax

```
DBMS_DATA_MINING.CREATE_MODEL2 (
  model_name          IN VARCHAR2,
  mining_function     IN VARCHAR2,
  data_query          IN CLOB,
  set_list            IN SETTING_LIST,
  case_id_column_name IN VARCHAR2 DEFAULT NULL,
  target_column_name  IN VARCHAR2 DEFAULT NULL,
  xform_list          IN TRANSFORM_LIST DEFAULT NULL);
```

## Parameters

**Table 36-63 CREATE\_MODEL2 Procedure Parameters**

Parameter	Description
model_name	Name of the model in the form [schema_name.]model_name. If you do not specify a schema, then the current schema is used. See the Usage Notes, <a href="#">CREATE_MODEL Procedure</a> for model naming restrictions.
mining_function	The mining function. Values are listed in <a href="#">DBMS_DATA_MINING — Mining Function Settings</a> .
data_query	A query which provides training data for building the model.
set_list	Specifies the SETTING_LIST SETTING_LIST is a table of CLOB index by VARCHAR2 (30); Where the index is the setting name and the CLOB is the setting value for that name.
case_id_column_name	Case identifier column in the build data.
target_column_name	For supervised models, the target column in the build data. NULL for unsupervised models.
xform_list	Refer to <a href="#">CREATE_MODEL Procedure</a> .

## Usage Notes

Refer to [CREATE\\_MODEL Procedure](#) for Usage Notes.

## Examples

The following example uses the Support Vector Machine algorithm.

```

declare
  v_setlst DBMS_DATA_MINING.SETTING_LIST;

BEGIN
  v_setlst(dbms_data_mining.algo_name) :=
dbms_data_mining.algo_support_vector_machines;
  v_setlst(dbms_data_mining.prep_auto) := dbms_data_mining.prep_auto_on;

DBMS_DATA_MINING.CREATE_MODEL2 (
  model_name          => 'svm_model',
  mining_function     => dbms_data_mining.classification,
  data_query          => 'select * from mining_data_build_v',
  data_table_name     => 'mining_data_build_v',
  case_id_column_name=> 'cust_id',
  target_column_name => 'affinity_card',
  set_list            => v_setlst,
  case_id_column_name=> 'cust_id',
  target_column_name => 'affinity_card');

END;
/

```

### 36.1.5.13 Create Model Using Registration Information

Create model function fetches the setting information from JSON object.

#### Usage Notes

If an algorithm is registered, user can create model using the registered algorithm name. Since all R scripts and default setting values are already registered, providing the value through the setting table is not necessary. This makes the use of this algorithm easier.

#### Examples

The first example builds a Classification model using the GLM algorithm.

```
CREATE TABLE GLM_RDEMO_SETTINGS_CL (

    setting_name VARCHAR2(30),
    setting_value VARCHAR2(4000));
BEGIN
    INSERT INTO GLM_RDEMO_SETTINGS_CL VALUES
        ('ALGO_EXTENSIBLE_LANG', 'R');
    INSERT INTO GLM_RDEMO_SETTINGS_CL VALUES
        (dbms_data_mining.ralg_registration_algo_name, 't1');
    INSERT INTO GLM_RDEMO_SETTINGS_CL VALUES
        (dbms_data_mining.odms_formula,
        'AGE + EDUCATION + HOUSEHOLD_SIZE + OCCUPATION');
    INSERT INTO GLM_RDEMO_SETTINGS_CL VALUES
        ('RALG_PARAMETER_FAMILY', 'binomial(logit) ');
END;
/

BEGIN
    DBMS_DATA_MINING.CREATE_MODEL(
        model_name           => 'GLM_RDEMO_CLASSIFICATION',
        mining_function      => dbms_data_mining.classification,
        data_table_name      => 'mining_data_build_v',
        case_id_column_name  => 'CUST_ID',
        target_column_name   => 'AFFINITY_CARD',
        settings_table_name  => 'GLM_RDEMO_SETTINGS_CL');
END;
/
```

### 36.1.5.14 DROP\_ALGORITHM Procedure

This function is used to drop the registered algorithm information.

#### Syntax

```
DBMS_DATA_MINING.DROP_ALGORITHM (algorithm_name IN VARCHAR2(30),
                                cascade         IN BOOLEAN default FALSE)
```

#### Parameters

**Table 36-64 DROP\_ALGORITHM Procedure Parameters**

Parameter	Description
algorithm_name	Name of the algorithm.

**Table 36-64 (Cont.) DROP\_ALGORITHM Procedure Parameters**

Parameter	Description
cascade	If the cascade option is TRUE, all the models with this algorithms are forced to drop. There after, the algorithm is dropped. The default value is FALSE.

**Usage Note**

- To drop a mining model, you must be the owner or you must have the RQADMIN privilege. See *Oracle Data Mining User's Guide* for information about privileges for data mining.
- Make sure a model is not built on the algorithm, then drop the algorithm from the system table.
- If you try to drop an algorithm with a model built on it, then an error is displayed.

### 36.1.5.15 DROP\_PARTITION Procedure

The DROP\_PARTITION procedure drops a single partition that is specified in the parameter `partition_name`.

**Syntax**

```
DBMS_DATA_MINING.DROP_PARTITION (
    model_name           IN VARCHAR2,
    partition_name       IN VARCHAR2);
```

**Parameters****Table 36-65 DROP\_PARTITION Procedure Parameters**

Parameters	Description
model_name	Name of the mining model in the form [ <i>schema_name</i> .] <i>model_name</i> . If you do not specify a schema, then your own schema is used.
partition_name	Name of the partition that must be dropped.

### 36.1.5.16 DROP\_MODEL Procedure

This procedure deletes the specified mining model.

**Syntax**

```
DBMS_DATA_MINING.DROP_MODEL (model_name IN VARCHAR2,
                             force      IN BOOLEAN DEFAULT FALSE);
```



## Parameters

**Table 36-66 DROP\_MODEL Procedure Parameters**

Parameter	Description
model_name	Name of the mining model in the form <code>[schema_name.]model_name</code> . If you do not specify a schema, your own schema is used.
force	Forces the mining model to be dropped even if it is invalid. A mining model may be invalid if a serious system error interrupted the model build process.

## Usage Note

To drop a mining model, you must be the owner or you must have the `DROP ANY MINING MODEL` privilege. See *Oracle Data Mining User's Guide* for information about privileges for data mining.

## Example

You can use the following command to delete a valid mining model named `nb_sh_clas_sample` that exists in your schema.

```
BEGIN
  DBMS_DATA_MINING.DROP_MODEL(model_name => 'nb_sh_clas_sample');
END;
/
```

## 36.1.5.17 EXPORT\_MODEL Procedure

This procedure exports the specified data mining models to a dump file set.

To import the models from the dump file set, use the [IMPORT\\_MODEL Procedure](#). `EXPORT_MODEL` and `IMPORT_MODEL` use Oracle Data Pump technology.

When Oracle Data Pump is used to export/import an entire schema or database, the mining models in the schema or database are included. However, `EXPORT_MODEL` and `IMPORT_MODEL` are the only utilities that support the export/import of individual models.



### See Also:

*Oracle Database Utilities* for information about Oracle Data Pump

*Oracle Data Mining User's Guide* for more information about exporting and importing mining models

## Syntax

```
DBMS_DATA_MINING.EXPORT_MODEL (
  filename          IN VARCHAR2,
  directory         IN VARCHAR2,
  model_filter      IN VARCHAR2 DEFAULT NULL,
  filesize          IN VARCHAR2 DEFAULT NULL,
  operation         IN VARCHAR2 DEFAULT NULL,
  remote_link      IN VARCHAR2 DEFAULT NULL,
  jobname          IN VARCHAR2 DEFAULT NULL);
```

## Parameters

Table 36-67 EXPORT\_MODEL Procedure Parameters

Parameter	Description
filename	<p>Name of the dump file set to which the models should be exported. The name must be unique within the schema.</p> <p>The dump file set can contain one or more files. The number of files in a dump file set is determined by the size of the models being exported (both metadata and data) and a specified or estimated maximum file size. You can specify the file size in the <code>filesize</code> parameter, or you can use the <code>operation</code> parameter to cause Oracle Data Pump to estimate the file size. If the size of the models to export is greater than the maximum file size, one or more additional files are created.</p> <p>When the export operation completes successfully, the name of the dump file set is automatically expanded to <code>filename01.dmp</code>, even if there is only one file in the dump set. If there are additional files, they are named sequentially as <code>filename02.dmp</code>, <code>filename03.dmp</code>, and so forth.</p>
directory	<p>Name of a pre-defined directory object that specifies where the dump file set should be created.</p> <p>The exporting user must have read/write privileges on the directory object and on the file system directory that it identifies.</p> <p>See <i>Oracle Database SQL Language Reference</i> for information about directory objects.</p>
model_filter	<p>Optional parameter that specifies which model or models to export. If you do not specify a value for <code>model_filter</code>, all models in the schema are exported. You can also specify <code>NULL</code> (the default) or <code>'ALL'</code> to export all models.</p> <p>You can export individual models by name and groups of models based on mining function or algorithm. For instance, you could export all regression models or all Naive Bayes models. Examples are provided in <a href="#">Table 36-68</a>.</p>
filesize	<p>Optional parameter that specifies the maximum size of a file in the dump file set. The size may be specified in bytes, kilobytes (K), megabytes (M), or gigabytes (G). The default size is 50 MB.</p> <p>If the size of the models to export is larger than <code>filesize</code>, one or more additional files are created within the dump set. See the description of the <code>filename</code> parameter for more information.</p>
operation	<p>Optional parameter that specifies whether or not to estimate the size of the files in the dump set. By default the size is not estimated and the value of the <code>filesize</code> parameter determines the size of the files.</p> <p>You can specify either of the following values for <code>operation</code>:</p> <ul style="list-style-type: none"> <li><code>'EXPORT'</code> — Export all or the specified models. (Default)</li> <li><code>'ESTIMATE'</code> — Estimate the size of the exporting models.</li> </ul>
remote_link	<p>Optional parameter that specifies the name of a database link to a remote system. The default value is <code>NULL</code>. A database link is a schema object in a local database that enables access to objects in a remote database. When you specify a value for <code>remote_link</code>, you can export the models in the remote database. The <code>EXP_FULL_DATABASE</code> role is required for exporting the remote models. The <code>EXP_FULL_DATABASE</code> privilege, the <code>CREATE DATABASE LINK</code> privilege, and other privileges may also be required.</p>

**Table 36-67 (Cont.) EXPORT\_MODEL Procedure Parameters**

Parameter	Description
jobname	<p>Optional parameter that specifies the name of the export job. By default, the name has the form <i>username_exp_nnnn</i>, where <i>nnnn</i> is a number. For example, a job name in the SCOTT schema might be SCOTT_exp_134.</p> <p>If you specify a job name, it must be unique within the schema. The maximum length of the job name is 30 characters.</p> <p>A log file for the export job, named <i>jobname.log</i>, is created in the same directory as the dump file set.</p>

### Usage Notes

The `model_filter` parameter specifies which models to export. You can list the models by name, or you can specify all models that have the same mining function or algorithm. You can query the `USER_MINING_MODELS` view to list the models in your schema.

```
SQL> describe user_mining_models
Name                                         Null?    Type
-----
MODEL_NAME                                 NOT NULL VARCHAR2 (30)
MINING_FUNCTION                            VARCHAR2 (30)
ALGORITHM                                  VARCHAR2 (30)
CREATION_DATE                               NOT NULL DATE
BUILD_DURATION                              NUMBER
MODEL_SIZE                                  NUMBER
COMMENTS                                    VARCHAR2 (4000)
```

Examples of model filters are provided in [Table 36-68](#).

**Table 36-68 Sample Values for the Model Filter Parameter**

Sample Value	Meaning
'mymodel'	Export the model named <code>mymodel</code>
'name= 'mymodel''	Export the model named <code>mymodel</code>
'name IN ('mymodel2','mymodel3')'	Export the models named <code>mymodel2</code> and <code>mymodel3</code>
'ALGORITHM_NAME = 'NAIVE_BAYES''	Export all Naive Bayes models. See <a href="#">Table 36-5</a> for a list of algorithm names.
'FUNCTION_NAME = 'CLASSIFICATION''	Export all classification models. See <a href="#">Table 36-3</a> for a list of mining functions.

### Examples

- The following statement exports all the models in the `DMUSER3` schema to a dump file set called `models_out` in the directory `$ORACLE_HOME/rdbms/log`. This directory is mapped to a directory object called `DATA_PUMP_DIR`. The `DMUSER3` user has read/write access to the directory and to the directory object.

```
SQL>execute dbms_data_mining.export_model ('models_out', 'DATA_PUMP_DIR');
```

You can exit SQL\*Plus and list the resulting dump file and log file.

```
SQL>EXIT
>cd $ORACLE_HOME/rdbms/log
>ls
>DMUSER3_exp_1027.log  models_out01.dmp
```

- The following example uses the same directory object and is executed by the same user. This example exports the models called NMF\_SH\_SAMPLE and SVMR\_SH\_REGR\_SAMPLE to a different dump file set in the same directory.

```
SQL>EXECUTE DBMS_DATA_MINING.EXPORT_MODEL ( 'models2_out', 'DATA_PUMP_DIR',
      'name in ('NMF_SH_SAMPLE', 'SVMR_SH_REGR_SAMPLE')');
SQL>EXIT
>cd $ORACLE_HOME/rdbms/log
>ls
>DMUSER3_exp_1027.log  models_out01.dmp
  DMUSER3_exp_924.log  models2_out01.dmp
```

- The following examples show how to export models with specific algorithm and mining function names.

```
SQL>EXECUTE DBMS_DATA_MINING.EXPORT_MODEL('algo.dmp', 'DM_DUMP',
      'ALGORITHM_NAME IN ('O_CLUSTER','GENERALIZED_LINEAR_MODEL',
      'SUPPORT_VECTOR_MACHINES','NAIVE_BAYES')');

SQL>EXECUTE DBMS_DATA_MINING.EXPORT_MODEL('func.dmp', 'DM_DUMP',
      'FUNCTION_NAME IN (CLASSIFICATION,CLUSTERING,FEATURE_EXTRACTION)');
```

### 36.1.5.18 EXPORT\_SERMODEL Procedure

This procedure exports the model in a serialized format so that they can be moved to another platform for scoring.

When exporting a model in serialized format, the user must pass in an empty BLOB locator and specify the model name to be exported. If the model is partitioned, the user can optionally select an individual partition to export, otherwise all partitions are exported. The returned BLOB contains the content that can be deployed.

#### Syntax

```
DBMS_DATA_MINING.EXPORT_SERMODEL (
  model_data      IN OUT NOCOPY BLOB,
  model_name      IN VARCHAR2,
  partition_name  IN VARCHAR2 DEFAULT NULL);
```

#### Parameters

**Table 36-69 EXPORT\_SERMODEL Procedure Parameters**

Parameter	Description
model_data	Provides serialized model data.
model_name	Name of the mining model in the form [schema_name.]model_name. If you do not specify a schema, then your own schema is used.
partition_name	Name of the partition that must be exported.

## Examples

The following statement exports all the models in a serialized format.

```

DECLARE
  v_blob blob;
BEGIN
  dbms_lob.createtemporary(v_blob, FALSE);
  dbms_data_mining.export_sermodel(v_blob, 'MY_MODEL');
  -- save v_blob somewhere (e.g., bfile, etc.)
  dbms_lob.freetemporary(v_blob);
END;
/

```



### See Also:

*Oracle Data Mining User's Guide* for more information about exporting and importing mining models

## 36.1.5.19 FETCH\_JSON\_SCHEMA Procedure

User can fetch and read JSON schema from the ALL\_MINING\_ALGORITHMS view. This function returns the pre-registered JSON schema for R extensible algorithms.

### Syntax

```
DBMS_DATA_MINING.FETCH_JSON_SCHEMA RETURN CLOB;
```

### Parameters

**Table 36-70** FETCH\_JSON\_SCHEMA Procedure Parameters

Parameter	Description
RETURN	This function returns the pre-registered JSON schema for R extensibility. The default value is CLOB.

### Usage Note

If a user wants to register a new algorithm using the algorithm registration function, they must fetch and follow the pre-registered JSON schema using this function, when they create the required JSON object metadata, and then pass it to the registration function.

## 36.1.5.20 GET\_ASSOCIATION\_RULES Function

The GET\_ASSOCIATION\_RULES function returns the rules produced by an Association model. Starting from Oracle Database 12c Release 2, this function is deprecated. See "Model Detail Views" in *Oracle Data Mining User's Guide*

You can specify filtering criteria to GET\_ASSOCIATION\_RULES to return a subset of the rules. Filtering criteria can improve the performance of the table function. If the number of rules is

large, then the greatest performance improvement will result from specifying the `topn` parameter.

### Syntax

```
DBMS_DATA_MINING.get_association_rules(
    model_name      IN VARCHAR2,
    topn            IN NUMBER DEFAULT NULL,
    rule_id         IN INTEGER DEFAULT NULL,
    min_confidence  IN NUMBER DEFAULT NULL,
    min_support     IN NUMBER DEFAULT NULL,
    max_rule_length IN INTEGER DEFAULT NULL,
    min_rule_length IN INTEGER DEFAULT NULL,
    sort_order      IN ORA_MINING_VARCHAR2_NT DEFAULT NULL,
    antecedent_items IN DM_ITEMS DEFAULT NULL,
    consequent_items IN DM_ITEMS DEFAULT NULL,
    min_lift        IN NUMBER DEFAULT NULL,
    partition_name  IN VARCHAR2 DEFAULT NULL)
RETURN DM_Rules PIPELINED;
```

### Parameters

**Table 36-71 GET\_ASSOCIATION\_RULES Function Parameters**

Parameter	Description
<code>model_name</code>	Name of the model in the form <code>[schema_name.]model_name</code> . If you do not specify a schema, then your own schema is used.  This is the only required parameter of <code>GET_ASSOCIATION_RULES</code> . All other parameters specify optional filters on the rules to return.
<code>topn</code>	Returns the <i>n</i> top rules ordered by confidence and then support, both descending. If you specify a sort order, then the top <i>n</i> rules are derived after the sort is performed.  If <code>topn</code> is specified and no maximum or minimum rule length is specified, then the only columns allowed in the sort order are <code>RULE_CONFIDENCE</code> and <code>RULE_SUPPORT</code> . If <code>topn</code> is specified and a maximum or minimum rule length is specified, then <code>RULE_CONFIDENCE</code> , <code>RULE_SUPPORT</code> , and <code>NUMBER_OF_ITEMS</code> are allowed in the sort order.
<code>rule_id</code>	Identifier of the rule to return. If you specify a value for <code>rule_id</code> , do not specify values for the other filtering parameters.
<code>min_confidence</code>	Returns the rules with confidence greater than or equal to this number.
<code>min_support</code>	Returns the rules with support greater than or equal to this number.
<code>max_rule_length</code>	Returns the rules with a length less than or equal to this number.  Rule length refers to the number of items in the rule (See <code>NUMBER_OF_ITEMS</code> in <a href="#">Table 36-72</a> ). For example, in the rule <code>A=&gt;B</code> (if A, then B), the number of items is 2.  If <code>max_rule_length</code> is specified, then the <code>NUMBER_OF_ITEMS</code> column is permitted in the sort order.
<code>min_rule_length</code>	Returns the rules with a length greater than or equal to this number. See <code>max_rule_length</code> for a description of rule length.  If <code>min_rule_length</code> is specified, then the <code>NUMBER_OF_ITEMS</code> column is permitted in the sort order.

**Table 36-71 (Cont.) GET\_ASSOCIATION\_RULES Function Parameters**

Parameter	Description
sort_order	Sorts the rules by the values in one or more of the returned columns. Specify one or more column names, each followed by <code>ASC</code> for ascending order or <code>DESC</code> for descending order. (See <a href="#">Table 36-72</a> for the column names.)  For example, to sort the result set in descending order first by the <code>NUMBER_OF_ITEMS</code> column, then by the <code>RULE_CONFIDENCE</code> column, you must specify:  <code>ORA_MINING_VARCHAR2_NT('NUMBER_OF_ITEMS DESC', 'RULE_CONFIDENCE DESC')</code>  If you specify <code>topn</code> , the results will vary depending on the sort order.  By default, the results are sorted by Confidence in descending order, then by Support in descending order.
antecedent_items	Returns the rules with these items in the antecedent.
consequent_items	Returns the rules with this item in the consequent.
min_lift	Returns the rules with lift greater than or equal to this number.
partition_name	Specifies a partition in a partitioned model.

**Return Values**

The object type returned by `GET_ASSOCIATION_RULES` is described in [Table 36-72](#). For descriptions of each field, see the Usage Notes.

**Table 36-72 GET\_ASSOCIATION RULES Function Return Values**

Return Value	Description
DM_RULES	A set of rows of type <code>DM_RULE</code> . The rows have the following columns:  (rule_id                    INTEGER, antecedent                DM_PREDICATES, consequent                DM_PREDICATES, rule_support              NUMBER, rule_confidence          NUMBER, rule_lift                 NUMBER, antecedent_support        NUMBER, consequent_support        NUMBER, number_of_items          INTEGER )
DM_PREDICATES	The antecedent and consequent columns each return nested tables of type <code>DM_PREDICATES</code> . The rows, of type <code>DM_PREDICATE</code> , have the following columns:  (attribute_name            VARCHAR2(4000), attribute_subname         VARCHAR2(4000), conditional_operator      CHAR(2) /*=, <>, <, >, <=, >=*/, attribute_num_value        NUMBER, attribute_str_value        VARCHAR2(4000), attribute_support          NUMBER, attribute_confidence       NUMBER)

## Usage Notes

1. This table function pipes out rows of type `DM_RULES`. For information on Data Mining data types and piped output from table functions, see "[Datatypes](#)".
2. The columns returned by `GET_ASSOCIATION_RULES` are described as follows:

Column in <code>DM_RULES</code>	Description
<code>rule_id</code>	Unique identifier of the rule
<code>antecedent</code>	<p>The independent condition in the rule. When this condition exists, the dependent condition in the consequent also exists.</p> <p>The condition is a combination of attribute values called a predicate (<code>DM_PREDICATE</code>). The predicate specifies a condition for each attribute. The condition may specify equality (=), inequality (&lt;&gt;), greater than (&gt;), less than (&lt;), greater than or equal to (&gt;=), or less than or equal to (&lt;=) a given value.</p> <p>Support and Confidence for each attribute condition in the antecedent is returned in the predicate. Support is the number of transactions that satisfy the antecedent. Confidence is the likelihood that a transaction will satisfy the antecedent.</p> <p><b>Note:</b> The occurrence of the attribute as a <code>DM_PREDICATE</code> indicates the presence of the item in the transaction. The actual value for <code>attribute_num_value</code> or <code>attribute_str_value</code> is meaningless. For example, the following predicate indicates that 'Mouse Pad' is present in the transaction <i>even though</i> the attribute value is NULL.</p> <pre>DM_PREDICATE('PROD_NAME',               'Mouse Pad', '= ', NULL, NULL, NULL, NULL))</pre>
<code>consequent</code>	<p>The dependent condition in the rule. This condition exists when the antecedent exists.</p> <p>The consequent, like the antecedent, is a predicate (<code>DM_PREDICATE</code>).</p> <p>Support and confidence for each attribute condition in the consequent is returned in the predicate. Support is the number of transactions that satisfy the consequent. Confidence is the likelihood that a transaction will satisfy the consequent.</p>
<code>rule_support</code>	The number of transactions that satisfy the rule.
<code>rule_confidence</code>	The likelihood of a transaction satisfying the rule.
<code>rule_lift</code>	The degree of improvement in the prediction over random chance when the rule is satisfied.
<code>antecedent_support</code>	The ratio of the number of transactions that satisfy the antecedent to the total number of transactions.
<code>consequent_support</code>	The ratio of the number of transactions that satisfy the consequent to the total number of transactions.
<code>number_of_items</code>	The total number of attributes referenced in the antecedent and consequent of the rule.

## Examples

The following example demonstrates an Association model build followed by several invocations of the `GET_ASSOCIATION_RULES` table function:

```
-- prepare a settings table to override default settings
CREATE TABLE market_settings AS
SELECT *
```



```

    FROM TABLE(DBMS_DATA_MINING.GET_DEFAULT_SETTINGS)
    WHERE setting_name LIKE 'ASSO_%';
BEGIN
-- update the value of the minimum confidence
UPDATE market_settings
    SET setting_value = TO_CHAR(0.081)
    WHERE setting_name = DBMS_DATA_MINING.asso_min_confidence;

-- build an AR model
DBMS_DATA_MINING.CREATE_MODEL(
    model_name => 'market_model',
    function => DBMS_DATA_MINING.ASSOCIATION,
    data_table_name => 'market_build',
    case_id_column_name => 'item_id',
    target_column_name => NULL,
    settings_table_name => 'market_settings');
END;
/
-- View the (unformatted) rules
SELECT rule_id, antecedent, consequent, rule_support,
       rule_confidence
    FROM TABLE(DBMS_DATA_MINING.GET_ASSOCIATION_RULES('market_model'));

```

In the previous example, you view all rules. To view just the top 20 rules, use the following statement.

```

-- View the top 20 (unformatted) rules
SELECT rule_id, antecedent, consequent, rule_support,
       rule_confidence
    FROM TABLE(DBMS_DATA_MINING.GET_ASSOCIATION_RULES('market_model', 20));

```

The following query uses the Association model AR\_SH\_SAMPLE, which is created from one of the Oracle Data Mining sample programs:

```

SELECT * FROM TABLE (
    DBMS_DATA_MINING.GET_ASSOCIATION_RULES (
        'AR_SH_SAMPLE', 10, NULL, 0.5, 0.01, 2, 1,
        ORA_MINING_VARCHAR2_NT (
            'NUMBER_OF_ITEMS DESC', 'RULE_CONFIDENCE DESC', 'RULE_SUPPORT DESC'),
        DM_ITEMS(DM_ITEM('CUSTPRODS', 'Mouse Pad', 1, NULL),
            DM_ITEM('CUSTPRODS', 'Standard Mouse', 1, NULL)),
        DM_ITEMS(DM_ITEM('CUSTPRODS', 'Extension Cable', 1, NULL)));

```

The query returns three rules, shown as follows:

```

13  DM_PREDICATES(
      DM_PREDICATE('CUSTPRODS', 'Mouse Pad', '= ', 1, NULL, NULL, NULL),
      DM_PREDICATE('CUSTPRODS', 'Standard Mouse', '= ', 1, NULL, NULL, NULL))
    DM_PREDICATES(
      DM_PREDICATE('CUSTPRODS', 'Extension Cable', '= ', 1, NULL, NULL, NULL))
    .15532      .84393      2.7075      .18404      .3117      2

11  DM_PREDICATES(
      DM_PREDICATE('CUSTPRODS', 'Standard Mouse', '= ', 1, NULL, NULL, NULL))
    DM_PREDICATES(
      DM_PREDICATE('CUSTPRODS', 'Extension Cable', '= ', 1, NULL, NULL, NULL))
    .18085      .56291      1.8059      .32128      .3117      1

9   DM_PREDICATES(
      DM_PREDICATE('CUSTPRODS', 'Mouse Pad', '= ', 1, NULL, NULL, NULL))
    DM_PREDICATES(
      DM_PREDICATE('CUSTPRODS', 'Extension Cable', '= ', 1, NULL, NULL, NULL))

```

.17766 .55116 1.7682 .32234 .3117 1

 **See Also:**

[Table 36-72](#) for the `DM_RULE` column data types.

*Oracle Data Mining User's Guide* for information about the sample programs.

*Oracle Data Mining User's Guide* for Model Detail Views.

### 36.1.5.21 GET\_FREQUENT\_ITEMSETS Function

The `GET_FREQUENT_ITEMSETS` function returns a set of rows that represent the frequent itemsets from an Association model. Starting from Oracle Database 12c Release 2, this function is deprecated. See "Model Detail Views" in *Oracle Data Mining User's Guide*.

For a detailed description of frequent itemsets, consult *Oracle Data Mining Concepts*.

#### Syntax

```
DBMS_DATA_MINING.get_frequent_itemsets(
    model_name IN VARCHAR2,
    topn IN NUMBER DEFAULT NULL,
    max_itemset_length IN NUMBER DEFAULT NULL,
    partition_name IN VARCHAR2 DEFAULT NULL)
RETURN DM_ItemSets PIPELINED;
```

#### Parameters

**Table 36-73** GET\_FREQUENT\_ITEMSETS Function Parameters

Parameter	Description
<code>model_name</code>	Name of the model in the form <code>[schema_name].model_name</code> . If you do not specify a schema, then your own schema is used.
<code>topn</code>	When not NULL, return the top <i>n</i> rows ordered by support in descending order
<code>max_itemset_length</code>	Maximum length of an item set.
<code>partition_name</code>	Specifies a partition in a partitioned model.

 **Note:**

The `partition_name` columns applies only when the model is partitioned.

## Return Values

**Table 36-74 GET\_FREQUENT\_ITEMSETS Function Return Values**

Return Value	Description
DM_ITEMSETS	A set of rows of type DM_ITEMSET. The rows have the following columns:  (partition_name VARCHAR2(128) itemsets_id NUMBER, items DM_ITEMS, support NUMBER, number_of_items NUMBER)



### Note:

The `partition_name` columns applies only when the model is partitioned.

The `items` column returns a nested table of type DM\_ITEMS. The rows have type DM\_ITEM:

```
(attribute_name      VARCHAR2(4000),
 attribute_subname   VARCHAR2(4000),
 attribute_num_value NUMBER,
 attribute_str_value VARCHAR2(4000))
```

## Usage Notes

This table function pipes out rows of type DM\_ITEMSETS. For information on Data Mining datatypes and piped output from table functions, see "[Datatypes](#)".

## Examples

The following example demonstrates an Association model build followed by an invocation of GET\_FREQUENT\_ITEMSETS table function from Oracle SQL.

```
-- prepare a settings table to override default settings
CREATE TABLE market_settings AS

    SELECT *

    FROM TABLE(DBMS_DATA_MINING.GET_DEFAULT_SETTINGS)
    WHERE setting_name LIKE 'ASSO_%';
BEGIN
-- update the value of the minimum confidence
UPDATE market_settings
    SET setting_value = TO_CHAR(0.081)
    WHERE setting_name = DBMS_DATA_MINING.asso_min_confidence;

/* build a AR model */
DBMS_DATA_MINING.CREATE_MODEL(
    model_name          => 'market_model',
    function            => DBMS_DATA_MINING.ASSOCIATION,
    data_table_name     => 'market_build',
    case_id_column_name => 'item_id',
    target_column_name  => NULL,
```

```

    settings_table_name => 'market_settings');
END;
/

-- View the (unformatted) Itemsets from SQL*Plus
SELECT itemset_id, items, support, number_of_items
  FROM TABLE(DBMS_DATA_MINING.GET_FREQUENT_ITEMSETS('market_model'));

```

In the example above, you view all itemsets. To view just the top 20 itemsets, use the following statement:

```

-- View the top 20 (unformatted) Itemsets from SQL*Plus
SELECT itemset_id, items, support, number_of_items
  FROM TABLE(DBMS_DATA_MINING.GET_FREQUENT_ITEMSETS('market_model', 20));

```



### See Also:

*Oracle Data Mining User's Guide*

## 36.1.5.22 GET\_MODEL\_COST\_MATRIX Function

The `GET_*` interfaces are replaced by model views, and Oracle recommends that users leverage the views instead. The `GET_MODEL_COST_MATRIX` function is replaced by the `DM$VC` prefixed view, Scoring Cost Matrix. The cost matrix used when building a Decision Tree is made available by the `DM$VM` prefixed view, Decision Tree Build Cost Matrix.

Refer to Model Detail View for Classification Algorithm.

The `GET_MODEL_COST_MATRIX` function returns the rows of a cost matrix associated with the specified model.

By default, this function returns the scoring cost matrix that was added to the model with the `ADD_COST_MATRIX` procedure. If you wish to obtain the cost matrix used to create a model, specify `cost_matrix_type_create` as the `matrix_type`. See [Table 36-75](#).

See also [ADD\\_COST\\_MATRIX Procedure](#).

### Syntax

```

DBMS_DATA_MINING.GET_MODEL_COST_MATRIX (
    model_name           IN VARCHAR2,
    matrix_type          IN VARCHAR2 DEFAULT cost_matrix_type_score)
    partition_name      IN VARCHAR2 DEFAULT NULL);
RETURN DM_COST_MATRIX PIPELINED;

```

### Parameters

**Table 36-75 GET\_MODEL\_COST\_MATRIX Function Parameters**

Parameter	Description
<code>model_name</code>	Name of the model in the form <code>[schema_name.]model_name</code> . If you do not specify a schema, then your own schema is used.

**Table 36-75 (Cont.) GET\_MODEL\_COST\_MATRIX Function Parameters**

Parameter	Description
matrix_type	The type of cost matrix. COST_MATRIX_TYPE_SCORE — cost matrix used for scoring. (Default.) COST_MATRIX_TYPE_CREATE — cost matrix used to create the model (Decision Tree only).
partition_name	Name of the partition in a partitioned model

**Return Values****Table 36-76 GET\_MODEL\_COST\_MATRIX Function Return Values**

Return Value	Description								
DM_COST_MATRIX	A set of rows of type DM_COST_ELEMENT. The rows have the following columns:  <table border="0"> <tr> <td>actual</td> <td>VARCHAR2(4000),</td> <td>NUMBER,</td> <td>predicted</td> </tr> <tr> <td>VARCHAR2(4000),</td> <td>cost</td> <td>NUMBER)</td> <td></td> </tr> </table>	actual	VARCHAR2(4000),	NUMBER,	predicted	VARCHAR2(4000),	cost	NUMBER)	
actual	VARCHAR2(4000),	NUMBER,	predicted						
VARCHAR2(4000),	cost	NUMBER)							

**Usage Notes**

Only Decision Tree models can be built with a cost matrix. If you want to build a Decision Tree model with a cost matrix, specify the cost matrix table name in the CLAS\_COST\_TABLE\_NAME setting in the settings table for the model. See [Table 36-7](#).

The cost matrix used to create a Decision Tree model becomes the default scoring matrix for the model. If you want to specify different costs for scoring, you can use the REMOVE\_COST\_MATRIX procedure to remove the cost matrix and the ADD\_COST\_MATRIX procedure to add a new one.

The GET\_MODEL\_COST\_MATRIX may return either the build or scoring cost matrix defined for a model or model partition.

If you do not specify a partitioned model name, then an error is displayed.

**Example**

This example returns the scoring cost matrix associated with the Naive Bayes model NB\_SH\_CLAS\_SAMPLE.

```
column actual format a10
column predicted format a10
SELECT *
      FROM TABLE(dbms_data_mining.get_model_cost_matrix('nb_sh_clas_sample'))
      ORDER BY predicted, actual;
```

ACTUAL	PREDICTED	COST
0	0	.00
1	0	.75
0	1	.25
1	1	.00

### 36.1.5.23 GET\_MODEL\_DETAILS\_AI Function

The `GET_MODEL_DETAILS_AI` function returns a set of rows that provide the details of an Attribute Importance model. Starting from Oracle Database 12c Release 2, this function is deprecated. See "Model Detail Views" in *Oracle Data Mining User's Guide*.

#### Syntax

```
DBMS_DATA_MINING.get_model_details_ai(
    model_name IN VARCHAR2,
    partition_name IN VARCHAR2 DEFAULT NULL)
RETURN dm_ranked_attributes pipelined;
```

#### Parameters

**Table 36-77 GET\_MODEL\_DETAILS\_AI Function Parameters**

Parameter	Description
<code>model_name</code>	Name of the model in the form <code>[schema_name.]model_name</code> . If you do not specify a schema, then your own schema is used.
<code>partition_name</code>	Specifies a partition in a partitioned model.

#### Return Values

**Table 36-78 GET\_MODEL\_DETAILS\_AI Function Return Values**

Return Value	Description								
<code>DM_RANKED_ATTRIBUTES</code>	A set of rows of type <code>DM_RANKED_ATTRIBUTE</code> . The rows have the following columns: <table border="0" style="margin-left: 20px;"> <tr> <td><code>attribute_name</code></td> <td><code>VARCHAR2(4000)</code>,</td> </tr> <tr> <td><code>attribute_subname</code></td> <td><code>VARCHAR2(4000)</code>,</td> </tr> <tr> <td><code>importance_value</code></td> <td><code>NUMBER</code>,</td> </tr> <tr> <td><code>rank</code></td> <td><code>NUMBER(38)</code></td> </tr> </table>	<code>attribute_name</code>	<code>VARCHAR2(4000)</code> ,	<code>attribute_subname</code>	<code>VARCHAR2(4000)</code> ,	<code>importance_value</code>	<code>NUMBER</code> ,	<code>rank</code>	<code>NUMBER(38)</code>
<code>attribute_name</code>	<code>VARCHAR2(4000)</code> ,								
<code>attribute_subname</code>	<code>VARCHAR2(4000)</code> ,								
<code>importance_value</code>	<code>NUMBER</code> ,								
<code>rank</code>	<code>NUMBER(38)</code>								

#### Examples

The following example returns model details for the Attribute Importance model `AI_SH_sample`, which was created by the sample program `dmaidemo.sql`. For information about the sample programs, see *Oracle Data Mining User's Guide*.

```
SELECT attribute_name, importance_value, rank
       FROM TABLE(DBMS_DATA_MINING.GET_MODEL_DETAILS_AI('AI_SH_sample'))
       ORDER BY RANK;
```

ATTRIBUTE_NAME	IMPORTANCE_VALUE	RANK
HOUSEHOLD_SIZE	.151685183	1
CUST_MARITAL_STATUS	.145294546	2
YRS_RESIDENCE	.07838928	3
AGE	.075027496	4
Y_BOX_GAMES	.063039952	5
EDUCATION	.059605314	6
HOME_THEATER_PACKAGE	.056458722	7
OCCUPATION	.054652937	8

CUST_GENDER	.035264741	9
BOOKKEEPING_APPLICATION	.019204751	10
PRINTER_SUPPLIES	0	11
OS_DOC_SET_KANJI	-.00050013	12
FLAT_PANEL_MONITOR	-.00509564	13
BULK_PACK_DISKETTES	-.00540822	14
COUNTRY_NAME	-.01201116	15
CUST_INCOME_LEVEL	-.03951311	16

### 36.1.5.24 GET\_MODEL\_DETAILS\_EM Function

The `GET_MODEL_DETAILS_EM` function returns a set of rows that provide statistics about the clusters produced by an Expectation Maximization model. Starting from Oracle Database 12c Release 2, this function is deprecated. See "Model Detail Views" in *Oracle Data Mining User's Guide*.

By default, the EM algorithm groups components into high-level clusters, and `GET_MODEL_DETAILS_EM` returns only the high-level clusters with their hierarchies. Alternatively, you can configure EM model to disable the grouping of components into high-level clusters. In this case, `GET_MODEL_DETAILS_EM` returns the components themselves as clusters with their hierarchies. See [Table 36-12](#).

#### Syntax

```
DBMS_DATA_MINING.get_model_details_em(
    model_name VARCHAR2,
    cluster_id NUMBER DEFAULT NULL,
    attribute VARCHAR2 DEFAULT NULL,
    centroid NUMBER DEFAULT 1,
    histogram NUMBER DEFAULT 1,
    rules NUMBER DEFAULT 2,
    attribute_subname VARCHAR2 DEFAULT NULL,
    topn_attributes NUMBER DEFAULT NULL,
    partition_name IN VARCHAR2 DEFAULT NULL)
RETURN dm_clusters PIPELINED;
```

#### Parameters

**Table 36-79 GET\_MODEL\_DETAILS\_EM Function Parameters**

Parameter	Description
<code>model_name</code>	Name of the model in the form <code>[schema_name.]model_name</code> . If you do not specify a schema, then your own schema is used.
<code>cluster_id</code>	The ID of a cluster in the model. When a valid cluster ID is specified, only the details of this cluster are returned. Otherwise, the details for all clusters are returned.
<code>attribute</code>	The name of an attribute. When a valid attribute name is specified, only the details of this attribute are returned. Otherwise, the details for all attributes are returned.
<code>centroid</code>	This parameter accepts the following values: <ul style="list-style-type: none"> <li>1: Details about centroids are returned (default)</li> <li>0: Details about centroids are not returned</li> </ul>
<code>histogram</code>	This parameter accepts the following values: <ul style="list-style-type: none"> <li>1: Details about histograms are returned (default)</li> <li>0: Details about histograms are not returned</li> </ul>

**Table 36-79 (Cont.) GET\_MODEL\_DETAILS\_EM Function Parameters**

Parameter	Description
rules	This parameter accepts the following values: <ul style="list-style-type: none"> <li>• 2: Details about rules are returned (default)</li> <li>• 1: Rule summaries are returned</li> <li>• 0: No information about rules is returned</li> </ul>
attribute_subname	The name of a nested attribute. The full name of a nested attribute has the form: <i>attribute_name.attribute_subname</i> where <i>attribute_name</i> is the name of the column and <i>attribute_subname</i> is the name of the nested attribute in that column. If the attribute is not nested, then <i>attribute_subname</i> is null.
topn_attributes	Restricts the number of attributes returned in the centroid, histogram, and rules objects. Only the <i>n</i> attributes with the highest confidence values in the rules are returned.  If the number of attributes included in the rules is less than <i>topn</i> , then, up to <i>n</i> additional attributes in alphabetical order are returned.  If both the <i>attribute</i> and <i>topn_attributes</i> parameters are specified, then <i>topn_attributes</i> is ignored.
partition_name	Specifies a partition in a partitioned model.

**Usage Notes**

1. For information on Data Mining datatypes and Return Values for Clustering Algorithms piped output from table functions, see "[Datatypes](#)".
2. GET\_MODEL\_DETAILS functions preserve model transparency by automatically reversing the transformations applied during the build process. Thus the attributes returned in the model details are the original attributes (or a close approximation of the original attributes) used to build the model.
3. When cluster statistics are disabled (EMCS\_CLUSTER\_STATISTICS is set to EMCS\_CLUS\_STATS\_DISABLE), GET\_MODEL\_DETAILS\_EM does not return centroids, histograms, or rules. Only taxonomy (hierarchy) and cluster counts are returned.
4. When the partition\_name is NULL for a partitioned model, an exception is thrown. When the value is not null, it must contain the desired partition name.

**Related Topics**

- *Oracle Data Mining User's Guide*

### 36.1.5.25 GET\_MODEL\_DETAILS\_EM\_COMP Function

The GET\_MODEL\_DETAILS\_EM\_COMP table function returns a set of rows that provide details about the parameters of an Expectation Maximization model. Starting from Oracle Database 12c Release 2, this function is deprecated. See "Model Detail Views" in *Oracle Data Mining User's Guide*.

**Syntax**

```
DBMS_DATA_MINING.get_model_details_em_comp(
    model_name IN VARCHAR2,
```



```
partition_name IN VARCHAR2 DEFAULT NULL)
RETURN DM_EM_COMPONENT_SET PIPELINED;
```

## Parameters

**Table 36-80 GET\_MODEL\_DETAILS\_EM\_COMP Function Parameters**

Parameter	Description
model_name	Name of the model in the form [schema_name.]model_name. If you do not specify a schema, your own schema is used.
partition_name	Specifies a partition in a partitioned model to retrieve details for.

## Return Values

**Table 36-81 GET\_MODEL\_DETAILS\_EM\_COMP Function Return Values**

Return Value	Description														
DM_EM_COMPONENT_SET	A set of rows of type DM_EM_COMPONENT. The rows have the following columns:  <table border="0"> <tr> <td>(info_type</td> <td>VARCHAR2(30),</td> </tr> <tr> <td>component_id</td> <td>NUMBER,</td> </tr> <tr> <td>cluster_id</td> <td>NUMBER,</td> </tr> <tr> <td>attribute_name</td> <td>VARCHAR2(4000),</td> </tr> <tr> <td>covariate_name</td> <td>VARCHAR2(4000),</td> </tr> <tr> <td>attribute_value</td> <td>VARCHAR2(4000),</td> </tr> <tr> <td>value</td> <td>NUMBER )</td> </tr> </table>	(info_type	VARCHAR2(30),	component_id	NUMBER,	cluster_id	NUMBER,	attribute_name	VARCHAR2(4000),	covariate_name	VARCHAR2(4000),	attribute_value	VARCHAR2(4000),	value	NUMBER )
(info_type	VARCHAR2(30),														
component_id	NUMBER,														
cluster_id	NUMBER,														
attribute_name	VARCHAR2(4000),														
covariate_name	VARCHAR2(4000),														
attribute_value	VARCHAR2(4000),														
value	NUMBER )														

## Usage Notes

1. This table function pipes out rows of type DM\_EM\_COMPONENT. For information on Data Mining datatypes and piped output from table functions, see "[Datatypes](#)".

The columns in each row returned by GET\_MODEL\_DETAILS\_EM\_COMP are described as follows:

Column in DM_EM_COMPONENT	Description
info_type	The type of information in the row. The following information types are supported: <ul style="list-style-type: none"> <li>• cluster</li> <li>• prior</li> <li>• mean</li> <li>• covariance</li> <li>• frequency</li> </ul>
component_id	Unique identifier of a component
cluster_id	Unique identifier of the high-level leaf cluster for each component
attribute_name	Name of an original attribute or a derived feature ID. The derived feature ID is used in models built on data with nested columns. The derived feature definitions can be obtained from the <a href="#">GET_MODEL_DETAILS_EM_PROJ Function</a> .

Column in DM_EM_COMPONENT	Description
covariate_name	Name of an original attribute or a derived feature ID used in variance/covariance definition
attribute_value	Categorical value or bin interval for binned numerical attributes
value	Encodes different information depending on the value of info_type, as follows: <ul style="list-style-type: none"> <li>cluster — The value field is NULL</li> <li>prior — The value field returns the component prior</li> <li>mean — The value field returns the mean of the attribute specified in attribute_name</li> <li>covariance — The value field returns the covariance of the attributes specified in attribute_name and covariate_name. Using the same attribute in attribute_name and covariate_name, returns the variance.</li> <li>frequency — The value field returns the multivalued Bernoulli frequency parameter for the attribute/value combination specified by attribute_name and attribute_value</li> </ul> <p>See Usage Note 2 for details.</p>

2. The following table shows which fields are used for each info\_type. The blank cells represent NULLS.

info_type	component_id	cluster_id	attribute_name	covariate_name	attribute_value	value
cluster	X	X				
prior	X	X				X
mean	X	X	X			X
covariance	X	X	X	X		X
frequency	X	X	X		X	X

3. GET\_MODEL\_DETAILS functions preserve model transparency by automatically reversing the transformations applied during the build process. Thus the attributes returned in the model details are the original attributes (or a close approximation of the original attributes) used to build the model.
4. When the value is NULL for a partitioned model, an exception is thrown. When the value is not null, it must contain the desired partition name.

#### Related Topics

- Oracle Data Mining User's Guide

### 36.1.5.26 GET\_MODEL\_DETAILS\_EM\_PROJ Function

The GET\_MODEL\_DETAILS\_EM\_PROJ function returns a set of rows that provide statistics about the projections produced by an Expectation Maximization model. Starting from Oracle

Database 12c Release 2, this function is deprecated. See "Model Detail Views" in *Oracle Data Mining User's Guide*.

### Syntax

```
DBMS_DATA_MINING.get_model_details_em_proj(
    model_name IN VARCHAR2,
    partition_name IN VARCHAR2 DEFAULT NULL)
RETURN DM_EM_PROJECTION_SET PIPELINED;
```

### Parameters

**Table 36-82 GET\_MODEL\_DETAILS\_EM\_PROJ Function Parameters**

Parameter	Description
model_name	Name of the model in the form [schema_name.]model_name. If you do not specify a schema, then your own schema is used.
partition_name	Specifies a partition in a partitioned model

### Return Values

**Table 36-83 GET\_MODEL\_DETAILS\_EM\_PROJ Function Return Values**

Return Value	Description										
DM_EM_PROJECTION_SET	<p>A set of rows of type DM_EM_PROJECTION. The rows have the following columns:</p> <table border="1"> <tbody> <tr> <td>feature_name</td> <td>VARCHAR2(4000),</td> </tr> <tr> <td>attribute_name</td> <td>VARCHAR2(4000),</td> </tr> <tr> <td>attribute_subname</td> <td>VARCHAR2(4000),</td> </tr> <tr> <td>attribute_value</td> <td>VARCHAR2(4000),</td> </tr> <tr> <td>coefficient</td> <td>NUMBER )</td> </tr> </tbody> </table> <p>See Usage Notes for details.</p>	feature_name	VARCHAR2(4000),	attribute_name	VARCHAR2(4000),	attribute_subname	VARCHAR2(4000),	attribute_value	VARCHAR2(4000),	coefficient	NUMBER )
feature_name	VARCHAR2(4000),										
attribute_name	VARCHAR2(4000),										
attribute_subname	VARCHAR2(4000),										
attribute_value	VARCHAR2(4000),										
coefficient	NUMBER )										

### Usage Notes

1. This table function pipes out rows of type DM\_EM\_PROJECTION. For information on Data Mining datatypes and piped output from table functions, see "Datatypes".

The columns in each row returned by GET\_MODEL\_DETAILS\_EM\_PROJ are described as follows:

Column in DM_EM_PROJECTION	Description
feature_name	Name of a derived feature. The feature maps to the attribute_name returned by the <a href="#">GET_MODEL_DETAILS_EM Function</a> .
attribute_name	Name of a column in the build data
attribute_subname	Subname in a nested column
attribute_value	Categorical value
coefficient	Projection coefficient. The representation is sparse; only the non-zero coefficients are returned.

2. `GET_MODEL_DETAILS` functions preserve model transparency by automatically reversing the transformations applied during the build process. Thus the attributes returned in the model details are the original attributes (or a close approximation of the original attributes) used to build the model.

The coefficients are related to the transformed, not the original, attributes. When returned directly with the model details, the coefficients may not provide meaningful information.

3. When the value is `NULL` for a partitioned model, an exception is thrown. When the value is not null, it must contain the desired partition name.

### Related Topics

- *Oracle Data Mining User's Guide*

## 36.1.5.27 GET\_MODEL\_DETAILS\_GLM Function

The `GET_MODEL_DETAILS_GLM` function returns the coefficient statistics for a Generalized Linear Model. Starting from Oracle Database 12c Release 2, this function is deprecated. See "Model Detail Views" in *Oracle Data Mining User's Guide*.

The same set of statistics is returned for both linear and Logistic Regression, but statistics that do not apply to the mining function are returned as `NULL`. For more details, see the Usage Notes.

### Syntax

```
DBMS_DATA_MINING.get_model_details_glm(
    model_name IN VARCHAR2,
    partition_name IN VARCHAR2 DEFAULT NULL)
RETURN DM_GLM_Coeff_Set PIPELINED;
```

### Parameters

**Table 36-84** GET\_MODEL\_DETAILS\_GLM Function Parameters

Parameter	Description
<code>model_name</code>	Name of the model in the form [ <i>schema_name</i> .] <i>model_name</i> . If you do not specify a schema, then your own schema is used.
<code>partition_name</code>	Specifies a partition in a partitioned model

## Return Values

**Table 36-85 GET\_MODEL\_DETAILS\_GLM Return Values**

Return Value	Description																																
DM_GLM_COEFF_SET	<p>A set of rows of type DM_GLM_COEFF. The rows have the following columns:</p> <table> <tbody> <tr> <td>class</td> <td>VARCHAR2(4000),</td> </tr> <tr> <td>attribute_name</td> <td>VARCHAR2(4000),</td> </tr> <tr> <td>attribute_subname</td> <td>VARCHAR2(4000),</td> </tr> <tr> <td>attribute_value</td> <td>VARCHAR2(4000),</td> </tr> <tr> <td>feature_expression</td> <td>VARCHAR2(4000),</td> </tr> <tr> <td>coefficient</td> <td>NUMBER,</td> </tr> <tr> <td>std_error</td> <td>NUMBER,</td> </tr> <tr> <td>test_statistic</td> <td>NUMBER,</td> </tr> <tr> <td>p_value</td> <td>NUMBER,</td> </tr> <tr> <td>VIF</td> <td>NUMBER,</td> </tr> <tr> <td>std_coefficient</td> <td>NUMBER,</td> </tr> <tr> <td>lower_coeff_limit</td> <td>NUMBER,</td> </tr> <tr> <td>upper_coeff_limit</td> <td>NUMBER,</td> </tr> <tr> <td>exp_coefficient</td> <td>BINARY_DOUBLE,</td> </tr> <tr> <td>exp_lower_coeff_limit</td> <td>BINARY_DOUBLE,</td> </tr> <tr> <td>exp_upper_coeff_limit</td> <td>BINARY_DOUBLE)</td> </tr> </tbody> </table>	class	VARCHAR2(4000),	attribute_name	VARCHAR2(4000),	attribute_subname	VARCHAR2(4000),	attribute_value	VARCHAR2(4000),	feature_expression	VARCHAR2(4000),	coefficient	NUMBER,	std_error	NUMBER,	test_statistic	NUMBER,	p_value	NUMBER,	VIF	NUMBER,	std_coefficient	NUMBER,	lower_coeff_limit	NUMBER,	upper_coeff_limit	NUMBER,	exp_coefficient	BINARY_DOUBLE,	exp_lower_coeff_limit	BINARY_DOUBLE,	exp_upper_coeff_limit	BINARY_DOUBLE)
class	VARCHAR2(4000),																																
attribute_name	VARCHAR2(4000),																																
attribute_subname	VARCHAR2(4000),																																
attribute_value	VARCHAR2(4000),																																
feature_expression	VARCHAR2(4000),																																
coefficient	NUMBER,																																
std_error	NUMBER,																																
test_statistic	NUMBER,																																
p_value	NUMBER,																																
VIF	NUMBER,																																
std_coefficient	NUMBER,																																
lower_coeff_limit	NUMBER,																																
upper_coeff_limit	NUMBER,																																
exp_coefficient	BINARY_DOUBLE,																																
exp_lower_coeff_limit	BINARY_DOUBLE,																																
exp_upper_coeff_limit	BINARY_DOUBLE)																																

GET\_MODEL\_DETAILS\_GLM returns a row of statistics for each attribute and one extra row for the intercept, which is identified by a null value in the attribute name. Each row has the DM\_GLM\_COEFF datatype. The statistics are described in [Table 36-86](#).

**Table 36-86 DM\_GLM\_COEFF Datatype Description**

Column	Description
class	<p>The non-reference target class for Logistic Regression. The model is built to predict the probability of this class.</p> <p>The other class (the reference class) is specified in the model setting GLMS_REFERENCE_CLASS_NAME. See <a href="#">Table 36-18</a>.</p> <p>For Linear Regression, class is null.</p>
attribute_name	<p>The attribute name when there is no subname, or first part of the attribute name when there is a subname. The value of attribute_name is also the name of the column in the case table that is the source for this attribute.</p> <p>For the intercept, attribute_name is null. Intercepts are equivalent to the bias term in SVM models.</p>
attribute_subname	<p>The name of an attribute in a nested table. The full name of a nested attribute has the form:</p> <p><i>attribute_name.attribute_subname</i></p> <p>where <i>attribute_name</i> is the name of the nested column in the case table that is the source for this attribute.</p> <p>If the attribute is not nested, then attribute_subname is null. If the attribute is an intercept, then both the attribute_name and the attribute_subname are null.</p>

**Table 36-86 (Cont.) DM\_GLM\_COEFF Datatype Description**

Column	Description
<code>attribute_value</code>	The value of the attribute (categorical attribute only). For numeric attributes, <code>attribute_value</code> is null.
<code>feature_expression</code>	The feature name constructed by the algorithm when feature generation is enabled and higher-order features are found. If feature selection is not enabled, then the feature name is simply the fully-qualified attribute name ( <code>attribute_name.attribute_subname</code> if the attribute is in a nested column). For categorical attributes, the algorithm constructs a feature name that has the following form: <i>fully-qualified_attribute_name.attribute_value</i> For numeric attributes, the algorithm constructs a name for the higher-order feature by taking the product of the resulting values: <i>(attrib1)*(attrib2)*.....</i> where <i>attrib1</i> and <i>attrib2</i> are fully-qualified attribute names.
<code>coefficient</code>	The linear coefficient estimate.
<code>std_error</code>	Standard error of the coefficient estimate.
<code>test_statistic</code>	For Linear Regression, the t-value of the coefficient estimate. For Logistic Regression, the Wald chi-square value of the coefficient estimate.
<code>p-value</code>	Probability of the <code>test_statistic</code> . Used to analyze the significance of specific attributes in the model.
VIF	Variance Inflation Factor. The value is zero for the intercept. For Logistic Regression, VIF is null. VIF is not computed if the solver is Cholesky.
<code>std_coefficient</code>	Standardized estimate of the coefficient.
<code>lower_coeff_limit</code>	Lower confidence bound of the coefficient.
<code>upper_coeff_limit</code>	Upper confidence bound of the coefficient.
<code>exp_coefficient</code>	Exponentiated coefficient for Logistic Regression. For Linear Regression, <code>exp_coefficient</code> is null.
<code>exp_lower_coeff_limit</code>	Exponentiated coefficient for lower confidence bound of the coefficient for Logistic Regression. For Linear Regression, <code>exp_lower_coeff_limit</code> is null.
<code>exp_upper_coeff_limit</code>	Exponentiated coefficient for upper confidence bound of the coefficient for Logistic Regression. For Linear Regression, <code>exp_lower_coeff_limit</code> is null.

**Usage Notes**

Not all statistics are necessarily returned for each coefficient. Statistics will be null if:

- They do not apply to the mining function. For example, `exp_coefficient` does not apply to Linear Regression.
- They cannot be computed from a theoretical standpoint. For information on ridge regression, see [Table 36-18](#).
- They cannot be computed because of limitations in system resources.

- Their values would be infinity.
- When the value is NULL for a partitioned model, an exception is thrown. When the value is not null, it must contain the desired partition name.

### Examples

The following example returns some of the model details for the GLM Regression model GLMR\_SH\_Regr\_sample, which was created by the sample program dmglrdem.sql. For information about the sample programs, see *Oracle Data Mining User's Guide*.

```
SET line 120
SET pages 99
column attribute_name format a30
column attribute_subname format a20
column attribute_value format a20
col coefficient format 990.9999
col std_error format 990.9999
SQL> SELECT * FROM
(SELECT attribute_name, attribute_value, coefficient, std_error
 FROM DM$VDGLMR_SH_REGR_SAMPLE order by 1,2)
WHERE rownum < 11;
```

ATTRIBUTE_NAME	ATTRIBUTE_VALUE	COEFFICIENT	STD_ERROR
AFFINITY_CARD		-0.5797	0.5283
BOOKKEEPING_APPLICATION		-0.4689	3.8872
BULK_PACK_DISKETTES		-0.9819	2.5430
COUNTRY_NAME	Argentina	-1.2020	1.1876
COUNTRY_NAME	Australia	-0.0071	5.1146
COUNTRY_NAME	Brazil	5.2931	1.9233
COUNTRY_NAME	Canada	4.0191	2.4108
COUNTRY_NAME	China	0.8706	3.5889
COUNTRY_NAME	Denmark	-2.9822	3.1803
COUNTRY_NAME	France	-1.1044	7.1811

### Related Topics

- *Oracle Data Mining User's Guide*

## 36.1.5.28 GET\_MODEL\_DETAILS\_GLOBAL Function

The GET\_MODEL\_DETAILS\_GLOBAL function returns statistics about the model as a whole. Starting from Oracle Database 12c Release 2, this function is deprecated. See "Model Detail Views" in *Oracle Data Mining User's Guide*.

Global details are available for Generalized Linear Models, Association Rules, Singular Value Decomposition, and Expectation Maximization. There are new Global model views which show global information for all algorithms. Oracle recommends that users leverage the views instead. Refer to Model Details View Global.

### Syntax

```
DBMS_DATA_MINING.get_model_details_global(
    model_name IN VARCHAR2,
    partition_name IN VARCHAR2 DEFAULT NULL)
RETURN DM_model_global_details PIPELINED;
```

## Parameters

**Table 36-87 GET\_MODEL\_DETAILS\_GLOBAL Function Parameters**

Parameter	Description
model_name	Name of the model in the form [schema_name.]model_name. If you do not specify a schema, then your own schema is used.
partition_name	Specifies a partition in a partitioned model.

## Return Values

**Table 36-88 GET\_MODEL\_DETAILS\_GLOBAL Function Return Values**

Return Value	Description
DM_MODEL_GLOBAL_DETAILS	A collection of rows of type DM_MODEL_GLOBAL_DETAIL. The rows have the following columns:  (global_detail_name VARCHAR2(30), global_detail_value NUMBER)

## Examples

The following example returns the global model details for the GLM Regression model GLMR\_SH\_Regr\_sample, which was created by the sample program dmglrdem.sql. For information about the sample programs, see *Oracle Data Mining User's Guide*.

```
SELECT *
  FROM TABLE(dbms_data_mining.get_model_details_global(
              'GLMR_SH_Regr_sample'))
ORDER BY global_detail_name;
GLOBAL_DETAIL_NAME          GLOBAL_DETAIL_VALUE
-----
ADJUSTED_R_SQUARE          .731412557
AIC                        5931.814
COEFF_VAR                  18.1711243
CORRECTED_TOTAL_DF        1499
CORRECTED_TOT_SS          278740.504
DEPENDENT_MEAN             38.892
ERROR_DF                   1433
ERROR_MEAN_SQUARE          49.9440956
ERROR_SUM_SQUARES          71569.8891
F_VALUE                    62.8492452
GMSEP                      52.280819
HOCKING_SP                 .034877162
J_P                        52.1749319
MODEL_CONVERGED            1
MODEL_DF                   66
MODEL_F_P_VALUE            0
MODEL_MEAN_SQUARE          3138.94871
MODEL_SUM_SQUARES          207170.615
NUM_PARAMS                 67
NUM_ROWS                   1500
ROOT_MEAN_SQ               7.06711367
R_SQ                       .743238288
SBIC                       6287.79977
VALID_COVARIANCE_MATRIX    1
```



**Related Topics**

- *Oracle Data Mining User's Guide*

**36.1.5.29 GET\_MODEL\_DETAILS\_KM Function**

The `GET_MODEL_DETAILS_KM` function returns a set of rows that provide the details of a *k*-Means clustering model. Starting from Oracle Database 12c Release 2, this function is deprecated. See "Model Detail Views" in *Oracle Data Mining User's Guide*.

You can provide input to `GET_MODEL_DETAILS_KM` to request specific information about the model, thus improving the performance of the query. If you do not specify filtering parameters, then `GET_MODEL_DETAILS_KM` returns all the information about the model.

**Syntax**

```
DBMS_DATA_MINING.get_model_details_km(
    model_name VARCHAR2,
    cluster_id NUMBER    DEFAULT NULL,
    attribute  VARCHAR2  DEFAULT NULL,
    centroid  NUMBER    DEFAULT 1,
    histogram NUMBER    DEFAULT 1,
    rules     NUMBER    DEFAULT 2,
    attribute_subname VARCHAR2 DEFAULT NULL,
    topn_attributes NUMBER DEFAULT NULL,
    partition_name VARCHAR2 DEFAULT NULL)
RETURN dm_clusters PIPELINED;
```

**Parameters****Table 36-89 GET\_MODEL\_DETAILS\_KM Function Parameters**

Parameter	Description
<code>model_name</code>	Name of the model in the form <code>[schema_name.]model_name</code> . If you do not specify a schema, then your own schema is used.
<code>cluster_id</code>	The ID of a cluster in the model. When a valid cluster ID is specified, only the details of this cluster are returned. Otherwise the details for all clusters are returned.
<code>attribute</code>	The name of an attribute. When a valid attribute name is specified, only the details of this attribute are returned. Otherwise, the details for all attributes are returned.
<code>centroid</code>	This parameter accepts the following values: <ul style="list-style-type: none"> <li>• 1: Details about centroids are returned (default)</li> <li>• 0: Details about centroids are not returned</li> </ul>
<code>histogram</code>	This parameter accepts the following values: <ul style="list-style-type: none"> <li>• 1: Details about histograms are returned (default)</li> <li>• 0: Details about histograms are not returned</li> </ul>
<code>rules</code>	This parameter accepts the following values: <ul style="list-style-type: none"> <li>• 2: Details about rules are returned (default)</li> <li>• 1: Rule summaries are returned</li> <li>• 0: No information about rules is returned</li> </ul>

**Table 36-89 (Cont.) GET\_MODEL\_DETAILS\_KM Function Parameters**

Parameter	Description
attribute_subname	The name of a nested attribute. The full name of a nested attribute has the form: <i>attribute_name.attribute_subname</i> where <i>attribute_name</i> is the name of the column and <i>attribute_subname</i> is the name of the nested attribute in that column. If the attribute is not nested, <i>attribute_subname</i> is null.
topn_attributes	Restricts the number of attributes returned in the centroid, histogram, and rules objects. Only the <i>n</i> attributes with the highest confidence values in the rules are returned. If the number of attributes included in the rules is less than <i>topn</i> , then up to <i>n</i> additional attributes in alphabetical order are returned. If both the <i>attribute</i> and <i>topn_attributes</i> parameters are specified, then <i>topn_attributes</i> is ignored.
partition_name	Specifies a partition in a partitioned model.

### Usage Notes

1. The table function pipes out rows of type `DM_CLUSTERS`. For information on Data Mining datatypes and Return Value for Clustering Algorithms piped output from table functions, see "Datatypes".
2. When the value is NULL for a partitioned model, an exception is thrown. When the value is not null, it must contain the desired partition name.

### Examples

The following example returns model details for the *k*-Means clustering model `KM_SH_Clus_sample`, which was created by the sample program `dmkmdemo.sql`. For information about the sample programs, see *Oracle Data Mining User's Guide*.

```
SELECT T.id          clu_id,
       T.record_count rec_cnt,
       T.parent      parent,
       T.tree_level  tree_level,
       T.dispersion  dispersion
FROM (SELECT *
      FROM TABLE(DBMS_DATA_MINING.GET_MODEL_DETAILS_KM(
                  'KM_SH_Clus_sample'))
      ORDER BY id) T
WHERE ROWNUM < 6;
```

CLU_ID	REC_CNT	PARENT	TREE_LEVEL	DISPERSION
1	1500			1 5.9152211
2	638	1		2 3.98458982
3	862	1		2 5.83732097
4	376	3		3 5.05192137
5	486	3		3 5.42901522

### Related Topics

- *Oracle Data Mining User's Guide*

### 36.1.5.30 GET\_MODEL\_DETAILS\_NB Function

The `GET_MODEL_DETAILS_NB` function returns a set of rows that provide the details of a Naive Bayes model. Starting from Oracle Database 12c Release 2, this function is deprecated. See "Model Detail Views" in *Oracle Data Mining User's Guide*.

#### Syntax

```
DBMS_DATA_MINING.get_model_details_nb(
    model_name IN VARCHAR2,
    partition_name IN VARCHAR2 DEFAULT NULL)
RETURN DM_NB_Details PIPELINED;
```

#### Parameters

**Table 36-90 GET\_MODEL\_DETAILS\_NB Function Parameters**

Parameter	Description
<code>model_name</code>	Name of the model in the form <code>[schema_name.]model_name</code> . If you do not specify a schema, then your own schema is used.
<code>partition_name</code>	Specifies a partition in a partitioned model

#### Return Values

**Table 36-91 GET\_MODEL\_DETAILS\_NB Function Return Values**

Return Value	Description																				
<code>DM_NB_DETAILS</code>	<p>A set of rows of type <code>DM_NB_DETAIL</code>. The rows have the following columns:</p> <table border="0"> <tr> <td><code>target_attribute_name</code></td> <td><code>VARCHAR2(30)</code>,</td> </tr> <tr> <td><code>target_attribute_str_value</code></td> <td><code>VARCHAR2(4000)</code>,</td> </tr> <tr> <td><code>target_attribute_num_value</code></td> <td><code>NUMBER</code>,</td> </tr> <tr> <td><code>prior_probability</code></td> <td><code>NUMBER</code>,</td> </tr> <tr> <td><code>conditionals</code></td> <td><code>DM_CONDITIONALS</code>)</td> </tr> </table> <p>The <code>conditionals</code> column of <code>DM_NB_DETAIL</code> returns a nested table of type <code>DM_CONDITIONALS</code>. The rows, of type <code>DM_CONDITIONAL</code>, have the following columns:</p> <table border="0"> <tr> <td><code>attribute_name</code></td> <td><code>VARCHAR2(4000)</code>,</td> </tr> <tr> <td><code>attribute_subname</code></td> <td><code>VARCHAR2(4000)</code>,</td> </tr> <tr> <td><code>attribute_str_value</code></td> <td><code>VARCHAR2(4000)</code>,</td> </tr> <tr> <td><code>attribute_num_value</code></td> <td><code>NUMBER</code>,</td> </tr> <tr> <td><code>conditional_probability</code></td> <td><code>NUMBER</code>)</td> </tr> </table>	<code>target_attribute_name</code>	<code>VARCHAR2(30)</code> ,	<code>target_attribute_str_value</code>	<code>VARCHAR2(4000)</code> ,	<code>target_attribute_num_value</code>	<code>NUMBER</code> ,	<code>prior_probability</code>	<code>NUMBER</code> ,	<code>conditionals</code>	<code>DM_CONDITIONALS</code> )	<code>attribute_name</code>	<code>VARCHAR2(4000)</code> ,	<code>attribute_subname</code>	<code>VARCHAR2(4000)</code> ,	<code>attribute_str_value</code>	<code>VARCHAR2(4000)</code> ,	<code>attribute_num_value</code>	<code>NUMBER</code> ,	<code>conditional_probability</code>	<code>NUMBER</code> )
<code>target_attribute_name</code>	<code>VARCHAR2(30)</code> ,																				
<code>target_attribute_str_value</code>	<code>VARCHAR2(4000)</code> ,																				
<code>target_attribute_num_value</code>	<code>NUMBER</code> ,																				
<code>prior_probability</code>	<code>NUMBER</code> ,																				
<code>conditionals</code>	<code>DM_CONDITIONALS</code> )																				
<code>attribute_name</code>	<code>VARCHAR2(4000)</code> ,																				
<code>attribute_subname</code>	<code>VARCHAR2(4000)</code> ,																				
<code>attribute_str_value</code>	<code>VARCHAR2(4000)</code> ,																				
<code>attribute_num_value</code>	<code>NUMBER</code> ,																				
<code>conditional_probability</code>	<code>NUMBER</code> )																				

#### Usage Notes

- The table function pipes out rows of type `DM_NB_DETAILS`. For information on Data Mining datatypes and piped output from table functions, see "Datatypes".
- When the value is `NULL` for a partitioned model, an exception is thrown. When the value is not null, it must contain the desired partition name.

## Examples

The following query is from the sample program `dmnbdemo.sql`. It returns model details about the model `NB_SH_Clas_sample`. For information about the sample programs, see *Oracle Data Mining User's Guide*.

The query creates labels from the bin boundary tables that were used to bin the training data. It replaces the attribute values with the labels. For numeric bins, the labels are `(lower_boundary,upper_boundary]`; for categorical bins, the label matches the value it represents. (This method of categorical label representation will only work for cases where one value corresponds to one bin.) The target was not binned.

```
WITH
  bin_label_view AS (
    SELECT col, bin, (DECODE(bin,'1','[','(') || lv || ',' || val || ']') label
      FROM (SELECT col,
                  bin,
                  LAST_VALUE(val) OVER (
                    PARTITION BY col ORDER BY val
                    ROWS BETWEEN UNBOUNDED PRECEDING AND 1 PRECEDING) lv,
                  val
             FROM nb_sh_sample_num)
    UNION ALL
    SELECT col, bin, val label
      FROM nb_sh_sample_cat
  ),
  model_details AS (
    SELECT T.target_attribute_name                                tname,
           NVL(TO_CHAR(T.target_attribute_num_value,T.target_attribute_str_value)) tval,
           C.attribute_name                                       pname,
           NVL(L.label, NVL(C.attribute_str_value, C.attribute_num_value)) pval,
           T.prior_probability                                    priorp,
           C.conditional_probability                             condp
      FROM TABLE(DBMS_DATA_MINING.GET_MODEL_DETAILS_NB('NB_SH_Clas_sample')) T,
           TABLE(T.conditionals) C,
           bin_label_view L
    WHERE C.attribute_name = L.col (+) AND
           (NVL(C.attribute_str_value,C.attribute_num_value) = L.bin(+))
    ORDER BY 1,2,3,4,5,6
  )
  SELECT tname, tval, pname, pval, priorp, condp
     FROM model_details
    WHERE ROWNUM < 11;
```

TNAME	TVAL	PNAME	PVAL	PRIORP	CONDP
AFFINITY_CARD	0	AGE	(24,30]	.6500	.1714
AFFINITY_CARD	0	AGE	(30,35]	.6500	.1509
AFFINITY_CARD	0	AGE	(35,40]	.6500	.1125
AFFINITY_CARD	0	AGE	(40,46]	.6500	.1134
AFFINITY_CARD	0	AGE	(46,53]	.6500	.1071
AFFINITY_CARD	0	AGE	(53,90]	.6500	.1312
AFFINITY_CARD	0	AGE	[17,24]	.6500	.2134
AFFINITY_CARD	0	BOOKKEEPING_APPLICATION	0	.6500	.1500
AFFINITY_CARD	0	BOOKKEEPING_APPLICATION	1	.6500	.8500
AFFINITY_CARD	0	BULK_PACK_DISKETTES	0	.6500	.3670

## Related Topics

- [Oracle Data Mining User's Guide](#)

### 36.1.5.31 GET\_MODEL\_DETAILS\_NMF Function

The `GET_MODEL_DETAILS_NMF` function returns a set of rows that provide the details of a Non-Negative Matrix Factorization model. Starting from Oracle Database 12c Release 2, this function is deprecated. See "Model Detail Views" in *Oracle Data Mining User's Guide*.

#### Syntax

```
DBMS_DATA_MINING.get_model_details_nmf(
    model_name IN VARCHAR2,
    partition_name VARCHAR2 DEFAULT NULL)
RETURN DM_NMF_Feature_Set PIPELINED;
```

#### Parameters

**Table 36-92 GET\_MODEL\_DETAILS\_NMF Function Parameters**

Parameter	Description
<code>model_name</code>	Name of the model in the form <code>[schema_name.]model_name</code> . If you do not specify a schema, then your own schema is used.
<code>partition_name</code>	Specifies a partition in a partitioned model

#### Return Values

**Table 36-93 GET\_MODEL\_DETAILS\_NMF Function Return Values**

Return Value	Description
<code>DM_NMF_FEATURE_SET</code>	<p>A set of rows of <code>DM_NMF_FEATURE</code>. The rows have the following columns:</p> <pre>(feature_id          NUMBER,  mapped_feature_id   VARCHAR2(4000),  attribute_set       DM_NMF_ATTRIBUTE_SET)</pre> <p>The <code>attribute_set</code> column of <code>DM_NMF_FEATURE</code> returns a nested table of type <code>DM_NMF_ATTRIBUTE_SET</code>. The rows, of type <code>DM_NMF_ATTRIBUTE</code>, have the following columns:</p> <pre>(attribute_name      VARCHAR2(4000),  attribute_subname   VARCHAR2(4000),  attribute_value     VARCHAR2(4000),  coefficient         NUMBER)</pre>

#### Usage Notes

- The table function pipes out rows of type `DM_NMF_FEATURE_SET`. For information on Data Mining datatypes and piped output from table functions, see "Datatypes".
- When the value is NULL for a partitioned model, an exception is thrown. When the value is not null, it must contain the desired partition name.

#### Examples

The following example returns model details for the feature extraction model `NMF_SH_Sample`, which was created by the sample program `dmnmdemo.sql`. For information about the sample programs, see *Oracle Data Mining User's Guide*.

```

SELECT * FROM (
SELECT F.feature_id,
      A.attribute_name,
      A.attribute_value,
      A.coefficient
  FROM TABLE(DBMS_DATA_MINING.GET_MODEL_DETAILS_NMF('NMF_SH_Sample')) F,
       TABLE(F.attribute_set) A
 ORDER BY feature_id,attribute_name,attribute_value
) WHERE ROWNUM < 11;

```

FEATURE_ID	ATTRIBUTE_NAME	ATTRIBUTE_VALUE	COEFFICIENT
1	AFFINITY_CARD		.051208078859308
1	AGE		.0390513260041573
1	BOOKKEEPING_APPLICATION		.0512734004239326
1	BULK_PACK_DISKETTES		.232471260895683
1	COUNTRY_NAME	Argentina	.00766817464479959
1	COUNTRY_NAME	Australia	.000157637881096675
1	COUNTRY_NAME	Brazil	.0031409632415604
1	COUNTRY_NAME	Canada	.00144213099311427
1	COUNTRY_NAME	China	.000102279310968754
1	COUNTRY_NAME	Denmark	.000242424084307513

### Related Topics

- *Oracle Data Mining User's Guide*

## 36.1.5.32 GET\_MODEL\_DETAILS\_OC Function

The `GET_MODEL_DETAILS_OC` function returns a set of rows that provide the details of an O-Cluster clustering model. The rows are an enumeration of the Clustering patterns generated during the creation of the model. Starting from Oracle Database 12c Release 2, this function is deprecated. See "Model Detail Views" in *Oracle Data Mining User's Guide*.

You can provide input to `GET_MODEL_DETAILS_OC` to request specific information about the model, thus improving the performance of the query. If you do not specify filtering parameters, then `GET_MODEL_DETAILS_OC` returns all the information about the model.

### Syntax

```

DBMS_DATA_MINING.get_model_details_oc(
  model_name VARCHAR2,
  cluster_id NUMBER DEFAULT NULL,
  attribute VARCHAR2 DEFAULT NULL,
  centroid NUMBER DEFAULT 1,
  histogram NUMBER DEFAULT 1,
  rules NUMBER DEFAULT 2,
  topn_attributes NUMBER DEFAULT NULL,
  partition_name VARCHAR2 DEFAULT NULL)
RETURN dm_clusters PIPELINED;

```

### Parameters

**Table 36-94** GET\_MODEL\_DETAILS\_OC Function Parameters

Parameter	Description
model_name	Name of the model in the form <code>[schema_name.]model_name</code> . If you do not specify a schema, then your own schema is used.

**Table 36-94 (Cont.) GET\_MODEL\_DETAILS\_OC Function Parameters**

Parameter	Description
cluster_id	The ID of a cluster in the model. When a valid cluster ID is specified, only the details of this cluster are returned. Otherwise the details for all clusters are returned.
attribute	The name of an attribute. When a valid attribute name is specified, only the details of this attribute are returned. Otherwise, the details for all attributes are returned
centroid	This parameter accepts the following values: <ul style="list-style-type: none"> <li>• 1: Details about centroids are returned (default)</li> <li>• 0: Details about centroids are not returned</li> </ul>
histogram	This parameter accepts the following values: <ul style="list-style-type: none"> <li>• 1: Details about histograms are returned (default)</li> <li>• 0: Details about histograms are not returned</li> </ul>
rules	This parameter accepts the following values: <ul style="list-style-type: none"> <li>• 2: Details about rules are returned (default)</li> <li>• 1: Rule summaries are returned</li> <li>• 0: No information about rules is returned</li> </ul>
topn_attributes	Restricts the number of attributes returned in the centroid, histogram, and rules objects. Only the <i>n</i> attributes with the highest confidence values in the rules are returned.  If the number of attributes included in the rules is less than <i>topn</i> , then up to <i>n</i> additional attributes in alphabetical order are returned.  If both the <code>attribute</code> and <code>topn_attributes</code> parameters are specified, then <code>topn_attributes</code> is ignored.
partition_name	Specifies a partition in a partitioned model.

### Usage Notes

1. For information about Data Mining datatypes and Return Values for Clustering Algorithms piped output from table functions, see "[Datatypes](#)".
2. When the value is NULL for a partitioned model, an exception is thrown. When the value is not null, it must contain the desired partition name.

### Examples

The following example returns model details for the clustering model `OC_SH_Clus_sample`, which was created by the sample program `dmocdemo.sql`. For information about the sample programs, see *Oracle Data Mining User's Guide*.

For each cluster in this example, the `split predicate` indicates the attribute and the condition used to assign records to the cluster's children during model build. It provides an important piece of information on how the population within a cluster can be divided up into two smaller clusters.

```
SELECT clu_id, attribute_name, op, s_value
       FROM (SELECT a.id clu_id, sp.attribute_name, sp.conditional_operator op,
                   sp.attribute_str_value s_value
              FROM TABLE(DBMS_DATA_MINING.GET_MODEL_DETAILS_OC(
                           'OC_SH_Clus_sample')) a,
                   TABLE(a.split_predicate) sp
              ORDER BY a.id, op, s_value)
```

WHERE ROWNUM < 11;

CLU_ID	ATTRIBUTE_NAME	OP	S_VALUE
1	OCCUPATION	IN	?
1	OCCUPATION	IN	Armed-F
1	OCCUPATION	IN	Cleric.
1	OCCUPATION	IN	Crafts
2	OCCUPATION	IN	?
2	OCCUPATION	IN	Armed-F
2	OCCUPATION	IN	Cleric.
3	OCCUPATION	IN	Exec.
3	OCCUPATION	IN	Farming
3	OCCUPATION	IN	Handler

### Related Topics

- [Oracle Data Mining User's Guide](#)

## 36.1.5.33 GET\_MODEL\_SETTINGS Function

The `GET_MODEL_SETTINGS` function returns the settings used to build the given model. Starting from Oracle Database 12c Release 2, this function is deprecated. See "Static Data Dictionary Views: ALL\_ALL\_TABLES to ALL\_OUTLINES" in *Oracle Database Reference*.

### Syntax

```
FUNCTION get_model_settings(model_name IN VARCHAR2)
RETURN DM_Model_Settings PIPELINED;
```

### Parameters

**Table 36-95 GET\_MODEL\_SETTINGS Function Parameters**

Parameter	Description
model_name	Name of the model in the form [schema_name.]model_name. If you do not specify a schema, then your own schema is used.

### Return Values

**Table 36-96 GET\_MODEL\_SETTINGS Function Return Values**

Return Value	Description								
DM_MODEL_SETTINGS	A set of rows of type <code>DM_MODEL_SETTINGS</code> . The rows have the following columns:  <table border="1"> <thead> <tr> <th colspan="2">DM_MODEL_SETTINGS TABLE OF SYS.DM_MODEL_SETTING</th> </tr> <tr> <th>Name</th> <th>Type</th> </tr> </thead> <tbody> <tr><td>SETTING_NAME</td><td>VARCHAR2 (30)</td></tr> <tr><td>SETTING_VALUE</td><td>VARCHAR2 (4000)</td></tr> </tbody> </table>	DM_MODEL_SETTINGS TABLE OF SYS.DM_MODEL_SETTING		Name	Type	SETTING_NAME	VARCHAR2 (30)	SETTING_VALUE	VARCHAR2 (4000)
DM_MODEL_SETTINGS TABLE OF SYS.DM_MODEL_SETTING									
Name	Type								
SETTING_NAME	VARCHAR2 (30)								
SETTING_VALUE	VARCHAR2 (4000)								



## Usage Notes

1. This table function pipes out rows of type `DM_MODEL_SETTINGS`. For information on Data Mining datatypes and piped output from table functions, see "[DBMS\\_DATA\\_MINING Datatypes](#)".
2. The setting names/values include both those specified by the user and any defaults assigned by the build process.

## Examples

The following example returns model settings for an example Naive Bayes model.

SETTING_NAME	SETTING_VALUE
ALGO_NAME	ALGO_NAIVE_BAYES
PREP_AUTO	ON
ODMS_MAX_PARTITIONS	1000
NABS_SINGLETON_THRESHOLD	0
CLAS_WEIGHTS_BALANCED	OFF
NABS_PAIRWISE_THRESHOLD	0
ODMS_PARTITION_COLUMNS	GENDER,Y_BOX_GAMES
ODMS_MISSING_VALUE_TREATMENT	ODMS_MISSING_VALUE_AUTO
ODMS_SAMPLING	ODMS_SAMPLING_DISABLE

9 rows selected.

## Related Topics

- [Oracle Database Reference](#)

## 36.1.5.34 GET\_MODEL\_SIGNATURE Function

The `GET_MODEL_SIGNATURE` function returns the list of columns from the build input table that were used by the build process to train the model. Starting from Oracle Database 12c Release 2, this function is deprecated. See "Static Data Dictionary Views: `ALL_ALL_TABLES` to `ALL_OUTLINES`" in *Oracle Database Reference*.

## Syntax

```
FUNCTION get_model_signature (model_name IN VARCHAR2)
RETURN DM_Model_Signature PIPELINED;
```

## Parameters

**Table 36-97 GET\_MODEL\_SIGNATURE Function Parameters**

Parameter	Description
<code>model_name</code>	Name of the model in the form <code>[schema_name.]model_name</code> . If you do not specify a schema, then your own schema is used.

## Return Values

**Table 36-98 GET\_MODEL\_SIGNATURE Function Return Values**

Return Value	Description
DM_MODEL_SIGNATURE	<p>A set of rows of type DM_MODEL_SIGNATURE. The rows have the following columns:</p> <pre> DM_MODEL_SIGNATURE TABLE OF SYS.DM_MODEL_SIGNATURE_ATTRIBUTE       Name                               Type ----- ATTRIBUTE_NAME                          VARCHAR2(130) ATTRIBUTE_TYPE                           VARCHAR2(106) </pre>

## Usage Notes

1. This table function pipes out rows of type DM\_MODEL\_SIGNATURE. For information on Data Mining datatypes and piped output from table functions, see "[DBMS\\_DATA\\_MINING Datatypes](#)".
2. The signature names or types include only those attributes used by the build process.

## Examples

The following example returns model settings for an example Naive Bayes model.

```

ATTRIBUTE_NAME          ATTRIBUTE_TYPE
-----
AGE                     NUMBER
ANNUAL_INCOME           NUMBER
AVERAGE_ITEMS_PURCHASED NUMBER
BOOKKEEPING_APPLICATION NUMBER
BULK_PACK_DISKETTES    NUMBER
BULK_PURCH_AVE_AMT     NUMBER
DISABLE_COOKIES        NUMBER
EDUCATION               VARCHAR2
FLAT_PANEL_MONITOR     NUMBER
GENDER                  VARCHAR2
HOME_THEATER_PACKAGE   NUMBER
HOUSEHOLD_SIZE         VARCHAR2
MAILING_LIST           NUMBER
MARITAL_STATUS         VARCHAR2
NO_DIFFERENT_KIND_ITEMS NUMBER
OCCUPATION             VARCHAR2
OS_DOC_SET_KANJI       NUMBER
PETS                   NUMBER
PRINTER_SUPPLIES       NUMBER
PROMO_RESPOND          NUMBER
SHIPPING_ADDRESS_COUNTRY VARCHAR2
SR_CITIZEN             NUMBER
TOP_REASON_FOR_SHOPPING VARCHAR2
WKS_SINCE_LAST_PURCH   NUMBER
WORKCLASS              VARCHAR2
YRS_RESIDENCE          NUMBER
Y_BOX_GAMES            NUMBER

```

27 rows selected.

**Related Topics**

- [Oracle Database Reference](#)

**36.1.5.35 GET\_MODEL\_DETAILS\_SVD Function**

The `GET_MODEL_DETAILS_SVD` function returns a set of rows that provide the details of a Singular Value Decomposition model. Oracle recommends to use model details view settings. Starting from Oracle Database 12c Release 2, this function is deprecated. See "Model Detail Views" in *Oracle Data Mining User's Guide*.

Refer to Model Details View for Singular Value Decomposition.

**Syntax**

```
DBMS_DATA_MINING.get_model_details_svd(
    model_name IN VARCHAR2,
    matrix_type IN VARCHAR2 DEFAULT NULL,
    partition_name VARCHAR2 DEFAULT NULL)
RETURN DM_SVD_MATRIX_Set PIPELINED;
```

**Parameters****Table 36-99 GET\_MODEL\_DETAILS\_SVD Function Parameters**

Parameter	Description
<code>model_name</code>	Name of the model in the form [ <i>schema_name</i> ]. <i>model_name</i> . If you do not specify a schema, then your own schema is used.
<code>matrix_type</code>	Specifies which of the three SVD matrix types to return. Values are: U, S, V, and NULL. When <code>matrix_type</code> is null (default), all matrices are returned.  The U matrix is only computed when the <code>SVDS_U_MATRIX_OUTPUT</code> setting is enabled. It is not computed by default. If the model does not contain U matrices and you set <code>matrix_type</code> to U, an empty set of rows is returned. See <a href="#">Table 36-26</a> .
<code>partition_name</code>	A partition in a partitioned model.

**Return Values****Table 36-100 GET\_MODEL\_DETAILS\_SVD Function Return Values**

Return Value	Description																		
<code>DM_SVD_MATRIX_SET</code>	A set of rows of type <code>DM_SVD_MATRIX</code> . The rows have the following columns:  <table border="0"> <tr> <td><code>(matrix_type</code></td> <td><code>CHAR(1),</code></td> </tr> <tr> <td><code>feature_id</code></td> <td><code>NUMBER,</code></td> </tr> <tr> <td><code>mapped_feature_id</code></td> <td><code>VARCHAR2(4000),</code></td> </tr> <tr> <td><code>attribute_name</code></td> <td><code>VARCHAR2(4000),</code></td> </tr> <tr> <td><code>attribute_subname</code></td> <td><code>VARCHAR2(4000),</code></td> </tr> <tr> <td><code>case_id</code></td> <td><code>VARCHAR2(4000),</code></td> </tr> <tr> <td><code>value</code></td> <td><code>NUMBER,</code></td> </tr> <tr> <td><code>variance</code></td> <td><code>NUMBER,</code></td> </tr> <tr> <td><code>pct_cum_variance</code></td> <td><code>NUMBER)</code></td> </tr> </table> <p>See Usage Notes for details.</p>	<code>(matrix_type</code>	<code>CHAR(1),</code>	<code>feature_id</code>	<code>NUMBER,</code>	<code>mapped_feature_id</code>	<code>VARCHAR2(4000),</code>	<code>attribute_name</code>	<code>VARCHAR2(4000),</code>	<code>attribute_subname</code>	<code>VARCHAR2(4000),</code>	<code>case_id</code>	<code>VARCHAR2(4000),</code>	<code>value</code>	<code>NUMBER,</code>	<code>variance</code>	<code>NUMBER,</code>	<code>pct_cum_variance</code>	<code>NUMBER)</code>
<code>(matrix_type</code>	<code>CHAR(1),</code>																		
<code>feature_id</code>	<code>NUMBER,</code>																		
<code>mapped_feature_id</code>	<code>VARCHAR2(4000),</code>																		
<code>attribute_name</code>	<code>VARCHAR2(4000),</code>																		
<code>attribute_subname</code>	<code>VARCHAR2(4000),</code>																		
<code>case_id</code>	<code>VARCHAR2(4000),</code>																		
<code>value</code>	<code>NUMBER,</code>																		
<code>variance</code>	<code>NUMBER,</code>																		
<code>pct_cum_variance</code>	<code>NUMBER)</code>																		

## Usage Notes

1. This table function pipes out rows of type `DM_SVD_MATRIX`. For information on Data Mining datatypes and piped output from table functions, see "Datatypes".

The columns in each row returned by `GET_MODEL_DETAILS_SVD` are described as follows:

Column in <code>DM_SVD_MATRIX_SET</code>	Description
<code>matrix_type</code>	The type of matrix. Possible values are <b>S</b> , <b>V</b> , and <b>U</b> . This field is never null.
<code>feature_id</code>	The feature that the matrix entry refers to.
<code>mapped_feature_id</code>	A descriptive name for the feature.
<code>attribute_name</code>	Column name in the <b>V</b> matrix component bases. This field is null for the <b>S</b> and <b>U</b> matrices.
<code>attribute_subname</code>	Subname in the <b>V</b> matrix component bases. This is relevant only in the case of a nested column. This field is null for the <b>S</b> and <b>U</b> matrices.
<code>case_id</code>	Unique identifier of the row in the build data described by the <b>U</b> matrix projection. This field is null for the <b>S</b> and <b>V</b> matrices.
<code>value</code>	The matrix entry value.
<code>variance</code>	The variance explained by a component. It is non-null only for <b>S</b> matrix entries. This column is non-null only for <b>S</b> matrix entries and for SVD models with setting <code>dbms_data_mining.svds_scoring_mode</code> set to <code>dbms_data_mining.svds_scoring_pca</code> and the build data is centered, either manually or because the setting <code>dbms_data_mining.prep_auto</code> is set to <code>dbms_data_mining.prep_auto_on</code> .
<code>pct_cum_variance</code>	The percent cumulative variance explained by the components thus far. The components are ranked by the explained variance in descending order.  This column is non-null only for <b>S</b> matrix entries and for SVD models with setting <code>dbms_data_mining.svds_scoring_mode</code> set to <code>dbms_data_mining.svds_scoring_pca</code> and the build data is centered, either manually or because the setting <code>dbms_data_mining.prep_auto</code> is set to <code>dbms_data_mining.prep_auto_on</code> .

2. The output of `GET_MODEL_DETAILS` is in sparse format. Zero values are not returned. Only the diagonal elements of the **S** matrix, the non-zero coefficients in the **V** matrix bases, and the non-zero **U** matrix projections are returned.

There is one exception: If the data row does not produce non-zero **U** Matrix projections, the case ID for that row is returned with `NULL` for the `feature_id` and `value`. This is done to avoid losing any records from the original data.

3. `GET_MODEL_DETAILS` functions preserve model transparency by automatically reversing the transformations applied during the build process. Thus the attributes returned in the model details are the original attributes (or a close approximation of the original attributes) used to build the model.
4. When the value is `NULL` for a partitioned model, an exception is thrown. When the value is not null, it must contain the preferred partition name.

**Related Topics**

- *Oracle Data Mining User's Guide*

**36.1.5.36 GET\_MODEL\_DETAILS\_SVM Function**

The `GET_MODEL_DETAILS_SVM` function returns a set of rows that provide the details of a linear Support Vector Machine (SVM) model. If invoked for nonlinear SVM, it returns ORA-40215. Starting from Oracle Database 12c Release 2, this function is deprecated. See "Model Detail Views" in *Oracle Data Mining User's Guide*.

In linear SVM models, only nonzero coefficients are stored. This reduces storage and speeds up model loading. As a result, if an attribute is missing in the coefficient list returned by `GET_MODEL_DETAILS_SVM`, then the coefficient of this attribute should be interpreted as zero.

**Syntax**

```
DBMS_DATA_MINING.get_model_details_svm(
    model_name    VARCHAR2,
    reverse_coef  NUMBER DEFAULT 0,
    partition_name VARCHAR2 DEFAULT NULL)
RETURN DM_SVM_Linear_Coeff_Set PIPELINED;
```

**Parameters****Table 36-101 GET\_MODEL\_DETAILS\_SVM Function Parameters**

Parameter	Description
<code>model_name</code>	Name of the model in the form [ <i>schema_name</i> .] <i>model_name</i> . If you do not specify a schema, then your own schema is used.
<code>reverse_coef</code>	Whether or not <code>GET_MODEL_DETAILS_SVM</code> should transform the attribute coefficients using the original attribute transformations. When <code>reverse_coef</code> is set to 0 (default), <code>GET_MODEL_DETAILS_SVM</code> returns the coefficients directly from the model without applying transformations. When <code>reverse_coef</code> is set to 1, <code>GET_MODEL_DETAILS_SVM</code> transforms the coefficients and bias by applying the normalization shifts and scales that were generated using automatic data preparation. See Usage Note 4.
<code>partition_name</code>	Specifies a partition in a partitioned model.

## Return Values

Table 36-102 GET\_MODEL\_DETAILS\_SVM Function Return Values

Return Value	Description
DM_SVM_LINEAR_COEFF_SET	<p>A set of rows of type DM_SVM_LINEAR_COEFF. The rows have the following columns:</p> <pre>(class          VARCHAR2(4000),  attribute_set   DM_SVM_ATTRIBUTE_SET)</pre> <p>The attribute_set column returns a nested table of type DM_SVM_ATTRIBUTE_SET. The rows, of type DM_SVM_ATTRIBUTE, have the following columns:</p> <pre>(attribute_name  VARCHAR2(4000),  attribute_subname VARCHAR2(4000),  attribute_value  VARCHAR2(4000),  coefficient      NUMBER)</pre> <p>See Usage Notes.</p>

## Usage Notes

1. This table function pipes out rows of type DM\_SVM\_LINEAR\_COEFF. For information on Data Mining datatypes and piped output from table functions, see "Datatypes".
2. The class column of DM\_SVM\_LINEAR\_COEFF contains Classification target values. For SVM Regression models, class is null. For each Classification target value, a set of coefficients is returned. For Binary Classification, one-class Classification, and Regression models, only a single set of coefficients is returned.
3. The attribute\_value column in DM\_SVM\_ATTRIBUTE\_SET is used for categorical attributes.
4. GET\_MODEL\_DETAILS functions preserve model transparency by automatically reversing the transformations applied during the build process. Thus the attributes returned in the model details are the original attributes (or a close approximation of the original attributes) used to build the model.

The coefficients are related to the transformed, not the original, attributes. When returned directly with the model details, the coefficients may not provide meaningful information. If you want GET\_MODEL\_DETAILS\_SVM to transform the coefficients such that they relate to the original attributes, set the reverse\_coef parameter to 1.

5. When the value is NULL for a partitioned model, an exception is thrown. When the value is not null, it must contain the desired partition name.

## Examples

The following example returns model details for the SVM Classification model SVMC\_SH\_Clas\_sample, which was created by the sample program dmsvcDEM.sql. For information about the sample programs, see *Oracle Data Mining User's Guide*.

```
WITH
  mod_dtls AS (
    SELECT *
      FROM TABLE(DBMS_DATA_MINING.GET_MODEL_DETAILS_SVM('SVMC_SH_Clas_sample'))
  ),
  model_details AS (
```

```

SELECT D.class, A.attribute_name, A.attribute_value, A.coefficient
FROM mod_dtls D,
     TABLE(D.attribute_set) A
ORDER BY D.class, ABS(A.coefficient) DESC
)
SELECT class, attribute_name aname, attribute_value aval, coefficient coeff
FROM model_details
WHERE ROWNUM < 11;

```

CLASS	ANAME	AVAL	COEFF
1			-2.85
1	BOOKKEEPING_APPLICATION		1.11
1	OCCUPATION	Other	-.94
1	HOUSEHOLD_SIZE	4-5	.88
1	CUST_MARITAL_STATUS	Married	.82
1	YRS_RESIDENCE		.76
1	HOUSEHOLD_SIZE	6-8	-.74
1	OCCUPATION	Exec.	.71
1	EDUCATION	11th	-.71
1	EDUCATION	Masters	.63

### Related Topics

- *Oracle Data Mining User's Guide*

## 36.1.5.37 GET\_MODEL\_DETAILS\_XML Function

This function returns an XML object that provides the details of a Decision Tree model.

### Syntax

```

DBMS_DATA_MINING.get_model_details_xml(
    model_name IN VARCHAR2,
    partition_name IN VARCHAR2 DEFAULT NULL)
RETURN XMLType;

```

### Parameters

**Table 36-103** GET\_MODEL\_DETAILS\_XML Function Parameters

Parameter	Description
model_name	Name of the model in the form [schema_name.]model_name. If you do not specify a schema, then your own schema is used.
partition_name	Specifies a partition in a partitioned model.

## Return Values

Table 36-104 GET\_MODEL\_DETAILS\_XML Function Return Value

Return Value	Description
XMLTYPE	<p>The XML definition for the Decision Tree model. See "XMLTYPE" for details. The XML definition conforms to the Data Mining Group Predictive Model Markup Language (PMML) version 2.1 specification. The specification is available at <a href="http://www.dmg.org">http://www.dmg.org</a>.</p> <p>If a nested attribute is used as a splitter, the attribute will appear in the XML document as field="&lt;column_name&gt;.&lt;subname&gt;", as opposed to the non-nested attributes which appear in the document as field="&lt;column_name&gt;".</p>

 **Note:**

The column names are surrounded by single quotes and a period separates the column\_name from the subname.

The rest of the document style remains unchanged.

## Usage Notes

Special characters that cannot be displayed by Oracle XML are converted to '#'.

## Examples

The following statements in SQL\*Plus return the details of the Decision Tree model `dt_sh_clas_sample`. This model is created by the program `dmdtdemo.sql`, one of the sample data mining programs provided with Oracle Database Examples.

Note: The "&quot;" characters you will see in the XML output are a result of SQL\*Plus behavior. To display the XML in proper format, cut and past it into a file and open the file in a browser.

```
column dt_details format a320
SELECT
  dbms_data_mining.get_model_details_xml('dt_sh_clas_sample')
  AS DT_DETAILS
FROM dual;

DT_DETAILS
-----
<PMML version="2.1">
  <Header copyright="Copyright (c) 2004, Oracle Corporation. All rights
    reserved."/>
  <DataDictionary numberOfFields="9">
    <DataField name="AFFINITY_CARD" optype="categorical"/>
    <DataField name="AGE" optype="continuous"/>
    <DataField name="BOOKKEEPING_APPLICATION" optype="continuous"/>
    <DataField name="CUST_MARITAL_STATUS" optype="categorical"/>
    <DataField name="EDUCATION" optype="categorical"/>
    <DataField name="HOUSEHOLD_SIZE" optype="categorical"/>
    <DataField name="OCCUPATION" optype="categorical"/>
    <DataField name="YRS_RESIDENCE" optype="continuous"/>
    <DataField name="Y_BOX_GAMES" optype="continuous"/>
```



```

</DataDictionary>
<TreeModel modelName="DT_SH_CLAS_SAMPLE" functionName="classification"
  splitCharacteristic="binarySplit">
  <Extension name="buildSettings">
    <Setting name="TREE_IMPURITY_METRIC" value="TREE_IMPURITY_GINI"/>
    <Setting name="TREE_TERM_MAX_DEPTH" value="7"/>
    <Setting name="TREE_TERM_MINPCT_NODE" value=".05"/>
    <Setting name="TREE_TERM_MINPCT_SPLIT" value=".1"/>
    <Setting name="TREE_TERM_MINREC_NODE" value="10"/>
    <Setting name="TREE_TERM_MINREC_SPLIT" value="20"/>
    <costMatrix>
      <costElement>
        <actualValue>0</actualValue>
        <predictedValue>0</predictedValue>
        <cost>0</cost>
      </costElement>
      <costElement>
        <actualValue>0</actualValue>
        <predictedValue>1</predictedValue>
        <cost>1</cost>
      </costElement>
      <costElement>
        <actualValue>1</actualValue>
        <predictedValue>0</predictedValue>
        <cost>8</cost>
      </costElement>
      <costElement>
        <actualValue>1</actualValue>
        <predictedValue>1</predictedValue>
        <cost>0</cost>
      </costElement>
    </costMatrix>
  </Extension>
  <MiningSchema>
    .
    .
    .
    .
    .
  </Node>
</Node>
</TreeModel>
</PMML>

```

**Related Topics**

- [Oracle Database PL/SQL Packages and Types Reference](#)

### 36.1.5.38 GET\_MODEL\_TRANSFORMATIONS Function

This function returns the transformation expressions embedded in the specified model. Starting from Oracle Database 12c Release 2, this function is deprecated. See "Static Data Dictionary Views: ALL\_ALL\_TABLES to ALL\_OUTLINES" in *Oracle Database Reference*.

All GET\_\* interfaces are replaced by model views, and Oracle recommends that users reference the model views to retrieve the relevant information. The GET\_MODEL\_TRANSFORMATIONS function is replaced by the following:

- USER/(DBA/ALL)\_MINING\_MODEL\_XFORMS: provides the user-embedded transformations

- DM\$VX prefixed model view: provides text feature extraction information
- D\$VN prefixed mode view: provides normalization and missing value information
- DM\$VB: provides binning information

#### See Also:

"About Transformation Lists" in [DBMS\\_DATA\\_MINING\\_TRANSFORM Operational Notes](#)

"GET\_TRANSFORM\_LIST Procedure"

"CREATE\_MODEL Procedure"

"ALL\_MINING\_MODEL\_XFORMS" in *Oracle Database Reference*

"DBA\_MINING\_MODEL\_XFORMS" in *Oracle Database Reference*

"USER\_MINING\_MODEL\_XFORMS" in *Oracle Database Reference*

Model Details View for Binning

Normalization and Missing Value Handling

Data Preparation for Text Features

## Syntax

```
DBMS_DATA_MINING.get_model_transformations(
    model_name IN VARCHAR2,
    partition_name IN VARCHAR2 DEFAULT NULL)
RETURN DM_Transforms PIPELINED;
```

## Parameters

**Table 36-105 GET\_MODEL\_TRANSFORMATIONS Function Parameters**

Parameter	Description
model_name	Indicates the name of the model in the form [schema_name.]model_name. If you do not specify a schema, then your own schema is used.
partition_name	Specifies a partition in a partitioned model

## Return Values

**Table 36-106 GET\_MODEL\_TRANSFORMATIONS Function Return Value**

Return Value	Description								
DM_TRANSFORMS	<p>The transformation expressions embedded in <i>model_name</i>.</p> <p>The DM_TRANSFORMS type is a table of DM_TRANSFORM objects. Each DM_TRANSFORM has these fields:</p> <table> <tbody> <tr> <td>attribute_name</td> <td>VARCHAR2(4000)</td> </tr> <tr> <td>attribute_subname</td> <td>VARCHAR2(4000)</td> </tr> <tr> <td>expression</td> <td>CLOB</td> </tr> <tr> <td>reverse_expression</td> <td>CLOB</td> </tr> </tbody> </table>	attribute_name	VARCHAR2(4000)	attribute_subname	VARCHAR2(4000)	expression	CLOB	reverse_expression	CLOB
attribute_name	VARCHAR2(4000)								
attribute_subname	VARCHAR2(4000)								
expression	CLOB								
reverse_expression	CLOB								

## Usage Notes

When Automatic Data Preparation (ADP) is enabled, both automatic and user-defined transformations may be associated with an attribute. In this case, the user-defined transformations are evaluated before the automatic transformations.

When invoked for a partitioned model, the *partition\_name* parameter must be specified.

## Examples

In this example, several columns in the SH.CUSTOMERS table are used to create a Naive Bayes model. A transformation expression is specified for one of the columns. The model does not use ADP.

```
CREATE OR REPLACE VIEW mining_data AS
  SELECT cust_id, cust_year_of_birth, cust_income_level, cust_credit_limit
  FROM sh.customers;
```

```
describe mining_data
```

Name	Null?	Type
CUST_ID	NOT NULL	NUMBER
CUST_YEAR_OF_BIRTH	NOT NULL	NUMBER(4)
CUST_INCOME_LEVEL		VARCHAR2(30)
CUST_CREDIT_LIMIT		NUMBER

```
CREATE TABLE settings_nb(
  setting_name VARCHAR2(30),
  setting_value VARCHAR2(30));
BEGIN
  INSERT INTO settings_nb (setting_name, setting_value) VALUES
    (dbms_data_mining.algo_name, dbms_data_mining.algo_naive_bayes);
  INSERT INTO settings_nb (setting_name, setting_value) VALUES
    (dbms_data_mining.prep_auto, dbms_data_mining.prep_auto_off);
  COMMIT;
END;
/
DECLARE
  mining_data_xforms dbms_data_mining_transform.TRANSFORM_LIST;
BEGIN
  dbms_data_mining_transform.SET_TRANSFORM (
    xform_list      => mining_data_xforms,
    attribute_name  => 'cust_year_of_birth',
    attribute_subname => null,
```

```

        expression          => 'cust_year_of_birth + 10',
        reverse_expression => 'cust_year_of_birth - 10');
dbms_data_mining.CREATE_MODEL (
  model_name           => 'new_model',
  mining_function      => dbms_data_mining.classification,
  data_table_name     => 'mining_data',
  case_id_column_name => 'cust_id',
  target_column_name  => 'cust_income_level',
  settings_table_name => 'settings_nb',
  data_schema_name    => null,
  settings_schema_name => null,
  xform_list          => mining_data_xforms );
END;
/
SELECT attribute_name, TO_CHAR(expression), TO_CHAR(reverse_expression)
       FROM TABLE (dbms_data_mining.GET_MODEL_TRANSFORMATIONS('new_model'));

ATTRIBUTE_NAME      TO_CHAR(EXPRESSION)      TO_CHAR(REVERSE_EXPRESSION)
-----
CUST_YEAR_OF_BIRTH  cust_year_of_birth + 10    cust_year_of_birth - 10

```

### Related Topics

- [Oracle Database Reference](#)

## 36.1.5.39 GET\_TRANSFORM\_LIST Procedure

This procedure converts transformation expressions specified as `DM_TRANSFORMS` to a transformation list (`TRANSFORM_LIST`) that can be used in creating a model. `DM_TRANSFORMS` is returned by the `GET_MODEL_TRANSFORMATIONS` function.

You can also use routines in the `DBMS_DATA_MINING_TRANSFORM` package to construct a transformation list.



### See Also:

- "About Transformation Lists" in [DBMS\\_DATA\\_MINING\\_TRANSFORM](#)
- "[GET\\_MODEL\\_TRANSFORMATIONS](#) Function"
- "[CREATE\\_MODEL](#) Procedure"

### Syntax

```

DBMS_DATA_MINING.GET_TRANSFORM_LIST (
  xform_list          OUT NOCOPY TRANSFORM_LIST,
  model_xforms        IN  DM_TRANSFORMS);

```

## Parameters

**Table 36-107 GET\_TRANSFORM\_LIST Procedure Parameters**

Parameter	Description										
<code>xform_list</code>	<p>A list of transformation specifications that can be embedded in a model. Accepted as a parameter to the <a href="#">CREATE_MODEL Procedure</a>.</p> <p>The <code>TRANSFORM_LIST</code> type is a table of <code>TRANSFORM_REC</code> objects. Each <code>TRANSFORM_REC</code> has these fields:</p> <table> <tr> <td><code>attribute_name</code></td> <td><code>VARCHAR2(30)</code></td> </tr> <tr> <td><code>attribute_subname</code></td> <td><code>VARCHAR2(4000)</code></td> </tr> <tr> <td><code>expression</code></td> <td><code>EXPRESSION_REC</code></td> </tr> <tr> <td><code>reverse_expression</code></td> <td><code>EXPRESSION_REC</code></td> </tr> <tr> <td><code>attribute_spec</code></td> <td><code>VARCHAR2(4000)</code></td> </tr> </table> <p>For details about the <code>TRANSFORM_LIST</code> collection type, see <a href="#">Table 36-114</a>.</p>	<code>attribute_name</code>	<code>VARCHAR2(30)</code>	<code>attribute_subname</code>	<code>VARCHAR2(4000)</code>	<code>expression</code>	<code>EXPRESSION_REC</code>	<code>reverse_expression</code>	<code>EXPRESSION_REC</code>	<code>attribute_spec</code>	<code>VARCHAR2(4000)</code>
<code>attribute_name</code>	<code>VARCHAR2(30)</code>										
<code>attribute_subname</code>	<code>VARCHAR2(4000)</code>										
<code>expression</code>	<code>EXPRESSION_REC</code>										
<code>reverse_expression</code>	<code>EXPRESSION_REC</code>										
<code>attribute_spec</code>	<code>VARCHAR2(4000)</code>										
<code>model_xforms</code>	<p>A list of embedded transformation expressions returned by the <a href="#">GET_MODEL_TRANSFORMATIONS Function</a> for a specific model.</p> <p>The <code>DM_TRANSFORMS</code> type is a table of <code>DM_TRANSFORM</code> objects. Each <code>DM_TRANSFORM</code> has these fields:</p> <table> <tr> <td><code>attribute_name</code></td> <td><code>VARCHAR2(4000)</code></td> </tr> <tr> <td><code>attribute_subname</code></td> <td><code>VARCHAR2(4000)</code></td> </tr> <tr> <td><code>expression</code></td> <td><code>CLOB</code></td> </tr> <tr> <td><code>reverse_expression</code></td> <td><code>CLOB</code></td> </tr> </table>	<code>attribute_name</code>	<code>VARCHAR2(4000)</code>	<code>attribute_subname</code>	<code>VARCHAR2(4000)</code>	<code>expression</code>	<code>CLOB</code>	<code>reverse_expression</code>	<code>CLOB</code>		
<code>attribute_name</code>	<code>VARCHAR2(4000)</code>										
<code>attribute_subname</code>	<code>VARCHAR2(4000)</code>										
<code>expression</code>	<code>CLOB</code>										
<code>reverse_expression</code>	<code>CLOB</code>										

## Examples

In this example, a model `mod1` is trained using several columns in the `SH.CUSTOMERS` table. The model uses ADP, which automatically bins one of the columns.

A second model `mod2` is trained on the same data without ADP, but it uses a transformation list that was obtained from `mod1`. As a result, both `mod1` and `mod2` have the same embedded transformation expression.

```
CREATE OR REPLACE VIEW mining_data AS
  SELECT cust_id, cust_year_of_birth, cust_income_level, cust_credit_limit
  FROM sh.customers;

describe mining_data
Name                                     Null?    Type
-----
CUST_ID                                 NOT NULL NUMBER
CUST_YEAR_OF_BIRTH                       NOT NULL NUMBER(4)
CUST_INCOME_LEVEL                         VARCHAR2(30)
CUST_CREDIT_LIMIT                          NUMBER

CREATE TABLE setmod1(setting_name VARCHAR2(30),setting_value VARCHAR2(30));
BEGIN
  INSERT INTO setmod1 VALUES (dbms_data_mining.algo_name, dbms_data_mining.algo_naive_bayes);
  INSERT INTO setmod1 VALUES (dbms_data_mining.prep_auto,dbms_data_mining.prep_auto_on);
  dbms_data_mining.CREATE_MODEL (
    model_name           => 'mod1',
    mining_function      => dbms_data_mining.classification,
    data_table_name     => 'mining_data',
    case_id_column_name => 'cust_id',
```

```
        target_column_name => 'cust_income_level',
        settings_table_name => 'setmod1');
COMMIT;
END;
/
CREATE TABLE setmod2(setting_name VARCHAR2(30),setting_value VARCHAR2(30));
BEGIN
    INSERT INTO setmod2
        VALUES (dbms_data_mining.algo_name, dbms_data_mining.algo_naive_bayes);
COMMIT;
END;
/
DECLARE
    v_xform_list    dbms_data_mining_transform.TRANSFORM_LIST;
    dmx             DM_TRANSFORMS;
BEGIN
    EXECUTE IMMEDIATE
        'SELECT dm_transform(attribute_name, attribute_subname,expression, reverse_expression)
        FROM TABLE(dbms_data_mining.GET_MODEL_TRANSFORMATIONS (''mod1''))'
        BULK COLLECT INTO dmx;
    dbms_data_mining.GET_TRANSFORM_LIST (
        xform_list => v_xform_list,
        model_xforms => dmx);
    dbms_data_mining.CREATE_MODEL(
        model_name => 'mod2',
        mining_function => dbms_data_mining.classification,
        data_table_name => 'mining_data',
        case_id_column_name => 'cust_id',
        target_column_name => 'cust_income_level',
        settings_table_name => 'setmod2',
        xform_list => v_xform_list);
END;
/

-- Transformation expression embedded in mod1
SELECT TO_CHAR(expression) FROM TABLE (dbms_data_mining.GET_MODEL_TRANSFORMATIONS('mod1'));

TO_CHAR(EXPRESSION)
-----
CASE WHEN "CUST_YEAR_OF_BIRTH"<1915 THEN 0 WHEN "CUST_YEAR_OF_BIRTH"<=1915 THEN 0
WHEN "CUST_YEAR_OF_BIRTH"<=1920.5 THEN 1 WHEN "CUST_YEAR_OF_BIRTH"<=1924.5 THEN 2
.
.
.
.5 THEN 29 WHEN "CUST_YEAR_OF_BIRTH" IS NOT NULL THEN 30 END

-- Transformation expression embedded in mod2
SELECT TO_CHAR(expression) FROM TABLE (dbms_data_mining.GET_MODEL_TRANSFORMATIONS('mod2'));

TO_CHAR(EXPRESSION)
-----
CASE WHEN "CUST_YEAR_OF_BIRTH"<1915 THEN 0 WHEN "CUST_YEAR_OF_BIRTH"<=1915 THEN 0
WHEN "CUST_YEAR_OF_BIRTH"<=1920.5 THEN 1 WHEN "CUST_YEAR_OF_BIRTH"<=1924.5 THEN 2
.
.
.
.5 THEN 29 WHEN "CUST_YEAR_OF_BIRTH" IS NOT NULL THEN 30 END

-- Reverse transformation expression embedded in mod1
SELECT TO_CHAR(reverse_expression) FROM TABLE (dbms_data_mining.GET_MODEL_TRANSFORMATIONS('mod1'));

TO_CHAR(REVERSE_EXPRESSION)
```

```

-----
DECODE("CUST_YEAR_OF_BIRTH",0,'( ; 1915), [1915; 1915]',1,'(1915; 1920.5]',2,'(1
920.5; 1924.5]',3,'(1924.5; 1928.5]',4,'(1928.5; 1932.5]',5,'(1932.5; 1936.5]',6
.
.
.
8,'(1987.5; 1988.5]',29,'(1988.5; 1989.5]',30,'(1989.5; )',NULL,'NULL')

-- Reverse transformation expression embedded in mod2
SELECT TO_CHAR(reverse_expression) FROM TABLE (dbms_data_mining.GET_MODEL_TRANSFORMATIONS('mod2'));

TO_CHAR(REVERSE_EXPRESSION)
-----
DECODE("CUST_YEAR_OF_BIRTH",0,'( ; 1915), [1915; 1915]',1,'(1915; 1920.5]',2,'(1
920.5; 1924.5]',3,'(1924.5; 1928.5]',4,'(1928.5; 1932.5]',5,'(1932.5; 1936.5]',6
.
.
.
8,'(1987.5; 1988.5]',29,'(1988.5; 1989.5]',30,'(1989.5; )',NULL,'NULL')

```

### 36.1.5.40 IMPORT\_MODEL Procedure

This procedure imports one or more data mining models. The procedure is overloaded. You can call it to import mining models from a dump file set, or you can call it to import a single mining model from a PMML document.

#### Import from a dump file set

You can import mining models from a dump file set that was created by the [EXPORT\\_MODEL Procedure](#). `IMPORT_MODEL` and `EXPORT_MODEL` use Oracle Data Pump technology to export to and import from a dump file set.

When Oracle Data Pump is used directly to export/import an entire schema or database, the mining models in the schema or database are included. `EXPORT_MODEL` and `IMPORT_MODEL` export/import mining models only.

#### Import from PMML

You can import a mining model represented in Predictive Model Markup Language (PMML). The model must be of type `RegressionModel`, either linear regression or binary logistic regression.

PMML is an XML-based standard specified by the Data Mining Group (<http://www.dmg.org>). Applications that are PMML-compliant can deploy PMML-compliant models that were created by any vendor. Oracle Data Mining supports the core features of PMML 3.1 for regression models.

#### See Also:

*Oracle Data Mining User's Guide* for more information about exporting and importing mining models

*Oracle Database Utilities* for information about Oracle Data Pump

<http://www.dmg.org/faq.html> for more information about PMML

## Syntax

Imports a mining model from a dump file set:

```

DBMS_DATA_MINING.IMPORT_MODEL (
    filename          IN  VARCHAR2,
    directory         IN  VARCHAR2,
    model_filter      IN  VARCHAR2 DEFAULT NULL,
    operation         IN  VARCHAR2 DEFAULT NULL,
    remote_link       IN  VARCHAR2 DEFAULT NULL,
    jobname           IN  VARCHAR2 DEFAULT NULL,
    schema_remap      IN  VARCHAR2 DEFAULT NULL,
    tablespace_remap IN  VARCHAR2 DEFAULT NULL);

```

Imports a mining model from a PMML document:

```

DBMS_DATA_MINING.IMPORT_MODEL (
    model_name        IN  VARCHAR2,
    pmmldoc           IN  XMLTYPE,
    strict_check      IN  BOOLEAN DEFAULT FALSE);

```

## Parameters

**Table 36-108** IMPORT\_MODEL Procedure Parameters

Parameter	Description
filename	<p>Name of the dump file set from which the models should be imported. The dump file set must have been created by the EXPORT_MODEL procedure or the expdp export utility of Oracle Data Pump.</p> <p>The dump file set can contain one or more files. (Refer to "EXPORT_MODEL Procedure" for details.) If the dump file set contains multiple files, you can specify <code>'filename%U'</code> instead of listing them. For example, if your dump file set contains 3 files, <code>archive01.dmp</code>, <code>archive02.dmp</code>, and <code>archive03.dmp</code>, you can import them by specifying <code>'archive%U'</code>.</p>
directory	<p>Name of a pre-defined directory object that specifies where the dump file set is located. Both the exporting and the importing user must have read/write access to the directory object and to the file system directory that it identifies.</p> <p>Note: The target database must have also have read/write access to the file system directory.</p>
model_filter	<p>Optional parameter that specifies one or more models to import. If you do not specify a value for <code>model_filter</code>, all models in the dump file set are imported. You can also specify <code>NULL</code> (the default) or <code>'ALL'</code> to import all models.</p> <p>The value of <code>model_filter</code> can be one or more model names. The following are valid filters.</p> <pre>'mymodel1'</pre> <pre>'name IN ('mymodel2','mymodel3')'</pre> <p>The first causes <code>IMPORT_MODEL</code> to import a single model named <code>mymodel1</code>. The second causes <code>IMPORT_MODEL</code> to import two models, <code>mymodel2</code> and <code>mymodel3</code>.</p>
operation	<p>Optional parameter that specifies whether to import the models or the SQL statements that create the models. By default, the models are imported.</p> <p>You can specify either of the following values for <code>operation</code>:</p> <ul style="list-style-type: none"> <li>'IMPORT' — Import the models (Default)</li> <li>'SQL_FILE' — Write the SQL DDL for creating the models to a text file. The text file is named <code>job_name.sql</code> and is located in the dump set directory.</li> </ul>



**Table 36-108 (Cont.) IMPORT\_MODEL Procedure Parameters**

Parameter	Description
<code>remote_link</code>	Optional parameter that specifies the name of a database link to a remote system. The default value is <code>NULL</code> . A database link is a schema object in a local database that enables access to objects in a remote database. When you specify a value for <code>remote_link</code> , you can import models into the local database from the remote database. The import is fileless; no dump file is involved. The <code>IMP_FULL_DATABASE</code> role is required for importing the remote models. The <code>EXP_FULL_DATABASE</code> privilege, the <code>CREATE DATABASE LINK</code> privilege, and other privileges may also be required. (See Example 2.)
<code>jobname</code>	Optional parameter that specifies the name of the import job. By default, the name has the form <code>username_imp_nnnn</code> , where <code>nnnn</code> is a number. For example, a job name in the <code>SCOTT</code> schema might be <code>SCOTT_imp_134</code> .  If you specify a job name, it must be unique within the schema. The maximum length of the job name is 30 characters.  A log file for the import job, named <code>jobname.log</code> , is created in the same directory as the dump file set.
<code>schema_remap</code>	Optional parameter for importing into a different schema. By default, models are exported and imported within the same schema.  If the dump file set belongs to a different schema, you must specify a schema mapping in the form <code>export_user:import_user</code> . For example, you would specify <code>'SCOTT:MARY'</code> to import a model exported by <code>SCOTT</code> into the <code>MARY</code> schema.  Note: In some cases, you may need to have the <code>IMP_FULL_DATABASE</code> privilege or the <code>SYS</code> role to import a model from a different schema.
<code>tablespace_remap</code>	Optional parameter for importing into a different tablespace. By default, models are exported and imported within the same tablespace.  If the dump file set belongs to a different tablespace, you must specify a tablespace mapping in the form <code>export_tablespace:import_tablespace</code> . For example, you would specify <code>'TBLSPC01:TBLSPC02'</code> to import a model that was exported from tablespace <code>TBLSPC01</code> into tablespace <code>TBLSPC02</code> .  Note: In some cases, you may need to have the <code>IMP_FULL_DATABASE</code> privilege or the <code>SYS</code> role to import a model from a different tablespace.
<code>model_name</code>	Name for the new model that will be created in the database as a result of an import from PMML. The name must be unique within the user's schema.
<code>pmmlidoc</code>	The PMML document representing the model to be imported. The PMML document has an <code>XMLTYPE</code> object type. See "XMLTYPE" for details.
<code>strict_check</code>	Whether or not an error occurs when the PMML document contains sections that are not part of core PMML (for example, Output or Targets). Oracle Data Mining supports only core PMML; any non-core features may affect the scoring representation.  If the PMML does not strictly conform to core PMML and <code>strict_check</code> is set to <code>TRUE</code> , then <code>IMPORT_MODEL</code> returns an error. If <code>strict_check</code> is <code>FALSE</code> (the default), then the error is suppressed. The model may be imported and scored.

### Examples

1. This example shows a model being exported and imported within the schema `dmuser2`. Then the same model is imported into the `dmuser3` schema. The `dmuser3` user has the `IMP_FULL_DATABASE` privilege. The `dmuser2` user has been assigned the `USER2` tablespace; `dmuser3` has been assigned the `USER3` tablespace.

```

SQL> connect dmuser2
Enter password: dmuser2_password
Connected.
SQL> select model_name from user_mining_models;

MODEL_NAME
-----
NMF_SH_SAMPLE
SVMO_SH_CLAS_SAMPLE
SVMR_SH_REGR_SAMPLE

-- export the model called NMF_SH_SAMPLE to a dump file in same schema
SQL>EXECUTE DBMS_DATA_MINING.EXPORT_MODEL (
    filename =>'NMF_SH_SAMPLE_out',
    directory =>'DATA_PUMP_DIR',
    model_filter => 'name = 'NMF_SH_SAMPLE''');

-- import the model back into the same schema
SQL>EXECUTE DBMS_DATA_MINING.IMPORT_MODEL (
    filename => 'NMF_SH_SAMPLE_out01.dmp',
    directory => 'DATA_PUMP_DIR',
    model_filter => 'name = 'NMF_SH_SAMPLE''');

-- connect as different user
-- import same model into that schema
SQL> connect dmuser3
Enter password: dmuser3_password
Connected.
SQL>EXECUTE DBMS_DATA_MINING.IMPORT_MODEL (
    filename => 'NMF_SH_SAMPLE_out01.dmp',
    directory => 'DATA_PUMP_DIR',
    model_filter => 'name = 'NMF_SH_SAMPLE'',
    operation =>'IMPORT',
    remote_link => NULL,
    jobname => 'nmf_imp_job',
    schema_remap => 'dmuser2:dmuser3',
    tablespace_remap => 'USER2:USER3');

```

The following example shows user MARY importing all models from a dump file, model\_exp\_001.dmp, which was created by user SCOTT. User MARY has been assigned a tablespace named USER2; user SCOTT was assigned the tablespace USERS when the models were exported into the dump file model\_exp\_001.dmp. The dump file is located in the file system directory mapped to a directory object called DM\_DUMP. If user MARY does not have IMP\_FULL\_DATABASE privileges, IMPORT\_MODEL will raise an error.

```

-- import all models
DECLARE
    file_name VARCHAR2(40);
BEGIN
    file_name := 'model_exp_001.dmp';
    DBMS_DATA_MINING.IMPORT_MODEL(
        filename=> 'file_name',
        directory=>'DM_DUMP',
        schema_remap=>'SCOTT:MARY',
        tablespace_remap=>'USERS:USER2');
    DBMS_OUTPUT.PUT_LINE(
        'DBMS_DATA_MINING.IMPORT_MODEL of all models from SCOTT done!');
END;
/

```

2. This example shows how the user `xuser` could import the model `dmuser.r1mod` from a remote database. The SQL\*Net connection alias for the remote database is `R1DB`. The user `xuser` is assigned the `SYS_AUX` tablespace; the user `dmuser` is assigned the `TBS_1` tablespace.

```
CONNECT / AS SYSDBA;
GRANT CREATE DATABASE LINK TO xuser;
GRANT imp_full_database TO xuser;
CONNECT xuser/xuserpassword
CREATE DATABASE LINK dmuser_link
    CONNECT TO dmuser IDENTIFIED BY dmuserpassword USING 'R1DB';
EXEC dbms_data_mining.import_model (
    NULL,
    'DMUSER_DIR',
    'R1MOD',
    remote_link => 'DMUSER_LINK', schema_remap => 'DMUSER:XUSER',
    tablespace_remap => 'TBS_1:SYS_AUX' );
SELECT name FROM dm_user_models;

NAME
-----
R1MOD
```

3. This example shows how a PMML document called `SamplePMML1.xml` could be imported from a location referenced by directory object `PMMLDIR` into the schema of the current user. The imported model will be called `PMMLMODEL1`.

```
BEGIN
    dbms_data_mining.import_model ('PMMLMODEL1',
        XMLType (bfilename ('PMMLDIR', 'SamplePMML1.xml'),
            nls_charset_id ('AL32UTF8')
        ));
END;
```

### Related Topics

- *Oracle Database PL/SQL Packages and Types Reference*

## 36.1.5.41 IMPORT\_SERMODEL Procedure

This procedure imports the serialized format of the model back into a database.

The import routine takes the serialized content in the `BLOB` and the name of the model to be created with the content. This import does not create model views or tables that are needed for querying model details. The import procedure only provides the ability to score the model.

### Syntax

```
DBMS_DATA_MINING.IMPORT_SERMODEL (
    model_data      IN BLOB,
    model_name      IN VARCHAR2,);
```

### Parameters

**Table 36-109** IMPORT\_SERMODEL Procedure Parameters

Parameter	Description
<code>model_data</code>	Provides model data in <code>BLOB</code> format.

**Table 36-109 (Cont.) IMPORT\_SERMODEL Procedure Parameters**

Parameter	Description
model_name	Name of the mining model in the form [ <i>schema_name</i> ]. <i>model_name</i> . If you do not specify a schema, then your own schema is used.

### Examples

The following statement imports the serialized format of the models.

```
declare
  v_blob blob;
BEGIN
  dbms_lob.createtemporary(v_blob, FALSE);
  -- fill in v_blob from somewhere (e.g., bfile, etc.)
  dbms_data_mining.import_sermodel(v_blob, 'MY_MODEL');
  dbms_lob.freetemporary(v_blob);
END;
/
```

### Related Topics

- [EXPORT\\_SERMODEL Procedure](#)  
This procedure exports the model in a serialized format so that they can be moved to another platform for scoring.

#### See Also:

*Oracle Data Mining User's Guide* for more information about exporting and importing mining models

## 36.1.5.42 JSON Schema for R Extensible Algorithm

Follow JSON schema when creating a new JSON object with flexibility.

### Usage Note

Some flexibility when creating a new JSON object are as follows:

- Partial registration is allowed. For example, detail function can be missing.
- Different orders are allowed. For example, detail function can be written before build function or after the build function.

### Example 36-1 JSON Schema

JSON schema 1.1 for R extensible algorithm:

```
{
  "type": "object",
  "properties": {
    "algo_name_display": { "type" : "object",
```

```

        "properties" : {
        "language" : { "type" :
"string",
"enum" : ["English", "Spanish", "French"],
"default" : "English"},
        "name" : { "type" : "string"}}
    },
    "function_language": {"type": "string" },
    "mining_function": {
        "type" : "array",
        "items" : [
            { "type" : "object",
                "properties" : {
                    "mining_function_name" : { "type" : "string"},
                    "build_function": {
                        "type": "object",
                        "properties": {
                            "function_body": { "type": "CLOB" }
                        }
                    }
                }
            },
            "detail_function": {
                "type" : "array",
                "items" : [
                    {"type": "object",
                        "properties": {
                            "function_body": { "type": "CLOB" },
                            "view_columns": { "type" : "array",
                                "items" : {
                                    "type" : "object",
                                    "properties" : {
                                        "name" : { "type" : "string"},
                                        "type" : { "type" : "string",
                                            "enum" : ["VARCHAR2",
                                                "NUMBER",
                                                "DATE",
                                                "BOOLEAN"]}
                                    }
                                }
                            }
                        }
                    }
                ]
            }
        ]
    },

```

```

    "score_function": {
      "type": "object",
      "properties": {
        "function_body": { "type": "CLOB" }
      }
    },
    "weight_function": {
      "type": "object",
      "properties": {
        "function_body": { "type": "CLOB" },
      }
    }
  }
}

  }
},

"algo_setting": {
  "type" : "array",
  "items" : [
    { "type" : "object",
      "properties" : {
        "name" : { "type" : "string"},
        "name_display": { "type" : "object",
          "properties" : {
            "language" :
{ "type" : "string",

      "enum" : ["English", "Spanish", "French"],

      "default" : "English"},

      "name" : { "type" :
"string"}}
          },
        "type" : { "type" : "string",
          "enum" : ["string", "integer",
"number", "boolean"]},

        "optional": {"type" : "BOOLEAN",
          "default" : "FALSE"},

        "value" : { "type" : "string"},

        "min_value" : { "type": "object",
          "properties": {
            "min_value":
{"type": "number"},

            "inclusive":
{ "type": "boolean",

      "default" : TRUE},

          }
        },
        "max_value" : {"type": "object",
          "properties": {
            "max_value":

```

```

{"type": "number"},
                                                                    "inclusive":
{ "type": "boolean",
  "default" : TRUE},
                                                                    }
                                                                    },
    "categorical choices" : { "type": "array",
                              "items": {
                                "type":
"string"
                                                                    }
                                                                    },
    "description_display": { "type" : "object",

"properties" : {
"language" : { "type" : "string",
               "enum" : ["English", "Spanish", "French"],
               "default" : "English"},
               "name" :
{ "type" : "string"}}
                                                                    }
                                                                    }
                                                                    ]
                                                                    }
                                                                    }
}

```

### Example 36-2 JSON object example

The following is an JSON object example that must be passed to the registration procedure:

```

{ "algo_name_display" : {"English", "t1"},
  "function_language" : "R",
  "mining_function" : {
    "mining_function_name" : "CLASSIFICATION",
    "build_function" : {"function_body": "function(dat,
formula, family)
{
                                                                    set.seed(1234);
                                                                    mod <- glm(formula = formula,
data=dat,
                                                                    family=
eval(parse(text=family))); mod}"),
    "score_function" : { "function_body": "function(mod, dat) {
                                                                    res <- predict(mod, newdata =
dat,
type='response
                                                                    ');
                                                                    res2=data.frame(1-res, res);

```

```

res2}}}}
    },
    "algo_setting" : [{"name"
"dbms_data_mining.odms_m
        "missing_value_treatment",
        "name_display" : {"English",
"dbms_data_mining.odms_missing_value
_treatment"},
        "type" : "string",
        "optional" : "TRUE",
        "value" :
"dbms_data_mining.odms_missing_value_mean_mode",
        "categorical_choices" :
[ "dbms_data_mining.odms_missing_value_mean_mode",
"dbms_data_mining.odms_missing_value_auto",
"dbms_data_mining.odms_missing_value_delete_row"],
        "description" : {"English",
"how to
treat missing values"}
    },
    {"name" : "RALG_PARAMETER_FAMILY",
"name_display" : {"English",
"RALG_PARAMETER_FAMILY"},
"type" : "string",
"optional" : "TRUE",
"value" : "",
"description" : {"English", "R family
parameter in build function"}
    }
],
}

```

### 36.1.5.43 REGISTER\_ALGORITHM Procedure

User can register a new algorithm by providing algorithm name, mining function, and all other algorithm metadata to this function.

#### Syntax

```

DBMS_DATA_MINING.REGISTER_ALGORITHM (
    algorithm_name          IN VARCHAR2,
    algorithm_metadata      IN CLOB,
    algorithm_description   IN VARCHAR2 DEFAULT NULL);

```



## Parameters

**Table 36-110 REGISTER\_ALGORITHM Procedure Parameters**

Parameter	Description
algorithm_name	Name of the algorithm.
algorithm_metadata	Metadata of the algorithm.
algorithm_description	Description of the algorithm.

## Usage Notes

The registration procedure performs the following:

- Checks whether `algorithm_metadata` has correct JSON syntax.
- Checks whether the input JSON object follows the predefined JSON schema.
- Checks whether current user has `RQADMIN` privilege.
- Checks duplicate algorithms such that the same algorithm is not registered twice.
- Checks for missing entries. For example, algorithm name, algorithm type, metadata, and build function.

## Register Algorithms After the JSON Object Is Created

SQL users can register new algorithms by following the given procedure:

Create a JSON object following JSON schema and pass it to `REGISTER_ALGORITHM` procedure.

```
BEGIN
  DBMS_DATA_MINING.register_algorithm(
    algorithm_name      => 't1',
    algorithm_metadata  =>
      '{"function_language" : "R",
       "mining_function" :
         { "mining_function_name" : "CLASSIFICATION",
           "build_function" : {"function_body": "function(dat, formula,
family) { set.seed(1234);
                                     mod <- glm(formula = formula,
data=dat,
family=eval(parse(text=family)));
mod}}",
           "score_function" : {"function_body": "function(mod, dat) {
                                     res <- predict(mod, newdata =
dat, type='response');
                                     res2=data.frame(1-res, res);
res2}}"}',
    algorithm_description => 't1');
END;
/
```

### 36.1.5.44 RANK\_APPLY Procedure

This procedure ranks the results of an `APPLY` operation based on a top-N specification for predictive and descriptive model results.

For classification models, you can provide a cost matrix as input, and obtain the ranked results with costs applied to the predictions.

#### Syntax

```
DBMS_DATA_MINING.RANK_APPLY (
    apply_result_table_name      IN VARCHAR2,
    case_id_column_name         IN VARCHAR2,
    score_column_name           IN VARCHAR2,
    score_criterion_column_name IN VARCHAR2,
    ranked_apply_table_name     IN VARCHAR2,
    top_N                       IN NUMBER (38) DEFAULT 1,
    cost_matrix_table_name      IN VARCHAR2   DEFAULT NULL,
    apply_result_schema_name    IN VARCHAR2   DEFAULT NULL,
    cost_matrix_schema_name     IN VARCHAR2   DEFAULT NULL);
```

#### Parameters

**Table 36-111 RANK\_APPLY Procedure Parameters**

Parameter	Description
<code>apply_result_table_name</code>	Name of the table or view containing the results of an <code>APPLY</code> operation on the test data set (see Usage Notes)
<code>case_id_column_name</code>	Name of the case identifier column. This must be the same as the one used for generating <code>APPLY</code> results.
<code>score_column_name</code>	Name of the prediction column in the apply results table
<code>score_criterion_column_name</code>	Name of the probability column in the apply results table
<code>ranked_apply_result_table_name</code>	Name of the table containing the ranked apply results
<code>top_N</code>	Top N predictions to be considered from the <code>APPLY</code> results for precision recall computation
<code>cost_matrix_table_name</code>	Name of the cost matrix table
<code>apply_result_schema_name</code>	Name of the schema hosting the <code>APPLY</code> results table
<code>cost_matrix_schema_name</code>	Name of the schema hosting the cost matrix table

#### Usage Notes

You can use `RANK_APPLY` to generate ranked apply results, based on a top-N filter and also with application of cost for predictions, if the model was built with costs.

The behavior of `RANK_APPLY` is similar to that of `APPLY` with respect to other DDL-like operations such as `CREATE_MODEL`, `DROP_MODEL`, and `RENAME_MODEL`. The procedure does not depend on the model; the only input of relevance is the apply results generated in a fixed schema table from `APPLY`.

The main intended use of `RANK_APPLY` is for the generation of the final `APPLY` results against the scoring data in a production setting. You can apply the model against test data using `APPLY`,

compute various test metrics against various cost matrix tables, and use the candidate cost matrix for RANK\_APPLY.

The schema for the apply results from each of the supported algorithms is listed in subsequent sections. The `case_id` column will be the same case identifier column as that of the apply results.

### Classification Models — NB and SVM

For numerical targets, the ranked results table will have the definition as shown:

```
(case_id      VARCHAR2/NUMBER,
prediction    NUMBER,
probability   NUMBER,
cost         NUMBER,
rank         INTEGER)
```

For categorical targets, the ranked results table will have the following definition:

```
(case_id      VARCHAR2/NUMBER,
prediction    VARCHAR2,
probability   NUMBER,
cost         NUMBER,
rank         INTEGER)
```

### Clustering Using *k*-Means or O-Cluster

Clustering is an unsupervised mining function, and hence there are no targets. The results of an APPLY operation contains simply the cluster identifier corresponding to a case, and the associated probability. Cost matrix is not considered here. The ranked results table will have the definition as shown, and contains the cluster ids ranked by top-N.

```
(case_id      VARCHAR2/NUMBER,
cluster_id    NUMBER,
probability   NUMBER,
rank         INTEGER)
```

### Feature Extraction using NMF

Feature extraction is also an unsupervised mining function, and hence there are no targets. The results of an APPLY operation contains simply the feature identifier corresponding to a case, and the associated match quality. Cost matrix is not considered here. The ranked results table will have the definition as shown, and contains the feature ids ranked by top-N.

```
(case_id      VARCHAR2/NUMBER,
feature_id    NUMBER,
match_quality NUMBER,
rank         INTEGER)
```

### Examples

```
BEGIN
/* build a model with name census_model.
 * (See example under CREATE_MODEL)
 */

/* if training data was pre-processed in any manner,
 * perform the same pre-processing steps on apply
 * data also.
 * (See examples in the section on DBMS_DATA_MINING_TRANSFORM)
 */
```

```

/* apply the model to data to be scored */
DBMS_DATA_MINING.RANK_APPLY(
  apply_result_table_name => 'census_apply_result',
  case_id_column_name     => 'person_id',
  score_column_name       => 'prediction',
  score_criterion_column_name => 'probability'
  ranked_apply_result_tab_name => 'census_ranked_apply_result',
  top_N                   => 3,
  cost_matrix_table_name  => 'census_cost_matrix');
END;
/

-- View Ranked Apply Results
SELECT *
  FROM census_ranked_apply_result;

```

### 36.1.5.45 REMOVE\_COST\_MATRIX Procedure

The `REMOVE_COST_MATRIX` procedure removes the default scoring matrix from a classification model.



#### See Also:

- ["ADD\\_COST\\_MATRIX Procedure"](#)
- ["REMOVE\\_COST\\_MATRIX Procedure"](#)

#### Syntax

```

DBMS_DATA_MINING.REMOVE_COST_MATRIX (
  model_name IN VARCHAR2);

```

#### Parameters

**Table 36-112 Remove\_Cost\_Matrix Procedure Parameters**

Parameter	Description
model_name	Name of the model in the form [ <i>schema_name</i> ]. <i>model_name</i> . If you do not specify a schema, your own schema is used.

#### Usage Notes

If the model is not in your schema, then `REMOVE_COST_MATRIX` requires the `ALTER ANY MINING MODEL` system privilege or the `ALTER` object privilege for the mining model.

#### Example

The Naive Bayes model `NB_SH_CLAS_SAMPLE` has an associated cost matrix that can be used for scoring the model.

```

SQL>SELECT *
      FROM TABLE(dbms_data_mining.get_model_cost_matrix('nb_sh_clas_sample'))
      ORDER BY predicted, actual;

ACTUAL      PREDICTED      COST
-----

```

```

0      0      0
1      0      .75
0      1      .25
1      1      0

```

You can remove the cost matrix with `REMOVE_COST_MATRIX`.

```

SQL>EXECUTE dbms_data_mining.remove_cost_matrix('nb_sh_clas_sample');

SQL>SELECT *
      FROM TABLE(dbms_data_mining.get_model_cost_matrix('nb_sh_clas_sample'))
      ORDER BY predicted, actual;

no rows selected

```

### 36.1.5.46 RENAME\_MODEL Procedure

This procedure changes the name of the mining model indicated by *model\_name* to the name that you specify as *new\_model\_name*.

If a model with *new\_model\_name* already exists, then the procedure optionally renames *new\_model\_name* to *versioned\_model\_name* before renaming *model\_name* to *new\_model\_name*.

The model name is in the form `[schema_name.]model_name`. If you do not specify a schema, your own schema is used. For mining model naming restrictions, see the Usage Notes for "[CREATE\\_MODEL Procedure](#)".

#### Syntax

```

DBMS_DATA_MINING.RENAME_MODEL (
  model_name          IN VARCHAR2,
  new_model_name      IN VARCHAR2,
  versioned_model_name IN VARCHAR2 DEFAULT NULL);

```

#### Parameters

**Table 36-113 RENAME\_MODEL Procedure Parameters**

Parameter	Description
<code>model_name</code>	Model to be renamed.
<code>new_model_name</code>	New name for the model <i>model_name</i> .
<code>versioned_model_name</code>	New name for the model <i>new_model_name</i> if it already exists.

#### Usage Notes

If you attempt to rename a model while it is being applied, then the model will be renamed but the apply operation will return indeterminate results.

#### Examples

1. This example changes the name of model `census_model` to `census_model_2012`.

```

BEGIN
  DBMS_DATA_MINING.RENAME_MODEL(
    model_name      => 'census_model',
    new_model_name => 'census_model_2012');

```

```
END;
/
```

2. In this example, there are two classification models in the user's schema: `clas_mod`, the working model, and `clas_mod_tst`, a test model. The `RENAME_MODEL` procedure preserves `clas_mod` as `clas_mod_old` and makes the test model the new working model.

```
SELECT model_name FROM user_mining_models;
MODEL_NAME
-----
CLAS_MOD
CLAS_MOD_TST

BEGIN
  DBMS_DATA_MINING.RENAME_MODEL(
    model_name      => 'clas_mod_tst',
    new_model_name  => 'clas_mod',
    versioned_model_name => 'clas_mod_old');
END;
/

SELECT model_name FROM user_mining_models;
MODEL_NAME
-----
CLAS_MOD
CLAS_MOD_OLD
```

## 36.2 DBMS\_DATA\_MINING\_TRANSFORM

`DBMS_DATA_MINING_TRANSFORM` implements a set of transformations that are commonly used in data mining.

This chapter contains the following topics:

- [Overview](#)
- [Operational Notes](#)
- [Security Model](#)
- [Datatypes](#)
- [Constants](#)
- [Summary of DBMS\\_DATA\\_MINING\\_TRANSFORM Subprograms](#)



### See Also:

- [DBMS\\_DATA\\_MINING](#)
- *Oracle Data Mining User's Guide*

### 36.2.1 Using DBMS\_DATA\_MINING\_TRANSFORM

This section contains topics that relate to using the `DBMS_DATA_MINING_TRANSFORM` package.

- [Overview](#)
- [Operational Notes](#)

- [Security Model](#)
- [Datatypes](#)
- [Constants](#)

### 36.2.1.1 DBMS\_DATA\_MINING\_TRANSFORM Overview

A transformation is a SQL expression that modifies the data in one or more columns.

Data must typically undergo certain transformations before it can be used to build a mining model. Many data mining algorithms have specific transformation requirements.

Data that will be scored must be transformed in the same way as the data that was used to create (train) the model.

#### External or Embedded Transformations

DBMS\_DATA\_MINING\_TRANSFORM offers two approaches to implementing transformations. For a given model, you can either:

- Create a list of transformation expressions and pass it to the [CREATE\\_MODEL Procedure](#)  
*or*
- Create a view that implements the transformations and pass the name of the view to the [CREATE\\_MODEL Procedure](#)

If you create a transformation list and pass it to CREATE\_MODEL, the transformation expressions are embedded in the model and automatically implemented whenever the model is applied.

If you create a view, the transformation expressions are external to the model. You will need to re-create the transformations whenever you apply the model.



#### Note:

Embedded transformations significantly enhance the model's usability while simplifying the process of model management.

#### Automatic Transformations

Oracle Data Mining supports an Automatic Data Preparation (ADP) mode. When ADP is enabled, most algorithm-specific transformations are *automatically* embedded. Any additional transformations must be explicitly provided in an embedded transformation list or in a view.

If ADP is enabled and you create a model with a transformation list, both sets of transformations are embedded. The model will execute the user-specified transformations from the transformation list before executing the automatic transformations specified by ADP.

Within a transformation list, you can selectively disable ADP for individual attributes.

 **See Also:**

"Automatic Data Preparation" in [DBMS\\_DATA\\_MINING](#)

*Oracle Data Mining User's Guide* for a more information about ADP

"[DBMS\\_DATA\\_MINING\\_TRANSFORM-About Transformation Lists](#)"

## Transformations in DBMS\_DATA\_MINING\_TRANSFORM

The transformations supported by `DBMS_DATA_MINING_TRANSFORM` are summarized in this section.

### Binning

Binning refers to the mapping of continuous or discrete values to discrete values of reduced cardinality.

- **Supervised Binning (Categorical and Numerical)**  
Binning is based on intrinsic relationships in the data as determined by a decision tree model.  
See "[INSERT\\_BIN\\_SUPER Procedure](#)".
- **Top-N Frequency Categorical Binning**  
Binning is based on the number of cases in each category.  
See "[INSERT\\_BIN\\_CAT\\_FREQ Procedure](#)".
- **Equi-Width Numerical Binning**  
Binning is based on equal-range partitions.  
See "[INSERT\\_BIN\\_NUM\\_EQWIDTH Procedure](#)".
- **Quantile Numerical Binning**  
Binning is based on quantiles computed using the SQL `NTILE` function.  
See "[INSERT\\_BIN\\_NUM\\_QTILE Procedure](#)".

### Linear Normalization

Normalization is the process of scaling continuous values down to a specific range, often between zero and one. Normalization transforms each numerical value by subtracting a number (the **shift**) and dividing the result by another number (the **scale**).

```
x_new = (x_old-shift)/scale
```

- **Min-Max Normalization**  
Normalization is based on the minimum and maximum with the following shift and scale:  

```
shift = min  
scale = max-min
```

  
See "[INSERT\\_NORM\\_LIN\\_MINMAX Procedure](#)".
- **Scale Normalization**  
Normalization is based on the minimum and maximum with the following shift and scale:



```
shift = 0
scale = max{abs(max), abs(min)}
```

See "[INSERT\\_NORM\\_LIN\\_SCALE Procedure](#)".

- Z-Score Normalization

Normalization is based on the mean and standard deviation with the following shift and scale:

```
shift = mean
scale = standard_deviation
```

See "[INSERT\\_NORM\\_LIN\\_ZSCORE Procedure](#)".

### Outlier Treatment

An outlier is a numerical value that is located far from the rest of the data. Outliers can artificially skew the results of data mining.

- Winsorizing

Outliers are replaced with the nearest value that is not an outlier.

See "[INSERT\\_CLIP\\_WINSOR\\_TAIL Procedure](#)".

- Trimming

Outliers are set to NULL.

See "[INSERT\\_CLIP\\_TRIM\\_TAIL Procedure](#)".

### Missing Value Treatment

Missing data may indicate sparsity or it may indicate that some values are missing at random. DBMS\_DATA\_MINING\_TRANSFORM supports the following transformations for minimizing the effects of missing values:

- Missing numerical values are replaced with the mean.  
See "[INSERT\\_MISS\\_NUM\\_MEAN Procedure](#)".
- Missing categorical values are replaced with the mode.  
See "[INSERT\\_MISS\\_CAT\\_MODE Procedure](#)".



#### Note:

Oracle Data Mining also has default mechanisms for handling missing data. See *Oracle Data Mining User's Guide* for details.

## 36.2.1.2 DBMS\_DATA\_MINING\_TRANSFORM Security Model

The DBMS\_DATA\_MINING\_TRANSFORM package is owned by user SYS and is installed as part of database installation. Execution privilege on the package is granted to public. The routines in the package are run with invokers' rights (run with the privileges of the current user).

The DBMS\_DATA\_MINING\_TRANSFORM.INSERT\_\* procedures have a *data\_table\_name* parameter that enables the user to provide the input data for transformation purposes. The value of *data\_table\_name* can be the name of a physical table or a view. The *data\_table\_name* parameter can also accept an inline query.

 **Note:**

Because an inline query can be used to specify the data for transformation, Oracle strongly recommends that the calling routine perform any necessary SQL injection checks on the input string.

 **See Also:**

"Operational Notes" for a description of the `DBMS_DATA_MINING_TRANSFORM.INSERT_*` procedures

### 36.2.1.3 DBMS\_DATA\_MINING\_TRANSFORM Datatypes

DBMS\_DATA\_MINING\_TRANSFORM defines the datatypes described in the following table.

**Table 36-114 Datatypes in DBMS\_DATA\_MINING\_TRANSFORM**

List Type	List Elements	Description
<b>COLUMN_LIST</b>	VARRAY(1000) OF varchar2(32)	<p>COLUMN_LIST stores quoted and non-quoted identifiers for column names.</p> <p>COLUMN_LIST is the datatype of the <code>exclude_list</code> parameter in the INSERT procedures. See "<a href="#">INSERT_AUTOBIN_NUM_EQWIDTH Procedure</a>" for an example.</p> <p>See <i>Oracle Database PL/SQL Language Reference</i> for information about populating VARRAY structures.</p>
<b>DESCRIBE_LIST</b>	<p>DBMS_SQL.DESC_TAB2</p> <p>TYPE desc_tab2 IS TABLE OF desc_rec2 INDEX BY BINARY_INTEGER</p> <p>TYPE desc_rec2 IS RECORD (  col_type BINARY_INTEGER := 0,  col_max_len BINARY_INTEGER := 0,  col_name VARCHAR2(32767) :=  '',  col_name_len BINARY_INTEGER := 0,  col_schema_name VARCHAR2(32) :=  '',  col_schema_name_len BINARY_INTEGER := 0,  col_precision BINARY_INTEGER := 0,  col_scale BINARY_INTEGER := 0,  col_charsetid BINARY_INTEGER := 0,  col_charsetform BINARY_INTEGER := 0,  col_null_ok BOOLEAN := TRUE);</p>	<p>DESCRIBE_LIST describes the columns of the data table after the transformation list has been applied. A DESCRIBE_LIST is returned by the <a href="#">DESCRIBE_STACK Procedure</a>.</p> <p>The DESC_TAB2 and DESC_REC2 types are defined in the DBMS_SQL package. See "<a href="#">DESC_REC2 Record Type</a>".</p> <p>The col_type field of DESC_REC2 identifies the datatype of the column. The datatype is expressed as a numeric constant that represents a built-in datatype. For example, a 1 indicates a variable length character string. The codes for Oracle built-in datatypes are listed in <i>Oracle Database SQL Language Reference</i>. The codes for the Oracle Data Mining nested types are described in "<a href="#">Constants</a>".</p> <p>The col_name field of DESC_REC2 identifies the column name. It may be populated with a column name, an alias, or an expression. If the column name is a SELECT expression, it may be very long. If the expression is longer than 30 bytes, it cannot be used in a view unless it is given an alias.</p>

**Table 36-114 (Cont.) Datatypes in DBMS\_DATA\_MINING\_TRANSFORM**

List Type	List Elements	Description
<b>TRANSFORM_LIST</b>	<p><b>TABLE OF transform_rec</b></p> <pre> TYPE transform_rec IS RECORD (   attribute_name      VARCHAR2(30),   attribute_subname   VARCHAR2(4000),   expression          EXPRESSION_REC,   reverse_expression  EXPRESSION_REC,   attribute_spec      VARCHAR2(4000));  TYPE expression_rec IS RECORD (   lstmt              DBMS_SQL.VARCHAR2A,   lb                 BINARY_INTEGER DEFAULT 1,   ub                 BINARY_INTEGER DEFAULT 0);  TYPE varchar2a IS TABLE OF   VARCHAR2(32767)   INDEX BY BINARY_INTEGER; </pre>	<p>TRANSFORM_LIST is a list of transformations that can be embedded in a model. A TRANSFORM_LIST is accepted as an argument by the <a href="#">CREATE_MODEL Procedure</a>.</p> <p>Each element in a TRANSFORM_LIST is a TRANSFORM_REC that specifies how to transform a single attribute. The attribute_name is a column name. The attribute_subname is the nested attribute name if the column is nested, otherwise attribute_subname is null.</p> <p>The expression field holds a SQL expression for transforming the attribute. See <a href="#">"About Transformation Lists"</a> for an explanation of reverse expressions.</p> <p>The attribute_spec field can be used to cause the attribute to be handled in a specific way during the model build. See <a href="#">Table 36-146</a> for details.</p> <p>The expressions in a TRANSFORM_REC have type EXPRESSION_REC. The lstmt field stores a VARCHAR2A, which is a table of VARCHAR2(32767). The VARCHAR2A datatype allows transformation expressions to be very long, as they can be broken up across multiple rows of VARCHAR2. The VARCHAR2A type is defined in the DBMS_SQL package. See <a href="#">"VARCHAR2A Table Type"</a>.</p> <p>The ub (upper bound) and lb (lower bound) fields indicate how many rows there are in the VARCHAR2A table. If ub &lt; lb (default) the EXPRESSION_REC is empty; if lb=ub=1 there is one row; if lb=1 and ub=2 there are 2 rows, and so on.</p>

**Related Topics**

- [Oracle Database PL/SQL Packages and Types Reference](#)

**Related Topics**

- [Oracle Database PL/SQL Packages and Types Reference](#)

### 36.2.1.4 DBMS\_DATA\_MINING\_TRANSFORM Constants

DBMS\_DATA\_MINING\_TRANSFORM defines the constants described in the following table.

**Table 36-115 Constants in DBMS\_DATA\_MINING\_TRANSFORM**

Constant	Value	Description				
NEST_NUM_COL_TYPE	100001	<p>Indicates that an attribute in the transformation list comes from a row in a column of DM_NESTED_NUMERICALS.</p> <p>Nested numerical attributes are defined as follows:</p> <table border="0"> <tr> <td>attribute_name</td> <td>VARCHAR2(4000)</td> </tr> <tr> <td>value</td> <td>NUMBER</td> </tr> </table>	attribute_name	VARCHAR2(4000)	value	NUMBER
attribute_name	VARCHAR2(4000)					
value	NUMBER					

**Table 36-115 (Cont.) Constants in DBMS\_DATA\_MINING\_TRANSFORM**

Constant	Value	Description				
NEST_CAT_COL_TYPE	100002	Indicates that an attribute in the transformation list comes from a row in a column of DM_NESTED_CATEGORICALS. Nested categorical attributes are defined as follows:  <table border="0"> <tr> <td>attribute_name</td> <td>VARCHAR2(4000)</td> </tr> <tr> <td>value</td> <td>VARCHAR2(4000)</td> </tr> </table>	attribute_name	VARCHAR2(4000)	value	VARCHAR2(4000)
attribute_name	VARCHAR2(4000)					
value	VARCHAR2(4000)					
NEST_BD_COL_TYPE	100003	Indicates that an attribute in the transformation list comes from a row in a column of DM_NESTED_BINARY_DOUBLES. Nested binary double attributes are defined as follows:  <table border="0"> <tr> <td>attribute_name</td> <td>VARCHAR2(4000)</td> </tr> <tr> <td>value</td> <td>BINARY_DOUBLE</td> </tr> </table>	attribute_name	VARCHAR2(4000)	value	BINARY_DOUBLE
attribute_name	VARCHAR2(4000)					
value	BINARY_DOUBLE					
NEST_BF_COL_TYPE	100004	Indicates that an attribute in the transformation list comes from a row in a column of DM_NESTED_BINARY_FLOATS.  <table border="0"> <tr> <td>attribute_name</td> <td>VARCHAR2(4000)</td> </tr> <tr> <td>value</td> <td>BINARY_FLOAT</td> </tr> </table>	attribute_name	VARCHAR2(4000)	value	BINARY_FLOAT
attribute_name	VARCHAR2(4000)					
value	BINARY_FLOAT					

 **See Also:**

*Oracle Data Mining User's Guide* for information about nested data in Oracle Data Mining

## 36.2.2 DBMS\_DATA\_MINING\_TRANSFORM Operational Notes

The `DBMS_DATA_MINING_TRANSFORM` package offers a flexible framework for specifying data transformations. If you choose to embed transformations in the model (the preferred method), you create a **transformation list** object and pass it to the `CREATE_MODEL` Procedure. If you choose to transform the data without embedding, you create a view.

When specified in a transformation list, the transformation expressions are executed by the model. When specified in a view, the transformation expressions are executed by the view.

### Transformation Definitions

Transformation definitions are used to generate the SQL expressions that transform the data. For example, the transformation definitions for normalizing a numeric column are the shift and scale values for that data.

With the `DBMS_DATA_MINING_TRANSFORM` package, you can call procedures to compute the transformation definitions, or you can compute them yourself, or you can do both.

### Transformation Definition Tables

`DBMS_DATA_MINING_TRANSFORM` provides **INSERT** procedures that compute transformation definitions and insert them in transformation definition tables. You can modify the values in the transformation definition tables or populate them yourself.

**XFORM** routines use populated definition tables to transform data in external views. **STACK** routines use populated definition tables to build transformation lists.

To specify transformations based on definition tables, follow these steps:

1. Use **CREATE** routines to create transformation definition tables.  
The tables have columns to hold the transformation definitions for a given type of transformation. For example, the [CREATE\\_BIN\\_NUM Procedure](#) creates a definition table that has a column for storing data values and another column for storing the associated bin identifiers.
2. Use **INSERT** routines to compute and insert transformation definitions in the tables.  
Each **INSERT** routine uses a specific technique for computing the transformation definitions. For example, the [INSERT\\_BIN\\_NUM\\_EQWIDTH Procedure](#) computes bin boundaries by identifying the minimum and maximum values then setting the bin boundaries at equal intervals.
3. Use **STACK** or **XFORM** routines to generate transformation expressions based on the information in the definition tables:
  - Use **STACK** routines to add the transformation expressions to a transformation list. Pass the transformation list to the [CREATE\\_MODEL Procedure](#). The transformation expressions will be assembled into one long SQL query and embedded in the model.
  - Use **XFORM** routines to execute the transformation expressions within a view. The transformations will be external to the model and will need to be re-created whenever the model is applied to new data.

### Transformations Without Definition Tables

**STACK** routines are not the only method for adding transformation expressions to a transformation list. You can also build a transformation list without using definition tables.

To specify transformations without using definition tables, follow these steps:

1. Write a SQL expression for transforming an attribute.
2. Write a SQL expression for reversing the transformation. (See "Reverse Transformations and Model Transparency" in "[DBMS\\_DATA\\_MINING\\_TRANSFORM-About Transformation Lists](#)".)
3. Determine whether or not to disable ADP for the attribute. By default ADP is enabled for the attribute if it is specified for the model. (See "Disabling Automatic Data Preparation" in "[DBMS\\_DATA\\_MINING\\_TRANSFORM - About Transformation Lists](#)".)
4. Specify the SQL expressions and ADP instructions in a call to the [SET\\_TRANSFORM Procedure](#), which adds the information to a transformation list.
5. Repeat steps 1 through 4 for each attribute that you wish to transform.
6. Pass the transformation list to the [CREATE\\_MODEL Procedure](#). The transformation expressions will be assembled into one long SQL query and embedded in the model.

 **Note:**

SQL expressions that you specify with `SET_TRANSFORM` must fit within a `VARCHAR2`. To specify a longer expression, you can use the [SET\\_EXPRESSION Procedure](#). With `SET_EXPRESSION`, you can build an expression by appending rows to a `VARCHAR2` array.

### About Stacking

Transformation lists are built by stacking transformation records. Transformation lists are evaluated from bottom to top. Each transformation expression depends on the result of the transformation expression below it in the stack.

### Related Topics

- [CREATE\\_MODEL Procedure](#)  
This procedure creates a mining model with a given mining function.
- [DBMS\\_DATA\\_MINING\\_TRANSFORM — About Transformation Lists](#)  
The elements of a transformation list are **transformation records**. Each transformation record provides all the information needed by the model for managing the transformation of a single attribute.
- [DBMS\\_DATA\\_MINING\\_TRANSFORM — About Stacking and Stack Procedures](#)  
Transformation lists are built by stacking transformation records. Transformation lists are evaluated from bottom to top. Each transformation expression depends on the result of the transformation expression below it in the stack.
- [DBMS\\_DATA\\_MINING\\_TRANSFORM — Nested Data Transformations](#)  
The `CREATE` routines create transformation definition tables that include two columns, `col` and `att`, for identifying attributes. The column `col` holds the name of a column in the data table. If the data column is not nested, then `att` is null, and the name of the attribute is `col`. If the data column is nested, then `att` holds the name of the nested attribute, and the name of the attribute is `col.att`.

## 36.2.2.1 DBMS\_DATA\_MINING\_TRANSFORM — About Transformation Lists

The elements of a transformation list are **transformation records**. Each transformation record provides all the information needed by the model for managing the transformation of a single attribute.

Each transformation record includes the following fields:

- `attribute_name` — Name of the column of data to be transformed
- `attribute_subname` — Name of the nested attribute if `attribute_name` is a nested column, otherwise `NULL`
- `expression` — SQL expression for transforming the attribute
- `reverse_expression` — SQL expression for reversing the transformation
- `attribute_spec` — Identifies special treatment for the attribute during the model build. See [Table 36-146](#) for details.

 **See Also:**

- [Table 36-114](#) for details about the `TRANSFORM_LIST` and `TRANSFORM_REC` object types
- [SET\\_TRANSFORM Procedure](#)
- [CREATE\\_MODEL Procedure](#)

### Reverse Transformations and Model Transparency

An algorithm manipulates transformed attributes to train and score a model. The transformed attributes, however, may not be meaningful to an end user. For example, if attribute *x* has been transformed into bins 1 — 4, the bin names 1, 2, 3, and 4 are manipulated by the algorithm, but a user is probably not interested in the model details about bins 1 — 4 or in predicting the numbers 1 — 4.

To return original attribute values in model details and predictions, you can provide a reverse expression in the transformation record for the attribute. For example, if you specify the transformation expression `'log(10, y)'` for attribute *y*, you could specify the reverse transformation expression `'power(10, y)'`.

Reverse transformations enable **model transparency**. They make internal processing transparent to the user.

 **Note:**

`STACK` procedures automatically reverse normalization transformations, but they do not provide a mechanism for reversing binning, clipping, or missing value transformations.

You can use the `DBMS_DATA_MINING.ALTER_REVERSE_EXPRESSION` procedure to specify or update reverse transformations expressions for an existing model.

 **See Also:**

[Table 36-114](#)

["ALTER\\_REVERSE\\_EXPRESSION Procedure"](#)

["Summary of DBMS\\_DATA\\_MINING Subprograms"](#) for links to the model details functions

### Disabling Automatic Data Preparation

ADP is controlled by a model-specific setting (`PREP_AUTO`). The `PREP_AUTO` setting affects all model attributes unless you disable it for individual attributes.

If ADP is enabled and you set `attribute_spec` to `NOPREP`, only the transformations that you specify for that attribute will be evaluated. If ADP is enabled and you do *not* set

*attribute\_spec* to NOPREP, the automatic transformations will be evaluated *after* the transformations that you specify for the attribute.

If ADP is not enabled for the model, the *attribute\_spec* field of the transformation record is ignored.



#### See Also:

"[Automatic Data Preparation](#)" for information about the `PREP_AUTO` setting

### Adding Transformation Records to a Transformation List

A transformation list is a stack of transformation records. When a new transformation record is added, it is appended to the top of the stack. (See "[About Stacking](#)" for details.)

When you use `SET_TRANSFORM` to add a transformation record to a transformation list, you can specify values for all the fields in the transformation record.

When you use `STACK` procedures to add transformation records to a transformation list, only the transformation expression field is populated. For normalization transformations, the reverse transformation expression field is also populated.

You can use both `STACK` procedures and `SET_TRANSFORM` to build one transformation list. Each `STACK` procedure call adds transformation records for all the attributes in a specified transformation definition table. Each `SET_TRANSFORM` call adds a transformation record for a single attribute.

## 36.2.2.2 DBMS\_DATA\_MINING\_TRANSFORM — About Stacking and Stack Procedures

Transformation lists are built by stacking transformation records. Transformation lists are evaluated from bottom to top. Each transformation expression depends on the result of the transformation expression below it in the stack.

### Stack Procedures

`STACK` procedures create transformation records from the information in transformation definition tables. For example `STACK_BIN_NUM` builds a transformation record for each attribute specified in a definition table for numeric binning. `STACK` procedures stack the transformation records as follows:

- If an attribute is specified in the definition table but not in the transformation list, the `STACK` procedure creates a transformation record, computes the reverse transformation (if possible), inserts the transformation and reverse transformation in the transformation record, and appends the transformation record to the top of the transformation list.
- If an attribute is specified in the transformation list but not in the definition table, the `STACK` procedure takes no action.
- If an attribute is specified in the definition table *and* in the transformation list, the `STACK` procedure stacks the transformation expression from the definition table on top of the transformation expression in the transformation record and updates the reverse transformation. See [Table 36-114](#) and [Example 36-6](#).



### Example 36-3 Stacking a Clipping Transformation

This example shows how [STACK\\_CLIP Procedure](#) would add transformation records to a transformation list. Note that the clipping transformations are not reversed in COL1 and COL2 after stacking (as described in "Reverse Transformations and Model Transparency" in "[DBMS\\_DATA\\_MINING\\_TRANSFORM-About Transformation Lists](#)").

Refer to:

- [CREATE\\_CLIP Procedure](#) — Creates the definition table
- [INSERT\\_CLIP\\_TRIM\\_TAIL Procedure](#) — Inserts definitions in the table
- [INSERT\\_CLIP\\_WINSOR\\_TAIL Procedure](#) — Inserts definitions in the table
- [Table 36-114](#) — Describes the structure of the transformation list (TRANSFORM\_LIST object)

Assume a clipping definition table populated as follows.

col	att	lcut	lval	rcut	rval
COL1	null	-1.5	-1.5	4.5	4.5
COL2	null	0	0	1	1

Assume the following transformation list before stacking.

```

-----
transformation record #1:
-----
    attribute_name      = COL1
    attribute_subname   = null
    expression          = log(10, COL1)
    reverse_expression  = power(10, COL1)
-----
transformation record #2:
-----
    attribute_name      = COL3
    attribute_subname   = null
    expression          = ln(COL3)
    reverse_expression  = exp(COL3)

```

After stacking, the transformation list is as follows.

```

-----
transformation record #1:
-----
    attribute_name      = COL1
    attribute_subname   = null
    expression          = CASE WHEN log(10, COL1) < -1.5 THEN -1.5
                        WHEN log(10, COL1) > 4.5 THEN 4.5
                        ELSE log(10, COL1)
                        END;
    reverse_expression  = power(10, COL1)
-----
transformation record #2:
-----
    attribute_name      = COL3
    attribute_subname   = null
    expression          = ln(COL3)
    reverse_expression  = exp(COL3)
-----
transformation record #3:

```

```

-----
attribute_name      = COL2
attribute_subname   = null
expression          = CASE WHEN COL2 < 0 THEN 0
                    WHEN COL2 > 1 THEN 1
                    ELSE COL2
                    END;
reverse_expression  = null

```

### 36.2.2.3 DBMS\_DATA\_MINING\_TRANSFORM — Nested Data Transformations

The `CREATE` routines create transformation definition tables that include two columns, `col` and `att`, for identifying attributes. The column `col` holds the name of a column in the data table. If the data column is not nested, then `att` is null, and the name of the attribute is `col`. If the data column is nested, then `att` holds the name of the nested attribute, and the name of the attribute is `col.att`.

The `INSERT` and `XFORM` routines ignore the `att` column in the definition tables. Neither the `INSERT` nor the `XFORM` routines support nested data.

Only the `STACK` procedures and `SET_TRANSFORM` support nested data. Nested data transformations are always embedded in the model.

feature 322331-1 Native doubles in DMFs

Nested columns in Oracle Data Mining can have the following types:

```

DM_NESTED_NUMERICALS
DM_NESTED_CATEGORICALS
DM_NESTED_BINARY_DOUBLES
DM_NESTED_BINARY_FLOATS

```



#### See Also:

["Constants"](#)

*Oracle Data Mining User's Guide* for details about nested attributes in Oracle Data Mining

#### Specifying Nested Attributes in a Transformation Record

A transformation record (`TRANSFORM_REC`) includes two fields, `attribute_name` and `attribute_subname`, for identifying the attribute. The field `attribute_name` holds the name of a column in the data table. If the data column is not nested, then `attribute_subname` is null, and the name of the attribute is `attribute_name`. If the data column is nested, then `attribute_subname` holds the name of the nested attribute, and the name of the attribute is `attribute_name.attribute_subname`.

#### Transforming Individual Nested Attributes

You can specify different transformations for different attributes in a nested column, and you can specify a default transformation for all the remaining attributes in the column. To specify a default nested transformation, specify null in the `attribute_name` field and the name of the nested column in the `attribute_subname` field as shown in [Example 36-4](#). Note that the

keyword `VALUE` is used to represent the value of a nested attribute in a transformation expression.

#### Example 36-4 Transforming a Nested Column

The following statement transforms two of the nested attributes in `COL_N1`. Attribute `ATTR1` is transformed with normalization; Attribute `ATTR2` is set to null, which causes attribute removal transformation (`ATTR2` is not used in training the model). All the remaining attributes in `COL_N1` are divided by 10.

```
DECLARE
  stk dbms_data_mining_transform.TRANSFORM_LIST;
BEGIN
  dbms_data_mining_transform.SET_TRANSFORM(
    stk,'COL_N1', 'ATTR1', '(VALUE - (-1.5))/20', 'VALUE *20 + (-1.5)');
  dbms_data_mining_transform.SET_TRANSFORM(
    stk,'COL_N1', 'ATTR2', NULL, NULL);
  dbms_data_mining_transform.SET_TRANSFORM(
    stk, NULL, 'COL_N1', 'VALUE/10', 'VALUE*10');
END;
/
```

The following SQL is generated from this statement.

```
CAST(MULTISET(SELECT DM_NESTED_NUMERICAL(
                "ATTRIBUTE_NAME",
                DECODE("ATTRIBUTE_NAME",
                    'ATTR1', ("VALUE" - (-1.5))/20,
                    "VALUE"/10))
            FROM TABLE("COL_N1")
            WHERE "ATTRIBUTE_NAME" IS NOT IN ('ATTR2'))
    AS DM_NESTED_NUMERICALS)
```

If transformations are not specified for `COL_N1.ATTR1` and `COL_N1.ATTR2`, then the default transformation is used for all the attributes in `COL_N1`, and the resulting SQL does not include a `DECODE`.

```
CAST(MULTISET(SELECT DM_NESTED_NUMERICAL(
                "ATTRIBUTE_NAME",
                "VALUE"/10)
            FROM TABLE("COL_N1"))
    AS DM_NESTED_NUMERICALS)
```

Since `DECODE` is limited to 256 arguments, multiple `DECODE` functions are nested to support an arbitrary number of individual nested attribute specifications.

#### Adding a Nested Column

You can specify a transformation that adds a nested column to the data, as shown in [Example 36-5](#).

#### Example 36-5 Adding a Nested Column to a Transformation List

```
DECLARE
  v_xlst dbms_data_mining_transform.TRANSFORM_LIST;
BEGIN
  dbms_data_mining_transform.SET_TRANSFORM(v_xlst,
    'YOB_CREDLIM', NULL,
    'dm_nested_numericals(
      dm_nested_numerical(
        'CUST_YEAR_OF_BIRTH', cust_year_of_birth),
      dm_nested_numerical(
```

```

        'CUST_CREDIT_LIMIT', cust_credit_limit))',
    NULL);
dbms_data_mining_transform.SET_TRANSFORM(
    v_xlst, 'CUST_YEAR_OF_BIRTH', NULL, NULL, NULL);
dbms_data_mining_transform.SET_TRANSFORM(
    v_xlst, 'CUST_CREDIT_LIMIT', NULL, NULL, NULL);
dbms_data_mining_transform.XFORM_STACK(
    v_xlst, 'mining_data', 'mining_data_v');
END;
/

set long 2000
SELECT text FROM user_views WHERE view_name IN 'MINING_DATA_V';

TEXT
-----
SELECT "CUST_ID","CUST_POSTAL_CODE",dm_nested_numericals(
    dm_nested_numerical(
        'CUST_YEAR_OF_BIRTH', cust_year_of_birth),
    dm_nested_numerical(
        'CUST_CREDIT_LIMIT', cust_credit_limit)) "YOB_CREDLIM" FROM mining_data

SELECT * FROM mining_data_v WHERE cust_id = 104500;

CUST_ID CUST_POSTAL_CODE YOB_CREDLIM(ATTRIBUTE_NAME, VALUE)
-----
104500 68524          DM_NESTED_NUMERICALS(DM_NESTED_NUMERICAL(
                        'CUST_YEAR_OF_BIRTH', 1962),
                        DM_NESTED_NUMERICAL('CUST_CREDIT_LIMIT', 15000))

```

### Stacking Nested Transformations

Example 36-6 shows how the [STACK\\_NORM\\_LIN Procedure](#) would add transformation records for nested column COL\_N to a transformation list.

#### Refer to:

- [CREATE\\_NORM\\_LIN Procedure](#) — Creates the definition table
- [INSERT\\_NORM\\_LIN\\_MINMAX Procedure](#) — Inserts definitions in the table
- [INSERT\\_NORM\\_LIN\\_SCALE Procedure](#) — Inserts definitions in the table
- [INSERT\\_NORM\\_LIN\\_ZSCORE Procedure](#) — Inserts definitions in the table
- [Table 36-114](#) — Describes the structure of the transformation list

#### Example 36-6 Stacking a Nested Normalization Transformation

Assume a linear normalization definition table populated as follows.

col	att	shift	scale
COL_N	ATT2	0	20
null	COL_N	0	10

Assume the following transformation list before stacking.

```

-----
transformation record #1:
-----
    attribute_name      = COL_N

```

```

attribute_subname = ATT1
expression        = log(10, VALUE)
reverse_expression = power(10, VALUE)
-----
transformation record #2:
-----
attribute_name    = null
attribute_subname = COL_N
expression        = ln(VALUE)
reverse_expression = exp(VALUE)

```

**After stacking, the transformation list is as follows.**

```

-----
transformation record #1:
-----
attribute_name    = COL_N
attribute_subname = ATT1
expression        = (log(10, VALUE) - 0)/10
reverse_expression = power(10, VALUE*10 + 0)
-----
transformation record #2:
-----
attribute_name    = NULL
attribute_subname = COL_N
expression        = (ln(VALUE)- 0)/10
reverse_expression = exp(VALUE *10 + 0)
-----
transformation record #3:
-----
attribute_name    = COL_N
attribute_subname = ATT2
expression        = (ln(VALUE) - 0)/20
reverse_expression = exp(VALUE * 20 + 0)

```

### 36.2.3 Summary of DBMS\_DATA\_MINING\_TRANSFORM Subprograms

This table lists the DBMS\_DATA\_MINING\_TRANSFORM subprograms in alphabetical order and briefly describes them.

**Table 36-116 DBMS\_DATA\_MINING\_TRANSFORM Package Subprograms**

Subprogram	Purpose
<a href="#">CREATE_BIN_CAT Procedure</a>	Creates a transformation definition table for categorical binning
<a href="#">CREATE_BIN_NUM Procedure</a>	Creates a transformation definition table for numerical binning
<a href="#">CREATE_CLIP Procedure</a>	Creates a transformation definition table for clipping
<a href="#">CREATE_COL_REM Procedure</a>	Creates a transformation definition table for column removal
<a href="#">CREATE_MISS_CAT Procedure</a>	Creates a transformation definition table for categorical missing value treatment
<a href="#">CREATE_MISS_NUM Procedure</a>	Creates a transformation definition table for numerical missing values treatment
<a href="#">CREATE_NORM_LIN Procedure</a>	Creates a transformation definition table for linear normalization
<a href="#">DESCRIBE_STACK Procedure</a>	Describes the transformation list
<a href="#">GET_EXPRESSION Function</a>	Returns a VARCHAR2 chunk from a transformation expression

**Table 36-116 (Cont.) DBMS\_DATA\_MINING\_TRANSFORM Package Subprograms**

Subprogram	Purpose
<a href="#">INSERT_AUTOBIN_NUM_EQWIDT H Procedure</a>	Inserts numeric automatic equi-width binning definitions in a transformation definition table
<a href="#">INSERT_BIN_CAT_FREQ Procedure</a>	Inserts categorical frequency-based binning definitions in a transformation definition table
<a href="#">INSERT_BIN_NUM_EQWIDTH Procedure</a>	Inserts numeric equi-width binning definitions in a transformation definition table
<a href="#">INSERT_BIN_NUM_QTILE Procedure</a>	Inserts numeric quantile binning expressions in a transformation definition table
<a href="#">INSERT_BIN_SUPER Procedure</a>	Inserts supervised binning definitions in numerical and categorical transformation definition tables
<a href="#">INSERT_CLIP_TRIM_TAIL Procedure</a>	Inserts numerical trimming definitions in a transformation definition table
<a href="#">INSERT_CLIP_WINSOR_TAIL Procedure</a>	Inserts numerical winsorizing definitions in a transformation definition table
<a href="#">INSERT_MISS_CAT_MODE Procedure</a>	Inserts categorical missing value treatment definitions in a transformation definition table
<a href="#">INSERT_MISS_NUM_MEAN Procedure</a>	Inserts numerical missing value treatment definitions in a transformation definition table
<a href="#">INSERT_NORM_LIN_MINMAX Procedure</a>	Inserts linear min-max normalization definitions in a transformation definition table
<a href="#">INSERT_NORM_LIN_SCALE Procedure</a>	Inserts linear scale normalization definitions in a transformation definition table
<a href="#">INSERT_NORM_LIN_ZSCORE Procedure</a>	Inserts linear zscore normalization definitions in a transformation definition table
<a href="#">SET_EXPRESSION Procedure</a>	Adds a <code>VARCHAR2</code> chunk to an expression
<a href="#">SET_TRANSFORM Procedure</a>	Adds a transformation record to a transformation list
<a href="#">STACK_BIN_CAT Procedure</a>	Adds a categorical binning expression to a transformation list
<a href="#">STACK_BIN_NUM Procedure</a>	Adds a numerical binning expression to a transformation list
<a href="#">STACK_CLIP Procedure</a>	Adds a clipping expression to a transformation list
<a href="#">STACK_COL_REM Procedure</a>	Adds a column removal expression to a transformation list
<a href="#">STACK_MISS_CAT Procedure</a>	Adds a categorical missing value treatment expression to a transformation list
<a href="#">STACK_MISS_NUM Procedure</a>	Adds a numerical missing value treatment expression to a transformation list
<a href="#">STACK_NORM_LIN Procedure</a>	Adds a linear normalization expression to a transformation list
<a href="#">XFORM_BIN_CAT Procedure</a>	Creates a view of the data table with categorical binning transformations
<a href="#">XFORM_BIN_NUM Procedure</a>	Creates a view of the data table with numerical binning transformations
<a href="#">XFORM_CLIP Procedure</a>	Creates a view of the data table with clipping transformations
<a href="#">XFORM_COL_REM Procedure</a>	Creates a view of the data table with column removal transformations
<a href="#">XFORM_EXPR_NUM Procedure</a>	Creates a view of the data table with the specified numeric transformations

**Table 36-116 (Cont.) DBMS\_DATA\_MINING\_TRANSFORM Package Subprograms**

Subprogram	Purpose
<a href="#">XFORM_EXPR_STR Procedure</a>	Creates a view of the data table with the specified categorical transformations
<a href="#">XFORM_MISS_CAT Procedure</a>	Creates a view of the data table with categorical missing value treatment
<a href="#">XFORM_MISS_NUM Procedure</a>	Creates a view of the data table with numerical missing value treatment
<a href="#">XFORM_NORM_LIN Procedure</a>	Creates a view of the data table with linear normalization transformations
<a href="#">XFORM_STACK Procedure</a>	Creates a view of the transformation list

### 36.2.3.1 CREATE\_BIN\_CAT Procedure

This procedure creates a transformation definition table for categorical binning.

The columns are described in the following table.

**Table 36-117 Columns in a Transformation Definition Table for Categorical Binning**

Name	Datatype	Description
col	VARCHAR2(30)	Name of a column of categorical data. If the column is not nested, the column name is also the attribute name. For information about attribute names, see <i>Oracle Data Mining User's Guide</i> .
att	VARCHAR2(4000)	The attribute subname if <i>col</i> is a nested column. If <i>col</i> is nested, the attribute name is <i>col.att</i> . If <i>col</i> is not nested, <i>att</i> is null.
val	VARCHAR2(4000)	Values of the attribute
bin	VARCHAR2(4000)	Bin assignments for the values

#### Syntax

```
DBMS_DATA_MINING_TRANSFORM.CREATE_BIN_CAT (
    bin_table_name    IN VARCHAR2,
    bin_schema_name  IN VARCHAR2 DEFAULT NULL );
```

#### Parameters

**Table 36-118 CREATE\_BIN\_CAT Procedure Parameters**

Parameter	Description
bin_table_name	Name of the transformation definition table to be created
bin_schema_name	Schema of <i>bin_table_name</i> . If no schema is specified, the current schema is used.

#### Usage Notes

1. See *Oracle Data Mining User's Guide* for details about categorical data.

2. See ["Nested Data Transformations"](#) for information about transformation definition tables and nested data.
3. You can use the following procedures to populate the transformation definition table:
  - [INSERT\\_BIN\\_CAT\\_FREQ Procedure](#) — frequency-based binning
  - [INSERT\\_BIN\\_SUPER Procedure](#) — supervised binning



**See Also:**

"Binning" in [DBMS\\_DATA\\_MINING\\_TRANSFORM Overview](#)  
 "Operational Notes"

**Examples**

The following statement creates a table called `bin_cat_xtbl` in the current schema. The table has columns that can be populated with bin assignments for categorical attributes.

```
BEGIN
  DBMS_DATA_MINING_TRANSFORM.CREATE_BIN_CAT('bin_cat_xtbl');
END;
/
DESCRIBE bin_cat_xtbl
Name                                         Null?      Type
-----
COL                                         VARCHAR2(30)
ATT                                         VARCHAR2(4000)
VAL                                         VARCHAR2(4000)
BIN                                         VARCHAR2(4000)
```

**36.2.3.2 CREATE\_BIN\_NUM Procedure**

This procedure creates a transformation definition table for numerical binning.

The columns are described in the following table.

**Table 36-119 Columns in a Transformation Definition Table for Numerical Binning**

Name	Datatype	Description
col	VARCHAR2(30)	Name of a column of numerical data. If the column is not nested, the column name is also the attribute name. For information about attribute names, see <i>Oracle Data Mining User's Guide</i> .
att	VARCHAR2(4000)	The attribute subname if <i>col</i> is a nested column. If <i>col</i> is nested, the attribute name is <i>col.att</i> . If <i>col</i> is not nested, <i>att</i> is null.
val	NUMBER	Values of the attribute
bin	VARCHAR2(4000)	Bin assignments for the values



## Syntax

```
DBMS_DATA_MINING_TRANSFORM.CREATE_BIN_NUM (
    bin_table_name    IN VARCHAR2,
    bin_schema_name  IN VARCHAR2 DEFAULT NULL );
```

## Parameters

**Table 36-120 CREATE\_BIN\_NUM Procedure Parameters**

Parameter	Description
<code>bin_table_name</code>	Name of the transformation definition table to be created
<code>bin_schema_name</code>	Schema of <code>bin_table_name</code> . If no schema is specified, the current schema is used.

## Usage Notes

1. See *Oracle Data Mining User's Guide* for details about numerical data.
2. See "[Nested Data Transformations](#)" for information about transformation definition tables and nested data.
3. You can use the following procedures to populate the transformation definition table:
  - [INSERT\\_AUTOBIN\\_NUM\\_EQWIDTH Procedure](#) — automatic equi-width binning
  - [INSERT\\_BIN\\_NUM\\_EQWIDTH Procedure](#) — user-specified equi-width binning
  - [INSERT\\_BIN\\_NUM\\_QTILE Procedure](#) — quantile binning
  - [INSERT\\_BIN\\_SUPER Procedure](#) — supervised binning



### See Also:

"Binning" in [DBMS\\_DATA\\_MINING\\_TRANSFORM Overview](#)

"Operational Notes"

## Examples

The following statement creates a table called `bin_num_xtbl` in the current schema. The table has columns that can be populated with bin assignments for numerical attributes.

```
BEGIN
    DBMS_DATA_MINING_TRANSFORM.CREATE_BIN_NUM('bin_num_xtbl');
END;
/
```

```
DESCRIBE bin_num_xtbl
```

Name	Null?	Type
COL		VARCHAR2 (30)
ATT		VARCHAR2 (4000)
VAL		NUMBER
BIN		VARCHAR2 (4000)

### 36.2.3.3 CREATE\_CLIP Procedure

This procedure creates a transformation definition table for clipping or winsorizing to minimize the effect of outliers.

The columns are described in the following table.

**Table 36-121 Columns in a Transformation Definition Table for Clipping or Winsorizing**

Name	Datatype	Description
col	VARCHAR2 (30)	Name of a column of numerical data. If the column is not nested, the column name is also the attribute name. For information about attribute names, see <i>Oracle Data Mining User's Guide</i> .
att	VARCHAR2 (4000)	The attribute subname if <i>col</i> is a nested column of <code>DM_NESTED_NUMERICALS</code> . If <i>col</i> is nested, the attribute name is <i>col.att</i> . If <i>col</i> is not nested, <i>att</i> is null.
lcut	NUMBER	The lowest typical value for the attribute. If the attribute values were plotted on an <i>xy</i> axis, <i>lcut</i> would be the left-most boundary of the range of values considered typical for this attribute. Any values to the left of <i>lcut</i> are outliers.
lval	NUMBER	Value assigned to an outlier to the left of <i>lcut</i>
rcut	NUMBER	The highest typical value for the attribute If the attribute values were plotted on an <i>xy</i> axis, <i>rcut</i> would be the right-most boundary of the range of values considered typical for this attribute. Any values to the right of <i>rcut</i> are outliers.
rval	NUMBER	Value assigned to an outlier to the right of <i>rcut</i>

#### Syntax

```
DBMS_DATA_MINING_TRANSFORM.CREATE_CLIP (
    clip_table_name    IN VARCHAR2,
    clip_schema_name  IN VARCHAR2 DEFAULT NULL );
```

#### Parameters

**Table 36-122 CREATE\_CLIP Procedure Parameters**

Parameter	Description
clip_table_name	Name of the transformation definition table to be created
clip_schema_name	Schema of <i>clip_table_name</i> . If no schema is specified, the current schema is used.

#### Usage Notes

1. See *Oracle Data Mining User's Guide* for details about numerical data.

2. See ["Nested Data Transformations"](#) for information about transformation definition tables and nested data.
3. You can use the following procedures to populate the transformation definition table:
  - [INSERT\\_CLIP\\_TRIM\\_TAIL Procedure](#) — replaces outliers with nulls
  - [INSERT\\_CLIP\\_WINSOR\\_TAIL Procedure](#) — replaces outliers with an average value

 **See Also:**

"Outlier Treatment" in [DBMS\\_DATA\\_MINING\\_TRANSFORM Overview](#)

"Operational Notes"

### Examples

The following statement creates a table called `clip_xtbl` in the current schema. The table has columns that can be populated with clipping instructions for numerical attributes.

```
BEGIN
  DBMS_DATA_MINING_TRANSFORM.CREATE_CLIP('clip_xtbl');
END;
/
```

```
DESCRIBE clip_xtbl
```

Name	Null?	Type
COL		VARCHAR2 (30)
ATT		VARCHAR2 (4000)
LCUT		NUMBER
LVAL		NUMBER
RCUT		NUMBER
RVAL		NUMBER

### 36.2.3.4 CREATE\_COL\_REM Procedure

This procedure creates a transformation definition table for removing columns from the data table.

The columns are described in the following table.

**Table 36-123 Columns in a Transformation Definition Table for Column Removal**

Name	Datatype	Description
col	VARCHAR2 (30)	Name of a column of data. If the column is not nested, the column name is also the attribute name. For information about attribute names, see <i>Oracle Data Mining User's Guide</i> .
att	VARCHAR2 (4000)	The attribute subname if <i>col</i> is nested ( <code>DM_NESTED_NUMERICALS</code> or <code>DM_NESTED_CATEGORICALS</code> ). If <i>col</i> is nested, the attribute name is <i>col.att</i> . If <i>col</i> is not nested, <i>att</i> is null.

## Syntax

```
DBMS_DATA_MINING_TRANSFORM.CREATE_COL_REM (
    rem_table_name          VARCHAR2,
    rem_schema_name        VARCHAR2 DEFAULT NULL );
```

## Parameters

**Table 36-124 CREATE\_COL\_REM Procedure Parameters**

Parameter	Description
rem_table_name	Name of the transformation definition table to be created
rem_schema_name	Schema of <i>rem_table_name</i> . If no schema is specified, the current schema is used.

## Usage Notes

1. See "[Nested Data Transformations](#)" for information about transformation definition tables and nested data.
2. See "[Operational Notes](#)".

## Examples

The following statement creates a table called *rem\_att\_xtbl* in the current schema. The table has columns that can be populated with the names of attributes to exclude from the data to be mined.

```
BEGIN
    DBMS_DATA_MINING_TRANSFORM.CREATE_COL_REM ('rem_att_xtbl');
END;
/
DESCRIBE rem_att_xtbl
Name                               Null?    Type
-----
COL                                          VARCHAR2 (30)
ATT                                          VARCHAR2 (4000)
```

### 36.2.3.5 CREATE\_MISS\_CAT Procedure

This procedure creates a transformation definition table for replacing categorical missing values.

The columns are described in the following table.

**Table 36-125 Columns in a Transformation Definition Table for Categorical Missing Value Treatment**

Name	Datatype	Description
col	VARCHAR2 (30)	Name of a column of categorical data. If the column is not nested, the column name is also the attribute name. For information about attribute names, see <i>Oracle Data Mining User's Guide</i> .

**Table 36-125 (Cont.) Columns in a Transformation Definition Table for Categorical Missing Value Treatment**

Name	Datatype	Description
att	VARCHAR2(4000)	The attribute subname if <i>col</i> is a nested column of DM_NESTED_CATEGORICALS. If <i>col</i> is nested, the attribute name is <i>col.att</i> . If <i>col</i> is not nested, <i>att</i> is null.
val	VARCHAR2(4000)	Replacement for missing values in the attribute

### Syntax

```
DBMS_DATA_MINING_TRANSFORM.CREATE_MISS_CAT (
    miss_table_name      IN VARCHAR2,
    miss_schema_name    IN VARCHAR2 DEFAULT NULL );
```

### Parameters

**Table 36-126 CREATE\_MISS\_CAT Procedure Parameters**

Parameter	Description
miss_table_name	Name of the transformation definition table to be created
miss_schema_name	Schema of <i>miss_table_name</i> . If no schema is specified, the current schema is used.

### Usage Notes

1. See *Oracle Data Mining User's Guide* for details about categorical data.
2. See "[Nested Data Transformations](#)" for information about transformation definition tables and nested data.
3. You can use the [INSERT\\_MISS\\_CAT\\_MODE Procedure](#) to populate the transformation definition table.

#### See Also:

"Missing Value Treatment" in [DBMS\\_DATA\\_MINING\\_TRANSFORM Overview](#)  
"Operational Notes"

### Examples

The following statement creates a table called `miss_cat_xtbl` in the current schema. The table has columns that can be populated with values for missing data in categorical attributes.

```
BEGIN
    DBMS_DATA_MINING_TRANSFORM.CREATE_MISS_CAT('miss_cat_xtbl');
END;
/

DESCRIBE miss_cat_xtbl
```

Name	Null?	Type
COL		VARCHAR2 (30)
ATT		VARCHAR2 (4000)
VAL		VARCHAR2 (4000)

### 36.2.3.6 CREATE\_MISS\_NUM Procedure

This procedure creates a transformation definition table for replacing numerical missing values.

The columns are described in [Table 36-127](#).

**Table 36-127 Columns in a Transformation Definition Table for Numerical Missing Value Treatment**

Name	Datatype	Description
col	VARCHAR2 (30)	Name of a column of numerical data. If the column is not nested, the column name is also the attribute name. For information about attribute names, see <i>Oracle Data Mining User's Guide</i> .
att	VARCHAR2 (4000)	The attribute subname if <i>col</i> is a nested column of <code>DM_NESTED_NUMERICALS</code> . If <i>col</i> is nested, the attribute name is <i>col.att</i> . If <i>col</i> is not nested, <i>att</i> is null.
val	NUMBER	Replacement for missing values in the attribute

#### Syntax

```
DBMS_DATA_MINING_TRANSFORM.CREATE_MISS_NUM (
    miss_table_name      IN VARCHAR2,
    miss_schema_name    IN VARCHAR2 DEFAULT NULL );
```

#### Parameters

**Table 36-128 CREATE\_MISS\_NUM Procedure Parameters**

Parameter	Description
miss_table_name	Name of the transformation definition table to be created
miss_schema_name	Schema of <i>miss_table_name</i> . If no schema is specified, the current schema is used.

#### Usage Notes

1. See *Oracle Data Mining User's Guide* for details about numerical data.
2. See "[Nested Data Transformations](#)" for information about transformation definition tables and nested data.
3. You can use the [INSERT\\_MISS\\_NUM\\_MEAN Procedure](#) to populate the transformation definition table.

 **See Also:**

"Missing Value Treatment" in [DBMS\\_DATA\\_MINING\\_TRANSFORM Overview](#)  
 "Operational Notes"

**Example**

The following statement creates a table called `miss_num_xtbl` in the current schema. The table has columns that can be populated with values for missing data in numerical attributes.

```
BEGIN
  DBMS_DATA_MINING_TRANSFORM.CREATE_MISS_NUM('miss_num_xtbl');
END;
/
```

```
DESCRIBE miss_num_xtbl
Name                                         Null?    Type
-----
COL                                         VARCHAR2(30)
ATT                                         VARCHAR2(4000)
VAL                                         NUMBER
```

### 36.2.3.7 CREATE\_NORM\_LIN Procedure

This procedure creates a transformation definition table for linear normalization.

The columns are described in [Table 36-129](#).

**Table 36-129 Columns in a Transformation Definition Table for Linear Normalization**

Name	Datatype	Description
<code>col</code>	<code>VARCHAR2(30)</code>	Name of a column of numerical data. If the column is not nested, the column name is also the attribute name. For information about attribute names, see <i>Oracle Data Mining User's Guide</i> .
<code>att</code>	<code>VARCHAR2(4000)</code>	The attribute subname if <code>col</code> is a nested column of <code>DM_NESTED_NUMERICALS</code> . If <code>col</code> is nested, the attribute name is <code>col.att</code> . If <code>col</code> is not nested, <code>att</code> is null.
<code>shift</code>	<code>NUMBER</code>	A constant to subtract from the attribute values
<code>scale</code>	<code>NUMBER</code>	A constant by which to divide the shifted values

**Syntax**

```
DBMS_DATA_MINING_TRANSFORM.CREATE_NORM_LIN (
  norm_table_name      IN VARCHAR2,
  norm_schema_name     IN VARCHAR2 DEFAULT NULL );
```

## Parameters

**Table 36-130 CREATE\_NORM\_LIN Procedure Parameters**

Parameter	Description
<code>norm_table_name</code>	Name of the transformation definition table to be created
<code>norm_schema_name</code>	Schema of <code>norm_table_name</code> . If no schema is specified, the current schema is used.

## Usage Notes

1. See *Oracle Data Mining User's Guide* for details about numerical data.
2. See "[Nested Data Transformations](#)" for information about transformation definition tables and nested data.
3. You can use the following procedures to populate the transformation definition table:
  - [INSERT\\_NORM\\_LIN\\_MINMAX Procedure](#) — Uses linear min-max normalization
  - [INSERT\\_NORM\\_LIN\\_SCALE Procedure](#) — Uses linear scale normalization
  - [INSERT\\_NORM\\_LIN\\_ZSCORE Procedure](#) — Uses linear zscore normalization

### See Also:

"Linear Normalization" in [DBMS\\_DATA\\_MINING\\_TRANSFORM Overview](#)  
["Operational Notes"](#)

## Examples

The following statement creates a table called `norm_xtbl` in the current schema. The table has columns that can be populated with shift and scale values for normalizing numerical attributes.

```
BEGIN
    DBMS_DATA_MINING_TRANSFORM.CREATE_NORM_LIN('norm_xtbl');
END;
/
```

```
DESCRIBE norm_xtbl
Name                                     Null?      Type
-----
COL                                       V          VARCHAR2 (30)
ATT                                       V          VARCHAR2 (4000)
SHIFT                                     V          NUMBER
SCALE                                     V          NUMBER
```

### 36.2.3.8 DESCRIBE\_STACK Procedure

This procedure describes the columns of the data table after a list of transformations has been applied.

Only the columns that are specified in the transformation list are transformed. The remaining columns in the data table are included in the output without changes.



To create a view of the data table after the transformations have been applied, use the [XFORM\\_STACK Procedure](#).

### Syntax

```
DBMS_DATA_MINING_TRANSFORM.DESCRIBE_STACK (
    xform_list          IN  TRANSFORM_LIST,
    data_table_name     IN  VARCHAR2,
    describe_list      OUT DESCRIBE_LIST,
    data_schema_name    IN  VARCHAR2 DEFAULT NULL);
```

### Parameters

**Table 36-131 DESCRIBE\_STACK Procedure Parameters**

Parameter	Description
<code>xform_list</code>	A list of transformations. See <a href="#">Table 36-114</a> for a description of the <code>TRANSFORM_LIST</code> object type.
<code>data_table_name</code>	Name of the table containing the data to be transformed
<code>describe_list</code>	Descriptions of the columns in the data table after the transformations specified in <code>xform_list</code> have been applied. See <a href="#">Table 36-114</a> for a description of the <code>DESCRIBE_LIST</code> object type.
<code>data_schema_name</code>	Schema of <code>data_table_name</code> . If no schema is specified, the current schema is used.

### Usage Notes

See "[Operational Notes](#)" for information about transformation lists and embedded transformations.

### Examples

This example shows the column name and datatype, the column name length, and the column maximum length for the view `dmuser.cust_info` after the transformation list has been applied. All the transformations are user-specified. The results of `DESCRIBE_STACK` do not include one of the columns in the original table, because the `SET_TRANSFORM` procedure sets that column to `NULL`.

```
CREATE OR REPLACE VIEW cust_info AS
    SELECT a.cust_id, c.country_id, c.cust_year_of_birth,
    CAST(COLLECT(DM_Nested_Numerical(
        b.prod_name, 1))
    AS DM_Nested_Numericals) custprods
    FROM sh.sales a, sh.products b, sh.customers c
    WHERE a.prod_id = b.prod_id AND
    a.cust_id=c.cust_id and
    a.cust_id between 100001 AND 105000
    GROUP BY a.cust_id, country_id, cust_year_of_birth;
```

```
describe cust_info
Name                                                    Null?    Type
-----
CUST_ID                                                NOT NULL NUMBER
COUNTRY_ID                                             NOT NULL NUMBER
CUST_YEAR_OF_BIRTH                                     NOT NULL NUMBER(4)
CUSTPRODS                                             SYS.DM_NESTED_NUMERICALS

DECLARE
```

```

    cust_stack dbms_data_mining_transform.TRANSFORM_LIST;
    cust_cols dbms_data_mining_transform.DESCRIBE_LIST;
BEGIN
    dbms_data_mining_transform.SET_TRANSFORM (cust_stack,
        'country_id', NULL, 'country_id/10', 'country_id*10');
    dbms_data_mining_transform.SET_TRANSFORM (cust_stack,
        'cust_year_of_birth', NULL, NULL, NULL);
    dbms_data_mining_transform.SET_TRANSFORM (cust_stack,
        'custprods', 'Mouse Pad', 'value*100', 'value/100');
    dbms_data_mining_transform.DESCRIBE_STACK(
        xform_list => cust_stack,
        data_table_name => 'cust_info',
        describe_list => cust_cols);
    dbms_output.put_line('====');
    for i in 1..cust_cols.COUNT loop
        dbms_output.put_line('COLUMN_NAME:      ||cust_cols(i).col_name);
        dbms_output.put_line('COLUMN_TYPE:      ||cust_cols(i).col_type);
        dbms_output.put_line('COLUMN_NAME_LEN:  ||cust_cols(i).col_name_len);
        dbms_output.put_line('COLUMN_MAX_LEN:  ||cust_cols(i).col_max_len);
        dbms_output.put_line('====');
    END loop;
END;
/
====
COLUMN_NAME:      CUST_ID
COLUMN_TYPE:      2
COLUMN_NAME_LEN:  7
COLUMN_MAX_LEN:   22
====
COLUMN_NAME:      COUNTRY_ID
COLUMN_TYPE:      2
COLUMN_NAME_LEN:  10
COLUMN_MAX_LEN:   22
====
COLUMN_NAME:      CUSTPRODS
COLUMN_TYPE:      100001
COLUMN_NAME_LEN:  9
COLUMN_MAX_LEN:   40
====

```

### 36.2.3.9 GET\_EXPRESSION Function

This function returns a row from a VARCHAR2 array that stores a transformation expression. The array is built by calls to the SET\_EXPRESSION Procedure.

The array can be used for specifying SQL expressions that are too long to be used with the SET\_TRANSFORM Procedure.

#### Syntax

```

DBMS_DATA_MINING_TRANSFORM.GET_EXPRESSION (
    expression          IN EXPRESSION_REC,
    chunk_num          IN PLS_INTEGER DEFAULT NULL);
RETURN VARCHAR2;

```

## Parameters

**Table 36-132 GET\_EXPRESSION Function Parameters**

Parameter	Description
<code>expression</code>	An expression record ( <code>EXPRESSION_REC</code> ) that specifies a transformation expression or a reverse transformation expression for an attribute. Each expression record includes a <code>VARCHAR2</code> array and index fields for specifying upper and lower boundaries within the array.  There are two <code>EXPRESSION_REC</code> fields within a transformation record ( <code>TRANSFORM_REC</code> ): one for the transformation expression; the other for the reverse transformation expression.  See <a href="#">Table 36-114</a> for a description of the <code>EXPRESSION_REC</code> type.
<code>chunk</code>	A <code>VARCHAR2</code> chunk (row) to be appended to <code>expression</code> .

## Usage Notes

1. Chunk numbering starts with one. For chunks outside of the range, the return value is null. When a chunk number is null the whole expression is returned as a string. If the expression is too big, a `VALUE_ERROR` is raised.
2. See "[About Transformation Lists](#)".
3. See "[Operational Notes](#)".

## Examples

See the example for the [SET\\_EXPRESSION Procedure](#).

## Related Topics

- [SET\\_EXPRESSION Procedure](#)  
This procedure appends a row to a `VARCHAR2` array that stores a SQL expression.
- [SET\\_TRANSFORM Procedure](#)  
This procedure appends the transformation instructions for an attribute to a transformation list.

### 36.2.3.10 INSERT\_AUTOBIN\_NUM\_EQWIDTH Procedure

This procedure performs numerical binning and inserts the transformation definitions in a transformation definition table. The procedure identifies the minimum and maximum values and computes the bin boundaries at equal intervals.

`INSERT_AUTOBIN_NUM_EQWIDTH` computes the number of bins separately for each column. If you want to use equi-width binning with the same number of bins for each column, use the [INSERT\\_BIN\\_NUM\\_EQWIDTH Procedure](#).

`INSERT_AUTOBIN_NUM_EQWIDTH` bins all the `NUMBER` and `FLOAT` columns in the data source unless you specify a list of columns to ignore.

## Syntax

```
DBMS_DATA_MINING_TRANSFORM.INSERT_AUTOBIN_NUM_EQWIDTH (
    bin_table_name      IN VARCHAR2,
    data_table_name     IN VARCHAR2,
    bin_num             IN PLS_INTEGER DEFAULT 3,
```

```

max_bin_num          IN PLS_INTEGER DEFAULT 100,
exclude_list         IN COLUMN_LIST DEFAULT NULL,
round_num            IN PLS_INTEGER DEFAULT 6,
sample_size          IN PLS_INTEGER DEFAULT 50000,
bin_schema_name      IN VARCHAR2 DEFAULT NULL,
data_schema_name     IN VARCHAR2 DEFAULT NULL,
rem_table_name       IN VARCHAR2 DEFAULT NULL,
rem_schema_name      IN VARCHAR2 DEFAULT NULL));

```

## Parameters

**Table 36-133** INSERT\_AUTOBIN\_NUM\_EQWIDTH Procedure Parameters

Parameter	Description
bin_table_name	<p>Name of the transformation definition table for numerical binning. You can use the <a href="#">CREATE_BIN_NUM Procedure</a> to create the definition table. The following columns are required:</p> <pre> COL          VARCHAR2(30) VAL          NUMBER BIN          VARCHAR2(4000) </pre> <p>CREATE_BIN_NUM creates an additional column, ATT, which may be used for specifying nested attributes. This column is not used by INSERT_AUTOBIN_NUM_EQWIDTH.</p>
data_table_name	Name of the table containing the data to be transformed
bin_num	<p>Minimum number of bins. If <i>bin_num</i> is 0 or NULL, it is ignored. The default value of <i>bin_num</i> is 3.</p>
max_bin_num	<p>Maximum number of bins. If <i>max_bin_num</i> is 0 or NULL, it is ignored. The default value of <i>max_bin_num</i> is 100.</p>
exclude_list	<p>List of numerical columns to be excluded from the binning process. If you do not specify <i>exclude_list</i>, all numerical columns in the data source are binned.</p> <p>The format of <i>exclude_list</i> is:</p> <pre> dbms_data_mining_transform.COLUMN_LIST('col1','col2',  ...'coln') </pre>
round_num	<p>Specifies how to round the number in the VAL column of the transformation definition table.</p> <p>When <i>round_num</i> is positive, it specifies the most significant digits to retain. When <i>round_num</i> is negative, it specifies the least significant digits to remove. In both cases, the result is rounded to the specified number of digits. See the Usage Notes for an example.</p> <p>The default value of <i>round_num</i> is 6.</p>
sample_size	<p>Size of the data sample. If <i>sample_size</i> is less than the total number of non-NULL values in the column, then <i>sample_size</i> is used instead of the SQL COUNT function in computing the number of bins. If <i>sample_size</i> is 0 or NULL, it is ignored. See the Usage Notes.</p> <p>The default value of <i>sample_size</i> is 50,000.</p>
bin_schema_name	Schema of <i>bin_table_name</i> . If no schema is specified, the current schema is used.
data_schema_name	Schema of <i>data_table_name</i> . If no schema is specified, the current schema is used.

**Table 36-133 (Cont.) INSERT\_AUTOBIN\_NUM\_EQWIDTH Procedure Parameters**

Parameter	Description
<code>rem_table_name</code>	Name of a transformation definition table for column removal. The table must have the columns described in " <a href="#">CREATE_COL_REM Procedure</a> ".  INSERT_AUTOBIN_NUM_EQWIDTH ignores columns with all nulls or only one unique value. If you specify a value for <code>rem_table_name</code> , these columns are removed from the mining data. If you do not specify a value for <code>rem_table_name</code> , these unbinned columns remain in the data.
<code>rem_schema_name</code>	Schema of <code>rem_table_name</code> . If no schema is specified, the current schema is used.

**Usage Notes**

1. See *Oracle Data Mining User's Guide* for details about numerical data.
2. INSERT\_AUTOBIN\_NUM\_EQWIDTH computes the number of bins for a column based on the number of non-null values (COUNT), the maximum (MAX), the minimum (MIN), the standard deviation (STDDEV), and the constant  $C=3.49/0.9$ :  
  

$$N = \text{floor}(\text{power}(\text{COUNT}, 1/3) * (\text{max} - \text{min}) / (c * \text{dev}))$$

If the `sample_size` parameter is specified, it is used instead of COUNT.  
  
See *Oracle Database SQL Language Reference* for information about the COUNT, MAX, MIN, STDDEV, FLOOR, and POWER functions.
3. INSERT\_AUTOBIN\_NUM\_EQWIDTH uses absolute values to compute the number of bins. The sign of the parameters `bin_num`, `max_bin_num`, and `sample_size` has no effect on the result.
4. In computing the number of bins, INSERT\_AUTOBIN\_NUM\_EQWIDTH evaluates the following criteria in the following order:
  - a. The minimum number of bins (`bin_num`)
  - b. The maximum number of bins (`max_bin_num`)
  - c. The maximum number of bins for integer columns, calculated as the number of distinct values in the range `max-min+1`.
5. The `round_num` parameter controls the rounding of column values in the transformation definition table, as follows:

**For a value of 308.162:**

```

when round_num = 1      result is 300
when round_num = 2      result is 310
when round_num = 3      result is 308
when round_num = 0      result is 308.162
when round_num = -1     result is 308.16
when round_num = -2     result is 308.2

```

**Examples**

In this example, INSERT\_AUTOBIN\_NUM\_EQWIDTH computes the bin boundaries for the `cust_year_of_birth` column in `sh.customers` and inserts the transformations in a transformation definition table. The [STACK\\_BIN\\_NUM Procedure](#) creates a transformation list from the contents of the definition table. The [CREATE\\_MODEL Procedure](#) embeds the transformation list in a new model called `nb_model`.

The transformation and reverse transformation expressions embedded in `nb_model` are returned by the [GET\\_MODEL\\_TRANSFORMATIONS Function](#).

```
CREATE OR REPLACE VIEW mining_data AS
    SELECT cust_id, cust_year_of_birth, cust_postal_code
    FROM sh.customers;

DESCRIBE mining_data
Name                               Null?    Type
-----
CUST_ID                             NOT NULL NUMBER
CUST_YEAR_OF_BIRTH                   NOT NULL NUMBER(4)
CUST_POSTAL_CODE                     NOT NULL VARCHAR2(10)

BEGIN
    dbms_data_mining_transform.CREATE_BIN_NUM(
        bin_table_name => 'bin_tbl');
    dbms_data_mining_transform.INSERT_AUTOBIN_NUM_EQWIDTH (
        bin_table_name => 'bin_tbl',
        data_table_name => 'mining_data',
        bin_num         => 3,
        max_bin_num     => 5,
        exclude_list    => dbms_data_mining_transform.COLUMN_LIST('cust_id'));
END;
/

set numwidth 4
column val off
SELECT col, val, bin FROM bin_tbl
    ORDER BY val ASC;

COL                               VAL BIN
-----
CUST_YEAR_OF_BIRTH                1913
CUST_YEAR_OF_BIRTH                1928 1
CUST_YEAR_OF_BIRTH                1944 2
CUST_YEAR_OF_BIRTH                1959 3
CUST_YEAR_OF_BIRTH                1975 4
CUST_YEAR_OF_BIRTH                1990 5

DECLARE
    year_birth_xform  dbms_data_mining_transform.TRANSFORM_LIST;
BEGIN
    dbms_data_mining_transform.STACK_BIN_NUM (
        bin_table_name => 'bin_tbl',
        xform_list     => year_birth_xform);
    dbms_data_mining.CREATE_MODEL(
        model_name      => 'nb_model',
        mining_function => dbms_data_mining.classification,
        data_table_name => 'mining_data',
        case_id_column_name => 'cust_id',
        target_column_name => 'cust_postal_code',
        settings_table_name => null,
        data_schema_name   => null,
        settings_schema_name => null,
        xform_list         => year_birth_xform);
END;
/

SELECT attribute_name
    FROM TABLE(dbms_data_mining.GET_MODEL_TRANSFORMATIONS('nb_model'));
```

```

ATTRIBUTE_NAME
-----
CUST_YEAR_OF_BIRTH

SELECT expression
      FROM TABLE(dbms_data_mining.GET_MODEL_TRANSFORMATIONS('nb_model'));

EXPRESSION
-----
CASE WHEN "CUST_YEAR_OF_BIRTH"<1913 THEN NULL WHEN "CUST_YEAR_OF_BIRTH"<=1928.4
 THEN '1' WHEN "CUST_YEAR_OF_BIRTH"<=1943.8 THEN '2' WHEN "CUST_YEAR_OF_BIRTH"
<=1959.2 THEN '3' WHEN "CUST_YEAR_OF_BIRTH"<=1974.6 THEN '4' WHEN
"CUST_YEAR_OF_BIRTH" <=1990 THEN '5' END

SELECT reverse_expression
      FROM TABLE(dbms_data_mining.GET_MODEL_TRANSFORMATIONS('nb_model'));

REVERSE_EXPRESSION
-----
DECODE("CUST_YEAR_OF_BIRTH",'5', '(1974.6; 1990]', '1', '[1913; 1928.4]', '2', '(1928
.4; 1943.8]', '3', '(1943.8; 1959.2]', '4', '(1959.2; 1974.6]', NULL, '( ; 1913), (19
0; ), NULL')

```

### 36.2.3.11 INSERT\_BIN\_CAT\_FREQ Procedure

This procedure performs categorical binning and inserts the transformation definitions in a transformation definition table. The procedure computes the bin boundaries based on frequency.

INSERT\_BIN\_CAT\_FREQ bins all the CHAR and VARCHAR2 columns in the data source unless you specify a list of columns to ignore.

#### Syntax

```

DBMS_DATA_MINING_TRANSFORM.INSERT_BIN_CAT_FREQ (
  bin_table_name      IN VARCHAR2,
  data_table_name     IN VARCHAR2,
  bin_num             IN PLS_INTEGER DEFAULT 9,
  exclude_list        IN COLUMN_LIST DEFAULT NULL,
  default_num         IN PLS_INTEGER DEFAULT 2,
  bin_support         IN NUMBER DEFAULT NULL,
  bin_schema_name     IN VARCHAR2 DEFAULT NULL,
  data_schema_name    IN VARCHAR2 DEFAULT NULL);

```

## Parameters

**Table 36-134 INSERT\_BIN\_CAT\_FREQ Procedure Parameters**

Parameter	Description
<code>bin_table_name</code>	<p>Name of the transformation definition table for categorical binning. You can use the <a href="#">CREATE_BIN_CAT Procedure</a> to create the definition table. The following columns are required:</p> <pre>COL      VARCHAR2 (30) VAL      VARCHAR2 (4000) BIN      VARCHAR2 (4000)</pre> <p><code>CREATE_BIN_CAT</code> creates an additional column, <code>ATT</code>, which may be used for specifying nested attributes. This column is not used by <code>INSERT_BIN_CAT_FREQ</code>.</p>
<code>data_table_name</code>	Name of the table containing the data to be transformed
<code>bin_num</code>	<p>The number of bins to fill using frequency-based binning. The total number of bins will be <code>bin_num+1</code>. The additional bin is the default bin. Classes that are not assigned to a frequency-based bin will be assigned to the default bin.</p> <p>The default binning order is from highest to lowest: the most frequently occurring class is assigned to the first bin, the second most frequently occurring class is assigned to the second bin, and so on. You can reverse the binning order by specifying a negative number for <code>bin_num</code>. The negative sign causes the binning order to be from lowest to highest.</p> <p>If the total number of distinct values (classes) in the column is less than <code>bin_num</code>, then a separate bin will be created for each value and the default bin will be empty.</p> <p>If you specify <code>NULL</code> or <code>0</code> for <code>bin_num</code>, no binning is performed.</p> <p>The default value of <code>bin_num</code> is 9.</p>
<code>exclude_list</code>	<p>List of categorical columns to be excluded from the binning process. If you do not specify <code>exclude_list</code>, all categorical columns in the data source are binned.</p> <p>The format of <code>exclude_list</code> is:</p> <pre>dbms_data_mining_transform.COLUMN_LIST('col1','col2', ... 'coln')</pre>
<code>default_num</code>	<p>The number of class occurrences (rows of the same class) required for assignment to the default bin.</p> <p>By default, <code>default_num</code> is the minimum number of occurrences required for assignment to the default bin. For example, if <code>default_num</code> is 3 and a given class occurs only once, it will not be assigned to the default bin. You can change the occurrence requirement from minimum to maximum by specifying a negative number for <code>default_num</code>. For example, if <code>default_num</code> is -3 and a given class occurs only once, it <i>will</i> be assigned to the default bin, but a class that occurs four or more times will not be included.</p> <p>If you specify <code>NULL</code> or <code>0</code> for <code>default_bin</code>, there are no requirements for assignment to the default bin.</p> <p>The default value of <code>default_num</code> is 2.</p>



**Table 36-134 (Cont.) INSERT\_BIN\_CAT\_FREQ Procedure Parameters**

Parameter	Description
<code>bin_support</code>	<p>The number of class occurrences (rows of the same class) required for assignment to a frequency-based bin. <i>bin_support</i> is expressed as a fraction of the total number of rows.</p> <p>By default, <i>bin_support</i> is the minimum percentage required for assignment to a frequency-based bin. For example, if there are twenty rows of data and you specify .2 for <i>bin_support</i>, then there must be four or more occurrences of a class (.2*20) in order for it to be assigned to a frequency-based bin. You can change <i>bin_support</i> from a minimum percentage to a maximum percentage by specifying a negative number for <i>bin_support</i>. For example, if there are twenty rows of data and you specify -.2 for <i>bin_support</i>, then there must be four or less occurrences of a class in order for it to be assigned to a frequency-based bin.</p> <p>Classes that occur less than a positive <i>bin_support</i> or more than a negative <i>bin_support</i> will be assigned to the default bin.</p> <p>If you specify NULL or 0 for <i>bin_support</i>, then there is no support requirement for frequency-based binning.</p> <p>The default value of <i>bin_support</i> is NULL.</p>
<code>bin_schema_name</code>	Schema of <i>bin_table_name</i> . If no schema is specified, the current schema is used.
<code>data_schema_name</code>	Schema of <i>data_table_name</i> . If no schema is specified, the current schema is used.

**Usage Notes**

1. See *Oracle Data Mining User's Guide* for details about categorical data.
2. If values occur with the same frequency, `INSERT_BIN_CAT_FREQ` assigns them in descending order when binning is from most to least frequent, or in ascending order when binning is from least to most frequent.

**Examples**

1. In this example, `INSERT_BIN_CAT_FREQ` computes the bin boundaries for the `cust_postal_code` and `cust_city` columns in `sh.customers` and inserts the transformations in a transformation definition table. The [STACK\\_BIN\\_CAT Procedure](#) creates a transformation list from the contents of the definition table, and the [CREATE\\_MODEL Procedure](#) embeds the transformation list in a new model called `nb_model`.

The transformation and reverse transformation expressions embedded in `nb_model` are returned by the [GET\\_MODEL\\_TRANSFORMATIONS Function](#).

```
CREATE OR REPLACE VIEW mining_data AS
SELECT cust_id, cust_year_of_birth, cust_postal_code, cust_city
FROM sh.customers;
```

```
DESCRIBE mining_data
Name                               Null?    Type
-----
CUST_ID                             NOT NULL NUMBER
CUST_YEAR_OF_BIRTH                   NOT NULL NUMBER(4)
CUST_POSTAL_CODE                     NOT NULL VARCHAR2(10)
CUST_CITY                             NOT NULL VARCHAR2(30)
```

```

BEGIN
  dbms_data_mining_transform.CREATE_BIN_CAT(
    bin_table_name => 'bin_tbl_1');
  dbms_data_mining_transform.INSERT_BIN_CAT_FREQ (
    bin_table_name => 'bin_tbl_1',
    data_table_name => 'mining_data',
    bin_num        => 4);
END;
/

column col format a18
column val format a15
column bin format a10
SELECT col, val, bin
       FROM bin_tbl_1
       ORDER BY col ASC, bin ASC;

COL              VAL              BIN
-----
CUST_CITY        Los Angeles    1
CUST_CITY        Greenwich     2
CUST_CITY        Killarney     3
CUST_CITY        Montara       4
CUST_CITY
CUST_POSTAL_CODE 38082         1
CUST_POSTAL_CODE 63736         2
CUST_POSTAL_CODE 55787         3
CUST_POSTAL_CODE 78558         4
CUST_POSTAL_CODE

DECLARE
  city_xform  dbms_data_mining_transform.TRANSFORM_LIST;
BEGIN
  dbms_data_mining_transform.STACK_BIN_CAT (
    bin_table_name => 'bin_tbl_1',
    xform_list     => city_xform);
  dbms_data_mining.CREATE_MODEL(
    model_name     => 'nb_model',
    mining_function => dbms_data_mining.classification,
    data_table_name => 'mining_data',
    case_id_column_name => 'cust_id',
    target_column_name => 'cust_city',
    settings_table_name => null,
    data_schema_name   => null,
    settings_schema_name => null,
    xform_list        => city_xform);
END;
/

SELECT attribute_name
       FROM TABLE(dbms_data_mining.GET_MODEL_TRANSFORMATIONS('nb_model'));

ATTRIBUTE_NAME
-----
CUST_CITY
CUST_POSTAL_CODE

SELECT expression
       FROM TABLE(dbms_data_mining.GET_MODEL_TRANSFORMATIONS('nb_model'));

EXPRESSION

```

```

-----
DECODE("CUST_CITY", 'Greenwich', '2', 'Killarney', '3', 'Los Angeles', '1',
'Montara', '4', NULL, NULL, '5')
DECODE("CUST_POSTAL_CODE", '38082', '1', '55787', '3', '63736', '2', '78558', '4', NULL, NULL, '5')

SELECT reverse_expression
       FROM TABLE(dbms_data_mining.GET_MODEL_TRANSFORMATIONS('nb_model'));

REVERSE_EXPRESSION
-----
DECODE("CUST_CITY", '2', ''Greenwich'', '3', ''Killarney'', '1',
''Los Angeles'', '4', ''Montara'', NULL, 'NULL', '5', 'DEFAULT')
DECODE("CUST_POSTAL_CODE", '1', ''38082'', '3', ''55787'', '2', ''63736'',
'4', ''78558'', NULL, 'NULL', '5', 'DEFAULT')

```

- The binning order in example 1 is from most frequent to least frequent. The following example shows reverse order binning (least frequent to most frequent). The binning order is reversed by setting *bin\_num* to -4 instead of 4.

```

BEGIN
  dbms_data_mining_transform.CREATE_BIN_CAT(
    bin_table_name => 'bin_tbl_reverse');
  dbms_data_mining_transform.INSERT_BIN_CAT_FREQ (
    bin_table_name => 'bin_tbl_reverse',
    data_table_name => 'mining_data',
    bin_num         => -4);
END;
/

column col format a20
SELECT col, val, bin
       FROM bin_tbl_reverse
       ORDER BY col ASC, bin ASC;

```

COL	VAL	BIN
-----	-----	-----
CUST_CITY	Tokyo	1
CUST_CITY	Sliedrecht	2
CUST_CITY	Haarlem	3
CUST_CITY	Diemen	4
CUST_CITY		5
CUST_POSTAL_CODE	49358	1
CUST_POSTAL_CODE	80563	2
CUST_POSTAL_CODE	74903	3
CUST_POSTAL_CODE	71349	4
CUST_POSTAL_CODE		5

### 36.2.3.12 INSERT\_BIN\_NUM\_EQWIDTH Procedure

This procedure performs numerical binning and inserts the transformation definitions in a transformation definition table. The procedure identifies the minimum and maximum values and computes the bin boundaries at equal intervals.

INSERT\_BIN\_NUM\_EQWIDTH computes a specified number of bins (*n*) and assigns  $(max-min)/n$  values to each bin. The number of bins is the same for each column. If you want to use equi-width binning, but you want the number of bins to be calculated on a per-column basis, use the [INSERT\\_AUTOBIN\\_NUM\\_EQWIDTH Procedure](#).

INSERT\_BIN\_NUM\_EQWIDTH bins all the NUMBER and FLOAT columns in the data source unless you specify a list of columns to ignore.

## Syntax

```
DBMS_DATA_MINING_TRANSFORM.INSERT_BIN_NUM_EQWIDTH (
  bin_table_name      IN VARCHAR2,
  data_table_name     IN VARCHAR2,
  bin_num             IN PLS_INTEGER DEFAULT 10,
  exclude_list        IN COLUMN_LIST DEFAULT NULL,
  round_num           IN PLS_INTEGER DEFAULT 6,
  bin_schema_name     IN VARCHAR2 DEFAULT NULL,
  data_schema_name    IN VARCHAR2 DEFAULT NULL);
```

## Parameters

**Table 36-135 INSERT\_BIN\_NUM\_EQWIDTH Procedure Parameters**

Parameter	Description
bin_table_name	<p>Name of the transformation definition table for numerical binning. You can use the <a href="#">CREATE_BIN_NUM Procedure</a> to create the definition table. The following columns are required:</p> <pre>COL      VARCHAR2(30) VAL      NUMBER BIN      VARCHAR2(4000)</pre> <p>CREATE_BIN_NUM creates an additional column, ATT, which may be used for specifying nested attributes. This column is not used by INSERT_BIN_NUM_EQWIDTH.</p>
data_table_name	Name of the table containing the data to be transformed
bin_num	<p>Number of bins. No binning occurs if <i>bin_num</i> is 0 or NULL.</p> <p>The default number of bins is 10.</p>
exclude_list	<p>List of numerical columns to be excluded from the binning process. If you do not specify <i>exclude_list</i>, all numerical columns in the data source are binned.</p> <p>The format of <i>exclude_list</i> is:</p> <pre>dbms_data_mining_transform.COLUMN_LIST('col1','col2',  ...'coln')</pre>
round_num	<p>Specifies how to round the number in the VAL column of the transformation definition table.</p> <p>When <i>round_num</i> is positive, it specifies the most significant digits to retain. When <i>round_num</i> is negative, it specifies the least significant digits to remove. In both cases, the result is rounded to the specified number of digits. See the Usage Notes for an example.</p> <p>The default value of <i>round_num</i> is 6.</p>
bin_schema_name	Schema of <i>bin_table_name</i> . If no schema is specified, the current schema is used.
data_schema_name	Schema of <i>data_table_name</i> . If no schema is specified, the current schema is used.

## Usage Notes

1. See *Oracle Data Mining User's Guide* for details about numerical data.

- The `round_num` parameter controls the rounding of column values in the transformation definition table, as follows:

**For a value of 308.162:**

```

when round_num = 1      result is 300
when round_num = 2      result is 310
when round_num = 3      result is 308
when round_num = 0      result is 308.162
when round_num = -1     result is 308.16
when round_num = -2     result is 308.2

```

- `INSERT_BIN_NUM_EQWIDTH` ignores columns with all NULL values or only one unique value.

### Examples

In this example, `INSERT_BIN_NUM_EQWIDTH` computes the bin boundaries for the `affinity_card` column in `mining_data_build` and inserts the transformations in a transformation definition table. The [STACK\\_BIN\\_NUM Procedure](#) creates a transformation list from the contents of the definition table. The [CREATE\\_MODEL Procedure](#) embeds the transformation list in a new model called `glm_model`.

The transformation and reverse transformation expressions embedded in `glm_model` are returned by the [GET\\_MODEL\\_TRANSFORMATIONS Function](#).

```

CREATE OR REPLACE VIEW mining_data AS
    SELECT cust_id, cust_income_level, cust_gender, affinity_card
    FROM mining_data_build;

DESCRIBE mining_data
Name                               Null?    Type
-----
CUST_ID                             NOT NULL NUMBER
CUST_INCOME_LEVEL                   VARCHAR2(30)
CUST_GENDER                          VARCHAR2(1)
AFFINITY_CARD                        NUMBER(10)

BEGIN
    dbms_data_mining_transform.CREATE_BIN_NUM(
        bin_table_name => 'bin_tbl');
    dbms_data_mining_transform.INSERT_BIN_NUM_EQWIDTH (
        bin_table_name => 'bin_tbl',
        data_table_name => 'mining_data',
        bin_num        => 4,
        exclude_list  => dbms_data_mining_transform.COLUMN_LIST('cust_id'));
END;
/

set numwidth 10
column val off
column col format a20
column bin format a10
SELECT col, val, bin FROM bin_tbl
    ORDER BY val ASC;

COL                               VAL  BIN
-----
AFFINITY_CARD                      0
AFFINITY_CARD                      .25  1
AFFINITY_CARD                      .5   2
AFFINITY_CARD                      .75  3
AFFINITY_CARD                      1    4

```

```
CREATE TABLE glmsettings(
    setting_name VARCHAR2(30),
    setting_value VARCHAR2(30));

BEGIN
    INSERT INTO glmsettings (setting_name, setting_value) VALUES
        (dbms_data_mining.algo_name, dbms_data_mining.algo_generalized_linear_model);
    COMMIT;
END;
/

DECLARE
    xforms dbms_data_mining_transform.TRANSFORM_LIST;
BEGIN
    dbms_data_mining_transform.STACK_BIN_NUM (
        bin_table_name      => 'bin_tbl',
        xform_list          => xforms,
        literal_flag        => TRUE);
    dbms_data_mining.CREATE_MODEL(
        model_name          => 'glm_model',
        mining_function     => dbms_data_mining.regression,
        data_table_name     => 'mining_data',
        case_id_column_name => 'cust_id',
        target_column_name  => 'affinity_card',
        settings_table_name => 'glmsettings',
        data_schema_name    => null,
        settings_schema_name => null,
        xform_list          => xforms);
END;
/

SELECT attribute_name
    FROM TABLE(dbms_data_mining.GET_MODEL_TRANSFORMATIONS('glm_model'));

ATTRIBUTE_NAME
-----
AFFINITY_CARD

SELECT expression
    FROM TABLE(dbms_data_mining.GET_MODEL_TRANSFORMATIONS('glm_model'));

EXPRESSION
-----
CASE WHEN "AFFINITY_CARD"<0 THEN NULL WHEN "AFFINITY_CARD"<=.25 THEN 1 WHEN
"AFFINITY_CARD"<=.5 THEN 2 WHEN "AFFINITY_CARD"<=.75 THEN 3 WHEN
"AFFINITY_CARD"<=1 THEN 4 END

SELECT reverse_expression
    FROM TABLE(dbms_data_mining.GET_MODEL_TRANSFORMATIONS('glm_model'));

REVERSE_EXPRESSION
-----
DECODE("AFFINITY_CARD",4, '( .75; 1]',1, '[0; .25]',2, '( .25; .5]',3, '( .5; .75]',
NULL, '( ; 0), (1; ), NULL')
```

### 36.2.3.13 INSERT\_BIN\_NUM\_QTILE Procedure

This procedure performs numerical binning and inserts the transformation definitions in a transformation definition table. The procedure calls the SQL `NTILE` function to order the data and divide it equally into the specified number of bins (quantiles).

`INSERT_BIN_NUM_QTILE` bins all the `NUMBER` and `FLOAT` columns in the data source unless you specify a list of columns to ignore.

#### Syntax

```
DBMS_DATA_MINING_TRANSFORM.INSERT_BIN_NUM_QTILE (
  bin_table_name      IN VARCHAR2,
  data_table_name     IN VARCHAR2,
  bin_num             IN PLS_INTEGER DEFAULT 10,
  exclude_list       IN COLUMN_LIST DEFAULT NULL,
  bin_schema_name     IN VARCHAR2 DEFAULT NULL,
  data_schema_name    IN VARCHAR2 DEFAULT NULL);
```

#### Parameters

**Table 36-136** INSERT\_BIN\_NUM\_QTILE Procedure Parameters

Parameter	Description						
<code>bin_table_name</code>	Name of the transformation definition table for numerical binning. You can use the <a href="#">CREATE_BIN_NUM Procedure</a> to create the definition table. The following columns are required:  <table border="0"> <tr> <td>COL</td> <td>VARCHAR2 (30)</td> </tr> <tr> <td>VAL</td> <td>NUMBER</td> </tr> <tr> <td>BIN</td> <td>VARCHAR2 (4000)</td> </tr> </table> <code>CREATE_BIN_NUM</code> creates an additional column, <code>ATT</code> , which may be used for specifying nested attributes. This column is not used by <code>INSERT_BIN_NUM_QTILE</code> .	COL	VARCHAR2 (30)	VAL	NUMBER	BIN	VARCHAR2 (4000)
COL	VARCHAR2 (30)						
VAL	NUMBER						
BIN	VARCHAR2 (4000)						
<code>data_table_name</code>	Name of the table containing the data to be transformed						
<code>bin_num</code>	Number of bins. No binning occurs if <code>bin_num</code> is 0 or <code>NULL</code> . The default number of bins is 10.						
<code>exclude_list</code>	List of numerical columns to be excluded from the binning process. If you do not specify <code>exclude_list</code> , all numerical columns in the data source are binned. The format of <code>exclude_list</code> is:  <pre>dbms_data_mining_transform.COLUMN_LIST('col1','col2',  ...'coln')</pre>						
<code>bin_schema_name</code>	Schema of <code>bin_table_name</code> . If no schema is specified, the current schema is used.						
<code>data_schema_name</code>	Schema of <code>data_table_name</code> . If no schema is specified, the current schema is used.						

#### Usage Notes

1. See *Oracle Data Mining User's Guide* for details about numerical data.

2. After dividing the data into quantiles, the `NTILE` function distributes any remainder values one for each quantile, starting with the first. See *Oracle Database SQL Language Reference* for details.
3. Columns with all `NULL` values are ignored by `INSERT_BIN_NUM_QTILE`.

### Examples

In this example, `INSERT_BIN_NUM_QTILE` computes the bin boundaries for the `cust_year_of_birth` and `cust_credit_limit` columns in `sh.customers` and inserts the transformations in a transformation definition table. The [STACK\\_BIN\\_NUM Procedure](#) creates a transformation list from the contents of the definition table.

The SQL expression that computes the transformation is shown in `STACK_VIEW`. The view is for display purposes only; it cannot be used to embed the transformations in a model.

```
CREATE OR REPLACE VIEW mining_data AS
    SELECT cust_id, cust_year_of_birth, cust_credit_limit, cust_city
    FROM sh.customers;
```

```
DESCRIBE mining_data
```

Name	Null?	Type
CUST_ID	NOT NULL	NUMBER
CUST_YEAR_OF_BIRTH	NOT NULL	NUMBER(4)
CUST_CREDIT_LIMIT		NUMBER
CUST_CITY	NOT NULL	VARCHAR2(30)

```
BEGIN
    dbms_data_mining_transform.CREATE_BIN_NUM(
        bin_table_name => 'bin_tbl');
    dbms_data_mining_transform.INSERT_BIN_NUM_QTILE (
        bin_table_name => 'bin_tbl',
        data_table_name => 'mining_data',
        bin_num => 3,
        exclude_list => dbms_data_mining_transform.COLUMN_LIST('cust_id'));
END;
/

set numwidth 8
column val off
column col format a20
column bin format a10
SELECT col, val, bin
    FROM bin_tbl
    ORDER BY col ASC, val ASC;
```

COL	VAL	BIN
CUST_CREDIT_LIMIT	1500	
CUST_CREDIT_LIMIT	3000	1
CUST_CREDIT_LIMIT	9000	2
CUST_CREDIT_LIMIT	15000	3
CUST_YEAR_OF_BIRTH	1913	
CUST_YEAR_OF_BIRTH	1949	1
CUST_YEAR_OF_BIRTH	1965	2
CUST_YEAR_OF_BIRTH	1990	3

```
DECLARE
    xforms dbms_data_mining_transform.TRANSFORM_LIST;
BEGIN
    dbms_data_mining_transform.STACK_BIN_NUM (
```



```

        bin_table_name      => 'bin_tbl',
        xform_list          => xforms);
dbms_data_mining_transform.XFORM_STACK (
    xform_list             => xforms,
    data_table_name        => 'mining_data',
    xform_view_name        => 'stack_view');
END;
/

set long 3000
SELECT text FROM user_views WHERE view_name in 'STACK_VIEW';

TEXT
-----
SELECT "CUST_ID",CASE WHEN "CUST_YEAR_OF_BIRTH"<1913 THEN NULL WHEN "CUST_YEAR_O
F_BIRTH"<=1949 THEN '1' WHEN "CUST_YEAR_OF_BIRTH"<=1965 THEN '2' WHEN "CUST_YEAR
_OF_BIRTH"<=1990 THEN '3' END "CUST_YEAR_OF_BIRTH",CASE WHEN "CUST_CREDIT_LIMIT"
<1500 THEN NULL WHEN "CUST_CREDIT_LIMIT"<=3000 THEN '1' WHEN "CUST_CREDIT_LIMIT"
<=9000 THEN '2' WHEN "CUST_CREDIT_LIMIT"<=15000 THEN '3' END "CUST_CREDIT_LIMIT"
,"CUST_CITY" FROM mining_data

```

### 36.2.3.14 INSERT\_BIN\_SUPER Procedure

This procedure performs numerical and categorical binning and inserts the transformation definitions in transformation definition tables. The procedure computes bin boundaries based on intrinsic relationships between predictors and a target.

INSERT\_BIN\_SUPER uses an intelligent binning technique known as **supervised binning**. It builds a single-predictor decision tree and derives the bin boundaries from splits within the tree.

INSERT\_BIN\_SUPER bins all the VARCHAR2, CHAR, NUMBER, and FLOAT columns in the data source unless you specify a list of columns to ignore.

#### Syntax

```

DBMS_DATA_MINING_TRANSFORM.INSERT_BIN_SUPER (
    num_table_name          IN VARCHAR2,
    cat_table_name          IN VARCHAR2,
    data_table_name         IN VARCHAR2,
    target_column_name      IN VARCHAR2,
    max_bin_num             IN PLS_INTEGER DEFAULT 1000,
    exclude_list            IN COLUMN_LIST  DEFAULT NULL,
    num_schema_name         IN VARCHAR2    DEFAULT NULL,
    cat_schema_name         IN VARCHAR2    DEFAULT NULL,
    data_schema_name        IN VARCHAR2    DEFAULT NULL,
    rem_table_name          IN VARCHAR2    DEFAULT NULL,
    rem_schema_name         IN VARCHAR2    DEFAULT NULL);

```

## Parameters

**Table 36-137 INSERT\_BIN\_SUPER Procedure Parameters**

Parameter	Description						
num_table_name	<p>Name of the transformation definition table for numerical binning. You can use the <a href="#">CREATE_BIN_NUM Procedure</a> to create the definition table. The following columns are required:</p> <table border="1"> <tr> <td>COL</td> <td>VARCHAR2 (30)</td> </tr> <tr> <td>VAL</td> <td>VNUMBER</td> </tr> <tr> <td>BIN</td> <td>VARCHAR2 (4000)</td> </tr> </table> <p>CREATE_BIN_NUM creates an additional column, ATT, which may be used for specifying nested attributes. This column is not used by INSERT_BIN_SUPER.</p>	COL	VARCHAR2 (30)	VAL	VNUMBER	BIN	VARCHAR2 (4000)
COL	VARCHAR2 (30)						
VAL	VNUMBER						
BIN	VARCHAR2 (4000)						
cat_table_name	<p>Name of the transformation definition table for categorical binning. You can use the <a href="#">CREATE_BIN_CAT Procedure</a> to create the definition table. The following columns are required:</p> <table border="1"> <tr> <td>COL</td> <td>VARCHAR2 (30)</td> </tr> <tr> <td>VAL</td> <td>VARCHAR2 (4000)</td> </tr> <tr> <td>BIN</td> <td>VARCHAR2 (4000)</td> </tr> </table> <p>CREATE_BIN_CAT creates an additional column, ATT, which is used for specifying nested attributes. This column is not used by INSERT_BIN_SUPER.</p>	COL	VARCHAR2 (30)	VAL	VARCHAR2 (4000)	BIN	VARCHAR2 (4000)
COL	VARCHAR2 (30)						
VAL	VARCHAR2 (4000)						
BIN	VARCHAR2 (4000)						
data_table_name	Name of the table containing the data to be transformed						
target_column_name	Name of a column to be used as the target for the decision tree models						
max_bin_num	The maximum number of bins. The default is 1000.						
exclude_list	<p>List of columns to be excluded from the binning process. If you do not specify <i>exclude_list</i>, all numerical and categorical columns in the data source are binned.</p> <p>The format of <i>exclude_list</i> is:</p> <pre>dbms_data_mining_transform.COLUMN_LIST('col1','col2',  ...'coln')</pre>						
num_schema_name	Schema of <i>num_table_name</i> . If no schema is specified, the current schema is used.						
cat_schema_name	Schema of <i>cat_table_name</i> . If no schema is specified, the current schema is used.						
data_schema_name	Schema of <i>data_table_name</i> . If no schema is specified, the current schema is used.						
rem_table_name	Name of a column removal definition table. The table must have the columns described in " <a href="#">CREATE_COL_REM Procedure</a> ". You can use CREATE_COL_REM to create the table. See Usage Notes.						
rem_schema_name	Schema of <i>rem_table_name</i> . If no schema is specified, the current schema is used.						

## Usage Notes

1. See *Oracle Data Mining User's Guide* for details about numerical and categorical data.

- Columns that have no significant splits are not binned. You can remove the unbinned columns from the mining data by specifying a column removal definition table. If you do not specify a column removal definition table, the unbinned columns remain in the mining data.
- See *Oracle Data Mining Concepts* to learn more about decision trees in Oracle Data Mining

### Examples

In this example, `INSERT_BIN_SUPER` computes the bin boundaries for predictors of `cust_credit_limit` and inserts the transformations in transformation definition tables. One predictor is numerical, the other is categorical. (`INSERT_BIN_SUPER` determines that the `cust_postal_code` column is not a significant predictor.) `STACK` procedures create transformation lists from the contents of the definition tables.

The SQL expressions that compute the transformations are shown in the views `MINING_DATA_STACK_NUM` and `MINING_DATA_STACK_CAT`. The views are for display purposes only; they cannot be used to embed the transformations in a model.

```
CREATE OR REPLACE VIEW mining_data AS
  SELECT cust_id, cust_year_of_birth, cust_marital_status,
         cust_postal_code, cust_credit_limit
  FROM sh.customers;

DESCRIBE mining_data
Name                                         Null?    Type
-----
CUST_ID                                     NOT NULL NUMBER
CUST_YEAR_OF_BIRTH                         NOT NULL NUMBER(4)
CUST_MARITAL_STATUS                        VARCHAR2(20)
CUST_POSTAL_CODE                           NOT NULL VARCHAR2(10)
CUST_CREDIT_LIMIT                          NUMBER

BEGIN
  dbms_data_mining_transform.CREATE_BIN_NUM(
    bin_table_name => 'bin_num_tbl');
  dbms_data_mining_transform.CREATE_BIN_CAT(
    bin_table_name => 'bin_cat_tbl');
  dbms_data_mining_transform.CREATE_COL_REM(
    rem_table_name => 'rem_tbl');
END;
/

BEGIN
  COMMIT;
  dbms_data_mining_transform.INSERT_BIN_SUPER (
    num_table_name => 'bin_num_tbl',
    cat_table_name => 'bin_cat_tbl',
    data_table_name => 'mining_data',
    target_column_name => 'cust_credit_limit',
    max_bin_num => 4,
    exclude_list => dbms_data_mining_transform.COLUMN_LIST('cust_id'),
    num_schema_name => 'dmuser',
    cat_schema_name => 'dmuser',
    data_schema_name => 'dmuser',
    rem_table_name => 'rem_tbl',
    rem_schema_name => 'dmuser');
  COMMIT;
END;
/

set numwidth 8
```

```
column val off
SELECT col, val, bin FROM bin_num_tbl
ORDER BY bin ASC;
```

COL	VAL	BIN
CUST_YEAR_OF_BIRTH	1923.5	1
CUST_YEAR_OF_BIRTH	1923.5	1
CUST_YEAR_OF_BIRTH	1945.5	2
CUST_YEAR_OF_BIRTH	1980.5	3
CUST_YEAR_OF_BIRTH		4

```
column val on
column val format a20
SELECT col, val, bin FROM bin_cat_tbl
ORDER BY bin ASC;
```

COL	VAL	BIN
CUST_MARITAL_STATUS	married	1
CUST_MARITAL_STATUS	single	2
CUST_MARITAL_STATUS	Mar-AF	3
CUST_MARITAL_STATUS	Mabsent	3
CUST_MARITAL_STATUS	Divorc.	3
CUST_MARITAL_STATUS	Married	3
CUST_MARITAL_STATUS	Widowed	3
CUST_MARITAL_STATUS	NeverM	3
CUST_MARITAL_STATUS	Separ.	3
CUST_MARITAL_STATUS	divorced	4
CUST_MARITAL_STATUS	widow	4

```
SELECT col from rem_tbl;
```

```
COL
-----
CUST_POSTAL_CODE
```

```
DECLARE
  xforms_num      dbms_data_mining_transform.TRANSFORM_LIST;
  xforms_cat      dbms_data_mining_transform.TRANSFORM_LIST;
BEGIN
  dbms_data_mining_transform.STACK_BIN_NUM (
    bin_table_name => 'bin_num_tbl',
    xform_list     => xforms_num);
  dbms_data_mining_transform.XFORM_STACK (
    xform_list     => xforms_num,
    data_table_name => 'mining_data',
    xform_view_name => 'mining_data_stack_num');
  dbms_data_mining_transform.STACK_BIN_CAT (
    bin_table_name => 'bin_cat_tbl',
    xform_list     => xforms_cat);
  dbms_data_mining_transform.XFORM_STACK (
    xform_list     => xforms_cat,
    data_table_name => 'mining_data',
    xform_view_name => 'mining_data_stack_cat');
END;
/

set long 3000
SELECT text FROM user_views WHERE view_name IN 'MINING_DATA_STACK_NUM';

TEXT
```

```
-----
SELECT "CUST_ID",CASE WHEN "CUST_YEAR_OF_BIRTH"<1923.5 THEN '1' WHEN "CUST_YEAR_
OF_BIRTH"<=1923.5 THEN '1' WHEN "CUST_YEAR_OF_BIRTH"<=1945.5 THEN '2' WHEN "CUST
_YEAR_OF_BIRTH"<=1980.5 THEN '3' WHEN "CUST_YEAR_OF_BIRTH" IS NOT NULL THEN '4'
END "CUST_YEAR_OF_BIRTH","CUST_MARITAL_STATUS","CUST_POSTAL_CODE","CUST_CREDIT_L
IMIT" FROM mining_data
```

```
SELECT text FROM user_views WHERE view_name IN 'MINING_DATA_STACK_CAT';
```

```
TEXT
```

```
-----
SELECT "CUST_ID","CUST_YEAR_OF_BIRTH",DECODE("CUST_MARITAL_STATUS",'Divorc.','3'
,'Mabsent','3','Mar-AF','3','Married','3','NeverM','3','Separ.','3','Widowed','3
','divorced','4','married','1','single','2','widow','4') "CUST_MARITAL_STATUS","
CUST_POSTAL_CODE","CUST_CREDIT_LIMIT" FROM mining_data
```

### 36.2.3.15 INSERT\_CLIP\_TRIM\_TAIL Procedure

This procedure replaces numeric outliers with nulls and inserts the transformation definitions in a transformation definition table.

INSERT\_CLIP\_TRIM\_TAIL computes the boundaries of the data based on a specified percentage. It removes the values that fall outside the boundaries (tail values) from the data. If you wish to replace the tail values instead of removing them, use the [INSERT\\_CLIP\\_WINSOR\\_TAIL Procedure](#).

INSERT\_CLIP\_TRIM\_TAIL clips all the NUMBER and FLOAT columns in the data source unless you specify a list of columns to ignore.

#### Syntax

```
DBMS_DATA_MINING_TRANSFORM.INSERT_CLIP_TRIM_TAIL (
    clip_table_name      IN VARCHAR2,
    data_table_name      IN VARCHAR2,
    tail_frac            IN NUMBER DEFAULT 0.025,
    exclude_list         IN COLUMN_LIST DEFAULT NULL,
    clip_schema_name     IN VARCHAR2 DEFAULT NULL,
    data_schema_name     IN VARCHAR2 DEFAULT NULL);
```

#### Parameters

**Table 36-138** INSERT\_CLIP\_TRIM\_TAIL Procedure Parameters

Parameter	Description										
clip_table_name	Name of the transformation definition table for numerical clipping. You can use the <a href="#">CREATE_CLIP Procedure</a> to create the definition table. The following columns are required: <table border="0" style="margin-left: 20px;"> <tr> <td>COL</td> <td>VARCHAR2 (30)</td> </tr> <tr> <td>LCUT</td> <td>NUMBER</td> </tr> <tr> <td>LVAL</td> <td>NUMBER</td> </tr> <tr> <td>RCUT</td> <td>NUMBER</td> </tr> <tr> <td>RVAL</td> <td>NUMBER</td> </tr> </table> <p>CREATE_CLIP creates an additional column, ATT, which may be used for specifying nested attributes. This column is not used by INSERT_CLIP_TRIM_TAIL.</p>	COL	VARCHAR2 (30)	LCUT	NUMBER	LVAL	NUMBER	RCUT	NUMBER	RVAL	NUMBER
COL	VARCHAR2 (30)										
LCUT	NUMBER										
LVAL	NUMBER										
RCUT	NUMBER										
RVAL	NUMBER										
data_table_name	Name of the table containing the data to be transformed										

**Table 36-138 (Cont.) INSERT\_CLIP\_TRIM\_TAIL Procedure Parameters**

Parameter	Description
<code>tail_frac</code>	The percentage of non-null values to be designated as outliers at each end of the data. For example, if <code>tail_frac</code> is .01, then 1% of the data at the low end and 1% of the data at the high end will be treated as outliers. If <code>tail_frac</code> is greater than or equal to .5, no clipping occurs. The default value of <code>tail_frac</code> is 0.025.
<code>exclude_list</code>	List of numerical columns to be excluded from the clipping process. If you do not specify <code>exclude_list</code> , all numerical columns in the data are clipped. The format of <code>exclude_list</code> is:  <code>dbms_data_mining_transform.COLUMN_LIST('col1', 'col2', ... 'coln')</code>
<code>clip_schema_name</code>	Schema of <code>clip_table_name</code> . If no schema is specified, the current schema is used.
<code>data_schema_name</code>	Schema of <code>data_table_name</code> . If no schema is specified, the current schema is used.

### Usage Notes

1. See *Oracle Data Mining User's Guide* for details about numerical data.
2. The `DBMS_DATA_MINING_TRANSFORM` package provides two clipping procedures: `INSERT_CLIP_TRIM_TAIL` and `INSERT_CLIP_WINSOR_TAIL`. Both procedures compute the boundaries as follows:
  - Count the number of non-null values, *n*, and sort them in ascending order
  - Calculate the number of outliers, *t*, as  $n * tail\_frac$
  - Define the lower boundary *lcut* as the value at position  $1 + floor(t)$
  - Define the upper boundary *rcut* as the value at position  $n - floor(t)$

(The SQL `FLOOR` function returns the largest integer less than or equal to *t*.)

  - All values that are  $\leq lcut$  or  $\geq rcut$  are designated as outliers.

`INSERT_CLIP_TRIM_TAIL` replaces the outliers with nulls, effectively removing them from the data.

`INSERT_CLIP_WINSOR_TAIL` assigns *lcut* to the low outliers and *rcut* to the high outliers.

### Examples

In this example, `INSERT_CLIP_TRIM_TAIL` trims 10% of the data in two columns (5% from the high end and 5% from the low end) and inserts the transformations in a transformation definition table. The [STACK\\_CLIP Procedure](#) creates a transformation list from the contents of the definition table.

The SQL expression that computes the trimming is shown in the view `MINING_DATA_STACK`. The view is for display purposes only; it cannot be used to embed the transformations in a model.

```
CREATE OR REPLACE VIEW mining_data AS
  SELECT cust_id, cust_year_of_birth, cust_credit_limit, cust_city
  FROM sh.customers;
```

```

DESCRIBE mining_data
Name                               Null?    Type
-----
CUST_ID                            NOT NULL NUMBER
CUST_YEAR_OF_BIRTH                 NOT NULL NUMBER(4)
CUST_CREDIT_LIMIT                   NUMBER
CUST_CITY                           NOT NULL VARCHAR2(30)

BEGIN
  dbms_data_mining_transform.CREATE_CLIP(
    clip_table_name => 'clip_tbl');
  dbms_data_mining_transform.INSERT_CLIP_TRIM_TAIL(
    clip_table_name => 'clip_tbl',
    data_table_name => 'mining_data',
    tail_frac       => 0.05,
    exclude_list    => DBMS_DATA_MINING_TRANSFORM.COLUMN_LIST('cust_id'));
END;
/

SELECT col, lcut, lval, rcut, rval
       FROM clip_tbl
       ORDER BY col ASC;

COL          LCUT          LVAL          RCUT          RVAL
-----
CUST_CREDIT_LIMIT      1500              11000
CUST_YEAR_OF_BIRTH    1934              1982

DECLARE
  xforms      dbms_data_mining_transform.TRANSFORM_LIST;
BEGIN
  dbms_data_mining_transform.STACK_CLIP (
    clip_table_name => 'clip_tbl',
    xform_list      => xforms);
  dbms_data_mining_transform.XFORM_STACK (
    xform_list      => xforms,
    data_table_name => 'mining_data',
    xform_view_name => 'mining_data_stack');
END;
/

set long 3000
SELECT text FROM user_views WHERE view_name IN 'MINING_DATA_STACK';

TEXT
-----
SELECT "CUST_ID",CASE WHEN "CUST_YEAR_OF_BIRTH" < 1934 THEN NULL WHEN "CUST_YEAR
_OF_BIRTH" > 1982 THEN NULL ELSE "CUST_YEAR_OF_BIRTH" END "CUST_YEAR_OF_BIRTH",C
ASE WHEN "CUST_CREDIT_LIMIT" < 1500 THEN NULL WHEN "CUST_CREDIT_LIMIT" > 11000 T
HEN NULL ELSE "CUST_CREDIT_LIMIT" END "CUST_CREDIT_LIMIT","CUST_CITY" FROM minin
g_data

```

### 36.2.3.16 INSERT\_CLIP\_WINSOR\_TAIL Procedure

This procedure replaces numeric outliers with the upper or lower boundary values. It inserts the transformation definitions in a transformation definition table.

`INSERT_CLIP_WINSOR_TAIL` computes the boundaries of the data based on a specified percentage. It replaces the values that fall outside the boundaries (tail values) with the related boundary value. If you wish to set tail values to null, use the [INSERT\\_CLIP\\_TRIM\\_TAIL Procedure](#).

INSERT\_CLIP\_WINSOR\_TAIL clips all the NUMBER and FLOAT columns in the data source unless you specify a list of columns to ignore.

### Syntax

```
DBMS_DATA_MINING_TRANSFORM.INSERT_CLIP_WINSOR_TAIL (
    clip_table_name    IN VARCHAR2,
    data_table_name    IN VARCHAR2,
    tail_frac          IN NUMBER DEFAULT 0.025,
    exclude_list       IN COLUMN_LIST DEFAULT NULL,
    clip_schema_name   IN VARCHAR2 DEFAULT NULL,
    data_schema_name   IN VARCHAR2 DEFAULT NULL);
```

### Parameters

**Table 36-139** INSERT\_CLIP\_WINSOR\_TAIL Procedure Parameters

Parameter	Description										
clip_table_name	Name of the transformation definition table for numerical clipping. You can use the <a href="#">CREATE_CLIP Procedure</a> to create the definition table. The following columns are required: <table border="1" data-bbox="641 829 950 976"> <tr><td>COL</td><td>VARCHAR2(30)</td></tr> <tr><td>LCUT</td><td>NUMBER</td></tr> <tr><td>LVAL</td><td>NUMBER</td></tr> <tr><td>RCUT</td><td>NUMBER</td></tr> <tr><td>RVAL</td><td>NUMBER</td></tr> </table> CREATE_CLIP creates an additional column, ATT, which may be used for specifying nested attributes. This column is not used by INSERT_CLIP_WINSOR_TAIL.	COL	VARCHAR2(30)	LCUT	NUMBER	LVAL	NUMBER	RCUT	NUMBER	RVAL	NUMBER
COL	VARCHAR2(30)										
LCUT	NUMBER										
LVAL	NUMBER										
RCUT	NUMBER										
RVAL	NUMBER										
data_table_name	Name of the table containing the data to be transformed										
tail_frac	The percentage of non-null values to be designated as outliers at each end of the data. For example, if tail_frac is .01, then 1% of the data at the low end and 1% of the data at the high end will be treated as outliers. If tail_frac is greater than or equal to .5, no clipping occurs. The default value of tail_frac is 0.025.										
exclude_list	List of numerical columns to be excluded from the clipping process. If you do not specify exclude_list, all numerical columns in the data are clipped. The format of exclude_list is: <pre>dbms_data_mining_transform.COLUMN_LIST('col1','col2',  ...'coln')</pre>										
clip_schema_name	Schema of clip_table_name. If no schema is specified, the current schema is used.										
data_schema_name	Schema of data_table_name. If no schema is specified, the current schema is used.										

### Usage Notes

1. See *Oracle Data Mining User's Guide* for details about numerical data.
2. The DBMS\_DATA\_MINING\_TRANSFORM package provides two clipping procedures: INSERT\_CLIP\_WINSOR\_TAIL and INSERT\_CLIP\_TRIM\_TAIL. Both procedures compute the boundaries as follows:



- Count the number of non-null values, *n*, and sort them in ascending order
- Calculate the number of outliers, *t*, as  $n * tail\_frac$
- Define the lower boundary *lcut* as the value at position  $1 + floor(t)$
- Define the upper boundary *rcut* as the value at position  $n - floor(t)$   
(The SQL FLOOR function returns the largest integer less than or equal to *t*.)
- All values that are  $\leq lcut$  or  $\geq rcut$  are designated as outliers.

INSERT\_CLIP\_WINSOR\_TAIL assigns *lcut* to the low outliers and *rcut* to the high outliers.

INSERT\_CLIP\_TRIM\_TAIL replaces the outliers with nulls, effectively removing them from the data.

## Examples

In this example, INSERT\_CLIP\_WINSOR\_TAIL winsorizes 10% of the data in two columns (5% from the high end, and 5% from the low end) and inserts the transformations in a transformation definition table. The STACK\_CLIP Procedure creates a transformation list from the contents of the definition table.

The SQL expression that computes the transformation is shown in the view MINING\_DATA\_STACK. The view is for display purposes only; it cannot be used to embed the transformations in a model.

```
CREATE OR REPLACE VIEW mining_data AS
  SELECT cust_id, cust_year_of_birth, cust_credit_limit, cust_city
  FROM sh.customers;
```

describe mining\_data

Name	Null?	Type
CUST_ID	NOT NULL	NUMBER
CUST_YEAR_OF_BIRTH	NOT NULL	NUMBER(4)
CUST_CREDIT_LIMIT		NUMBER
CUST_CITY	NOT NULL	VARCHAR2(30)

```
BEGIN
  dbms_data_mining_transform.CREATE_CLIP(
    clip_table_name => 'clip_tbl');
  dbms_data_mining_transform.INSERT_CLIP_WINSOR_TAIL(
    clip_table_name => 'clip_tbl',
    data_table_name => 'mining_data',
    tail_frac       => 0.05,
    exclude_list    => DBMS_DATA_MINING_TRANSFORM.COLUMN_LIST('cust_id'));
END;
/

SELECT col, lcut, lval, rcut, rval FROM clip_tbl
  ORDER BY col ASC;
```

COL	LCUT	LVAL	RCUT	RVAL
CUST_CREDIT_LIMIT	1500	1500	11000	11000
CUST_YEAR_OF_BIRTH	1934	1934	1982	1982

```
DECLARE
  xforms      dbms_data_mining_transform.TRANSFORM_LIST;
BEGIN
  dbms_data_mining_transform.STACK_CLIP (
    clip_table_name => 'clip_tbl',
    xform_list      => xforms);
```

```

dbms_data_mining_transform.XFORM_STACK (
  xform_list      => xforms,
  data_table_name => 'mining_data',
  xform_view_name => 'mining_data_stack');
END;
/

set long 3000
SQL> SELECT text FROM user_views WHERE view_name IN 'MINING_DATA_STACK';

TEXT
-----
SELECT "CUST_ID",CASE WHEN "CUST_YEAR_OF_BIRTH" < 1934 THEN 1934 WHEN "CUST_YEAR
_OF_BIRTH" > 1982 THEN 1982 ELSE "CUST_YEAR_OF_BIRTH" END "CUST_YEAR_OF_BIRTH",C
ASE WHEN "CUST_CREDIT_LIMIT" < 1500 THEN 1500 WHEN "CUST_CREDIT_LIMIT" > 11000 T
HEN 11000 ELSE "CUST_CREDIT_LIMIT" END "CUST_CREDIT_LIMIT","CUST_CITY" FROM mini
ng_data

```

### 36.2.3.17 INSERT\_MISS\_CAT\_MODE Procedure

This procedure replaces missing categorical values with the value that occurs most frequently in the column (the mode). It inserts the transformation definitions in a transformation definition table.

INSERT\_MISS\_CAT\_MODE replaces missing values in all VARCHAR2 and CHAR columns in the data source unless you specify a list of columns to ignore.

#### Syntax

```

DBMS_DATA_MINING_TRANSFORM.INSERT_MISS_CAT_MODE (
  miss_table_name      IN VARCHAR2,
  data_table_name      IN VARCHAR2,
  exclude_list         IN COLUMN_LIST DEFAULT NULL,
  miss_schema_name     IN VARCHAR2 DEFAULT NULL,
  data_schema_name     IN VARCHAR2 DEFAULT NULL);

```

#### Parameters

**Table 36-140** INSERT\_MISS\_CAT\_MODE Procedure Parameters

Parameter	Description				
miss_table_name	Name of the transformation definition table for categorical missing value treatment. You can use the <a href="#">CREATE_MISS_CAT Procedure</a> to create the definition table. The following columns are required: <table border="0" style="margin-left: 20px;"> <tr> <td>COL</td> <td>VARCHAR2(30)</td> </tr> <tr> <td>VAL</td> <td>VARCHAR2(4000)</td> </tr> </table> CREATE_MISS_CAT creates an additional column, ATT, which may be used for specifying nested attributes. This column is not used by INSERT_MISS_CAT_MODE.	COL	VARCHAR2(30)	VAL	VARCHAR2(4000)
COL	VARCHAR2(30)				
VAL	VARCHAR2(4000)				
data_table_name	Name of the table containing the data to be transformed				
exclude_list	List of categorical columns to be excluded from missing value treatment. If you do not specify <i>exclude_list</i> , all categorical columns are transformed. The format of <i>exclude_list</i> is: <pre>dbms_data_mining_transform.COLUMN_LIST('col1','col2', ... 'coln')</pre>				

**Table 36-140 (Cont.) INSERT\_MISS\_CAT\_MODE Procedure Parameters**

Parameter	Description
miss_schema_name	Schema of <i>miss_table_name</i> . If no schema is specified, the current schema is used.
data_schema_name	Schema of <i>data_table_name</i> . If no schema is specified, the current schema is used.

**Usage Notes**

1. See *Oracle Data Mining User's Guide* for details about categorical data.
2. If you wish to replace categorical missing values with a value other than the mode, you can edit the transformation definition table.

 **See Also:**

*Oracle Data Mining User's Guide* for information about default missing value treatment in Oracle Data Mining

**Example**

In this example, `INSERT_MISS_CAT_MODE` computes missing value treatment for `cust_city` and inserts the transformation in a transformation definition table. The [STACK\\_MISS\\_CAT Procedure](#) creates a transformation list from the contents of the definition table.

The SQL expression that computes the transformation is shown in the view `MINING_DATA_STACK`. The view is for display purposes only; it cannot be used to embed the transformations in a model.

```
CREATE OR REPLACE VIEW mining_data AS
  SELECT cust_id, cust_year_of_birth, cust_city
  FROM sh.customers;

describe mining_data
Name                                Null?    Type
-----
CUST_ID                             NOT NULL NUMBER
CUST_YEAR_OF_BIRTH                   NOT NULL NUMBER(4)
CUST_CITY                             NOT NULL VARCHAR2(30)

BEGIN
  dbms_data_mining_transform.create_miss_cat(
    miss_table_name => 'missc_tbl');
  dbms_data_mining_transform.insert_miss_cat_mode(
    miss_table_name => 'missc_tbl',
    data_table_name => 'mining_data');
END;
/

SELECT stats_mode(cust_city) FROM mining_data;

STATS_MODE(CUST_CITY)
-----
Los Angeles
```

```

SELECT col, val
       from missc_tbl;

COL                                VAL
-----
CUST_CITY                          Los Angeles

DECLARE
  xforms      dbms_data_mining_transform.TRANSFORM_LIST;
BEGIN
  dbms_data_mining_transform.STACK_MISS_CAT (
    miss_table_name => 'missc_tbl',
    xform_list      => xforms);
  dbms_data_mining_transform.XFORM_STACK (
    xform_list      => xforms,
    data_table_name => 'mining_data',
    xform_view_name => 'mining_data_stack');
END;
/

set long 3000
SELECT text FROM user_views WHERE view_name IN 'MINING_DATA_STACK';

TEXT
-----
SELECT "CUST_ID","CUST_YEAR_OF_BIRTH",NVL("CUST_CITY",'Los Angeles') "CUST_CITY"
FROM mining_data

```

### 36.2.3.18 INSERT\_MISS\_NUM\_MEAN Procedure

This procedure replaces missing numerical values with the average (the mean) and inserts the transformation definitions in a transformation definition table.

INSERT\_MISS\_NUM\_MEAN replaces missing values in all NUMBER and FLOAT columns in the data source unless you specify a list of columns to ignore.

#### Syntax

```

DBMS_DATA_MINING_TRANSFORM.INSERT_MISS_NUM_MEAN (
  miss_table_name      IN VARCHAR2,
  data_table_name      IN VARCHAR2,
  exclude_list         IN COLUMN_LIST DEFAULT NULL,
  round_num            IN PLS_INTEGER DEFAULT 6,
  miss_schema_name     IN VARCHAR2 DEFAULT NULL,
  data_schema_name     IN VARCHAR2 DEFAULT NULL);

```

## Parameters

Table 36-141 INSERT\_MISS\_NUM\_MEAN Procedure Parameters

Parameter	Description				
<code>miss_table_name</code>	<p>Name of the transformation definition table for numerical missing value treatment. You can use the <a href="#">CREATE_MISS_NUM Procedure</a> to create the definition table.</p> <p>The following columns are required by <code>INSERT_MISS_NUM_MEAN</code>:</p> <table border="1"> <tr> <td>COL</td> <td>VARCHAR2 (30)</td> </tr> <tr> <td>VAL</td> <td>NUMBER</td> </tr> </table> <p><code>CREATE_MISS_NUM</code> creates an additional column, <code>ATT</code>, which may be used for specifying nested attributes. This column is not used by <code>INSERT_MISS_NUM_MEAN</code>.</p>	COL	VARCHAR2 (30)	VAL	NUMBER
COL	VARCHAR2 (30)				
VAL	NUMBER				
<code>data_table_name</code>	Name of the table containing the data to be transformed				
<code>exclude_list</code>	<p>List of numerical columns to be excluded from missing value treatment. If you do not specify <code>exclude_list</code>, all numerical columns are transformed.</p> <p>The format of <code>exclude_list</code> is:</p> <pre>dbms_data_mining_transform.COLUMN_LIST('col1', 'col2',  ... 'coln')</pre>				
<code>round_num</code>	<p>The number of significant digits to use for the mean.</p> <p>The default number is 6.</p>				
<code>miss_schema_name</code>	Schema of <code>miss_table_name</code> . If no schema is specified, the current schema is used.				
<code>data_schema_name</code>	Schema of <code>data_table_name</code> . If no schema is specified, the current schema is used.				

## Usage Notes

1. See *Oracle Data Mining User's Guide* for details about numerical data.
2. If you wish to replace numerical missing values with a value other than the mean, you can edit the transformation definition table.

 **See Also:**

*Oracle Data Mining User's Guide* for information about default missing value treatment in Oracle Data Mining

## Example

In this example, `INSERT_MISS_NUM_MEAN` computes missing value treatment for `cust_year_of_birth` and inserts the transformation in a transformation definition table. The [STACK\\_MISS\\_NUM Procedure](#) creates a transformation list from the contents of the definition table.

The SQL expression that computes the transformation is shown in the view `MINING_DATA_STACK`. The view is for display purposes only; it cannot be used to embed the transformations in a model.

```

CREATE OR REPLACE VIEW mining_data AS
  SELECT cust_id, cust_year_of_birth, cust_city
  FROM sh.customers;

DESCRIBE mining_data
Name                                                    Null?    Type
-----
CUST_ID                                                NOT NULL NUMBER
CUST_YEAR_OF_BIRTH                                    NOT NULL NUMBER(4)
CUST_CITY                                              NOT NULL VARCHAR2(30)

BEGIN
  dbms_data_mining_transform.create_miss_num(
    miss_table_name => 'missn_tbl');
  dbms_data_mining_transform.insert_miss_num_mean(
    miss_table_name => 'missn_tbl',
    data_table_name => 'mining_data',
    exclude_list   => DBMS_DATA_MINING_TRANSFORM.COLUMN_LIST('cust_id'));
END;
/

set numwidth 4
column val off
SELECT col, val
  FROM missn_tbl;

COL                VAL
-----
CUST_YEAR_OF_BIRTH 1957

SELECT avg(cust_year_of_birth) FROM mining_data;

AVG(CUST_YEAR_OF_BIRTH)
-----
                        1957

DECLARE
  xforms      dbms_data_mining_transform.TRANSFORM_LIST;
BEGIN
  dbms_data_mining_transform.STACK_MISS_NUM (
    miss_table_name => 'missn_tbl',
    xform_list      => xforms);
  dbms_data_mining_transform.XFORM_STACK (
    xform_list      => xforms,
    data_table_name => 'mining_data',
    xform_view_name => 'mining_data_stack');
END;
/

set long 3000
SELECT text FROM user_views WHERE view_name IN 'MINING_DATA_STACK';

TEXT
-----
SELECT "CUST_ID",NVL("CUST_YEAR_OF_BIRTH",1957.4) "CUST_YEAR_OF_BIRTH","CUST_CIT
Y" FROM mining_data

```

### 36.2.3.19 INSERT\_NORM\_LIN\_MINMAX Procedure

This procedure performs linear normalization and inserts the transformation definitions in a transformation definition table.

INSERT\_NORM\_LIN\_MINMAX computes the minimum and maximum values from the data and sets the value of *shift* and *scale* as follows:

```
shift = min
scale = max - min
```

Normalization is computed as:

$$x_{new} = (x_{old} - shift) / scale$$

INSERT\_NORM\_LIN\_MINMAX rounds the value of *scale* to a specified number of significant digits before storing it in the transformation definition table.

INSERT\_NORM\_LIN\_MINMAX normalizes all the NUMBER and FLOAT columns in the data source unless you specify a list of columns to ignore.

#### Syntax

```
DBMS_DATA_MINING_TRANSFORM.INSERT_NORM_LIN_MINMAX (
  norm_table_name      IN VARCHAR2,
  data_table_name      IN VARCHAR2,
  exclude_list         IN COLUMN_LIST DEFAULT NULL,
  round_num            IN PLS_INTEGER DEFAULT 6,
  norm_schema_name     IN VARCHAR2 DEFAULT NULL,
  data_schema_name     IN VARCHAR2 DEFAULT NULL);
```

#### Parameters

**Table 36-142** INSERT\_NORM\_LIN\_MINMAX Procedure Parameters

Parameter	Description						
norm_table_name	Name of the transformation definition table for linear normalization. You can use the <a href="#">CREATE_NORM_LIN Procedure</a> to create the definition table. The following columns are required: <table border="1" data-bbox="646 1388 963 1472"> <tr> <td>COL</td> <td>VARCHAR2 (30)</td> </tr> <tr> <td>SHIFT</td> <td>NUMBER</td> </tr> <tr> <td>SCALE</td> <td>NUMBER</td> </tr> </table> CREATE_NORM_LIN creates an additional column, ATT, which may be used for specifying nested attributes. This column is not used by INSERT_NORM_LIN_MINMAX.	COL	VARCHAR2 (30)	SHIFT	NUMBER	SCALE	NUMBER
COL	VARCHAR2 (30)						
SHIFT	NUMBER						
SCALE	NUMBER						
data_table_name	Name of the table containing the data to be transformed						
exclude_list	List of numerical columns to be excluded from normalization. If you do not specify <i>exclude_list</i> , all numerical columns are transformed. <p>The format of <i>exclude_list</i> is:</p> <pre>dbms_data_mining_transform.COLUMN_LIST('col1','col2', ... 'coln')</pre>						
round_num	The number of significant digits to use for the minimum and maximum. The default number is 6.						

**Table 36-142 (Cont.) INSERT\_NORM\_LIN\_MINMAX Procedure Parameters**

Parameter	Description
norm_schema_name	Schema of <i>norm_table_name</i> . If no schema is specified, the current schema is used.
data_schema_name	Schema of <i>data_table_name</i> . If no schema is specified, the current schema is used.

### Usage Notes

See *Oracle Data Mining User's Guide* for details about numerical data.

### Examples

In this example, `INSERT_NORM_LIN_MINMAX` normalizes the `cust_year_of_birth` column and inserts the transformation in a transformation definition table. The [STACK\\_NORM\\_LIN Procedure](#) creates a transformation list from the contents of the definition table.

The SQL expression that computes the transformation is shown in the view `MINING_DATA_STACK`. The view is for display purposes only; it cannot be used to embed the transformations in a model.

```
CREATE OR REPLACE VIEW mining_data AS
    SELECT cust_id, cust_gender, cust_year_of_birth
    FROM sh.customers;

describe mining_data
Name                                     Null?    Type
-----
CUST_ID                                 NOT NULL NUMBER
CUST_GENDER                             NOT NULL CHAR(1)
CUST_YEAR_OF_BIRTH                       NOT NULL NUMBER(4)

BEGIN
    dbms_data_mining_transform.CREATE_NORM_LIN(
        norm_table_name => 'norm_tbl');
    dbms_data_mining_transform.INSERT_NORM_LIN_MINMAX(
        norm_table_name => 'norm_tbl',
        data_table_name => 'mining_data',
        exclude_list    => dbms_data_mining_transform.COLUMN_LIST('cust_id'),
        round_num        => 3);
END;
/

SELECT col, shift, scale FROM norm_tbl;

COL                                     SHIFT    SCALE
-----
CUST_YEAR_OF_BIRTH                       1910      77

DECLARE
    xforms      dbms_data_mining_transform.TRANSFORM_LIST;
BEGIN
    dbms_data_mining_transform.STACK_NORM_LIN (
        norm_table_name => 'norm_tbl',
        xform_list      => xforms);
    dbms_data_mining_transform.XFORM_STACK (
        xform_list      => xforms,
```



```

        data_table_name => 'mining_data',
        xform_view_name => 'mining_data_stack');
END;
/

set long 3000
SELECT text FROM user_views WHERE view_name IN 'MINING_DATA_STACK';

TEXT
-----
SELECT "CUST_ID","CUST_GENDER",("CUST_YEAR_OF_BIRTH"-1910)/77 "CUST_YEAR_OF_BIRT
H" FROM mining_data

```

### 36.2.3.20 INSERT\_NORM\_LIN\_SCALE Procedure

This procedure performs linear normalization and inserts the transformation definitions in a transformation definition table.

INSERT\_NORM\_LIN\_SCALE computes the minimum and maximum values from the data and sets the value of *shift* and *scale* as follows:

```

shift = 0
scale = max(abs(max), abs(min))

```

Normalization is computed as:

```

x_new = (x_old)/scale

```

INSERT\_NORM\_LIN\_SCALE rounds the value of *scale* to a specified number of significant digits before storing it in the transformation definition table.

INSERT\_NORM\_LIN\_SCALE normalizes all the NUMBER and FLOAT columns in the data source unless you specify a list of columns to ignore.

#### Syntax

```

DBMS_DATA_MINING_TRANSFORM.INSERT_NORM_LIN_SCALE (
    norm_table_name      IN VARCHAR2,
    data_table_name      IN VARCHAR2,
    exclude_list         IN COLUMN_LIST DEFAULT NULL,
    round_num            IN PLS_INTEGER DEFAULT 6,
    norm_schema_name     IN VARCHAR2 DEFAULT NULL,
    data_schema_name     IN VARCHAR2 DEFAULT NULL);

```

#### Parameters

**Table 36-143** INSERT\_NORM\_LIN\_SCALE Procedure Parameters

Parameter	Description
norm_table_name	Name of the transformation definition table for linear normalization. You can use the <a href="#">CREATE_NORM_LIN Procedure</a> to create the definition table. The following columns are required: <ul style="list-style-type: none"> <li>COL        VARCHAR2 (30)</li> <li>SHIFT     NUMBER</li> <li>SCALE     NUMBER</li> </ul> <p>CREATE_NORM_LIN creates an additional column, ATT, which may be used for specifying nested attributes. This column is not used by INSERT_NORM_LIN_SCALE.</p>

**Table 36-143 (Cont.) INSERT\_NORM\_LIN\_SCALE Procedure Parameters**

Parameter	Description
<code>data_table_name</code>	Name of the table containing the data to be transformed
<code>exclude_list</code>	List of numerical columns to be excluded from normalization. If you do not specify <code>exclude_list</code> , all numerical columns are transformed.  The format of <code>exclude_list</code> is:  <code>dbms_data_mining_transform.COLUMN_LIST('col1','col2', ... 'coln')</code>
<code>round_num</code>	The number of significant digits to use for <code>scale</code> . The default number is 6.
<code>norm_schema_name</code>	Schema of <code>norm_table_name</code> . If no schema is specified, the current schema is used.
<code>data_schema_name</code>	Schema of <code>data_table_name</code> . If no schema is specified, the current schema is used.

### Usage Notes

See *Oracle Data Mining User's Guide* for details about numerical data.

### Examples

In this example, `INSERT_NORM_LIN_SCALE` normalizes the `cust_year_of_birth` column and inserts the transformation in a transformation definition table. The [STACK\\_NORM\\_LIN Procedure](#) creates a transformation list from the contents of the definition table.

The SQL expression that computes the transformation is shown in the view `MINING_DATA_STACK`. The view is for display purposes only; it cannot be used to embed the transformations in a model.

```
CREATE OR REPLACE VIEW mining_data AS
    SELECT cust_id, cust_gender, cust_year_of_birth
    FROM sh.customers;

DESCRIBE mining_data
Name                                     Null?    Type
-----
CUST_ID                                 NOT NULL NUMBER
CUST_GENDER                             NOT NULL CHAR(1)
CUST_YEAR_OF_BIRTH                       NOT NULL NUMBER(4)

BEGIN
    dbms_data_mining_transform.CREATE_NORM_LIN(
        norm_table_name => 'norm_tbl');
    dbms_data_mining_transform.INSERT_NORM_LIN_SCALE(
        norm_table_name => 'norm_tbl',
        data_table_name => 'mining_data',
        exclude_list    => dbms_data_mining_transform.COLUMN_LIST('cust_id'),
        round_num       => 3);
END;
/

SELECT col, shift, scale FROM norm_tbl;

COL          SHIFT SCALE
-----
```

```

CUST_YEAR_OF_BIRTH      0 1990

DECLARE
  xforms      dbms_data_mining_transform.TRANSFORM_LIST;
BEGIN
  dbms_data_mining_transform.STACK_NORM_LIN (
    norm_table_name => 'norm_tbl',
    xform_list      => xforms);
  dbms_data_mining_transform.XFORM_STACK (
    xform_list      => xforms,
    data_table_name => 'mining_data',
    xform_view_name => 'mining_data_stack');
END;
/

set long 3000
SELECT text FROM user_views WHERE view_name IN 'MINING_DATA_STACK';

TEXT
-----
SELECT "CUST_ID","CUST_GENDER", ("CUST_YEAR_OF_BIRTH"-0)/1990 "CUST_YEAR_OF_BIRTH
" FROM mining_data

```

### 36.2.3.21 INSERT\_NORM\_LIN\_ZSCORE Procedure

This procedure performs linear normalization and inserts the transformation definitions in a transformation definition table.

INSERT\_NORM\_LIN\_ZSCORE computes the mean and the standard deviation from the data and sets the value of *shift* and *scale* as follows:

```

shift = mean
scale = stddev

```

Normalization is computed as:

$$x_{new} = (x_{old} - shift) / scale$$

INSERT\_NORM\_LIN\_ZSCORE rounds the value of *scale* to a specified number of significant digits before storing it in the transformation definition table.

INSERT\_NORM\_LIN\_ZSCORE normalizes all the NUMBER and FLOAT columns in the data unless you specify a list of columns to ignore.

#### Syntax

```

DBMS_DATA_MINING_TRANSFORM.INSERT_NORM_LIN_ZSCORE (
  norm_table_name      IN VARCHAR2,
  data_table_name      IN VARCHAR2,
  exclude_list         IN COLUMN_LIST DEFAULT NULL,
  round_num            IN PLS_INTEGER DEFAULT 6,
  norm_schema_name     IN VARCHAR2 DEFAULT NULL,
  data_schema_name     IN VARCHAR2 DEFAULT NULL);

```

## Parameters

**Table 36-144 INSERT\_NORM\_LIN\_ZSCORE Procedure Parameters**

Parameter	Description						
norm_table_name	<p>Name of the transformation definition table for linear normalization. You can use the <a href="#">CREATE_NORM_LIN Procedure</a> to create the definition table. The following columns are required:</p> <table border="1"> <tr> <td>COL</td> <td>VARCHAR2 (30)</td> </tr> <tr> <td>SHIFT</td> <td>NUMBER</td> </tr> <tr> <td>SCALE</td> <td>NUMBER</td> </tr> </table> <p>CREATE_NORM_LIN creates an additional column, ATT, which may be used for specifying nested attributes. This column is not used by INSERT_NORM_LIN_ZSCORE.</p>	COL	VARCHAR2 (30)	SHIFT	NUMBER	SCALE	NUMBER
COL	VARCHAR2 (30)						
SHIFT	NUMBER						
SCALE	NUMBER						
data_table_name	Name of the table containing the data to be transformed						
exclude_list	<p>List of numerical columns to be excluded from normalization. If you do not specify <i>exclude_list</i>, all numerical columns are transformed.</p> <p>The format of <i>exclude_list</i> is:</p> <pre>dbms_data_mining_transform.COLUMN_LIST('col1','col2',  ...'coln')</pre>						
round_num	The number of significant digits to use for <i>scale</i> . The default number is 6.						
norm_schema_name	Schema of <i>norm_table_name</i> . If no schema is specified, the current schema is used.						
data_schema_name	Schema of <i>data_table_name</i> . If no schema is specified, the current schema is used.						

## Usage Notes

See *Oracle Data Mining User's Guide* for details about numerical data.

## Examples

In this example, INSERT\_NORM\_LIN\_ZSCORE normalizes the *cust\_year\_of\_birth* column and inserts the transformation in a transformation definition table. The [STACK\\_NORM\\_LIN Procedure](#) creates a transformation list from the contents of the definition table.

The SQL expression that computes the transformation is shown in the view MINING\_DATA\_STACK. The view is for display purposes only; it cannot be used to embed the transformations in a model.

```
CREATE OR REPLACE VIEW mining_data AS
    SELECT cust_id, cust_gender, cust_year_of_birth
    FROM sh.customers;
```

```
DESCRIBE mining_data
Name                               Null?    Type
-----
CUST_ID                             NOT NULL NUMBER
CUST_GENDER                          NOT NULL CHAR(1)
CUST_YEAR_OF_BIRTH                   NOT NULL NUMBER(4)

BEGIN
    dbms_data_mining_transform.CREATE_NORM_LIN(
```

```

norm_table_name => 'norm_tbl');
dbms_data_mining_transform.INSERT_NORM_LIN_ZSCORE (
norm_table_name => 'norm_tbl',
data_table_name => 'mining_data',
exclude_list    => dbms_data_mining_transform.COLUMN_LIST( 'cust_id'),
round_num       => 3);
END;
/

SELECT col, shift, scale FROM norm_tbl;

COL                SHIFT SCALE
-----
CUST_YEAR_OF_BIRTH 1960    15

DECLARE
  xforms          dbms_data_mining_transform.TRANSFORM_LIST;
BEGIN
  dbms_data_mining_transform.STACK_NORM_LIN (
    norm_table_name => 'norm_tbl',
    xform_list      => xforms);
  dbms_data_mining_transform.XFORM_STACK (
    xform_list      => xforms,
    data_table_name => 'mining_data',
    xform_view_name => 'mining_data_stack');
END;
/

set long 3000
SQL> SELECT text FROM user_views WHERE view_name IN 'MINING_DATA_STACK';

TEXT
-----
SELECT "CUST_ID","CUST_GENDER", ("CUST_YEAR_OF_BIRTH"-1960)/15 "CUST_YEAR_OF_BIRT
H" FROM mining_data

```

### 36.2.3.22 SET\_EXPRESSION Procedure

This procedure appends a row to a `VARCHAR2` array that stores a SQL expression.

The array can be used for specifying a transformation expression that is too long to be used with the [SET\\_TRANSFORM Procedure](#).

The [GET\\_EXPRESSION Function](#) returns a row in the array.

When you use `SET_EXPRESSION` to build a transformation expression, you must build a corresponding reverse transformation expression, create a transformation record, and add the transformation record to a transformation list.

#### Syntax

```

DBMS_DATA_MINING_TRANSFORM.SET_EXPRESSION (
  expression    IN OUT NOCOPY EXPRESSION_REC,
  chunk         VARCHAR2 DEFAULT NULL);

```

## Parameters

**Table 36-145 SET\_EXPRESSION Procedure Parameters**

Parameter	Description
<code>expression</code>	An expression record ( <code>EXPRESSION_REC</code> ) that specifies a transformation expression or a reverse transformation expression for an attribute. Each expression record includes a <code>VARCHAR2</code> array and index fields for specifying upper and lower boundaries within the array.  There are two <code>EXPRESSION_REC</code> fields within a transformation record ( <code>TRANSFORM_REC</code> ): one for the transformation expression; the other for the reverse transformation expression.  See <a href="#">Table 36-114</a> for a description of the <code>EXPRESSION_REC</code> type.
<code>chunk</code>	A <code>VARCHAR2</code> chunk (row) to be appended to <code>expression</code> .

## Notes

1. You can pass `NULL` in the `chunk` argument to `SET_EXPRESSION` to clear the previous chunk. The default value of `chunk` is `NULL`.
2. See ["About Transformation Lists"](#).
3. See ["Operational Notes"](#).

## Examples

In this example, two calls to `SET_EXPRESSION` construct a transformation expression and two calls construct the reverse transformation.



### Note:

This example is for illustration purposes only. It shows how `SET_EXPRESSION` appends the text provided in `chunk` to the text that already exists in `expression`. The `SET_EXPRESSION` procedure is meant for constructing very long transformation expressions that cannot be specified in a `VARCHAR2` argument to `SET_TRANSFORM`.

Similarly while transformation lists are intended for embedding in a model, the transformation list `v_xlst` is shown in an external view for illustration purposes.

```
CREATE OR REPLACE VIEW mining_data AS
  SELECT cust_id, cust_year_of_birth, cust_postal_code, cust_credit_limit
  FROM sh.customers;

DECLARE
  v_expr dbms_data_mining_transform.EXPRESSION_REC;
  v_rexp dbms_data_mining_transform.EXPRESSION_REC;
  v_xrec dbms_data_mining_transform.TRANSFORM_REC;
  v_xlst dbms_data_mining_transform.TRANSFORM_LIST :=
    dbms_data_mining_transform.TRANSFORM_LIST(NULL);
BEGIN
  dbms_data_mining_transform.SET_EXPRESSION(
    EXPRESSION => v_expr,
    CHUNK      => '("CUST_YEAR_OF_BIRTH"-1910)');
  dbms_data_mining_transform.SET_EXPRESSION(
```

```

        EXPRESSION => v_expr,
        CHUNK      => '/77');
dbms_data_mining_transform.SET_EXPRESSION(
    EXPRESSION => v_rexp,
    CHUNK      => '"CUST_YEAR_OF_BIRTH"*77');
dbms_data_mining_transform.SET_EXPRESSION(
    EXPRESSION => v_rexp,
    CHUNK      => '+1910');

v_xrec := null;
v_xrec.attribute_name := 'CUST_YEAR_OF_BIRTH';
v_xrec.expression := v_expr;
v_xrec.reverse_expression := v_rexp;
v_xlst.TRIM;
v_xlst.extend(1);
v_xlst(1) := v_xrec;

dbms_data_mining_transform.XFORM_STACK (
    xform_list      => v_xlst,
    data_table_name => 'mining_data',
    xform_view_name => 'v_xlst_view');

dbms_output.put_line('====');
FOR i IN 1..v_xlst.count LOOP
    dbms_output.put_line('ATTR: '||v_xlst(i).attribute_name);
    dbms_output.put_line('SUBN: '||v_xlst(i).attribute_subname);
    FOR j IN v_xlst(i).expression.lb..v_xlst(i).expression.ub LOOP
        dbms_output.put_line('EXPR: '||v_xlst(i).expression.lstmt(j));
    END LOOP;
    FOR j IN v_xlst(i).reverse_expression.lb..
        v_xlst(i).reverse_expression.ub LOOP
        dbms_output.put_line('REXP: '||v_xlst(i).reverse_expression.lstmt(j));
    END LOOP;
    dbms_output.put_line('====');
END LOOP;
END;
/
====
ATTR: CUST_YEAR_OF_BIRTH
SUBN:
EXPR: ("CUST_YEAR_OF_BIRTH"-1910)
EXPR: /77
REXP: "CUST_YEAR_OF_BIRTH"*77
REXP: +1910
====

```

### 36.2.3.23 SET\_TRANSFORM Procedure

This procedure appends the transformation instructions for an attribute to a transformation list.

#### Syntax

```

DBMS_DATA_MINING_TRANSFORM.SET_TRANSFORM (
    xform_list          IN OUT NOCOPY TRANSFORM_LIST,
    attribute_name      VARCHAR2,
    attribute_subname   VARCHAR2,
    expression         VARCHAR2,
    reverse_expression  VARCHAR2,
    attribute_spec      VARCHAR2 DEFAULT NULL);

```

## Parameters

**Table 36-146 SET\_TRANSFORM Procedure Parameters**

Parameter	Description
xform_list	A transformation list. See <a href="#">Table 36-114</a> for a description of the TRANSFORM_LIST object type.
attribute_name	Name of the attribute to be transformed
attribute_subname	Name of the nested attribute if <i>attribute_name</i> is a nested column, otherwise NULL.
expression	A SQL expression that specifies the transformation of the attribute.
reverse_expression	A SQL expression that reverses the transformation for readability in model details and in the target of a supervised model (if the attribute is a target)
attribute_spec	One or more keywords that identify special treatment for the attribute during model build. Values are: <ul style="list-style-type: none"> <li>• NOPREP — When ADP is on, prevents automatic transformation of the attribute. If ADP is not on, this value has no effect.</li> <li>• TEXT — Causes the attribute to be treated as unstructured text data</li> <li>• FORCE_IN — Forces the inclusion of the attribute in the model build. Applies only to GLM models with feature selection enabled (<i>ftr_selection_enable</i> = yes). Feature selection is disabled by default.</li> </ul> <p>If the model is not using GLM with feature selection, this value has no effect.</p> <p>See "Specifying Transformation Instructions for an Attribute" in <i>Oracle Data Mining User's Guide</i> for more information about <i>attribute_spec</i>.</p>

## Usage Notes

1. See the following relevant sections in "[Operational Notes](#)":
  - About Transformation Lists
  - Nested Data Transformations
2. As shown in the following example, you can eliminate an attribute by specifying a null transformation expression and reverse expression. You can also use the STACK interface to remove a column ([CREATE\\_COL\\_REM Procedure](#) and [STACK\\_COL\\_REM Procedure](#)).

### 36.2.3.24 STACK\_BIN\_CAT Procedure

This procedure adds categorical binning transformations to a transformation list.

#### Syntax

```
DBMS_DATA_MINING_TRANSFORM.STACK_BIN_CAT (
  bin_table_name      IN          VARCHAR2,
  xform_list          IN OUT NOCOPY TRANSFORM_LIST,
  literal_flag        IN          BOOLEAN DEFAULT FALSE,
  bin_schema_name     IN          VARCHAR2 DEFAULT NULL);
```



## Parameters

**Table 36-147** STACK\_BIN\_CAT Procedure Parameters

Parameter	Description
<code>bin_table_name</code>	Name of the transformation definition table for categorical binning. You can use the <a href="#">CREATE_BIN_CAT Procedure</a> to create the definition table. The table must be populated with transformation definitions before you call <code>STACK_BIN_CAT</code> . To populate the table, you can use one of the <code>INSERT</code> procedures for categorical binning or you can write your own SQL. See <a href="#">Table 36-117</a> .
<code>xform_list</code>	A transformation list. See <a href="#">Table 36-114</a> for a description of the <code>TRANSFORM_LIST</code> object type.
<code>literal_flag</code>	Indicates whether the values in the <code>bin</code> column in the transformation definition table are valid SQL literals. When <code>literal_flag</code> is <code>FALSE</code> (the default), the bin identifiers will be transformed to SQL literals by surrounding them with single quotes.  Set <code>literal_flag</code> to <code>TRUE</code> if the bin identifiers are numbers that should have a numeric datatype, as is the case for an O-Cluster model. See " <a href="#">INSERT_BIN_NUM_EQWIDTH Procedure</a> " for an example.
<code>bin_schema_name</code>	Schema of <code>bin_table_name</code> . If no schema is specified, the current schema is used.

## Usage Notes

See "[Operational Notes](#)". The following sections are especially relevant:

- "[About Transformation Lists](#)"
- "[About Stacking](#)"
- "[Nested Data Transformations](#)"

## Examples

This example shows how a binning transformation for the categorical column `cust_postal_code` could be added to a stack called `mining_data_stack`.

**Note:**

This example invokes the [XFORM\\_STACK Procedure](#) to show how the data is transformed by the stack. `XFORM_STACK` simply generates an external view of the transformed data. The actual purpose of the `STACK` procedures is to assemble a list of transformations for embedding in a model. The transformations are passed to `CREATE_MODEL` in the `xform_list` parameter. See [INSERT\\_BIN\\_NUM\\_EQWIDTH Procedure](#) for an example.

```
CREATE or REPLACE VIEW mining_data AS
  SELECT cust_id, cust_postal_code, cust_credit_limit
     FROM sh.customers
     WHERE cust_id BETWEEN 100050 AND 100100;
BEGIN
  dbms_data_mining_transform.CREATE_BIN_CAT ('bin_cat_tbl');
```

```

    dbms_data_mining_transform.INSERT_BIN_CAT_FREQ (
        bin_table_name => 'bin_cat_tbl',
        data_table_name => 'mining_data',
        bin_num         => 3);
END;
/
DECLARE
    MINING_DATA_STACK dbms_data_mining_transform.TRANSFORM_LIST;
BEGIN
    dbms_data_mining_transform.STACK_BIN_CAT (
        bin_table_name     => 'bin_cat_tbl',
        xform_list         => mining_data_stack);
    dbms_data_mining_transform.XFORM_STACK (
        xform_list         => mining_data_stack,
        data_table_name    => 'mining_data',
        xform_view_name    => 'mining_data_stack_view');
END;
/
-- Before transformation
column cust_postal_code format a16
SELECT * from mining_data
        WHERE cust_id BETWEEN 100050 AND 100053
        ORDER BY cust_id;

    CUST_ID CUST_POSTAL_CODE CUST_CREDIT_LIMIT
-----
100050 76486                    1500
100051 73216                    9000
100052 69499                    5000
100053 45704                    7000

-- After transformation
SELECT * FROM mining_data_stack_view
        WHERE cust_id BETWEEN 100050 AND 100053
        ORDER BY cust_id;

    CUST_ID CUST_POSTAL_CODE CUST_CREDIT_LIMIT
-----
100050 4                        1500
100051 1                        9000
100052 4                        5000
100053 4                        7000

```

### 36.2.3.25 STACK\_BIN\_NUM Procedure

This procedure adds numerical binning transformations to a transformation list.

#### Syntax

```

DBMS_DATA_MINING_TRANSFORM.STACK_BIN_NUM (
    bin_table_name    IN          VARCHAR2,
    xform_list        IN OUT     NOCOPY TRANSFORM_LIST,
    literal_flag      IN          BOOLEAN DEFAULT FALSE,
    bin_schema_name   IN          VARCHAR2 DEFAULT NULL);

```

## Parameters

**Table 36-148** STACK\_BIN\_NUM Procedure Parameters

Parameter	Description
<code>bin_table_name</code>	Name of the transformation definition table for numerical binning. You can use the <a href="#">CREATE_BIN_NUM Procedure</a> to create the definition table. The table must be populated with transformation definitions before you call <code>STACK_BIN_NUM</code> . To populate the table, you can use one of the <code>INSERT</code> procedures for numerical binning or you can write your own SQL. See <a href="#">Table 36-119</a> .
<code>xform_list</code>	A transformation list. See <a href="#">Table 36-114</a> for a description of the <code>TRANSFORM_LIST</code> object type.
<code>literal_flag</code>	Indicates whether the values in the <code>bin</code> column in the transformation definition table are valid SQL literals. When <code>literal_flag</code> is <code>FALSE</code> (the default), the bin identifiers will be transformed to SQL literals by surrounding them with single quotes.  Set <code>literal_flag</code> to <code>TRUE</code> if the bin identifiers are numbers that should have a numeric datatype, as is the case for an O-Cluster model.  See " <a href="#">INSERT_BIN_NUM_EQWIDTH Procedure</a> " for an example.
<code>bin_schema_name</code>	Schema of <code>bin_table_name</code> . If no schema is specified, the current schema is used.

## Usage Notes

See "[Operational Notes](#)". The following sections are especially relevant:

- "[About Transformation Lists](#)"
- "[About Stacking](#)"
- "[Nested Data Transformations](#)"

## Examples

This example shows how a binning transformation for the numerical column `cust_credit_limit` could be added to a stack called `mining_data_stack`.

### Note:

This example invokes the [XFORM\\_STACK Procedure](#) to show how the data is transformed by the stack. `XFORM_STACK` simply generates an external view of the transformed data. The actual purpose of the `STACK` procedures is to assemble a list of transformations for embedding in a model. The transformations are passed to `CREATE_MODEL` in the `xform_list` parameter. See [INSERT\\_BIN\\_NUM\\_EQWIDTH Procedure](#) for an example.

```
CREATE OR REPLACE VIEW mining_data AS
  SELECT cust_id, cust_postal_code, cust_credit_limit
     FROM sh.customers
     WHERE cust_id BETWEEN 100050 and 100100;
BEGIN
  dbms_data_mining_transform.create_bin_num ('bin_num_tbl');
```

```

dbms_data_mining_transform.insert_bin_num_qtile (
bin_table_name => 'bin_num_tbl',
data_table_name => 'mining_data',
bin_num => 5,
exclude_list => dbms_data_mining_transform.COLUMN_LIST('cust_id'));
END;
/
DECLARE
MINING_DATA_STACK dbms_data_mining_transform.TRANSFORM_LIST;
BEGIN
dbms_data_mining_transform.STACK_BIN_CAT (
bin_table_name => 'bin_num_tbl',
xform_list => mining_data_stack);
dbms_data_mining_transform.XFORM_STACK (
xform_list => mining_data_stack,
data_table_name => 'mining_data',
xform_view_name => 'mining_data_stack_view');
END;
/
-- Before transformation
SELECT cust_id, cust_postal_code, ROUND(cust_credit_limit) FROM mining_data
WHERE cust_id BETWEEN 100050 AND 100055
ORDER BY cust_id;
CUST_ID CUST_POSTAL_CODE ROUND(CUST_CREDIT_LIMIT)
-----
100050 76486 1500
100051 73216 9000
100052 69499 5000
100053 45704 7000
100055 74673 11000
100055 74673 11000

-- After transformation
SELECT cust_id, cust_postal_code, ROUND(cust_credit_limit)
FROM mining_data_stack_view
WHERE cust_id BETWEEN 100050 AND 100055
ORDER BY cust_id;
CUST_ID CUST_POSTAL_CODE ROUND(CUST_CREDIT_LIMITT)
-----
100050 76486
100051 73216 2
100052 69499 1
100053 45704
100054 88021 3
100055 74673 3

```

### 36.2.3.26 STACK\_CLIP Procedure

This procedure adds clipping transformations to a transformation list.

#### Syntax

```

DBMS_DATA_MINING_TRANSFORM.STACK_CLIP (
clip_table_name IN VARCHAR2,
xform_list IN OUT NOCOPY TRANSFORM_LIST,
clip_schema_name IN VARCHAR2 DEFAULT NULL);

```

## Parameters

**Table 36-149** STACK\_CLIP Procedure Parameters

Parameter	Description
clip_table_name	Name of the transformation definition table for clipping. You can use the <a href="#">CREATE_CLIP Procedure</a> to create the definition table. The table must be populated with transformation definitions before you call <code>STACK_CLIP</code> . To populate the table, you can use one of the <code>INSERT</code> procedures for clipping or you can write your own SQL. See <a href="#">Table 36-121</a> .
xform_list	A transformation list. See <a href="#">Table 36-114</a> for a description of the <code>TRANSFORM_LIST</code> object type.
clip_schema_name	Schema of <i>clip_table_name</i> . If no schema is specified, the current schema is used.

## Usage Notes

See [DBMS\\_DATA\\_MINING\\_TRANSFORM Operational Notes](#). The following sections are especially relevant:

- “About Transformation Lists”
- “About Stacking”
- “Nested Data Transformations”

## Examples

This example shows how a clipping transformation for the numerical column `cust_credit_limit` could be added to a stack called `mining_data_stack`.

### Note:

This example invokes the [XFORM\\_STACK Procedure](#) to show how the data is transformed by the stack. `XFORM_STACK` simply generates an external view of the transformed data. The actual purpose of the `STACK` procedures is to assemble a list of transformations for embedding in a model. The transformations are passed to `CREATE_MODEL` in the `xform_list` parameter. See [INSERT\\_BIN\\_NUM\\_EQWIDTH Procedure](#) for an example.

```
CREATE OR REPLACE VIEW mining_data AS
  SELECT cust_id, cust_postal_code, cust_credit_limit
  FROM sh.customers
  WHERE cust_id BETWEEN 100050 AND 100100;

BEGIN
  dbms_data_mining_transform.create_clip ('clip_tbl');
  dbms_data_mining_transform.insert_clip_winsor_tail (
    clip_table_name => 'clip_tbl',
    data_table_name => 'mining_data',
    tail_frac       => 0.25,
    exclude_list    => dbms_data_mining_transform.COLUMN_LIST('cust_id'));
END;
/
```

```

DECLARE
  MINING_DATA_STACK  dbms_data_mining_transform.TRANSFORM_LIST;
BEGIN
  dbms_data_mining_transform.STACK_CLIP (
    clip_table_name  => 'clip_tbl',
    xform_list       => mining_data_stack);
  dbms_data_mining_transform.XFORM_STACK (
    xform_list       => mining_data_stack,
    data_table_name  => 'mining_data',
    xform_view_name  => 'mining_data_stack_view');
END;
/
-- Before transformation
SELECT cust_id, cust_postal_code, round(cust_credit_limit)
  FROM mining_data
     WHERE cust_id BETWEEN 100050 AND 100054
     ORDER BY cust_id;

CUST_ID  CUST_POSTAL_CODE  ROUND(CUST_CREDIT_LIMIT)
-----  -
100050   76486              1500
100051   73216              9000
100052   69499              5000
100053   45704              7000
100054   88021              11000

-- After transformation
SELECT cust_id, cust_postal_code, round(cust_credit_limit)
  FROM mining_data_stack_view
     WHERE cust_id BETWEEN 100050 AND 100054
     ORDER BY cust_id;

CUST_ID  CUST_POSTAL_CODE  ROUND(CUST_CREDIT_LIMIT)
-----  -
100050   76486              5000
100051   73216              9000
100052   69499              5000
100053   45704              7000
100054   88021              11000

```

### 36.2.3.27 STACK\_COL\_REM Procedure

This procedure adds column removal transformations to a transformation list.

#### Syntax

```

DBMS_DATA_MINING_TRANSFORM.STACK_COL_REM (
  rem_table_name  IN          VARCHAR2,
  xform_list      IN OUT NOCOPY TRANSFORM_LIST,
  rem_schema_name IN          VARCHAR2 DEFAULT NULL);

```

## Parameters

**Table 36-150** STACK\_COL\_REM Procedure Parameters

Parameter	Description
rem_table_name	Name of the transformation definition table for column removal. You can use the <a href="#">CREATE_COL_REM Procedure</a> to create the definition table. See <a href="#">Table 36-123</a> .  The table must be populated with column names before you call STACK_COL_REM. The <a href="#">INSERT_BIN_SUPER Procedure</a> and the <a href="#">INSERT_AUTOBIN_NUM_EQWIDTH Procedure</a> can optionally be used to populate the table. You can also use SQL INSERT statements.
xform_list	A transformation list. See <a href="#">Table 36-114</a> for a description of the TRANSFORM_LIST object type.
rem_schema_name	Schema of <i>rem_table_name</i> . If no schema is specified, the current schema is used.

## Usage Notes

See "[Operational Notes](#)". The following sections are especially relevant:

- "[About Transformation Lists](#)"
- "[About Stacking](#)"
- "[Nested Data Transformations](#)"

## Examples

This example shows how the column `cust_credit_limit` could be removed in a transformation list called `mining_data_stack`.

### Note:

This example invokes the [XFORM\\_STACK Procedure](#) to show how the data is transformed by the stack. XFORM\_STACK simply generates an external view of the transformed data. The actual purpose of the STACK procedures is to assemble a list of transformations for embedding in a model. The transformations are passed to CREATE\_MODEL in the xform\_list parameter. See [INSERT\\_BIN\\_NUM\\_EQWIDTH Procedure](#) for an example.

```
CREATE OR REPLACE VIEW mining_data AS
  SELECT cust_id, country_id, cust_postal_code, cust_credit_limit
     FROM sh.customers;

BEGIN
  dbms_data_mining_transform.create_col_rem ('rem_tbl');
END;
/

INSERT into rem_tbl VALUES (upper('cust_postal_code'), null);

DECLARE
  MINING_DATA_STACK  dbms_data_mining_transform.TRANSFORM_LIST;
```

```

BEGIN
  dbms_data_mining_transform.stack_col_rem (
    rem_table_name => 'rem_tbl',
    xform_list     => mining_data_stack);
  dbms_data_mining_transform.XFORM_STACK (
    xform_list     => mining_data_stack,
    data_table_name => 'mining_data',
    xform_view_name => 'mining_data_stack_view');
END;
/

SELECT * FROM mining_data
WHERE cust_id BETWEEN 100050 AND 100051
ORDER BY cust_id;

CUST_ID   COUNTRY_ID   CUST_POSTAL_CODE   CUST_CREDIT_LIMIT
-----
100050    52773        76486               1500
100051    52790        73216               9000

SELECT * FROM mining_data_stack_view
WHERE cust_id BETWEEN 100050 AND 100051
ORDER BY cust_id;

CUST_ID   COUNTRY_ID   CUST_CREDIT_LIMIT
-----
100050    52773        1500
100051    52790        9000

```

### 36.2.3.28 STACK\_MISS\_CAT Procedure

This procedure adds categorical missing value transformations to a transformation list.

#### Syntax

```

DBMS_DATA_MINING_TRANSFORM.STACK_MISS_CAT (
  miss_table_name IN VARCHAR2,
  xform_list     IN OUT NOCOPY TRANSFORM_LIST,
  miss_schema_name IN VARCHAR2 DEFAULT NULL);

```

#### Parameters

**Table 36-151** STACK\_MISS\_CAT Procedure Parameters

Parameter	Description
miss_table_name	Name of the transformation definition table for categorical missing value treatment. You can use the <a href="#">CREATE_MISS_CAT Procedure</a> to create the definition table. The table must be populated with transformation definitions before you call STACK_MISS_CAT. To populate the table, you can use the <a href="#">INSERT_MISS_CAT_MODE Procedure</a> or you can write your own SQL. See <a href="#">Table 36-125</a> .
xform_list	A transformation list. See <a href="#">Table 36-114</a> for a description of the TRANSFORM_LIST object type.
miss_schema_name	Schema of miss_table_name. If no schema is specified, the current schema is used.



## Usage Notes

See "Operational Notes". The following sections are especially relevant:

- "About Transformation Lists"
- "About Stacking"
- "Nested Data Transformations"

## Examples

This example shows how the missing values in the column `cust_marital_status` could be replaced with the mode in a transformation list called `mining_data_stack`.

### Note:

This example invokes the [XFORM\\_STACK Procedure](#) to show how the data is transformed by the stack. `XFORM_STACK` simply generates an external view of the transformed data. The actual purpose of the `STACK` procedures is to assemble a list of transformations for embedding in a model. The transformations are passed to `CREATE_MODEL` in the `xform_list` parameter. See [INSERT\\_BIN\\_NUM\\_EQWIDTH Procedure](#) for an example.

```

CREATE OR REPLACE VIEW mining_data AS
  SELECT cust_id, country_id, cust_marital_status
     FROM sh.customers
        where cust_id BETWEEN 1 AND 10;

BEGIN
  dbms_data_mining_transform.create_miss_cat ('miss_cat_tbl');
  dbms_data_mining_transform.insert_miss_cat_mode ('miss_cat_tbl', 'mining_data');
END;
/

DECLARE
  MINING_DATA_STACK  dbms_data_mining_transform.TRANSFORM_LIST;
BEGIN
  dbms_data_mining_transform.stack_miss_cat (
    miss_table_name => 'miss_cat_tbl',
    xform_list      => mining_data_stack);
  dbms_data_mining_transform.XFORM_STACK (
    xform_list      => mining_data_stack,
    data_table_name => 'mining_data',
    xform_view_name => 'mining_data_stack_view');
END;
/
SELECT * FROM mining_data
   ORDER BY cust_id;

```

CUST_ID	COUNTRY_ID	CUST_MARITAL_STATUS
1	52789	
2	52778	
3	52770	
4	52770	
5	52789	
6	52769	single

```

7      52790    single
8      52790    married
9      52770    divorced
10     52790    widow

```

```

SELECT * FROM mining_data_stack_view
ORDER By cust_id;

```

```

CUST_ID  COUNTRY_ID  CUST_MARITAL_STATUS
-----  -
1         52789       single
2         52778       single
3         52770       single
4         52770       single
5         52789       single
6         52769       single
7         52790       single
8         52790       married
9         52770       divorced
10        52790       widow

```

### 36.2.3.29 STACK\_MISS\_NUM Procedure

This procedure adds numeric missing value transformations to a transformation list.

#### Syntax

```

DBMS_DATA_MINING_TRANSFORM.STACK_MISS_NUM (
  miss_table_name      IN      VARCHAR2,
  xform_list           IN OUT  NOCOPY TRANSFORM_LIST,
  miss_schema_name     IN      VARCHAR2 DEFAULT NULL);

```

#### Parameters

**Table 36-152** STACK\_MISS\_NUM Procedure Parameters

Parameter	Description
miss_table_name	Name of the transformation definition table for numerical missing value treatment. You can use the <a href="#">CREATE_MISS_NUM Procedure</a> to create the definition table. The table must be populated with transformation definitions before you call STACK_MISS_NUM. To populate the table, you can use the <a href="#">INSERT_MISS_NUM_MEAN Procedure</a> or you can write your own SQL. See <a href="#">Table 36-127</a> .
xform_list	A transformation list. See <a href="#">Table 36-114</a> for a description of the TRANSFORM_LIST object type.
miss_schema_name	Schema of miss_table_name. If no schema is specified, the current schema is used.

#### Usage Notes

See "[Operational Notes](#)". The following sections are especially relevant:

- "[About Transformation Lists](#)"
- "[About Stacking](#)"
- "[Nested Data Transformations](#)"

## Examples

This example shows how the missing values in the column `cust_credit_limit` could be replaced with the mean in a transformation list called `mining_data_stack`.

### Note:

This example invokes the [XFORM\\_STACK Procedure](#) to show how the data is transformed by the stack. `XFORM_STACK` simply generates an external view of the transformed data. The actual purpose of the `STACK` procedures is to assemble a list of transformations for embedding in a model. The transformations are passed to `CREATE_MODEL` in the `xform_list` parameter. See [INSERT\\_BIN\\_NUM\\_EQWIDTH Procedure](#) for an example.

```

describe mining_data
Name                                                    Null?    Type
-----
CUST_ID                                                NOT NULL NUMBER
CUST_CREDIT_LIMIT                                     NUMBER

BEGIN
  dbms_data_mining_transform.create_miss_num ('miss_num_tbl');
  dbms_data_mining_transform.insert_miss_num_mean ('miss_num_tbl','mining_data');
END;
/
SELECT * FROM miss_num_tbl;

COL           ATT           VAL
-----
CUST_ID              5.5
CUST_CREDIT_LIMIT    185.71

DECLARE
  MINING_DATA_STACK  dbms_data_mining_transform.TRANSFORM_LIST;
BEGIN
  dbms_data_mining_transform.STACK_MISS_NUM (
    miss_table_name  => 'miss_num_tbl',
    xform_list       => mining_data_stack);
  dbms_data_mining_transform.XFORM_STACK (
    xform_list       => mining_data_stack,
    data_table_name  => 'mining_data',
    xform_view_name  => 'mining_data_stack_view');
END;
/
-- Before transformation
SELECT * FROM mining_data
ORDER BY cust_id;
CUST_ID CUST_CREDIT_LIMIT
-----
      1             100
      2
      3             200
      4
      5             150
      6             400
      7             150
      8

```

```

          9          100
         10          200

-- After transformation
SELECT * FROM mining_data_stack_view
       ORDER BY cust_id;
CUST_ID CUST_CREDIT_LIMIT
-----
1         100
2         185.71
3         200
4         185.71
5         150
6         400
7         150
8         185.71
9         100
10        200

```

### 36.2.3.30 STACK\_NORM\_LIN Procedure

This procedure adds linear normalization transformations to a transformation list.

#### Syntax

```

DBMS_DATA_MINING_TRANSFORM.STACK_NORM_LIN (
  norm_table_name      IN      VARCHAR2,
  xform_list           IN OUT  NOCOPY TRANSFORM_LIST,
  norm_schema_name     IN      VARCHAR2 DEFAULT NULL);

```

#### Parameters

**Table 36-153** STACK\_NORM\_LIN Procedure Parameters

Parameter	Description
<code>norm_table_name</code>	Name of the transformation definition table for linear normalization. You can use the <a href="#">CREATE_NORM_LIN Procedure</a> to create the definition table. The table must be populated with transformation definitions before you call <code>STACK_NORM_LIN</code> . To populate the table, you can use one of the <code>INSERT</code> procedures for normalization or you can write your own SQL. See <a href="#">Table 36-129</a> .
<code>xform_list</code>	A transformation list. See <a href="#">Table 36-114</a> for a description of the <code>TRANSFORM_LIST</code> object type.
<code>norm_schema_name</code>	Schema of <code>norm_table_name</code> . If no schema is specified, the current schema is used.

#### Usage Notes

See "[Operational Notes](#)". The following sections are especially relevant:

- "[About Transformation Lists](#)"
- "[About Stacking](#)"
- "[Nested Data Transformations](#)"

## Examples

This example shows how the column `cust_credit_limit` could be normalized in a transformation list called `mining_data_stack`.

### Note:

This example invokes the [XFORM\\_STACK Procedure](#) to show how the data is transformed by the stack. `XFORM_STACK` simply generates an external view of the transformed data. The actual purpose of the `STACK` procedures is to assemble a list of transformations for embedding in a model. The transformations are passed to `CREATE_MODEL` in the `xform_list` parameter. See [INSERT\\_BIN\\_NUM\\_EQWIDTH Procedure](#) for an example.

```

CREATE OR REPLACE VIEW mining_data AS
    SELECT cust_id, country_id, cust_postal_code, cust_credit_limit
       FROM sh.customers;

BEGIN
    dbms_data_mining_transform.create_norm_lin ('norm_lin_tbl');
    dbms_data_mining_transform.insert_norm_lin_minmax (
        norm_table_name => 'norm_lin_tbl',
        data_table_name => 'mining_data',
        exclude_list    => dbms_data_mining_transform.COLUMN_LIST('cust_id',
                                                                    'country_id'));
END;
/
SELECT * FROM norm_lin_tbl;
COL          ATT      SHIFT  SCALE
-----
CUST_CREDIT_LIMIT          1500  13500

DECLARE
    MINING_DATA_STACK  dbms_data_mining_transform.TRANSFORM_LIST;
BEGIN
    dbms_data_mining_transform.stack_norm_lin (
        norm_table_name => 'norm_lin_tbl',
        xform_list      => mining_data_stack);
    dbms_data_mining_transform.XFORM_STACK (
        xform_list      => mining_data_stack,
        data_table_name => 'mining_data',
        xform_view_name => 'mining_data_stack_view');
END;
/
SELECT * FROM mining_data
   WHERE cust_id between 1 and 10
   ORDER BY cust_id;
CUST_ID COUNTRY_ID CUST_POSTAL_CODE    CUST_CREDIT_LIMIT
-----
      1      52789  30828                9000
      2      52778  86319               10000
      3      52770  88666                1500
      4      52770  87551                1500
      5      52789  59200                1500
      6      52769  77287                1500
      7      52790  38763                1500
      8      52790  58488                3000
      9      52770  63033                3000

```

```

10      52790 52602                                3000

SELECT * FROM mining_data_stack_view
WHERE cust_id between 1 and 10
ORDER BY cust_id;
CUST_ID COUNTRY_ID CUST_POSTAL_CODE      CUST_CREDIT_LIMIT
-----
1       52789 30828                          .55556
2       52778 86319                          .62963
3       52770 88666                           0
4       52770 87551                           0
5       52789 59200                           0
6       52769 77287                           0
7       52790 38763                           0
8       52790 58488                          .11111
9       52770 63033                          .11111
10      52790 52602                          .11111

```

### 36.2.3.31 XFORM\_BIN\_CAT Procedure

This procedure creates a view that implements the categorical binning transformations specified in a definition table. Only the columns that are specified in the definition table are transformed; the remaining columns from the data table are present in the view, but they are not changed.

#### Syntax

```

DBMS_DATA_MINING_TRANSFORM.XFORM_BIN_CAT (
  bin_table_name      IN VARCHAR2,
  data_table_name     IN VARCHAR2,
  xform_view_name     IN VARCHAR2,
  literal_flag        IN BOOLEAN DEFAULT FALSE,
  bin_schema_name     IN VARCHAR2 DEFAULT NULL,
  data_schema_name    IN VARCHAR2 DEFAULT NULL,
  xform_schema_name   IN VARCHAR2 DEFAULT NULL);

```

#### Parameters

**Table 36-154 XFORM\_BIN\_CAT Procedure Parameters**

Parameter	Description
<code>bin_table_name</code>	Name of the transformation definition table for categorical binning. You can use the <a href="#">CREATE_BIN_CAT Procedure</a> to create the definition table. The table must be populated with transformation definitions before you call <code>XFORM_BIN_CAT</code> . To populate the table, you can use one of the <code>INSERT</code> procedures for categorical binning or you can write your own SQL. See <a href="#">Table 36-117</a> .
<code>data_table_name</code>	Name of the table containing the data to be transformed.
<code>xform_view_name</code>	Name of the view to be created. The view presents columns in <code>data_table_name</code> with the transformations specified in <code>bin_table_name</code> .

**Table 36-154 (Cont.) XFORM\_BIN\_CAT Procedure Parameters**

Parameter	Description
<code>literal_flag</code>	Indicates whether the values in the <code>bin</code> column in the transformation definition table are valid SQL literals. When <code>literal_flag</code> is FALSE (the default), the bin identifiers will be transformed to SQL literals by surrounding them with single quotes. Set <code>literal_flag</code> to TRUE if the bin identifiers are numbers that should have a numeric datatype, as is the case for an O-Cluster model. See " <a href="#">INSERT_BIN_NUM_EQWIDTH Procedure</a> " for an example.
<code>bin_schema_name</code>	Schema of <code>bin_table_name</code> . If no schema is specified, the current schema is used.
<code>data_schema_name</code>	Schema of <code>data_table_name</code> . If no schema is specified, the current schema is used.
<code>xform_schema_name</code>	Schema of <code>xform_view_name</code> . If no schema is specified, the current schema is used.

### Usage Notes

See "[Operational Notes](#)".

### Examples

This example creates a view that bins the `cust_postal_code` column. The data source consists of three columns from `sh.customer`.

```
describe mining_data
Name                                         Null?    Type
-----
CUST_ID                                     NOT NULL NUMBER
CUST_POSTAL_CODE                           NOT NULL VARCHAR2(10)
CUST_CREDIT_LIMIT                           NUMBER

SELECT * FROM mining_data WHERE cust_id between 104066 and 104069;

      CUST_ID CUST_POSTAL_CODE
CUST_CREDIT_LIMIT
-----
104066 69776
7000
104067 52602
9000
104068 55787
11000
104069 55977
5000

BEGIN
  dbms_data_mining_transform.create_bin_cat(
    bin_table_name => 'bin_cat_tbl');
  dbms_data_mining_transform.insert_bin_cat_freq(
    bin_table_name => 'bin_cat_tbl',
    data_table_name => 'mining_data',
    bin_num        => 10);
  dbms_data_mining_transform.xform_bin_cat(
    bin_table_name => 'bin_cat_tbl',
```

```

        data_table_name => 'mining_data',
        xform_view_name => 'bin_cat_view');
END;
/

SELECT * FROM bin_cat_view WHERE cust_id between 104066 and 104069;

      CUST_ID CUST_POSTAL_CODE
CUST_CREDIT_LIMIT
-----
-----
      104066 6
7000
      104067 11
9000
      104068 3
11000
      104069 11
5000

SELECT text FROM user_views WHERE view_name IN 'BIN_CAT_VIEW';

TEXT
-----

SELECT
"CUST_ID",DECODE("CUST_POSTAL_CODE",'38082','1','45704','9','48346','5','
55787','3','63736','2','67843','7','69776','6','72860','10','78558','4','80841',
'8',NULL,NULL,'11') "CUST_POSTAL_CODE","CUST_CREDIT_LIMIT" FROM
mining_data

```

### 36.2.3.32 XFORM\_BIN\_NUM Procedure

This procedure creates a view that implements the numerical binning transformations specified in a definition table. Only the columns that are specified in the definition table are transformed; the remaining columns from the data table are present in the view, but they are not changed.

#### Syntax

```

DBMS_DATA_MINING_TRANSFORM.XFORM_BIN_NUM (
  bin_table_name      IN VARCHAR2,
  data_table_name     IN VARCHAR2,
  xform_view_name     IN VARCHAR2,
  literal_flag        IN BOOLEAN DEFAULT FALSE,
  bin_schema_name     IN VARCHAR2 DEFAULT NULL,
  data_schema_name    IN VARCHAR2 DEFAULT NULL,
  xform_schema_name   IN VARCHAR2 DEFAULT NULL);

```



## Parameters

**Table 36-155 XFORM\_BIN\_NUM Procedure Parameters**

Parameter	Description
<code>bin_table_name</code>	Name of the transformation definition table for numerical binning. You can use the <a href="#">CREATE_BIN_NUM Procedure</a> to create the definition table. The table must be populated with transformation definitions before you call <code>XFORM_BIN_NUM</code> . To populate the table, you can use one of the <code>INSERT</code> procedures for numerical binning or you can write your own SQL. See "Table 36-119".
<code>data_table_name</code>	Name of the table containing the data to be transformed
<code>xform_view_name</code>	Name of the view to be created. The view presents columns in <code>data_table_name</code> with the transformations specified in <code>bin_table_name</code> .
<code>literal_flag</code>	Indicates whether the values in the <code>bin</code> column in the transformation definition table are valid SQL literals. When <code>literal_flag</code> is <code>FALSE</code> (the default), the bin identifiers will be transformed to SQL literals by surrounding them with single quotes.  Set <code>literal_flag</code> to <code>TRUE</code> if the bin identifiers are numbers that should have a numeric datatype, as is the case for an O-Cluster model. See " <a href="#">INSERT_BIN_NUM_EQWIDTH Procedure</a> " for an example.
<code>bin_schema_name</code>	Schema of <code>bin_table_name</code> . If no schema is specified, the current schema is used.
<code>data_schema_name</code>	Schema of <code>data_table_name</code> . If no schema is specified, the current schema is used.
<code>xform_schema_name</code>	Schema of <code>xform_view_name</code> . If no schema is specified, the current schema is used.

## Usage Notes

See "[Operational Notes](#)".

## Examples

This example creates a view that bins the `cust_credit_limit` column. The data source consists of three columns from `sh.customer`.

```
describe mining_data
Name                                     Null?    Type
-----
CUST_ID                                 NOT NULL NUMBER
CUST_POSTAL_CODE                       NOT NULL VARCHAR2(10)
CUST_CREDIT_LIMIT                       NUMBER

column cust_credit_limit off
SELECT * FROM mining_data WHERE cust_id between 104066 and 104069;

   CUST_ID CUST_POSTAL_CODE  CUST_CREDIT_LIMIT
-----
104066 69776                7000
104067 52602                9000
104068 55787               11000
104069 55977                5000
```

```

BEGIN
  dbms_data_mining_transform.create_bin_num(
    bin_table_name => 'bin_num_tbl');
  dbms_data_mining_transform.insert_autobin_num_eqwidth(
    bin_table_name => 'bin_num_tbl',
    data_table_name => 'mining_data',
    bin_num => 5,
    max_bin_num => 10,
    exclude_list => dbms_data_mining_transform.COLUMN_LIST('cust_id'));
  dbms_data_mining_transform.xform_bin_num(
    bin_table_name => 'bin_num_tbl',
    data_table_name => 'mining_data',
    xform_view_name => 'mining_data_view');

END;
/
describe mining_data_view
Name                               Null?    Type
-----
CUST_ID                             NOT NULL NUMBER
CUST_POSTAL_CODE                     NOT NULL VARCHAR2(10)
CUST_CREDIT_LIMIT                     VARCHAR2(2)

col cust_credit_limit on
col cust_credit_limit format a25
SELECT * FROM mining_data_view WHERE cust_id between 104066 and 104069;

      CUST_ID CUST_POSTAL_CODE
CUST_CREDIT_LIMIT
-----
104066 69776
5
104067 52602
6
104068 55787
8
104069 55977
3

set long 2000
SELECT text FROM user_views WHERE view_name IN 'MINING_DATA_VIEW';

TEXT
-----

SELECT "CUST_ID","CUST_POSTAL_CODE",CASE WHEN "CUST_CREDIT_LIMIT"<1500 THEN
NULL
  WHEN "CUST_CREDIT_LIMIT"<=2850 THEN '1' WHEN "CUST_CREDIT_LIMIT"<=4200 THEN
'2'
  WHEN "CUST_CREDIT_LIMIT"<=5550 THEN '3' WHEN "CUST_CREDIT_LIMIT"<=6900 THEN
'4'
  WHEN "CUST_CREDIT_LIMIT"<=8250 THEN '5' WHEN "CUST_CREDIT_LIMIT"<=9600 THEN
'6'
  WHEN "CUST_CREDIT_LIMIT"<=10950 THEN '7' WHEN "CUST_CREDIT_LIMIT"<=12300 THEN
,
8' WHEN "CUST_CREDIT_LIMIT"<=13650 THEN '9' WHEN "CUST_CREDIT_LIMIT"<=15000
THEN
'10' END "CUST_CREDIT_LIMIT" FROM mining_data

```

### 36.2.3.33 XFORM\_CLIP Procedure

This procedure creates a view that implements the clipping transformations specified in a definition table. Only the columns that are specified in the definition table are transformed; the remaining columns from the data table are present in the view, but they are not changed.

#### Syntax

```
DBMS_DATA_MINING_TRANSFORM.XFORM_CLIP (
  clip_table_name      IN VARCHAR2,
  data_table_name      IN VARCHAR2,
  xform_view_name      IN VARCHAR2,
  clip_schema_name     IN VARCHAR2 DEFAULT NULL,
  data_schema_name     IN VARCHAR2,DEFAULT NULL,
  xform_schema_name    IN VARCHAR2,DEFAULT NULL);
```

#### Parameters

**Table 36-156 XFORM\_CLIP Procedure Parameters**

Parameter	Description
clip_table_name	Name of the transformation definition table for clipping. You can use the <a href="#">CREATE_CLIP Procedure</a> to create the definition table. The table must be populated with transformation definitions before you call XFORM_CLIP. To populate the table, you can use one of the INSERT procedures for clipping you can write your own SQL. See <a href="#">Table 36-121</a> .
data_table_name	Name of the table containing the data to be transformed
xform_view_name	Name of the view to be created. The view presents columns in <i>data_table_name</i> with the transformations specified in <i>clip_table_name</i> .
clip_schema_name	Schema of <i>clip_table_name</i> . If no schema is specified, the current schema is used.
data_schema_name	Schema of <i>data_table_name</i> . If no schema is specified, the current schema is used.
xform_schema_name	Schema of <i>xform_view_name</i> . If no schema is specified, the current schema is used.

#### Examples

This example creates a view that clips the `cust_credit_limit` column. The data source consists of three columns from `sh.customer`.

```
describe mining_data
Name                               Null?    Type
-----
CUST_ID                            NOT NULL NUMBER
CUST_POSTAL_CODE                    NOT NULL VARCHAR2(10)
CUST_CREDIT_LIMIT                   NUMBER

BEGIN
  dbms_data_mining_transform.create_clip(
    clip_table_name => 'clip_tbl');
  dbms_data_mining_transform.insert_clip_trim_tail(
    clip_table_name => 'clip_tbl',
    data_table_name => 'mining_data',
```

```

        tail_frac          => 0.05,
        exclude_list      => dbms_data_mining_transform.COLUMN_LIST('cust_id'));
    dbms_data_mining_transform.xform_clip(
        clip_table_name   => 'clip_tbl',
        data_table_name   => 'mining_data',
        xform_view_name   => 'clip_view');
END;
/
describe clip_view
Name                                Null?    Type
-----
CUST_ID                             NOT NULL NUMBER
CUST_POSTAL_CODE                     NOT NULL VARCHAR2(10)
CUST_CREDIT_LIMIT                     NUMBER

SELECT MIN(cust_credit_limit), MAX(cust_credit_limit) FROM mining_data;

MIN(CUST_CREDIT_LIMIT) MAX(CUST_CREDIT_LIMIT)
-----
                1500                15000

SELECT MIN(cust_credit_limit), MAX(cust_credit_limit) FROM clip_view;

MIN(CUST_CREDIT_LIMIT) MAX(CUST_CREDIT_LIMIT)
-----
                1500                11000

set long 2000
SELECT text FROM user_views WHERE view_name IN 'CLIP_VIEW';

TEXT
-----
SELECT "CUST_ID","CUST_POSTAL_CODE",CASE WHEN "CUST_CREDIT_LIMIT" < 1500 THEN NU
LL WHEN "CUST_CREDIT_LIMIT" > 11000 THEN NULL ELSE "CUST_CREDIT_LIMIT" END "CUST
_CREDIT_LIMIT" FROM mining_data

```

### 36.2.3.34 XFORM\_COL\_REM Procedure

This procedure creates a view that implements the column removal transformations specified in a definition table. Only the columns that are specified in the definition table are removed; the remaining columns from the data table are present in the view.

#### Syntax

```

DBMS_DATA_MINING_TRANSFORM.XFORM_COL_REM (
    rem_table_name      IN      VARCHAR2,
    data_table_name     IN      VARCHAR2,
    xform_view_name     IN      VARCHAR2,
    rem_schema_name     IN      VARCHAR2 DEFAULT NULL,
    data_schema_name    IN      VARCHAR2 DEFAULT NULL,
    xform_schema_name   IN      VARCHAR2 DEFAULT NULL);

```

## Parameters

**Table 36-157 XFORM\_COL\_REM Procedure Parameters**

Parameter	Description
<code>rem_table_name</code>	Name of the transformation definition table for column removal. You can use the <a href="#">CREATE_COL_REM Procedure</a> to create the definition table. See <a href="#">Table 36-123</a> .  The table must be populated with column names before you call <code>XFORM_COL_REM</code> . The <a href="#">INSERT_BIN_SUPER Procedure</a> and the <a href="#">INSERT_AUTOBIN_NUM_EQWIDTH Procedure</a> can optionally be used to populate the table. You can also use SQL <code>INSERT</code> statements.
<code>data_table_name</code>	Name of the table containing the data to be transformed
<code>xform_view_name</code>	Name of the view to be created. The view presents the columns in <code>data_table_name</code> that are not specified in <code>rem_table_name</code> .
<code>rem_schema_name</code>	Schema of <code>rem_table_name</code> . If no schema is specified, the current schema is used.
<code>data_schema_name</code>	Schema of <code>data_table_name</code> . If no schema is specified, the current schema is used.
<code>xform_schema_name</code>	Schema of <code>xform_view_name</code> . If no schema is specified, the current schema is used.

## Usage Notes

See "[Operational Notes](#)".

## Examples

This example creates a view that includes all but one column from the table `customers` in the current schema.

```
describe customers
Name                                                    Null?    Type
-----
CUST_ID                                                NOT NULL NUMBER
CUST_MARITAL_STATUS                                   VARCHA2 (20)
OCCUPATION                                             VARCHA2 (21)
AGE                                                    NUMBER
YRS_RESIDENCE                                         NUMBER

BEGIN
  DBMS_DATA_MINING_TRANSFORM.CREATE_COL_REM ('colrem_xtbl');
END;
/
INSERT INTO colrem_xtbl VALUES('CUST_MARITAL_STATUS', null);

NOTE: This currently doesn't work. See bug 9310319

BEGIN
  DBMS_DATA_MINING_TRANSFORM.XFORM_COL_REM (
    rem_table_name      => 'colrem_xtbl',
    data_table_name     => 'customers',
    xform_view_name     => 'colrem_view');
END;
/
describe colrem_view
```

Name	Null?	Type
CUST_ID	NOT NULL	NUMBER
OCCUPATION		VARCHAR2 (21)
AGE		NUMBER
YRS_RESIDENCE		NUMBER

### 36.2.3.35 XFORM\_EXPR\_NUM Procedure

This procedure creates a view that implements the specified numeric transformations. Only the columns that you specify are transformed; the remaining columns from the data table are present in the view, but they are not changed.

#### Syntax

```
DBMS_DATA_MINING_TRANSFORM.XFORM_EXPR_NUM (
  expr_pattern      IN      VARCHAR2,
  data_table_name  IN      VARCHAR2,
  xform_view_name  IN      VARCHAR2,
  exclude_list     IN      COLUMN_LIST DEFAULT NULL,
  include_list     IN      COLUMN_LIST DEFAULT NULL,
  col_pattern      IN      VARCHAR2 DEFAULT ':col',
  data_schema_name IN      VARCHAR2 DEFAULT NULL,
  xform_schema_name IN     VARCHAR2 DEFAULT NULL);
```

#### Parameters

**Table 36-158 XFORM\_EXPR\_NUM Procedure Parameters**

Parameter	Description
<code>expr_pattern</code>	A numeric transformation expression
<code>data_table_name</code>	Name of the table containing the data to be transformed
<code>xform_view_name</code>	Name of the view to be created. The view presents columns in <code>data_table_name</code> with the transformations specified in <code>expr_pattern</code> and <code>col_pattern</code> .
<code>exclude_list</code>	List of numerical columns to exclude. If NULL, no numerical columns are excluded. The format of <code>exclude_list</code> is:  <pre>dbms_data_mining_transform.COLUMN_LIST('col1','col2',  ...'coln')</pre>
<code>include_list</code>	List of numeric columns to include. If NULL, all numeric columns are included. The format of <code>include_list</code> is:  <pre>dbms_data_mining_transform.COLUMN_LIST('col1','col2',  ...'coln')</pre>
<code>col_pattern</code>	The value within <code>expr_pattern</code> that will be replaced with a column name. The value of <code>col_pattern</code> is case-sensitive. The default value of <code>col_pattern</code> is <code>:col'</code>
<code>data_schema_name</code>	Schema of <code>data_table_name</code> . If no schema is specified, the current schema is used.

**Table 36-158 (Cont.) XFORM\_EXPR\_NUM Procedure Parameters**

Parameter	Description
<code>xform_schema_name</code>	Schema of <code>xform_view_name</code> . If no schema is specified, the current schema is used.

**Usage Notes**

1. The `XFORM_EXPR_NUM` procedure constructs numeric transformation expressions from the specified expression pattern (`expr_pattern`) by replacing every occurrence of the specified column pattern (`col_pattern`) with an actual column name.

`XFORM_EXPR_NUM` uses the SQL `REPLACE` function to construct the transformation expressions.

```
REPLACE (expr_pattern,col_pattern,"column_name") || "column_name"
```

If there is a column match, then the replacement is made in the transformation expression; if there is not a match, then the column is used without transformation.

**See:**

*Oracle Database SQL Language Reference* for information about the `REPLACE` function

2. Because of the include and exclude list parameters, the `XFORM_EXPR_NUM` and `XFORM_EXPR_STR` procedures allow you to easily specify individual columns for transformation within large data sets. The other `XFORM_*` procedures support an exclude list only. In these procedures, you must enumerate every column that you do not want to transform.
3. See "[Operational Notes](#)"

**Examples**

This example creates a view that transforms the datatype of numeric columns.

```
describe customers
Name                                     Null?    Type
-----
CUST_ID                                 NOT NULL NUMBER
CUST_MARITAL_STATUS                     VARCHAR2(20)
OCCUPATION                               VARCHAR2(21)
AGE                                       NUMBER
YRS_RESIDENCE                            NUMBER

BEGIN
  DBMS_DATA_MINING_TRANSFORM.XFORM_EXPR_NUM(
    expr_pattern      => 'to_char(:col)',
    data_table_name  => 'customers',
    xform_view_name  => 'cust_nonum_view',
    exclude_list     => dbms_data_mining_transform.COLUMN_LIST('cust_id'),
    include_list     => null,
    col_pattern      => ':col');
END;
/
```

```

describe cust_nonum_view
Name                               Null?    Type
-----
CUST_ID                             NOT NULL NUMBER
CUST_MARITAL_STATUS                 VARCHAR2(20)
OCCUPATION                          VARCHAR2(21)
AGE                                  VARCHAR2(40)
YRS_RESIDENCE                       VARCHAR2(40)

```

### 36.2.3.36 XFORM\_EXPR\_STR Procedure

This procedure creates a view that implements the specified categorical transformations. Only the columns that you specify are transformed; the remaining columns from the data table are present in the view, but they are not changed.

#### Syntax

```

DBMS_DATA_MINING_TRANSFORM.XFORM_EXPR_STR (
  expr_pattern      IN      VARCHAR2,
  data_table_name  IN      VARCHAR2,
  xform_view_name  IN      VARCHAR2,
  exclude_list     IN      COLUMN_LIST DEFAULT NULL,
  include_list     IN      COLUMN_LIST DEFAULT NULL,
  col_pattern      IN      VARCHAR2 DEFAULT ':col',
  data_schema_name IN      VARCHAR2 DEFAULT NULL,
  xform_schema_name IN     VARCHAR2 DEFAULT NULL);

```

#### Parameters

**Table 36-159 XFORM\_EXPR\_STR Procedure Parameters**

Parameter	Description
<code>expr_pattern</code>	A character transformation expression
<code>data_table_name</code>	Name of the table containing the data to be transformed
<code>xform_view_name</code>	Name of the view to be created. The view presents columns in <code>data_table_name</code> with the transformations specified in <code>expr_pattern</code> and <code>col_pattern</code> .
<code>exclude_list</code>	List of categorical columns to exclude. If NULL, no categorical columns are excluded. The format of <code>exclude_list</code> is: <code>dbms_data_mining_transform.COLUMN_LIST('col1','col2', ...'coln')</code>
<code>include_list</code>	List of character columns to include. If NULL, all character columns are included. The format of <code>include_list</code> is: <code>dbms_data_mining_transform.COLUMN_LIST('col1','col2', ...'coln')</code>
<code>col_pattern</code>	The value within <code>expr_pattern</code> that will be replaced with a column name. The value of <code>col_pattern</code> is case-sensitive. The default value of <code>col_pattern</code> is <code>:col</code>
<code>data_schema_name</code>	Schema of <code>data_table_name</code> . If no schema is specified, the current schema is used.



**Table 36-159 (Cont.) XFORM\_EXPR\_STR Procedure Parameters**

Parameter	Description
<code>xform_schema_name</code>	Schema of <code>xform_view_name</code> . If no schema is specified, the current schema is used.

### Usage Notes

1. The `XFORM_EXPR_STR` procedure constructs character transformation expressions from the specified expression pattern (`expr_pattern`) by replacing every occurrence of the specified column pattern (`col_pattern`) with an actual column name.

`XFORM_EXPR_STR` uses the SQL `REPLACE` function to construct the transformation expressions.

```
REPLACE (expr_pattern,col_pattern,'"column_name"' ) || '"column_name"'
```

If there is a column match, then the replacement is made in the transformation expression; if there is not a match, then the column is used without transformation.



#### See:

*Oracle Database SQL Language Reference* for information about the `REPLACE` function

2. Because of the include and exclude list parameters, the `XFORM_EXPR_STR` and `XFORM_EXPR_NUM` procedures allow you to easily specify individual columns for transformation within large data sets. The other `XFORM_*` procedures support an exclude list only. In these procedures, you must enumerate every column that you do not want to transform.
3. See "[Operational Notes](#)"

### Examples

This example creates a view that transforms character columns to upper case.

```
describe customers
Name                                     Null?    Type
-----
CUST_ID                                 NOT NULL NUMBER
CUST_MARITAL_STATUS                    VARCHAR2(20)
OCCUPATION                              VARCHAR2(21)
AGE                                     NUMBER
YRS_RESIDENCE                           NUMBER

SELECT cust_id, cust_marital_status, occupation FROM customers
WHERE   cust_id > 102995
ORDER BY cust_id desc;

CUST_ID CUST_MARITAL_STATUS OCCUPATION
-----
103000 Divorc.             Cleric.
102999 Married             Cleric.
```

```

102998 Married          Exec.
102997 Married          Exec.
102996 NeverM          Other

BEGIN
  DBMS_DATA_MINING_TRANSFORM.XFORM_EXPR_STR(
    expr_pattern         => 'upper(:col)',
    data_table_name     => 'customers',
    xform_view_name     => 'cust_upcase_view');
END;
/
describe cust_upcase_view
Name                               Null?    Type
-----
CUST_ID                             NOT NULL NUMBER
CUST_MARITAL_STATUS                 VARCHAR2(20)
OCCUPATION                           VARCHAR2(21)
AGE                                  NUMBER
YRS_RESIDENCE                        NUMBER

SELECT cust_id, cust_marital_status, occupation FROM cust_upcase_view
WHERE cust_id > 102995
ORDER BY cust_id desc;

CUST_ID CUST_MARITAL_STATUS OCCUPATION
-----
103000 DIVORC.             CLERIC.
102999 MARRIED             CLERIC.
102998 MARRIED             EXEC.
102997 MARRIED             EXEC.
102996 NEVERM             OTHER

```

### 36.2.3.37 XFORM\_MISS\_CAT Procedure

This procedure creates a view that implements the categorical missing value treatment transformations specified in a definition table. Only the columns that are specified in the definition table are transformed; the remaining columns from the data table are present in the view, but they are not changed.

#### Syntax

```

DBMS_DATA_MINING_TRANSFORM.XFORM_MISS_CAT (
  miss_table_name      IN VARCHAR2,
  data_table_name      IN VARCHAR2,
  xform_view_name      IN VARCHAR2,
  miss_schema_name     IN VARCHAR2 DEFAULT NULL,
  data_schema_name     IN VARCHAR2 DEFAULT NULL,
  xform_schema_name    IN VARCHAR2 DEFAULT NULL;

```

## Parameters

**Table 36-160 XFORM\_MISS\_CAT Procedure Parameters**

Parameter	Description
<code>miss_table_name</code>	Name of the transformation definition table for categorical missing value treatment. You can use the <a href="#">CREATE_MISS_CAT Procedure</a> to create the definition table. The table must be populated with transformation definitions before you call <code>XFORM_MISS_CAT</code> . To populate the table, you can use the <a href="#">INSERT_MISS_CAT_MODE Procedure</a> or you can write your own SQL. See <a href="#">Table 36-125</a> .
<code>data_table_name</code>	Name of the table containing the data to be transformed
<code>xform_view_name</code>	Name of the view to be created. The view presents columns in <code>data_table_name</code> with the transformations specified in <code>miss_table_name</code> .
<code>miss_schema_name</code>	Schema of <code>miss_table_name</code> . If no schema is specified, the current schema is used.
<code>data_schema_name</code>	Schema of <code>data_table_name</code> . If no schema is specified, the current schema is used.
<code>xform_schema_name</code>	Schema of <code>xform_view_name</code> . If no schema is specified, the current schema is used.

## Usage Notes

See "[Operational Notes](#)".

## Examples

This example creates a view that replaces missing categorical values with the mode.

```
SELECT * FROM geog;

REG_ID REGION
-----
1 NE
2 SW
3 SE
4 SW
5
6 NE
7 NW
8 NW
9
10
11 SE
12 SE
13 NW
14 SE
15 SE

SELECT STATS_MODE(region) FROM geog;

STATS_MODE (REGION)
-----
SE

BEGIN
```

```

DBMS_DATA_MINING_TRANSFORM.CREATE_MISS_CAT('misscat_xtbl');
DBMS_DATA_MINING_TRANSFORM.INSERT_MISS_CAT_MODE (
  miss_table_name      => 'misscat_xtbl',
  data_table_name      => 'geog' );
END;
/

SELECT col, val FROM misscat_xtbl;

COL          VAL
-----
REGION      SE

BEGIN
  DBMS_DATA_MINING_TRANSFORM.XFORM_MISS_CAT (
    miss_table_name      => 'misscat_xtbl',
    data_table_name      => 'geog',
    xform_view_name      => 'geogxf_view');
END;
/

SELECT * FROM geogxf_view;

REG_ID REGION
-----
1 NE
2 SW
3 SE
4 SW
5 SE
6 NE
7 NW
8 NW
9 SE
10 SE
11 SE
12 SE
13 NW
14 SE
15 SE

```

### 36.2.3.38 XFORM\_MISS\_NUM Procedure

This procedure creates a view that implements the numerical missing value treatment transformations specified in a definition table. Only the columns that are specified in the definition table are transformed; the remaining columns from the data table are present in the view, but they are not changed.

#### Syntax

```

DBMS_DATA_MINING_TRANSFORM.XFORM_MISS_NUM (
  miss_table_name      IN VARCHAR2,
  data_table_name      IN VARCHAR2,
  xform_view_name      IN VARCHAR2,
  miss_schema_name     IN VARCHAR2 DEFAULT NULL,
  data_schema_name     IN VARCHAR2 DEFAULT NULL,
  xform_schema_name    IN VARCHAR2 DEFAULT NULL;

```

## Parameters

**Table 36-161 XFORM\_MISS\_NUM Procedure Parameters**

Parameter	Description
<code>miss_table_name</code>	Name of the transformation definition table for numerical missing value treatment. You can use the <a href="#">CREATE_MISS_NUM Procedure</a> to create the definition table. The table must be populated with transformation definitions before you call <code>XFORM_MISS_NUM</code> . To populate the table, you can use the <a href="#">INSERT_MISS_NUM_MEAN Procedure</a> or you can write your own SQL. See <a href="#">Table 36-127</a> .
<code>data_table_name</code>	Name of the table containing the data to be transformed
<code>xform_view_name</code>	Name of the view to be created. The view presents columns in <code>data_table_name</code> with the transformations specified in <code>miss_table_name</code> .
<code>miss_schema_name</code>	Schema of <code>miss_table_name</code> . If no schema is specified, the current schema is used.
<code>data_schema_name</code>	Schema of <code>data_table_name</code> . If no schema is specified, the current schema is used.
<code>xform_schema_name</code>	Schema of <code>xform_view_name</code> . If no schema is specified, the current schema is used.

## Usage Notes

See "[Operational Notes](#)".

## Examples

This example creates a view that replaces missing numerical values with the mean.

```
SELECT * FROM items;
```

```
ITEM_ID      QTY
-----
aa           200
bb           200
cc           250
dd
ee
ff           100
gg           250
hh           200
ii
jj           200
```

```
SELECT AVG(qty) FROM items;
```

```
AVG(QTY)
-----
      200
```

```
BEGIN
  DBMS_DATA_MINING_TRANSFORM.CREATE_MISS_NUM('misnum_xtbl');
  DBMS_DATA_MINING_TRANSFORM.INSERT_MISS_NUM_MEAN (
    miss_table_name      => 'misnum_xtbl',
    data_table_name      => 'items' );
END;
```

```

END;
/

SELECT col, val FROM misnum_xtbl;

COL          VAL
-----
QTY          200

BEGIN
  DBMS_DATA_MINING_TRANSFORM.XFORM_MISS_NUM (
    miss_table_name      => 'misnum_xtbl',
    data_table_name      => 'items',
    xform_view_name      => 'items_view');
END;
/

SELECT * FROM items_view;

ITEM_ID      QTY
-----
aa           200
bb           200
cc           250
dd           200
ee           200
ff           100
gg           250
hh           200
ii           200
jj           200

```

### 36.2.3.39 XFORM\_NORM\_LIN Procedure

This procedure creates a view that implements the linear normalization transformations specified in a definition table. Only the columns that are specified in the definition table are transformed; the remaining columns from the data table are present in the view, but they are not changed.

#### Syntax

```

DBMS_DATA_MINING_TRANSFORM.XFORM_NORM_LIN (
  norm_table_name      IN VARCHAR2,
  data_table_name      IN VARCHAR2,
  xform_view_name      IN VARCHAR2,
  norm_schema_name     IN VARCHAR2 DEFAULT NULL,
  data_schema_name     IN VARCHAR2 DEFAULT NULL,
  xform_schema_name    IN VARCHAR2 DEFAULT NULL);

```

## Parameters

**Table 36-162 XFORM\_NORM\_LIN Procedure Parameters**

Parameter	Description
<code>norm_table_name</code>	Name of the transformation definition table for linear normalization. You can use the <a href="#">CREATE_NORM_LIN Procedure</a> to create the definition table. The table must be populated with transformation definitions before you call <code>XFORM_NORM_LIN</code> . To populate the table, you can use one of the <code>INSERT</code> procedures for normalization or you can write your own SQL. See <a href="#">Table 36-125</a> .
<code>data_table_name</code>	Name of the table containing the data to be transformed
<code>xform_view_name</code>	Name of the view to be created. The view presents columns in <code>data_table_name</code> with the transformations specified in <code>miss_table_name</code> .
<code>norm_schema_name</code>	Schema of <code>miss_table_name</code> . If no schema is specified, the current schema is used.
<code>data_schema_name</code>	Schema of <code>data_table_name</code> . If no schema is specified, the current schema is used.
<code>xform_schema_name</code>	Schema of <code>xform_view_name</code> . If no schema is specified, the current schema is used.

## Usage Notes

See "[Operational Notes](#)".

## Examples

This example creates a view that normalizes the `cust_year_of_birth` and `cust_credit_limit` columns. The data source consists of three columns from `sh.customer`.

```
CREATE OR REPLACE VIEW mining_data AS
  SELECT cust_id, cust_year_of_birth, cust_credit_limit
  FROM sh.customers;
```

```
describe mining_data
```

Name	Null?	Type
CUST_ID	NOT NULL	NUMBER
CUST_YEAR_OF_BIRTH	NOT NULL	NUMBER(4)
CUST_CREDIT_LIMIT		NUMBER

```
SELECT * FROM mining_data WHERE cust_id > 104495
  ORDER BY cust_year_of_birth;
```

CUST_ID	CUST_YEAR_OF_BIRTH	CUST_CREDIT_LIMIT
104496	1947	3000
104498	1954	10000
104500	1962	15000
104499	1970	3000
104497	1976	3000

```
BEGIN
  dbms_data_mining_transform.CREATE_NORM_LIN(
    norm_table_name => 'normx_tbl');
```

```

dbms_data_mining_transform.INSERT_NORM_LIN_MINMAX(
  norm_table_name => 'normx_tbl',
  data_table_name => 'mining_data',
  exclude_list   => dbms_data_mining_transform.COLUMN_LIST( 'cust_id'),
  round_num      => 3);
END;
/

SELECT col, shift, scale FROM normx_tbl;

COL                                SHIFT    SCALE
-----
CUST_YEAR_OF_BIRTH                 1910     77
CUST_CREDIT_LIMIT                  1500    13500

BEGIN
  DBMS_DATA_MINING_TRANSFORM.XFORM_NORM_LIN (
    norm_table_name => 'normx_tbl',
    data_table_name => 'mining_data',
    xform_view_name => 'norm_view');
END;
/

SELECT * FROM norm_view WHERE cust_id > 104495
       ORDER BY cust_year_of_birth;

CUST_ID CUST_YEAR_OF_BIRTH CUST_CREDIT_LIMIT
-----
104496          .4805195          .1111111
104498          .5714286          .6296296
104500          .6753247           1
104499          .7792208          .1111111
104497          .8571429          .1111111

set long 2000
SQL> SELECT text FROM user_views WHERE view_name IN 'NORM_VIEW';

TEXT
-----
SELECT "CUST_ID", ("CUST_YEAR_OF_BIRTH"-1910)/77 "CUST_YEAR_OF_BIRTH", ("CUST
_CREDIT_LIMIT"-1500)/13500 "CUST_CREDIT_LIMIT" FROM mining_data

```

### 36.2.3.40 XFORM\_STACK Procedure

This procedure creates a view that implements the transformations specified by the stack. Only the columns and nested attributes that are specified in the stack are transformed. Any remaining columns and nested attributes from the data table appear in the view without changes.

To create a list of objects that describe the transformed columns, use the [DESCRIBE\\_STACK Procedure](#).



**See Also:**["Overview"](#)*Oracle Data Mining User's Guide* for more information about data mining attributes**Syntax**

```

DBMS_DATA_MINING_TRANSFORM.XFORM_STACK (
  xform_list          IN      TRANSFORM_list,
  data_table_name     IN      VARCHAR2,
  xform_view_name     IN      VARCHAR2,
  data_schema_name   IN      VARCHAR2 DEFAULT NULL,
  xform_schema_name  IN      VARCHAR2 DEFAULT NULL);

```

**Parameters****Table 36-163 XFORM\_STACK Procedure Parameters**

Parameter	Description
<code>xform_list</code>	The transformation list. See <a href="#">Table 36-114</a> for a description of the <code>TRANSFORM_LIST</code> object type.
<code>data_table_name</code>	Name of the table containing the data to be transformed
<code>xform_view_name</code>	Name of the view to be created. The view applies the transformations in <code>xform_list</code> to <code>data_table_name</code> .
<code>data_schema_name</code>	Schema of <code>data_table_name</code> . If no schema is specified, the current schema is used.
<code>xform_schema_name</code>	Schema of <code>xform_view_name</code> . If no schema is specified, the current schema is used.

**Usage Notes**

See ["Operational Notes"](#). The following sections are especially relevant:

- ["About Transformation Lists"](#)
- ["About Stacking"](#)
- ["Nested Data Transformations"](#)

**Examples**

This example applies a transformation list to the view `dmuser.cust_info` and shows how the data is transformed. The `CREATE` statement for `cust_info` is shown in ["DESCRIBE\\_STACK Procedure"](#).

```

BEGIN
  dbms_data_mining_transform.CREATE_BIN_NUM ('birth_yr_bins');
  dbms_data_mining_transform.INSERT_BIN_NUM_QTILE (
    bin_table_name => 'birth_yr_bins',
    data_table_name => 'cust_info',
    bin_num        => 6,
    exclude_list   => dbms_data_mining_transform.column_list(
                      'cust_id','country_id'));
END;

```

```

/
SELECT * FROM birth_yr_bins;

COL          ATT          VAL BIN
-----
CUST_YEAR_OF_BIRTH          1922
CUST_YEAR_OF_BIRTH          1951 1
CUST_YEAR_OF_BIRTH          1959 2
CUST_YEAR_OF_BIRTH          1966 3
CUST_YEAR_OF_BIRTH          1973 4
CUST_YEAR_OF_BIRTH          1979 5
CUST_YEAR_OF_BIRTH          1986 6

DECLARE
    cust_stack  dbms_data_mining_transform.TRANSFORM_LIST;
BEGIN
    dbms_data_mining_transform.SET_TRANSFORM (cust_stack,
        'country_id', NULL, 'country_id/10', 'country_id*10');
    dbms_data_mining_transform.STACK_BIN_NUM ('birth_yr_bins',
        cust_stack);
    dbms_data_mining_transform.SET_TRANSFORM (cust_stack,
        'custprods', 'Mouse Pad', 'value*100', 'value/100');
    dbms_data_mining_transform.XFORM_STACK(
        xform_list      => cust_stack,
        data_table_name => 'cust_info',
        xform_view_name => 'cust_xform_view');
END;
/

-- Two rows of data without transformations
SELECT * from cust_info WHERE cust_id BETWEEN 100010 AND 100011;

CUST_ID COUNTRY_ID CUST_YEAR_OF_BIRTH CUSTPRODS(ATTRIBUTE_NAME, VALUE)
-----
100010      52790          1975 DM_NESTED_NUMERICALS(
                                DM_NESTED_NUMERICAL(
                                    '18" Flat Panel Graphics Monitor', 1),
                                DM_NESTED_NUMERICAL(
                                    'SIMM- 16MB PCMCIAII card', 1))
100011      52775          1972 DM_NESTED_NUMERICALS(
                                DM_NESTED_NUMERICAL(
                                    'External 8X CD-ROM', 1),
                                DM_NESTED_NUMERICAL(
                                    'Mouse Pad', 1),
                                DM_NESTED_NUMERICAL(
                                    'SIMM- 16MB PCMCIAII card', 1),
                                DM_NESTED_NUMERICAL(
                                    'Keyboard Wrist Rest', 1),
                                DM_NESTED_NUMERICAL(
                                    '18" Flat Panel Graphics Monitor', 1),
                                DM_NESTED_NUMERICAL(
                                    'O/S Documentation Set - English', 1))

-- Same two rows of data with transformations
SELECT * FROM cust_xform_view WHERE cust_id BETWEEN 100010 AND 100011;

CUST_ID COUNTRY_ID C CUSTPRODS(ATTRIBUTE_NAME, VALUE)
-----
100010      5279      5 DM_NESTED_NUMERICALS(
                                DM_NESTED_NUMERICAL(
                                    '18" Flat Panel Graphics Monitor', 1),
                                DM_NESTED_NUMERICAL(

```

```

100011      5277.5      4  DM_NESTED_NUMERICALS(
                                'SIMM- 16MB PCMCIAII card', 1))
                                DM_NESTED_NUMERICAL(
                                'External 8X CD-ROM', 1),
                                DM_NESTED_NUMERICAL(
                                'Mouse Pad', 100),
                                DM_NESTED_NUMERICAL(
                                'SIMM- 16MB PCMCIAII card', 1),
                                DM_NESTED_NUMERICAL(
                                'Keyboard Wrist Rest', 1),
                                DM_NESTED_NUMERICAL(
                                '18" Flat Panel Graphics Monitor', 1),
                                DM_NESTED_NUMERICAL(
                                'O/S Documentation Set - English', 1))

```

## 36.3 DBMS\_PREDICTIVE\_ANALYTICS

Data mining can discover useful information buried in vast amounts of data. However, it is often the case that both the programming interfaces and the data mining expertise required to obtain these results are too complex for use by the wide audiences that can obtain benefits from using Oracle Data Mining.

The `DBMS_PREDICTIVE_ANALYTICS` package addresses both of these complexities by automating the entire data mining process from data preprocessing through model building to scoring new data. This package provides an important tool that makes data mining possible for a broad audience of users, in particular, business analysts.

This chapter contains the following topics:

- [Overview](#)
- [Security Model](#)
- [Summary of DBMS\\_PREDICTIVE\\_ANALYTICS Subprograms](#)

### 36.3.1 Using DBMS\_PREDICTIVE\_ANALYTICS

This section contains topics that relate to using the `DBMS_PREDICTIVE_ANALYTICS` package.

- [Overview](#)
- [Security Model](#)

#### 36.3.1.1 DBMS\_PREDICTIVE\_ANALYTICS Overview

`DBMS_PREDICTIVE_ANALYTICS` automates parts of the data mining process.

Data mining, according to a commonly used process model, requires the following steps:

1. Understand the business problem.
2. Understand the data.
3. Prepare the data for mining.
4. Create models using the prepared data.
5. Evaluate the models.
6. Deploy and use the model to score new data.

`DBMS_PREDICTIVE_ANALYTICS` automates parts of step 3 — 5 of this process.

Predictive analytics procedures analyze and prepare the input data, create and test mining models using the input data, and then use the input data for scoring. The results of scoring are returned to the user. The models and supporting objects are not preserved after the operation completes.

### 36.3.1.2 DBMS\_PREDICTIVE\_ANALYTICS Security Model

The `DBMS_PREDICTIVE_ANALYTICS` package is owned by user `SYS` and is installed as part of database installation. Execution privilege on the package is granted to `public`. The routines in the package are run with invokers' rights (run with the privileges of the current user).

The `DBMS_PREDICTIVE_ANALYTICS` package exposes APIs which are leveraged by the Oracle Data Mining option. Users who wish to invoke procedures in this package require the `CREATE MINING MODEL` system privilege (as well as the `CREATE TABLE` and `CREATE VIEW` system privilege).

## 36.3.2 Summary of DBMS\_PREDICTIVE\_ANALYTICS Subprograms

This table lists and briefly describes the `DBMS_PREDICTIVE_ANALYTICS` package subprograms.

**Table 36-164 DBMS\_PREDICTIVE\_ANALYTICS Package Subprograms**

Subprogram	Purpose
<a href="#">EXPLAIN Procedure</a>	Ranks attributes in order of influence in explaining a target column.
<a href="#">PREDICT Procedure</a>	Predicts the value of a target column based on values in the input data.
<a href="#">PROFILE Procedure</a>	Generates rules that identify the records that have the same target value.

### 36.3.2.1 EXPLAIN Procedure

The `EXPLAIN` procedure identifies the attributes that are important in explaining the variation in values of a target column.

The input data must contain some records where the target value is known (not `NULL`). These records are used by the procedure to train a model that calculates the attribute importance.

#### Note:

`EXPLAIN` supports `DATE` and `TIMESTAMP` datatypes in addition to the numeric, character, and nested datatypes supported by Oracle Data Mining models.

Data requirements for Oracle Data Mining are described in *Oracle Data Mining User's Guide*.

The `EXPLAIN` procedure creates a result table that lists the attributes in order of their explanatory power. The result table is described in the Usage Notes.

#### Syntax

```
DBMS_PREDICTIVE_ANALYTICS.EXPLAIN (
  data_table_name      IN VARCHAR2,
  explain_column_name  IN VARCHAR2,
```

```

result_table_name IN VARCHAR2,
data_schema_name IN VARCHAR2 DEFAULT NULL);

```

## Parameters

**Table 36-165 EXPLAIN Procedure Parameters**

Parameter	Description
data_table_name	Name of input table or view
explain_column_name	Name of the column to be explained
result_table_name	Name of the table where results are saved
data_schema_name	Name of the schema where the input table or view resides and where the result table is created. Default: the current schema.

## Usage Notes

The `EXPLAIN` procedure creates a result table with the columns described in [Table 36-166](#).

**Table 36-166 EXPLAIN Procedure Result Table**

Column Name	Datatype	Description
ATTRIBUTE_NAME	VARCHAR2 (30)	Name of a column in the input data; all columns except the explained column are listed in the result table.
EXPLANATORY_VALUE	NUMBER	Value indicating how useful the column is for determining the value of the explained column. Higher values indicate greater explanatory power. Value can range from 0 to 1.  An individual column's explanatory value is independent of other columns in the input table. The values are based on how strong each individual column correlates with the explained column. The value is affected by the number of records in the input table, and the relations of the values of the column to the values of the explain column.  An explanatory power value of 0 implies there is no useful correlation between the column's values and the explain column's values. An explanatory power of 1 implies perfect correlation; such columns should be eliminated from consideration for <code>PREDICT</code> . In practice, an explanatory power equal to 1 is rarely returned.
RANK	NUMBER	Ranking of explanatory power. Rows with equal values for <code>explanatory_value</code> have the same rank. Rank values are not skipped in the event of ties.

## Example

The following example performs an `EXPLAIN` operation on the `SUPPLEMENTARY_DEMOGRAPHICS` table of Sales History.

```

--Perform EXPLAIN operation
BEGIN
  DBMS_PREDICTIVE_ANALYTICS.EXPLAIN(
    data_table_name      => 'supplementary_demographics',
    explain_column_name => 'home_theater_package',
    result_table_name   => 'demographics_explain_result');
END;
/
--Display results
SELECT * FROM demographics_explain_result;

```

ATTRIBUTE_NAME	EXPLANATORY_VALUE	RANK
Y_BOX_GAMES	.524311073	1
YRS_RESIDENCE	.495987246	2
HOUSEHOLD_SIZE	.146208506	3
AFFINITY_CARD	.0598227	4
EDUCATION	.018462703	5
OCCUPATION	.009721543	6
FLAT_PANEL_MONITOR	.00013733	7
PRINTER_SUPPLIES	0	8
OS_DOC_SET_KANJI	0	8
BULK_PACK_DISKETTES	0	8
BOOKKEEPING_APPLICATION	0	8
COMMENTS	0	8
CUST_ID	0	8

The results show that Y\_BOX\_GAMES, YRS\_RESIDENCE, and HOUSEHOLD\_SIZE are the best predictors of HOME\_THEATER\_PACKAGE.

### 36.3.2.2 PREDICT Procedure

The PREDICT procedure predicts the values of a target column.

The input data must contain some records where the target value is known (not NULL). These records are used by the procedure to train and test a model that makes the predictions.

#### Note:

PREDICT supports DATE and TIMESTAMP datatypes in addition to the numeric, character, and nested datatypes supported by Oracle Data Mining models.

Data requirements for Oracle Data Mining are described in *Oracle Data Mining User's Guide*.

The PREDICT procedure creates a result table that contains a predicted target value for every record. The result table is described in the Usage Notes.

#### Syntax

```
DBMS_PREDICTIVE_ANALYTICS.PREDICT (
  accuracy                OUT NUMBER,
  data_table_name         IN VARCHAR2,
  case_id_column_name     IN VARCHAR2,
  target_column_name      IN VARCHAR2,
  result_table_name       IN VARCHAR2,
  data_schema_name        IN VARCHAR2 DEFAULT NULL);
```

## Parameters

**Table 36-167 PREDICT Procedure Parameters**

Parameter	Description
accuracy	Output parameter that returns the predictive confidence, a measure of the accuracy of the predicted values. The predictive confidence for a categorical target is the most common target value; the predictive confidence for a numerical target is the mean.
data_table_name	Name of the input table or view.
case_id_column_name	Name of the column that uniquely identifies each case (record) in the input data.
target_column_name	Name of the column to predict.
result_table_name	Name of the table where results will be saved.
data_schema_name	Name of the schema where the input table or view resides and where the result table is created. Default: the current schema.

## Usage Notes

The `PREDICT` procedure creates a result table with the columns described in [Table 36-168](#).

**Table 36-168 PREDICT Procedure Result Table**

Column Name	Datatype	Description
Case ID column name	VARCHAR2 or NUMBER	The name of the case ID column in the input data.
PREDICTION	VARCHAR2 or NUMBER	The predicted value of the target column for the given case.
PROBABILITY	NUMBER	For classification (categorical target), the probability of the prediction. For regression problems (numerical target), this column contains <code>NULL</code> .

**Note:**

Make sure that the name of the case ID column is not 'PREDICTION' or 'PROBABILITY'.

Predictions are returned for all cases whether or not they contained target values in the input.

Predicted values for known cases may be interesting in some situations. For example, you could perform deviation analysis to compare predicted values and actual values.

## Example

The following example performs a `PREDICT` operation and displays the first 10 predictions. The results show an accuracy of 79% in predicting whether each customer has an affinity card.

```
--Perform PREDICT operation
DECLARE
    v_accuracy NUMBER(10,9);
BEGIN
```

```

DBMS_PREDICTIVE_ANALYTICS.PREDICT (
  accuracy          => v_accuracy,
  data_table_name   => 'supplementary_demographics',
  case_id_column_name => 'cust_id',
  target_column_name => 'affinity_card',
  result_table_name => 'pa_demographics_predict_result');
DBMS_OUTPUT.PUT_LINE('Accuracy = ' || v_accuracy);
END;
/

```

Accuracy = .788696903

--Display results

```
SELECT * FROM pa_demographics_predict_result WHERE rownum < 10;
```

CUST_ID	PREDICTION	PROBABILITY
101501	1	.834069848
101502	0	.991269965
101503	0	.99978311
101504	1	.971643388
101505	1	.541754127
101506	0	.803719133
101507	0	.999999303
101508	0	.999999987
101509	0	.999953074

### 36.3.2.3 PROFILE Procedure

The `PROFILE` procedure generates rules that describe the cases (records) from the input data.

For example, if a target column `CHURN` has values 'Yes' and 'No', `PROFILE` generates a set of rules describing the expected outcomes. Each profile includes a rule, record count, and a score distribution.

The input data must contain some cases where the target value is known (not `NULL`). These cases are used by the procedure to build a model that calculates the rules.

#### Note:

`PROFILE` does not support nested types or dates.

Data requirements for Oracle Data Mining are described in *Oracle Data Mining User's Guide*.

The `PROFILE` procedure creates a result table that specifies rules (profiles) and their corresponding target values. The result table is described in the Usage Notes.

#### Syntax

```

DBMS_PREDICTIVE_ANALYTICS.PROFILE (
  data_table_name      IN VARCHAR2,
  target_column_name   IN VARCHAR2,
  result_table_name    IN VARCHAR2,
  data_schema_name     IN VARCHAR2 DEFAULT NULL);

```



## Parameters

**Table 36-169** PROFILE Procedure Parameters

Parameter	Description
data_table_name	Name of the table containing the data to be analyzed.
target_column_name	Name of the target column.
result_table_name	Name of the table where the results will be saved.
data_schema_name	Name of the schema where the input table or view resides and where the result table is created. Default: the current schema.

## Usage Notes

The PROFILE procedure creates a result table with the columns described in [Table 36-170](#).

**Table 36-170** PROFILE Procedure Result Table

Column Name	Datatype	Description
PROFILE_ID	NUMBER	A unique identifier for this profile (rule).
RECORD_COUNT	NUMBER	The number of records described by the profile.
DESCRIPTION	SYS.XMLTYPE	The profile rule. See " <a href="#">XML Schema for Profile Rules</a> ".

## XML Schema for Profile Rules

The DESCRIPTION column of the result table contains XML that conforms to the following XSD:

```
<xs:element name="SimpleRule">
  <xs:complexType>
    <xs:sequence>
      <xs:group ref="PREDICATE"/>
      <xs:element ref="ScoreDistribution" minOccurs="0" maxOccurs="unbounded"/>
    </xs:sequence>
    <xs:attribute name="id" type="xs:string" use="optional"/>
    <xs:attribute name="score" type="xs:string" use="required"/>
    <xs:attribute name="recordCount" type="NUMBER" use="optional"/>
  </xs:complexType>
</xs:element>
```

## Example

This example generates a rule describing customers who are likely to use an affinity card (target value is 1) and a set of rules describing customers who are not likely to use an affinity card (target value is 0). The rules are based on only two predictors: education and occupation.

```
SET serveroutput ON
SET trimsPOOL ON
SET pages 10000
SET long 10000
SET pagesize 10000
SET linesize 150
CREATE VIEW cust_edu_occ_view AS
    SELECT cust_id, education, occupation, affinity_card
    FROM sh.supplementary_demographics;
BEGIN
    DBMS_PREDICTIVE_ANALYTICS.PROFILE (
```

```

DATA_TABLE_NAME => 'cust_edu_occ_view',
TARGET_COLUMN_NAME => 'affinity_card',
RESULT_TABLE_NAME => 'profile_result');
END;
/

```

This example generates eight rules in the result table `profile_result`. Seven of the rules suggest a target value of 0; one rule suggests a target value of 1. The `score` attribute on a rule identifies the target value.

This `SELECT` statement returns all the rules in the result table.

```

SELECT a.profile_id, a.record_count, a.description.getstringval()
FROM profile_result a;

```

This `SELECT` statement returns the rules for a target value of 0.

```

SELECT *
FROM profile_result t
WHERE extractvalue(t.description, '/SimpleRule/@score') = 0;

```

The eight rules generated by this example are displayed as follows.

```

<SimpleRule id="1" score="0" recordCount="443">
  <CompoundPredicate booleanOperator="and">
    <SimpleSetPredicate field="OCCUPATION" booleanOperator="isIn">
      <Array type="string">"Armed-F" "Exec." "Prof." "Protec."
    </Array>
    </SimpleSetPredicate>
    <SimpleSetPredicate field="EDUCATION" booleanOperator="isIn">
      <Array type="string">"< Bach." "Assoc-V" "HS-grad"
    </Array>
    </SimpleSetPredicate>
  </CompoundPredicate>
  <ScoreDistribution value="0" recordCount="297" />
  <ScoreDistribution value="1" recordCount="146" />
</SimpleRule>

<SimpleRule id="2" score="0" recordCount="18">
  <CompoundPredicate booleanOperator="and">
    <SimpleSetPredicate field="OCCUPATION" booleanOperator="isIn">
      <Array type="string">"Armed-F" "Exec." "Prof." "Protec."
    </Array>
    </SimpleSetPredicate>
    <SimpleSetPredicate field="EDUCATION" booleanOperator="isIn">
      <Array type="string">"10th" "11th" "12th" "1st-4th" "5th-6th" "7th-8th" "9th" "Presch."
    </Array>
    </SimpleSetPredicate>
  </CompoundPredicate>
  <ScoreDistribution value="0" recordCount="18" />
</SimpleRule>

<SimpleRule id="3" score="0" recordCount="458">
  <CompoundPredicate booleanOperator="and">
    <SimpleSetPredicate field="OCCUPATION" booleanOperator="isIn">
      <Array type="string">"Armed-F" "Exec." "Prof." "Protec."
    </Array>
    </SimpleSetPredicate>
    <SimpleSetPredicate field="EDUCATION" booleanOperator="isIn">
      <Array type="string">"Assoc-A" "Bach."
    </Array>
    </SimpleSetPredicate>
  </CompoundPredicate>

```

```
</CompoundPredicate>
<ScoreDistribution value="0" recordCount="248" />
<ScoreDistribution value="1" recordCount="210" />
</SimpleRule>

<SimpleRule id="4" score="1" recordCount="276">
  <CompoundPredicate booleanOperator="and">
    <SimpleSetPredicate field="OCCUPATION" booleanOperator="isIn">
      <Array type="string">"Armed-F" "Exec." "Prof." "Protec."
      </Array>
    </SimpleSetPredicate>
    <SimpleSetPredicate field="EDUCATION" booleanOperator="isIn">
      <Array type="string">"Masters" "PhD" "Profsc"
      </Array>
    </SimpleSetPredicate>
  </CompoundPredicate>
  <ScoreDistribution value="1" recordCount="183" />
  <ScoreDistribution value="0" recordCount="93" />
</SimpleRule>

<SimpleRule id="5" score="0" recordCount="307">
  <CompoundPredicate booleanOperator="and">
    <SimpleSetPredicate field="EDUCATION" booleanOperator="isIn">
      <Array type="string">"Assoc-A" "Bach." "Masters" "PhD" "Profsc"
      </Array>
    </SimpleSetPredicate>
    <SimpleSetPredicate field="OCCUPATION" booleanOperator="isIn">
      <Array type="string">"Crafts" "Sales" "TechSup" "Transp."
      </Array>
    </SimpleSetPredicate>
  </CompoundPredicate>
  <ScoreDistribution value="0" recordCount="184" />
  <ScoreDistribution value="1" recordCount="123" />
</SimpleRule>

<SimpleRule id="6" score="0" recordCount="243">
  <CompoundPredicate booleanOperator="and">
    <SimpleSetPredicate field="EDUCATION" booleanOperator="isIn">
      <Array type="string">"Assoc-A" "Bach." "Masters" "PhD" "Profsc"
      </Array>
    </SimpleSetPredicate>
    <SimpleSetPredicate field="OCCUPATION" booleanOperator="isIn">
      <Array type="string">"?" "Cleric." "Farming" "Handler" "House-s" "Machine" "Other"
      </Array>
    </SimpleSetPredicate>
  </CompoundPredicate>
  <ScoreDistribution value="0" recordCount="197" />
  <ScoreDistribution value="1" recordCount="46" />
</SimpleRule>

<SimpleRule id="7" score="0" recordCount="2158">
  <CompoundPredicate booleanOperator="and">
    <SimpleSetPredicate field="EDUCATION" booleanOperator="isIn">
      <Array type="string">
        "10th" "11th" "12th" "1st-4th" "5th-6th" "7th-8th" "9th" "< Bach." "Assoc-V" "HS-grad"
        "Presch."
      </Array>
    </SimpleSetPredicate>
    <SimpleSetPredicate field="OCCUPATION" booleanOperator="isIn">
      <Array type="string">"?" "Cleric." "Crafts" "Farming" "Machine" "Sales" "TechSup" " Transp."
      </Array>
    </SimpleSetPredicate>
  </CompoundPredicate>
  <ScoreDistribution value="0" recordCount="197" />
  <ScoreDistribution value="1" recordCount="46" />
</SimpleRule>
```

```
</CompoundPredicate>
<ScoreDistribution value="0" recordCount="1819"/>
<ScoreDistribution value="1" recordCount="339"/>
</SimpleRule>

<SimpleRule id="8" score="0" recordCount="597">
  <CompoundPredicate booleanOperator="and">
    <SimpleSetPredicate field="EDUCATION" booleanOperator="isIn">
      <Array type="string">
        "10th" "11th" "12th" "1st-4th" "5th-6th" "7th-8th" "9th" "< Bach." "Assoc-v" "HS-grad"
        "Presch."
      </Array>
    </SimpleSetPredicate>
    <SimpleSetPredicate field="OCCUPATION" booleanOperator="isIn">
      <Array type="string">"Handler" "House-s" "Other"
    </Array>
    </SimpleSetPredicate>
  </CompoundPredicate>
  <ScoreDistribution value="0" recordCount="572"/>
  <ScoreDistribution value="1" recordCount="25"/>
</SimpleRule>
```

# 37

## Data Dictionary Views

The information in the data dictionary tables can be viewed through data dictionary views. The data mining related dictionary views are listed in this chapter.

- [ALL\\_MINING\\_MODELS](#)
- [ALL\\_MINING\\_MODEL\\_ATTRIBUTES](#)
- [ALL\\_MINING\\_MODEL\\_PARTITIONS](#)
- [ALL\\_MINING\\_MODEL\\_SETTINGS](#)
- [ALL\\_MINING\\_MODEL\\_VIEWS](#)
- [ALL\\_MINING\\_MODEL\\_XFORMS](#)

### 37.1 ALL\_MINING\_MODELS

`ALL_MINING_MODELS` describes the mining models accessible to the current user.

Mining models are schema objects created by Oracle Data Mining.

#### Related Views

- `DBA_MINING_MODELS` describes all mining models in the database.
- `USER_MINING_MODELS` describes the mining models owned by the current user. This view does not display the `OWNER` column.

Column	Datatype	NULL	Description
OWNER	VARCHAR2 (128)	NOT NULL	Owner of the mining model
MODEL_NAME	VARCHAR2 (128)	NOT NULL	Name of the mining model
MINING_FUNCTION	VARCHAR2 (30)	NOT NULL	Function of the mining model. The function identifies the class of problems that can be solved by this model. The mining function is specified when the model is built: <ul style="list-style-type: none"><li>• CLASSIFICATION</li><li>• REGRESSION</li><li>• CLUSTERING</li><li>• FEATURE_EXTRACTION</li><li>• ASSOCIATION_RULES</li><li>• ATTRIBUTE_IMPORTANCE</li></ul>

Column	Datatype	NULL	Description
ALGORITHM	VARCHAR2 (30)	NOT NULL	<p>Algorithm used by the model. Each mining function has a default algorithm. The default can be overridden with a model setting (see * _MINING_MODEL_SETTINGS):</p> <ul style="list-style-type: none"> <li>• CUR_DECOMPOSITION</li> <li>• NAIVE_BAYES</li> <li>• DECISION_TREE</li> <li>• EXPLICIT_SEMANTIC_ANALYS</li> <li>• EXPONENTIAL_SMOOTHING</li> <li>• SUPPORT_VECTOR_MACHINES</li> <li>• KMEANS</li> <li>• O_CLUSTER</li> <li>• NONNEGATIVE_MATRIX_FACTOR</li> <li>• NEURAL_NETWORK</li> <li>• GENERALIZED_LINEAR_MODEL</li> <li>• APRIORI_ASSOCIATION_RULES</li> <li>• MINIMUM_DESCRIPTION_LENGTH</li> <li>• EXPECTATION_MAXIMIZATION</li> <li>• RANDOM_FOREST</li> <li>• SINGULAR_VALUE_DECOMP</li> <li>• R_EXTENSIBLE</li> </ul>
ALGORITHM_TYPE	VARCHAR2 (10)	NOT NULL	Algorithm type of the model
CREATION_DATE	DATE	NOT NULL	Date that the model was created
BUILD_DURATION	NUMBER	NOT NULL	Time (in seconds) of the model build process
MODEL_SIZE	NUMBER	NOT NULL	Size of the model (in megabytes)
PARTITIONED	VARCHAR2 (3)	NOT NULL	<p>Indicates whether the model is partitioned or not. Possible values:</p> <ul style="list-style-type: none"> <li>• YES: The model is partitioned.</li> <li>• NO: The model is not partitioned</li> </ul>
COMMENTS	VARCHAR2 (4000)	NOT NULL	Comment applied to the model with a SQL COMMENT statement

### Related Topics

- [DBA\\_MINING\\_MODEL](#)
- [USER\\_MINING\\_MODELS](#)



#### See Also:

- [Oracle Data Mining User's Guide](#) for information about mining model schema objects
- [Oracle Data Mining Concepts](#) for an introduction to Data Mining

## 37.2 ALL\_MINING\_MODEL\_ATTRIBUTES

ALL\_MINING\_MODEL\_ATTRIBUTES describes the attributes of the mining models accessible to the current user. Only the attributes in the model signature are included in this view. The attributes

in the model signature correspond to the columns in the training data that were used to build the model.

Mining models are schema objects created by Oracle Data Mining.

### Related Views

- `DBA_MINING_MODEL_ATTRIBUTES` describes the attributes of all mining models in the database.
- `USER_MINING_MODEL_ATTRIBUTES` describes the attributes of the mining models owned by the current user. This view does not display the `OWNER` column.

Column	Datatype	NULL	Description
<code>OWNER</code>	<code>VARCHAR2 (128)</code>	NOT NULL	Owner of the mining model
<code>MODEL_NAME</code>	<code>VARCHAR2 (128)</code>	NOT NULL	Name of the mining model
<code>ATTRIBUTE_NAME</code>	<code>VARCHAR2 (128)</code>	NOT NULL	Name of the attribute
<code>ATTRIBUTE_TYPE</code>	<code>VARCHAR2 (11)</code>	–	Logical type of the attribute. The type is identified during the model build or apply process: <ul style="list-style-type: none"> <li>• <b>NUMERICAL:</b> Numeric data</li> <li>• <b>CATEGORICAL:</b> Character data</li> <li>• <b>TEXT:</b> Unstructured text data</li> <li>• <b>PARTITION:</b> The input signature column is used for the partitioning key</li> <li>• <b>MIXED:</b> The input signature column takes on more than one attribute type.</li> </ul> This is due to user-defined embedded transformations that allow an input column to be transformed into multiple independent mining attributes, including mining attributes of different types.
<code>DATA_TYPE</code>	<code>VARCHAR2 (106)</code>	–	Data type of the attribute
<code>DATA_LENGTH</code>	<code>NUMBER</code>	–	Length of the data type
<code>DATA_PRECISION</code>	<code>NUMBER</code>	–	Precision of a fixed point number. Precision, which is the total number of significant decimal digits, is represented as <i>p</i> in the data type <code>NUMBER (p, s)</code> .
<code>DATA_SCALE</code>	<code>NUMBER</code>	–	Scale of a fixed point number. Scale, which is the number of digits from the decimal to the least significant digit, is represented as <i>s</i> in the data type <code>NUMBER (p, s)</code> .
<code>USAGE_TYPE</code>	<code>VARCHAR2 (8)</code>	–	Indicates whether the attribute was used to construct the model ( <code>ACTIVE</code> ) or not ( <code>INACTIVE</code> ). Some attributes may be eliminated by transformations or algorithmic processing. The <code>*_MINING_MODEL_ATTRIBUTES</code> view only lists the attributes used by the model, therefore the value of this column is always <code>ACTIVE</code> .
<code>TARGET</code>	<code>VARCHAR2 (3)</code>	–	Indicates whether the attribute is the target of a predictive model ( <code>YES</code> ) or not ( <code>NO</code> ). The target describes the result that is produced when the model is applied.

Column	Datatype	NULL	Description
ATTRIBUTE_SPEC	VARCHAR2 (4000)	–	<p>One or more keywords that identify special treatment for the attribute during model build. Values are:</p> <ul style="list-style-type: none"> <li><b>FORCE_IN:</b> (GLM only) When feature selection is enabled, forces the inclusion of the attribute in the model build. Feature selection is disabled by default. If the model is not using GLM with feature selection enabled, this value is ignored.</li> <li><b>NOPREP:</b> When ADP is on, prevents automatic transformation of the attribute. If ADP is OFF, this value is ignored.</li> <li><b>TEXT:</b> Causes the attribute to be treated as unstructured text data. The TEXT value supports three subsettings: POLICY_NAME, MAX_FEATURES, TOKEN_TYPE, and MIN_DOCUMENTS. Subsettings are specified as name:value pairs within parentheses. For example: (POLICY_NAME:mypolicy) (MAX_FEATURES:2000) (TOKEN_TYPE:THEME). See <i>Oracle Data Mining User's Guide</i> for details.</li> <li><b>NULL:</b> The ATTRIBUTE_SPEC for this attribute is NULL.</li> </ul> <p>ATTRIBUTE_SPEC is a parameter to the PL/SQL procedure DBMS_DATA_MINING_TRANSFORM.SET_TRANSFORM. See <i>Oracle Database PL/SQL Packages and Types Reference</i> for details.</p>

#### Related Topics

- [DBA\\_MINING\\_MODEL\\_ATTRIBUTES](#)
- [USER\\_MINING\\_MODEL\\_ATTRIBUTES](#)



#### See Also:

*Oracle Data Mining User's Guide*

## 37.3 ALL\_MINING\_MODEL\_PARTITIONS

ALL\_MINING\_MODEL\_PARTITIONS describes all the model partitions accessible to the user.

#### Related Views

- [DBA\\_MINING\\_MODEL\\_PARTITIONS](#) describes all the model partitions accessible to the system.
- [USER\\_MINING\\_MODEL\\_PARTITIONS](#) describes the user's own model partitions. This view does not display the OWNER column.

Column	Datatype	NULL	Description
OWNER	VARCHAR2 (128)	NOT NULL	Name of the model owner
MODEL_NAME	VARCHAR2 (128)	NOT NULL	Name of the model



Column	Datatype	NULL	Description
PARTITION_NAME	VARCHAR2 (128)	–	Name of the model partition
POSITION	NUMBER	–	Column position number for partitioning column. Column position represents the position of the column in a multi-column partitioning key, or 1 for a unary column partitioning key.
COLUMN_NAME	VARCHAR2 (128)	NOT NULL	Name of the column used for partitioning
COLUMN_VALUE	VARCHAR2 (4000)	–	Value of the column for this partition

#### Related Topics

- *DBA\_MINING\_MODEL\_PARTITIONS*
- *USER\_MINING\_MODEL\_PARTITIONS*

## 37.4 ALL\_MINING\_MODEL\_SETTINGS

ALL\_MINING\_MODEL\_SETTINGS describes the settings of the mining models accessible to the current user.

Mining models are schema objects created by Oracle Data Mining.

#### Related Views

- *DBA\_MINING\_MODEL\_SETTINGS* describes the settings of all mining models in the database.
- *USER\_MINING\_MODEL\_SETTINGS* describes the settings of the mining models owned by the current user. This view does not display the OWNER column.

Column	Datatype	NULL	Description
OWNER	VARCHAR2 (128)	NOT NULL	Owner of the mining model
MODEL_NAME	VARCHAR2 (128)	NOT NULL	Name of the mining model
SETTING_NAME	VARCHAR2 (30)	NOT NULL	Name of the setting
SETTING_VALUE	VARCHAR2 (4000)	–	Value of the setting
SETTING_TYPE	VARCHAR2 (7)	–	Indicates whether the default value (DEFAULT) or a user-specified value (INPUT) is used by the model

#### Related Topics

- *DBA\_MINING\_MODEL\_SETTINGS*
- *USER\_MINING\_MODEL\_SETTINGS*

#### See Also:

Oracle Database PL/SQL Packages and Types Reference for descriptions of model settings

## 37.5 ALL\_MINING\_MODEL\_VIEWS

ALL\_MINING\_MODEL\_VIEWS provides a description of all the model views accessible to the user.

### Related Views

- DBA\_MINING\_MODEL\_VIEWS provides a description of all the model views in the database.
- USER\_MINING\_MODEL\_VIEWS provides a description of the user's own model views. This view does not display the OWNER column.

Column	Datatype	NULL	Description
OWNER	VARCHAR2 (128)	NOT NULL	Owner of the model view
MODEL_NAME	VARCHAR2 (128)	NOT NULL	Name of the model to which model views belongs
VIEW_NAME	VARCHAR2 (128)	NOT NULL	Name of the model view
VIEW_TYPE	VARCHAR2 (128)	–	Type of the model view

### Related Topics

- [DBA\\_MINING\\_MODEL\\_VIEWS](#)
- [USER\\_MINING\\_MODEL\\_VIEWS](#)



### See Also:

"USER\_MINING\_MODEL\_VIEWS" in *Oracle Data Mining User's Guide*

## 37.6 ALL\_MINING\_MODEL\_XFORMS

ALL\_MINING\_MODEL\_XFORMS describes the user-specified transformations embedded in all models accessible to the user.

### Related Views

- DBA\_MINING\_MODEL\_XFORMS describes the user-specified transformations embedded in all models accessible in the system.
- USER\_MINING\_MODEL\_XFORMS describes the user-specified transformations embedded with the user's own models. This view does not display the OWNER column.

Column	Datatype	NULL	Description
OWNER	VARCHAR2 (128)	NOT NULL	Name of the model owner
MODEL_NAME	VARCHAR2 (128)	NOT NULL	Name of the model
ATTRIBUTE_NAME	VARCHAR2 (128)		Name of the attribute used in the transformation
ATTRIBUTE_SUBNAME	VARCHAR2 (4000)		Subname of the attribute used in the transformation
ATTRIBUTE_SPEC	VARCHAR2 (4000)		Attribute specification provided to model training
EXPRESSION	CLOB		Transformation expression provided to model training

Column	Datatype	NULL	Description
REVERSE	VARCHAR2 (3)		Indicates whether the specified transformation is a reverse transformation (YES) or a forward expression (NO)

---

**Related Topics**

- [DBA\\_MINING\\_MODEL\\_XFORMS](#)
- [USER\\_MINING\\_MODEL\\_XFORMS](#)

# 38

## SQL Scoring Functions

Data Mining functions are single-row functions that use Oracle Data Mining to score data. The functions can apply a mining model schema object to the data, or they can dynamically mine the data by executing an analytic clause.

- CLUSTER\_DETAILS
- CLUSTER\_DISTANCE
- CLUSTER\_ID
- CLUSTER\_PROBABILITY
- CLUSTER\_SET
- FEATURE\_COMPARE
- FEATURE\_DETAILS
- FEATURE\_ID
- FEATURE\_SET
- FEATURE\_VALUE
- ORA\_DM\_PARTITION\_NAME
- PREDICTION
- PREDICTION\_BOUNDS
- PREDICTION\_COST
- PREDICTION\_DETAILS
- PREDICTION\_PROBABILITY
- PREDICTION\_SET

### 38.1 CLUSTER\_DETAILS

#### Syntax

**cluster\_details::=**

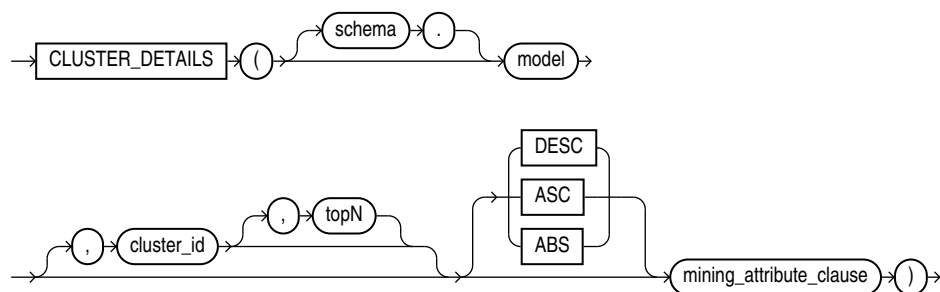

## Analytic Syntax

***cluster\_details\_analytic::=***

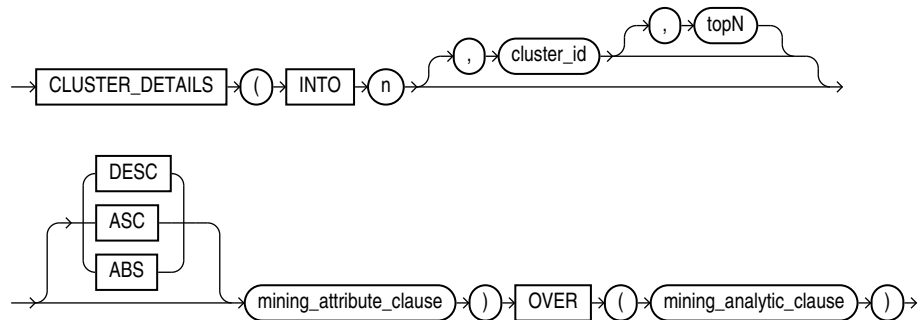

***mining\_attribute\_clause::=***

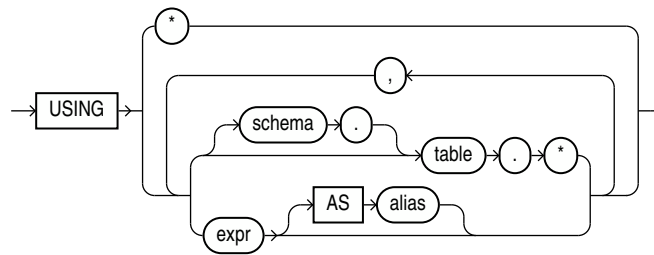

***mining\_analytic\_clause::=***

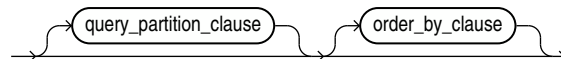

### See Also:

"Analytic Functions" for information on the syntax, semantics, and restrictions of *mining\_analytic\_clause*

## Purpose

CLUSTER\_DETAILS returns cluster details for each row in the selection. The return value is an XML string that describes the attributes of the highest probability cluster or the specified *cluster\_id*.

## topN

If you specify a value for *topN*, the function returns the *N* attributes that most influence the cluster assignment (the score). If you do not specify *topN*, the function returns the 5 most influential attributes.

## DESC, ASC, or ABS

The returned attributes are ordered by weight. The weight of an attribute expresses its positive or negative impact on cluster assignment. A positive weight indicates an increased likelihood of assignment. A negative weight indicates a decreased likelihood of assignment.

By default, `CLUSTER_DETAILS` returns the attributes with the highest positive weights (`DESC`). If you specify `ASC`, the attributes with the highest negative weights are returned. If you specify `ABS`, the attributes with the greatest weights, whether negative or positive, are returned. The results are ordered by absolute value from highest to lowest. Attributes with a zero weight are not included in the output.

## Syntax Choice

`CLUSTER_DETAILS` can score the data in one of two ways: It can apply a mining model object to the data, or it can dynamically mine the data by executing an analytic clause that builds and applies one or more transient mining models. Choose **Syntax** or **Analytic Syntax**:

- **Syntax** — Use the first syntax to score the data with a pre-defined model. Supply the name of a clustering model.
- **Analytic Syntax** — Use the analytic syntax to score the data without a pre-defined model. Include `INTO n`, where `n` is the number of clusters to compute, and `mining_analytic_clause`, which specifies if the data should be partitioned for multiple model builds. The `mining_analytic_clause` supports a `query_partition_clause` and an `order_by_clause`. (See "analytic\_clause::".)

The syntax of the `CLUSTER_DETAILS` function can use an optional `GROUPING` hint when scoring a partitioned model. See `GROUPING` Hint.

## mining\_attribute\_clause

`mining_attribute_clause` identifies the column attributes to use as predictors for scoring. When the function is invoked with the analytic syntax, these predictors are also used for building the transient models. The `mining_attribute_clause` behaves as described for the `PREDICTION` function. (See "mining\_attribute\_clause".)

### See Also:

- *Oracle Data Mining User's Guide* for information about scoring.
- *Oracle Data Mining Concepts* for information about clustering.

### Note:

The following examples are excerpted from the Data Mining sample programs. For more information about the sample programs, see Appendix A in *Oracle Data Mining User's Guide*.

## Example

This example lists the attributes that have the greatest impact (more than 20% probability) on cluster assignment for customer ID 100955. The query invokes the `CLUSTER_DETAILS` and `CLUSTER_SET` functions, which apply the clustering model `em_sh_clus_sample`.

```
SELECT S.cluster_id, probability prob,
       CLUSTER_DETAILS(em_sh_clus_sample, S.cluster_id, 5 USING T.*) det
FROM   (SELECT v.*, CLUSTER_SET(em_sh_clus_sample, NULL, 0.2 USING *) pset
       FROM mining_data_apply_v v
       WHERE cust_id = 100955) T,
       TABLE(T.pset) S
ORDER BY 2 DESC;
```

```
CLUSTER_ID  PROB DET
-----
```

```
14 .6761 <Details algorithm="Expectation Maximization" cluster="14">
        <Attribute name="AGE" actualValue="51" weight=".676" rank="1"/>
        <Attribute name="HOME_THEATER_PACKAGE" actualValue="1" weight=".557" rank="2"/>
        <Attribute name="FLAT_PANEL_MONITOR" actualValue="0" weight=".412" rank="3"/>
        <Attribute name="Y_BOX_GAMES" actualValue="0" weight=".171" rank="4"/>
        <Attribute name="BOOKKEEPING_APPLICATION" actualValue="1" weight="-.003"rank="5"/>
        </Details>
```

```
3 .3227 <Details algorithm="Expectation Maximization" cluster="3">
        <Attribute name="YRS_RESIDENCE" actualValue="3" weight=".323" rank="1"/>
        <Attribute name="BULK_PACK_DISKETTES" actualValue="1" weight=".265" rank="2"/>
        <Attribute name="EDUCATION" actualValue="HS-grad" weight=".172" rank="3"/>
        <Attribute name="AFFINITY_CARD" actualValue="0" weight=".125" rank="4"/>
        <Attribute name="OCCUPATION" actualValue="Crafts" weight=".055" rank="5"/>
        </Details>
```

## Analytic Example

This example divides the customer database into four segments based on common characteristics. The clustering functions compute the clusters and return the score without a predefined clustering model.

```
SELECT * FROM (
  SELECT cust_id,
         CLUSTER_ID(INTO 4 USING *) OVER () cls,
         CLUSTER_DETAILS(INTO 4 USING *) OVER () cls_details
  FROM mining_data_apply_v)
WHERE cust_id <= 100003
ORDER BY 1;
```

```
CUST_ID CLS CLS_DETAILS
-----
```

```
100001 5 <Details algorithm="K-Means Clustering" cluster="5">
        <Attribute name="FLAT_PANEL_MONITOR" actualValue="0" weight=".349" rank="1"/>
        <Attribute name="BULK_PACK_DISKETTES" actualValue="0" weight=".33" rank="2"/>
        <Attribute name="CUST_INCOME_LEVEL" actualValue="G: 130\,000 - 149\,999" weight=".291"
        rank="3"/>
        <Attribute name="HOME_THEATER_PACKAGE" actualValue="1" weight=".268" rank="4"/>
        <Attribute name="Y_BOX_GAMES" actualValue="0" weight=".179" rank="5"/>
        </Details>
```

```
100002 6 <Details algorithm="K-Means Clustering" cluster="6">
        <Attribute name="CUST_GENDER" actualValue="F" weight=".945" rank="1"/>
        <Attribute name="CUST_MARITAL_STATUS" actualValue="NeverM" weight=".856" rank="2"/>
```

```
<Attribute name="HOUSEHOLD_SIZE" actualValue="2" weight=".468" rank="3"/>
<Attribute name="AFFINITY_CARD" actualValue="0" weight=".012" rank="4"/>
<Attribute name="CUST_INCOME_LEVEL" actualValue="L: 300\,000 and above" weight=".009"
rank="5"/>
</Details>
```

```
100003 7 <Details algorithm="K-Means Clustering" cluster="7">
<Attribute name="CUST_MARITAL_STATUS" actualValue="NeverM" weight=".862" rank="1"/>
<Attribute name="HOUSEHOLD_SIZE" actualValue="2" weight=".423" rank="2"/>
<Attribute name="HOME_THEATER_PACKAGE" actualValue="0" weight=".113" rank="3"/>
<Attribute name="AFFINITY_CARD" actualValue="0" weight=".007" rank="4"/>
<Attribute name="CUST_ID" actualValue="100003" weight=".006" rank="5"/>
</Details>
```

## 38.2 CLUSTER\_DISTANCE

### Syntax

**cluster\_distance ::=**

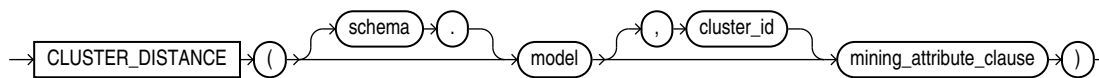

### Analytic Syntax

**cluster\_distance\_analytic ::=**

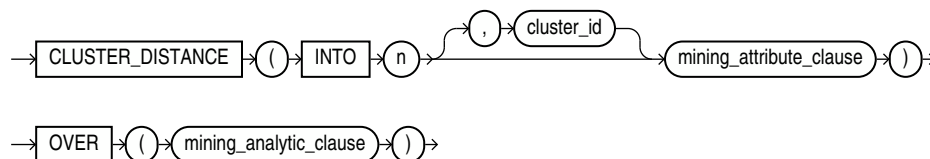

**mining\_attribute\_clause ::=**

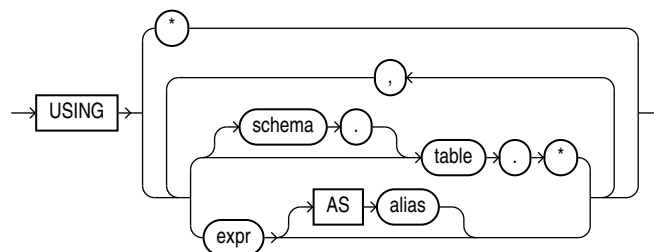

**mining\_analytic\_clause ::=**

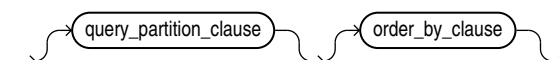



 **See Also:**

"Analytic Functions" for information on the syntax, semantics, and restrictions of *mining\_analytic\_clause*

**Purpose**

CLUSTER\_DISTANCE returns a cluster distance for each row in the selection. The cluster distance is the distance between the row and the centroid of the highest probability cluster or the specified *cluster\_id*. The distance is returned as BINARY\_DOUBLE.

**Syntax Choice**

CLUSTER\_DISTANCE can score the data in one of two ways: It can apply a mining model object to the data, or it can dynamically mine the data by executing an analytic clause that builds and applies one or more transient mining models. Choose **Syntax** or **Analytic Syntax**:

- **Syntax** — Use the first syntax to score the data with a pre-defined model. Supply the name of a clustering model.
- **Analytic Syntax** — Use the analytic syntax to score the data without a pre-defined model. Include INTO *n*, where *n* is the number of clusters to compute, and *mining\_analytic\_clause*, which specifies if the data should be partitioned for multiple model builds. The *mining\_analytic\_clause* supports a *query\_partition\_clause* and an *order\_by\_clause*. (See "analytic\_clause::".)

The syntax of the CLUSTER\_DISTANCE function can use an optional GROUPING hint when scoring a partitioned model. See GROUPING Hint.

**mining\_attribute\_clause**

*mining\_attribute\_clause* identifies the column attributes to use as predictors for scoring. When the function is invoked with the analytic syntax, this data is also used for building the transient models. The *mining\_attribute\_clause* behaves as described for the PREDICTION function. (See "mining\_attribute\_clause".)

 **See Also:**

- *Oracle Data Mining User's Guide* for information about scoring.
- *Oracle Data Mining Concepts* for information about clustering.

 **Note:**

The following example is excerpted from the Data Mining sample programs. For more information about the sample programs, see Appendix A in *Oracle Data Mining User's Guide*.

### Example

This example finds the 10 rows that are most anomalous as measured by their distance from their nearest cluster centroid.

```
SELECT cust_id
FROM (
  SELECT cust_id,
         rank() over
           (order by CLUSTER_DISTANCE(km_sh_clus_sample USING *) desc) rnk
    FROM mining_data_apply_v)
WHERE rnk <= 11
ORDER BY rnk;
```

```
CUST_ID
-----
100579
100050
100329
100962
101251
100179
100382
100713
100629
100787
101478
```

## 38.3 CLUSTER\_ID

### Syntax

**cluster\_id::=**

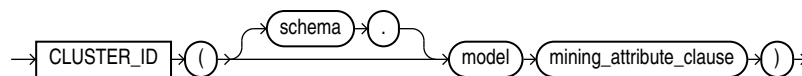

### Analytic Syntax

**cluster\_id\_analytic::=**

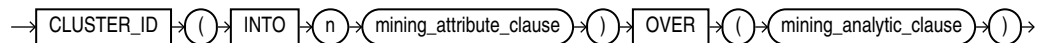

**mining\_attribute\_clause::=**

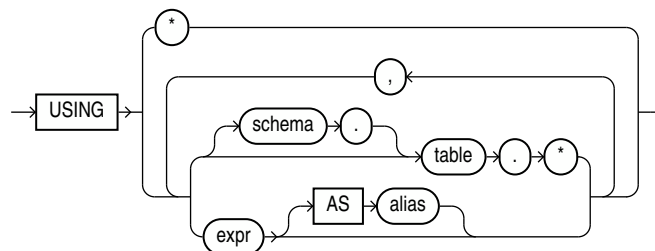

*mining\_analytic\_clause*::=

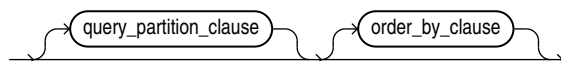

### See Also:

"Analytic Functions" for information on the syntax, semantics, and restrictions of *mining\_analytic\_clause*

### Purpose

CLUSTER\_ID returns the identifier of the highest probability cluster for each row in the selection. The cluster identifier is returned as an Oracle NUMBER.

### Syntax Choice

CLUSTER\_ID can score the data in one of two ways: It can apply a mining model object to the data, or it can dynamically mine the data by executing an analytic clause that builds and applies one or more transient mining models. Choose **Syntax** or **Analytic Syntax**:

- **Syntax** — Use the first syntax to score the data with a pre-defined model. Supply the name of a clustering model.
- **Analytic Syntax** — Use the analytic syntax to score the data without a pre-defined model. Include INTO *n*, where *n* is the number of clusters to compute, and *mining\_analytic\_clause*, which specifies if the data should be partitioned for multiple model builds. The *mining\_analytic\_clause* supports a *query\_partition\_clause* and an *order\_by\_clause*. (See "analytic\_clause::=".)

The syntax of the CLUSTER\_ID function can use an optional GROUPING hint when scoring a partitioned model. See GROUPING Hint.

### mining\_attribute\_clause

*mining\_attribute\_clause* identifies the column attributes to use as predictors for scoring. When the function is invoked with the analytic syntax, these predictors are also used for building the transient models. The *mining\_attribute\_clause* behaves as described for the PREDICTION function. (See "mining\_attribute\_clause".)

### See Also:

- *Oracle Data Mining User's Guide* for information about scoring.
- *Oracle Data Mining Concepts* for information about clustering.

 **Note:**

The following examples are excerpted from the Data Mining sample programs. For more information about the sample programs, see Appendix A in *Oracle Data Mining User's Guide*.

**Example**

The following example lists the clusters into which the customers in `mining_data_apply_v` have been grouped.

```
SELECT CLUSTER_ID(km_sh_clus_sample USING *) AS clus, COUNT(*) AS cnt
FROM mining_data_apply_v
GROUP BY CLUSTER_ID(km_sh_clus_sample USING *)
ORDER BY cnt DESC;
```

CLUS	CNT
2	580
10	216
6	186
8	115
19	110
12	101
18	81
16	39
17	38
14	34

**Analytic Example**

This example divides the customer database into four segments based on common characteristics. The clustering functions compute the clusters and return the score without a predefined clustering model.

```
SELECT * FROM (
  SELECT cust_id,
         CLUSTER_ID(INTO 4 USING *) OVER () cls,
         CLUSTER_DETAILS(INTO 4 USING *) OVER () cls_details
  FROM mining_data_apply_v)
WHERE cust_id <= 100003
ORDER BY 1;
```

```
CUST_ID CLS CLS_DETAILS
```

```
-----
100001  5 <Details algorithm="K-Means Clustering" cluster="5">
  <Attribute name="FLAT_PANEL_MONITOR" actualValue="0" weight=".349" rank="1"/>
  <Attribute name="BULK_PACK_DISKETTES" actualValue="0" weight=".33" rank="2"/>
  <Attribute name="CUST_INCOME_LEVEL" actualValue="G: 130\,000 - 149\,999"
    weight=".291" rank="3"/>
  <Attribute name="HOME_THEATER_PACKAGE" actualValue="1" weight=".268" rank="4"/>
  <Attribute name="Y_BOX_GAMES" actualValue="0" weight=".179" rank="5"/>
  </Details>

100002  6 <Details algorithm="K-Means Clustering" cluster="6">
  <Attribute name="CUST_GENDER" actualValue="F" weight=".945" rank="1"/>
  <Attribute name="CUST_MARITAL_STATUS" actualValue="NeverM" weight=".856" rank="2"/>
  <Attribute name="HOUSEHOLD_SIZE" actualValue="2" weight=".468" rank="3"/>
  <Attribute name="AFFINITY_CARD" actualValue="0" weight=".012" rank="4"/>
```

```
<Attribute name="CUST_INCOME_LEVEL" actualValue="L: 300\,000 and above"
  weight=".009" rank="5"/>
</Details>
```

```
100003 7 <Details algorithm="K-Means Clustering" cluster="7">
  <Attribute name="CUST_MARITAL_STATUS" actualValue="NeverM" weight=".862" rank="1"/>
  <Attribute name="HOUSEHOLD_SIZE" actualValue="2" weight=".423" rank="2"/>
  <Attribute name="HOME_THEATER_PACKAGE" actualValue="0" weight=".113" rank="3"/>
  <Attribute name="AFFINITY_CARD" actualValue="0" weight=".007" rank="4"/>
  <Attribute name="CUST_ID" actualValue="100003" weight=".006" rank="5"/>
</Details>
```

## 38.4 CLUSTER\_PROBABILITY

### Syntax

**cluster\_probability::=**

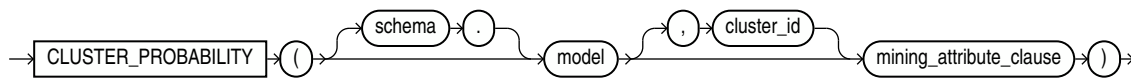

### Analytic Syntax

**cluster\_prob\_analytic::=**

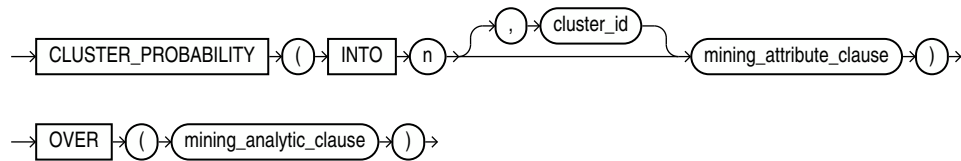

**mining\_attribute\_clause::=**

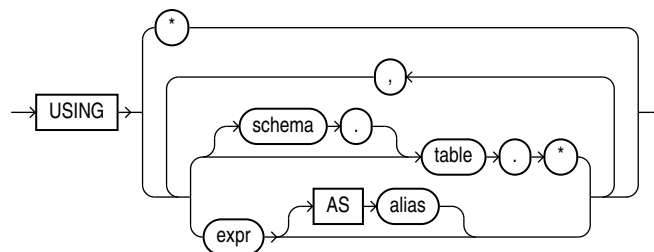

**mining\_analytic\_clause::=**

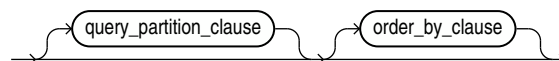

 **See Also:**

"Analytic Functions" for information on the syntax, semantics, and restrictions of *mining\_analytic\_clause*

**Purpose**

CLUSTER\_PROBABILITY returns a probability for each row in the selection. The probability refers to the highest probability cluster or to the specified *cluster\_id*. The cluster probability is returned as BINARY\_DOUBLE.

**Syntax Choice**

CLUSTER\_PROBABILITY can score the data in one of two ways: It can apply a mining model object to the data, or it can dynamically mine the data by executing an analytic clause that builds and applies one or more transient mining models. Choose **Syntax** or **Analytic Syntax**:

- **Syntax** — Use the first syntax to score the data with a pre-defined model. Supply the name of a clustering model.
- **Analytic Syntax** — Use the analytic syntax to score the data without a pre-defined model. Include INTO *n*, where *n* is the number of clusters to compute, and *mining\_analytic\_clause*, which specifies if the data should be partitioned for multiple model builds. The *mining\_analytic\_clause* supports a *query\_partition\_clause* and an *order\_by\_clause*. (See "analytic\_clause::".)

The syntax of the CLUSTER\_PROBABILITY function can use an optional GROUPING hint when scoring a partitioned model. See GROUPING Hint.

**mining\_attribute\_clause**

*mining\_attribute\_clause* identifies the column attributes to use as predictors for scoring. When the function is invoked with the analytic syntax, these predictors are also used for building the transient models. The *mining\_attribute\_clause* behaves as described for the PREDICTION function. (See "mining\_attribute\_clause".)

 **See Also:**

- *Oracle Data Mining User's Guide* for information about scoring.
- *Oracle Data Mining Concepts* for information about clustering.

 **Note:**

The following example is excerpted from the Data Mining sample programs. For more information about the sample programs, see Appendix A in *Oracle Data Mining User's Guide*.

### Example

The following example lists the ten most representative customers, based on likelihood, of cluster 2.

```
SELECT cust_id
FROM (SELECT cust_id, rank() OVER (ORDER BY prob DESC, cust_id) rnk_clus2
      FROM (SELECT cust_id, CLUSTER_PROBABILITY(km_sh_clus_sample, 2 USING *) prob
            FROM mining_data_apply_v))
WHERE rnk_clus2 <= 10
ORDER BY rnk_clus2;
```

```

CUST_ID
-----
100256
100988
100889
101086
101215
100390
100985
101026
100601
100672
```

## 38.5 CLUSTER\_SET

### Syntax

**cluster\_set::=**

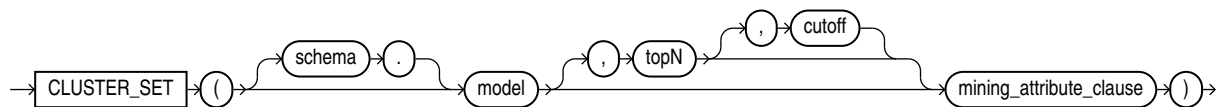

### Analytic Syntax

**cluster\_set\_analytic::=**

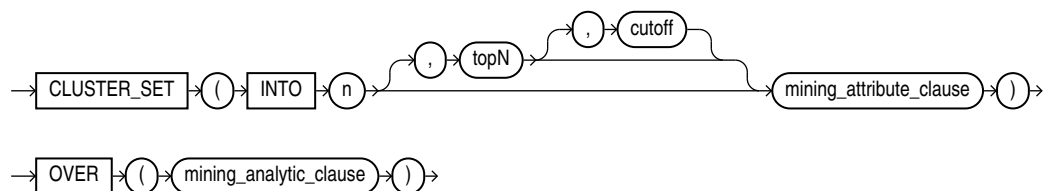

**mining\_attribute\_clause::=**

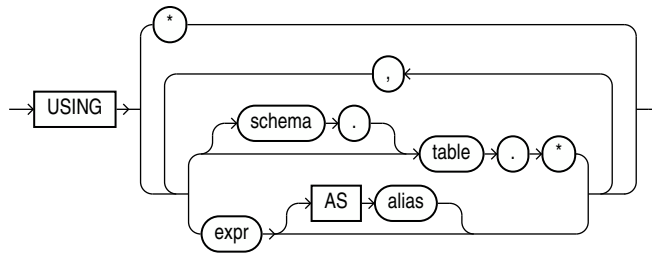

**mining\_analytic\_clause::=**

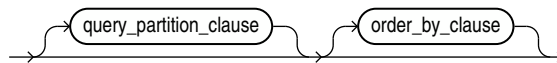

 **See Also:**

"Analytic Functions" for information on the syntax, semantics, and restrictions of *mining\_analytic\_clause*

**Purpose**

CLUSTER\_SET returns a set of cluster ID and probability pairs for each row in the selection. The return value is a varray of objects with field names CLUSTER\_ID and PROBABILITY. The cluster identifier is an Oracle NUMBER; the probability is BINARY\_DOUBLE.

**topN and cutoff**

You can specify *topN* and *cutoff* to limit the number of clusters returned by the function. By default, both *topN* and *cutoff* are null and all clusters are returned.

- *topN* is the *N* most probable clusters. If multiple clusters share the *N*th probability, then the function chooses one of them.
- *cutoff* is a probability threshold. Only clusters with probability greater than or equal to *cutoff* are returned. To filter by *cutoff* only, specify NULL for *topN*.

To return up to the *N* most probable clusters that are greater than or equal to *cutoff*, specify both *topN* and *cutoff*.

**Syntax Choice**

CLUSTER\_SET can score the data in one of two ways: It can apply a mining model object to the data, or it can dynamically mine the data by executing an analytic clause that builds and applies one or more transient mining models. Choose **Syntax** or **Analytic Syntax**:

- **Syntax** — Use the first syntax to score the data with a pre-defined model. Supply the name of a clustering model.
- **Analytic Syntax** — Use the analytic syntax to score the data without a pre-defined model. Include INTO *n*, where *n* is the number of clusters to compute, and



*mining\_analytic\_clause*, which specifies if the data should be partitioned for multiple model builds. The *mining\_analytic\_clause* supports a *query\_partition\_clause* and an *order\_by\_clause*. (See "analytic\_clause::".)

The syntax of the `CLUSTER_SET` function can use an optional `GROUPING` hint when scoring a partitioned model. See `GROUPING` Hint.

### mining\_attribute\_clause

*mining\_attribute\_clause* identifies the column attributes to use as predictors for scoring. When the function is invoked with the analytic syntax, these predictors are also used for building the transient models. The *mining\_attribute\_clause* behaves as described for the `PREDICTION` function. (See "mining\_attribute\_clause".)

#### See Also:

- *Oracle Data Mining User's Guide* for information about scoring.
- *Oracle Data Mining Concepts* for information about clustering.

#### Note:

The following example is excerpted from the Data Mining sample programs. For more information about the sample programs, see Appendix A in *Oracle Data Mining User's Guide*.

### Example

This example lists the attributes that have the greatest impact (more than 20% probability) on cluster assignment for customer ID 100955. The query invokes the `CLUSTER_DETAILS` and `CLUSTER_SET` functions, which apply the clustering model `em_sh_clus_sample`.

```
SELECT S.cluster_id, probability prob,
       CLUSTER_DETAILS(em_sh_clus_sample, S.cluster_id, 5 USING T.*) det
FROM
  (SELECT v.*, CLUSTER_SET(em_sh_clus_sample, NULL, 0.2 USING *) pset
   FROM mining_data_apply_v v
   WHERE cust_id = 100955) T,
  TABLE(T.pset) S
ORDER BY 2 DESC;
```

```
CLUSTER_ID  PROB DET
-----
14 .6761 <Details algorithm="Expectation Maximization" cluster="14">
      <Attribute name="AGE" actualValue="51" weight=".676" rank="1"/>
      <Attribute name="HOME_THEATER_PACKAGE" actualValue="1" weight=".557" rank="2"/>
      <Attribute name="FLAT_PANEL_MONITOR" actualValue="0" weight=".412" rank="3"/>
      <Attribute name="Y_BOX_GAMES" actualValue="0" weight=".171" rank="4"/>
      <Attribute name="BOOKKEEPING_APPLICATION" actualValue="1" weight="-.003"rank="5"/>
      </Details>

3 .3227 <Details algorithm="Expectation Maximization" cluster="3">
      <Attribute name="YRS_RESIDENCE" actualValue="3" weight=".323" rank="1"/>
      <Attribute name="BULK_PACK_DISKETTES" actualValue="1" weight=".265" rank="2"/>
```

```
<Attribute name="EDUCATION" actualValue="HS-grad" weight=".172" rank="3"/>
<Attribute name="AFFINITY_CARD" actualValue="0" weight=".125" rank="4"/>
<Attribute name="OCCUPATION" actualValue="Crafts" weight=".055" rank="5"/>
</Details>
```

## 38.6 FEATURE\_COMPARE

### Syntax

**feature\_compare::=**

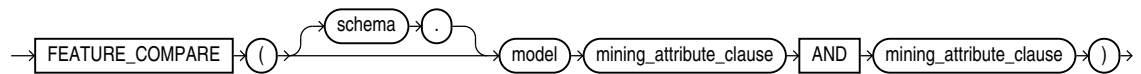

**mining\_attribute\_clause::=**

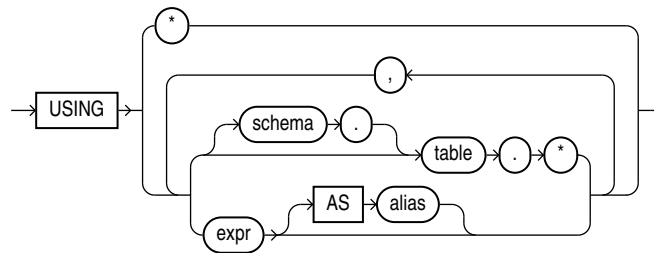

### Purpose

The `FEATURE_COMPARE` function uses a Feature Extraction model to compare two different documents, including short ones such as keyword phrases or two attribute lists, for similarity or dissimilarity. The `FEATURE_COMPARE` function can be used with Feature Extraction algorithms such as Singular Value Decomposition (SVD), Principal Component Analysis (PCA), Non-Negative Matrix Factorization (NMF), and Explicit Semantic Analysis (ESA). This function is applicable not only to documents, but also to numeric and categorical data.

The input to the `FEATURE_COMPARE` function is a single feature model built using the Feature Extraction algorithms of Oracle Data Mining, such as NMF, SVD, and ESA. The double `USING` clause provides a mechanism to compare two different documents or constant keyword phrases, or any combination of the two, for similarity or dissimilarity using the extracted features in the model.

The syntax of the `FEATURE_COMPARE` function can use an optional `GROUPING` hint when scoring a partitioned model. See `GROUPING Hint`.

### mining\_attribute\_clause

The `mining_attribute_clause` identifies the column attributes to use as predictors for scoring. When the function is invoked with the analytic syntax, these predictors are also used for building the transient models. The `mining_attribute_clause` behaves as described for the `PREDICTION` function. See `mining_attribute_clause`.

 **See Also:**

- *Oracle Data Mining User's Guide* for information about scoring
- *Oracle Data Mining Concepts* for information about clustering

 **Note:**

The following examples are excerpted from the Data Mining sample programs. For more information about the sample programs, see Appendix A in *Oracle Data Mining User's Guide*.

**Examples**

An ESA model is built against a 2005 Wiki dataset rendering over 200,000 features. The documents are mined as text and the document titles are considered as the Feature IDs.

The examples show the `FEATURE_COMPARE` function with the ESA algorithm, which compares a similar set of texts and then a dissimilar set of texts.

**Similar texts**

```
SELECT 1-FEATURE_COMPARE(esa_wiki_mod USING 'There are several PGA tour golfers from South
Africa' text AND USING 'Nick Price won the 2002 Mastercard Colonial Open' text) similarity
FROM DUAL;
```

```
SIMILARITY
-----
      .258
```

The output metric shows the results of a distance calculation. Therefore, a smaller number represents more similar texts. So 1 minus the distance in the queries represents a document similarity metric.

**Dissimilar texts**

```
SELECT 1-FEATURE_COMPARE(esa_wiki_mod USING 'There are several PGA tour golfers from South
Africa' text AND USING 'John Elway played quarterback for the Denver Broncos' text)
similarity FROM DUAL;
```

```
SIMILARITY
-----
      .007
```

## 38.7 FEATURE\_DETAILS

### Syntax

**feature\_details::=**

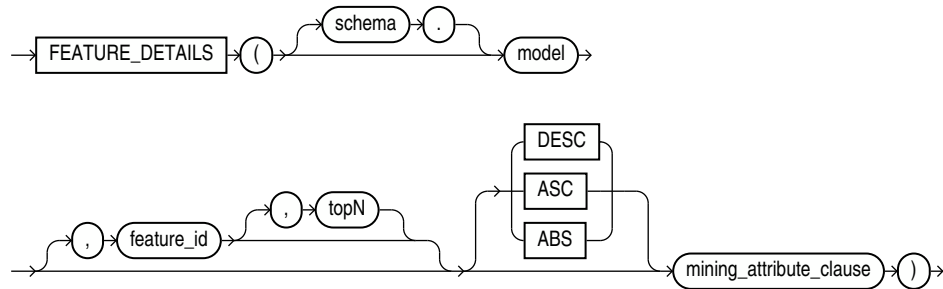

### Analytic Syntax

**feature\_details\_analytic::=**

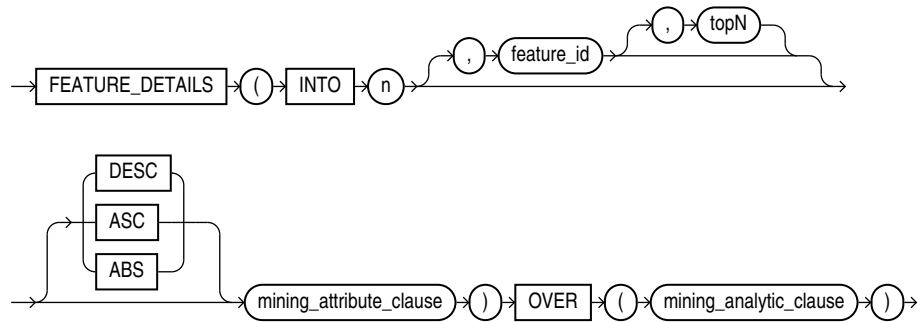

**mining\_attribute\_clause::=**

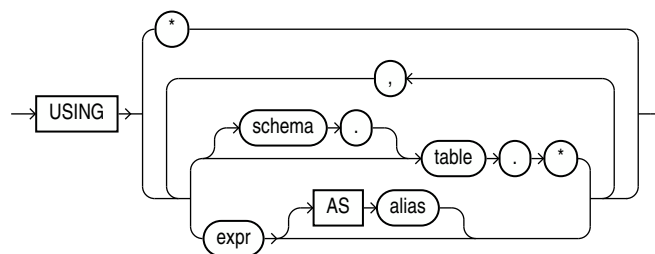

**mining\_analytic\_clause::=**

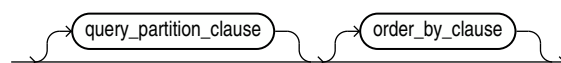

 **See Also:**

"Analytic Functions" for information on the syntax, semantics, and restrictions of *mining\_analytic\_clause*

**Purpose**

FEATURE\_DETAILS returns feature details for each row in the selection. The return value is an XML string that describes the attributes of the highest value feature or the specified *feature\_id*.

**topN**

If you specify a value for *topN*, the function returns the *N* attributes that most influence the feature value. If you do not specify *topN*, the function returns the 5 most influential attributes.

**DESC, ASC, or ABS**

The returned attributes are ordered by weight. The weight of an attribute expresses its positive or negative impact on the value of the feature. A positive weight indicates a higher feature value. A negative weight indicates a lower feature value.

By default, FEATURE\_DETAILS returns the attributes with the highest positive weight (DESC). If you specify ASC, the attributes with the highest negative weight are returned. If you specify ABS, the attributes with the greatest weight, whether negative or positive, are returned. The results are ordered by absolute value from highest to lowest. Attributes with a zero weight are not included in the output.

**Syntax Choice**

FEATURE\_DETAILS can score the data in one of two ways: It can apply a mining model object to the data, or it can dynamically mine the data by executing an analytic clause that builds and applies one or more transient mining models. Choose **Syntax** or **Analytic Syntax**:

- **Syntax** — Use the first syntax to score the data with a pre-defined model. Supply the name of a feature extraction model.
- **Analytic Syntax** — Use the analytic syntax to score the data without a pre-defined model. Include INTO *n*, where *n* is the number of features to extract, and *mining\_analytic\_clause*, which specifies if the data should be partitioned for multiple model builds. The *mining\_analytic\_clause* supports a *query\_partition\_clause* and an *order\_by\_clause*. (See "analytic\_clause::".)

The syntax of the FEATURE\_DETAILS function can use an optional GROUPING hint when scoring a partitioned model. See GROUPING Hint.

**mining\_attribute\_clause**

*mining\_attribute\_clause* identifies the column attributes to use as predictors for scoring. When the function is invoked with the analytic syntax, these predictors are also used for building the transient models. The *mining\_attribute\_clause* behaves as described for the PREDICTION function. (See "mining\_attribute\_clause".)

 **See Also:**

- *Oracle Data Mining User's Guide* for information about scoring.
- *Oracle Data Mining Concepts* for information about feature extraction.

 **Note:**

The following examples are excerpted from the Data Mining sample programs. For more information about the sample programs, see Appendix A in *Oracle Data Mining User's Guide*.

**Example**

This example uses the feature extraction model `nmf_sh_sample` to score the data. The query returns the three features that best represent customer 100002 and the attributes that most affect those features.

```
SELECT S.feature_id fid, value val,
       FEATURE_DETAILS(nmf_sh_sample, S.feature_id, 5 using T.*) det
FROM
  (SELECT v.*, FEATURE_SET(nmf_sh_sample, 3 USING *) fset
   FROM mining_data_apply_v v
   WHERE cust_id = 100002) T,
  TABLE(T.fset) S
ORDER BY 2 DESC;
```

FID	VAL	DET
5	3.492	<Details algorithm="Non-Negative Matrix Factorization" feature="5"> <Attribute name="BULK_PACK_DISKETTES" actualValue="1" weight=".077" rank="1"/> <Attribute name="OCCUPATION" actualValue="Prof." weight=".062" rank="2"/> <Attribute name="BOOKKEEPING_APPLICATION" actualValue="1" weight=".001" rank="3"/> <Attribute name="OS_DOC_SET_KANJI" actualValue="0" weight="0" rank="4"/> <Attribute name="YRS_RESIDENCE" actualValue="4" weight="0" rank="5"/> </Details>
3	1.928	<Details algorithm="Non-Negative Matrix Factorization" feature="3"> <Attribute name="HOUSEHOLD_SIZE" actualValue="2" weight=".239" rank="1"/> <Attribute name="CUST_INCOME_LEVEL" actualValue="L: 300\,000 and above" weight=".051" rank="2"/> <Attribute name="FLAT_PANEL_MONITOR" actualValue="1" weight=".02" rank="3"/> <Attribute name="HOME_THEATER_PACKAGE" actualValue="1" weight=".006" rank="4"/> <Attribute name="AGE" actualValue="41" weight=".004" rank="5"/> </Details>
8	.816	<Details algorithm="Non-Negative Matrix Factorization" feature="8"> <Attribute name="EDUCATION" actualValue="Bach." weight=".211" rank="1"/> <Attribute name="CUST_MARITAL_STATUS" actualValue="NeverM" weight=".143" rank="2"/> <Attribute name="FLAT_PANEL_MONITOR" actualValue="1" weight=".137" rank="3"/> <Attribute name="CUST_GENDER" actualValue="F" weight=".044" rank="4"/> <Attribute name="BULK_PACK_DISKETTES" actualValue="1" weight=".032" rank="5"/> </Details>

**Analytic Example**

This example dynamically maps customer attributes into six features and returns the feature mapping for customer 100001.

```
SELECT feature_id, value
FROM (
  SELECT cust_id, feature_set(INTO 6 USING *) OVER () fset
  FROM mining_data_apply_v),
TABLE (fset)
WHERE cust_id = 100001
ORDER BY feature_id;
```

FEATURE_ID	VALUE
1	2.670
2	.000
3	1.792
4	.000
5	.000
6	3.379

## 38.8 FEATURE\_ID

### Syntax

**feature\_id::=**

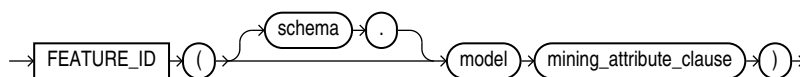

### Analytic Syntax

**feature\_id\_analytic::=**

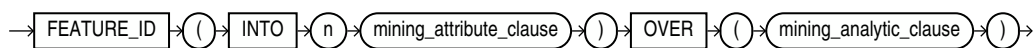

**mining\_attribute\_clause::=**

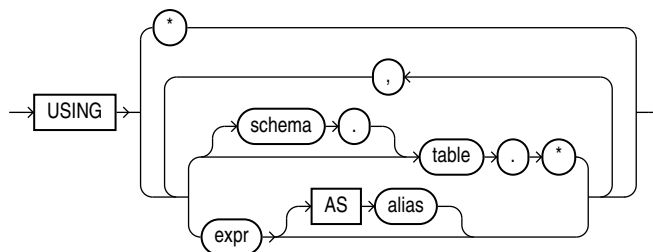

**mining\_analytic\_clause::=**

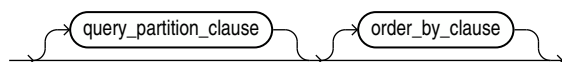

 **See Also:**

"Analytic Functions" for information on the syntax, semantics, and restrictions of *mining\_analytic\_clause*

**Purpose**

FEATURE\_ID returns the identifier of the highest value feature for each row in the selection. The feature identifier is returned as an Oracle NUMBER.

**Syntax Choice**

FEATURE\_ID can score the data in one of two ways: It can apply a mining model object to the data, or it can dynamically mine the data by executing an analytic clause that builds and applies one or more transient mining models. Choose **Syntax** or **Analytic Syntax**:

- **Syntax** — Use the first syntax to score the data with a pre-defined model. Supply the name of a feature extraction model.
- **Analytic Syntax** — Use the analytic syntax to score the data without a pre-defined model. Include INTO *n*, where *n* is the number of features to extract, and *mining\_analytic\_clause*, which specifies if the data should be partitioned for multiple model builds. The *mining\_analytic\_clause* supports a *query\_partition\_clause* and an *order\_by\_clause*. (See "analytic\_clause::".)

The syntax of the FEATURE\_ID function can use an optional GROUPING hint when scoring a partitioned model. See GROUPING Hint.

**mining\_attribute\_clause**

*mining\_attribute\_clause* identifies the column attributes to use as predictors for scoring. When the function is invoked with the analytic syntax, these predictors are also used for building the transient models. The *mining\_attribute\_clause* behaves as described for the PREDICTION function. (See "mining\_attribute\_clause".)

 **See Also:**

- *Oracle Data Mining User's Guide* for information about scoring.
- *Oracle Data Mining Concepts* for information about feature extraction.

 **Note:**

The following example is excerpted from the Data Mining sample programs. For more information about the sample programs, see Appendix A in *Oracle Data Mining User's Guide*.

**Example**

This example lists the features and corresponding count of customers in a data set.



```
SELECT FEATURE_ID(nmf_sh_sample USING *) AS feat, COUNT(*) AS cnt
FROM nmf_sh_sample_apply_prepared
GROUP BY FEATURE_ID(nmf_sh_sample USING *)
ORDER BY cnt DESC, feat DESC;
```

FEAT	CNT
7	1443
2	49
3	6
6	1
1	1

## 38.9 FEATURE\_SET

### Syntax

**feature\_set::=**

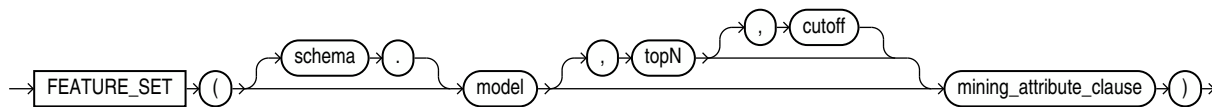

### Analytic Syntax

**feature\_set\_analytic::=**

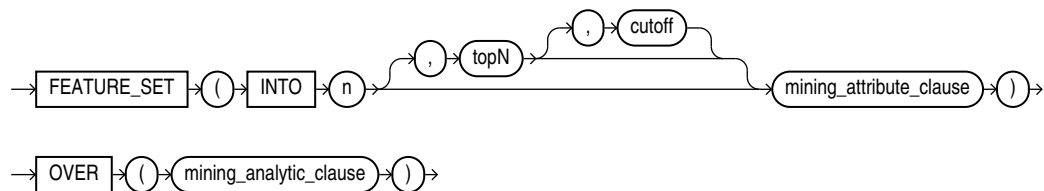

**mining\_attribute\_clause::=**

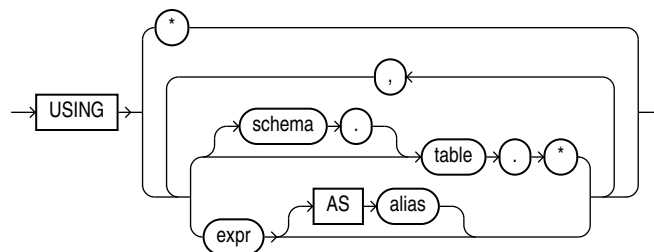

**mining\_analytic\_clause::=**

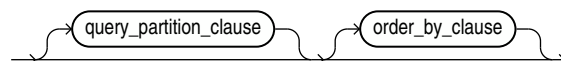

 **See Also:**

"Analytic Functions" for information on the syntax, semantics, and restrictions of *mining\_analytic\_clause*

### Purpose

FEATURE\_SET returns a set of feature ID and feature value pairs for each row in the selection. The return value is a varray of objects with field names FEATURE\_ID and VALUE. The data type of both fields is NUMBER.

### topN and cutoff

You can specify *topN* and *cutoff* to limit the number of features returned by the function. By default, both *topN* and *cutoff* are null and all features are returned.

- *topN* is the *N* highest value features. If multiple features have the *N*th value, then the function chooses one of them.
- *cutoff* is a value threshold. Only features that are greater than or equal to *cutoff* are returned. To filter by *cutoff* only, specify NULL for *topN*.

To return up to *N* features that are greater than or equal to *cutoff*, specify both *topN* and *cutoff*.

### Syntax Choice

FEATURE\_SET can score the data in one of two ways: It can apply a mining model object to the data, or it can dynamically mine the data by executing an analytic clause that builds and applies one or more transient mining models. Choose **Syntax** or **Analytic Syntax**:

- **Syntax** — Use the first syntax to score the data with a pre-defined model. Supply the name of a feature extraction model.
- **Analytic Syntax** — Use the analytic syntax to score the data without a pre-defined model. Include INTO *n*, where *n* is the number of features to extract, and *mining\_analytic\_clause*, which specifies if the data should be partitioned for multiple model builds. The *mining\_analytic\_clause* supports a *query\_partition\_clause* and an *order\_by\_clause*. (See "analytic\_clause::".)

The syntax of the FEATURE\_SET function can use an optional GROUPING hint when scoring a partitioned model. See GROUPING Hint.

### mining\_attribute\_clause

*mining\_attribute\_clause* identifies the column attributes to use as predictors for scoring. When the function is invoked with the analytic syntax, these predictors are also used for building the transient models. The *mining\_attribute\_clause* behaves as described for the PREDICTION function. (See "mining\_attribute\_clause".)

 **See Also:**

- *Oracle Data Mining User's Guide* for information about scoring.
- *Oracle Data Mining Concepts* for information about feature extraction.

 **Note:**

The following example is excerpted from the Data Mining sample programs. For more information about the sample programs, see Appendix A in *Oracle Data Mining User's Guide*.

**Example**

This example lists the top features corresponding to a given customer record and determines the top attributes for each feature (based on coefficient > 0.25).

```
WITH
feat_tab AS (
SELECT F.feature_id fid,
       A.attribute_name attr,
       TO_CHAR(A.attribute_value) val,
       A.coefficient coeff
  FROM TABLE(DBMS_DATA_MINING.GET_MODEL_DETAILS_NMF('nmf_sh_sample')) F,
       TABLE(F.attribute_set) A
 WHERE A.coefficient > 0.25
),
feat AS (
SELECT fid,
       CAST(COLLECT(Featattr(attr, val, coeff))
            AS Featattrs) f_attrs
  FROM feat_tab
 GROUP BY fid
),
cust_10_features AS (
SELECT T.cust_id, S.feature_id, S.value
  FROM (SELECT cust_id, FEATURE_SET(nmf_sh_sample, 10 USING *) pset
        FROM nmf_sh_sample_apply_prepared
        WHERE cust_id = 100002) T,
        TABLE(T.pset) S
)
SELECT A.value, A.feature_id fid,
       B.attr, B.val, B.coeff
  FROM cust_10_features A,
       (SELECT T.fid, F.*
        FROM feat T,
             TABLE(T.f_attrs) F) B
 WHERE A.feature_id = B.fid
 ORDER BY A.value DESC, A.feature_id ASC, coeff DESC, attr ASC, val ASC;
```

VALUE	FID	ATTR	VAL	COEFF
6.8409	7	YRS_RESIDENCE		1.3879
6.8409	7	BOOKKEEPING_APPLICATION		.4388
6.8409	7	CUST_GENDER	M	.2956
6.8409	7	COUNTRY_NAME	United States of America	.2848

6.4975	3	YRS_RESIDENCE		1.2668
6.4975	3	BOOKKEEPING_APPLICATION		.3465
6.4975	3	COUNTRY_NAME	United States of America	.2927
6.4886	2	YRS_RESIDENCE		1.3285
6.4886	2	CUST_GENDER	M	.2819
6.4886	2	PRINTER_SUPPLIES		.2704
6.3953	4	YRS_RESIDENCE		1.2931
5.9640	6	YRS_RESIDENCE		1.1585
5.9640	6	HOME_THEATER_PACKAGE		.2576
5.2424	5	YRS_RESIDENCE		1.0067
2.4714	8	YRS_RESIDENCE		.3297
2.3559	1	YRS_RESIDENCE		.2768
2.3559	1	FLAT_PANEL_MONITOR		.2593

## 38.10 FEATURE\_VALUE

### Syntax

**feature\_value::=**

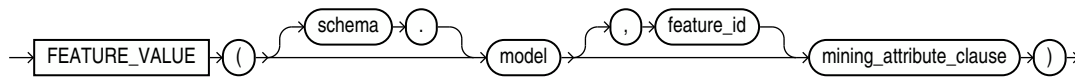

### Analytic Syntax

**feature\_value\_analytic::=**

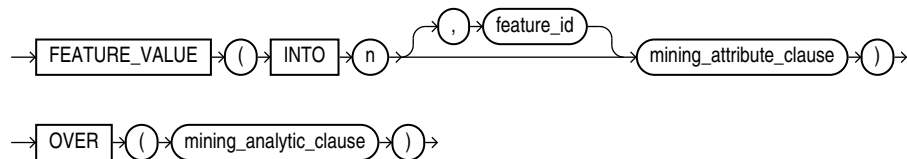

**mining\_attribute\_clause::=**

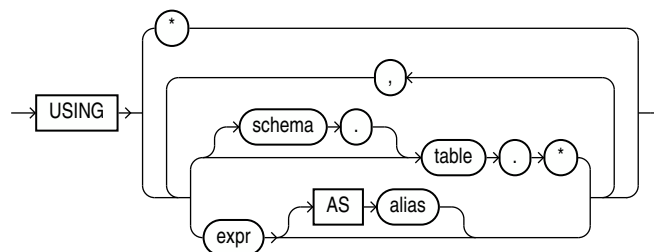

**mining\_analytic\_clause::=**

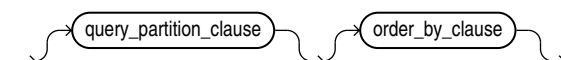

 **See Also:**

"Analytic Functions" for information on the syntax, semantics, and restrictions of *mining\_analytic\_clause*

**Purpose**

FEATURE\_VALUE returns a feature value for each row in the selection. The value refers to the highest value feature or to the specified *feature\_id*. The feature value is returned as BINARY\_DOUBLE.

**Syntax Choice**

FEATURE\_VALUE can score the data in one of two ways: It can apply a mining model object to the data, or it can dynamically mine the data by executing an analytic clause that builds and applies one or more transient mining models. Choose **Syntax** or **Analytic Syntax**:

- **Syntax** — Use the first syntax to score the data with a pre-defined model. Supply the name of a feature extraction model.
- **Analytic Syntax** — Use the analytic syntax to score the data without a pre-defined model. Include INTO *n*, where *n* is the number of features to extract, and *mining\_analytic\_clause*, which specifies if the data should be partitioned for multiple model builds. The *mining\_analytic\_clause* supports a *query\_partition\_clause* and an *order\_by\_clause*. (See "analytic\_clause::".)

The syntax of the FEATURE\_VALUE function can use an optional GROUPING hint when scoring a partitioned model. See GROUPING Hint.

**mining\_attribute\_clause**

*mining\_attribute\_clause* identifies the column attributes to use as predictors for scoring. When the function is invoked with the analytic syntax, this data is also used for building the transient models. The *mining\_attribute\_clause* behaves as described for the PREDICTION function. (See "mining\_attribute\_clause".)

 **See Also:**

- *Oracle Data Mining User's Guide* for information about scoring.
- *Oracle Data Mining Concepts* for information about feature extraction.

 **Note:**

The following example is excerpted from the Data Mining sample programs. For more information about the sample programs, see Appendix A in *Oracle Data Mining User's Guide*.

### Example

The following example lists the customers that correspond to feature 3, ordered by match quality.

```
SELECT *
FROM (SELECT cust_id, FEATURE_VALUE(nmf_sh_sample, 3 USING *) match_quality
      FROM nmf_sh_sample_apply_prepared
      ORDER BY match_quality DESC)
WHERE ROWNUM < 11;
```

CUST_ID	MATCH_QUALITY
100210	19.4101627
100962	15.2482251
101151	14.5685197
101499	14.4186292
100363	14.4037396
100372	14.3335148
100982	14.1716545
101039	14.1079914
100759	14.0913761
100953	14.0799737

## 38.11 ORA\_DM\_PARTITION\_NAME

### Syntax

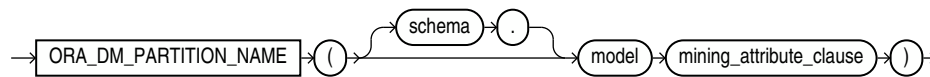

### mining\_attribute\_clause::=

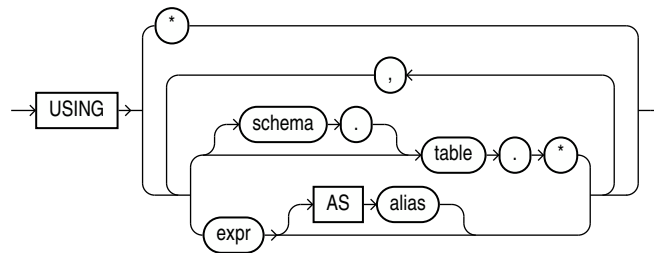

### Purpose

ORA\_DM\_PARTITION\_NAME is a single row function that works along with other existing functions. This function returns the name of the partition associated with the input row. When ORA\_DM\_PARTITION\_NAME is used on a non-partitioned model, the result is NULL.

The syntax of the ORA\_DM\_PARTITION\_NAME function can use an optional GROUPING hint when scoring a partitioned model. See GROUPING Hint.

### *mining\_attribute\_clause*

The *mining\_attribute\_clause* identifies the column attributes to use as predictors for scoring. When the function is invoked with the analytic syntax, these predictors are also used for building the transient models. The *mining\_attribute\_clause* behaves as described for the PREDICTION function. See *mining\_attribute\_clause*.

#### See Also:

- *Oracle Data Mining User's Guide* for information about scoring
- *Oracle Data Mining Concepts* for information about clustering

#### Note:

The following examples are excerpted from the Data Mining sample programs. For more information about the sample programs, see Appendix A in *Oracle Data Mining User's Guide*.

### Example

```
SELECT prediction(mymodel using *) pred, ora_dm_partition_name(mymodel USING
*) pname FROM customers;
```

## 38.12 PREDICTION

### Syntax

***prediction*::=**

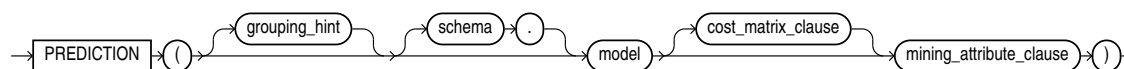

### Analytic Syntax

***prediction\_analytic*::=**



**cost\_matrix\_clause::=**

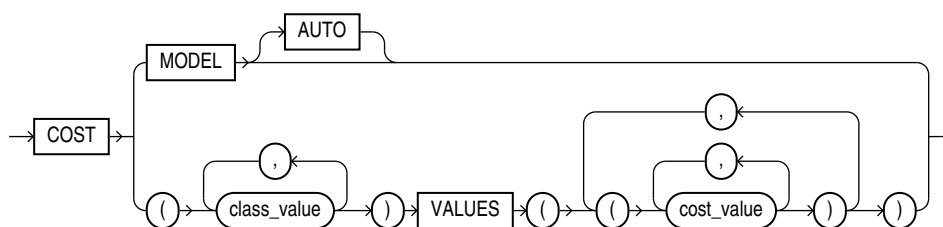

**mining\_attribute\_clause::=**

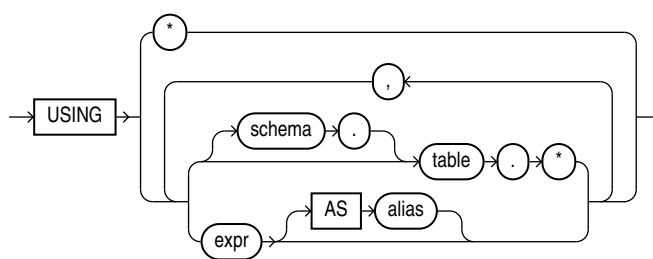

**mining\_analytic\_clause::=**

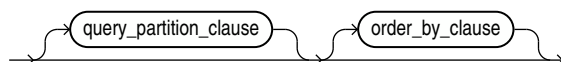

**See Also:**

"Analytic Functions" for information on the syntax, semantics, and restrictions of *mining\_analytic\_clause*

**Purpose**

PREDICTION returns a prediction for each row in the selection. The data type of the returned prediction depends on whether the function performs Regression, Classification, or Anomaly Detection.

- **Regression:** Returns the expected target value for each row. The data type of the return value is the data type of the target.
- **Classification:** Returns the most probable target class (or lowest cost target class, if costs are specified) for each row. The data type of the return value is the data type of the target.
- **Anomaly Detection:** Returns 1 or 0 for each row. Typical rows are classified as 1. Rows that differ significantly from the rest of the data are classified as 0.



### `cost_matrix_clause`

Costs are a biasing factor for minimizing the most harmful kinds of misclassifications. You can specify `cost_matrix_clause` for Classification or Anomaly Detection. Costs are not relevant for Regression. The `cost_matrix_clause` behaves as described for "PREDICTION COST".

### Syntax Choice

PREDICTION can score data in one of two ways: It can apply a mining model object to the data, or it can dynamically score the data by executing an analytic clause that builds and applies one or more transient mining models. Choose **Syntax** or **Analytic Syntax**:

- **Syntax:** Use this syntax to score the data with a pre-defined model. Supply the name of a model that performs Classification, Regression, or Anomaly Detection.
- **Analytic Syntax:** Use the analytic syntax to score the data without a pre-defined model. The analytic syntax uses `mining_analytic_clause`, which specifies if the data should be partitioned for multiple model builds. The `mining_analytic_clause` supports a `query_partition_clause` and an `order_by_clause`. (See "analytic\_clause::".)
  - For Regression, specify FOR `expr`, where `expr` is an expression that identifies a target column that has a numeric data type.
  - For Classification, specify FOR `expr`, where `expr` is an expression that identifies a target column that has a character data type.
  - For Anomaly Detection, specify the keywords OF ANOMALY.

The syntax of the PREDICTION function can use an optional GROUPING hint when scoring a partitioned model. See GROUPING Hint.

### `mining_attribute_clause`

`mining_attribute_clause` identifies the column attributes to use as predictors for scoring.

- If you specify USING \*, all the relevant attributes present in the input row are used.
- If you invoke the function with the analytic syntax, the `mining_attribute_clause` is used both for building the transient models and for scoring.
- If you invoke the function with a pre-defined model, the `mining_attribute_clause` should include all or some of the attributes that were used to create the model. The following conditions apply:
  - If `mining_attribute_clause` includes an attribute with the same name but a different data type from the one that was used to create the model, then the data type is converted to the type expected by the model.
  - If you specify more attributes for scoring than were used to create the model, then the extra attributes are silently ignored.
  - If you specify fewer attributes for scoring than were used to create the model, then scoring is performed on a best-effort basis.

 **See Also:**

- *Oracle Data Mining User's Guide* for information about scoring.
- *Oracle Data Mining Concepts* for information about predictive data mining.
- Appendix C in *Oracle Database Globalization Support Guide* for the collation derivation rules, which define the collation assigned to the return value of PREDICTION when it is a character value

 **Note:**

The following examples are excerpted from the Data Mining sample programs. For more information about the sample programs, see Appendix A in *Oracle Data Mining User's Guide*.

**Example**

In this example, the model `dt_sh_clas_sample` predicts the gender and age of customers who are most likely to use an affinity card (`target = 1`). The PREDICTION function takes into account the cost matrix associated with the model and uses marital status, education, and household size as predictors.

```
SELECT cust_gender, COUNT(*) AS cnt, ROUND(AVG(age)) AS avg_age
FROM mining_data_apply_v
WHERE PREDICTION(dt_sh_clas_sample COST MODEL
    USING cust_marital_status, education, household_size) = 1
GROUP BY cust_gender
ORDER BY cust_gender;
```

CUST_GENDER	CNT	AVG_AGE
F	170	38
M	685	42

The cost matrix associated with the model `dt_sh_clas_sample` is stored in the table `dt_sh_sample_costs`. The cost matrix specifies that the misclassification of 1 is 8 times more costly than the misclassification of 0.

```
SQL> select * from dt_sh_sample_cost;
```

ACTUAL_TARGET_VALUE	PREDICTED_TARGET_VALUE	COST
0	0	.000000000
0	1	1.000000000
1	0	8.000000000
1	1	.000000000

**Analytic Example**

In this example, dynamic regression is used to predict the age of customers who are likely to use an affinity card. The query returns the 3 customers whose predicted age is most different from the actual. The query includes information about the predictors that have the greatest influence on the prediction.

```
SELECT cust_id, age, pred_age, age-pred_age age_diff, pred_det FROM
  (SELECT cust_id, age, pred_age, pred_det,
    RANK() OVER (ORDER BY ABS(age-pred_age) desc) rnk FROM
  (SELECT cust_id, age,
    PREDICTION(FOR age USING *) OVER () pred_age,
    PREDICTION_DETAILS(FOR age ABS USING *) OVER () pred_det
  FROM mining_data_apply_v))
WHERE rnk <= 3;
```

CUST_ID	AGE	PRED_AGE	AGE_DIFF	PRED_DET
100910	80	40.67	39.33	<Details algorithm="Support Vector Machines"> <Attribute name="HOME_THEATER_PACKAGE" actualValue="1" weight=".059" rank="1"/> <Attribute name="Y_BOX_GAMES" actualValue="0" weight=".059" rank="2"/> <Attribute name="AFFINITY_CARD" actualValue="0" weight=".059" rank="3"/> <Attribute name="FLAT_PANEL_MONITOR" actualValue="1" weight=".059" rank="4"/> <Attribute name="YRS_RESIDENCE" actualValue="4" weight=".059" rank="5"/> </Details>
101285	79	42.18	36.82	<Details algorithm="Support Vector Machines"> <Attribute name="HOME_THEATER_PACKAGE" actualValue="1" weight=".059" rank="1"/> <Attribute name="HOUSEHOLD_SIZE" actualValue="2" weight=".059" rank="2"/> <Attribute name="CUST_MARITAL_STATUS" actualValue="Mabsent" weight=".059" rank="3"/> <Attribute name="Y_BOX_GAMES" actualValue="0" weight=".059" rank="4"/> <Attribute name="OCCUPATION" actualValue="Prof." weight=".059" rank="5"/> </Details>
100694	77	41.04	35.96	<Details algorithm="Support Vector Machines"> <Attribute name="HOME_THEATER_PACKAGE" actualValue="1" weight=".059" rank="1"/> <Attribute name="EDUCATION" actualValue="&lt; Bach." weight=".059" rank="2"/> <Attribute name="Y_BOX_GAMES" actualValue="0" weight=".059" rank="3"/> <Attribute name="CUST_ID" actualValue="100694" weight=".059" rank="4"/> <Attribute name="COUNTRY_NAME" actualValue="United States of America" weight=".059" rank="5"/> </Details>

## 38.13 PREDICTION\_BOUNDS

### Syntax

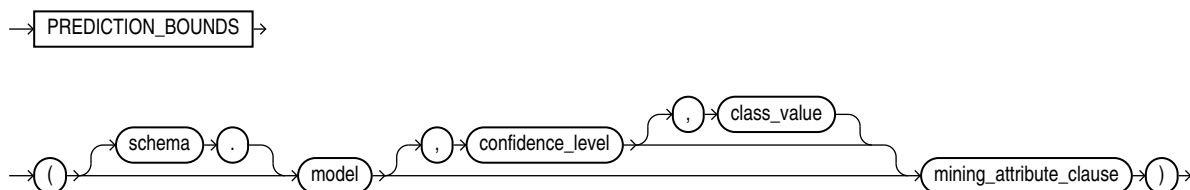

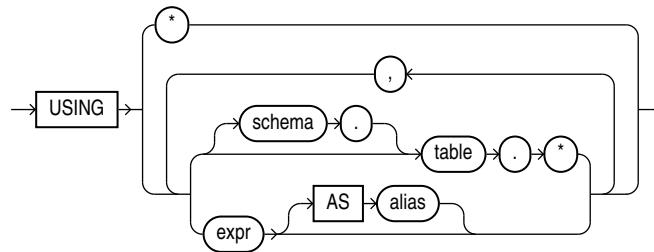
**mining\_attribute\_clause::=****Purpose**

`PREDICTION_BOUNDS` applies a Generalized Linear Model (GLM) to predict a class or a value for each row in the selection. The function returns the upper and lower bounds of each prediction in a varray of objects with fields `UPPER` and `LOWER`.

GLM can perform either regression or binary classification:

- The bounds for regression refer to the predicted target value. The data type of `UPPER` and `LOWER` is the data type of the target.
- The bounds for binary classification refer to the probability of either the predicted target class or the specified `class_value`. The data type of `UPPER` and `LOWER` is `BINARY_DOUBLE`.

If the model was built using ridge regression, or if the covariance matrix is found to be singular during the build, then `PREDICTION_BOUNDS` returns `NULL` for both bounds.

`confidence_level` is a number in the range (0,1). The default value is 0.95. You can specify `class_value` while leaving `confidence_level` at its default by specifying `NULL` for `confidence_level`.

The syntax of the `PREDICTION_BOUNDS` function can use an optional `GROUPING` hint when scoring a partitioned model. See `GROUPING Hint`.

**mining\_attribute\_clause**

`mining_attribute_clause` identifies the column attributes to use as predictors for scoring. This clause behaves as described for the `PREDICTION` function. (Note that the reference to analytic syntax does not apply.) See "mining\_attribute\_clause".

**See Also:**

- *Oracle Data Mining User's Guide* for information about scoring
- *Oracle Data Mining Concepts* for information about Generalized Linear Models

**Note:**

The following example is excerpted from the Data Mining sample programs. For more information about the sample programs, see Appendix A in *Oracle Data Mining User's Guide*.

### Example

The following example returns the distribution of customers whose ages are predicted with 98% confidence to be greater than 24 and less than 46.

```
SELECT count(cust_id) cust_count, cust_marital_status
FROM (SELECT cust_id, cust_marital_status
      FROM mining_data_apply_v
      WHERE PREDICTION_BOUNDS(glmr_sh_regr_sample,0.98 USING *).LOWER > 24 AND
            PREDICTION_BOUNDS(glmr_sh_regr_sample,0.98 USING *).UPPER < 46)
GROUP BY cust_marital_status;
```

CUST_COUNT	CUST_MARITAL_STATUS
46	NeverM
7	Mabsent
5	Separ.
35	Divorc.
72	Married

## 38.14 PREDICTION\_COST

### Syntax

***prediction\_cost::=***

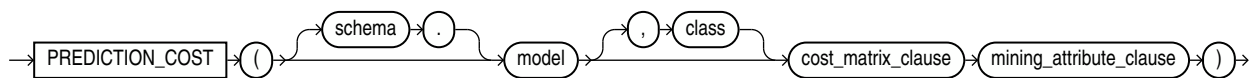

### Analytic Syntax

***prediction\_cost\_analytic::=***

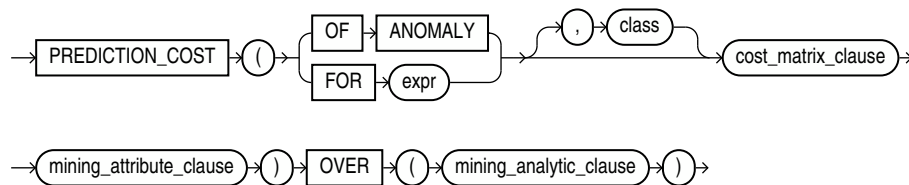

***cost\_matrix\_clause::=***

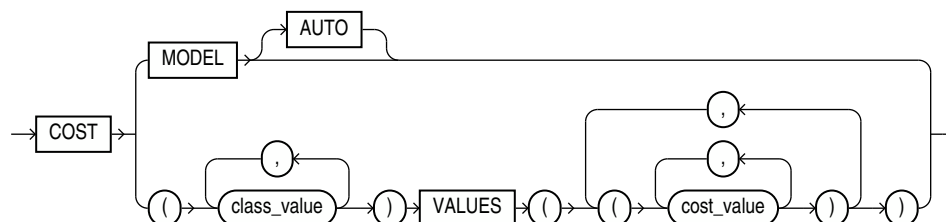

**mining\_attribute\_clause::=**

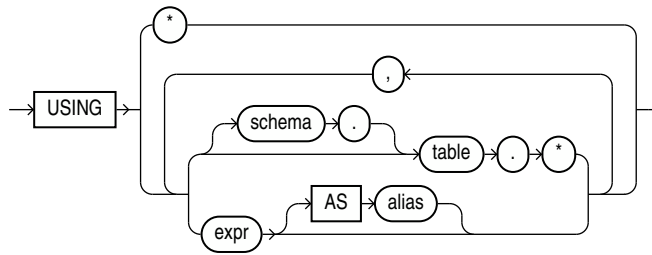

**mining\_analytic\_clause::=**

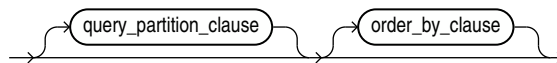

**See Also:**

"Analytic Functions" for information on the syntax, semantics, and restrictions of *mining\_analytic\_clause*

**Purpose**

PREDICTION\_COST returns a cost for each row in the selection. The cost refers to the lowest cost class or to the specified *class*. The cost is returned as BINARY\_DOUBLE.

PREDICTION\_COST can perform classification or anomaly detection. For classification, the returned cost refers to a predicted target class. For anomaly detection, the returned cost refers to a classification of 1 (for typical rows) or 0 (for anomalous rows).

You can use PREDICTION\_COST in conjunction with the PREDICTION function to obtain the prediction and the cost of the prediction.

**cost\_matrix\_clause**

Costs are a biasing factor for minimizing the most harmful kinds of misclassifications. For example, false positives might be considered more costly than false negatives. Costs are specified in a cost matrix that can be associated with the model or defined inline in a VALUES clause. All classification algorithms can use costs to influence scoring.

Decision Tree is the only algorithm that can use costs to influence the model build. The cost matrix used to build a Decision Tree model is also the default scoring cost matrix for the model.

The following cost matrix table specifies that the misclassification of 1 is five times more costly than the misclassification of 0.

ACTUAL_TARGET_VALUE	PREDICTED_TARGET_VALUE	COST
0	0	0
0	1	1

1	0	5
1	1	0

In `cost_matrix_clause`:

- `COST MODEL` indicates that scoring should be performed by taking into account the scoring cost matrix associated with the model. If the cost matrix does not exist, then the function returns an error.
- `COST MODEL AUTO` indicates that the existence of a cost matrix is unknown. If a cost matrix exists, then the function uses it to return the lowest cost prediction. Otherwise the function returns the highest probability prediction.
- The `VALUES` clause specifies an inline cost matrix for `class_value`. For example, you could specify that the misclassification of 1 is five times more costly than the misclassification of 0 as follows:

```
PREDICTION (nb_model COST (0,1) VALUES ((0, 1), (1, 5)) USING *)
```

If a model that has a scoring cost matrix is invoked with an inline cost matrix, then the inline costs are used.

#### See Also:

*Oracle Data Mining User's Guide* for more information about cost-sensitive prediction.

### Syntax Choice

`PREDICTION_COST` can score the data in one of two ways: It can apply a mining model object to the data, or it can dynamically mine the data by executing an analytic clause that builds and applies one or more transient mining models. Choose **Syntax** or **Analytic Syntax**:

- **Syntax** — Use the first syntax to score the data with a pre-defined model. Supply the name of a model that performs classification or anomaly detection.
- **Analytic Syntax** — Use the analytic syntax to score the data without a pre-defined model. The analytic syntax uses `mining_analytic_clause`, which specifies if the data should be partitioned for multiple model builds. The `mining_analytic_clause` supports a `query_partition_clause` and an `order_by_clause`. (See "analytic\_clause::".)
  - For classification, specify `FOR expr`, where `expr` is an expression that identifies a target column that has a character data type.
  - For anomaly detection, specify the keywords `OF ANOMALY`.

The syntax of the `PREDICTION_COST` function can use an optional `GROUPING` hint when scoring a partitioned model. See `GROUPING` Hint.

### mining\_attribute\_clause

`mining_attribute_clause` identifies the column attributes to use as predictors for scoring. When the function is invoked with the analytic syntax, these predictors are also used for building the transient models. The `mining_attribute_clause` behaves as described for the `PREDICTION` function. (See "mining\_attribute\_clause".)

 **See Also:**

- *Oracle Data Mining User's Guide* for information about scoring.
- *Oracle Data Mining Concepts* for information about classification with costs

 **Note:**

The following example is excerpted from the Data Mining sample programs. For more information about the sample programs, see Appendix A in *Oracle Data Mining User's Guide*.

**Example**

This example predicts the ten customers in Italy who would respond to the least expensive sales campaign (offering an affinity card).

```
SELECT cust_id
FROM (SELECT cust_id,rank()
      OVER (ORDER BY PREDICTION_COST(DT_SH_Clas_sample, 1 COST MODEL USING *)
            ASC, cust_id) rnk
      FROM mining_data_apply_v
      WHERE country_name = 'Italy')
WHERE rnk <= 10
ORDER BY rnk;
```

```
  CUST_ID
-----
  100081
  100179
  100185
  100324
  100344
  100554
  100662
  100733
  101250
  101306
```



## 38.15 PREDICTION\_DETAILS

### Syntax

***prediction\_details::=***

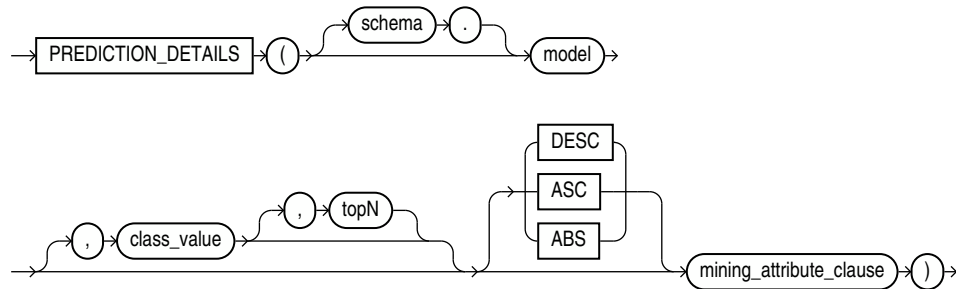

### Analytic Syntax

***prediction\_details\_analytic::=***

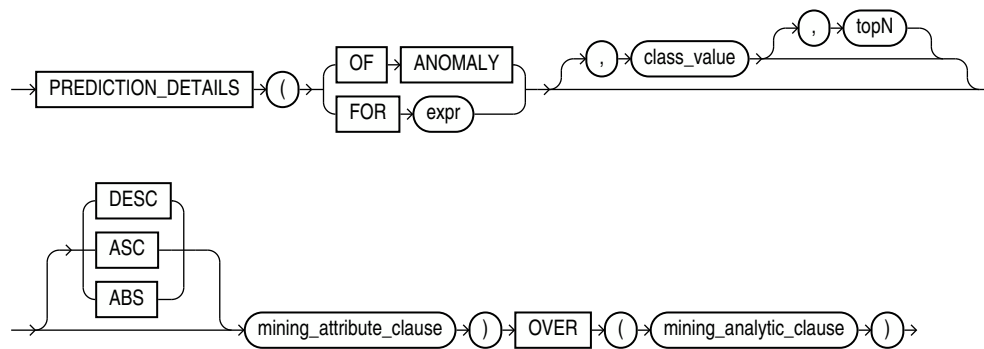

***mining\_attribute\_clause::=***

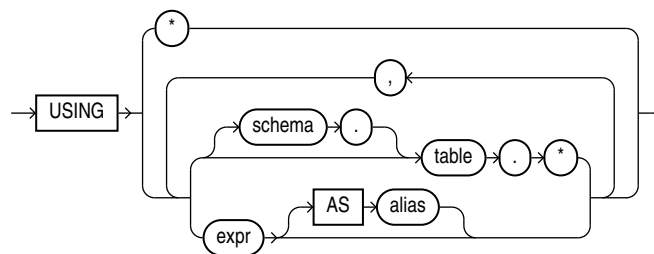

***mining\_analytic\_clause::=***

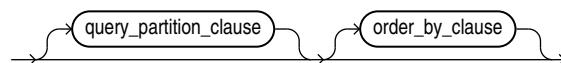

 **See Also:**

"Analytic Functions" for information on the syntax, semantics, and restrictions of *mining\_analytic\_clause*

**Purpose**

PREDICTION\_DETAILS returns prediction details for each row in the selection. The return value is an XML string that describes the attributes of the prediction.

For regression, the returned details refer to the predicted target value. For classification and anomaly detection, the returned details refer to the highest probability class or the specified *class\_value*.

**topN**

If you specify a value for *topN*, the function returns the *N* attributes that have the most influence on the prediction (the score). If you do not specify *topN*, the function returns the 5 most influential attributes.

**DESC, ASC, or ABS**

The returned attributes are ordered by weight. The weight of an attribute expresses its positive or negative impact on the prediction. For regression, a positive weight indicates a higher value prediction; a negative weight indicates a lower value prediction. For classification and anomaly detection, a positive weight indicates a higher probability prediction; a negative weight indicates a lower probability prediction.

By default, PREDICTION\_DETAILS returns the attributes with the highest positive weight (DESC). If you specify ASC, the attributes with the highest negative weight are returned. If you specify ABS, the attributes with the greatest weight, whether negative or positive, are returned. The results are ordered by absolute value from highest to lowest. Attributes with a zero weight are not included in the output.

**Syntax Choice**

PREDICTION\_DETAILS can score the data in one of two ways: It can apply a mining model object to the data, or it can dynamically mine the data by executing an analytic clause that builds and applies one or more transient mining models. Choose **Syntax** or **Analytic Syntax**:

- **Syntax** — Use the first syntax to score the data with a pre-defined model. Supply the name of a model that performs classification, regression, or anomaly detection.
- **Analytic Syntax** — Use the analytic syntax to score the data without a pre-defined model. The analytic syntax uses *mining\_analytic\_clause*, which specifies if the data should be partitioned for multiple model builds. The *mining\_analytic\_clause* supports a *query\_partition\_clause* and an *order\_by\_clause*. (See "analytic\_clause::".)
  - For classification, specify FOR *expr*, where *expr* is an expression that identifies a target column that has a character data type.
  - For regression, specify FOR *expr*, where *expr* is an expression that identifies a target column that has a numeric data type.
  - For anomaly detection, specify the keywords OF ANOMALY.

The syntax of the PREDICTION\_DETAILS function can use an optional GROUPING hint when scoring a partitioned model. See GROUPING Hint.

## mining\_attribute\_clause

*mining\_attribute\_clause* identifies the column attributes to use as predictors for scoring. When the function is invoked with the analytic syntax, these predictors are also used for building the transient models. The *mining\_attribute\_clause* behaves as described for the PREDICTION function. (See "mining\_attribute\_clause".)

### See Also:

- *Oracle Data Mining User's Guide* for information about scoring.
- *Oracle Data Mining Concepts* for information about predictive data mining.

### Note:

The following examples are excerpted from the Data Mining sample programs. For more information about the sample programs, see Appendix A in *Oracle Data Mining User's Guide*.

## Example

This example uses the model `svmr_sh_regr_sample` to score the data. The query returns the three attributes that have the greatest influence on predicting a higher value for customer age.

```
SELECT PREDICTION_DETAILS(svmr_sh_regr_sample, null, 3 USING *) prediction_details
FROM mining_data_apply_v
WHERE cust_id = 100001;
```

```
PREDICTION_DETAILS
```

```
-----
<Details algorithm="Support Vector Machines">
<Attribute name="CUST_MARITAL_STATUS" actualValue="Widowed" weight=".361" rank="1"/>
<Attribute name="CUST_GENDER" actualValue="F" weight=".14" rank="2"/>
<Attribute name="HOME_THEATER_PACKAGE" actualValue="1" weight=".135" rank="3"/>
</Details>
```

## Analytic Syntax

This example dynamically identifies customers whose age is not typical for the data. The query returns the attributes that predict or detract from a typical age.

```
SELECT cust_id, age, pred_age, age-pred_age age_diff, pred_det
FROM (SELECT cust_id, age, pred_age, pred_det,
RANK() OVER (ORDER BY ABS(age-pred_age) DESC) rnk
FROM (SELECT cust_id, age,
PREDICTION(FOR age USING *) OVER () pred_age,
PREDICTION_DETAILS(FOR age ABS USING *) OVER () pred_det
FROM mining_data_apply_v))
WHERE rnk <= 5;
```

```
CUST_ID AGE PRED_AGE AGE_DIFF PRED_DET
```

```
-----
100910 80 40.67 39.33 <Details algorithm="Support Vector Machines">
<Attribute name="HOME_THEATER_PACKAGE" actualValue="1" weight=".059"
```

```
rank="1"/>
<Attribute name="Y_BOX_GAMES" actualValue="0" weight=".059"
rank="2"/>
<Attribute name="AFFINITY_CARD" actualValue="0" weight=".059"
rank="3"/>
<Attribute name="FLAT_PANEL_MONITOR" actualValue="1" weight=".059"
rank="4"/>
<Attribute name="YRS_RESIDENCE" actualValue="4" weight=".059"
rank="5"/>
</Details>

101285 79 42.18 36.82 <Details algorithm="Support Vector Machines">
<Attribute name="HOME_THEATER_PACKAGE" actualValue="1" weight=".059"
rank="1"/>
<Attribute name="HOUSEHOLD_SIZE" actualValue="2" weight=".059"
rank="2"/>
<Attribute name="CUST_MARITAL_STATUS" actualValue="Mabsent"
weight=".059" rank="3"/>
<Attribute name="Y_BOX_GAMES" actualValue="0" weight=".059"
rank="4"/>
<Attribute name="OCCUPATION" actualValue="Prof." weight=".059"
rank="5"/>
</Details>

100694 77 41.04 35.96 <Details algorithm="Support Vector Machines">
<Attribute name="HOME_THEATER_PACKAGE" actualValue="1"
weight=".059" rank="1"/>
<Attribute name="EDUCATION" actualValue="&lt; Bach." weight=".059"
rank="2"/>
<Attribute name="Y_BOX_GAMES" actualValue="0" weight=".059"
rank="3"/>
<Attribute name="CUST_ID" actualValue="100694" weight=".059"
rank="4"/>
<Attribute name="COUNTRY_NAME" actualValue="United States of
America" weight=".059" rank="5"/>
</Details>

100308 81 45.33 35.67 <Details algorithm="Support Vector Machines">
<Attribute name="HOME_THEATER_PACKAGE" actualValue="1" weight=".059"
rank="1"/>
<Attribute name="Y_BOX_GAMES" actualValue="0" weight=".059"
rank="2"/>
<Attribute name="HOUSEHOLD_SIZE" actualValue="2" weight=".059"
rank="3"/>
<Attribute name="FLAT_PANEL_MONITOR" actualValue="1" weight=".059"
rank="4"/>
<Attribute name="CUST_GENDER" actualValue="F" weight=".059"
rank="5"/>
</Details>

101256 90 54.39 35.61 <Details algorithm="Support Vector Machines">
<Attribute name="YRS_RESIDENCE" actualValue="9" weight=".059"
rank="1"/>
<Attribute name="HOME_THEATER_PACKAGE" actualValue="1" weight=".059"
rank="2"/>
<Attribute name="EDUCATION" actualValue="&lt; Bach." weight=".059"
rank="3"/>
<Attribute name="Y_BOX_GAMES" actualValue="0" weight=".059"
rank="4"/>
<Attribute name="COUNTRY_NAME" actualValue="United States of
America" weight=".059" rank="5"/>
</Details>
```

## 38.16 PREDICTION\_PROBABILITY

### Syntax

***prediction\_probability::=***

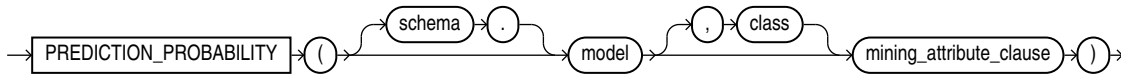

### Analytic Syntax

***prediction\_prob\_analytic::=***

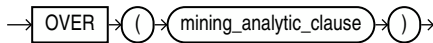
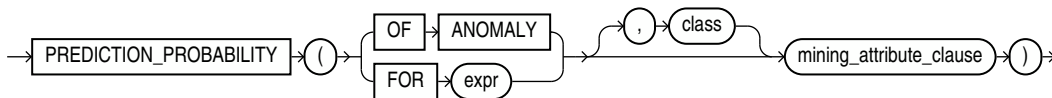

***mining\_attribute\_clause::=***

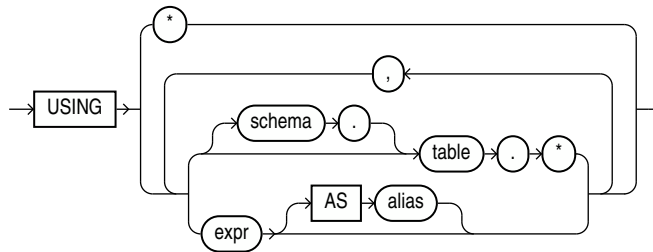

***mining\_analytic\_clause::=***

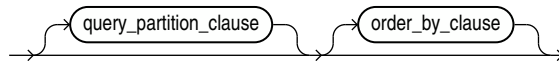

### See Also:

"Analytic Functions" for information on the syntax, semantics, and restrictions of `mining_analytic_clause`

## Purpose

PREDICTION\_PROBABILITY returns a probability for each row in the selection. The probability refers to the highest probability class or to the specified *class*. The data type of the returned probability is BINARY\_DOUBLE.

PREDICTION\_PROBABILITY can perform classification or anomaly detection. For classification, the returned probability refers to a predicted target class. For anomaly detection, the returned probability refers to a classification of 1 (for typical rows) or 0 (for anomalous rows).

You can use PREDICTION\_PROBABILITY in conjunction with the PREDICTION function to obtain the prediction and the probability of the prediction.

## Syntax Choice

PREDICTION\_PROBABILITY can score the data in one of two ways: It can apply a mining model object to the data, or it can dynamically mine the data by executing an analytic clause that builds and applies one or more transient mining models. Choose **Syntax** or **Analytic Syntax**:

- **Syntax** — Use the first syntax to score the data with a pre-defined model. Supply the name of a model that performs classification or anomaly detection.
- **Analytic Syntax** — Use the analytic syntax to score the data without a pre-defined model. The analytic syntax uses *mining\_analytic\_clause*, which specifies if the data should be partitioned for multiple model builds. The *mining\_analytic\_clause* supports a *query\_partition\_clause* and an *order\_by\_clause*. (See "analytic\_clause::".)
  - For classification, specify FOR *expr*, where *expr* is an expression that identifies a target column that has a character data type.
  - For anomaly detection, specify the keywords OF ANOMALY.

The syntax of the PREDICTION\_PROBABILITY function can use an optional GROUPING hint when scoring a partitioned model. See GROUPING Hint.

## mining\_attribute\_clause

*mining\_attribute\_clause* identifies the column attributes to use as predictors for scoring. When the function is invoked with the analytic syntax, these predictors are also used for building the transient models. The *mining\_attribute\_clause* behaves as described for the PREDICTION function. (See "mining\_attribute\_clause".)

### See Also:

- *Oracle Data Mining User's Guide* for information about scoring.
- *Oracle Data Mining Concepts* for information about predictive data mining.

### Note:

The following examples are excerpted from the Data Mining sample programs. For information about the sample programs, see Appendix A in *Oracle Data Mining User's Guide*.

### Example

The following example returns the 10 customers living in Italy who are most likely to use an affinity card.

```
SELECT cust_id FROM (
  SELECT cust_id
  FROM mining_data_apply_v
  WHERE country_name = 'Italy'
  ORDER BY PREDICTION_PROBABILITY(DT_SH_Clas_sample, 1 USING *)
  DESC, cust_id)
WHERE rownum < 11;
```

```
CUST_ID
-----
100081
100179
100185
100324
100344
100554
100662
100733
101250
101306
```

### Analytic Example

This example identifies rows that are most atypical in the data in `mining_data_one_class_v`. Each type of marital status is considered separately so that the most anomalous rows per marital status group are returned.

The query returns three attributes that have the most influence on the determination of anomalous rows. The `PARTITION BY` clause causes separate models to be built and applied for each marital status. Because there is only one record with status `Mabsent`, no model is created for that partition (and no details are provided).

```
SELECT cust_id, cust_marital_status, rank_anom, anom_det FROM
  (SELECT cust_id, cust_marital_status, anom_det,
    rank() OVER (PARTITION BY CUST_MARITAL_STATUS
      ORDER BY ANOM_PROB DESC,cust_id) rank_anom FROM
    (SELECT cust_id, cust_marital_status,
      PREDICTION_PROBABILITY(OF ANOMALY, 0 USING *)
      OVER (PARTITION BY CUST_MARITAL_STATUS) anom_prob,
      PREDICTION_DETAILS(OF ANOMALY, 0, 3 USING *)
      OVER (PARTITION BY CUST_MARITAL_STATUS) anom_det
    FROM mining_data_one_class_v
  ))
WHERE rank_anom < 3 order by 2, 3;
```

```
CUST_ID CUST_MARITAL_STATUS RANK_ANOM ANOM_DET
-----
102366 Divorc. 1 <Details algorithm="Support Vector Machines" class="0">
  <Attribute name="COUNTRY_NAME" actualValue="United Kingdom"
  weight=".069" rank="1"/>
  <Attribute name="AGE" actualValue="28" weight=".013"
  rank="2"/>
  <Attribute name="YRS_RESIDENCE" actualValue="4"
  weight=".006" rank="3"/>
  </Details>
```

```

101817 Divorc.      2      <Details algorithm="Support Vector Machines" class="0">
                                <Attribute name="YRS_RESIDENCE" actualValue="8"
                                weight=".018" rank="1"/>
                                <Attribute name="EDUCATION" actualValue="PhD" weight=".007"
                                rank="2"/>
                                <Attribute name="CUST_INCOME_LEVEL" actualValue="K:
                                250\,000 - 299\,999" weight=".006" rank="3"/>
                                </Details>

101713 Mabsent      1

101790 Married      1      <Details algorithm="Support Vector Machines" class="0">
                                <Attribute name="COUNTRY_NAME" actualValue="Canada"
                                weight=".063" rank="1"/>
                                <Attribute name="EDUCATION" actualValue="7th-8th"
                                weight=".011" rank="2"/>
                                <Attribute name="HOUSEHOLD_SIZE" actualValue="4-5"
                                weight=".011" rank="3"/>
                                </Details>

. . .

```

## 38.17 PREDICTION\_SET

### Syntax

***prediction\_set::=***

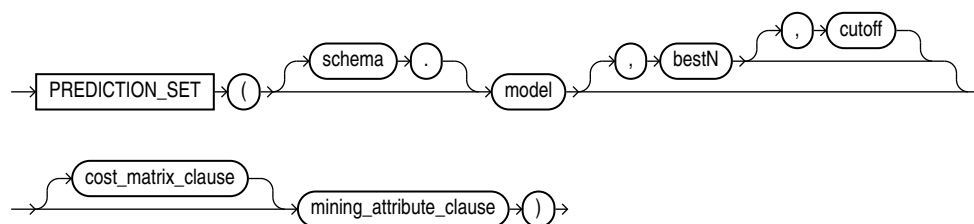

### Analytic Syntax

***prediction\_set\_analytic::=***

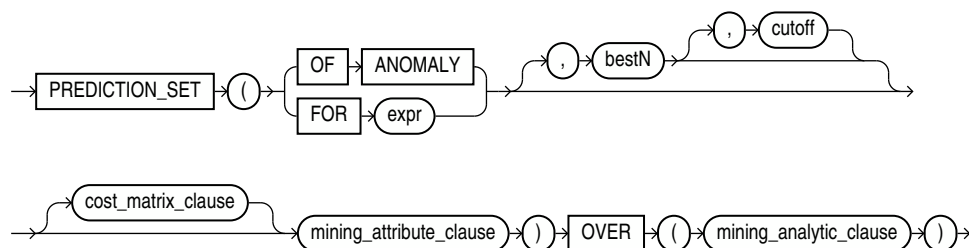



**cost\_matrix\_clause::=**

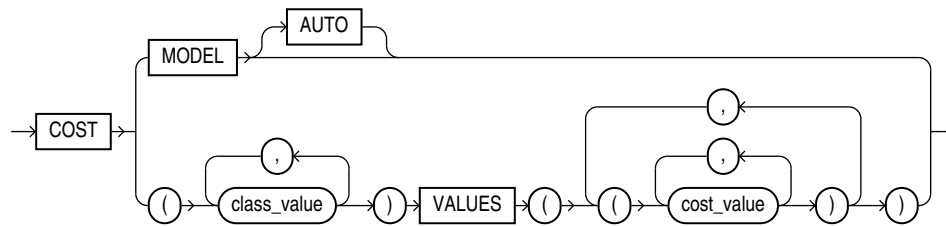

**mining\_attribute\_clause::=**

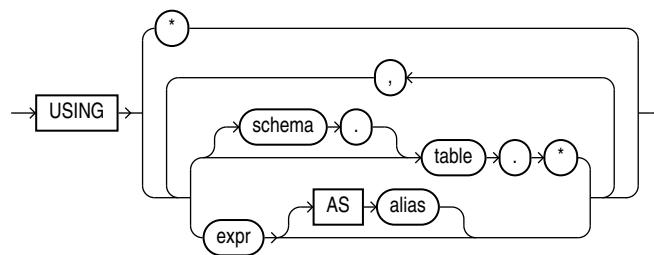

**mining\_analytic\_clause::=**

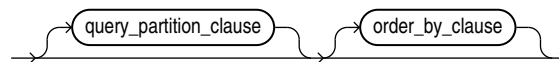

**See Also:**

"Analytic Functions" for information on the syntax, semantics, and restrictions of `mining_analytic_clause`

**Purpose**

`PREDICTION_SET` returns a set of predictions with either probabilities or costs for each row in the selection. The return value is a varray of objects with field names `PREDICTION_ID` and `PROBABILITY` or `COST`. The prediction identifier is an Oracle `NUMBER`; the probability and cost fields are `BINARY_DOUBLE`.

`PREDICTION_SET` can perform classification or anomaly detection. For classification, the return value refers to a predicted target class. For anomaly detection, the return value refers to a classification of 1 (for typical rows) or 0 (for anomalous rows).

**bestN and cutoff**

You can specify `bestN` and `cutoff` to limit the number of predictions returned by the function. By default, both `bestN` and `cutoff` are null and all predictions are returned.

- *bestN* is the *N* predictions that are either the most probable or the least costly. If multiple predictions share the *N*th probability or cost, then the function chooses one of them.
- *cutoff* is a value threshold. Only predictions with probability greater than or equal to *cutoff*, or with cost less than or equal to *cutoff*, are returned. To filter by *cutoff* only, specify NULL for *bestN*. If the function uses a *cost\_matrix\_clause* with COST MODEL AUTO, then *cutoff* is ignored.

You can specify *bestN* with *cutoff* to return up to the *N* most probable predictions that are greater than or equal to *cutoff*. If costs are used, specify *bestN* with *cutoff* to return up to the *N* least costly predictions that are less than or equal to *cutoff*.

### cost\_matrix\_clause

You can specify *cost\_matrix\_clause* as a biasing factor for minimizing the most harmful kinds of misclassifications. *cost\_matrix\_clause* behaves as described for "PREDICTION\_COST".

### Syntax Choice

PREDICTION\_SET can score the data in one of two ways: It can apply a mining model object to the data, or it can dynamically mine the data by executing an analytic clause that builds and applies one or more transient mining models. Choose **Syntax** or **Analytic Syntax**:

- **Syntax** — Use the first syntax to score the data with a pre-defined model. Supply the name of a model that performs classification or anomaly detection.
- **Analytic Syntax** — Use the analytic syntax to score the data without a pre-defined model. The analytic syntax uses *mining\_analytic\_clause*, which specifies if the data should be partitioned for multiple model builds. The *mining\_analytic\_clause* supports a *query\_partition\_clause* and an *order\_by\_clause*. (See "analytic\_clause::".)
  - For classification, specify FOR *expr*, where *expr* is an expression that identifies a target column that has a character data type.
  - For anomaly detection, specify the keywords OF ANOMALY.

The syntax of the PREDICTION\_SET function can use an optional GROUPING hint when scoring a partitioned model. See GROUPING Hint.

### mining\_attribute\_clause

*mining\_attribute\_clause* identifies the column attributes to use as predictors for scoring. When the function is invoked with the analytic syntax, these predictors are also used for building the transient models. The *mining\_attribute\_clause* behaves as described for the PREDICTION function. (See "mining\_attribute\_clause".)

#### See Also:

- *Oracle Data Mining User's Guide* for information about scoring.
- *Oracle Data Mining Concepts* for information about predictive data mining.

 **Note:**

The following example is excerpted from the Data Mining sample programs. For more information about the sample programs, see Appendix A in *Oracle Data Mining User's Guide*.

**Example**

This example lists the probability and cost that customers with ID less than 100006 will use an affinity card. This example has a binary target, but such a query is also useful for multiclass classification such as low, medium, and high.

```
SELECT T.cust_id, S.prediction, S.probability, S.cost
FROM (SELECT cust_id,
             PREDICTION_SET(dt_sh_clas_sample COST MODEL USING *) pset
      FROM mining_data_apply_v
      WHERE cust_id < 100006) T,
     TABLE(T.pset) S
ORDER BY cust_id, S.prediction;
```

CUST_ID	PREDICTION	PROBABILITY	COST
100001	0	.966183575	.270531401
100001	1	.033816425	.966183575
100002	0	.740384615	2.076923077
100002	1	.259615385	.740384615
100003	0	.909090909	.727272727
100003	1	.090909091	.909090909
100004	0	.909090909	.727272727
100004	1	.090909091	.909090909
100005	0	.272357724	5.821138211
100005	1	.727642276	.272357724