

# Oracle® Multimedia

## DICOM Developer's Guide



12c Release 12 (12.2)

E85858-01

July 2017

The Oracle logo, consisting of a solid red square with the word "ORACLE" in white, uppercase, sans-serif font centered within it.

ORACLE®

Oracle Multimedia DICOM Developer's Guide, 12c Release 12 (12.2)

E85858-01

Copyright © 2007, 2017, Oracle and/or its affiliates. All rights reserved.

Primary Author: Sue Pelski

Contributors: Rob Abbott, Melliya Annamalai, Susan Mavris, Valarie Moore, David Noblet, James Steiner, Jean Wilson, Manjari Yalavathy, Jie Zhang

This software and related documentation are provided under a license agreement containing restrictions on use and disclosure and are protected by intellectual property laws. Except as expressly permitted in your license agreement or allowed by law, you may not use, copy, reproduce, translate, broadcast, modify, license, transmit, distribute, exhibit, perform, publish, or display any part, in any form, or by any means. Reverse engineering, disassembly, or decompilation of this software, unless required by law for interoperability, is prohibited.

The information contained herein is subject to change without notice and is not warranted to be error-free. If you find any errors, please report them to us in writing.

If this is software or related documentation that is delivered to the U.S. Government or anyone licensing it on behalf of the U.S. Government, then the following notice is applicable:

U.S. GOVERNMENT END USERS: Oracle programs, including any operating system, integrated software, any programs installed on the hardware, and/or documentation, delivered to U.S. Government end users are "commercial computer software" pursuant to the applicable Federal Acquisition Regulation and agency-specific supplemental regulations. As such, use, duplication, disclosure, modification, and adaptation of the programs, including any operating system, integrated software, any programs installed on the hardware, and/or documentation, shall be subject to license terms and license restrictions applicable to the programs. No other rights are granted to the U.S. Government.

This software or hardware is developed for general use in a variety of information management applications. It is not developed or intended for use in any inherently dangerous applications, including applications that may create a risk of personal injury. If you use this software or hardware in dangerous applications, then you shall be responsible to take all appropriate fail-safe, backup, redundancy, and other measures to ensure its safe use. Oracle Corporation and its affiliates disclaim any liability for any damages caused by use of this software or hardware in dangerous applications.

Oracle and Java are registered trademarks of Oracle and/or its affiliates. Other names may be trademarks of their respective owners.

Intel and Intel Xeon are trademarks or registered trademarks of Intel Corporation. All SPARC trademarks are used under license and are trademarks or registered trademarks of SPARC International, Inc. AMD, Opteron, the AMD logo, and the AMD Opteron logo are trademarks or registered trademarks of Advanced Micro Devices. UNIX is a registered trademark of The Open Group.

This software or hardware and documentation may provide access to or information about content, products, and services from third parties. Oracle Corporation and its affiliates are not responsible for and expressly disclaim all warranties of any kind with respect to third-party content, products, and services unless otherwise set forth in an applicable agreement between you and Oracle. Oracle Corporation and its affiliates will not be responsible for any loss, costs, or damages incurred due to your access to or use of third-party content, products, or services, except as set forth in an applicable agreement between you and Oracle.

# Contents

## Preface

---

Audience	xviii
Documentation Accessibility	xviii
Related Documents	xix
Conventions	xx
Syntax Descriptions	xx

## Changes in This Release for Oracle Multimedia DICOM Developer's Guide

---

Changes in Oracle Database 12c Release 2 (12.2)	xxi
---	-----

## Part I DICOM Common Usage and Reference

---

### 1 Introduction to Oracle Multimedia DICOM

---

1.1 Medical Imaging and Communication	1-1
1.1.1 History of the DICOM Standard	1-2
1.1.2 Overview of DICOM Content	1-2
1.2 Oracle Multimedia and DICOM	1-3
1.2.1 Oracle Multimedia DICOM Format Support	1-3
1.2.2 DICOM Database Network Component for the DICOM Protocol Adapter	1-4
1.2.3 Storing DICOM Content	1-4
1.2.4 DICOM Metadata Extraction	1-4
1.2.5 DICOM Conformance Validation	1-4
1.2.6 DICOM Image Processing	1-5
1.2.7 Making Confidential Data in DICOM Content Anonymous	1-5
1.2.8 Creating ORDDicom Objects from Images or Video and Metadata	1-5
1.2.9 Run-Time, Updatable DICOM Data Model	1-6

## 2 Oracle Multimedia DICOM Concepts

---

2.1	Oracle Multimedia DICOM Architecture	2-1
2.2	Oracle Multimedia DICOM Storage	2-3
2.3	Model-Driven Design	2-4
2.4	DICOM Data Model Repository	2-5
2.4.1	Configuration Documents in the Repository	2-6
2.4.2	Administrator and User Sessions in the Repository	2-8
2.4.3	DICOM Data Model Repository in a CDB	2-10
2.5	Extraction of Metadata from DICOM Content	2-11
2.5.1	Overview of the Metadata Extraction and XML Mapping Process	2-11
2.5.2	Sample XML Documents Used in the Extraction and Mapping Process	2-14
2.6	Validation of DICOM Content	2-15
2.7	Image Conversion and Creation of New DICOM Content	2-16
2.8	Making DICOM Content Anonymous	2-18
2.9	Extraction of DICOM Metadata for Partitioning	2-19

## 3 Overview of DICOM Development

---

3.1	The DICOM Development Environment	3-1
3.1.1	APIs for Use With Oracle Multimedia DICOM	3-1
3.1.2	Views in the DICOM Repository	3-2
3.2	DICOM Developer and Administrator Tasks	3-3
3.2.1	Task 1: Load the Repository	3-3
3.2.2	Task 2: Load the DICOM Content	3-4
3.2.3	Task 3: Extract the DICOM Metadata	3-4
3.2.3.1	Extracting Metadata: Administrator Tasks	3-5
3.2.3.2	Extracting Metadata: Developer Tasks	3-6
3.2.4	Task 4: Search and Retrieve DICOM Attributes	3-6
3.2.5	Task 5: Write and Edit DICOM Metadata	3-7
3.2.6	Task 6: Process, Convert, and Compress DICOM Data	3-7
3.2.7	Task 7: Create DICOM Content from Secondary Capture Images and Video	3-8
3.2.8	Task 8: Validate Conformance with DICOM Constraints	3-9
3.2.8.1	Validating Conformance: Administrator Tasks	3-9
3.2.8.2	Validating Conformance: Developer Tasks	3-10
3.2.9	Task 9: Protect Confidential Patient Data	3-11
3.2.9.1	Protecting Privacy: Administrator Tasks	3-12
3.2.9.2	Protecting Privacy: Developer Tasks	3-12
3.2.10	Task 10: Improve Storage When Extracting DICOM Attributes	3-13

## 4 DICOM Protocol Support

---

4.1	Overview of DICOM Protocol Support for Oracle Database	4-2
4.2	Contents of the Oracle DICOM Protocol Adapter Suite	4-2
4.2.1	The Oracle DICOM Protocol Adapter	4-3
4.2.2	The Oracle DICOM Crawler	4-5
4.2.3	The Oracle DICOM WADO Proxy	4-5
4.3	Deploying the Oracle DICOM Protocol Adapter Suite	4-6
4.3.1	Deploying the Archive Files	4-7
4.3.2	Performing a Standard Deployment	4-8
4.3.3	Performing an Advanced Deployment	4-8
4.3.4	Modifying the Component Archive Files	4-10
4.3.4.1	Modifying the DICOM Adapter Archive File	4-10
4.3.4.2	Modifying the DICOM Crawler Archive File	4-10
4.3.4.3	Modifying the DICOM WADO Proxy Archive File	4-11
4.4	Configuring the Oracle DICOM Protocol Adapter	4-11
4.4.1	Configuring the Oracle DICOM Protocol Adapter	4-11
4.4.2	Configuring the Oracle DICOM Crawler	4-17
4.4.3	Configuring the Oracle DICOM WADO Proxy	4-20
4.5	Configuring DICOM Protocol Support for Oracle Database	4-22
4.6	Image Versioning with the DICOM Protocol Adapter	4-23
4.7	Extracting Private Attributes from DICOM Data with the DICOM Protocol Adapter	4-23
4.8	Improving DICOM Metadata Extraction for BLOB Storage	4-24

## 5 DICOM Data Model Utility Reference

---

5.1	Directory Definition and Setup for ORD_DICOM Examples	5-1
5.2	DICOM Data Model Utility Functions	5-2
5.2.1	getDictionaryTag( ) Function	5-2
5.2.2	getMappingXPath( ) Function	5-3
5.3	DICOM Data Model Utility Procedures	5-5
5.3.1	setDataModel( ) Procedure	5-5
5.4	DICOM Repository Public Views	5-6
5.4.1	orddcm_conformance_vld_msgs	5-6
5.4.2	orddcm_constraint_names	5-7
5.4.3	orddcm_documents	5-8
5.4.4	orddcm_document_types	5-9

## Part II DICOM Development Usage and Reference

---

## 6 DICOM Application Development

---

6.1	Setting Up Your Environment	6-1
6.2	Creating a Table with an ORDDicom Column	6-2
6.3	Loading DICOM Content Using the SQL*Loader Utility	6-3
6.4	Developing DICOM Applications Using the PL/SQL API	6-7
6.4.1	Selecting DICOM Attributes	6-8
6.4.2	Creating Thumbnail Images and Changing Image Formats	6-9
6.4.3	Making Anonymous Copies of ORDDicom Objects	6-10
6.4.4	Checking the Conformance of ORDDicom Objects	6-12
6.4.5	Handling Oracle Multimedia DICOM Exceptions in PL/SQL	6-13

## 7 DICOM PL/SQL API Reference

---

7.1	Examples for DICOM PL/SQL API Functions and Procedures	7-1
7.1.1	Directory Definition and Setup for DICOM PL/SQL API Examples	7-2
7.1.2	MEDICAL_IMAGE_REL Table Definition	7-2
7.2	DICOM PL/SQL API Functions	7-2
7.2.1	extractMetadata() for BFILES	7-3
7.2.2	extractMetadata() for BLOBs	7-4
7.2.3	extractMetadata() for ORDImage	7-5
7.2.4	isAnonymous() for BFILES	7-6
7.2.5	isAnonymous() for BLOBs	7-7
7.2.6	isAnonymous() for ORDImage	7-8
7.2.7	isConformanceValid() for BFILES	7-9
7.2.8	isConformanceValid() for BLOBs	7-10
7.2.9	isConformanceValid() for ORDImage	7-11
7.3	DICOM PL/SQL API Procedures	7-12
7.3.1	createDicomImage() for BFILES	7-13
7.3.2	createDicomImage() for BLOBs	7-14
7.3.3	createDicomImage() for ORDImage	7-15
7.3.4	export()	7-17
7.3.5	importFrom()	7-18
7.3.6	makeAnonymous() for BFILES	7-19
7.3.7	makeAnonymous() for BLOBs	7-20
7.3.8	makeAnonymous() for ORDImage	7-21
7.3.9	processCopy() for BFILES	7-22
7.3.10	processCopy() for BFILES with SOP Instance UID	7-23
7.3.11	processCopy() for BLOBs	7-25
7.3.12	processCopy() for BLOBs with SOP Instance UID	7-26
7.3.13	processCopy() for ORDImage	7-27
7.3.14	processCopy() for ORDImage with SOP Instance UID	7-28

7.3.15	writeMetadata() for BFILES	7-30
7.3.16	writeMetadata() for BLOBs	7-31
7.3.17	writeMetadata() for ORDImage	7-32

## 8 ORDDicom Object Type Reference

---

8.1	ORDDicom Object Examples	8-1
8.1.1	Directory Definition and Setup for ORDDicom Object Examples	8-2
8.1.2	MEDICAL_IMAGE_OBJ Table Definition	8-2
8.2	ORDDicom Object Type	8-3
8.3	ORDDicom Constructors	8-3
8.3.1	ORDDicom() for BLOBs	8-4
8.3.2	ORDDicom() for ORDImage	8-5
8.3.3	ORDDicom() for Other Sources	8-6
8.4	ORDDicom Methods	8-7
8.4.1	export()	8-8
8.4.2	extractMetadata()	8-9
8.4.3	getAttributeByName()	8-10
8.4.4	getAttributeByTag()	8-11
8.4.5	getContent()	8-12
8.4.6	getContentLength()	8-13
8.4.7	getSeriesInstanceUID()	8-14
8.4.8	getSOPClassUID()	8-14
8.4.9	getSOPInstanceUID()	8-15
8.4.10	getSourceInformation()	8-15
8.4.11	getSourceLocation()	8-16
8.4.12	getSourceName()	8-16
8.4.13	getSourceType()	8-17
8.4.14	getStudyInstanceUID()	8-18
8.4.15	import()	8-18
8.4.16	isAnonymous()	8-19
8.4.17	isConformanceValid()	8-20
8.4.18	isLocal()	8-21
8.4.19	makeAnonymous()	8-22
8.4.20	processCopy() to BLOBs	8-23
8.4.21	processCopy() to ORDDicom	8-24
8.4.22	processCopy() to ORDImage	8-26
8.4.23	setProperties()	8-27
8.4.24	writeMetadata()	8-28

### 9 Overview of DICOM Administration

---

9.1	Assigning Administrator Roles and Privileges	9-2
9.2	Managing XML Schemas	9-3
9.2.1	Registering XML Schemas	9-3
9.2.2	Finding User-Defined XML Schemas	9-4
9.3	Loading the Data Model Repository	9-5
9.4	Managing the Impact of Oracle Data Guard Rolling Upgrades	9-5
9.5	Browsing the Repository with Views	9-6
9.6	Exporting Documents from the Repository	9-6
9.7	Inserting Documents into the Repository	9-7
9.7.1	Inserting Anonymity, Mapping, and Constraint Documents	9-7
9.7.2	Inserting Dictionary Documents	9-7
9.7.3	Inserting Preference and UID Definition Documents	9-8
9.7.4	Inserting Stored Tag List Documents	9-8
9.7.5	Inserting DICOM Protocol Documents	9-9
9.8	Updating Documents in the Repository	9-9
9.8.1	Updating Anonymity, Mapping, and Constraint Documents	9-10
9.8.2	Updating Dictionary Documents	9-10
9.8.3	Updating Preference and UID Definition Documents	9-10
9.9	Deleting Documents from the Repository	9-11
9.9.1	Deleting Anonymity, Mapping, and Constraint Documents	9-11
9.9.2	Deleting Dictionary Documents	9-11
9.9.3	Deleting Preference and UID Definition Documents	9-11
9.10	Oracle Data Pump Utilities Support for Oracle Multimedia DICOM	9-12
9.10.1	Roles for Export and Import Operations	9-12
9.10.2	Mode for Export and Import Operations	9-13
9.10.2.1	Exporting in Full Mode	9-13
9.10.2.2	Importing in Full Mode	9-13

### 10 Creating DICOM Configuration Documents

---

10.1	Characteristics of Configuration Documents	10-2
10.1.1	Characteristics of Anonymity Documents	10-3
10.1.2	Characteristics of Constraint Documents	10-3
10.1.3	Characteristics of DICOM Protocol Documents	10-3
10.1.4	Characteristics of Mapping Documents	10-4
10.1.5	Characteristics of Preference Documents	10-4
10.1.6	Characteristics of Private Dictionary Documents	10-5



10.1.7	Characteristics of Standard Dictionary Documents	10-5
10.1.8	Characteristics of Stored Tag List Documents	10-5
10.1.9	Characteristics of UID Definition Documents	10-5
10.2	Writing Configuration Documents	10-6
10.2.1	Creating Anonymity Documents	10-6
10.2.1.1	Making Standard Attributes Anonymous	10-9
10.2.1.2	Making Undefined Standard Attributes Anonymous	10-9
10.2.1.3	Making Selected Private Attributes Anonymous	10-9
10.2.1.4	Making All Private Attributes Anonymous	10-10
10.2.1.5	Using DICOM Value Locators in Anonymity Documents	10-11
10.2.2	Creating Constraint Documents	10-12
10.2.2.1	Defining a Simple Constraint Rule	10-14
10.2.2.2	Defining Constraint Rules by Importing Other Constraint Rules	10-16
10.2.2.3	Defining and Referencing Constraint Macros	10-17
10.2.2.4	Defining Recursive Constraint Macros	10-19
10.2.2.5	Using DICOM Value Locators in Constraint Documents	10-24
10.2.3	Creating DICOM Protocol Documents	10-27
10.2.4	Creating Mapping Documents and Metadata XML Schemas	10-29
10.2.4.1	Structure of a Mapping Document	10-29
10.2.4.2	Structure of a Metadata XML Schema	10-30
10.2.4.3	Creating a Mapping Document for Metadata with No Schema Constraints	10-31
10.2.4.4	Creating a Mapping Document for Metadata with Schema Constraints and a Mapped Section Only	10-33
10.2.4.5	Creating a Mapping Document for Metadata with Schema Constraints	10-37
10.2.4.6	Using DICOM Value Locators in Mapping Documents	10-42
10.2.5	Creating Preference Documents	10-44
10.2.5.1	Defining the BINARY_SKIP_INVALID_ATTR Preference Parameter	10-45
10.2.5.2	Defining the CONFORMANCE_LEVEL Preference Parameter	10-45
10.2.5.3	Defining the EXP_IF_NULL_ATTR_IN_CONSTRAINT Preference Parameter	10-46
10.2.5.4	Defining the IGNORED_EXP_LIST Preference Parameter	10-47
10.2.5.5	Defining the MANDATE_ATTR_TAGS_IN_STL Preference Parameter	10-47
10.2.5.6	Defining the MAX_RECURSION_DEPTH Preference Parameter	10-48
10.2.5.7	Defining the SPECIFIC_CHARACTER_SET Preference Parameter	10-48
10.2.5.8	Defining the SQ_WRITE_LEN Preference Parameter	10-49
10.2.5.9	Defining the VALIDATE_METADATA Preference Parameter	10-50
10.2.5.10	Defining the XML_SKIP_ATTR Preference Parameter	10-51
10.2.6	Creating Private Dictionary Documents	10-51

10.2.6.1	Defining Private Attributes	10-52
10.2.6.2	Defining Attribute Definers	10-54
10.2.6.3	Retiring Private Attributes	10-55
10.2.7	Creating Standard Dictionary Documents	10-55
10.2.7.1	Defining Standard Attributes	10-56
10.2.7.2	Retiring Standard Attributes	10-57
10.2.8	Creating Stored Tag List Documents	10-57
10.2.9	Creating UID Definition Documents	10-58
10.2.9.1	Defining UID Definitions	10-59
10.2.9.2	Retiring UID Definitions	10-59

## 11 Administering the DICOM Repository

---

11.1	Sample Session 1: Inserting Two Documents	11-1
11.2	Sample Session 2: Updating a Mapping Document	11-3
11.3	Sample Session 3: Deleting a Constraint Document	11-4
11.4	Sample Session 4: Inserting a Stored Tag List Document	11-5
11.4.1	Inserting a Stored Tag List Document with a Known Set of Tags	11-6
11.4.2	Generating and Inserting a Stored Tag List Document	11-7
11.5	Sample Session 5: Inserting a DICOM Protocol Document	11-10

## 12 ORD\_DICOM\_ADMIN Package Reference

---

12.1	Directory Definition and Setup for ORD_DICOM_ADMIN Examples	12-2
12.2	Important Notes for DICOM Repository Administrators	12-2
12.3	DICOM Data Model Repository Administrator Functions	12-2
12.3.1	generateTagListDocument( ) Function	12-2
12.3.2	getDocumentContent( ) Function	12-3
12.4	DICOM Data Model Repository Administrator Procedures	12-4
12.4.1	deleteDocument( ) Procedure	12-5
12.4.2	editDataModel( ) Procedure	12-6
12.4.3	exportDocument( ) Procedure	12-6
12.4.4	insertDocument( ) Procedure	12-7
12.4.5	publishDataModel( ) Procedure	12-9
12.4.6	rollbackDataModel( ) Procedure	12-10
12.5	DICOM Repository Administrator Views	12-11
12.5.1	orddcm_document_refs	12-11
12.6	General Format for DICOM Value Locators	12-12
12.6.1	Syntax	12-12
12.6.1.1	value_locator::=	12-12
12.6.1.2	sublocator::=	12-12

12.6.2	Description	12-12
12.6.3	Parameters	12-13
12.6.4	Examples	12-15
12.6.4.1	DICOM Value Locator Example 1	12-15
12.6.4.2	DICOM Value Locator Example 2	12-15
12.6.4.3	DICOM Value Locator Example 3	12-16
12.6.4.4	DICOM Value Locator Example 4	12-16
12.6.4.5	DICOM Value Locator Example 5	12-16
12.6.4.6	DICOM Value Locator Example 6	12-16

## Part IV DICOM Supplementary Information

---

### A DICOM Configuration Documents

---

### B DICOM XML Schemas

---

### C DICOM Encoding Rules

---

### D DICOM Processing and Supported Formats

---

D.1	DICOM Image Content and Compression Formats	D-1
D.1.1	DEFLATE Compression Format	D-3
D.1.2	JPEG-LOSSLESS Compression Format	D-4
D.1.3	JPEG-LS Compression Format	D-4
D.1.4	MPEG Compression Format	D-4
D.1.5	RLE Compression Format	D-4
D.2	The frame Image Processing Operator	D-4
D.3	Other Image Processing Operators	D-5
D.4	Multiframe Image Processing and Creation	D-5
D.5	Multiframe DICOM Content Processing to AVI Format	D-5
D.6	Order of Precedence with processCopy( ) Method Arguments	D-6

### E DICOM Sample Applications

---

### Glossary

---

# Index

---

## List of Examples

---

2-1	Sample XML Mapping Document	2-14
2-2	Sample XML Metadata Document	2-15
2-3	Sample Constraint Document	2-16
2-4	Sample Anonymity Document	2-18
3-1	Constraint Rule for the Patient Module	3-10
4-1	Sample XML File for Advanced Deployment	4-9
4-2	ordim_adapter_config.xsd Schema	4-13
4-3	ordim_common.xsd Schema	4-14
4-4	ordim_crawler_config.xsd Schema	4-19
4-5	ordim_wado_config.xsd Schema	4-21
6-1	Creating a Table for DICOM Content	6-2
6-2	Loading DICOM Content	6-5
6-3	Finish Loading and Initializing the DICOM Table	6-6
6-4	Selecting Metadata from the DICOM Content	6-8
6-5	Generating and Processing the New ORDImage Object	6-10
6-6	Populating the Column and Generating an Anonymous ORDDicom Object	6-11
6-7	Checking DICOM Conformance	6-13
9-1	Finding User-Registered XML Schemas	9-4
9-2	Full Mode Export	9-13
9-3	Full Mode Import	9-14
10-1	Making a Standard Attribute Anonymous	10-9
10-2	Removing All Undefined Standard Attributes	10-9
10-3	Making a Private Attribute Anonymous	10-10
10-4	Removing All Private Attributes	10-11
10-5	Removing All Undefined Private Attributes	10-11
10-6	Including Defined Private Attributes and Removing Undefined Private Attributes	10-11
10-7	Removing Defined Private Attributes and Including Undefined Private Attributes	10-11
10-8	Simple DICOM Value Locator in an Anonymity Document	10-12
10-9	DICOM Value Locator with a Wildcard Character in an Anonymity Document	10-12
10-10	Predicate for One Condition on SOP Class UID	10-15
10-11	Predicate for One Condition on SOP Instance UID	10-15
10-12	Predicate for Two Conditions	10-15
10-13	Global Rule for Two Boolean Functions	10-15
10-14	Global Rule for Two Conditions on Patient's Sex	10-16
10-15	Global Rule for a Logical Relation	10-17

10-16	External Rule for Three Constraint Rules	10-17
10-17	Global Macro for a Condition	10-18
10-18	Global Rule with a Constraint Macro	10-18
10-19	One Constraint Macro with Recursion	10-22
10-20	Two Constraint Macros with Recursion	10-23
10-21	DICOM Value Locator with a Wildcard Character in a Constraint Macro	10-25
10-22	DICOM Value Locator with a Special Wildcard Tag in a Global Rule	10-26
10-23	Sample DICOM Protocol Configuration Document	10-28
10-24	Sample Mapping Document for Metadata with No Schema Constraints	10-32
10-25	Resulting XML Document for Metadata with No Schema Constraints	10-33
10-26	Sample Mapping Document for Metadata with Schema Constraints and a Mapped Section Only	10-34
10-27	Sample XML Schema for Metadata with Schema Constraints and a Mapped Section	10-35
10-28	Resulting XML Document for Metadata with Schema Constraints and a Mapped Section	10-37
10-29	Sample Mapping Document for Metadata with Schema Constraints	10-38
10-30	Sample XML Schema for Metadata with Schema Constraints	10-39
10-31	Resulting XML Document for Metadata with Schema Constraints (MAPPED)	10-40
10-32	Resulting XML Document for Metadata with Schema Constraints (ALL)	10-41
10-33	DICOM Value Locator for an Attribute with Unibyte Encoding in a Mapping Document	10-44
10-34	DICOM Value Locator for an Embedded Sequence Attribute in a Mapping Document	10-44
10-35	DICOM Value Locator for a Single Attribute Value in a Mapping Document	10-44
10-36	Definition of the BINARY_SKIP_INVALID_ATTR Preference Parameter	10-45
10-37	Definition of the CONFORMANCE_LEVEL Preference Parameter	10-46
10-38	Definition of the EXP_IF_NULL_ATTR_IN_CONSTRAINT Preference Parameter	10-47
10-39	Definition of the IGNORED_EXP_LIST Preference Parameter	10-47
10-40	Definition of the MANDATE_ATTR_TAGS_IN_STL Preference Parameter	10-48
10-41	Definition of the MAX_RECURSION_DEPTH Preference Parameter	10-48
10-42	Definition of the SPECIFIC_CHARACTER_SET Preference Parameter	10-49
10-43	Definition of the SQ_WRITE_LEN Preference Parameter	10-50
10-44	Definition of the VALIDATE_METADATA Preference Parameter	10-51
10-45	Definition of the XML_SKIP_ATTR Preference Parameter	10-51
10-46	Definition of a Private Attribute with a Simple Attribute Tag	10-54
10-47	Definition of a Private Attribute with a Wildcard Attribute Tag	10-54
10-48	Definition of a Private Attribute with a Range Attribute Tag	10-54
10-49	Definition of an Attribute Definer	10-55
10-50	Definition of a Private Attribute as Retired	10-55
10-51	Definition of a Standard Attribute with a Simple Attribute Tag	10-57

10-52	Definition of a Standard Attribute with a Wildcard Attribute Tag	10-57
10-53	Definition of a Standard Attribute As Retired	10-57
10-54	Definition of a Storage Class UID Definition	10-59
10-55	Definition of a UID Definition as Retired	10-59
11-1	Inserting a Stored Tag List Document with Known Attribute Tags	11-7
11-2	Sample Preference Document for the Mandate Attribute Tags Rule	11-9
11-3	Generating and Exporting a Stored Tag List Document to a File	11-9

## List of Figures

---

2-1	Oracle Multimedia DICOM Architecture	2-2
2-2	ORDDicom Object	2-3
2-3	Table in a Medical Image Database	2-4
2-4	DICOM Model-Based Parsing Details	2-5
2-5	DICOM Data Model Repository	2-10
2-6	DICOM Metadata Extraction and XML Mapping	2-12
2-7	Image Conversion Process	2-17
4-1	DICOM Protocol Adapter Interacting with Other Components	4-4
4-2	DICOM Crawler Exchanging Messages with Other Components	4-5
4-3	DICOM WADO Proxy Retrieving DICOM Images	4-6



## List of Tables

---

2-1	DICOM Configuration Documents and Their XML Schemas	2-6
3-1	Application Programming Interfaces for DICOM	3-2
3-2	DICOM Repository Views	3-2
4-1	Roadmap for More DICOM Protocol Documentation in This Guide	4-1
4-2	Components in the DICOM Protocol Adapter Suite	4-3
4-3	DICOM Protocol Adapter Message Handling Commands	4-4
10-1	action Attribute Values	10-6
10-2	Global Action Elements	10-8
A-1	DICOM Configuration Documents	A-1
B-1	DICOM XML Schemas	B-1
C-1	Encoding Rules for Transfer Syntax	C-1
D-1	DICOM Content Photometric Interpretations	D-1
D-2	DICOM Content Compression Formats	D-2
E-1	Oracle Multimedia DICOM Sample Programs	E-1

# Preface

This guide describes how to use the Digital Imaging and Communications in Medicine (DICOM) feature of Oracle Multimedia, which ships with Oracle Database.

In Oracle Database 11g Release 1 (11.1), the name Oracle *interMedia* was changed to Oracle Multimedia. The feature remains the same, only the name has changed.

This information in this guide is organized as follows:

Title	Contents
Part I, "DICOM Common Usage and Reference"	Introductory, conceptual, user, and reference information, which is common to administrators and developers of DICOM applications
Part II, "DICOM Development Usage and Reference"	User and reference information for developers of DICOM applications
Part III, "DICOM Administration Usage and Reference"	User and reference information for administrators of the DICOM data model repository
Part IV, "DICOM Supplementary Information"	Additional information about Oracle Multimedia DICOM

The sample code in this guide might not match the code shipped with Oracle Database Examples media. To run examples that are shipped with Oracle Database Examples media on your system, use the files provided with Oracle Database Examples media. Do not attempt to compile and run the code in this guide.

For information about Oracle Database and the features and options that are available to you, see *Oracle Database New Features Guide*.

## Audience

This guide is for application developers and administrators who are interested in storing, retrieving, and manipulating DICOM format medical images and other objects in a database.

## Documentation Accessibility

For information about Oracle's commitment to accessibility, visit the Oracle Accessibility Program website at <http://www.oracle.com/pls/topic/lookup?ctx=acc&id=docacc>.

### Access to Oracle Support

Oracle customers that have purchased support have access to electronic support through My Oracle Support. For information, visit <http://www.oracle.com/pls/topic/>

[lookup?ctx=acc&id=info](http://www.oracle.com/pls/topic/lookup?ctx=acc&id=info) or visit <http://www.oracle.com/pls/topic/lookup?ctx=acc&id=trs> if you are hearing impaired.

## Related Documents

### Note:

For information added after the release of this guide, see the online `README.txt` file under your `<ORACLE_HOME>` directory. Depending on your operating system, this file may be in

```
<ORACLE_HOME>/ord/im/admin/README.txt
```

See your operating system-specific installation guide for more information.

For more information about using Oracle Multimedia in a development environment, see the following documents in the Oracle Database Online Documentation Library:

- *Oracle Multimedia Reference*
- *Oracle Multimedia User's Guide*
- *Oracle Call Interface Programmer's Guide*
- *Oracle Database Development Guide*
- *Oracle Database SecureFiles and Large Objects Developer's Guide*
- *Oracle Database Concepts*
- *Oracle Database PL/SQL Language Reference*
- *Oracle Database SQL Language Reference*
- *Oracle Database Error Messages*
- *Oracle Database Java Developer's Guide*
- *Oracle Database JDBC Developer's Guide*

For more information about using XML, see *Oracle XML DB Developer's Guide*.

For more information about medical imaging standards, see the documentation provided by the National Electrical Manufacturers Association (NEMA).

For more information about Oracle WebLogic Server, see the following documents in the Oracle Fusion Middleware Online Documentation Library:

- *Oracle Fusion Middleware Deploying Applications to Oracle WebLogic Server*
- *Oracle Fusion Middleware Understanding Oracle WebLogic Server*

For reference information about Oracle Multimedia Java classes in Javadoc format, see the following Oracle API documentation (also known as Javadoc) in the Oracle Database Online Documentation Library:

- *Oracle Multimedia DICOM Java API Reference (Deprecated)*
- *Oracle Multimedia Java API Reference (Deprecated)*
- *Oracle Multimedia Servlets and JSP Java API Reference (Deprecated)*

- *Oracle Multimedia Mid-Tier Java API Reference* (Deprecated)

For more information about Java, see the API documentation provided by Oracle.

## Conventions

The following text conventions are used in this guide:

Convention	Meaning
<b>boldface</b>	Boldface type indicates graphical user interface elements associated with an action, or terms defined in text or the glossary.
<i>italic</i>	Italic type indicates book titles, emphasis, or placeholder variables for which you supply particular values.
monospace	Monospace type indicates commands within a paragraph, URLs, code in examples, text that appears on the screen, or text that you enter.

## Syntax Descriptions

Syntax descriptions are provided in this guide for various SQL, PL/SQL, or other command-line constructs in graphic form or Backus Naur Form (BNF). See *Oracle Database SQL Language Reference* for information about how to interpret these descriptions.

# Changes in This Release for Oracle Multimedia DICOM Developer's Guide

This preface lists changes in *Oracle Multimedia DICOM Developer's Guide*.

## Changes in Oracle Database 12c Release 2 (12.2)

The following are changes in *Oracle Multimedia DICOM Developer's Guide* for Oracle Database 12c Release 2 (12.2).

### New Features

The following feature is new in this release:

- Oracle Multimedia PL/SQL API

This API allows metadata extraction and image processing operations to be more intuitively included in SQL and PL/SQL applications.

See *Oracle Multimedia Reference* for more information about the Oracle Multimedia PL/SQL API.

### Deprecated Features

The following feature is deprecated in this release, and may be desupported in a future release:

- Oracle Multimedia support for DICOM

# Part I

## DICOM Common Usage and Reference

This part contains introductory and conceptual information about the Oracle Multimedia DICOM feature. It also contains user and reference information that is common to administrators and developers of DICOM applications.

This part includes these chapters:

- [Introduction to Oracle Multimedia DICOM](#)
- [Oracle Multimedia DICOM Concepts](#)
- [Overview of DICOM Development](#)
- [DICOM Protocol Support](#)
- [DICOM Data Model Utility Reference](#)

# 1

## Introduction to Oracle Multimedia DICOM

This chapter contains background information about medical imaging, and provides a general introduction to the Oracle Multimedia DICOM (formerly Oracle *interMedia* DICOM) feature.

This chapter includes these sections:

- [Medical Imaging and Communication](#)
- [Oracle Multimedia and DICOM](#)

### 1.1 Medical Imaging and Communication

[Digital Imaging and Communications in Medicine \(DICOM\)](#) is a medical imaging standard that was initiated by the American College of Radiology (ACR) and the National Electrical Manufacturers Association (NEMA) to enhance the connectivity of radiological devices. Before the [DICOM standard](#) became widely adopted, each manufacturer had its own proprietary image format and communication protocol. This proliferation of formats and protocols made it almost impossible to produce third-party software to manage or study medical content, or to connect hardware devices from different manufacturers.

For the most part, the DICOM standard is developed by volunteers. Working groups formed by domain experts propose additions and changes to the existing standards, and the changes are approved by a balloting process. Typically, the National Electrical Manufacturers Association publishes a new version of the standard each year, and makes it available worldwide on its Web site. In addition, the Integrating the Healthcare Enterprise (IHE) initiative provides information about issues related to DICOM content and communication, and makes this information available on its Web site.

The following subsections provide introductory information about DICOM:

- [History of the DICOM Standard](#)
- [Overview of DICOM Content](#)

#### See Also:

- <http://medical.nema.org/> for more information about the DICOM standard
- <http://www.ihe.net/> for more information about DICOM content and communication
- <http://www.iso.org/> for more information about the OSI Model and other communication protocols

## 1.1.1 History of the DICOM Standard

In 1985, the American College of Radiology and the National Electrical Manufacturers Association jointly published the ACR-NEMA medical imaging and communication standard to address the proliferation problem. In 1993, the ACR-NEMA standard was revised and renamed as the DICOM standard (Version 3.0). Since the release of Version 3.0, the DICOM standard has become the dominant standard for radiology imaging and communication. All major manufacturers now conform to the DICOM standard.

Today, any software component can take [DICOM content](#) from any manufacturer and manage that content with a uniform interface. The term DICOM content refers to standalone DICOM Information Objects that are encoded according to the data structure and encoding definitions of PS 3.10 of the DICOM standard (commonly referred to as [DICOM Part 10 files](#)). (In the DICOM standard, the phrase *DICOM objects* refers to DICOM content.)

The DICOM standard has two major areas of focus: the file format and the communication protocol. Content such as images and waveforms captured by medical devices is represented as information objects. Services such as get, find, and store operations can be defined on these information objects. The combination of services and information objects is a service object pair ([SOP](#)).

The DICOM standard (Part 5 and Part 6) defines different types of [transfer syntax](#) (or binary encoding rules) for sending objects across the network or encoding objects in files. Transfer syntax specifies the mapping of a DICOM object hierarchy into a binary stream.

The binary data can be stored on physical media such as tapes, CDs, or disks, and organized in accordance with the DICOM file hierarchy. Binary data can also be exchanged over a network with the DICOM communication protocol. The DICOM communication protocol covers the upper three layers (Application, Presentation, and Session) of the Open Systems Interconnection (OSI) Seven Layer Model. The DICOM protocol is typically implemented on top of TCP/IP.

Messages exchanged between a DICOM server and a DICOM object involve operations such as these:

- Radiology workflow
- Grayscale image rendering
- Image printing
- Storage and retrieval

Recently, the DICOM standard (Part 18) introduced Web Access to DICOM Objects (WADO). [WADO](#) deals primarily with HTTP access to DICOM objects.

## 1.1.2 Overview of DICOM Content

DICOM content can include many different types of data, such as the following:

- Patient administration information
- Waveforms
- Images



- Slices of 3-D volumes
- Video segments
- Diagnostic reports
- Graphics
- Text annotations

DICOM content also contains standard attributes and private attributes. Standard attributes are defined and published in the DICOM standard. Private attributes are defined by and specific to private organizations, such as manufacturers and other enterprises. The DICOM data dictionary provides the definitions for DICOM standard and private attributes.

## 1.2 Oracle Multimedia and DICOM

The following subsections briefly introduce the support provided by the Digital Imaging and Communications in Medicine (DICOM) feature in Oracle Database:

- [Oracle Multimedia DICOM Format Support](#)
- [DICOM Database Network Component for the DICOM Protocol Adapter](#)
- [ORDDicom Object Type](#)
- [DICOM Metadata Extraction](#)
- [DICOM Conformance Validation](#)
- [DICOM Image Processing](#)
- [About Making Confidential Data in DICOM Content Anonymous](#)
- [About Creating ORDDicom Objects from Images or Video and Metadata](#)
- [Run-Time, Updatable DICOM Data Model](#)

### Note:

Oracle Multimedia DICOM supports the current version of the DICOM standard, PS 3.1-2011.

### 1.2.1 Oracle Multimedia DICOM Format Support

Oracle Multimedia provides full support for the DICOM file format, which is universally recognized as the standard for medical imaging. Applications can use Oracle Multimedia DICOM Java and PL/SQL APIs to store, manage, and manipulate DICOM content.

Customers can build large archives of medical content that are managed and secured using Oracle Database. Complete DICOM metadata support enables customers to index and search the archived DICOM content for research purposes. Central storage of DICOM content makes telemedicine practical. Incorporating DICOM content in a database enables customers to build electronic healthcare records applications, using application development tools from Oracle or others.

## 1.2.2 DICOM Database Network Component for the DICOM Protocol Adapter

Oracle Multimedia provides support for the DICOM protocol. This feature enables DICOM applications and devices to easily access DICOM data in Oracle Database, enabling Oracle Database to store and manage DICOM content as part of a clinical workflow. Large repositories of DICOM content can be managed and secured using Oracle Database tools, reducing management costs. Thus, the inclusion of images in electronic health care record management systems and other applications is simplified.

A DICOM protocol adapter enables the communication and exchange of DICOM content between PACS, DICOM viewers and other DICOM clients, and Oracle Database.

A configuration document type, `DICOM_PROTOCOL`, provides Oracle Multimedia DICOM protocol support. Administrators can use this document type to manage the behavior of a DICOM protocol adapter instance that is configured to use Oracle Database as the backing storage mechanism. This feature enables the DICOM protocol adapter to store, search, query, and retrieve DICOM images stored in Oracle Database, based on a specified user configuration.

## 1.2.3 Storing DICOM Content

Applications can store DICOM content directly in BLOBs or BFILEs. Oracle Multimedia provides the `ORD_DICOM` PL/SQL package, with functions and procedures that support DICOM content produced by medical devices.

In addition, Oracle Multimedia provides the `ORDDicom` object type, which natively supports DICOM content. This object type holds the DICOM content and extracted metadata, and implements the methods to manipulate the DICOM content.

## 1.2.4 DICOM Metadata Extraction

Oracle Multimedia provides support for extracting the most important metadata as DICOM attribute tags into an XML document, and then indexing and searching these tags to find DICOM content that matched certain conditions. Oracle Multimedia also supports complete and extensible metadata extraction. Customers can extract metadata according to an Oracle-specified XML schema, or create and use their own schema definition to extract subsets of the standard DICOM attribute tags or private tags. The extracted metadata can then be stored in a table to facilitate DICOM content searching based on standard or private DICOM attributes.

This enhanced metadata extraction capability enables customers to build large archives of DICOM content. By customizing extracted XML metadata documents, customers can create highly specialized indexes to DICOM content based on standard and private DICOM attribute tags.

## 1.2.5 DICOM Conformance Validation

Oracle Multimedia provides support for [conformance validation](#), enabling customers to verify that DICOM content adheres to a set of user-specified constraint rules.

DICOM content is generated by many devices. While most conform to the DICOM standard, some do not. It is important to be able to identify DICOM content that does not conform to the standard, or to the constraint rules for a particular organization or enterprise. Validating DICOM content for conformance can ensure the consistency of a DICOM archive. It enables a database to accept DICOM content from multiple sources and verify the integrity of the content.

## 1.2.6 DICOM Image Processing

Oracle Multimedia provides methods and functions to copy and process DICOM content into DICOM content or other formats (for example: JPEG, GIF, PNG, and TIFF), and to copy and generate scaled versions and thumbnail images. In addition, it provides a set of optional methods and functions to copy and process (for example: compress, scale, rotate, and crop) image content, during the conversion process.

Oracle Multimedia also provides functions to copy and process DICOM content into video formats. Oracle Multimedia supports the processing of multiframe DICOM content to the Microsoft Video for Windows Audio Video Interleave (AVI) format. You can generate output in AVI format from multiframe DICOM content such as MRIs, CTs, and Ultrasound videos.

To view medical images stored in the DICOM format in Web applications, you must create a copy of the images in formats that are compatible with the browsers that are currently used in the industry. Oracle Multimedia enables customers to automatically copy, reformat, and deliver DICOM images to applications that require popular industry-standard image formats such as JPEG.

## 1.2.7 Making Confidential Data in DICOM Content Anonymous

Oracle Multimedia provides a method that makes new ORDDicom objects with DICOM content and extracted XML attributes anonymous, in accordance with the rules specified by an anonymity document. The anonymity document defines both the set of attributes to be made anonymous and the actions to make them anonymous.

This method can be used to generate new, anonymous ORDDicom objects, ensuring that users of a DICOM medical archive see only the DICOM content and metadata that they are authorized to see. For example, clinicians require full access to DICOM content and metadata for each patient they are treating. They must be able to view all the DICOM metadata included in DICOM content. Researchers, however, require only partial access to the same DICOM metadata for patients participating in a study. Patient privacy regulations require that this class of users not be permitted to view attributes and metadata included in ORDDicom objects that contain personally identifying information.

By providing anonymity services in the database, Oracle Database enables appropriate access for different classes of users of a DICOM medical archive.

## 1.2.8 Creating ORDDicom Objects from Images or Video and Metadata

Oracle Multimedia includes the ability to generate new ORDDicom objects by combining digital images of various formats (for example: DICOM, JPEG, RAW, TIFF, and GIF) with an XML representation of the associated DICOM metadata. Oracle Multimedia supports the ability to generate new ORDDicom objects by combining

digital video of MPEG format with an XML representation of the associated DICOM metadata. This operation results in well-formed and validated ORDDicom objects, which can be stored in a table in the database or delivered to a DICOM viewer. This feature is particularly useful for generating DICOM secondary capture images and video.

Storing and retrieving film-based medical images is expensive and prone to loss. Replacing film-based medical images with DICOM images reduces storage and retrieval costs, and reduces the risk of loss. Storing scanned images and digital video with their metadata in DICOM format can make non-DICOM images and video more useful.

New DICOM content can also be generated to correct metadata errors in the original DICOM content.

## 1.2.9 Run-Time, Updatable DICOM Data Model

A key feature of DICOM support is that its run-time behavior is determined by a set of user-configurable documents. This set of documents is collectively managed by the data model repository. Administrators can update this data model repository to configure Oracle Multimedia DICOM for a particular database instance.

Hospitals must always be up and running. They cannot shut down the system for any of the following reasons:

- To update to a new version of the DICOM standard
- To incorporate private DICOM attribute tags for a new piece of equipment
- To change their DICOM conformance rules
- To modify the set of DICOM attribute tags they extract from each ORDDicom object, or to change the XML encoding of the extracted attributes
- To modify their DICOM anonymity rules

This design enables customers to upgrade Oracle Multimedia DICOM at any time, without interfering with a running DICOM archive.

# 2

## Oracle Multimedia DICOM Concepts

This chapter describes Oracle Multimedia DICOM at a conceptual level.

This chapter includes these sections:

- [Oracle Multimedia DICOM Architecture](#)
- [Oracle Multimedia DICOM Storage](#)
- [Model-Driven Design](#)
- [DICOM Data Model Repository](#)
- [Extraction of Metadata from DICOM Content](#)
- [Validation of DICOM Content](#)
- [Image Conversion and Creation of New DICOM Content](#)
- [Making DICOM Content Anonymous](#)
- [Extraction of DICOM Metadata for Partitioning](#)

### 2.1 Oracle Multimedia DICOM Architecture

Oracle Multimedia DICOM enables Oracle Database to store, manage, and retrieve DICOM content such as single-frame and multiframe images, waveforms, slices of 3-D volumes, video segments, and structured reports.

The Oracle Multimedia DICOM architecture defines the framework through which DICOM content is supported in the database. This DICOM content can then be securely shared across multiple applications written with popular languages and tools, easily managed and administered by relational database management and administration technologies, and offered on a scalable database that supports thousands of users.

The following figure illustrates the Oracle Multimedia DICOM architecture from the database perspective.

Figure 2-1 Oracle Multimedia DICOM Architecture

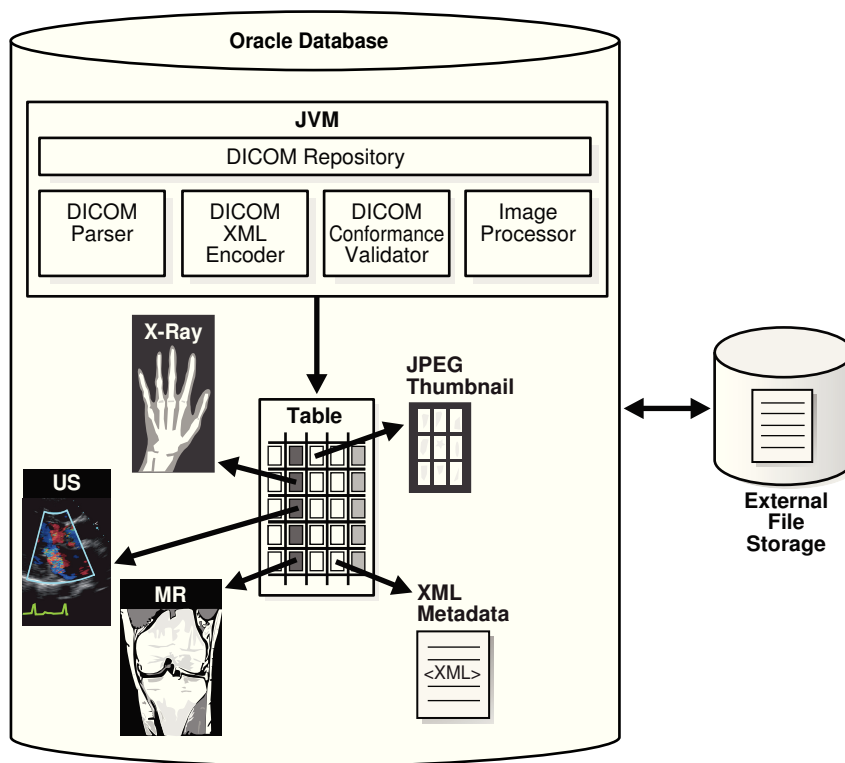

Using Oracle Multimedia DICOM, Oracle Database holds DICOM content in tables. As illustrated, DICOM content stored in a column of a table can include DICOM data such as X-rays, ultrasound images, and magnetic resonance images. In the table, a separate column stores a JPEG thumbnail image of the DICOM image. Another column stores the XML metadata documents associated with each image. Within a Java Virtual Machine (JVM), there is a server-side DICOM data model repository and a [DICOM parser](#), a [DICOM XML encoder](#), a [DICOM conformance validator](#), and an [image processor](#). The DICOM parser extracts metadata from DICOM content. The DICOM XML encoder maps the extracted DICOM attributes into an XML document, in accordance with the mapping rules defined in the [data model repository](#). The DICOM conformance validator checks the syntactical and semantic consistency of DICOM content in accordance with the constraint rules specified in the data model repository. The image processor provides image processing for operations such as producing thumbnail-size images and converting between DICOM and other supported image formats.

Using Oracle Multimedia DICOM procedures and methods enables import and export operations between the database and external file storage systems. The double-sided arrow connecting Oracle Database with External File Storage shows this data movement.

 **See Also:**

- *Oracle Multimedia User's Guide* for a view and description of the complete architecture for Oracle Multimedia
- *Oracle Multimedia DICOM Java API Reference* for information about using Oracle Multimedia DICOM with the Java programming language

## 2.2 Oracle Multimedia DICOM Storage

When using the object interface, you must create an ORDDicom object in a table before you can perform Oracle Multimedia DICOM operations on DICOM content. Oracle Multimedia defines the ORDDicom object type, which is similar to a Java or C++ class, to contain DICOM content.

Figure 2-2 shows an ORDDicom object at a very high level. Items in Figure 2-2 are numbered to help identify the items in this description. An instance of an ORDDicom object type (Item 1) consists of methods and attributes. Methods are functions or procedures that can be performed on the ORDDicom object, such as `makeAnonymous()` and `setProperties()`. The attributes include the following:

- Extracted DICOM attributes represented as an XML metadata document (Item 2)
- The DICOM content (Item 3), which is the original DICOM content in unmodified form stored within the database, under transaction control as a BLOB (recommended), or stored in an operating system-specific file in a local file system with pointers stored in the database
- Certain frequently accessed general attributes (Item 4), such as SOP Class UID, which are extracted and stored for ease of access and indexing
- Miscellaneous attributes (Item 5) that are meant for Oracle internal use

**Figure 2-2 ORDDicom Object**

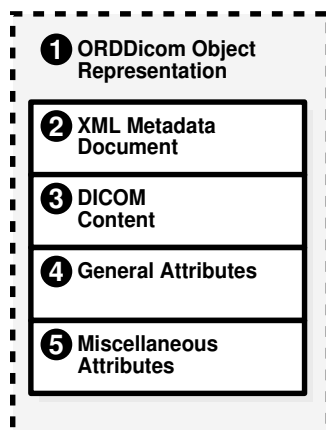

Similar to the NUMBER or BLOB data types, you can use the ORDDicom data type as the data type of a table column.

Figure 2-3 shows the structure of a simple table in a medical database that contains an ORDDicom object. Items in Figure 2-3 are numbered to help identify the items in this description. Item 1 represents the medical image database. Item 2 represents a simple medical image table managed by the database. This table contains two columns: ID (Item 3) and Image (Item 4). Item 3 represents the identifier for a specified DICOM image in the database. Item 4 represents the DICOM content in the database, which can be stored as an ORDDicom object (Item 5). Thus, the column type for the Image column is ORDDicom.

**Figure 2-3 Table in a Medical Image Database**

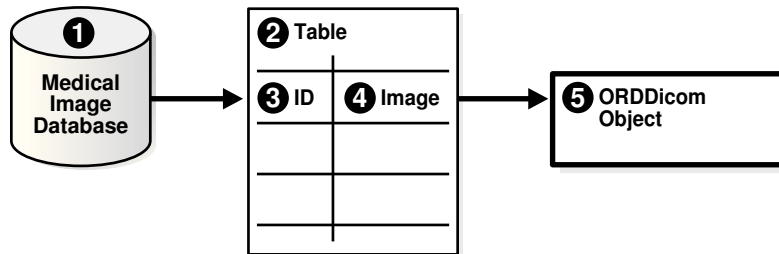

## 2.3 Model-Driven Design

Oracle Multimedia DICOM is designed with a model-driven software architecture. Thus, the run-time behavior of Oracle Multimedia DICOM is controlled by a domain-specific data model. The DICOM data model is a collection of XML documents that are managed in the data model repository. DICOM administrators can manage and modify the DICOM data model. The XML documents that comprise the data model can be inserted and deleted at run time when multiple user sessions are accessing the data model. Changes to the data model are protected with database transaction semantics, and each user session can refresh to the latest data model when necessary or desired.

Figure 2-4 illustrates the principles of model-driven software architecture using the DICOM metadata extraction feature. The items above the dotted line show the portions of the data model that are related to the metadata extraction feature. The items below the dotted line show the software run-time components of the extract metadata feature that access the data model. A line that connects an item of the data model and an item of the run-time component shows the run-time access to the corresponding item that is managed by the data model repository.

At design time, DICOM administrators can change the DICOM data model. Publishing these changes affects the run-time behavior of the extract metadata feature, and other DICOM operations.

Figure 2-4 shows three components of the data model. Items in Figure 2-4 are numbered to help identify the items in this description. Item 1 represents the DICOM data dictionary, which provides the definitions for DICOM standard and private attributes. Item 2 represents a mapping document, which describes how an attribute is to be mapped into an XML document. Item 3 represents a sample DICOM XML metadata schema, which defines the structure and data type of an XML document that is used to store DICOM attributes. The lines connecting elements of Item 2 and Item 3 show the mapping between a DICOM attribute stored in DICOM content and an XML element stored in an XML document that conforms to the XML schema.



The process of converting DICOM content (Item 4) into an XML metadata document (Item 8) is shown in the bottom half of Figure 2-4. Solid lines connecting items show the flow of data between run-time components. Two of the attributes of the sample DICOM content are shown in Item 5. The first attribute contains the attribute tag (0010,0010), the data type PN, the length in bytes 12, and the value Joe Smith. This attribute is encoded in the DICOM content, although its data type might not be encoded in the DICOM content. The parser (Item 6) can find an attribute definition by looking it up in the DICOM data dictionary (Item 1) using the attribute tag (0010,0010). The attribute definition determines the interpretation of the DICOM content. The result is passed to an XML encoder (Item 7). Similarly, the XML encoder looks up the data model (Item 2) to find the XML encoding guidelines for the attribute, and produces an XML document accordingly. Finally, an XML schema validator (Item 9) can validate the generated document against the XML metadata schema (Item 3).

In Figure 2-4, everything that controls the run-time behavior is part of the data model, which can be configured by a DICOM administrator.

Figure 2-4 DICOM Model-Based Parsing Details

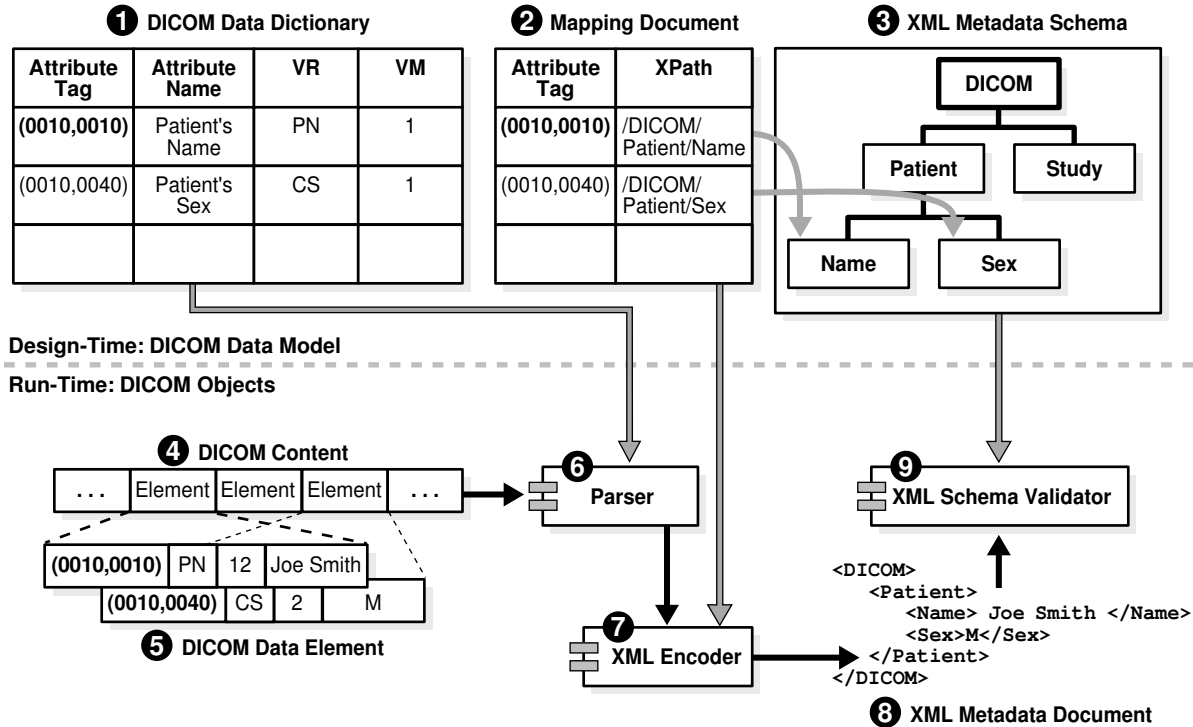

## 2.4 DICOM Data Model Repository

A key feature of Oracle Multimedia DICOM is that its run-time behavior is determined by a set of user-configurable documents (a data model). This set of documents is managed collectively in the data model repository. Administrators can update the data model repository to configure Oracle Multimedia DICOM for a particular database instance. With this design, customers can perform tasks such as upgrading Oracle Multimedia DICOM to a new version of the DICOM standard or adding new conformance validation rules at any time, without interfering with a running DICOM archive. Each database has its own set of configuration documents. Each organization

or enterprise can customize the installed configuration documents according to its needs.

This section includes these subsections:

- [Configuration Documents in the Repository](#)
- [Administrator and User Sessions in the Repository](#)
- [DICOM Data Model Repository in a CDB](#)

## 2.4.1 Configuration Documents in the Repository

The set of configuration documents that comprises the data model repository includes anonymity documents, constraint documents, DICOM protocol documents, mapping documents, preference documents, private and standard dictionary documents, stored tag list documents, and UID definition documents. Each [configuration document](#) comes with an XML schema definition. Other documents can be added to the repository as needed.

Oracle ships a set of default configuration documents with each software release. All schemas corresponding to the default documents are registered during installation. All schemas are fixed and must not be modified for a database installation.

[Table 2-1](#) lists the document type, the default XML document name, and the XML schema definition name for each type of document in the data model repository.

**Table 2-1 DICOM Configuration Documents and Their XML Schemas**

Document Type	Default XML Document	XML Schema Definition
Anonymity	ordcman.xml	ordcman.xsd
Constraint	ordcmct.xml ordcmcmd.xml ordcmcmc.xml	ordcmct.xsd
DICOM Protocol	None <sup>1</sup>	ordcmdp.xsd
Mapping	ordcmap.xml	ordcmap.xsd
Preference	ordcmpf.xml	ordcmpf.xsd
Private Dictionary	ordcmpv.xml	ordcmpv.xsd
Standard Dictionary	ordcmsd.xml	ordcmsd.xsd
Stored Tag List	None	ordcmstl.xsd
UID Definition	ordcmui.xml	ordcmui.xsd

<sup>1</sup> The DICOM\_PROTOCOL document type does not include a default XML document. Users must create one or more custom tables to store their DICOM images and metadata. Then, they must design a DICOM protocol document to configure the DICOM protocol adapter to use those tables.

 **Note:**

The latest versions of these XML documents are available as files in the `ord/xml` directory under `<ORACLE_HOME>`. The latest versions of these XML schemas are available as files in the `ord/xml/xsd` directory under `<ORACLE_HOME>`.

An **anonymity document** is an XML document that specifies the set of attributes to be made anonymous, and defines the actions required to make those attributes anonymous. The default anonymity document, `ordcman.xml`, lists a subset of the attributes defined in the Basic Application Level Confidentiality Profile in Part 15 of the DICOM standard.

A **constraint document** is an XML document that defines a collection of rules that check the conformance of DICOM content, according to the DICOM standard. The constraint document specifies attribute relationships and semantic constraints that cannot be expressed by the DICOM metadata schema. The default constraint documents, `ordcmct.xml`, `ordcmcmd.xml`, and `ordcmcmc.xml`, show a sample set of validation rules defined in accordance with a subset of Part 3 of the DICOM standard.

A **DICOM protocol document** is an XML document that is used as a named container for user-configurable parameters that manage where DICOM images and metadata are stored in Oracle Database. Each instance of the Oracle DICOM protocol adapter that is configured to connect to Oracle Database must have an associated DICOM protocol document. For example, the DICOM protocol document `ordcmdp.xml` defines where to store, query, and retrieve DICOM images and metadata to and from Oracle Database for one instance of the Oracle DICOM protocol adapter that is configured to connect to Oracle Database.

A **mapping document** is an XML document that defines how each attribute maps to a particular element in a DICOM XML metadata document. This document determines the structure of the extracted XML representation of the DICOM metadata. The default mapping document, `ordcmap.xml`, defines the mapping from DICOM content to XML, which is represented as a flat list where all XML encoded DICOM attributes are included under the root element `<DICOM_OBJECT>`.

A **preference document** is an XML document that defines run-time parameters, such as the size limits for DICOM attributes to omit when encoding to XML or whether to validate XML documents used in DICOM functions and procedures. The default preference document is `ordcmpf.xml`.

A **private dictionary document** is an XML document that enables users to extend the standard dictionary document definitions by adding manufacturer-specific or enterprise-specific attributes to DICOM content. The default private dictionary document, `ordcmpv.xml`, defines Oracle private attributes.

A **standard dictionary document** is an XML document that lists the standard attributes defined in Part 6 of the DICOM standard, and that can be used to reflect updates to the DICOM standard. The default standard dictionary document is `ordcmsd.xml`.

A **stored tag list document** is an optional XML document that specifies the DICOM attributes to be extracted from the embedded DICOM content and stored in the XML metadata attribute of the `ORDDicom` object when the `setProperties()` method is called. Generally, stored tag list documents contain the attribute tags used in mapping and constraint documents.

A [UID definition document](#) is an XML document that lists unique identifiers (UIDs) defined by the DICOM standard or a private organization. The UID is based on an ISO object identifier (OID). Rather than defining the DICOM content UIDs, the UID definition document contains a registry of standard UIDs that classify the DICOM content and express standard semantics. The default UID definition document, `ordcmui.xml`, lists UIDs defined by Part 6 of the DICOM standard.

See [DICOM Configuration Documents](#) and [DICOM XML Schemas](#), respectively, for more information about the installed configuration documents and their related XML schema definitions.

## 2.4.2 Administrator and User Sessions in the Repository

Administrators can manage configuration documents using the data model repository interface.

The data model repository must be loaded before any Oracle Multimedia DICOM methods, procedures, or functions are invoked. Loading the repository is accomplished through a DICOM package interface, using the `setDataModel()` procedure.

[Figure 2-5](#) uses a Unified Modeling Language (UML) sequence diagram to show the state of the DICOM data model repository in its installed state and in various states after being updated. Also shown are two administrator sessions and two user sessions working with one data model repository. The numbered items in [Figure 2-5](#) represent various components of, or operations on, the data model repository. The numbered items in the following list correspond to the numbered items in [Figure 2-5](#), respectively.

### Data Model States:

In Item 10, all the boxes in this column represent the data model repository in the following states:

- **State 0:** the installed version.
- **State 1:** the version that includes updates from the **Admin Session 1** editing session **XG1**.
- **State 2:** the version that includes updates from the **Admin Session 1** editing session **XG1** and the **Admin Session 2** editing session **XG2**.
- **State 3:** the version that includes updates from the **Admin Session 1** editing sessions **XG1** and **XG3** and updates from the **Admin Session 2** editing session **XG2**.

### Administrator Sessions:

- Item 1: All boxes in this column represent tasks performed by **Admin Session 1**.
- Item 6: All boxes in this column represent tasks performed by **Admin Session 2**.
- Item 2: **Admin Session 1** calls the `editDataModel()` procedure to begin editing session **XG1**. This locks the installed version of the data model (**State 0**) and prevents other administrators from editing the data model. During this time, users can view only the installed version of the data model (**State 0**). **Admin Session 1** edits the data model.
- Item 3: **Admin Session 1** completes editing session **XG1** and calls the `publishDataModel()` procedure to publish the changes to the data model. The data model is updated to **State 1** and the lock is released. Other administrators can

now lock the data model for editing. And, other users can now view the updated data model by calling the `setDataModel()` procedure.

- Item 7: **Admin Session 2** calls the `editDataModel()` procedure to begin editing session **XG2**. This locks the data model (**State 1**) and prevents other administrators from editing the data model. During this time, users can view **State 1** of the data model. **Admin Session 2** edits the data model.
- Item 8: **Admin Session 2** completes editing session **XG2** and calls the `publishDataModel()` procedure to publish the changes to the data model. The data model is updated to **State 2** and the lock is released.
- Item 4: **Admin Session 1** calls the `editDataModel()` procedure to begin editing session **XG3**. This locks the data model (**State 2**) and prevents other administrators from editing the data model. During this time, users can view **State 2** of the data model. **Admin Session 1** edits the data model.
- Item 9: **Admin Session 2** calls the `editDataModel()` procedure to begin editing session **XG4**. Because **Admin Session 1** has locked the data model, **Admin Session 2** cannot obtain the lock, and the call to the `editDataModel()` procedure fails.
- Item 5: **Admin Session 1** completes editing session **XG3** and calls the `publishDataModel()` procedure to publish the changes to the data model. The data model is updated to **State 3** and the lock is released.

#### User Sessions:

- Item 11: All boxes in this column represent tasks performed by **User Session 1**.
- Item 15: All boxes in this column represent tasks performed by **User Session 2**.
- Item 12: **User Session 1** calls the `setDataModel()` procedure to load the data model. The data model is still at the installed version (**State 0**) because **Admin Session 1** has not yet published the changes for editing session **XG1**.
- Item 16: **User Session 2** calls the `setDataModel()` procedure to load the data model. The data model is at **State 1**, which reflects the published changes from editing session **XG1**.
- Item 13: **User Session 1** calls the `setDataModel()` procedure again. The data model is now at **State 1**, which reflects the published changes from editing session **XG1**.
- Item 17: **User Session 2** calls the `setDataModel()` procedure again. The data model is still at **State 1** because **Admin Session 2** has not yet published the changes for editing session **XG2**.
- Item 14: **User Session 1** calls the `setDataModel()` procedure again. The data model is now at **State 2**, which reflects the published changes from editing sessions **XG1** and **XG2**.
- Item 18: **User Session 2** calls the `setDataModel()` procedure again. The data model is now at **State 3**, which reflects the published changes from editing sessions **XG1**, **XG2**, and **XG3**.

Figure 2-5 DICOM Data Model Repository

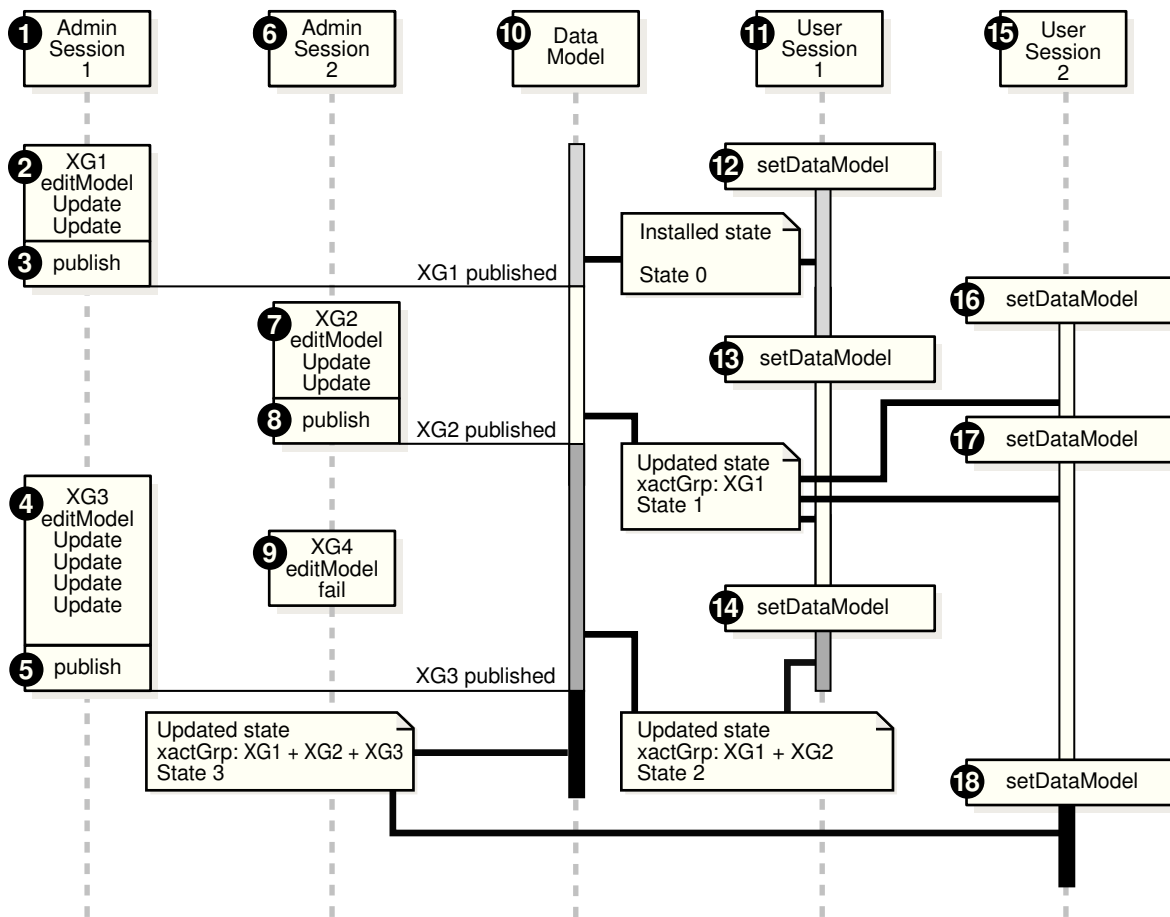

As shown in [Figure 2-5](#), the `setDataModel()` procedure is invoked during user sessions. Applications must call this procedure at the beginning of each database session to load the repository from the database into memory structures. This procedure can also be called whenever the application requires the new data model changes. This procedure is available to users through the DICOM data model utility in the `ORD_DICOM` package interface.

See [ORD\\_DICOM\\_ADMIN Package Reference](#) for more information about the data model repository administration interface. See [DICOM Data Model Utility Reference](#) for more information about the DICOM data model utility in the `ORD_DICOM` package interface.

### 2.4.3 DICOM Data Model Repository in a CDB

In a multitenant container database (CDB), each pluggable database (PDB) has its own distinct DICOM data model. Although the metadata is identical, the data in the DICOM data model may be very different. User documents in one PDB are not visible in other PDBs in the CDB.

 **See Also:**

- *Oracle Database Concepts* for information about the multitenant architecture
- *Oracle Database Administrator's Guide* for information about managing CDBs and PDBs

## 2.5 Extraction of Metadata from DICOM Content

Extracting metadata from DICOM content involves several operations using an XML metadata schema and a mapping document.

A [DICOM metadata document](#) is an XML document that contains the metadata extracted from DICOM content. Optionally, each metadata document can be constrained by an XML schema. Each XML metadata schema has a matching XML mapping document.

The mapping of DICOM content to the DICOM metadata document is defined by a mapping document. The mapping document defines how attributes from the DICOM content are to be mapped into an XML document that conforms to the schema. Like other configuration documents, mapping documents are managed by the DICOM data model repository (see [DICOM Data Model Repository](#)).

Oracle provides a default XML metadata schema (`ordcmmd.xsd`) and a matching XML mapping document (`ordcmmp.xml`). Application designers who create their own metadata schemas must ensure that their schema definition and mapping documents are compatible. They must also ensure that their data type definitions are compatible with the Oracle data type definitions (`ordcmddt.xsd`).

The following subsections describe these key extraction and mapping concepts:

- [Overview of the Metadata Extraction and XML Mapping Process](#)
- [Sample XML Documents Used in the Extraction and Mapping Process](#)

### 2.5.1 Overview of the Metadata Extraction and XML Mapping Process

[Figure 2-6](#) shows the components involved in the metadata extraction and XML mapping process. Each numbered item in [Figure 2-6](#) represents a component in this process.

Figure 2-6 DICOM Metadata Extraction and XML Mapping

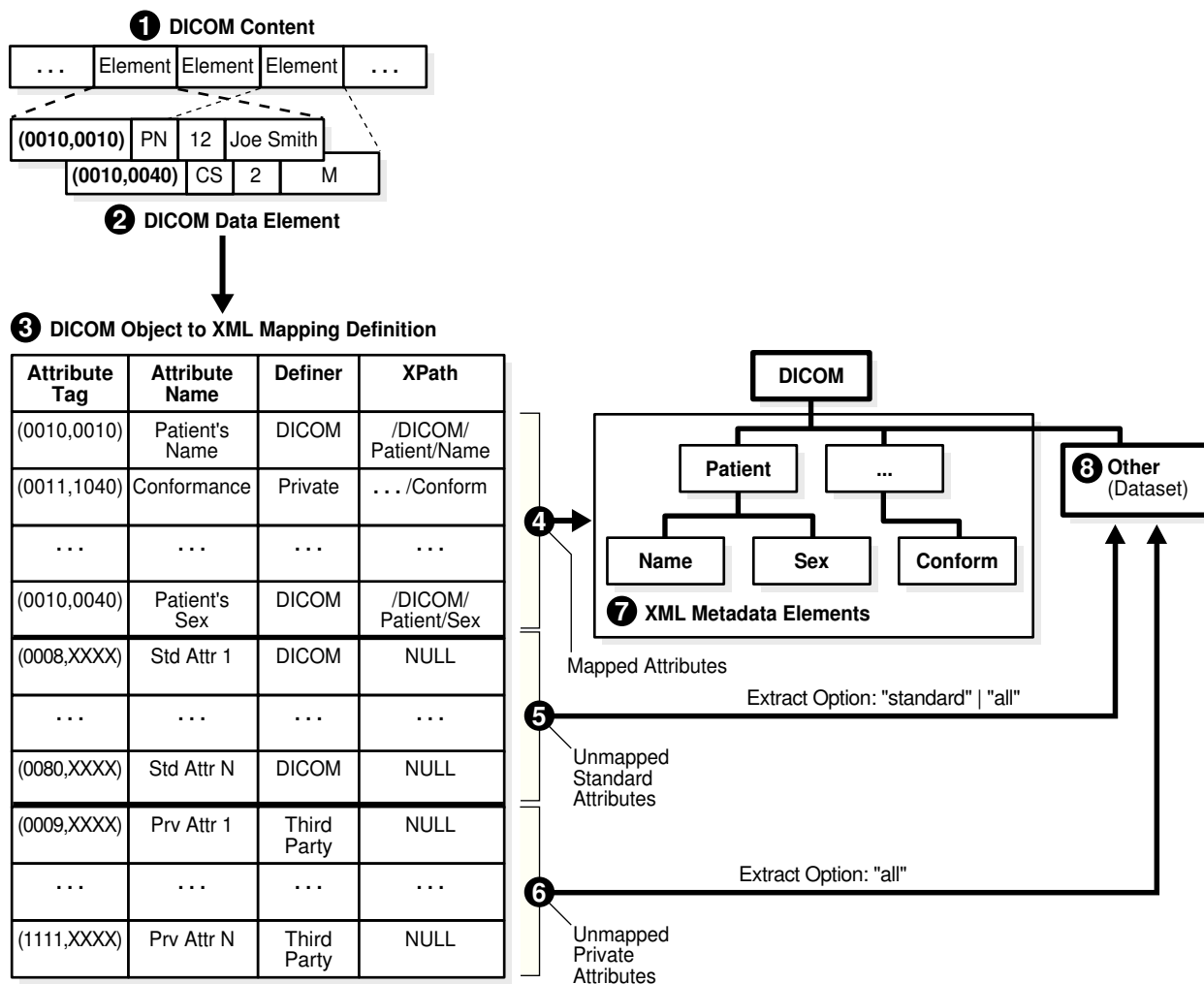

The input is DICOM content (Item 1) in binary format, which can be stored in an ORDDicom object, or directly in a BLOB or a BFILE. The output is an XML metadata document (Items 7 and 8). The layout of the metadata document is specified by the mapping document (Item 3). Metadata extraction uses a mapping option parameter that specifies which group of attributes to include in the output metadata document. The solid lines connecting items (Items 4, 5, and 6) show the flow of data from the DICOM content to the XML metadata document. Item 3 can also be interpreted as a processing engine that performs metadata extraction according to the specifications of the mapping document.

The DICOM content (Item 1) encodes a DICOM data element (Item 2) in binary code. At run time, the parser reads the binary stream of DICOM content, and builds a representation of the DICOM data element (Item 2) in memory. To map the in-memory representation of each DICOM attribute into an XML element, the XML encoder looks up the definition of the attribute in the mapping document (Item 3) that is stored in the data model repository.

For example, the first entry of this mapping document maps the DICOM attribute Patient's Name (0010,0010) to the XML path /DICOM/Patient/Name, where Name is a



subelement of the `Patient` element, and `Patient` is the child element of the document root element `DICOM`.

Attributes that are part of a DICOM data element and whose XML paths are explicitly defined in a mapping document are called [mapped attributes](#). Attributes that are part of a DICOM data element but whose XML paths are *not* explicitly defined in a mapping document are called [unmapped attributes](#).

Based on the mapping document, each DICOM metadata document can contain two sections: a mapped section and an optional, unmapped section. In the mapped section (Item 7), attributes are organized according to a predefined hierarchy. Attributes in the mapped section can be addressed with a fixed XPath query. In the unmapped section (Item 8), attributes are sorted by attribute tag and listed by [value representation](#). Attributes in the unmapped section can be addressed by an XPath query of the element tag in the following form:

```
/DICOM/Other/VR_TYPE(tag='HHHHHHHH')
```

In this query, `HHHHHHHH` is the hexadecimal attribute tag, and `/DICOM/Other` is the specified path for the unmapped section. See [About Creating Mapping Documents and Metadata XML Schemas](#) for information about how to create a your own mapping document.

The mapping option of the extract metadata function specifies which group of attributes to include in the output XML metadata document. The three mapping options are mapped, standard, or all.

If the extract option is `mapped` (Item 4), then only mapped attributes are included in the XML metadata document. This option is useful when the application using the metadata document has a fixed set of required attributes. The resulting metadata document (Item 7) has a well-defined tree structure.

If the extract option is `standard` (Item 5), then all mapped attributes and all unmapped attributes that are defined by the DICOM standard are extracted into the XML metadata document. Private attributes whose mappings are not defined are excluded from the output. This option is useful when an application such as a full-text search can use all standard attributes that are included in the DICOM content.

If the extract option is `all` (Item 6), then all attributes that are included in the DICOM content are extracted and encoded into the XML metadata document. This option provides lossless mapping of DICOM attributes from binary to XML.

 **Note:**

Attributes whose binary length exceeds the user-specified limit are not included in the XML metadata document. See [About Creating Preference Documents](#) for more information about specifying these limits within a preference document.

If the mapping option is `all` or `standard`, then unmapped attributes of the DICOM data element are stored under the XML element `Other` (Item 8). The resulting XML document can be stored in a database table, indexed, and queried using keywords or XPath query statements. To define alternative mapping structures and element names for mapped and unmapped sections, see [About Creating Mapping Documents and Metadata XML Schemas](#).

## 2.5.2 Sample XML Documents Used in the Extraction and Mapping Process

Using an XML mapping document to extract mapped metadata, you can generate an XML metadata document. [Example 2-1](#) shows a sample XML mapping document (`sample_map.xml`).

In [Example 2-1](#), the DICOM standard attribute `SOP_CLASS_UID` that has the DICOM attribute tag `(0002,0002)` maps to the XML metadata element `MEDIA_STORAGE_SOP_CLASS_UID` at the XML tree location `/DICOM_OBJECT/KEY_ATTRIBUTES/`. Similarly, the DICOM standard attribute `SOP_INSTANCE_UID` `(0002,0003)` maps to the XML metadata element `MEDIA_STORAGE_SOP_INSTANCE_UID`. The DICOM standard attribute `study date` `(0008,0020)` has not been listed by the XML mapping document. Thus, if it exists in the DICOM content, it appears in the unmapped section of the DICOM metadata document under the XML tree location `(/DICOM_OBJECT/OTHER_ATTRIBUTES)`.

[Example 2-2](#) shows a sample XML metadata document that can be generated by extracting mapped metadata using the XML mapping document shown in [Example 2-1](#).

### Example 2-1 Sample XML Mapping Document

```
<?xml version="1.0" encoding="UTF-8"?>
<XML_MAPPING_DOCUMENT xmlns="http://xmlns.oracle.com/ord/dicom/mapping_1_0"
xmlns:dt="http://xmlns.oracle.com/ord/dicom/datatype_1_0"
xmlns:xsi="http://www.w3.org/2001/XMLSchema-instance"
xsi:schemaLocation="http://xmlns.oracle.com/ord/dicom/mapping_1_0
http://xmlns.oracle.com/ord/dicom/mapping_1_0">
  <DOCUMENT_HEADER>
    <dt:DOCUMENT_CHANGE_LOG>
      <dt:DOCUMENT_MODIFIER>Developer</dt:DOCUMENT_MODIFIER>
      <dt:DOCUMENT_MODIFICATION_DATE>2006-01-13</dt:DOCUMENT_MODIFICATION_DATE>
      <dt:DOCUMENT_VERSION>0.0</dt:DOCUMENT_VERSION>
      <dt:MODIFICATION_COMMENT>Sample mapping document for metadata schema definition
1</dt:MODIFICATION_COMMENT>
    </dt:DOCUMENT_CHANGE_LOG>
  </DOCUMENT_HEADER>

  <NAMESPACE>http://xmlns.oracle.com/ord/dicom/metatest1</NAMESPACE>
  <ROOT_ELEM_TAG>DICOM_OBJECT</ROOT_ELEM_TAG>
  <UNMAPPED_ELEM>OTHER_ATTRIBUTES</UNMAPPED_ELEM>
  <MAPPED_ELEM>KEY_ATTRIBUTES</MAPPED_ELEM>

  <MAPPED_PATH occurs="true" notEmpty="true" writeTag="true" writeDefiner="true"
writeName="true" writeRawValue="true">
    <ATTRIBUTE_TAG>00020002</ATTRIBUTE_TAG>
    <PATH>MEDIA_STORAGE_SOP_CLASS_UID</PATH>
  </MAPPED_PATH>

  <MAPPED_PATH occurs="true" notEmpty="true">
    <ATTRIBUTE_TAG>00020003</ATTRIBUTE_TAG>
    <PATH>MEDIA_STORAGE_SOP_INSTANCE_UID</PATH>
  </MAPPED_PATH>

  <MAPPED_PATH writeTag="true" writeDefiner="true" writeName="true" writeRawValue="true">
    <ATTRIBUTE_TAG>00100010</ATTRIBUTE_TAG>
    <PATH>PATIENT_NAME</PATH>
  </MAPPED_PATH>
</XML_MAPPING_DOCUMENT>
```

## Example 2-2 Sample XML Metadata Document

```
<?xml version="1.0" encoding="DEC-MCS"?>
<DICOM_OBJECT xmlns="http://xmlns.oracle.com/ord/dicom/metatest1"
  xmlns:xsi="http://www.w3.org/2001/XMLSchema-instance"
  xsi:schemaLocation="http://xmlns.oracle.com/ord/dicom/metatest1
  http://xmlns.oracle.com/ord/dicom/metatest1">

  <KEY_ATTRIBUTES>

    <MEDIA_STORAGE_SOP_CLASS_UID definer="DICOM" tag="00020002"
      name="Media Storage SOP Class UID">1.2.840.10008.5.1.4.1.1.1</MEDIA_STORAGE_SOP_CLASS_UID>

    <MEDIA_STORAGE_SOP_INSTANCE_UID tag="00020003" definer="DICOM"
      name="media storage SOP instance UID">1.3.6.1.4.1.5962.1.1.10.1.2.20040119072730.12322
    </MEDIA_STORAGE_SOP_INSTANCE_UID>

    <PATIENT_NAME definer="DICOM" tag="00100010" name="Patient's Name">

      <NAME type="unibyte">

        <FAMILY>CompressedSamples</FAMILY>

        <GIVEN>RG2</GIVEN>

      </NAME>

      <VALUE>CompressedSampleRG2</VALUE>

    </PATIENT_NAME>

  </KEY_ATTRIBUTES>

</DICOM_OBJECT>
```

## 2.6 Validation of DICOM Content

Validating DICOM content involves verifying that the data conforms to a specified set of constraint rules.

There are several advantages of implementing [conformance validation](#) in the database instead of in the middle tier or the application tier. First, validating DICOM content can ensure the integrity and consistency of archived DICOM content by enabling a database to accept DICOM content from all sources and to check the integrity of that content. With this feature, the database can act as the centralized data store, connecting a variety of DICOM content sources while enforcing enterprise data constraint rules. Large organizations or government branches can establish their own sets of constraint rules that are more or less restrictive than the rules in the DICOM standard, and then enforce conformance with those constraint rules. In new areas, such as life sciences, where the DICOM standard is still being developed, constraint rules can serve as transitional tools to enforce a conventional representation of the DICOM content, thereby simplifying future transition to the DICOM standard. Finally, database systemwide conformance can greatly simplify enterprise (application) integration and data mining.

DICOM constraint documents define one or more constraint rules to check the conformance of DICOM content according to the DICOM standard or the guidelines for a particular organization or enterprise. [Example 2-3](#) shows a sample constraint document (`sample_ct.xml`).

After a constraint document has been inserted into the repository, users can validate DICOM content against the global constraint rules defined in the constraint document.

(Global constraint rules are defined with the <GLOBAL\_RULE> tag.) For example, users can check whether the DICOM content conforms to the global constraint rule named findJoeSmith, in [Example 2-3](#).

### Example 2-3 Sample Constraint Document

```
<?xml version="1.0" encoding="UTF-8"?>
<!-- Copyright (c) 2007, Oracle. All rights reserved.
NAME
sample_ct.xml - Oracle Multimedia DICOM sample constraint document
-->

<CONFORMANCE_CONSTRAINT_DEFINITION xmlns="http://xmlns.oracle.com/ord/dicom/constraint_1_0"
xmlns:dt="http://xmlns.oracle.com/ord/dicom/datatype_1_0"
xmlns:xsi="http://www.w3.org/2001/XMLSchema-instance"
xsi:schemaLocation="http://xmlns.oracle.com/ord/dicom/constraint_1_0
http://xmlns.oracle.com/ord/dicom/constraint_1_0">

  <GLOBAL_RULE name="findJoeSmith">
    <PREDICATE>
      <DESCRIPTION>An example to find an object that has (patientName="Joe Smith"
AND patientSex=="M")</DESCRIPTION>
      <LOGICAL operator="and">
        <PREDICATE>
          <RELATIONAL operator="eq">
            <ATTRIBUTE_TAG>00100010</ATTRIBUTE_TAG>
            <XML_VALUE>
              <dt:PERSON_NAME>
                <dt:NAME>
                  <dt:FAMILY>Smith</dt:FAMILY>
                  <dt:GIVEN>Joe</dt:GIVEN>
                </dt:NAME>
              </dt:PERSON_NAME>
            </XML_VALUE>
          </RELATIONAL>
        </PREDICATE>
        <PREDICATE>
          <RELATIONAL operator="eq">
            <ATTRIBUTE_TAG>00100040</ATTRIBUTE_TAG>
            <XML_VALUE>
              <dt:CODE_STRING>M</dt:CODE_STRING>
            </XML_VALUE>
          </RELATIONAL>
        </PREDICATE>
      </LOGICAL>
    </PREDICATE>
    <ACTION action="log" when="true">Found Joe Smith</ACTION>
  </GLOBAL_RULE>
</CONFORMANCE_CONSTRAINT_DEFINITION>
```

## 2.7 Image Conversion and Creation of New DICOM Content

ORDDicom objects can be processed and converted to other image formats. In addition, new ORDDicom objects can be created from existing ORDDicom objects. [Figure 2-7](#) shows these operations.

**Figure 2-7 Image Conversion Process**

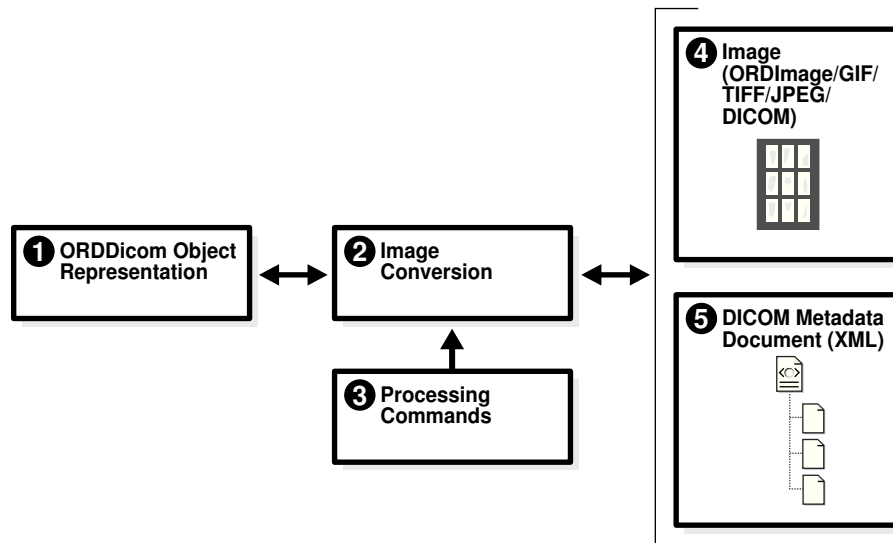

The following text describes [Figure 2-7](#) and discusses each of the components. The numbered items in the following text correspond to the numbered items in [Figure 2-7](#). The lines connecting the items in [Figure 2-7](#) show the direction for the flow of data.

The image converter (Item 2) can take DICOM content, specifically a DICOM image (Item 1), and processing commands (Item 3), and convert the DICOM content into an image (Item 4) of another format that is supported by Oracle Multimedia (for example: JPEG or GIF formats) for display in a Web browser or an application.

This process can also be reversed. Using an image such as an ORDImage object storing a JPEG file, TIFF file, or other supported image file (Item 4) and a DICOM metadata document (Item 5), the image converter can merge the two items and produce DICOM content that can be used to create a new ORDDicom object (Item 1). Similarly, the image converter (Item 2) can copy and convert the DICOM content (Item 4) and an XML metadata document (Item 5) into a new ORDDicom object (Item 1). Common uses of this type of process can include lossless compression on the converted image to save disk space, translation into a different type of transfer syntax to enable cross-platform image exchanging, or metadata updating.

When processing, the embedded image content can contain one or more frames. Depending on the processing command for frames, the image converter can read the pixel content of one or all the frames in an image. After the embedded DICOM image is written to an ORDImage object or a BLOB in a format such as GIF or JPEG, you can display the converted image on the Web.

In addition, multiframe DICOM images, such as MRIs, CTs, and Ultrasound videos, can be processed and converted to the Microsoft Video for Windows Audio Video Interleave (AVI) format. See [Overview of DICOM Development](#) and [DICOM Processing and Supported Formats](#) for more information about these and other DICOM processing operations.

## 2.8 Making DICOM Content Anonymous

Government regulations, such as the Health Insurance Portability and Accountability Act (HIPAA) in the U. S., mandate the protection of confidential data about patients. Sharing DICOM content with external resources often requires making confidential patient data anonymous. Making DICOM content anonymous in the database avoids exposing confidential patient data outside of the database, simplifying the protection of that information.

The process of making DICOM content anonymous can be customized using the data model repository. Users can create different anonymity documents in XML. Each anonymity document lists a set of attributes to be made anonymous, and the type of actions to be taken to make the attributes anonymous. Supported actions are `remove` and `replace`. The `remove` action is the default action that deletes an attribute or sets it to zero length in the DICOM content and in the ORDDicom object attributes. The `replace` action replaces an attribute with a string, which can either be empty or contain a user-defined string in the DICOM content and in the ORDDicom object attributes.

[Example 2-4](#) shows a sample anonymity document.



### See Also:

<http://www.hhs.gov/ocr/privacy/index.html> for more information about the HIPAA regulations in the U. S.

### Example 2-4 Sample Anonymity Document

```
<?xml version="1.0" encoding="UTF-8"?>
<!-- Copyright (c) 2006, 2007, Oracle. All rights reserved. -->
<ANONYMITY_RULE_DOCUMENT xmlns="http://xmlns.oracle.com/ord/dicom/anonymity_1_0"
  xmlns:dt="http://xmlns.oracle.com/ord/dicom/datatype_1_0"
  xmlns:xsi="http://www.w3.org/2001/XMLSchema-instance"
  xsi:schemaLocation="http://xmlns.oracle.com/ord/dicom/anonymity_1_0
  http://xmlns.oracle.com/ord/dicom/anonymity_1_0">
  <DOCUMENT_HEADER>
    <dt:DOCUMENT_CHANGE_LOG>
      <dt:DOCUMENT_MODIFIER>Developer</dt:DOCUMENT_MODIFIER>
      <dt:DOCUMENT_MODIFICATION_DATE>2006-02-06</dt:DOCUMENT_MODIFICATION_DATE>
      <dt:DOCUMENT_VERSION>0.1</dt:DOCUMENT_VERSION>
      <dt:MODIFICATION_COMMENT>Sample anonymity document</dt:MODIFICATION_COMMENT>
      <dt:BASE_DOCUMENT>Test Document</dt:BASE_DOCUMENT>
      <dt:BASE_DOCUMENT_RELEASE_DATE>2004-01-01</dt:BASE_DOCUMENT_RELEASE_DATE>
      <dt:BASE_DOCUMENT_DESCRIPTION>Same as ordcman.xml from label 070321</dt:BASE_DOCUMENT_DESCRIPTION>
    </dt:DOCUMENT_CHANGE_LOG>
  </DOCUMENT_HEADER>
  <PRIVATE_ATTRIBUTES action="remove"></PRIVATE_ATTRIBUTES>
  <UNDEFINED_STANDARD_ATTRIBUTES action="remove"></UNDEFINED_STANDARD_ATTRIBUTES>
  <UNDEFINED_PRIVATE_ATTRIBUTES action="remove"></UNDEFINED_PRIVATE_ATTRIBUTES>
  <INDIVIDUAL_ATTRIBUTE>
    <ATTRIBUTE_TAG>00100010</ATTRIBUTE_TAG>
    <DESCRIPTION>Patient Name</DESCRIPTION>
    <ANONYMITY_ACTION action="replace">SmitJoe</ANONYMITY_ACTION>
  </INDIVIDUAL_ATTRIBUTE>
  <INDIVIDUAL_ATTRIBUTE>
    <ATTRIBUTE_TAG>00100020</ATTRIBUTE_TAG>
    <DESCRIPTION>Patient ID</DESCRIPTION>
    <ANONYMITY_ACTION action="replace">madeAnonymous</ANONYMITY_ACTION>
  </INDIVIDUAL_ATTRIBUTE>
  <INDIVIDUAL_ATTRIBUTE>
```

```
<ATTRIBUTE_TAG>00100030</ATTRIBUTE_TAG>  
<DESCRIPTION>Patient Birth Date</DESCRIPTION>  
<ANONYMITY_ACTION action="remove"></ANONYMITY_ACTION>  
</INDIVIDUAL_ATTRIBUTE>  
</ANONYMITY_RULE_DOCUMENT>
```

## 2.9 Extraction of DICOM Metadata for Partitioning

Oracle Multimedia enables the extraction of DICOM metadata outside the database by a client tool or in the middle tier. This feature enables the extraction of DICOM metadata before the data is loaded into the database, facilitating metadata-based partitioning of DICOM data in the database.

Partitioning supports very large tables and indexes by enabling you to reorganize them into smaller, and thus more usable, chunks called partitions. Partitioning can make your data more available, easier to manage, and faster to query.

You can include DICOM metadata attributes in the partition key, a set of one or more columns that determines the partition in which each row in a partitioned table is stored. To ensure that data is stored in the correct partition, you must provide values for the partition key when the data is loaded.

Oracle Multimedia DICOM includes the Oracle Multimedia Mid-Tier Java API. This client application programming interface for the middle tier enables developers to write Java applications to extract DICOM metadata outside of Oracle Database. This API enables the extraction of DICOM attributes that constitute the partition key before the data is loaded into the database.

### See Also:

- *Oracle Multimedia Mid-Tier Java API Reference* for reference information
- *Oracle Database VLDB and Partitioning Guide* for more information about partitioning

# 3

## Overview of DICOM Development

This chapter briefly describes developer and administrator tasks that are related to developing applications using Oracle Multimedia DICOM.

This chapter includes these sections:

- [The DICOM Development Environment](#)
- [DICOM Developer and Administrator Tasks](#)

### 3.1 The DICOM Development Environment

Oracle Multimedia DICOM provides capabilities for several operations related to DICOM content. For example, administrators can review the Oracle-defined configuration documents in the DICOM data model repository before determining whether to add user-defined documents for their environment. Administrators can use views or invoke data model utility functions to obtain attributes and other detailed information about these configuration documents. Developers can also work directly with the DICOM content, metadata attributes, and other objects to perform various operations.

After installation, each database includes a set of default configuration documents in the Oracle Multimedia DICOM data model repository. After installation, administrators can add configuration documents that are specific to a particular organization. See [Configuration Documents in the Repository](#) for general information about configuration documents. See [DICOM Administration Usage and Reference](#) for detailed information about managing these documents in the DICOM repository.

The following subsections describe the DICOM development environment:

- [APIs for Use With Oracle Multimedia DICOM](#)
- [Views in the DICOM Repository](#)

#### 3.1.1 APIs for Use With Oracle Multimedia DICOM

Because Oracle Multimedia DICOM is fully functional after installing Oracle Multimedia, developers can begin writing applications immediately. Oracle Multimedia DICOM provides several application programming interfaces (APIs) for developers, which are also available to administrators.

In addition, Oracle Multimedia DICOM provides the ORD\_DICOM\_ADMIN data model repository API for administrators only. Using this API, administrators can assist developers by inserting or deleting configuration documents from the data model repository.

The following table lists the application programming interfaces that are available for Oracle Multimedia DICOM, indicates who can use them, and points to additional information.



**Table 3-1 Application Programming Interfaces for DICOM**

Name of API	Type of User	More Information
DICOM data model utility API	Administrators and developers	<a href="#">DICOM Data Model Utility Reference</a>
DICOM PL/SQL API	Administrators and developers	<a href="#">DICOM PL/SQL API Reference</a>
ORDDicom object API	Administrators and developers	<a href="#">ORDDicom Object Type Reference</a>
Mid-Tier Java API	Administrators and developers	<i>Oracle Multimedia Mid-Tier Java API Reference</i>
ORD_DICOM_ADMIN data model repository API	Administrators only	<a href="#">ORD_DICOM_ADMIN Package Reference</a>

## 3.1.2 Views in the DICOM Repository

Oracle Multimedia DICOM provides views to enable access to specific information about documents in the DICOM repository. Public views are available to users and administrators of the repository. These views provide details such as the names of documents, types of documents, names of constraints, and constraint validation messages. An administrator-only view provides details about document references within the repository.

The following table lists the views, indicates who can access them, and points to additional information.

**Table 3-2 DICOM Repository Views**

Name	Access	More Information
orddcm_conformance_vld_msgs	Public	<a href="#">DICOM Repository Public Views</a>
orddcm_constraint_names	Public	<a href="#">DICOM Repository Public Views</a>
orddcm_document_types	Public	<a href="#">DICOM Repository Public Views</a>
orddcm_documents	Public	<a href="#">DICOM Repository Public Views</a>
orddcm_document_refs	Administrators only	<a href="#">DICOM Repository Administrator Views</a>

### orddcm\_conformance\_vld\_msgs

The [orddcm\\_conformance\\_vld\\_msgs](#) view lists the constraint messages that are generated for a set of constraints during a validation operation.



#### Note:

This view lists the constraint messages for the current user's schema *only*.

#### **orddcm\_constraint\_names**

The [orddcm\\_constraint\\_names](#) view lists the names of the constraints installed in the repository.

#### **orddcm\_document\_types**

The [orddcm\\_document\\_types](#) view identifies the supported Oracle Multimedia DICOM document types with a list of codes.

#### **orddcm\_documents**

The [orddcm\\_documents](#) view lists details of the documents that are stored in the repository.

#### **orddcm\_document\_refs**

For administrators only, the [orddcm\\_document\\_refs](#) view lists the documents in the repository that are referenced by other documents in the repository.

## 3.2 DICOM Developer and Administrator Tasks

The following tasks, which are described in these subsections, present a recommended approach for developing applications using Oracle Multimedia DICOM:

- [Task 1: Load the Repository](#)
- [Task 2: Load the DICOM Content](#)
- [Task 3: Extract the DICOM Metadata](#)
- [Task 4: Search and Retrieve DICOM Attributes](#)
- [Task 5: Write and Edit DICOM Metadata](#)
- [Task 6: Process\\_ Convert\\_ and Compress DICOM Data](#)
- [Task 7: Create DICOM Content from Secondary Capture Images and Video](#)
- [Task 8: Validate Conformance with DICOM Constraints](#)
- [Task 9: Protect Confidential Patient Data](#)
- [Task 10: Improve Storage When Extracting DICOM Attributes](#)

In addition, each of these tasks requires administrators and developers to perform a separate, specific set of steps:

- Extracting the DICOM metadata
- Validating conformance with DICOM constraints
- Protecting confidential patient data

### 3.2.1 Task 1: Load the Repository

At the start of every database session, users and administrators must load the data model repository from the database into memory structures. Users load the data model by calling the `setDataModel()` procedure. Administrators load the data model by calling either the `setDataModel()` procedure or the `editDataModel()` procedure.

After loading the repository into memory, users and administrators can call the `setDataModel()` procedure whenever the application requires the new data model changes.

 **Note:**

Users and administrators must call the `setDataModel()` procedure before calling any other DICOM methods, functions, or procedures.

Using the DICOM data model utility in the `ORD_DICOM` package, users and administrators call the `setDataModel()` procedure as follows:

```
exec ord_dicom.setdatamodel;
```

See the [setDataModel\(\) Procedure](#) and the [editDataModel\(\) Procedure](#) for more information.

## 3.2.2 Task 2: Load the DICOM Content

You can use the SQL\*Loader utility to load DICOM content into existing tables in Oracle Database. First, you must create a table with the appropriate columns and initialize the columns (see [Creating a Table with an ORDDicom Column](#)). Then, you can call the SQL\*Loader utility and load the DICOM content from your data files into the table columns as SecureFiles LOBs (see [Loading DICOM Content Using the SQL\\*Loader Utility](#)). Before performing any operations on the DICOM content, you must call the `setDataModel()` procedure to load the DICOM data model (see the [setDataModel\(\) Procedure](#)).

After the DICOM content is loaded, you can perform other operations, such as extracting DICOM metadata, searching and retrieving DICOM attributes, writing and editing DICOM metadata, creating thumbnail images, validating the conformance of your DICOM content, or making confidential DICOM content anonymous.

See [DICOM Application Development](#) for examples that show how to use the SQL\*Loader utility to load DICOM content and then make specific metadata attributes in the DICOM content anonymous.

 **See Also:**

*Oracle Database Utilities* for more information about using the SQL\*Loader utility to load objects and LOBs into Oracle Database

## 3.2.3 Task 3: Extract the DICOM Metadata

Oracle Multimedia DICOM provides support for extracting metadata from DICOM content. By searching the extracted metadata, applications can find the specific DICOM content that contains the associated metadata.

To extract all DICOM attributes into an XML document that conforms to the default metadata XML schema, first call the `setProperties()` method to extract and store the

metadata XML document into the metadata attribute of the ORDDicom object. The default metadata XML schema defines a complete and generalized data model for storing DICOM attributes. A customized metadata schema and corresponding mapping document that is customized for your specific application may yield better performance for indexing and searching than the generalized, default metadata schema. Your custom schemas and mapping documents can be used to define frequently searched DICOM attributes within a hierarchical structure that is optimized for searching.

To extract the DICOM attributes into an application-specific XML document in XMLType, call the `extractMetadata()` method and specify the application-specific mapping document. The resulting application-specific metadata XML document can be stored in table columns. This metadata can be bound to the application-specific XML schema.

See the [setProperties\(\)](#) and [extractMetadata\(\)](#) methods for more information.

The following subsections list the steps for administrators and developers to perform when extracting metadata:

- [Extracting Metadata: Administrator Tasks](#)
- [Extracting Metadata: Developer Tasks](#)

### 3.2.3.1 Extracting Metadata: Administrator Tasks

As an administrator, perform the following tasks to initiate the process of extracting DICOM metadata:

1. Design the XML schema for the extracted metadata. Generally, the most frequently searched DICOM attributes are included in the mapped section of the XML schema.

See [DICOM XML Schemas](#) for more information about XML schemas.

2. Register the metadata XML schema, either as a global or local XML schema, with Oracle XML DB.

#### Note:

Global registered XML schemas can be seen and used by other database users. To prevent other users from validating against your custom metadata XML schemas that are associated with user-defined mapping documents, register them as local schemas with Oracle XML DB.

#### See Also:

*Oracle XML DB Developer's Guide* for more information about global and local XML schemas

3. Create the mapping document for the metadata XML schema.

See [About Creating Mapping Documents and Metadata XML Schemas](#) for more information.

4. Load the mapping document into the data model repository.  
See [About Inserting Documents into the Repository](#) for more information.

### 3.2.3.2 Extracting Metadata: Developer Tasks

As a developer, perform the following tasks to complete the process of extracting DICOM metadata:

1. Query the `orddcm_documents` view to ensure that the mapping document is loaded and available.  

```
select * from orddcm_documents;
```

  
See the [orddcm\\_documents](#) view for more information.
2. Call the `extractMetadata()` method to extract metadata into an XML metadata document by specifying the name of the mapping document and the appropriate parameters.  
See the [extractMetadata\(\)](#) method for more information.
3. Store the returned XML metadata document in a column in the database that is bound to the application-specific XML schema for later searching.



#### See Also:

*Oracle XML DB Developer's Guide* for more information about this task

### 3.2.4 Task 4: Search and Retrieve DICOM Attributes

Oracle Multimedia DICOM provides support for searching and retrieving DICOM attributes.

To extract the SOP instance UID, SOP class UID, study instance UID, and series instance UID attributes into ORDDicom object attributes, first call the `setProperties()` method to populate the attributes of the ORDDicom object. These DICOM attributes can be easily retrieved from within the ORDDicom object. To make searching faster, these attributes can also be indexed by creating indexes on the corresponding object attributes. (See [ORDDicom Object Type Reference](#) for reference information.)

To search and retrieve attributes within the metadata XML document, call the SQL XML functions `XMLCast()`, `XMLExists()`, `XMLQuery()`, and `XMLTable()` by specifying the XPath expression for the attributes. To make searching faster, the attributes in the metadata XML document can also be indexed.



#### See Also:

- *Oracle Database SQL Language Reference* for reference information
- *Oracle XML DB Developer's Guide* for more information about indexing XMLType data

To retrieve a single DICOM attribute, you can call either the `getAttributeByTag()` or the `getAttributeByName()` method. This process is not recommended for large tables, or for retrievals of multiple attributes. However, if you do use this process, Oracle recommends building function-based indexes on these methods to make searching faster. (See [ORDDicom Object Type Reference](#) for reference information.)

 **Note:**

Before you can retrieve DICOM attributes, you must call the `setProperties()` method to populate the attributes of the ORDDicom object (see [setProperties\(\)](#)).

### 3.2.5 Task 5: Write and Edit DICOM Metadata

Oracle Multimedia DICOM provides support for creating a new ORDDicom object with overwritten or supplemented metadata from an existing ORDDicom object. The `writeMetadata()` method creates a new copy of the ORDDicom object from the original ORDDicom object and an XML document containing any additional and modified metadata. The original ORDDicom object is preserved.

Perform the following tasks to write and edit DICOM metadata:

1. Extract a copy of the original DICOM metadata from the original DICOM content by calling the `extractMetadata()` method, using the Oracle default mapping document.  
See the [extractMetadata\(\)](#) method for more information.
2. Add or modify DICOM attributes in the copy of the extracted metadata XML document.  
See [Overview of DICOM Administration](#) for more information about working with DICOM metadata in XML documents.
3. Create an empty ORDDicom object using an empty ORDDicom constructor as the placeholder for the new DICOM content.  
See [ORDDicom Constructors](#) for reference information.
4. Call the `writeMetadata()` method to write the modified copy of the metadata XML document and the DICOM content from the original ORDDicom object into the newly created ORDDicom object. The metadata XML document is used to overwrite existing attributes and add new attributes in the new ORDDicom object.  
See the [writeMetadata\(\)](#) method for more information.

### 3.2.6 Task 6: Process, Convert, and Compress DICOM Data

Oracle Multimedia DICOM provides the `processCopy()` method to copy and process the DICOM content and save it as DICOM format or another media format, in accordance with the specified command parameters. The `processCopy()` method creates new content and preserves the original DICOM content.

The following list summarizes the processing, converting, and compressing operations supported by Oracle Multimedia DICOM, and includes examples of the command parameter of the `processCopy()` method that corresponds to each operation.

- Create a JPEG thumbnail image. For example:  
`'fileFormat=jpeg, maxScale=100 100'`
- Create a JPEG image of the same size as the original DICOM image. For example:  
`'fileFormat=jpeg'`
- Compress the image content within the DICOM content. For example:  
`'fileFormat=dicom, compressionFormat=jpeg'`
- Retrieve a specified frame from DICOM multiframe content. For example:  
`'frame=10'`
- Cut a specified region of a DICOM image. For example:  
`'cut=20 20 100 100'`
- Process multiframe DICOM content into AVI output. For example:  
`'fileFormat=avi, scale=0.5'`
- Write DICOM content with RLE compression. For example:  
`'fileFormat=dicom, compressionFormat=dicomrle'`
- Extract MPEG content from DICOM format and process it into MPEG format. For example:  
`'fileFormat=mpeg'`
- Write DICOM content with DEFLATE compression. For example:  
`'fileformat=dicom, compressionFormat=deflate, deflateLevel=defaultcompression'`

See [ORDDicom Methods](#) for reference information about `processCopy()` methods and supported command parameters. See [DICOM Processing and Supported Formats](#) for more information about DICOM processing.

## 3.2.7 Task 7: Create DICOM Content from Secondary Capture Images and Video

Oracle Multimedia DICOM provides the PL/SQL API procedure `createDicomImage()` to create DICOM format images and video from secondary capture images and video, including content in formats such as JPEG, TIFF, or MPEG and DICOM metadata in data type `XMLType`.

Perform the following tasks to create DICOM format content from secondary capture images or video and DICOM metadata:

1. Load the provided image or video into a BLOB, or define it as a BFILE data type.
2. Create an `XMLType` object from the DICOM metadata of the corresponding image or video.
3. Create an empty BLOB object as the placeholder for the new DICOM content.
4. Create the DICOM format image or video using the `createDicomImage()` procedure.

See [DICOM PL/SQL API Procedures](#) for reference information about the `createDicomImage()` procedures.

## 3.2.8 Task 8: Validate Conformance with DICOM Constraints

Oracle Multimedia DICOM provides support to validate the conformance of your DICOM content, according to DICOM specified constraints, with the `isConformanceValid()` method. Use this method to check if the embedded DICOM content conforms to a specific set of constraints.

Conformance constraints are a collection of rules for validating the conformance of DICOM content with the DICOM standard and other organization-wide guidelines. These rules are specified in an XML document called a [constraint document](#), which is stored in the repository. The default constraint document shipped with Oracle Multimedia DICOM defines rules that enforce conformance with parts of the DICOM standard.

DICOM content can come from many sources, and the DICOM content may or may not have been created in accordance with the DICOM standard. Before you decide to store DICOM content in your repository, you can check the DICOM content for specific attributes. As an example, you can check the DICOM content for the value of the attribute for a patient's sex. As defined in the Patient Module Attributes of the DICOM standard, this attribute can have these values: `M` (male), `F` (female), or `O` (other). You can define constraint rules to check for correct values for specific attributes. Or, you can define a custom set of constraint rules and then ensure that all DICOM content in your repository conforms to those rules.

After installation, you can define constraint documents to include user-defined constraint rules that are specific to your organization. To see a list of constraint names, query the view [orddcm\\_constraint\\_names](#).

During conformance validation, if a constraint rule was defined to generate messages for a specified predicate condition and the condition was met, these messages are generated to indicate the predicate conditions. To see a list of these constraint messages, query the view [orddcm\\_conformance\\_vld\\_msgs](#).

Validating the conformance of DICOM content requires a combination of administrator and developer tasks. The following subsections describe these tasks.



### Note:

Perform the administrator tasks described in this section first.

The following subsections list the steps for administrators and developers to perform when during conformance validation:

- [Validating Conformance: Administrator Tasks](#)
- [Validating Conformance: Developer Tasks](#)

### 3.2.8.1 Validating Conformance: Administrator Tasks

As an administrator, perform the following tasks to initiate the process of validating the conformance of DICOM content:

1. Create a constraint document for your organization. Within this document, you can define constraint rules to generate messages for specified predicate conditions.



[Example 3-1](#) shows the constraint rule for the Patient Module of the DICOM standard, which is defined in the Oracle-installed constraint document `ordcmcmd.xml`.

See [About Creating Constraint Documents](#) for more information.

2. Load the constraint document into the data model repository.

See [About Inserting Documents into the Repository](#) for more information.

### Example 3-1 Constraint Rule for the Patient Module

```
<GLOBAL_RULE name="PatientModule">
  <DESCRIPTION>
    A subset of Patient Module defined in DICOM standard
  </DESCRIPTION>
  <PREDICATE>
    <BOOLEAN_FUNC operator="notEmpty">
      <ATTRIBUTE_TAG>00100040</ATTRIBUTE_TAG>
    </BOOLEAN_FUNC>
  </PREDICATE>
  <PREDICATE>
    <DESCRIPTION>Patient's Sex</DESCRIPTION>
    <RELATIONAL operator="in">
      <ATTRIBUTE_TAG>00100040</ATTRIBUTE_TAG>
      <STRING_VALUE>M</STRING_VALUE>
      <STRING_VALUE>F</STRING_VALUE>
      <STRING_VALUE>O</STRING_VALUE>
    </RELATIONAL>
  </PREDICATE>
  <PREDICATE>
    <DESCRIPTION>Referenced patient sequence constraint</DESCRIPTION>
    <LOGICAL operator="derive">
      <PREDICATE>
        <BOOLEAN_FUNC operator="occurs">
          <ATTRIBUTE_TAG>00081120</ATTRIBUTE_TAG>
        </BOOLEAN_FUNC>
      </PREDICATE>
      <PREDICATE>
        <LOGICAL operator="and">
          <PREDICATE>
            <BOOLEAN_FUNC operator="notEmpty">
              <ATTRIBUTE_TAG>00081120.00081150</ATTRIBUTE_TAG>
            </BOOLEAN_FUNC>
          </PREDICATE>
          <PREDICATE>
            <BOOLEAN_FUNC operator="notEmpty">
              <ATTRIBUTE_TAG>00081120.00081155</ATTRIBUTE_TAG>
            </BOOLEAN_FUNC>
          </PREDICATE>
        </LOGICAL>
      </PREDICATE>
    </LOGICAL>
  </PREDICATE>
  <ACTION action="log" when="false">Validation error:
    missing mandatory attribute for patient module</ACTION>
  <ACTION action="warning" when="false">Warning: validation failure</ACTION>
</GLOBAL_RULE>
```

## 3.2.8.2 Validating Conformance: Developer Tasks

As a developer, perform the following tasks to complete the process of validating the conformance of DICOM content against your constraint rules:

1. Query the `ordcm_constraint_names` view to see the list of available constraint names for your organization as follows:

```
select * from orddcm_constraint_names;
```

See the [orddcm\\_constraint\\_names](#) view for more information.

2. Call the `isConformanceValid()` method to check the conformance of your DICOM content as follows:

```
declare
  cursor dicom_src_cur is
    select dicom_src from medical_image_obj order by id;
begin
  for rec in dicom_src_cur loop
    dbms_output.put_line('isConformanceValid(PatientModule): ' ||
      rec.dicom_src.isConformanceValid('PatientModule'));
  end loop;
end;
/
```

See the [isConformanceValid\(\)](#) method for more information.

3. Query the `orddcm_conformance_vld_msgs` view to see the list of constraint messages generated during constraint validation for your data as follows:

```
select * from orddcm_conformance_vld_msgs;
```

See the [orddcm\\_conformance\\_vld\\_msgs](#) view for more information.

If your DICOM content does not conform to the constraint rules defined for your organization, you can write another ORDDicom object with corrected DICOM metadata (see [Task 5: Write and Edit DICOM Metadata](#)).

## 3.2.9 Task 9: Protect Confidential Patient Data

Oracle Multimedia DICOM provides support to protect the privacy of patients by ensuring the confidentiality of patient data. In general, call the `isAnonymous()` method before calling the `makeAnonymous()` method to check if the confidential patient data for a specified ORDDicom object has been removed or replaced, according to a specified anonymity document. Call the `makeAnonymous()` method to remove or replace confidential patient data. This method creates a new ORDDicom object, and preserves the original ORDDicom object.

Both of these methods use anonymity documents, XML documents that are stored in the repository, to determine the patient identifying information that must be made anonymous. In addition to specifying the set of attributes to be made anonymous, anonymity documents specify the actions to be taken to make those attributes anonymous.

After installation, you can use the default anonymity document shipped with Oracle Multimedia DICOM. Or, you can add customized anonymity documents to overwrite or remove confidential patient data, as necessary.

The following subsections list the steps for administrators and developers to perform when making confidential data anonymous:

- [Protecting Privacy: Administrator Tasks](#)
- [Protecting Privacy: Developer Tasks](#)

### 3.2.9.1 Protecting Privacy: Administrator Tasks

As an administrator, perform the following tasks to initiate the process of making confidential patient data anonymous:

1. Create an anonymity document that defines the DICOM attributes to be removed or replaced.  
See [About Creating Anonymity Documents](#) for more information.
2. Load the anonymity document into the data model repository.  
See [About Inserting Documents into the Repository](#) for more information.

### 3.2.9.2 Protecting Privacy: Developer Tasks

As a developer, perform the following tasks to complete the process of making confidential patient data anonymous:

1. Query the `orddcm_documents` view to see the list of anonymity documents that have been loaded into the data model repository as follows:

```
select * from orddcm_documents;
```

See the [orddcm\\_documents](#) view for more information.

2. Create an empty ORDDicom object using the empty ORDDicom constructor if you plan to call the `makeAnonymous()` method. The empty ORDDicom object is used as a placeholder for the new ORDDicom object. Create the empty object as follows:

```
insert into medical_image_obj (id, dicom_src)
values (3, ORDDicom());
```

See [ORDDicom Constructors](#) for more information.

3. Call the `isAnonymous()` method to check if the original ORDDicom object is anonymous, in accordance with the specified anonymity document.

```
select t.dicom_src.isAnonymous('ordcman.xml') from medical_image_obj t;
```

See the [isAnonymous\(\)](#) method for more information.

4. Call the `makeAnonymous()` method to copy the original ORDDicom object, make it anonymous, and then write the new DICOM content into the new, empty ORDDicom object. Call this method as follows:

```
declare
  obj_src orddicom;
  obj_dest orddicom;
  dest_sop_instance_uid varchar2(128) := '<unique-UID>';
begin
  select dicom_src, dicom_dest into obj_src, obj_dest
  from medical_image_obj where id = 1 for update;
  obj_src.makeAnonymous(dest_sop_instance_uid, obj_dest, 'ordcman.xml');

  update medical_image_obj set dicom_dest = obj_dest where id = 1;
end;
/
```

See the [makeAnonymous\(\)](#) method for more information.

## 3.2.10 Task 10: Improve Storage When Extracting DICOM Attributes

Oracle Multimedia DICOM provides the ability to limit the list of DICOM attributes extracted by the `setProperties()` method. Extracting only a selected set of attributes instead of all the attributes improves the performance of the `setProperties()` method and reduces storage requirements. Oracle Multimedia DICOM provides this support with a stored tag list configuration document in the repository. A stored tag list document specifies the DICOM attributes to be extracted from the embedded DICOM content and stored in the XML metadata attribute of the ORDDicom object when the `setProperties()` method is called.

See [About Creating Stored Tag List Documents](#) for more information about creating stored tag list documents.

See [Sample Session 4: Inserting a Stored Tag List Document](#) for sample sessions that show how to insert a stored tag list document into the repository.

See the [generateTagListDocument\(\) Function](#) for reference information.

# 4

## DICOM Protocol Support

This chapter describes the Oracle Multimedia DICOM support for the DICOM protocol.

This chapter includes these sections:

- [Overview of DICOM Protocol Support for Oracle Database](#)
- [Contents of the Oracle DICOM Protocol Adapter Suite](#)
- [Deploying the Oracle DICOM Protocol Adapter Suite](#)
- [Configuring the Oracle DICOM Protocol Adapter](#)
- [Configuring DICOM Protocol Support for Oracle Database](#)
- [Image Versioning with the DICOM Protocol Adapter](#)
- [Extracting Private Attributes from DICOM Data with the DICOM Protocol Adapter](#)
- [Improving DICOM Metadata Extraction for BLOB Storage](#)

The following table contains links to additional information about the DICOM protocol located in other parts of this guide.

**Table 4-1 Roadmap for More DICOM Protocol Documentation in This Guide**

For:	See:
An overview of the DICOM protocol support for Oracle Database	<a href="#">DICOM Database Network Component for the DICOM Protocol Adapter</a>
Information about the characteristics of DICOM protocol documents	<a href="#">Characteristics of DICOM Protocol Documents</a>
How to information about creating a DICOM protocol document	<a href="#">Creating DICOM Protocol Documents</a>
How to information about inserting a DICOM protocol document into the DICOM data model repository	<a href="#">Inserting Documents into the Repository</a>
An example of inserting a DICOM protocol document into the DICOM repository	<a href="#">Sample Session 5: Inserting a DICOM Protocol Document</a>
Information about the DICOM XML schema for DICOM protocol documents	<a href="#">Table B-1</a>

For information about the DICOM conformance statement for the Oracle DICOM protocol adapter suite, see *Oracle Multimedia* on the Oracle Technology Network Web site.

 **Note:**

This chapter assumes that you are familiar with the process for deploying applications on WebLogic Server.

See *Oracle Fusion Middleware Deploying Applications to Oracle WebLogic Server* in the Oracle Fusion Middleware Online Documentation Library for complete documentation about application deployment on the WebLogic Application Server.

## 4.1 Overview of DICOM Protocol Support for Oracle Database

The DICOM standard specifies both an imaging file format and a networking protocol to be used in the medical imaging domain. Picture Archiving and Communication Systems (PACS) are designed to store and transfer medical images in the DICOM format using the DICOM network protocol. Medical imaging devices, such as CT scanners and MR machines, communicate with one or more PACS to store images. Health care professionals then review images using DICOM viewer applications that query PACS to retrieve relevant patient information and images.

In previous versions, Oracle Multimedia DICOM supported only the imaging file format. Beginning with Oracle Database 12c Release 1 (12.1), Oracle Multimedia DICOM added support for the DICOM networking protocol. This support allows Oracle Database to retrieve and manage images originally stored in PACS. It also allows DICOM viewers to view images stored and managed by Oracle Database.

DICOM protocol support enables users to import DICOM images into Oracle Database from PACS, query DICOM images stored in Oracle Database through DICOM viewers, retrieve DICOM images from Oracle Database to PACS, extract metadata associated with images, and generate preview images associated with the original DICOM images. The DICOM images, metadata, and preview images can be stored and managed in Oracle Database.

## 4.2 Contents of the Oracle DICOM Protocol Adapter Suite

The DICOM protocol adapter suite includes three Oracle WebLogic applications that are available as adapters to communicate with PACS, viewers, and other DICOM clients. The WebLogic applications interact with Oracle Database to perform operations based on the communications with the DICOM clients to store, query, and retrieve images from Oracle Database.

These applications run in the middle tier on the WebLogic Application Server. You can choose to deploy all or only selected components of the DICOM protocol adapter suite on WebLogic Server.

[Table 4-2](#) lists and briefly describes these application components:

**Table 4-2 Components in the DICOM Protocol Adapter Suite**

Name	Description
Oracle DICOM protocol adapter	The core application of the suite. Serves as a bridge between standard DICOM clients (such as PACS and DICOM viewers) and Oracle Database.
Oracle DICOM crawler	A scheduled service of the suite. Periodically queries a set of PACS using the DICOM protocol to import new DICOM images and DICOM metadata into Oracle Database.
Oracle DICOM WADO proxy	A service of the suite. Used to retrieve DICOM images from remote DICOM clients (such as PACS) by way of a WADO (Web Access to DICOM Persistent Objects)-formatted URL.

These subsections describe the components in this suite in more detail:

- [The Oracle DICOM Protocol Adapter](#)
- [The Oracle DICOM Crawler](#)
- [The Oracle DICOM WADO Proxy](#)

## 4.2.1 The Oracle DICOM Protocol Adapter

The [DICOM protocol adapter](#) is deployed as a ResourceAdapter in Oracle WebLogic Server. The adapter supports these DICOM protocol roles:

- C-ECHO SCP
- C-FIND SCP
- C-MOVE SCP
- C-STORE SCP
- C-STORE SCU

[Figure 4-1](#) shows how the DICOM protocol adapter interacts with other DICOM clients, such as DICOM viewers and PACS, as well as with Oracle Database.

**Figure 4-1 DICOM Protocol Adapter Interacting with Other Components**

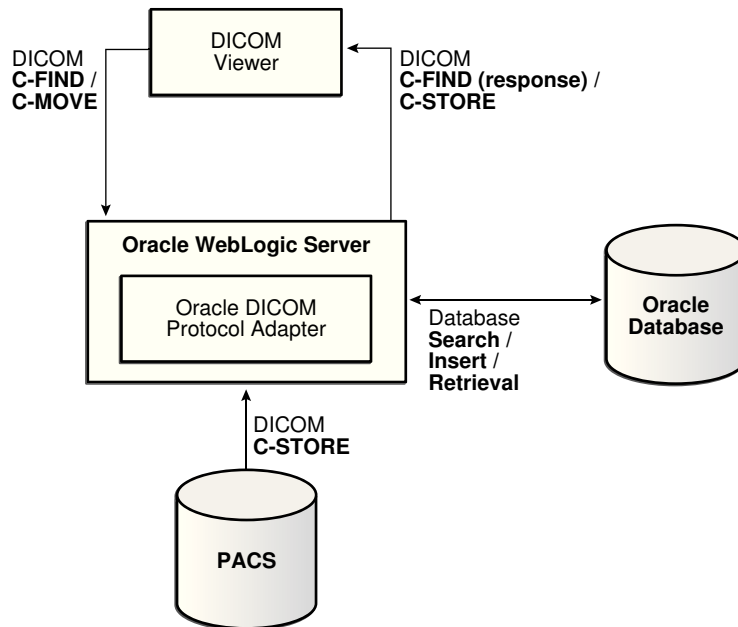

Specifically, [Figure 4-1](#) shows how a PACS might push an image to the DICOM protocol adapter for insertion into Oracle Database. And, it shows how a DICOM viewer might attempt to query and retrieve DICOM images from Oracle Database by way of the DICOM protocol adapter.

### DICOM Network Protocol Message Handling

The DICOM protocol adapter supports a set of message handling operations of the DICOM network protocol (as specified in the DICOM standard). [Table 4-3](#) describes the DICOM commands that DICOM clients can issue to the DICOM protocol adapter to query and retrieve DICOM image content stored in Oracle Database.

**Table 4-3 DICOM Protocol Adapter Message Handling Commands**

DICOM Command	Description
C-ECHO	Determines connectivity between the DICOM protocol adapter and a DICOM client. When the adapter receives a C-ECHO request, it issues a C-ECHO response indicating that the message was received and that the connection is good.
C-MOVE	Queries the DICOM protocol adapter to retrieve from the database images that match the specified metadata attributes (wildcards are supported) defined in the C-MOVE request.
C-STORE	Transfers an image to the DICOM protocol adapter. When the adapter receives a C-STORE request, it takes the associated DICOM image and stores the image in Oracle Database.
C-FIND	Queries the DICOM protocol adapter to retrieve image metadata that matches the specified query. Wildcards are supported in the queries.



## 4.2.2 The Oracle DICOM Crawler

The **DICOM crawler** is a scheduled service of the DICOM protocol adapter suite that periodically queries a set of PACS using the DICOM protocol to import new DICOM images or DICOM metadata into Oracle Database. It is deployed as a ResourceAdapter application in Oracle WebLogic Server.

Users can configure the DICOM crawler to periodically issue DICOM **C-FIND** requests to a PACS to identify DICOM images of interest according to user-specified search criteria. When the DICOM crawler identifies such images, it issues a **C-MOVE** request to the PACS to transfer these images to the DICOM protocol adapter. Then, the adapter checks in the images or the image metadata to Oracle Database.

Figure 4-2 shows how messages are exchanged between the DICOM crawler, PACS, and the DICOM protocol adapter.

**Figure 4-2 DICOM Crawler Exchanging Messages with Other Components**

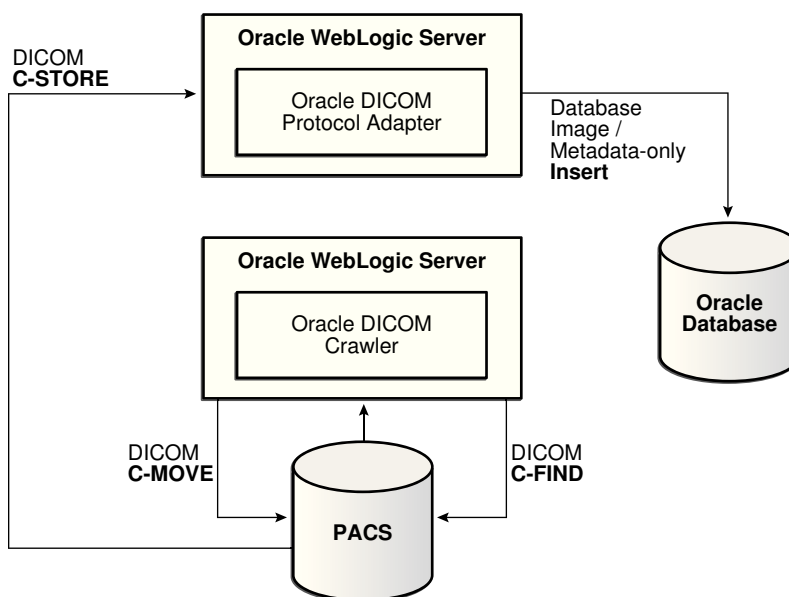

## 4.2.3 The Oracle DICOM WADO Proxy

The **DICOM WADO proxy** is a service that retrieves DICOM images through a WADO-formatted URL when the image metadata is in Oracle Database and the images are in the PACS.

The WADO proxy is deployed as a JAX-RS Servlet application in Oracle WebLogic Server. The proxy listens for HTTP GET requests that correspond to the retrieval of a specific DICOM image from a specific PACS. Both the Application Entity (AE) title of the PACS and the unique SOP instance UID of the image are encoded as part of the WADO URL.

When the proxy receives a WADO request like this, it issues a **C-MOVE** request to the corresponding PACS to retrieve the image. After the proxy receives the **C-STORE** request from the PACS with the DICOM image data corresponding to the **C-MOVE** it

issued, the proxy passes the DICOM image data to the HTTP client that issued the WADO request.

Figure 4-3 shows how the set of messages required to process a WADO request from a WADO client is exchanged between the various components. It also shows how this type of WADO URL is generated at insertion time for a DICOM image originating from a PACS.

**Figure 4-3 DICOM WADO Proxy Retrieving DICOM Images**

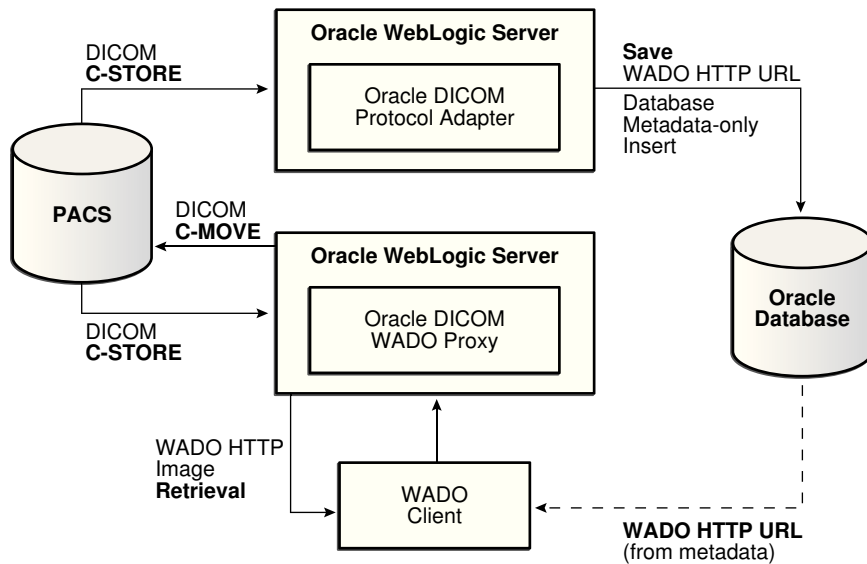

## 4.3 Deploying the Oracle DICOM Protocol Adapter Suite

This section describes how to install and deploy the DICOM protocol adapter suite. Before attempting these steps, ensure that Oracle WebLogic Server is installed and running.

You can find the files that are described in these steps in this directory:

```
<ORACLE_HOME>/ord/jlib
```

The complete process includes these steps:

1. Install and deploy the `OrdDicomLibrary.ear` archive file, which contains the Java classes and Java libraries required to run the Oracle DICOM protocol adapter suite (see [Deploying the Archive Files](#)).
2. Configure the `OrdDicomLibrary.ear` archive file for a standard or advanced deployment to choose individual components for installation (see [Performing a Standard Deployment](#) or [Performing an Advanced Deployment](#)).
3. Install and deploy the `OrdDicomAdapter.ear` archive file, which contains the files for each component in the Oracle DICOM protocol adapter suite.

This section includes these subsections:

- [Deploying the Archive Files](#)

- [Performing a Standard Deployment](#)
- [Performing an Advanced Deployment](#)
- [Modifying the Component Archive Files](#)

### 4.3.1 Deploying the Archive Files

The Oracle DICOM protocol adapter is distributed as two WebLogic enterprise archive files, as follows:

- `OrdDicomLibrary.ear`

This archive contains all the Java classes and other Java libraries required to run the adapter.

- `OrdDicomAdapter.ear`

This archive references the `OrdDicomLibrary.ear` archive file, and contains the XML descriptors and configuration files that are necessary to provide a bare-bones deployment configuration for the three components of the Oracle DICOM protocol adapter.

To deploy the `OrdDicomLibrary.ear` archive to WebLogic Server, use the `weblogic.Deployer` tool by issuing a command similar to this one:

```
java weblogic.Deployer -upload -name OrdDICOM -source OrdDicomLibrary.ear
-targets [target_name] -adminurl [weblogic_admin_url] -user [weblogic_user]
-deploy -library
```

To deploy the individual components of the Oracle DICOM protocol adapter suite, extract the contents of the `OrdDicomAdapter.ear` archive using the Java jar tool. Then modify the XML configuration files before deploying, as described in [Configuring the Oracle DICOM Protocol Adapter](#), [Configuring the Oracle DICOM Crawler](#), and [Configuring the Oracle DICOM WADO Proxy](#).

If the archive is extracted to a directory named `oracle-dicom`, the file structure of the directory appears as follows:

```
oracle-dicom/META-INF/MANIFEST.MF
oracle-dicom/META-INF/application.xml
oracle-dicom/META-INF/weblogic-application.xml
oracle-dicom/APP-INF/lib/dicom-net_adapter.jar
oracle-dicom/APP-INF/lib/dicom-net_adapter.rar
oracle-dicom/APP-INF/lib/dicom-net_crawler.jar
oracle-dicom/APP-INF/lib/dicom-net_crawler.rar
oracle-dicom/APP-INF/lib/dicom-net_wado.war
oracle-dicom/APP-INF/classes/ordim_adapter_config.xml
oracle-dicom/APP-INF/classes/ordim_crawler_config.xml
oracle-dicom/APP-INF/classes/ordim_wado_config.xml
```

The XML files in the `oracle-dicom/APP-INF/classes/` directory are the files used to configure the components of the Oracle DICOM protocol adapter suite.

The archive files in the `oracle-dicom/APP-INF/lib/` directory correspond to the modules comprising the Oracle DICOM protocol adapter.

The XML files in the `oracle-dicom/META-INF/` directory correspond to the WebLogic deployment descriptors describing all the modules and resources used in the application.

## 4.3.2 Performing a Standard Deployment

 **Note:**

Before attempting to deploy the Oracle DICOM protocol adapter, first you must deploy the `OrdDicomLibrary.ear` library to WebLogic Server and configure the DICOM Protocol support for Oracle Database.

See [Deploying the Archive Files](#) and [Configuring DICOM Protocol Support for Oracle Database](#) for details.

To deploy a single instance of each component of the Oracle DICOM protocol adapter suite, edit the XML files in the `oracle-dicom/APP-INF/classes/` directory.

After modifying the configuration files, as described in [Configuring the Oracle DICOM Protocol Adapter](#), issue a command similar to this one to deploy the application to WebLogic Server:

```
java weblogic.Deployer -upload -name OracleDicomAdapterSuite -source  
'oracle-dicom' -targets [weblogic_server] -adminurl [weblogic_admin_url]  
-user [weblogic_user] -deploy
```

This example assumes that you extracted the `OrdDicomAdapter.ear` archive to a directory named `oracle-dicom`.

This command deploys the three components of the Oracle DICOM protocol adapter suite to WebLogic Server, and then starts them.

## 4.3.3 Performing an Advanced Deployment

Although the components of the Oracle DICOM protocol adapter are bundled together in a single enterprise archive, you need not deploy all of them at the same time. For instance, you can deploy multiple instances of a particular component. Or, you can choose not to deploy a single instance of a particular component.

The `META-INF/application.xml` file describes the modules to be enabled at deployment time. [Example 4-1](#) shows a sample of this XML file:

In [Example 4-1](#), all three components of the Oracle DICOM protocol adapter suite are enabled. To disable any of these components, delete (or comment out) the module references that correspond to the component you want to remove.

Both the DICOM protocol adapter and the DICOM crawler components require at least two module definitions, as follows:

- `*.rar`  
This archive is the ResourceAdapter archive for the component (one is required for each component)
- `*.jar`  
This archive is the MessageDrivenBean (MDB) archive for the component (at least one is required for each component).

One module definition is required for each instance of the DICOM WADO proxy component (the \*.war archive)

By default, an Oracle DICOM protocol adapter configuration file is created for each MDB archive and for the WADO proxy archive, as shown in the following list:

- dicom-net\_adapter.jar and ordim\_adapter\_config.xml
- dicom-net\_crawler.jar and ordim\_crawler\_config.xml
- dicom-new\_wado.war and ordim\_wado\_config.xml

Follow these steps to deploy multiple instances of any of the three components of the Oracle DICOM protocol adapter suite:

1. Create a copy of the appropriate MDB (\*.jar) archive or WADO (\*.war) archive.
2. Modify the copy of the archive as described in [Modifying the Component Archive Files](#).
3. Place the modified archive with the original archive in the APP-INF/lib/ directory.
4. Place the new XML configuration file, which you modified in Step 2, in the APP-INF/classes/ directory.
5. Add a <module> entry in the META-INF/application.xml file for the new archive.
6. Deploy the components using the weblogic.Deployer tool (see [Performing a Standard Deployment](#)).

#### Example 4-1 Sample XML File for Advanced Deployment

```
<?xml version="1.0" encoding="UTF-8"?>
<application xmlns="http://java.sun.com/xml/ns/javaee"
             xmlns:xsi="http://www.w3.org/2001/XMLSchema-instance"
             xsi:schemaLocation="http://java.sun.com/xml/ns/javaee
http://java.sun.com/xml/ns/javaee/application_5.xsd"
             version="5">
  <!-- Oracle DICOM Protocol Adapter -->
  <module>
    <connector>/APP-INF/lib/dicom-net_adapter.rar</connector>
  </module>
  <module>
    <ejb>/APP-INF/lib/dicom-net_adapter.jar</ejb>
  </module>

  <!-- Oracle DICOM Crawler -->
  <module>
    <connector>/APP-INF/lib/dicom-net_crawler.rar</connector>
  </module>
  <module>
    <ejb>/APP-INF/lib/dicom-net_crawler.jar</ejb>
  </module>

  <!-- Oracle DICOM WADO Proxy -->
  <module>
    <web>
      <web-uri>/APP-INF/lib/dicom-net_wado.war</web-uri>
      <context-root>dicom-net</context-root>
    </web>
  </module>
</application>
```

## 4.3.4 Modifying the Component Archive Files

This section describes how to make required modifications to each Oracle DICOM protocol adapter component, in these subsections:

- [Modifying the DICOM Adapter Archive File](#)
- [Modifying the DICOM Crawler Archive File](#)
- [Modifying the DICOM WADO Proxy Archive File](#)

### 4.3.4.1 Modifying the DICOM Adapter Archive File

To modify the DICOM adapter `.jar` archive, you must rename the MDB and update the name of the XML configuration file. To make these changes, edit the `META-INF/ejb-jar.xml` file from the archive and change the parameter values as shown in bold italics in this code segment:

```
<message-driven>
  <display-name>DICOM_ADAPTER</display-name>
  <ejb-name>DICOM_ADAPTER</ejb-name>
  [...]
</message-driven>

<container-transaction>
  <method>
    <ejb-name>DICOM_ADAPTER</ejb-name>
    [...]
  </method>
  [...]
</container-transaction>

<activation-config-property>
  <activation-config-property-name>adapterConfig</activation-config-property-name>
  <activation-config-property-value>ordim_adapter_config.xml</activation-config-property-value>
</activation-config-property>
```

In addition, edit the `META-INF/weblogic-ejb-jar.xml` file from the archive and change the parameter values shown in bold italics in this code segment:

```
<weblogic-enterprise-bean>
  <ejb-name>DICOM_ADAPTER</ejb-name>
  [...]
</ weblogic-enterprise-bean>
```

### 4.3.4.2 Modifying the DICOM Crawler Archive File

To modify the `*.jar` archive to create a new instance of the Oracle DICOM crawler, you must rename the MDB and update the name of the XML configuration file. To make these changes, edit the `META-INF/ejb-jar.xml` file from the archive and change the parameter values as shown in bold italics in this code segment:

```
<message-driven>
  <display-name>DICOM_CRAWLER</display-name>
  <ejb-name>DICOM_CRAWLER</ejb-name>
  [...]
</message-driven>

<container-transaction>
  <method>
    <ejb-name>DICOM_CRAWLER</ejb-name>
    [...]
  </method>
  [...]
</container-transaction>
```

```

    </method>
    [...]
</container-transaction>

<activation-config-property>
  <activation-config-property-name>crawlerConfig</activation-config-property-name>
  <activation-config-property-value>ordim_crawler_config.xml</activation-config-property-value>
</activation-config-property>

```

In addition, edit the `META-INF/weblogic-ejb-jar.xml` file from the archive and change the parameter values shown in bold italics in this code segment:

```

<weblogic-enterprise-bean>
  <ejb-name>DICOM_CRAWLER</ejb-name>
  [...]
</ weblogic-enterprise-bean>

```

#### 4.3.4.3 Modifying the DICOM WADO Proxy Archive File

To modify WADO .war archive to create a new instance of the WADO proxy, you must rename the servlet and update the name of the XML configuration file. To make these changes, edit the `WEB-INF/web.xml` file from the archive and change the parameter values as shown in bold italics in this code segment:

```

<context-param>
  <param-name>wadoConfig</param-name>
  <param-value>ordim_wado_config.xml</param-value>
</context-param>

<servlet>
  <display-name>JAX-RS Servlet</display-name>
  <servlet-name>jersey</servlet-name>
  [...]
</servlet>

<servlet-mapping>
  <servlet-name>jersey</servlet-name>
  <url-pattern>/*</url-pattern>
</servlet-mapping>

```

## 4.4 Configuring the Oracle DICOM Protocol Adapter

This section describes how to configure the components in the Oracle DICOM protocol adapter suite, in these subsections:

- [Configuring the Oracle DICOM Protocol Adapter](#)
- [Configuring the Oracle DICOM Crawler](#)
- [Configuring the Oracle DICOM WADO Proxy](#)

### 4.4.1 Configuring the Oracle DICOM Protocol Adapter

The DICOM protocol adapter is configured by creating an XML file that adheres to the schema `ordim_adapter_config.xsd`. This XSD file is shipped in the `OrdDicomLibrary.ear` archive at this location: `APP-INF/lib/dicom-net.jar`.

**Example 4-2** lists the schema `ordim_adapter_config.xsd`. The XML include statement highlighted in bold calls the common data type definition schema `ordim_common.xsd`, which is listed in **Example 4-3**.

The XML file that is created contains these configurable elements: `<adapter>`, `<database>`, and `<DICOM>`.

### About the `<adapter>` Element

The `<adapter>` element is used to identify the DICOM host information for the DICOM protocol adapter.

The following table describes the `<adapter>` element in detail:

Element	Description
<code>&lt;title&gt;</code>	Specifies the DICOM AE title for the host.
<code>&lt;bind&gt;</code>	Specifies the port number the host is to listen on for incoming DICOM associations, and a Boolean value that specifies whether or not to use SSL/TLS for incoming connections.
<code>&lt;SSL&gt;</code>	Specifies the location of the keystore to use for any SSL/TLS connections and (optionally) the password to unlock the given keystore. If the password is not supplied here, it is retrieved by way of the credential map for the default WebLogic Server security realm associated with the resource adapter for the Oracle DICOM protocol adapter.

The following code segment shows an example of the `<adapter>` element:

```
<adapter>
  <title>DATABASE</title>
  <bind port="11112" useSSL="false"/>
  <SSL keystore="keystore.jks" password="pass"/>
</adapter>
```

### About the `<database>` Element

The `<database>` element is used to identify how to connect to Oracle Database server and configure the DICOM image and metadata storage.

The following table describes the `<database>` element in detail:

Element	Description
<code>&lt;connection&gt;</code>	Specifies these connection details: <ul style="list-style-type: none"> <li><code>&lt;url&gt;</code>: The URL used to connect to Oracle Database.</li> <li><code>&lt;schema&gt;</code>: The schema credentials (name and password) for the connection to Oracle Database. If the password is not supplied here, it is retrieved by way of the credential map for the default WebLogic Server security realm associated with the resource adapter for the Oracle DICOM protocol adapter.</li> </ul>
<code>&lt;configuration&gt;</code>	Specifies the name of the DICOM protocol document that defines the configuration to use for DICOM image and metadata storage when storing DICOM images by way of the Oracle DICOM protocol adapter.

The following code segment shows an example of the `<database>` element:

```
<database>
  <connection>
    <url location=" jdbc:oracle:oci8:@//hostname:1521/orcl"/>
    <schema name="user" password="pass"/>
  </connection>
</database>
```



```

    </connection>
    <configuration name="AdapterConfig1.xml"/>
</database>

```

### About the <DICOM> Element

The <DICOM> element is used to specify the DICOM-specific configuration, such as AE title to IP address and port mapping.

The following table describes the <DICOM> element in detail:

Element	Description
<hosts>	<p>Specifies the set of DICOM clients to which the adapter is permitted to connect, as follows:</p> <ul style="list-style-type: none"> <li>&lt;host&gt;: The AE title, IP address, and port of a remote DICOM client to which the Oracle DICOM protocol adapter can connect. This element also specifies whether or not to use SSL/TLS when connecting to the given DICOM client.</li> </ul>

The following code segment shows an example of the <DICOM> element:

```

<DICOM>
  <hosts>
    <host title="TESTPACS" address="testpacs.hostname" port="11112"/>
    <host title="WADO" address="127.0.0.1" port="12347" useSSL="false"/>
  </hosts>
</DICOM>

```

### About the Common Data Type Definition Schema

The schema `ordim_adapter_config.xsd` calls another schema, `ordim_common.xsd`, with the following XML include statement, which is highlighted in [Example 4-2](#):

```
<xs:include schemaLocation="ordim_common.xsd"/>
```

#### Note:

The schemas for the DICOM crawler and the DICOM WADO proxy also call the common schema `ordim_common.xsd`. For emphasis and consistency, this XML include statement is highlighted in [Example 4-4](#) and [Example 4-5](#) as well as in [Example 4-2](#).

[Example 4-3](#) lists the schema `ordim_common.xsd`. This schema contains the data type definitions for the components in the Oracle DICOM protocol adapter suite.

### Example 4-2 ordim\_adapter\_config.xsd Schema

```

<?xml version="1.0" encoding="ISO-8859-1" ?>
<xs:schema xmlns:xs="http://www.w3.org/2001/XMLSchema">
  <xs:include schemaLocation="ordim_common.xsd"/>

  <xs:complexType name="dicom_ucm_metadata_pairing_t">
    <xs:attribute name="tag" type="dicom_tag_t" use="required"/>
    <xs:attribute name="field" type="ucm_field_t" use="required"/>
  </xs:complexType>

  <xs:complexType name="ucm_property_t">

```

```

    <xs:attribute name="name" type="ucm_field_t" use="required"/>
    <xs:attribute name="value" type="ucm_field_value_t" use="required"/>
</xs:complexType>

<xs:complexType name="dicom_ucm_metadata_map_t">
  <xs:sequence>
    <xs:element name="entry" type="dicom_ucm_metadata_pairing_t" minOccurs="0" maxOccurs="unbounded"/>
  </xs:sequence>
</xs:complexType>

<xs:complexType name="dicom_tag_set_t">
  <xs:sequence>
    <xs:element name="tag" type="dicom_tag_t" minOccurs="0" maxOccurs="unbounded"/>
  </xs:sequence>
</xs:complexType>

<xs:complexType name="ucm_properties_map_t">
  <xs:sequence>
    <xs:element name="property" type="ucm_property_t" minOccurs="0" maxOccurs="unbounded"/>
  </xs:sequence>
</xs:complexType>

<xs:complexType name="ucm_config_t">
  <xs:sequence>
    <xs:element name="connection" type="ucm_connection_info_t"/>
    <xs:element name="properties" type="ucm_properties_map_t"/>
  </xs:sequence>
</xs:complexType>

<xs:complexType name="dicom_config_t">
  <xs:sequence>
    <xs:element name="hosts" type="dicom_host_config_t"/>
    <xs:element name="wado" minOccurs="0">
      <xs:complexType>
        <xs:attribute name="baseUrl" type="url_t" use="required"/>
      </xs:complexType>
    </xs:element>
    <xs:element name="selectedTags" type="dicom_tag_set_t"/>
    <xs:element name="tagMap" type="dicom_ucm_metadata_map_t"/>
  </xs:sequence>
</xs:complexType>

<xs:complexType name="ordim_adapter_config_t">
  <xs:sequence>
    <xs:element name="adapter" type="dicom_local_host_t"/>
    <xs:element name="UCM" type="ucm_config_t"/>
    <xs:element name="DICOM" type="dicom_config_t"/>
  </xs:sequence>
</xs:complexType>

<xs:element name="ordim_ucm_adapter_config" type="ordim_adapter_config_t"/>

</xs:schema>

```

### Example 4-3 ordim\_common.xsd Schema

```

<?xml version="1.0" encoding="ISO-8859-1" ?>
<xs:schema xmlns:xs="http://www.w3.org/2001/XMLSchema">
  <xs:complexType name="empty_t"/>

  <xs:simpleType name="boolean_t">
    <xs:restriction base="xs:boolean"/>
  </xs:simpleType>

  <xs:simpleType name="string_t">
    <xs:restriction base="xs:string"/>
  </xs:simpleType>

  <xs:simpleType name="nonempty_string_t">

```

```
<xs:restriction base="string_t">
  <xs:minLength value="1"/>
</xs:restriction>
</xs:simpleType>

<xs:simpleType name="integer_t">
  <xs:restriction base="xs:integer"/>
</xs:simpleType>

<xs:simpleType name="ae_title_t">
  <xs:restriction base="nonempty_string_t">
    <xs:pattern value="[ ]*(.[^ ])[ ]*" />
    <xs:maxLength value="16"/>
  </xs:restriction>
</xs:simpleType>

<xs:simpleType name="hostname_t">
  <xs:restriction base="nonempty_string_t"/>
</xs:simpleType>

<xs:simpleType name="network_port_t">
  <xs:restriction base="integer_t">
    <xs:minInclusive value="1"/>
    <xs:maxInclusive value="65535"/>
  </xs:restriction>
</xs:simpleType>

<xs:simpleType name="ssl_option_t">
  <xs:restriction base="boolean_t"/>
</xs:simpleType>

<xs:simpleType name="dicom_tag_t">
  <xs:restriction base="string_t">
    <xs:pattern value="[0-9a-fA-F]*" />
    <xs:length value="8" />
  </xs:restriction>
</xs:simpleType>

<xs:simpleType name="url_t">
  <xs:restriction base="nonempty_string_t">
  </xs:restriction>
</xs:simpleType>

<xs:simpleType name="ucm_username_t">
  <xs:restriction base="nonempty_string_t"/>
</xs:simpleType>

<xs:simpleType name="ucm_password_t">
  <xs:restriction base="nonempty_string_t"/>
</xs:simpleType>

<xs:simpleType name="database_username_t">
  <xs:restriction base="nonempty_string_t"/>
</xs:simpleType>

<xs:simpleType name="database_password_t">
  <xs:restriction base="nonempty_string_t"/>
</xs:simpleType>

<xs:simpleType name="database_repos_doc_name_t">
  <xs:restriction base="nonempty_string_t"/>
</xs:simpleType>

<xs:simpleType name="ucm_field_t">
  <xs:restriction base="nonempty_string_t"/>
</xs:simpleType>

<xs:simpleType name="ucm_field_value_t">
  <xs:restriction base="string_t"/>
```

```
</xs:simpleType>

<xs:simpleType name="keystore_t">
  <xs:restriction base="nonempty_string_t"/>
</xs:simpleType>

<xs:simpleType name="keystore_password_t">
  <xs:restriction base="string_t"/>
</xs:simpleType>

<xs:complexType name="network_bind_address_t">
  <xs:attribute name="address" type="hostname_t"/>
  <xs:attribute name="port" type="network_port_t" use="required"/>
  <xs:attribute name="useSSL" type="ssl_option_t"/>
</xs:complexType>

<xs:complexType name="network_remote_address_t">
  <xs:attribute name="address" type="hostname_t" use="required"/>
  <xs:attribute name="port" type="network_port_t" use="required"/>
</xs:complexType>

<xs:complexType name="dicom_simple_host_t">
  <xs:attribute name="title" type="ae_title_t" use="required"/>
</xs:complexType>

<xs:complexType name="ssl_config_t">
  <xs:attribute name="keystore" type="keystore_t" use="required"/>
  <xs:attribute name="password" type="keystore_password_t"/>
</xs:complexType>

<xs:complexType name="dicom_local_client_t">
  <xs:sequence>
    <xs:element name="title" type="ae_title_t"/>
    <xs:element name="SSL" type="ssl_config_t" minOccurs="0"/>
  </xs:sequence>
</xs:complexType>

<xs:complexType name="dicom_local_host_t">
  <xs:sequence>
    <xs:element name="title" type="ae_title_t"/>
    <xs:element name="bind" type="network_bind_address_t"/>
    <xs:element name="SSL" type="ssl_config_t" minOccurs="0"/>
  </xs:sequence>
</xs:complexType>

<xs:complexType name="dicom_remote_host_t">
  <xs:complexContent>
    <xs:extension base="network_remote_address_t">
      <xs:attribute name="title" type="ae_title_t" use="required"/>
      <xs:attribute name="useSSL" type="ssl_option_t"/>
    </xs:extension>
  </xs:complexContent>
</xs:complexType>

<xs:complexType name="ucm_login_info_t">
  <xs:attribute name="username" type="ucm_username_t" use="required"/>
  <xs:attribute name="password" type="ucm_password_t" use="required"/>
</xs:complexType>

<xs:complexType name="database_login_info_t">
  <xs:attribute name="name" type="database_username_t" use="required"/>
  <xs:attribute name="password" type="database_password_t" use="required"/>
</xs:complexType>

<xs:complexType name="url_location_t">
  <xs:attribute name="location" type="url_t" use="required"/>
</xs:complexType>

<xs:complexType name="ucm_connection_info_t">
```

```

<xs:sequence>
  <xs:element name="url" type="url_location_t"/>
  <xs:element name="login" type="ucm_login_info_t" minOccurs="0"/>
</xs:sequence>
</xs:complexType>

<xs:complexType name="database_connection_info_t">
  <xs:sequence>
    <xs:element name="url" type="url_location_t"/>
    <xs:element name="schema" type="database_login_info_t" minOccurs="0"/>
  </xs:sequence>
</xs:complexType>

<xs:complexType name="dicom_host_config_t">
  <xs:sequence>
    <xs:element name="host" type="dicom_remote_host_t" minOccurs="0" maxOccurs="unbounded"/>
  </xs:sequence>
</xs:complexType>
</xs:schema>

```

## 4.4.2 Configuring the Oracle DICOM Crawler

The Oracle DICOM crawler is configured by creating an XML file that adheres to the schema `ordim_crawler_config.xsd`. This XSD file is shipped in the `OrdDicomLibrary.ear` archive at this location: `APP-INF/lib/dicom-net.jar`.

[Example 4-4](#) lists the schema `ordim_crawler_config.xsd`. The XML include statement highlighted in bold calls the common data type definition schema `ordim_common.xsd`, which is listed in [Example 4-3](#).

This schema contains these configurable elements: `<crawler>`, `<jobs>`, `<hosts>`, and `<datasets>`.

### About the `<crawler>` Element

The `<crawler>` element specifies the DICOM host configuration for the DICOM crawler.

The following table describes the `<crawler>` element in detail:

Element	Description
<code>&lt;title&gt;</code>	Specifies the DICOM AE title for the crawler.

The following code segment shows an example of the `<crawler>` element:

```

<crawler>
  <title>DB_CRAWLER</title>
</crawler>

```

### About the `<jobs>` Element

The `<jobs>` element represents a single crawler job.

The following table describes the `<jobs>` element in detail:

Element	Description
<code>&lt;target&gt;</code>	Specifies the AE title of the DICOM client to search.
<code>&lt;dest&gt;</code>	Specifies the AE title of the DICOM host where DICOM images are to be sent.

Element	Description
<period>	Specifies the delay between job runs, including time units.
<search>	Specifies the list of queries to perform, in order, during the job invocation. Queries are chained such that the output of one query serves as the base data set for the next query.
<query>	Represents a single query, specifying the name of the data set and the DICOM search root to use.

The following code segment shows an example of the <jobs> element:

```
<jobs>
  <job>
    <target title=" PACS " />
    <dest title="DATABASE" />
    <period duration="15" timeUnit="s" />
    <search>
      <query searchRoot="study" dataset="Q1" />
      <query searchRoot="study" dataset="Q2" />
      <query searchRoot="study" dataset="Q3" />
    </search>
  </job>
</jobs>
```

### About the <hosts> Element

The <hosts> element specifies the set of DICOM clients to which the crawler is permitted to connect.

The following table describes the <hosts> element in detail:

Element	Description
<host>	Specifies the title, IP address, and port of a remote DICOM client to which the Oracle DICOM crawler can connect.

The following code segment shows an example of the <hosts> element:

```
<hosts>
  <host title="DATABASE" address="localhost" port="12345" />
  <host title="PACS " address="pacs.hostname" port="11112" />
</hosts>
```

### About the <datasets> Element

The <datasets> element specifies the set of DICOM data sets to use as part of the queries for the crawler jobs. Each data set is assigned a name that can be referenced in the query tag for a job.

The following table describes the <datasets> element in detail:

Element	Description
<dataset>	Specifies a single data set.
<value>	Specifies a DICOM tag and its corresponding value, as a tag-value pair.

The following code segment shows an example of the <datasets> element:

```
<datasets>
  <dataset name="Q1">
    <value tag="00080052">STUDY</value>
    <value tag="0020000D">*</value>
  </dataset>
  <dataset name="Q2">
    <value tag="00080052">SERIES</value>
    <value tag="0020000E">*</value>
  </dataset>
  <dataset name="Q3">
    <value tag="00080052">IMAGE</value>
    <value tag="00080018">*</value>
  </dataset>
</datasets>
```

#### Example 4-4 ordim\_crawler\_config.xsd Schema

```
<?xml version="1.0" encoding="ISO-8859-1" ?>
<xs:schema xmlns:xs="http://www.w3.org/2001/XMLSchema">
  <xs:include schemaLocation="ordim_common.xsd"/>

  <xs:simpleType name="dicom_value_t">
    <xs:restriction base="string_t"/>
  </xs:simpleType>

  <xs:complexType name="dicom_tag_value_t">
    <xs:simpleContent>
      <xs:extension base="dicom_value_t">
        <xs:attribute name="tag" type="dicom_tag_t" use="required"/>
      </xs:extension>
    </xs:simpleContent>
  </xs:complexType>

  <xs:complexType name="dicom_dataset_t">
    <xs:sequence>
      <xs:element name="value" type="dicom_tag_value_t" minOccurs="0" maxOccurs="unbounded"/>
    </xs:sequence>
  </xs:complexType>

  <xs:complexType name="named_dicom_dataset_t">
    <xs:complexContent>
      <xs:extension base="dicom_dataset_t">
        <xs:attribute name="name" type="nonempty_string_t" use="required"/>
      </xs:extension>
    </xs:complexContent>
  </xs:complexType>

  <xs:simpleType name="dicom_search_root_t">
    <xs:restriction base="string_t">
      <xs:enumeration value="patient"/>
      <xs:enumeration value="study"/>
      <xs:enumeration value="no_root"/>
    </xs:restriction>
  </xs:simpleType>

  <xs:simpleType name="time_unit_t">
    <xs:restriction base="string_t">
      <xs:enumeration value="ms"/>
      <xs:enumeration value="s"/>
      <xs:enumeration value="h"/>
      <xs:enumeration value="m"/>
      <xs:enumeration value="d"/>
    </xs:restriction>
  </xs:simpleType>
```

```

<xs:complexType name="dicom_query_t">
  <xs:attribute name="searchRoot" type="dicom_search_root_t"/>
  <xs:attribute name="dataset" type="nonempty_string_t"/>
</xs:complexType>

<xs:complexType name="dicom_query_list_t">
  <xs:sequence>
    <xs:element name="query" type="dicom_query_t" minOccurs="0" maxOccurs="unbounded"/>
  </xs:sequence>
</xs:complexType>

<xs:complexType name="crawler_period_t">
  <xs:attribute name="start" type="nonempty_string_t"/>
  <xs:attribute name="duration" type="integer_t" use="required"/>
  <xs:attribute name="timeUnit" type="time_unit_t"/>
</xs:complexType>

<xs:complexType name="crawler_job_t">
  <xs:sequence>
    <xs:element name="target" type="dicom_simple_host_t"/>
    <xs:element name="dest" type="dicom_simple_host_t"/>
    <xs:element name="period" type="crawler_period_t"/>
    <xs:element name="search" type="dicom_query_list_t"/>
  </xs:sequence>
</xs:complexType>

<xs:complexType name="crawler_job_list_t">
  <xs:sequence>
    <xs:element name="job" type="crawler_job_t" minOccurs="0" maxOccurs="unbounded"/>
  </xs:sequence>
</xs:complexType>

<xs:complexType name="dicom_dataset_set_t">
  <xs:sequence>
    <xs:element name="dataset" type="named_dicom_dataset_t" minOccurs="0" maxOccurs="unbounded"/>
  </xs:sequence>
</xs:complexType>

<xs:complexType name="ordim_crawler_config_t">
  <xs:sequence>
    <xs:element name="crawler" type="dicom_local_client_t"/>
    <xs:element name="jobs" type="crawler_job_list_t"/>
    <xs:element name="hosts" type="dicom_host_config_t"/>
    <xs:element name="datasets" type="dicom_dataset_set_t"/>
  </xs:sequence>
</xs:complexType>

<xs:element name="ordim_crawler_config" type="ordim_crawler_config_t"/>

</xs:schema>

```

### 4.4.3 Configuring the Oracle DICOM WADO Proxy

The Oracle DICOM WADO proxy is configured by creating an XML file that adheres to the schema `ordim_wado_config.xsd`. This XSD file is shipped in the `OrdDicomLibrary.ear` archive at this location: `APP-INF/lib/dicom-net.jar`.

[Example 4-5](#) lists the schema `ordim_wado_config.xsd`. The XML include statement highlighted in bold calls the common data type definition schema `ordim_common.xsd`, which is listed in [Example 4-3](#).

This schema contains these configurable elements: `<wado>` and `<hosts>`.



### About the <wado> Element

The <wado> element is used to identify the DICOM host information for the Oracle DICOM WADO proxy.

The following table describes the <wado> element in detail:

Element	Description
<wado>	Identifies the DICOM host information for the proxy.
<title>	Specifies the DICOM AE title for the host.
<bind>	Specifies the port number the host listens on for incoming DICOM associations.

The following code segment shows an example of the <wado> element:

```
<wado useSSL="false">
  <title>WADO</title>
  <bind port="12347"/>
</wado>
```

### About the <hosts> Element

The <hosts> element specifies the set of DICOM clients to which the proxy is permitted to connect.

The following table describes the <hosts> element in detail:

Element	Description
<host>	Specifies the AE title, IP address, and port of a remote DICOM client to which the Oracle DICOM proxy can connect.

The following code segment shows an example of the <hosts> element:

```
<hosts>
  <host title="DATABASE" address="localhost" port="12345"/>
  <host title="PACS " address="pacs.hostname" port="11112"/>
</hosts>
```

### Example 4-5 ordim\_wado\_config.xsd Schema

```
<?xml version="1.0" encoding="ISO-8859-1" ?>
<xs:schema xmlns:xs="http://www.w3.org/2001/XMLSchema">
  <xs:include schemaLocation="ordim_common.xsd"/>

  <xs:complexType name="ordim_wado_config_t">
    <xs:sequence>
      <xs:element name="wado" type="dicom_local_host_t"/>
      <xs:element name="hosts" type="dicom_host_config_t"/>
    </xs:sequence>
  </xs:complexType>

  <xs:element name="ordim_wado_config" type="ordim_wado_config_t"/>
</xs:schema>
```

## 4.5 Configuring DICOM Protocol Support for Oracle Database

A DICOM data model configuration document type, `DICOM_PROTOCOL`, is added for Oracle Multimedia DICOM protocol support. Administrators can use this document type to manage the behavior of a DICOM protocol adapter instance that stores DICOM images and metadata in one or more tables in Oracle Database. A [DICOM protocol document](#) is a named container for user-configurable parameters that govern where DICOM images and metadata are stored, such as table and column names. Each instance of the Oracle DICOM protocol adapter that is configured to connect to Oracle Database must have an associated DICOM protocol document in order to store, search, query, and retrieve DICOM images and metadata to and from Oracle Database.

Any table used by the DICOM protocol adapter instance to store images or metadata must satisfy these requirements:

- The table must contain a SOP instance UID (0008,0018) column.
- Table columns that are mapped to DICOM attributes with a value representation (VR) of `DA` must be of type `DATE`.
- Table columns that are mapped to DICOM attributes with a VR other than `DA` must be of type `VARCHAR2`.

Oracle recommends specifying the SOP instance UID column as the primary key for the table.

Administrators can manage DICOM protocol documents as part of the Oracle Multimedia DICOM data model using the `ORD_DICOM_ADMIN` data model repository interface. For example, to insert a new DICOM protocol document into the data model, invoke the procedure `ORD_DICOM_ADMIN.insertDocument` and specify `DICOM_PROTOCOL` as the value of the `docType` parameter.

See the DICOM protocol document schema (`ordcmdp.xsd`) for details about the available elements and attributes for the `<storage>` tag.

### See Also:

- [ORD\\_DICOM\\_ADMIN Package Reference](#) for more details about the available Oracle Multimedia DICOM functions and procedures for managing the DICOM data model
- [About Inserting DICOM Protocol Documents](#) for more information about how to insert DICOM protocol documents in the repository
- [Creating DICOM Protocol Documents](#) for more information about how to create DICOM protocol documents
- [Sample Session 5: Inserting a DICOM Protocol Document](#) for the steps required to insert DICOM protocol documents into the repository

## 4.6 Image Versioning with the DICOM Protocol Adapter

The DICOM protocol adapter supports image versioning. Thus, if multiple images with the same SOP instance UID are sent to the DICOM protocol adapter, instead of discarding duplicate images, it retains multiple versions of the images.

Versioning is enabled by a user-specified version column for each table defined in the DICOM protocol document. Although the name of the version column can differ for each table, all tables in the configuration must specify a version column.

A strictly increasing sequence assigns a version number to each image when it is stored in Oracle Database. Thus, each image is uniquely identified by its corresponding SOP instance UID-Version Number pair. When retrieving an image, Oracle Database returns the image with the largest version number.

The following example shows a sample DICOM protocol document for a deployment that uses versioning.

```
<?xml version="1.0"?>
<DICOM_PROTOCOL xmlns="http://xmlns.oracle.com/ord/dicom/protocol_1_0"
  xmlns:dt="http://xmlns.oracle.com/ord/dicom/datatype_1_0"
  xmlns:xsi="http://www.w3.org/2001/XMLSchema-instance"
  xsi:schemaLocation="http://xmlns.oracle.com/ord/dicom/protocol_1_0
  http://xmlns.oracle.com/ord/dicom/protocol_1_0">
  <STORAGE table='test.dicom_orcl_meta' id_col="sop_instance_uid" ver_col="meta_ver">
    <ATTRIBUTE column='STUDY_INSTANCE_UID' tag="0020000D"/>
    <ATTRIBUTE column='SERIES_INSTANCE_UID' tag="0020000E"/>
  </STORAGE>
  <STORAGE table='test.dicom_orcl_dcm' id_col="sop_instance_uid" ver_col="dicom_ver">
    <DICOM column="blob_data" type="BLOB" retain="true"/>
  </STORAGE>
</DICOM_PROTOCOL>
```

## 4.7 Extracting Private Attributes from DICOM Data with the DICOM Protocol Adapter

The DICOM protocol adapter supports the extraction of private attribute tags based on a group number and a tag name. Using this feature does not require knowing the element number of the tag.

Follow these steps to use this feature:

1. Create a private dictionary document that describes the private attribute.

The following example shows a sample private dictionary document that defines a private attribute (0031,XX00), where *x* is a wildcard matching any hexadecimal digit:

```
<?xml version="1.0"?>
<DICOM_PRIVATE_ATTRIBUTES
  xmlns="http://xmlns.oracle.com/ord/dicom/privateDictionary_1_0"
  xmlns:dt="http://xmlns.oracle.com/ord/dicom/datatype_1_0"
  xmlns:xsi="http://www.w3.org/2001/XMLSchema-instance"
  xsi:schemaLocation="http://xmlns.oracle.com/ord/dicom/
  privateDictionary_1_0
  http://xmlns.oracle.com/ord/dicom/privateDictionary_1_0">
  <PRIVATE_ATTRIBUTE_DEFINITION>
    <TAG>0031XX00</TAG>
    <NAME>LINKED ATTRIBUTES 1.0</NAME>
    <DEFINER>LINKED ATTRIBUTES 1.0</DEFINER>
    <VR>UN</VR>
```

```
<VM>1</VM>
</PRIVATE_ATTRIBUTE_DEFINITION>
</DICOM_PRIVATE_ATTRIBUTES>
```

2. Insert the private dictionary document into the DICOM data model repository of Oracle Database.
3. Configure the DICOM protocol adapter to use the private attribute.

This example shows a sample DICOM protocol document that configures the DICOM protocol adapter to use the defined private attribute. The values of the attributes `tag_name` and `definer` of the element `<SPECIAL_TAG>` in the DICOM protocol adapter configuration document must match the values of the tags `<NAME>` and `<DEFINER>`, respectively, in the `<PRIVATE_ATTRIBUTE_DEFINITION>` section of the private dictionary document.

```
?xml version="1.0"?>
<DICOM_PROTOCOL xmlns="http://xmlns.oracle.com/ord/dicom/protocol_1_0"
  xmlns:dt="http://xmlns.oracle.com/ord/dicom/datatype_1_0"
  xmlns:xsi="http://www.w3.org/2001/XMLSchema-instance"
  xsi:schemaLocation="http://xmlns.oracle.com/ord/dicom/protocol_1_0
  http://xmlns.oracle.com/ord/dicom/protocol_1_0">
  <STORAGE table='test.dicom_orcl_meta' id_col="sop_instance_uid">
    <ATTRIBUTE column="STUDY_INSTANCE_UID" tag="0020000D"/>
    <ATTRIBUTE column="SERIES_INSTANCE_UID" tag="0020000E"/>
    <SPECIAL_TAG column="DICOM_00311000" tag_name="LINKED ATTRIBUTES 1.0"
      definer="LINKED ATTRIBUTES 1.0"/>
  </STORAGE>
  <STORAGE table='test.dicom_orcl_dcm' id_col="sop_instance_uid">
    <DICOM column="blob_data" type="BLOB"/>
  </STORAGE>
</DICOM_PROTOCOL>
```

#### See Also:

- [About Creating Private Dictionary Documents](#) for detailed information about creating private dictionary documents
- [About Inserting Documents into the Repository](#) for information about how to insert private dictionary documents into the repository
- [Creating DICOM Protocol Documents](#) for more information about DICOM protocol documents

## 4.8 Improving DICOM Metadata Extraction for BLOB Storage

To improve the performance when extracting DICOM metadata from DICOM images stored in BLOBs, you can specify a mapping document to use during the metadata extraction. The mapping document specifies the attributes to be extracted. Using a mapping document in this way provides performance improvements that are similar to inserting a stored tag list document for use with ORDDicom storage.

The following example shows a sample DICOM protocol document for a deployment that specifies a mapping document:

```
<?xml version="1.0"?>
<DICOM_PROTOCOL xmlns="http://xmlns.oracle.com/ord/dicom/protocol_1_0"
```

```
xmlns:dt="http://xmlns.oracle.com/ord/dicom/datatype_1_0"  
xmlns:xsi="http://www.w3.org/2001/XMLSchema-instance"  
xsi:schemaLocation="http://xmlns.oracle.com/ord/dicom/protocol_1_0  
http://xmlns.oracle.com/ord/dicom/protocol_1_0">  
<ADMIN_DOC doc_type='MAPPING' doc_name="ordcmm.xml" doc_option="STANDARD"/>  
<STORAGE table='test.dicom_orcl_meta' id_col="sop_instance_uid">  
  <ATTRIBUTE column="STUDY_INSTANCE_UID" tag="0020000D"/>  
  <ATTRIBUTE column="SERIES_INSTANCE_UID" tag="0020000E"/>  
</STORAGE>  
<STORAGE table='test.dicom_orcl_dcm' id_col="sop_instance_uid">  
  <DICOM column="blob_data" type="BLOB"/>  
</STORAGE>  
</DICOM_PROTOCOL>
```

 **See Also:**

- [About Creating Mapping Documents and Metadata XML Schemas](#) for more information about mapping documents
- [About Creating Stored Tag List Documents](#) for more information about stored tag list documents

# 5

## DICOM Data Model Utility Reference

Oracle Multimedia provides the DICOM data model utility in the `ORD_DICOM` package. Oracle Multimedia DICOM also defines public views for the DICOM repository.

The functions, procedures, and views in the DICOM data model utility interface can be used by DICOM developers and administrators of the DICOM data model repository.

For administrative operations related to the Oracle Multimedia DICOM data model repository, the `setDataModel()` procedure must be called at the beginning of each database session (see the [setDataModel\(\) Procedure](#)). Developers and administrators must call the `setDataModel()` procedure before calling any other DICOM methods, functions, or procedures.

The `ORD_DICOM` package is defined in the `ordcpksp.sql` file. After installation, this file is available in the Oracle home directory at:

```
<ORACLE_HOME>/ord/im/admin (on Linux and UNIX)
```

```
<ORACLE_HOME>\ord\im\admin (on Windows)
```

This chapter describes the functions, procedures, and views in the DICOM data model utility interface, which operate on the DICOM data model repository.

This chapter contains these sections:

- [Directory Definition and Setup for ORD\\_DICOM Examples](#)
- [DICOM Data Model Utility Functions](#)
- [DICOM Data Model Utility Procedures](#)
- [DICOM Repository Public Views](#)

### See Also:

[Table 3-1](#) for information about other DICOM application programming interfaces (APIs)

## 5.1 Directory Definition and Setup for ORD\_DICOM Examples

See the examples for each function or procedure in this chapter for specific directory definitions for DICOM data files and other details specific to that function or procedure.

## 5.2 DICOM Data Model Utility Functions

The ORD\_DICOM package defines these DICOM data model utility functions:

- [getDictionaryTag\( \) Function](#)
- [getMappingXPath\( \) Function](#)

### 5.2.1 getDictionaryTag( ) Function

#### Format

```
getDictionaryTag(attributeName IN VARCHAR2,  
                 definerName   IN VARCHAR2 DEFAULT 'DICOM')  
RETURN VARCHAR2
```

#### Description

Looks in the standard or private data dictionaries for the specified attribute name and definer name and returns the value of the attribute name as a hexadecimal DICOM attribute tag. This function can be used to get the hexadecimal tag value that is needed in the `getMappingXPath( )` function.

#### Parameters

##### **attributeName**

The name of specified attribute in the standard or private data dictionary (for example: `Patient's Name`). The maximum length of this parameter is 128 characters.

##### **definerName**

The definer name of the specified attribute in the standard or private data dictionary. The default name, `DICOM`, refers to the DICOM standard. The maximum length of this parameter is 64 characters.

#### Pragmas

None.

#### Exceptions

None.

#### Usage Notes

Before calling this function, call the `setDataModel( )` procedure.

Call the `setDataModel( )` procedure at these times:

- At the beginning of each database session
- Whenever the application requires the new data model changes

See the [setDataModel\( \) Procedure](#) for more information.

#### Examples

Get the specified DICOM attribute name and return its value as a hexadecimal tag:

```
exec ord_dicom.setDataModel();
select ord_dicom.getDictionaryTag('Patient's Name', 'DICOM') as Patient_Name
from dual;

PATIENT_NAME
-----
00100010

select ord_dicom.getDictionaryTag('Audio Type', 'DICOM') as Audio_Type from dual;

AUDIO_TYPE
-----
50XX2000
```

## 5.2.2 getMappingXPath( ) Function

### Format

```
getMappingXPath(tag IN VARCHAR2,
                docName IN VARCHAR2 DEFAULT 'ordcmap.xml',
                definerName IN VARCHAR2 DEFAULT 'DICOM')
RETURN VARCHAR2
```

### Description

Returns the absolute XPath expression associated with the specified DICOM attribute tag and definer name from the specified mapping document. The XPath expression that is returned can be used to obtain values from an extracted XML metadata document.

### Parameters

#### tag

A DICOM attribute tag from the specified mapping document, represented as an 8-character hexadecimal string (for example: 00100010).

#### docName

The name of a mapping document. The default name is `ordcmap.xml`.

#### definerName

The definer name of the DICOM attribute tag in the specified mapping document. The default name is `DICOM`, which refers to the DICOM standard.

### Pragmas

None.

### Exceptions

None.

### Usage Notes

Before calling this function, call the `setDataModel( )` procedure.

Call the `setDataModel( )` procedure at these times:

- At the beginning of each database session



- Whenever the application requires the new data model changes

See the [setDataModel\(\) Procedure](#) for more information.

To see a list of all the mapping documents in the data model repository, query the public view [orddcm\\_documents](#).

## Examples

### Example 1:

Return the XPATH expression for DICOM attributes other than SEQUENCE type attributes:

```
col map_xpath new_value xpath
exec ord_dicom.setDataModel();
select ord_dicom.getMappingXPath('00100010') map_xpath from dual;

MAP_XPATH
-----
/DICOM_OBJECT/PERSON_NAME[@tag="00100010" and @definer="DICOM"]/VALUE/text()

1 row selected.

----- extract attribute from a document
select '&xpath' as map_xpath from dual;
select xmlquery(
  'declare default element namespace
   "http://xmlns.oracle.com/ord/dicom/metadata_1_0"; &xpath'
  passing t.metadata returning content) as
  Patient_Name from metadata_tab t where id=1;

PATIENT_NAME
-----
Anonymous

1 row selected.
```

### Example 2:

Return the XPATH expression for DICOM SEQUENCE type attributes only:

```
col map_xpath new_value xpath
exec ord_dicom.setDataModel();
select ord_dicom.getMappingXPath('00082218') map_xpath from dual;

MAP_XPATH
-----
/DICOM_OBJECT/SEQUENCE[@tag="00082218" and @definer="DICOM"]

1 row selected.

----- extract attribute from a document
set long 1000
select '&xpath' as map_xpath from dual;
select xmlquery(
  'declare default element namespace
   "http://xmlns.oracle.com/ord/dicom/metadata_1_0"; &xpath'
  passing t.metadata returning content) as
  Anatomic_Region from metadata_tab t where id=2;

ANATOMIC_REGION
```

```

-----
<SEQUENCE xmlns="http://xmlns.oracle.com/ord/dicom/metadata_1_0"
tag="00082218"
definer="DICOM" name="Anatomic Region Sequence" offset="590"
length="52"><ITEM number="1"><SHORT_STRING tag="00080100"
definer="DICOM" name="Code Value" offset=
"606" length="8">T-11170</SHORT_STRING><SHORT_STRING tag="00080102"
definer="DICOM" name="Coding Scheme Designator" offset="622"
length="4">SNM3</SHORT_STRING><LONG_STRING tag="00080104" definer="DICOM"
name="Code Meaning" offset="634"
length="8">Maxilla</LONG_STRING></ITEM></SEQUENCE>

```

1 row selected.

where:

- `metadata_tab`: a table containing metadata that has been extracted from the DICOM content.

## 5.3 DICOM Data Model Utility Procedures

The `ORD_DICOM` package defines this DICOM data model utility procedure:

- [setDataModel\(\) Procedure](#)

### 5.3.1 setDataModel() Procedure

#### Format

```
setDataModel(modelName IN VARCHAR2 DEFAULT 'DEFAULT')
```

#### Description

Loads the data model repository from the database into the memory structures. This procedure must be called at the beginning of each database session. It can be called again whenever the application requires the new data model changes.

#### Parameters

##### modelName

The model name of the data model repository. The default name, `DEFAULT`, is the only value currently supported.

#### Pragmas

None.

#### Exceptions

None.

#### Usage Notes

To maximize performance, you may want to call this procedure only once during a database session.

If the data model has changed since you made the original call, and your application requires these data model changes, you can call this procedure again. Keep in mind, however, that subsequent calls to this procedure may result in changed behavior.

To use the same DICOM data model throughout a session, Oracle recommends following the call to this procedure with a COMMIT statement. Because data that is loaded by the setDataModel() procedure is subject to transaction semantics, the database session's copy of the data model is deleted during a rollback operation if the call to the setDataModel() procedure is made within the transaction that you are rolling back.

If you roll back the transaction in which you call the setDataModel() procedure, you may get an error message indicating that the data model is not loaded when you use the DICOM feature in the same session following the rollback operation. Call the setDataModel() procedure to reload the data model.

See the [rollbackDataModel\(\) Procedure](#) for more information.

### Examples

Load the repository from the database into memory:

```
exec ord_dicom.setdatamodel;
select * from orddcm_documents;
```

## 5.4 DICOM Repository Public Views

This section describes these Oracle Multimedia DICOM repository public views:

- [orddcm\\_conformance\\_vld\\_msgs](#)
- [orddcm\\_constraint\\_names](#)
- [orddcm\\_documents](#)
- [orddcm\\_document\\_types](#)

See [DICOM Repository Administrator Views](#) for information about the Oracle Multimedia DICOM repository view for administrators.

### 5.4.1 orddcm\_conformance\_vld\_msgs

#### Format

Column Name	Data Type	Description
SOP_INSTANCE_UID	VARCHAR2(128 CHAR)	SOP_INSTANCE_UID of DICOM content
RULE_NAME	VARCHAR2(64 CHAR)	Constraint rule name
MESSAGE	VARCHAR2(1999 CHAR)	Message
MSG_TYPE	VARCHAR2(20 CHAR)	Message type, valid values are: log, warning, or error
MSG_TIME	TIMESTAMP	Message generation time

#### Description

This view lists the constraint messages generated during constraint validation. The public READ and DELETE access privileges are granted for this view.

### Usage Notes

This view shows the constraint validation messages that are generated for a specified user schema only.

### Examples

Show the list of constraint validation messages that were generated for the predicate conditions defined in the specified constraint document. The conformance validation rule shown in this example is PatientModule, as defined in the DICOM standard.

SOP_INSTANCE_UID	RULE_NAME	MESSAGE	MSG_TYPE	MSG_TIME
1.2.840.114346. 3384726461.899958945. 2180235641.3197827030	PatientModule	Validation error: missing mandatory attribute for patient module	log	01-MAR-07 01.40.21.158337 PM
1.2.840.114346. 3384726461.899958945. 2180235641.3197827030	PatientModule	Warning: validation failure	warning	01-MAR-07 01.40.21.168322 PM

2 rows selected.

## 5.4.2 orddcm\_constraint\_names

### Format

Column Name	Data Type	Description
NAME	VARCHAR2(100)	Constraint name

### Description

This read-only view lists the constraint names. The public READ access privilege is granted for this view.

### Usage Notes

Before querying this view, call the setDataModel( ) procedure at least once during the database session. Call it again whenever the application requires the new data model changes.

See the [setDataModel\( \) Procedure](#) for more information.

### Examples

Show a list of the constraint names that are available after installation:

NAME
PatientModule
GeneralStudyModule
GeneralSeriesModule
SOPCommonModule
ImagePixelMacro

```
OracleOrdDicomImage
OracleOrdObject

7 rows selected.
```

### 5.4.3 orddcm\_documents

#### Format

Column Name	Data Type	Description
DOC_NAME	VARCHAR2(100)	Document name
DOC_TYPE	VARCHAR2(100)	Document type
CREATE_DATE	DATE	Document creation date
ISINSTALLED_BY_ORACLE	NUMBER(1)	A value of 1 indicates that the document was installed by Oracle. A value of 0 indicates that the document was loaded by an administrator.

#### Description

This read-only view lists details of the documents stored in the repository. The public READ access privilege is granted for this view.

#### Usage Notes

Before querying this view, call the `setDataModel()` procedure at least once during the database session. Call it again whenever the application requires the new data model changes.

See the [setDataModel\(\) Procedure](#) for more information.

#### Examples

Show a list of the configuration documents in the repository, by name, type, and date of creation and indicate whether the configuration document is Oracle-defined or user-defined. This example shows details about the default Oracle-defined configuration documents that are available upon installation.

```
-----
DOC_NAME          DOC_TYPE          CREATE_DA          INSTALLED_BY_ORACLE
-----
ordcmpv.xml      PRIVATE_DICTIONARY  04-FEB-09          1
ordcmap.xml      MAPPING            04-FEB-09          1
ordcman.xml      ANONYMITY          04-FEB-09          1
ordcmpf.xml      PREFERENCE         04-FEB-09          1
ordcmui.xml      UID_DEFINITION     04-FEB-09          1
ordcmcmc.xml     CONSTRAINT         04-FEB-09          1
ordcmcmd.xml     CONSTRAINT         04-FEB-09          1
ordcmct.xml     CONSTRAINT         04-FEB-09          1
ordcmsd.xml     STANDARD_DICTIONARY 04-FEB-09          1
```

```
9 rows selected.
```

## 5.4.4 orddcm\_document\_types

### Format

Column Name	Data Type	Description
DOC_TYPE	VARCHAR2(100)	<p>Document type code of the document type</p> <p>This column contains these values:</p> <p>STANDARD_DICTIONARY PRIVATE_DICTIONARY CONSTRAINT MAPPING ANONYMITY PREFERENCE UID_DEFINITION STORED_TAG_LIST DICOM_PROTOCOL</p>
SCHEMA_URL	VARCHAR2(700)	<p>The URL of the XML schema registered with Oracle XML DB that is associated with this document type</p> <p>This column contains these values, which are listed respective to the order of the values in the DOC_TYPE column:</p> <p><a href="http://xmlns.oracle.com/ord/dicom/standardDictionary_1_0">http://xmlns.oracle.com/ord/dicom/standardDictionary_1_0</a> <a href="http://xmlns.oracle.com/ord/dicom/privateDictionary_1_0">http://xmlns.oracle.com/ord/dicom/privateDictionary_1_0</a> <a href="http://xmlns.oracle.com/ord/dicom/constraint_1_0">http://xmlns.oracle.com/ord/dicom/constraint_1_0</a> <a href="http://xmlns.oracle.com/ord/dicom/mapping_1_0">http://xmlns.oracle.com/ord/dicom/mapping_1_0</a> <a href="http://xmlns.oracle.com/ord/dicom/anonymity_1_0">http://xmlns.oracle.com/ord/dicom/anonymity_1_0</a> <a href="http://xmlns.oracle.com/ord/dicom/preference_1_0">http://xmlns.oracle.com/ord/dicom/preference_1_0</a> <a href="http://xmlns.oracle.com/ord/dicom/UIDdefinition_1_0">http://xmlns.oracle.com/ord/dicom/UIDdefinition_1_0</a> <a href="http://xmlns.oracle.com/ord/dicom/attributeTag_1_0">http://xmlns.oracle.com/ord/dicom/attributeTag_1_0</a> <a href="http://xmlns.oracle.com/ord/dicom/protocol_1_0">http://xmlns.oracle.com/ord/dicom/protocol_1_0</a></p>

Column Name	Data Type	Description
DOC_TYPE_DESC	VARCHAR2(4000)	Document type description This column contains these values, which are listed respective to the order of the values in the DOC_TYPE column:  DICOM standard data dictionary Private data dictionary Constraint document Mapping document Anonymity document Preference document DICOM UID definition document Stored tag list document DICOM protocol document

### Description

This read-only view identifies the supported Oracle Multimedia DICOM document types. Use this view to find the list of codes for document types when inserting a new document into the Oracle Multimedia DICOM repository. The public READ access privilege is granted for this view.

### Usage Notes

None.

### Examples

Show the document type, schema URL, and document type description for the Oracle-installed configuration documents:

```

-----
DOC_TYPE           SCHEMA_URL                                     DOC_TYPE_DESC
-----
STANDARD_DICTIONARY  http://xmlns.oracle.com/ord/dicom/standardDictionary_1_0  DICOM Standard
                                                             Data Dictionary

PRIVATE_DICTIONARY  http://xmlns.oracle.com/ord/dicom/privateDictionary_1_0    Private Data
                                                             Dictionary

MAPPING              http://xmlns.oracle.com/ord/dicom/mapping_1_0              Mapping document

ANONYMITY            http://xmlns.oracle.com/ord/dicom/anonymity_1_0            Anonymity document

PREFERENCE           http://xmlns.oracle.com/ord/dicom/preference_1_0           Preference document

UID_DEFINITION       http://xmlns.oracle.com/ord/dicom/UIDdefinition_1_0        DICOM UID
                                                             definition document

CONSTRAINT           http://xmlns.oracle.com/ord/dicom/constraint_1_0            Constraint document

STORED_TAG_LIST      http://xmlns.oracle.com/ord/dicom/attributeTag_1_0          Stored tag list
                                                             document

DICOM_PROTOCOL       http://xmlns.oracle.com/ord/dicom/protocol_1_0              DICOM protocol
                                                             document

```

8 rows selected.

# Part II

## DICOM Development Usage and Reference

This part contains user and reference information for developers of DICOM applications.

This part includes these chapters:

- [DICOM Application Development](#)
- [ORDDicom Object Type Reference](#)
- [DICOM PL/SQL API Reference](#)



# 6

## DICOM Application Development

This chapter describes how to develop applications using Oracle Multimedia DICOM.

Oracle Multimedia DICOM provides support for Oracle Database with these application programming interfaces (APIs):

- DICOM PL/SQL API
- ORDDicom object API
- DICOM data model utility API
- DICOM Java API (Deprecated)

Using these interfaces, you can quickly develop applications to upload to the database, retrieve from it, and manipulate DICOM content.

This chapter includes examples of how to import DICOM content into the database, write SQL queries based on DICOM metadata, perform basic image processing, make anonymous copies of ORDDicom objects, and check DICOM content for conformance to user-defined constraint rules. Some examples were extracted from the tutorial **Managing DICOM Format Data in Oracle Database 12c**, and adapted for this manual. See [DICOM Sample Applications](#) for the location of this tutorial.

This chapter includes these sections:

- [Setting Up Your Environment](#)
- [Creating a Table with an ORDDicom Column](#)
- [Loading DICOM Content Using the SQL\\*Loader Utility](#)
- [Developing DICOM Applications Using the PL/SQL API](#)

### See Also:

*Oracle Multimedia* on the Oracle Technology Network Web site for additional examples, articles, and other information

## 6.1 Setting Up Your Environment

The examples in this chapter use the table `medical_image_table` with these four columns:

- `id`: an integer identifier
- `dicom`: an ORDSYS.ORDDicom object
- `imageThumb`: an ORDSYS.ORDImage object
- `anonDicom`: another ORDSYS.ORDDicom object

Before running the examples in this chapter, issue the following statements while connected to a user with privileges to create a directory object, where `c:\mydir\work` is the directory where the user `scott` can find the DICOM files:

```
CREATE OR REPLACE DIRECTORY FILE_DIR as 'c:\mydir\work';
GRANT READ ON DIRECTORY FILE_DIR TO scott;
```

To use a different directory for your DICOM files, replace `c:\mydir\work` with the directory specification where your files are located.

 **Note:**

All Oracle Multimedia objects and procedures provided by Oracle are defined in the schema `ORDSYS`.

## 6.2 Creating a Table with an ORDDicom Column

This section shows how to create a table with an ORDDicom column to store DICOM content.

The code segment shown in [Example 6-1](#) creates the table `medical_image_table`, with the four columns `id`, `dicom`, `imageThumb`, and `anonDicom`.

[Example 6-1](#) uses SecureFiles LOB storage for the media content. Oracle SecureFiles is a re-engineered binary large object (BLOB) that improves performance and strengthens the content management capabilities of Oracle Database.

 **See Also:**

- *Oracle Database SecureFiles and Large Objects Developer's Guide* for more information about SecureFiles LOBs
- *Oracle Multimedia User's Guide* for tuning tips with SecureFiles LOBs
- *Oracle Database Security Guide* for more information about creating secure passwords

### Example 6-1 Creating a Table for DICOM Content

```
create table medical_image_table
  (id          integer primary key,
   dicom       ordsys.orddicom,
   imageThumb  ordsys.ordimage,
   anonDicom   ordsys.orddicom)
--
-- metadata extraction expands the ORDDicom object, allow room
pctfree 60
--
-- Use SecureFiles LOBS for binary content
--
lob(dicom.source.localdata) store as SecureFile
  (nocache filesystem_like_logging),
lob(imageThumb.source.localdata) store as SecureFile
```

```

        (nocache filesystem_like_logging),
lob(anonDicom.source.localdata) store as SecureFile
        (nocache filesystem_like_logging),
--
-- disable in row storage for the extension
-- so that it does not consume page space
-- it is usually < 4k in size
--
lob(dicom.extension) store as SecureFile
        ( nocache disable storage in row ),
lob(anonDicom.extension) store as SecureFile
        ( nocache disable storage in row ),
--
-- store the metadata as a CLOB,
-- disable storage in row
--
xmltype dicom.metadata store as SecureFile clob
        ( nocache disable storage in row )
xmltype anonDicom.metadata store as SecureFile clob
        ( nocache disable storage in row )
;

```

## 6.3 Loading DICOM Content Using the SQL\*Loader Utility

This section shows how to use the SQL\*Loader utility to load DICOM content into an existing table in Oracle Database. SQL\*Loader is a high-performance utility for loading data from external files into tables in an Oracle database. The external data can be loaded across a network from a client system that differs from the system that is running the server for Oracle Database. The data can also be loaded locally on the same system as the database server.

A typical SQL\*Loader session accepts a control file and one or more data files as input. The control file defines how to load the data into the database. The output of the SQL\*Loader session is an Oracle database (where the data is loaded), a log file, and potentially, a discard file.

[Example 6-2](#) shows a control file for loading DICOM data into the table `medical_image_table`, which you created in [Example 6-1](#). The control file contains directives that map the input data, which is specified at the end of the control file as `sample1.dcm` and `sample2.dcm`, to the columns of the table `medical_image_table`. Only the `id` and `dicom` columns are loaded with externally supplied data. The `imageThumb` and `anonDicom` columns are initialized using constant and default values that are supplied in the control file.

Before invoking the SQL\*Loader utility, you can temporarily disable logging for the LOB data to be loaded into the `dicom` column. When logging is disabled, the data is written to the database table only, and not to the redo log. Disabling logging can reduce the amount of time needed to load the DICOM data by cutting in half the amount of I/O to be performed.

To disable logging for the DICOM content in the `dicom` column, use the following SQL command:

```
alter table medical_image_table modify lob(dicom.source.localData) (nocache nologging);
```

To invoke the SQL\*Loader utility, use the following command, then enter the password when prompted:

```
sqlldr userid=USER control=load_dicom.ctl
```

After the DICOM data is loaded, use the following SQL command to re-enable logging for the DICOM content in the `dicom` column:

```
alter table medical_image_table modify lob(dicom.source.localData) (nocache logging);
```

After the DICOM data is loaded into the table from the external files, another program is required to complete the initialization of the `dicom` column and to generate the data to populate the `imageThumb` and `anonDicom` columns. These tasks can be performed using methods of the `ORDDicom` object, as shown in [Example 6-3](#) (which includes a PL/SQL block). In this example, the `dicom` column is initialized using the `setProperties()` method. The `imageThumb` column object is created using the `processCopy()` method. And, the `anonDicom` column object is created using the `makeAnonymous()` method, which requires a unique identifier for one of its input arguments.

 **Note:**

[Example 6-3](#) is a complete code sample that includes a call to the `setDataModel()` procedure. Keep in mind that this procedure call might not be required in all situations.

See the [setDataModel\(\) Procedure](#) for more information about when to call this procedure.

[Example 6-3](#) defines a function `genUID()` to generate a unique identifier (UID) by concatenating the value of the `id` column with a DICOM UID root value that you must define. You can replace this function with another function that generates unique UIDs, in accordance with the standards for your organization.

The PL/SQL block in [Example 6-3](#) loops once over all the rows in the table `medical_image_table`. Then, it reads and accesses each DICOM image in three passes. The first pass sets the properties of the `dicom` column. The second pass creates a JPEG thumbnail image. And, the third pass creates an anonymous DICOM image to store in the `anonDicom` column. Because of these repeated read operations, you may want to alter the LOB storage property of the `dicom` column to enable caching of the DICOM content.

To enable caching for the DICOM content in the `dicom` column, use the following SQL command:

```
alter table medical_image_table modify lob(dicom.source.localData) (cache);
```

After the initialization is complete, use the following SQL command to disable caching for the DICOM content in the `dicom` column:

```
alter table medical_image_table modify lob(dicom.source.localData) (nocache logging);
```

[Developing DICOM Applications Using the PL/SQL API](#) describes this and other PL/SQL programs in more detail.

 **See Also:**

- *Oracle Database Utilities* for more information about using the SQL\*Loader utility to load objects and LOBs into Oracle Database
- *Oracle Database SecureFiles and Large Objects Developer's Guide* for more information about LOBs and logging

**Example 6-2 Loading DICOM Content**

```
-- This file is a SQL*LDR control file to load DICOM data
-- into the table MEDICAL_IMAGE_TABLE. The control file contains directives
-- to load DICOM data into the DICOM column. It also contains directives
-- to initialize the IMAGETHUMB and ANONDICOM columns. The data to be loaded
-- is specified in this file after the BEGINDATA delimiter.
--
-- The following command invokes the SQL*Loader utility and then prompts you
-- to enter the password for the specified userid.
--
  sqlldr userid=USER control=load_dicom.ctl
--
load data
--
-- The input data is contained in this file after the BEGINDATA delimiter.
--
infile *
into table medical_image_table
--
-- This example truncates the table. Change the following to "append"
-- if you want to add to an existing table.
--
truncate
fields terminated by whitespace optionally enclosed by '''
(
  --
  -- The primary key column.
  --
  id                integer external,
  --
  -- A filler field that holds the file path of the DICOM data.
  --
  dicomFilename     filler char,
  --
  -- Load the dicom column object
  --   The LOB attribute source.localData is loaded with the DICOM data.
  --   The srcType attribute is initialized to "local".
  --   The updateTime attribute is initialized to "SYSDATE".
  --   The LOB attribute extension is initialized with an empty LOB.
  --
  dicom             column object (
    source          column object (
      localData     lobfile(dicomFilename) terminated by EOF,
      srcType       constant 'local',
      updateTime    expression "SYSDATE"
    ),
    extension       lobfile(dicomFilename) terminated by EOF
                  defaultif dicom.source.srcType='local'
```

```

    ),
--
-- Initialize the imageThumb column object
-- The LOB attribute source.localData is initialized with an empty LOB.
-- This LOB will hold the content for the thumbnail image.
-- The local attribute is initialized to "1".
--
imageThumb      column object (
  source         column object (
    localData    lobfile(dicomFilename) terminated by EOF
                 defaultif imageThumb.source.local=X'1',
    local        constant 1
  )
),
--
-- Initialize the anonDicom column object
-- The LOB attributes source.localData and extension are initialized.
-- with empty LOBs.
-- The localData LOB will hold the content for the DICOM data to be
-- made anonymous.
-- The extension LOB is an internal field used by ORDDICOM.
-- The srcType attribute is initialized to "local".
--
anonDicom       column object (
  source         column object (
    localData    lobfile(dicomFilename) terminated by EOF
                 defaultif anonDicom.source.srcType='local',
    srcType      constant 'local'
  ),
  extension      lobfile(dicomFilename) terminated by EOF
                 defaultif dicom.source.srcType='local'
)
)
--
-- Input data begins here
--
-- ID DICOMFILENAME
BEGINDATA
  1  sample1.dcm
  2  sample2.dcm

```

### Example 6-3 Finish Loading and Initializing the DICOM Table

```

--
-- The ORDDicom method makeAnonymous() takes a unique UID as an input parameter.
-- This utility function generates a simple UID to use in this example.
-- Replace the string value of UID_ROOT with the DICOM UID for your organization.
--
create or replace function genUID(in_id varchar2)
return varchar2
is
  -- Declare the DICOM UID root value for your organization
  -- You must replace this value.
  UID_ROOT varchar2(128) := '<unique-UID root>';
begin
  return UID_ROOT || '.' || in_id;
end;
/
show errors;

```

```

--
-- This PL/SQL block loops over all the rows in the MEDICAL_IMAGE_TABLE and:
-- 1. Calls the ORDDicom method setProperties() to initialize the dicom column
-- 2. Calls the ORDDicom method processCopy() to create a JPEG thumbnail image
--    that is stored in the imageThumb column.
-- 3. Calls the ORDDicom method makeAnonymous() to create an anonymous version
--    of the dicom column. The new version is stored in the column anonDicom.
--
declare
  dcm ordsys.orddicom;
begin
  -- load the DICOM data model
  ord_dicom.setDatamodel;

  -- loop over all rows in the medical image table
  for rec in (select * from medical_image_table for update) loop

    -- initialize the dicom column
    rec.dicom.setProperties();

    -- create a JPEG thumbnail
    rec.dicom.processCopy('fileFormat=jpeg fixedScale=75,100', rec.imageThumb);

    -- make a new anonymous version of the ORDDicom object
    rec.dicom.makeAnonymous(genUID(rec.id), rec.anonDicom);
    -- write the objects back to the row
    update medical_image_table
    set dicom = rec.dicom,
        imageThumb = rec.imageThumb,
        anonDicom = rec.anonDicom
    where id = rec.id;

  end loop;
  commit;
end;
/

```

## 6.4 Developing DICOM Applications Using the PL/SQL API

This section builds on the code examples in [Creating a Table with an ORDDicom Column](#) and [Loading DICOM Content Using the SQL\\*Loader Utility](#). It shows PL/SQL code examples that store and manipulate DICOM content inside a database using Oracle Multimedia DICOM.

Oracle Multimedia DICOM enables you to store DICOM content in database tables with columns of type ORDDicom. The following code sample shows some attributes that are contained within an ORDDicom object in a database table.

```

SOP_INSTANCE_UID
SOP_CLASS_UID
STUDY_INSTANCE_UID
SERIES_INSTANCE_UID
Source (ORDDataSource)
Metadata (SYS.XMLType)
ContentLength (integer)
Internal attributes

```

The following subsections describe sample tasks you can perform in PL/SQL using the code examples in this section:

- [Selecting DICOM Attributes](#)
- [Creating Thumbnail Images and Changing Image Formats](#)
- [Making Anonymous Copies of ORDDicom Objects](#)
- [Checking the Conformance of ORDDicom Objects](#)
- [Handling Oracle Multimedia DICOM Exceptions in PL/SQL](#)

## 6.4.1 Selecting DICOM Attributes

This section shows how to access DICOM attributes from the DICOM content that you loaded in [Loading DICOM Content Using the SQL\\*Loader Utility](#).

After the table `medical_image_table` is populated and metadata has been extracted, you can access metadata using SQL queries. [Example 6-4](#) demonstrates how to select extracted DICOM metadata from the DICOM content.

Running [Example 6-4](#) generates the following output:

```

ID SOP_INSTANCE_UID
-----
1 1.2.392.200036.9116.2.2.2.1762676206.1077529882.102147

ID SOP_CLASS_UID
-----
1 1.2.840.10008.5.1.4.1.1.2

ID STUDY_INSTANCE_UID
-----
1 1.2.392.200036.9116.2.2.2.1762929498.1080638122.365416

ID SERIES_INSTANCE_UID
-----
1 1.2.392.200036.9116.2.2.2.1762929498.1080638122.503288

ID CONTENT_LENGTH
-----
1 525974

ID PATIENT_NAME          PATIENT_ID          MODALITY
-----
1 CANCIO 2HR          A-02-013          CT

```

### Example 6-4 Selecting Metadata from the DICOM Content

1. `SOP_INSTANCE_UID`.
2. `SOP_CLASS_UID`
3. `STUDY_INSTANCE_UID`
4. `SERIES_INSTANCE_UID`.
5. Content length (number of bytes of DICOM content)
6. Patient Name, Patient ID, and Modality from DICOM metadata

```

select id,
       t.dicom.getSOPInstanceUID() as SOP_Instance_UID
from medical_image_table t;

```

```

select id,
       t.dicom.getSOPClassUID() as SOP_Class_UID
from medical_image_table t;

```



```

select id,
       t.dicom.getStudyInstanceUID() as Study_Instance_UID
from medical_image_table t;

select id,
       t.dicom.getSeriesInstanceUID() as Series_Instance_UID
from medical_image_table t;

select id,
       t.dicom.getcontentlength() as content_Length
from medical_image_table t;

select m.id, t.PATIENT_NAME, t.PATIENT_ID, t.MODALITY
from medical_image_table m,
     xmltable
     (xmlnamespaces
      (default 'http://xmlns.oracle.com/ord/dicom/metadata_1_0'),
      '/DICOM_OBJECT'
      passing m.dicom.metadata
      columns
        patient_name varchar2(100)
          path './*[@name="Patient"'||'s Name']/VALUE',
        patient_id   varchar2(100)
          path './*[@name="Patient ID"]',
        modality     varchar2(100)
          path './*[@name="Modality"]'
     ) t ;

```

## 6.4.2 Creating Thumbnail Images and Changing Image Formats

This section demonstrates some image processing operations that can be invoked within the database.

As an example, to create a JPEG thumbnail image from a DICOM image, you generate a new `ORDImage` object from the `ORDDicom` object. Before you can complete this task, you must describe the desired properties of the new `ORDImage` object.

The following description generates a JPEG thumbnail image of size 75x100 pixels:

```
'fileFormat=jfif fixedScale=75 100'
```

The code segment shown in [Example 6-5](#) defines the procedure `generate_thumb()`, which performs these tasks:

- Populates the column `imageThumb` of the table `medical_image_table` with the identifier `source_id`.
- Generates an `ORDImage` object in the column by invoking the `processCopy()` method on the `ORDDicom` object in the source row.

The code statements in [Example 6-5](#) where these tasks are performed are highlighted in bold.

 **Note:**

[Example 6-5](#) is a complete code sample that includes a call to the `setDataModel()` procedure. Keep in mind that this procedure call might not be required in all situations.

See the [setDataModel\(\) Procedure](#) for more information about when to call this procedure.

Running [Example 6-5](#) generates the following output:

```
ID  T.IMAGETHUMB.GETWIDTH()  T.IMAGETHUMB.GETHEIGHT()  T.IMAGETHUMB.GETFILE
-----
1          75                100                JFIF
```

### Example 6-5 Generating and Processing the New ORDDImage Object

```
-- Set Data Model Repository
execute ordsys.ord_dicom.setDataModel();

create or replace procedure generate_thumb(source_id number, verb varchar2) is
    dcmSrc    ordsys.orddicom;
    imgDst    ordsys.ordimage;
begin
    select dicom, imageThumb into dcmSrc, imgDst from medical_image_table
        where id = source_id for update;
    dcmSrc.processCopy(verb, imgDst);

    update medical_image_table set imageThumb = imgDst where id = source_id;
    commit;
end;
/

-- Create a JPEG thumbnail image for our test DICOM
execute generate_thumb(1, 'fileFormat=jfif fixedScale=75 100');

-- look at our handiwork
column t.imageThumb.getFileFormat() format A20;
select id, t.imageThumb.getWidth(), t.imageThumb.getHeight(),
        t.imageThumb.getFileFormat()
from medical_image_table t;
```

## 6.4.3 Making Anonymous Copies of ORDDicom Objects

This section shows how to protect patient privacy by making ORDDicom objects anonymous.

To make ORDDicom objects anonymous, you must create a new ORDDicom object in which certain user-specifiable DICOM attributes have either been removed or overwritten in both the new DICOM content and the associated ORDDicom object metadata. An XML anonymity document specifies which DICOM attributes to remove or replace and what action to take to make each attribute anonymous.

The default anonymity document, `ordcman.xml`, is loaded during installation. You can create a customized anonymity document, but that topic is beyond the scope of this example. This example uses the default anonymity document.

The code segment in [Example 6-6](#) defines the procedure `generate_anon()`, which performs these tasks:

- Selects the original content `dicom` and the column `anonDicom` of the table `medical_image_table` with the identifier `source_id`.
- Generates an ORDDicom object in the column `anonDicom` by calling the `makeAnonymous()` method on the `dicom` in the source row.

If you run this code segment, replace the temporary UID for the variable `dest_sop_instance_uid` in the procedure `generate_anon` with a globally unique UID.

The code statement in [Example 6-6](#) where the `makeAnonymous()` method is called is highlighted in bold.

 **Note:**

[Example 6-6](#) is a complete code sample that includes a call to the `setDataModel()` procedure. Keep in mind that this procedure call might not be required in all situations.

See the [setDataModel\(\) Procedure](#) for more information about when to call this procedure.

Running [Example 6-6](#) generates the following output:

ID	PATIENT_NAME	PATIENT_ID
1	anonymous	anonymous

**Example 6-6 Populating the Column and Generating an Anonymous ORDDicom Object**

```
-- Set Data Model Repository

execute ordsys.ord_dicom.setDataModel();

create or replace procedure generate_anon(source_id number) is
  dcmSrc   ordsys.orddicom;
  anonDst  ordsys.orddicom;
  dest_sop_inst_uid varchar2(128) := '1.2.3';

begin
  select dicom, anonDicom into dcmSrc, anonDst from medical_image_table
     where id = source_id for update;
  dcmSrc.makeAnonymous(dest_sop_inst_uid, anonDst);
  update medical_image_table set anonDicom = anonDst where id = source_id;
  commit;
end;
/

-- Generate an Anonymous Copy of our test DICOM
execute generate_anon(1);

select m.id, t.PATIENT_NAME, t.PATIENT_ID
from medical_image_table m,
  xmltable
    (xmlnamespaces
```

```
(default 'http://xmlns.oracle.com/ord/dicom/metadata_1_0'),
  '/DICOM_OBJECT'
passing m.anondicom.metadata
columns
  patient_name varchar2(100)
             path './*[@name="Patient'''s Name"]/VALUE',
  patient_id   varchar2(100)
             path './*[@name="Patient ID"]'
) t ;
```

## 6.4.4 Checking the Conformance of ORDDicom Objects

This section shows how to check the conformance of ORDDicom objects against a set of user-specified constraint rules. Constraint rules are specified in one or more constraint documents. These XML documents specify attribute relationships and semantic constraints that cannot be expressed by the DICOM metadata schema.

A default constraint document, `ordcmct.xml`, is loaded during installation. You can create a customized constraint document, but that topic is beyond the scope of this example. This example uses the default constraint document.

The code segment in [Example 6-7](#) defines the procedure `check_conform()`, which performs these tasks:

- Selects the original content `dicom` of the table `medical_image_table` with the identifier `source_id`.
- Displays a line of output text, which indicates either of these conditions for the DICOM content:

- Conformance valid

```
isconformanceValid(OracleOrdObject): 1
```

- Not conformance valid

```
isconformanceValid(OracleOrdObject): 0
```

### Note:

[Example 6-7](#) is a complete code sample that includes a call to the `setDataModel()` procedure. Keep in mind that this procedure call might not be required in all situations.

See the [setDataModel\(\) Procedure](#) for more information about when to call this procedure.

Running [Example 6-7](#) generates the following output:

```
SQL> execute check_conform(1) ;
isconformanceValid(OracleOrdObject): 1
```

The value of 1 indicates that the DICOM content used in this example was valid because it conformed to the Oracle default constraint rules. If the DICOM content had not been valid, running the example would have returned a value of 0. And, one or more constraint messages generated during the previous conformance validation would have been found in the view `orddcm_conformance_vld_msgs`.

The following code segment shows the description of this view:

```
SQL> describe orddcm_conformance_vld_msgs;
```

Name	Null?	Type
SOP_INSTANCE_UID		VARCHAR2(128 CHAR)
RULE_NAME	NOT NULL	VARCHAR2(64 CHAR)
MESSAGE		VARCHAR2(1999 CHAR)
MSG_TYPE	NOT NULL	VARCHAR2(20 CHAR)
MSG_TIME	NOT NULL	TIMESTAMP(6)

You can query this view to examine any constraint messages that are generated during conformance validation. Because the DICOM content used in this example conformed with the Oracle constraint rules, there are no messages in the `orddcm_conformance_vld_msgs` view.

```
select * from orddcm_conformance_vld_msgs;
```

Thus, invoking the preceding select query generates the following output:

```
no rows selected
```

See [Task 8: Validate Conformance with DICOM Constraints](#) for information about what to do if your DICOM content does not conform to the constraint rules defined for your organization. See [DICOM Repository Public Views](#) for information about the view `orddcm_conformance_vld_msgs`.

#### Example 6-7 Checking DICOM Conformance

```
-- Set Data Model Repository
execute ordsys.ord_dicom.setDataModel();

create or replace procedure check_conform(source_id number) is
  dcmSrc   ordsys.orddicom;
begin
  select dicom into dcmSrc from medical_image_table
  where id = source_id;
  dbms_output.put_line('isconformanceValid(OracleOrdObject): ' ||
    dcmSrc.isConformanceValid('OracleOrdObject'));
end;
/
show errors;
```

## 6.4.5 Handling Oracle Multimedia DICOM Exceptions in PL/SQL

Possible errors that can occur during run time should always be handled in your application. This practice enables the program to continue its operation even when it encounters a run-time error. This practice also enables you to know what went wrong during program operation. Proper error handling practices ensure that, whenever possible, you are always able to recover from an error while running an application. In addition, proper error handling provides you with the information you need so you always know what went wrong.

When handling exceptions, PL/SQL uses exception blocks. For example, in PL/SQL, the exception can appear as:

```
BEGIN
<some program logic>
EXCEPTION
```

```
WHEN OTHERS THEN  
  <some exception logic>  
END;
```

When you design, code, and debug your application, you are aware of the places in your program where processing might stop due to a failure to anticipate an error. Those are the places in your program where you must add exception handling blocks to handle the potential errors.



**See Also:**

*Oracle Database PL/SQL Language Reference* for more information about handling PL/SQL exceptions

# 7

## DICOM PL/SQL API Reference

Oracle Multimedia DICOM provides a PL/SQL API, which is defined in the ORD\_DICOM PL/SQL package.

The ORD\_DICOM PL/SQL package provides functions and procedures to perform common operations such as format conversion, metadata extraction, and conformance validation. This package adds Oracle Multimedia support to medical image data stored in BLOBs and BFILEs.

Application developers who create medical imaging applications without using the Oracle Multimedia ORDDicom object type to store and manage medical image data in relational tables can use the Oracle Multimedia DICOM PL/SQL API to manage their medical image data. In addition, application developers who do not want to migrate their existing medical image applications to use Oracle Multimedia ORDDicom objects can use the DICOM PL/SQL API to manage their medical image data.

The ORD\_DICOM package is defined in the `ordcpksp.sql` file. After installation, this file is available in the Oracle home directory at:

`<ORACLE_HOME>/ord/im/admin` (on Linux and UNIX)

`<ORACLE_HOME>\ord\im\admin` (on Windows)

This chapter describes the functions and procedures in the DICOM PL/SQL API.

This chapter contains these sections:

- [Examples for DICOM PL/SQL API Functions and Procedures](#)
- [DICOM PL/SQL API Functions](#)
- [DICOM PL/SQL API Procedures](#)

### See Also:

[APIs for Use With Oracle Multimedia DICOM](#) for information about other DICOM application programming interfaces (APIs)

## 7.1 Examples for DICOM PL/SQL API Functions and Procedures

The functions and procedures for the DICOM PL/SQL API described in this chapter show examples based on the MEDICAL\_IMAGE\_REL table. See [MEDICAL\\_IMAGE\\_REL Table Definition](#) when reading through these examples.

Before using DICOM PL/SQL API functions and procedures, you must load some data into the table. For example, you can use SQL\*Loader or the `importFrom()` procedure. Substitute your DICOM files for those in the examples.

## 7.1.1 Directory Definition and Setup for DICOM PL/SQL API Examples

Before executing the examples, issue the following statements while connected to a user with privileges to create a directory object, where `c:\mydir\work` is the directory where the user `<user>` can find the DICOM files:

```
CREATE OR REPLACE DIRECTORY DICOMDIR as 'c:\mydir\work';  
GRANT READ, WRITE ON DIRECTORY DICOMDIR TO <user>;
```



### Note:

At the beginning of each database session, call the `setDataModel()` procedure.

See the [setDataModel\(\) Procedure](#) for more information.

## 7.1.2 MEDICAL\_IMAGE\_REL Table Definition

Before loading data into the table, you must create the table and columns where the data is to be stored. The following PL/SQL code segment creates the `MEDICAL_IMAGE_REL` table with five columns.

```
CREATE TABLE MEDICAL_IMAGE_REL  
(  
  id          integer primary key,  
  blob_src   blob,  
  bfile_src  bfile,  
  image_src  ordsys.ordimage,  
  blob_dest  blob  
);
```

where:

- `blob_src`: the source DICOM content in the BLOB.
- `bfile_src`: the source DICOM content in the BFILE.
- `image_src`: the source DICOM content in the ORDImage object.
- `blob_dest`: the destination DICOM content in the BLOB.

## 7.2 DICOM PL/SQL API Functions

The `ORD_DICOM` package defines these DICOM PL/SQL API functions:

- [extractMetadata\(\) for BFILES](#)
- [extractMetadata\(\) for BLOBs](#)
- [extractMetadata\(\) for ORDImage](#)
- [isAnonymous\(\) for BFILES](#)
- [isAnonymous\(\) for BLOBs](#)
- [isAnonymous\(\) for ORDImage](#)



- [isConformanceValid\( \) for BFILES](#)
- [isConformanceValid\( \) for BLOBs](#)
- [isConformanceValid\( \) for ORDImage](#)

## 7.2.1 extractMetadata( ) for BFILES

### Format

```
extractMetadata(data IN BFILE,  
               extractOption IN VARCHAR2 DEFAULT 'ALL',  
               docName IN VARCHAR2 DEFAULT 'ordcmmp.xml')  
RETURN SYS.XMLTYPE
```

### Description

Returns the DICOM metadata as an XML document for a specified mapping document. The default mapping document refers to the default metadata namespace [http://xmlns.oracle.com/ord/dicom/metadata\\_1\\_0](http://xmlns.oracle.com/ord/dicom/metadata_1_0).

### Parameters

#### data

The input DICOM content stored in a BFILE.

#### extractOption

A string that specifies the types of metadata to extract from the DICOM content. Valid values are: `ALL`, `MAPPED`, and `STANDARD`. The default is `ALL`.

When the value of the `extractOption` parameter is `ALL`, all attributes in the DICOM content are extracted. When the value is set to `MAPPED`, only mapped attributes are extracted. And, when the value is set to `STANDARD`, only attributes that conform to the DICOM standard and mapped attributes are extracted.

#### docName

The name of the mapping document. The default mapping document `ordcmmp.xml` is loaded during installation.

### Pragmas

None.

### Exceptions

None.

### Usage Notes

Use the preference parameter `XML_SKIP_ATTR` to specify size limits for DICOM attributes to be omitted when encoding into XML. See [Defining the XML\\_SKIP\\_ATTR Preference Parameter](#) for more information about this preference parameter.

Use the preference parameter `VALIDATE_METADATA` to specify whether the XML documents are validated against a specific XML schema that is registered with Oracle XML DB, either as a global or local XML schema. See [Defining the VALIDATE\\_METADATA Preference Parameter](#) for more information about this preference parameter.

Calling this function when the value of the preference parameter `VALIDATE_METADATA` is set to `true` raises an error if the metadata namespace in the mapping document is not available to the current user.

### Examples

Extract metadata from the DICOM content stored in a BFILE:

```
declare
  src bfile;
  metadata xmltype;
begin
  select bfile_src into src from medical_image_rel where id = 1 for update;
  metadata := ord_dicom.extractMetadata(src, 'all', 'ordcmmp.xml');
end;
/
```

## 7.2.2 extractMetadata( ) for BLOBs

### Format

```
extractMetadata(data IN BLOB,
               extractOption IN VARCHAR2 DEFAULT 'ALL',
               docName IN VARCHAR2 DEFAULT 'ordcmmp.xml')
RETURN SYS.XMLTYPE
```

### Description

Returns the DICOM metadata as an XML document for a specified mapping document. The default mapping document refers to the default metadata namespace `http://xmlns.oracle.com/ord/dicom/metadata_1_0`.

### Parameters

#### **data**

The input DICOM content stored in a BLOB.

#### **extractOption**

A string that specifies the types of metadata to extract from the DICOM content. Valid values are: `ALL`, `MAPPED`, and `STANDARD`. The default is `ALL`.

When the value of the `extractOption` parameter is `ALL`, all attributes in the DICOM content are extracted. When the value is set to `MAPPED`, only mapped attributes are extracted. And, when the value is set to `STANDARD`, only attributes that conform to the DICOM standard and mapped attributes are extracted.

#### **docName**

The name of the mapping document. The default mapping document `ordcmmp.xml` is loaded during installation.

### Pragmas

None.

### Exceptions

None.

## Usage Notes

Use the preference parameter `XML_SKIP_ATTR` to specify size limits for DICOM attributes to be omitted when encoding into XML. See [Defining the XML\\_SKIP\\_ATTR Preference Parameter](#) for more information about this preference parameter.

Use the preference parameter `VALIDATE_METADATA` to specify whether the XML documents are validated against a specific XML schema that is registered with Oracle XML DB, either as a global or local XML schema. See [Defining the VALIDATE\\_METADATA Preference Parameter](#) for more information about this preference parameter.

Calling this function when the value of the preference parameter `VALIDATE_METADATA` is set to `true` raises an error if the metadata namespace in the mapping document is not available to the current user.

## Examples

Extract metadata from the DICOM content stored in a BLOB:

```
declare
  src blob;
  metadata xmltype;
begin
  select blob_src into src from medical_image_rel where id = 1 for update;
  metadata := ord_dicom.extractMetadata(src, 'all', 'ordcmmp.xml');
end;
```

## 7.2.3 extractMetadata( ) for ORDImage

### Format

```
extractMetadata(data IN ORDSYS.ORDImage,
               extractOption IN VARCHAR2 DEFAULT 'ALL',
               docName IN VARCHAR2 DEFAULT 'ordcmmp.xml')
RETURN SYS.XMLTYPE
```

### Description

Returns the DICOM metadata as an XML document for a specified mapping document. The default mapping document refers to the default metadata namespace `http://xmlns.oracle.com/ord/dicom/metadata_1_0`.

### Parameters

#### **data**

The input DICOM content stored in an `ORDImage` object.

#### **extractOption**

A string that specifies the types of metadata to extract from the DICOM content. Valid values are: `ALL`, `MAPPED`, and `STANDARD`. The default is `ALL`.

When the value of the `extractOption` parameter is `ALL`, all attributes in the DICOM content are extracted. When the value is set to `MAPPED`, only mapped attributes are extracted. And, when the value is set to `STANDARD`, only attributes that conform to the DICOM standard and mapped attributes are extracted.

**docName**

The name of the mapping document. The default mapping document `ordcmmp.xml` is loaded during installation.

**Pragmas**

None.

**Exceptions**

None.

**Usage Notes**

Use the preference parameter `XML_SKIP_ATTR` to specify size limits for DICOM attributes to be omitted when encoding into XML. See [Defining the XML\\_SKIP\\_ATTR Preference Parameter](#) for more information about this preference parameter.

Use the preference parameter `VALIDATE_METADATA` to specify whether the XML documents are validated against a specific XML schema that is registered with Oracle XML DB, either as a global or local XML schema. See [Defining the VALIDATE\\_METADATA Preference Parameter](#) for more information about this preference parameter.

Calling this function when the value of the preference parameter `VALIDATE_METADATA` is set to `true` raises an error if the metadata namespace in the mapping document is not available to the current user.

**Examples**

Extract metadata from the DICOM content stored in an `ORDImage` object:

```
declare
  src ordimage;
  metadata xmltype;
begin
  select image_src into src from medical_image_rel where id = 1 for update;
  metadata := ord_dicom.extractMetadata(src, 'all', 'ordcmmp.xml');
end;
/
```

## 7.2.4 isAnonymous( ) for BFILEs

**Format**

```
isAnonymous(src IN BFILE,
            anonymityDocName IN VARCHAR2 DEFAULT 'ordcman.xml')
RETURN INTEGER
```

**Description**

Determines whether the input DICOM content is anonymous, using a specified anonymity document. This function returns a value of 1 if the data is anonymous; otherwise it returns a value of 0.

**Parameters****src**

The input DICOM content stored in a BFILE.

**anonymityDocName**

The name of the anonymity document. The default name is `ordcman.xml`.

**Pragmas**

None.

**Exceptions**

None.

**Usage Notes**

None.

**Examples**

Check if the DICOM content stored in a BFILE is anonymous:

```
select ord_dicom.isAnonymous(t.bfile_src, 'ordcman.xml')
  from medical_image_rel t where id = 1;
```

## 7.2.5 isAnonymous( ) for BLOBs

**Format**

```
isAnonymous(src IN BLOB,
            anonymityDocName IN VARCHAR2 DEFAULT 'ordcman.xml')
  RETURN INTEGER
```

**Description**

Determines whether the input DICOM content is anonymous, using a specified anonymity document. This function returns a value of 1 if the data is anonymous; otherwise it returns a value of 0.

**Parameters****src**

The input DICOM content stored in a BLOB.

**anonymityDocName**

The name of the anonymity document. The default name is `ordcman.xml`.

**Pragmas**

None.

**Exceptions**

None.

### Usage Notes

None.

### Examples

Check if the DICOM content stored in a BLOB is anonymous:

```
select ord_dicom.isAnonymous(t.blob_src, 'ordcman.xml')
  from medical_image_rel t where id = 1;
```

## 7.2.6 isAnonymous( ) for ORDImage

### Format

```
isAnonymous(src IN ORDSYS.ORDImage,
            anonymityDocName IN VARCHAR2 DEFAULT 'ordcman.xml')
  RETURN INTEGER
```

### Description

Determines whether the input DICOM content is anonymous, using a specified anonymity document. This function returns a value of 1 if the data is anonymous; otherwise it returns a value of 0.

### Parameters

#### src

The input DICOM content stored in an ORDImage object.

#### anonymityDocName

The name of the anonymity document. The default name is `ordcman.xml`.

### Pragmas

None.

### Exceptions

None.

### Usage Notes

None.

### Examples

Check if the DICOM content stored in an ORDImage object is anonymous:

```
select ord_dicom.isAnonymous(t.image_src, 'ordcman.xml')
  from medical_image_rel t where id = 1;
```

## 7.2.7 isConformanceValid( ) for BFILES

### Format

```
isConformanceValid(src IN BFILE,  
                   constraintName IN VARCHAR2)  
RETURN INTEGER
```

### Description

Performs a conformance validation check to determine whether the input DICOM content conforms to a specified set of constraints identified by the `constraintName` parameter. This function returns a value of 1 if conformance is valid; otherwise it returns a value of 0.

This function also logs error messages from the constraint documents, which can be viewed by querying the public view [orddcm\\_conformance\\_vld\\_msgs](#). The public view [orddcm\\_constraint\\_names](#) contains the list of constraint names.

### Parameters

#### **src**

The input DICOM content stored in a BFILE.

#### **constraintName**

The name of the constraint to be used for conformance validation checking.

### Pragmas

None.

### Exceptions

None.

### Usage Notes

If this function is called from a SQL query, ensure that the constraint rule definition does not contain any <ACTION> elements.

Use the preference parameter `EXP_IF_NULL_ATTR_IN_CONSTRAINT` to indicate whether to throw exceptions when encountering missing attributes or null attribute values during conformance validation. See [Defining the EXP\\_IF\\_NULL\\_ATTR\\_IN\\_CONSTRAINT Preference Parameter](#) for more information about this preference parameter.

### Examples

Delete any existing conformance validation messages. Check if the DICOM content stored in a BFILE is conformance valid. Then, show any new conformance validation messages that are generated.

```
-- clear the previous conformance validation messages  
delete from orddcm_conformance_vld_msgs;  
  
-- conformance validate the DICOM content  
declare  
  src bfile;
```

```
begin
  select bfile_src into src from medical_image_rel where id = 1;
  dbms_output.put_line('isConformanceValid(PatientModule) ' ||
    ord_dicom.isConformanceValid(src, 'PatientModule'));
end;
/

-- get the logged conformance validation messages
select message, msg_time time from orddcm_conformance_vld_msgs
  where rule_name='PatientModule';
```

## 7.2.8 isConformanceValid() for BLOBs

### Format

```
isConformanceValid(src IN BLOB,
                   constraintName IN VARCHAR2)
  RETURN INTEGER
```

### Description

Performs a conformance validation check to determine whether the input DICOM content conforms to a specified set of constraints identified by the `constraintName` parameter. This function returns a value of 1 if conformance is valid; otherwise it returns a value of 0.

This function also logs error messages from the constraint documents, which can be viewed by querying the public view [orddcm\\_conformance\\_vld\\_msgs](#). The public view [orddcm\\_constraint\\_names](#) contains the list of constraint names.

### Parameters

#### **src**

The input DICOM content stored in a BLOB.

#### **constraintName**

The name of the constraint to be used for conformance validation checking.

### Pragmas

None.

### Exceptions

None.

### Usage Notes

If this function is called from a SQL query, ensure that the constraint rule definition does not contain any <ACTION> elements.

Use the preference parameter `EXP_IF_NULL_ATTR_IN_CONSTRAINT` to indicate whether to throw exceptions when encountering missing attributes or null attribute values during conformance validation. See [Defining the EXP\\_IF\\_NULL\\_ATTR\\_IN\\_CONSTRAINT Preference Parameter](#) for more information about this preference parameter.



## Examples

Delete any existing conformance validation messages. Check if the DICOM content stored in a BLOB is conformance valid. Then, show any new conformance validation messages that are generated.

```
-- clear the previous conformance validation messages
delete from orddcm_conformance_vld_msgs;

-- conformance validate the DICOM content
declare
  src blob;
begin
  select blob_src into src from medical_image_rel where id = 1;
  dbms_output.put_line('isConformanceValid(PatientModule) ' ||
    ord_dicom.isConformanceValid(src, 'PatientModule'));
end;
/

-- get the logged conformance validation messages
select message, msg_time time from orddcm_conformance_vld_msgs
where rule_name='PatientModule';
```

## 7.2.9 isConformanceValid( ) for ORDImage

### Format

```
isConformanceValid(src IN ORDSYS.ORDImage,
                   constraintName IN VARCHAR2)
RETURN INTEGER
```

### Description

Performs a conformance validation check to determine whether the input DICOM content conforms to a specified set of constraints identified by the `constraintName` parameter. This function returns a value of 1 if conformance is valid; otherwise it returns a value of 0.

This function also logs error messages from the constraint documents, which can be viewed by querying the public view [orddcm\\_conformance\\_vld\\_msgs](#). The public view [orddcm\\_constraint\\_names](#) contains the list of constraint names.

### Parameters

#### **src**

The input DICOM content stored in an `ORDImage` object.

#### **constraintName**

The name of the constraint to be used for conformance validation checking.

### Pragmas

None.

### Exceptions

None.

## Usage Notes

If this function is called from a SQL query, ensure that the constraint rule definition does not contain any <ACTION> elements.

Use the preference parameter EXP\_IF\_NULL\_ATTR\_IN\_CONSTRAINT to indicate whether to throw exceptions when encountering missing attributes or null attribute values during conformance validation. See [Defining the EXP\\_IF\\_NULL\\_ATTR\\_IN\\_CONSTRAINT Preference Parameter](#) for more information about this preference parameter.

## Examples

Delete any existing conformance validation messages. Check if the DICOM content stored in an ORDImage object is conformance valid. Then, show any new conformance validation messages that are generated.

```
-- clear the previous conformance validation messages
delete from orddcm_conformance_vld_msgs;

-- conformance validate the DICOM content
declare
  src ordimage;
begin
  select image_src into src from medical_image_rel where id = 1;
  dbms_output.put_line('isConformanceValid(PatientModule) ' ||
    ord_dicom.isConformanceValid(src, 'PatientModule'));
end;
/

-- get the logged conformance validation messages
select message, msg_time time from orddcm_conformance_vld_msgs
  where rule_name='PatientModule';
```

## 7.3 DICOM PL/SQL API Procedures

The ORD\_DICOM package defines these DICOM PL/SQL API procedures:

- [createDicomImage\( \) for BFILES](#)
- [createDicomImage\( \) for BLOBs](#)
- [createDicomImage\( \) for ORDImage](#)
- [export\( \)](#)
- [importFrom\( \)](#)
- [makeAnonymous\( \) for BFILES](#)
- [makeAnonymous\( \) for BLOBs](#)
- [makeAnonymous\( \) for ORDImage](#)
- [processCopy\( \) for BFILES](#)
- [processCopy\( \) for BFILES with SOP Instance UID](#)
- [processCopy\( \) for BLOBs](#)
- [processCopy\( \) for BLOBs with SOP Instance UID](#)
- [processCopy\( \) for ORDImage](#)

- `processCopy()` for ORDIImage with SOP Instance UID
- `writeMetadata()` for BFILES
- `writeMetadata()` for BLOBs
- `writeMetadata()` for ORDIImage

 **Note:**

In this section, *<unique-UID>* represents a 64-byte, dot-concatenated, numeric string that represents a globally unique identifier for DICOM content worldwide. The UID is commonly constructed with a root that uniquely identifies the organization producing the DICOM content, and a suffix that uniquely identifies the DICOM content within that organization. For some examples in this section, you must replace *<unique-UID>* with the appropriate UID.

### 7.3.1 createDicomImage() for BFILES

#### Format

```
createDicomImage(src IN BFILE,  
                metadata IN SYS.XMLTYPE,  
                dest IN OUT NOCOPY BLOB)
```

#### Description

Creates a DICOM image from a source image and DICOM metadata. If the source content that is input to this procedure is DICOM content, the resulting destination DICOM content contains only the metadata that was input to this procedure in the metadata parameter. Thus, in the destination DICOM content, the metadata in the source DICOM content is removed and replaced by the metadata that was input.

#### Parameters

**src**

The source raster image stored in a BFILE.

**metadata**

DICOM metadata stored in data type XMLType. The metadata must include all standard and private attributes. It must include a new SOP instance UID for the destination DICOM image, ensuring that the destination DICOM content is globally unique.

**dest**

An empty BLOB in which to store the DICOM image created from the source image and metadata.

#### Pragmas

None.

## Exceptions

None.

## Usage Notes

See [DICOM Encoding Rules](#) for information about the encoding rules that support image content processing.

Use the preference parameter `VALIDATE_METADATA` to specify whether the XML documents are validated against the Oracle default DICOM metadata schema. See [Defining the `VALIDATE\_METADATA` Preference Parameter](#) for more information about this preference parameter.

## Examples

Create a DICOM image from a source BFILE and DICOM metadata:

```
declare
  src bfile;
  dest blob;
  metadata xmltype;
begin
  metadata := xmltype(bfilename('DICOMDIR', 'wm_meta.xml'),
                    nls_charset_id('AL32UTF8'),
                    'http://xmlns.oracle.com/ord/dicom/metadata_1_0');

  select bfile_src, blob_dest into src, dest from medical_image_rel
  where id = 1 for update;

  ord_dicom.createDicomImage(src, metadata, dest);
end;
/
```

## 7.3.2 createDicomImage( ) for BLOBs

### Format

```
createDicomImage(src IN BLOB,
                 metadata IN SYS.XMLTYPE,
                 dest IN OUT NOCOPY BLOB)
```

### Description

Creates a DICOM image from a source image and DICOM metadata. If the source content that is input to this procedure is DICOM content, the resulting destination DICOM content contains only the metadata that was input to this procedure in the metadata parameter. Thus, in the destination DICOM content, the metadata in the source DICOM content is removed and replaced by the metadata that was input.

### Parameters

#### **src**

The source raster image stored in a BLOB.

**metadata**

DICOM metadata stored in data type XMLType. The metadata must include all standard and private attributes. It must include a new SOP instance UID for the destination DICOM image, ensuring that the destination DICOM content is globally unique.

**dest**

An empty BLOB in which to store the DICOM image created from the source image and metadata.

**Pragmas**

None.

**Exceptions**

None.

**Usage Notes**

See [DICOM Encoding Rules](#) for information about the encoding rules that support image content processing.

Use the preference parameter `VALIDATE_METADATA` to specify whether the XML documents are validated against the Oracle default DICOM metadata schema. See [Defining the VALIDATE\\_METADATA Preference Parameter](#) for more information about this preference parameter.

**Examples**

Create a DICOM image from a source BLOB and DICOM metadata:

```
declare
  src blob;
  dest blob;
  metadata xmltype;
begin
  metadata := xmltype(bfilename('DICOMDIR', 'wm_meta.xml'),
                    nls_charset_id('AL32UTF8'),
                    'http://xmlns.oracle.com/ord/dicom/metadata_1_0');

  select blob_src, blob_dest into src, dest from medical_image_rel
     where id = 1 for update;

  ord_dicom.createDicomImage(src, metadata, dest);
end;
/
```

### 7.3.3 createDicomImage( ) for ORDImage

**Format**

```
createDicomImage(src IN ORDSYS.ORDImage,
                 metadata IN SYS.XMLTYPE,
                 dest IN OUT NOCOPY BLOB)
```

## Description

Creates a DICOM image from a source image and DICOM metadata. If the source content that is input to this procedure is DICOM content, the resulting destination DICOM content contains only the metadata that was input to this procedure in the metadata parameter. Thus, in the destination DICOM content, the metadata in the source DICOM content is removed and replaced by the metadata that was input.

## Parameters

### src

The source raster image stored in an ORDImage object.

### metadata

DICOM metadata stored in data type XMLType. The metadata must include all standard and private attributes. It must include a new SOP instance UID for the destination DICOM image, ensuring that the destination DICOM content is globally unique.

### dest

An empty BLOB in which to store the DICOM image created from the source image and metadata.

## Pragmas

None.

## Exceptions

None.

## Usage Notes

See [DICOM Encoding Rules](#) for information about the encoding rules that support image content processing.

Use the preference parameter `VALIDATE_METADATA` to specify whether the XML documents are validated against the Oracle default DICOM metadata schema. See [Defining the VALIDATE\\_METADATA Preference Parameter](#) for more information about this preference parameter.

## Examples

Create a DICOM image from a source ORDImage object and DICOM metadata:

```
declare
  src ordimage;
  dest blob;
  metadata xmltype;
begin
  metadata := xmltype(bfilename('DICOMDIR', 'wm_meta.xml'),
                    nls_charset_id('AL32UTF8'),
                    'http://xmlns.oracle.com/ord/dicom/metadata_1_0');

  select image_src, blob_dest into src, dest from medical_image_rel
  where id = 1 for update;

  ord_dicom.createDicomImage(src, metadata, dest);
```

```
end;  
/
```

## 7.3.4 export( )

### Format

```
export(src IN BLOB,  
       dest_type IN VARCHAR2,  
       dest_location IN VARCHAR2,  
       dest_name IN VARCHAR2)
```

### Description

Exports DICOM content in a BLOB to a specified destination. The data remains in the source BLOB when it is copied to the destination.

### Parameters

#### src

The source location of the DICOM content.

#### dest\_type

The type of the destination (only `FILE` is supported).

#### dest\_location

The location of the destination (must be a valid Oracle directory object).

#### dest\_name

The name of the destination file.

### Pragmas

None.

### Exceptions

None.

### Usage Notes

The `export( )` procedure writes only to a database directory object that the user has privilege to access. That is, you can access a directory object that you have created using the SQL statement `CREATE DIRECTORY`, or one to which you have been granted `READ` and `WRITE` access.

For example, the following SQL\*Plus commands create a directory object and grant the user `<user>` permission to read and write to any file within the directory `c:\mydir\work`. Before executing these commands, you must be connected as a user with privileges to create a directory object.

```
CREATE OR REPLACE DIRECTORY DICOMDIR AS 'c:\mydir\work';  
GRANT READ,WRITE ON DIRECTORY DICOMDIR TO <user>;
```

See [Examples for DICOM PL/SQL API Functions and Procedures](#) for more information about directory and table definitions.

## Examples

Export DICOM content from a BLOB to a specified file:

```
declare
  src blob;
begin
  select blob_src into src from medical_image_rel where id = 1;
  ord_dicom.export(src, 'FILE', 'DICOMDIR', 'exported.dcm');
end;
/
```

## 7.3.5 importFrom( )

### Format

```
importFrom(dest IN OUT NOCOPY BLOB,
           source_type IN VARCHAR2,
           source_location IN VARCHAR2,
           source_name IN VARCHAR2)
```

### Description

Imports DICOM content from a specified source into a BLOB.

### Parameters

#### **dest**

The storage destination of the imported DICOM file.

#### **source\_type**

The type of the source (only `FILE` is supported).

#### **source\_location**

The location of the source (must be a valid Oracle directory object).

#### **source\_name**

The name of the source file.

### Pragmas

None.

### Exceptions

None.

### Usage Notes

The `importFrom( )` procedure reads only from a database directory object that the user has privilege to access. That is, you can access a directory object that you have created using the SQL statement `CREATE DIRECTORY`, or one to which you have been granted `READ` access.

For example, the following SQL\*Plus commands create a directory object and grant the user `<user>` permission to read any file within the directory `c:\mydir\work`. Before executing these commands, you must be connected as a user with privileges to create a directory object.



```
CREATE OR REPLACE DIRECTORY DICOMDIR AS 'c:\mydir\work';  
GRANT READ ON DIRECTORY DICOMDIR TO <user>;
```

See [Examples for DICOM PL/SQL API Functions and Procedures](#) for more information about directory and table definitions.

### Examples

Import the DICOM content into a BLOB:

```
declare  
  dest blob;  
begin  
  select blob_dest into dest from medical_image_rel where id = 1 for update;  
  ord_dicom.importFrom(dest, 'file', 'DICOMDIR', 'example.dcm');  
end;  
/
```

## 7.3.6 makeAnonymous( ) for BFILES

### Format

```
makeAnonymous(src IN BFILE,  
             dest_sop_instance_uid IN VARCHAR2,  
             dest IN OUT NOCOPY BLOB,  
             anonymityDocName IN VARCHAR2 DEFAULT 'ordcman.xml')
```

### Description

Removes patient identifying information from the source DICOM content after copying it into another DICOM content BLOB, based on a specified anonymity document.

### Parameters

#### src

The input DICOM content stored in a BFILE.

#### dest\_sop\_instance\_uid

The SOP instance UID of the destination DICOM content. It must ensure that the destination DICOM content is globally unique.

#### dest

An empty BLOB in which to store the anonymous DICOM content.

#### anonymityDocName

The name of the anonymity document. The default name is `ordcman.xml`.

### Pragmas

None.

### Exceptions

None.

### Usage Notes

None.

## Examples

Remove patient identifying information from the embedded DICOM content stored in a BFILE:



### Note:

Replace *<unique-UID>* with the UID that identifies the organization producing the DICOM content and the DICOM content within that organization.

```
declare
  src bfile;
  dest blob;
  dest_sop_instance_uid varchar2(128) := '<unique-UID>';
begin
  select bfile_src, blob_dest into src, dest from medical_image_rel
  where id = 1 for update;
  ord_dicom.makeAnonymous(src, dest_sop_instance_uid, dest, 'ordcman.xml');
end;
/
```

## 7.3.7 makeAnonymous( ) for BLOBs

### Format

```
makeAnonymous(src IN BLOB,
              dest_sop_instance_uid IN VARCHAR2,
              dest IN OUT NOCOPY BLOB,
              anonymityDocName IN VARCHAR2 DEFAULT 'ordcman.xml')
```

### Description

Removes patient identifying information from the source DICOM content after copying it into another DICOM content BLOB, based on a specified anonymity document.

### Parameters

#### src

The input DICOM content stored in a BLOB.

#### dest\_sop\_instance\_uid

The SOP instance UID of the destination DICOM content. It must ensure that the destination DICOM content is globally unique.

#### dest

An empty BLOB in which to store the anonymous DICOM content.

#### anonymityDocName

The name of the anonymity document. The default name is `ordcman.xml`.

### Pragmas

None.

**Exceptions**

None.

**Usage Notes**

None.

**Examples**

Remove patient identifying information from the embedded DICOM content stored in a BLOB:

 **Note:**

Replace *<unique-UID>* with the UID that identifies the organization producing the DICOM content and the DICOM content within that organization.

```
declare
  src blob;
  dest blob;
  dest_sop_instance_uid varchar2(128) := '<unique-UID>';
begin
  select blob_src, blob_dest into src, dest from medical_image_rel
  where id = 1 for update;
  ord_dicom.makeAnonymous(src, dest_sop_instance_uid, dest, 'ordcman.xml');
end;
/
```

## 7.3.8 makeAnonymous( ) for ORDImage

**Format**

```
makeAnonymous(src IN ORDSYS.ORDImage,
              dest_sop_instance_uid IN VARCHAR2,
              dest IN OUT NOCOPY BLOB,
              anonymityDocName IN VARCHAR2 DEFAULT 'ordcman.xml')
```

**Description**

Removes patient identifying information from the source DICOM content after copying it into another DICOM content BLOB, based on a specified anonymity document.

**Parameters****src**

The input DICOM content stored in an ORDImage object.

**dest\_sop\_instance\_uid**

The SOP instance UID of the destination DICOM content. It must ensure that the destination DICOM content is globally unique.

**dest**

An empty BLOB in which to store the anonymous DICOM content.

**anonymityDocName**

The name of the anonymity document. The default name is `ordcman.xml`.

**Pragmas**

None.

**Exceptions**

None.

**Usage Notes**

None.

**Examples**

Remove patient identifying information from the embedded DICOM content stored in an `ORDImage` object:

**Note:**

Replace `<unique-UID>` with the UID that identifies the organization producing the DICOM content and the DICOM content within that organization.

```
declare
  src ordimage;
  dest blob;
  dest_sop_instance_uid varchar2(128) := '<unique-UID>';
begin
  select image_src, blob_dest into src, dest from medical_image_rel
  where id = 1 for update;
  ord_dicom.makeAnonymous(src, dest_sop_instance_uid, dest, 'ordcman.xml');
end;
/
```

## 7.3.9 processCopy( ) for BFILEs

**Format**

```
processCopy(src IN BFILE,
            command IN VARCHAR2,
            dest IN OUT NOCOPY BLOB)
```

**Description**

Reads the DICOM content that is input from the source BFILE, performs the specified processing operations on the image, and then stores the resulting image in the destination BLOB. The original DICOM content in the source BFILE remains unchanged.

## Parameters

### src

The input DICOM content stored in the source BFILE.

### command

A command string that accepts a processing operator as input. Valid values include: `fileFormat`, `frame`, `contentFormat`, `compressionFormat`, `cut`, `scale`, and `rotate`. See [DICOM Processing and Supported Formats](#) for information about processing operators.

### dest

An empty BLOB in which to store the destination content.

## Pragmas

None.

## Exceptions

None.

## Usage Notes

See [DICOM Encoding Rules](#) for information about the encoding rules that support DICOM content processing. See [DICOM Processing and Supported Formats](#) for more information about DICOM processing.

Use the preference parameter `VALIDATE_METADATA` to specify whether the XML documents are validated against the Oracle default DICOM metadata schema. See [Defining the VALIDATE\\_METADATA Preference Parameter](#) for more information about this preference parameter.

## Examples

Generate a new JPEG thumbnail image from a DICOM source:

```
declare
  src bfile;
  dest blob;
begin
  select bfile_src, blob_dest into src, dest from medical_image_rel
  where id = 1 for update;
  ord_dicom.processCopy(src, 'fileFormat=jpeg maxScale=100 100', dest);
end;
/
```

## 7.3.10 processCopy( ) for BFILES with SOP Instance UID

### Format

```
processCopy(src IN BFILE,
            command IN VARCHAR2,
            dest_sop_instance_uid IN VARCHAR2,
            dest IN OUT NOCOPY BLOB,
            metadata IN SYS.XMLTYPE DEFAULT NULL)
```

## Description

Reads the DICOM content that is input from the source BFILE, performs the specified processing operations on the image, updates it with the new metadata, and then stores the resulting image in the destination BLOB. The original DICOM content in the source BFILE remains unchanged.

## Parameters

### src

The input DICOM content stored in the source BFILE.

### command

A command string that accepts a processing operator as input. Valid values include: `frame`, `contentFormat`, `compressionFormat`, `cut`, `scale`, and `rotate`. See [DICOM Processing and Supported Formats](#) for information about processing operators.

### dest\_sop\_instance\_uid

The SOP instance UID of the destination DICOM content. It must ensure that the destination DICOM content is globally unique.

### dest

An empty BLOB in which to store the destination content.

### metadata

The new metadata to be written into the new DICOM content.

## Pragmas

None.

## Exceptions

None.

## Usage Notes

See [DICOM Encoding Rules](#) for information about the encoding rules that support DICOM content processing. See [DICOM Processing and Supported Formats](#) for more information about DICOM processing.

Use the preference parameter `VALIDATE_METADATA` to specify whether the XML documents are validated against the Oracle default DICOM metadata schema. See [Defining the VALIDATE\\_METADATA Preference Parameter](#) for more information about this preference parameter.

## Examples

Generate a new compressed DICOM image:

### Note:

Replace `<unique-UID>` with the UID that identifies the organization producing the DICOM content and the DICOM content within that organization.

```
src bfile;
dest blob;
dest_sop_instance_uid varchar2(128) := '<unique-UID>';
begin
select bfile_src, blob_dest into src, dest from medical_image_rel
where id = 1 for update;
ord_dicom.processCopy(
src, 'CompressionFormat=jpeg', dest_sop_instance_uid, dest);
end;
/
```

## 7.3.11 processCopy( ) for BLOBs

### Format

```
processCopy(src IN BLOB,
            command IN VARCHAR2,
            dest IN OUT NOCOPY BLOB)
```

### Description

Reads the DICOM content that is input from the source BLOB, performs the specified processing operations on the image, and then stores the resulting image in the destination BLOB. The original DICOM content in the source BLOB remains unchanged.

### Parameters

#### src

The input DICOM content stored in the source BLOB.

#### command

A command string that accepts a processing operator as input. Valid values include: `fileFormat`, `frame`, `contentFormat`, `compressionFormat`, `cut`, `scale`, and `rotate`. See [DICOM Processing and Supported Formats](#) for information about processing operators.

#### dest

An empty BLOB in which to store the destination content.

### Pragmas

None.

### Exceptions

None.

### Usage Notes

See [DICOM Encoding Rules](#) for information about the encoding rules that support DICOM content processing. See [DICOM Processing and Supported Formats](#) for more information about DICOM processing.

Use the preference parameter `VALIDATE_METADATA` to specify whether the XML documents are validated against the Oracle default DICOM metadata schema. See [Defining the VALIDATE\\_METADATA Preference Parameter](#) for more information about this preference parameter.

## Examples

Create a new JPEG thumbnail image:

```
src blob;  
dest blob;  
begin  
  select blob_src, blob_dest into src, dest from medical_image_rel  
  where id = 1 for update;  
  ord_dicom.processCopy(src, 'fileFormat=jpeg maxScale=100 100' dest);  
end;  
/
```

## 7.3.12 processCopy( ) for BLOBs with SOP Instance UID

### Format

```
processCopy(src IN BLOB,  
            command IN VARCHAR2,  
            dest_sop_instance_uid IN VARCHAR2,  
            dest IN OUT NOCOPY BLOB,  
            metadata IN SYS.XMLTYPE DEFAULT NULL)
```

### Description

Reads the DICOM content that is input from the source BLOB, performs the specified processing operations on the image, updates it with the new metadata, and then stores the resulting image in the destination BLOB. The original DICOM content in the source BLOB remains unchanged.

### Parameters

#### src

The input DICOM content stored in the source BLOB.

#### command

A command string that accepts a processing operator as input. Valid values include: `frame`, `contentFormat`, `compressionFormat`, `cut`, `scale`, and `rotate`. See [DICOM Processing and Supported Formats](#) for information about processing operators.

#### dest\_sop\_instance\_uid

The SOP instance UID of the destination DICOM content. It must ensure that the destination DICOM content is globally unique.

#### dest

An empty BLOB in which to store the destination content.

#### metadata

The new metadata to be written into the new DICOM content.

### Pragmas

None.

### Exceptions

None.



## Usage Notes

See [DICOM Encoding Rules](#) for information about the encoding rules that support DICOM content processing. See [DICOM Processing and Supported Formats](#) for more information about DICOM processing.

Use the preference parameter `VALIDATE_METADATA` to specify whether the XML documents are validated against the Oracle default DICOM metadata schema. See [Defining the VALIDATE\\_METADATA Preference Parameter](#) for more information about this preference parameter.

## Examples

Create a new compressed DICOM image:

 **Note:**

Replace `<unique-UID>` with the UID that identifies the organization producing the DICOM content and the DICOM content within that organization.

```
declare
  src blob;
  dest blob;
  dest_sop_instance_uid varchar2(128) := '<unique-UID>';
begin
  select blob_src, blob_dest into src, dest from medical_image_rel
  where id = 1 for update;
  ord_dicom.processCopy(
    src, 'CompressionFormat=jpeg', dest_sop_instance_uid, dest);
end;
/
```

## 7.3.13 processCopy( ) for ORDImage

### Format

```
processCopy(src IN ORDSYS.ORDImage,
            command IN VARCHAR2,
            dest IN OUT NOCOPY BLOB)
```

### Description

Reads the DICOM content that is input from the source `ORDImage` object, performs the specified processing operations on the image, and then stores the resulting image in the destination `BLOB`. The original DICOM content in the source `ORDImage` object remains unchanged.

### Parameters

**src**

The input DICOM content stored in the source `ORDImage` object.

**command**

A command string that accepts an image processing operator as input. Valid values include: `fileFormat`, `frame`, `contentFormat`, `compressionFormat`, `cut`, `scale`, and `rotate`. See [DICOM Processing and Supported Formats](#) for information about image processing operators.

**dest**

An empty BLOB in which to store the destination content.

**Pragmas**

None.

**Exceptions**

None.

**Usage Notes**

Use this procedure to get a non-DICOM image that is suitable for presentation on the Web from the embedded DICOM content.

See [DICOM Encoding Rules](#) for information about the encoding rules that support image content processing. See [DICOM Processing and Supported Formats](#) for more information about DICOM processing.

Use the preference parameter `VALIDATE_METADATA` to specify whether the XML documents are validated against the Oracle default DICOM metadata schema. See [Defining the VALIDATE\\_METADATA Preference Parameter](#) for more information about this preference parameter.

**Examples**

Create a new JPEG thumbnail image:

```
declare
  src ordimage;
  dest blob;
begin
  select image_src, blob_dest into src, dest from medical_image_rel
  where id = 1 for update;
  ord_dicom.processCopy(src, 'fileFormat=jpeg maxScale=100 100' dest);
end;
/
```

## 7.3.14 processCopy( ) for ORDImage with SOP Instance UID

**Format**

```
processCopy(src IN ORDSYS.ORDImage,
            command IN VARCHAR2,
            dest_sop_instance_uid IN VARCHAR2,
            dest IN OUT NOCOPY BLOB,
            metadata IN SYS.XMLTYPE DEFAULT NULL)
```

**Description**

Reads the DICOM content that is input from the source `ORDImage` object, performs the specified processing operations on the image, updates it with the new metadata,

and then stores the resulting image in the destination BLOB. The original DICOM content in the source `ORDImage` object remains unchanged.

### Parameters

#### **src**

The input DICOM content stored in the source `ORDImage` object.

#### **command**

A command string that accepts an image processing operator as input. Valid values include: `frame`, `contentFormat`, `compressionFormat`, `cut`, `scale`, and `rotate`. See [DICOM Processing and Supported Formats](#) for information about image processing operators.

#### **dest\_sop\_instance\_uid**

The SOP instance UID of the destination DICOM image. It must ensure that the destination DICOM content is globally unique.

#### **dest**

An empty BLOB in which to store the destination content.

#### **metadata**

The new metadata to be written into the new DICOM content.

### Pragmas

None.

### Exceptions

None.

### Usage Notes

Use this procedure to get a non-DICOM image that is suitable for presentation on the Web from the embedded DICOM content.

See [DICOM Encoding Rules](#) for information about the encoding rules that support image content processing. See [DICOM Processing and Supported Formats](#) for more information about DICOM processing.

Use the preference parameter `VALIDATE_METADATA` to specify whether the XML documents are validated against the Oracle default DICOM metadata schema. See [Defining the VALIDATE\\_METADATA Preference Parameter](#) for more information about this preference parameter.

### Examples

Create a new compressed DICOM image:

 **Note:**

Replace `<unique-UID>` with the UID that identifies the organization producing the DICOM content and the DICOM content within that organization.

```
declare
  src ordimage;
```

```
dest blob;
dest_sop_instance_uid varchar2(128) := '<unique-UID>';
begin
  select image_src, blob_dest into src, dest from medical_image_rel
  where id = 1 for update;
  ord_dicom.processCopy(
    src, 'CompressionFormat=jpeg', dest_sop_instance_uid, dest);
end;
/
```

## 7.3.15 writeMetadata( ) for BFILEs

### Format

```
writeMetadata(src IN BFILE,
             metadata IN SYS.XMLTYPE,
             dest IN OUT NOCOPY BLOB),
```

### Description

Writes or modifies the current DICOM content with the metadata provided by making a copy of the existing DICOM content in the destination BLOB, and then modifying the metadata. The original DICOM content remains unchanged. The attributes in the destination DICOM content are copied from the metadata that was input.

### Parameters

#### src

The input DICOM content stored in a BFILE.

#### metadata

The input metadata stored in data type XMLType. In the destination DICOM content, the input metadata is used to update the values for attributes that are identical to attributes in the source DICOM content, or to add any new attributes. The metadata must conform to the default metadata schema with the namespace `http://xmlns.oracle.com/ord/dicom/metadata_1_0`. The SOP instance UID in the metadata must ensure that the destination DICOM content is globally unique.

#### dest

An empty BLOB in which to store the new DICOM content with the new metadata.

### Pragmas

None.

### Exceptions

None.

### Usage Notes

See [DICOM Encoding Rules](#) for information about the encoding rules that support metadata extraction.

Use the preference parameter `VALIDATE_METADATA` to specify whether the XML documents are validated against the Oracle default DICOM metadata schema. See [Defining the VALIDATE\\_METADATA Preference Parameter](#) for more information about this preference parameter.

Use the preference parameter `SQ_WRITE_LEN` to specify how the DICOM sequence (SQ) types are encoded. See [Defining the SQ\\_WRITE\\_LEN Preference Parameter](#) for more information about this preference parameter.

### Examples

Write the new metadata to the copy of the DICOM content in the destination BLOB:

```
declare
  src bfile;
  dest blob;
  metadata xmltype;
begin
  metadata := xmltype(bfilename('DICOMDIR', 'wm_meta.xml'),
                    nls_charset_id('AL32UTF8'),
                    'http://xmlns.oracle.com/ord/dicom/metadata_1_0');

  select bfile_src, blob_dest into src, dest from medical_image_rel
     where id = 1 for update;

  ord_dicom.writeMetadata(src, metadata, dest);

end;
/
```

## 7.3.16 writeMetadata() for BLOBs

### Format

```
writeMetadata(src IN BLOB,
             metadata IN SYS.XMLTYPE,
             dest IN OUT NOCOPY BLOB),
```

### Description

Writes or modifies the current DICOM content with the metadata provided by making a copy of the existing DICOM content in the destination BLOB, and then modifying the metadata. The original DICOM content remains unchanged. The attributes in the destination DICOM content are copied from the metadata that was input.

### Parameters

#### src

The input DICOM content stored in a BLOB.

#### metadata

The input metadata stored in data type XMLType. In the destination DICOM content, the input metadata is used to update the values for attributes that are identical to attributes in the source DICOM content, or to add any new attributes. The metadata must conform to the default metadata schema with the namespace `http://xmlns.oracle.com/ord/dicom/metadata_1_0`. The SOP instance UID in the metadata must ensure that the destination DICOM content is globally unique.

#### dest

An empty BLOB in which to store the new DICOM content with the new metadata.

**Pragmas**

None.

**Exceptions**

None.

**Usage Notes**

See [DICOM Encoding Rules](#) for information about the encoding rules that support metadata extraction.

Use the preference parameter `VALIDATE_METADATA` to specify whether the XML documents are validated against the Oracle default DICOM metadata schema. See [Defining the `VALIDATE\_METADATA` Preference Parameter](#) for more information about this preference parameter.

Use the preference parameter `SQ_WRITE_LEN` to specify how the DICOM sequence (SQ) types are encoded. See [Defining the `SQ\_WRITE\_LEN` Preference Parameter](#) for more information about this preference parameter.

**Examples**

Write the new metadata to the copy of the DICOM content in the destination BLOB:

```
declare
  src blob;
  dest blob;
  metadata xmltype;
begin
  metadata := xmltype(bfilename('DICOMDIR', 'wm_meta.xml'),
                    nls_charset_id('AL32UTF8'),
                    'http://xmlns.oracle.com/ord/dicom/metadata_1_0');

  select blob_src, blob_dest into src, dest from medical_image_rel
     where id = 1 for update;

  ord_dicom.writeMetadata(src, metadata, dest);

end;
/
```

## 7.3.17 writeMetadata( ) for ORDImage

**Format**

```
writeMetadata(src IN ORDSYS.ORDImage,
             metadata IN SYS.XMLTYPE,
             dest IN OUT NOCOPY BLOB),
```

**Description**

Writes or modifies the current DICOM content with the metadata provided by making a copy of the existing DICOM content in the destination BLOB, and then modifying the metadata. The original DICOM content remains unchanged. The attributes in the destination DICOM content are copied from the metadata that was input.

## Parameters

### src

The input DICOM content stored in an ORDImage object.

### metadata

The input metadata stored in data type XMLType. In the destination DICOM content, the input metadata is used to update the values for attributes that are identical to attributes in the source DICOM content, or to add any new attributes. The metadata must conform to the default metadata schema with the namespace `http://xmlns.oracle.com/ord/dicom/metadata_1_0`. The SOP instance UID in the metadata must ensure that the destination DICOM content is globally unique.

### dest

An empty BLOB in which to store the new DICOM content with the new metadata.

## Pragmas

None.

## Exceptions

None.

## Usage Notes

See [DICOM Encoding Rules](#) for information about the encoding rules that support metadata extraction.

Use the preference parameter `VALIDATE_METADATA` to specify whether the XML documents are validated against the Oracle default DICOM metadata schema. See [Defining the VALIDATE\\_METADATA Preference Parameter](#) for more information about this preference parameter.

Use the preference parameter `SQ_WRITE_LEN` to specify how the DICOM sequence (SQ) types are encoded. See [Defining the SQ\\_WRITE\\_LEN Preference Parameter](#) for more information about this preference parameter.

## Examples

Write the new metadata to the copy of the DICOM content in the destination BLOB:

```
declare
  src ordimage;
  dest blob;
  metadata xmltype;
begin
  metadata := xmltype(bfilename('DICOMDIR', 'wm_meta.xml'),
                    nls_charset_id('AL32UTF8'),
                    'http://xmlns.oracle.com/ord/dicom/metadata_1_0');

  select image_src, blob_dest into src, dest from medical_image_rel
  where id = 1 for update;

  ord_dicom.writeMetadata(src, metadata, dest);

end;
/
```

# 8

## ORDDicom Object Type Reference

Oracle Multimedia provides the ORDDicom object type, which supports the storage, management, and manipulation of DICOM format medical images and other data.

The ORDDicom object is intended as an object that is written only once. To generate a new ORDDicom object by image processing or compression, create a new ORDDicom object, ORDImage object, or BLOB.

The ORDDicom object type is defined in the `ordcspec.sql` file. After installation, this file is available in the Oracle home directory at:

```
<ORACLE_HOME>/ord/im/admin (on Linux and UNIX)
```

```
<ORACLE_HOME>\ord\im\admin (on Windows)
```

This chapter describes the attributes, constructors, and methods in the ORDDicom object interface.

This chapter contains these sections:

- [ORDDicom Object Examples](#)
- [ORDDicom Object Type](#) on
- [ORDDicom Constructors](#)
- [ORDDicom Methods](#)



### See Also:

[Table 3-1](#) for information about other DICOM application programming interfaces (APIs)

### 8.1 ORDDicom Object Examples

The examples in this chapter use the `MEDICAL_IMAGE_OBJ` table. See [MEDICAL\\_IMAGE\\_OBJ Table Definition](#) when reading through these examples.

Before using ORDDicom methods, you must load some data into the table. For example, you can use the SQL\*Loader utility, a Java client, or the `import()` method. Substitute your DICOM files for those in the examples.



 **Note:**

If you manipulate the DICOM content itself (by either directly modifying the BLOB or changing the external source), call the `setProperties()` method to ensure that the object attributes stay synchronized. You must also ensure that the update time is modified. Otherwise, the object attributes will not match the DICOM content.

See the [setProperties\(\)](#) method for more information.

## 8.1.1 Directory Definition and Setup for ORDDicom Object Examples

Before executing the examples, issue the following statements while connected to a user with privileges to create a directory object, where `c:\mydir\work` is the directory where the user `<user>` can find the DICOM files:

```
CREATE OR REPLACE DIRECTORY DICOMDIR as 'c:\mydir\work';
GRANT READ, WRITE ON DIRECTORY DICOMDIR TO <user>;
```

 **Note:**

At the beginning of each database session, call the `setDataModel()` procedure.

See the [setDataModel\(\) Procedure](#) for more information.

## 8.1.2 MEDICAL\_IMAGE\_OBJ Table Definition

Before loading data into the table, you must create the table and columns where the data is to be stored. The following PL/SQL code segment creates the `MEDICAL_IMAGE_OBJ` table with five columns.

```
CREATE TABLE MEDICAL_IMAGE_OBJ
(
  id          integer primary key,
  dicom_src   ordsys.orddicom,
  dicom_dest  ordsys.orddicom,
  image_dest  ordsys.ordimage,
  blob_dest   blob
);
```

where:

- `dicom_src`: the source DICOM content in the ORDDicom object.
- `dicom_dest`: the destination DICOM content in the ORDDicom object.
- `image_dest`: the destination DICOM content in the ORDImage object.
- `blob_dest`: the destination DICOM content in the BLOB.

## 8.2 ORDDicom Object Type

The ORDDicom object type supports the storage, management, and manipulation of DICOM format medical images and other data. The attributes for this object type are defined as follows in the `ordcspec.sql` file:

```
-----  
-- TYPE ATTRIBUTES  
-----  
SOP_INSTANCE_UID    VARCHAR2(128),  
SOP_CLASS_UID       VARCHAR2(64),  
STUDY_INSTANCE_UID  VARCHAR2(64),  
SERIES_INSTANCE_UID VARCHAR2(64),  
source              ORDDataSource,  
metadata            SYS.XMLType,  
contentLength       INTEGER,  
flag                INTEGER,  
extension           BLOB,
```

where:

- `SOP_INSTANCE_UID`: the SOP instance UID of the embedded DICOM content.
- `SOP_CLASS_UID`: the SOP class UID of the embedded DICOM content.
- `STUDY_INSTANCE_UID`: the study instance UID of the embedded DICOM content.
- `SERIES_INSTANCE_UID`: the series instance UID of the embedded DICOM content.
- `source`: the original DICOM content stored within the database, under transaction control as a BLOB (recommended), or stored in an operating system-specific file in a local file system with pointer stored in the database.
- `metadata`: the XML metadata document extracted from the embedded DICOM content.
- `contentLength`: the length of the embedded DICOM content, in number of bytes.
- `flag`: an Oracle reserved attribute.
- `extension`: an Oracle reserved attribute.

## 8.3 ORDDicom Constructors

This section describes these ORDDicom constructor functions:

- [ORDDicom\(\) for BLOBs](#)
- [ORDDicom\(\) for ORDImage](#)
- [ORDDicom\(\) for Other Sources](#)

The ORDDicom object can be constructed using these constructors in a SQL statement or PL/SQL program.

The ORDDicom object has embedded BLOB attributes. BLOB locators must be initialized before they can be accessed. Thus, newly constructed ORDDicom objects

(unless constructed from a temporary BLOB) must be inserted into a table before you can call object member methods on these ORDDicom objects.

## 8.3.1 ORDDicom( ) for BLOBs

### Format

```
ORDDicom(SELF IN OUT NOCOPY ORDDicom,
         data IN BLOB,
         setproperties IN INTEGER DEFAULT 0)
RETURN SELF AS RESULT
```

### Description

Constructs an ORDDicom object from a BLOB. The data stored in the BLOB is copied into the ORDDicom object when the constructed ORDDicom object is inserted or updated into a table. The metadata conforms to the XML schema defined by the default mapping document.

### Parameters

#### data

Embedded DICOM content stored in a BLOB.

#### setproperties

Indicator flag that determines whether the DICOM attributes are extracted from the embedded DICOM content. If the value is 1, the DICOM attributes are extracted into the metadata attribute of the constructed ORDDicom object, and the attributes of the ORDDicom object are populated. If the value is 0, no DICOM attributes are extracted. The default is 0.

### Pragmas

None.

### Exceptions

None.

### Usage Notes

Use this constructor to create an ORDDicom object when the DICOM content is stored in either a temporary or a persistent BLOB.

### Examples

Create an ORDDicom object from a BLOB:

```
SQL> desc blob_tbl;
Name                               Null?    Type-----
-----
ID                                  NUMBER(38)DATA          BLOB

insert into medical_image_obj (id, dicom_src)
  select s.id, ORDDicom(s.data) from blob_tbl s;
```

## 8.3.2 ORDDicom( ) for ORDImage

### Format

```
ORDDicom(SELF IN OUT NOCOPY ORDDicom,
         data IN ORDImage,
         setproperties IN INTEGER DEFAULT 0)
RETURN SELF AS RESULT
```

### Description

Constructs an ORDDicom object from an ORDImage object that has either a local source (BLOB) or a file source (BFILE). If the DICOM content is stored originally in the BLOB of the ORDImage object, the data is copied into the BLOB in the ORDDicom object source attribute when the constructed ORDDicom object is inserted or updated into a table. If the DICOM content is stored originally as a BFILE source of the ORDImage object, the srcType, srcLocation, and srcName parameters from the ORDImage source are copied into the source attribute of the ORDDicom object. The metadata conforms to the XML schema defined by the default mapping document.

### Parameters

#### data

Embedded DICOM content stored in an ORDImage object.

#### setproperties

Indicator flag that determines whether the DICOM attributes are extracted from the embedded DICOM content. If the value is 1, the DICOM attributes are extracted into the metadata attribute of the constructed ORDDicom object, and the attributes of the ORDDicom object are populated. If the value is 0, no DICOM attributes are extracted. The default is 0.

### Pragmas

None.

### Exceptions

None.

### Usage Notes

Use this constructor to create an ORDDicom object when the DICOM content is stored in an ORDImage object. Or, use this constructor to migrate an ORDImage object to an ORDDicom object.

### Examples

Create an ORDDicom object from an ORDImage object:

```
SQL> desc image_tbl;
Name                               Null?    Type-----
-----
ID                                  NUMBER(38) IMAGE          ORDIMAGE

insert into medical_image_obj (id, dicom_src)
select s.id, ORDDicom(s.image) from image_tbl s;
```

## 8.3.3 ORDDicom( ) for Other Sources

### Format

```
ORDDicom(SELF IN OUT NOCOPY ORDDicom,  
         source_type IN VARCHAR2 DEFAULT 'LOCAL',  
         source_location IN VARCHAR2 DEFAULT NULL,  
         source_name IN VARCHAR2 DEFAULT NULL,  
         setproperties IN INTEGER DEFAULT 0)  
RETURN SELF AS RESULT
```

### Description

Constructs an ORDDicom object from a specific source. By default, the value of the `source_type` parameter is set to `LOCAL`, which means that the source of the data is stored locally in the database in a BLOB. With the default values, an empty object with a local source is constructed. If the value of the `source_type` parameter is set to `FILE`, an ORDDicom object is constructed with the source stored as an external FILE. The metadata conforms to the XML schema defined by the default XML mapping document.

### Parameters

#### **source\_type**

The type of the source. Valid values are: `FILE` or `LOCAL`. The default is `LOCAL`.

#### **source\_location**

The directory location of the source (used for `source_type=FILE`).

#### **source\_name**

The file name of the source (used for `source_type=FILE`).

#### **setproperties**

Indicator flag that determines whether the DICOM attributes are extracted from the embedded DICOM content. If the value is `1`, the DICOM attributes are extracted into the metadata attribute of the constructed ORDDicom object, and the attributes of the ORDDicom object are populated. If the value is `0`, no DICOM attributes are extracted. The default is `0`.

### Pragmas

None.

### Exceptions

None.

### Usage Notes

Use this constructor to create an ORDDicom object when the DICOM content is stored in the file system. Use the empty constructor when uploading DICOM content from a client, such as a Web browser or a Java application. Or, use the empty constructor as a destination object for methods such as `processCopy( )`, `makeAnonymous( )`, and `writeMetadata( )`.

## Examples

### Example 1:

Create an ORDDicom object from a file without populating the object attributes:

```
insert into medical_image_obj (id, dicom_src)
  values (1, ORDDicom('FILE', 'DICODEDIR', 'example.dcm'));
```

### Example 2:

Create an ORDDicom object from a file with the setProperties flag set:

```
insert into medical_image_obj (id, dicom_src)
  values (2, ORDDicom('FILE', 'DICODEDIR', 'example.dcm', 1));
```

### Example 3:

Create an empty ORDDicom object:

```
insert into medical_image_obj (id, dicom_src)
  values (3, ORDDicom());
```

## 8.4 ORDDicom Methods

This section presents reference information about these ORDDicom methods:

- [export\(\)](#)
- [extractMetadata\(\)](#)
- [getAttributeByName\(\)](#)
- [getAttributeByTag\(\)](#)
- [getContent\(\)](#)
- [getContentLength\(\)](#)
- [getSeriesInstanceUID\(\)](#)
- [getSOPClassUID\(\)](#)
- [getSOPInstanceUID\(\)](#)
- [getSourceInformation\(\)](#)
- [getSourceLocation\(\)](#)
- [getSourceName\(\)](#)
- [getSourceType\(\)](#)
- [getStudyInstanceUID\(\)](#)
- [import\(\)](#)
- [isAnonymous\(\)](#)
- [isConformanceValid\(\)](#)
- [isLocal\(\)](#)
- [makeAnonymous\(\)](#)
- [processCopy\(\)](#) to BLOBs

- `processCopy()` to ORDDicom
- `processCopy()` to ORDImage
- `setProperties()`
- `writeMetadata()`

 **Note:**

In this section, *<unique-UID>* represents a 64-byte, dot-concatenated, numeric string that represents a globally unique identifier for DICOM content worldwide. The UID is commonly constructed with a root that uniquely identifies the organization producing the DICOM content, and a suffix that uniquely identifies the DICOM content within that organization. For some examples in this section, you must replace *<unique-UID>* with the appropriate UID.

## 8.4.1 `export()`

### Format

```
export(SELF IN ORDDicom,  
       dest_type IN VARCHAR2,  
       dest_location IN VARCHAR2,  
       dest_name IN VARCHAR2)
```

### Description

Exports embedded DICOM content to a specified destination. The data remains in the source BLOB when it is copied to the destination.

### Parameters

**dest\_type**

The type of the destination (only `FILE` is supported).

**dest\_location**

The location of the destination (must be a valid Oracle directory object).

**dest\_name**

The name of the destination file.

### Pragmas

None.

### Exceptions

None.

### Usage Notes

Use this method to export the embedded DICOM content to the local file system.

The `export()` method writes only to a database directory object that the user has privilege to access. That is, you can access a directory object that you have created using the SQL statement `CREATE DIRECTORY`, or one to which you have been granted `READ` and `WRITE` access.

For example, the following SQL\*Plus commands create a directory object and grant the user `<user>` permission to read and write any file within the directory `c:\mydir\work`. Before executing these commands, you must be connected as a user with privileges to create a directory object.

```
CREATE OR REPLACE DIRECTORY DICOMDIR AS 'c:\mydir\work';
GRANT READ,WRITE ON DIRECTORY DICOMDIR TO <user>;
```

See [ORDDicom Object Examples](#) for more information about directory and table definitions.

### Examples

Export embedded DICOM content to a specified file:

```
declare
  obj orddicom;
begin
  select dicom_src into obj from medical_image_obj where id = 1;
  obj.export('FILE', 'DICOMDIR', 'exported.dcm');
end;
/
```

## 8.4.2 extractMetadata()

### Format

```
extractMetadata(extractOption IN VARCHAR2 DEFAULT 'ALL',
                docName IN VARCHAR2 DEFAULT 'ordcmmmp.xml')
RETURN SYS.XMLTYPE
```

### Description

Returns the DICOM metadata as XML code for a specified mapping document. The default mapping document refers to the default metadata namespace `http://xmlns.oracle.com/ord/dicom/metadata_1_0`. The metadata attribute and other attributes of the ORDDicom object are not affected.

### Parameters

#### extractOption

A string that specifies the types of metadata to extract from the DICOM content. Valid values are: `ALL`, `MAPPED`, and `STANDARD`. The default is `ALL`.

When the value of this parameter is `ALL`, all the attributes in the embedded DICOM content are extracted. When the value is set to `MAPPED`, only mapped attributes are extracted. And, when the value is set to `STANDARD`, only attributes that conform to the DICOM standard and mapped attributes are extracted.

#### docName

The name of the mapping document. The default mapping document `ordcmmmp.xml` is loaded during installation. This document refers to the default metadata namespace `http://xmlns.oracle.com/ord/dicom/metadata_1_0`.



## Pragmas

None.

## Exceptions

None.

## Usage Notes

Use this method to retrieve metadata from the embedded DICOM content as XML code, and then store it in a database table for searching or viewing.

Use the preference parameter XML\_SKIP\_ATTR to specify size limits for DICOM attributes to be omitted when encoding into XML. See [Defining the XML\\_SKIP\\_ATTR Preference Parameter](#) for more information about this preference parameter.

Use the preference parameter VALIDATE\_METADATA to specify whether the XML documents are validated against a specific XML schema that is registered with Oracle XML DB, either as a global or local XML schema. See [Defining the VALIDATE\\_METADATA Preference Parameter](#) for more information about this preference parameter.

Calling this method when the value of the preference parameter VALIDATE\_METADATA is set to `true` raises an error if the metadata namespace in the mapping document is not available to the current user.

## Examples

Extract metadata from the embedded DICOM content:

```
declare
  obj orddicom;
  metadata xmltype;
begin
  select dicom_src into obj from medical_image_obj where id = 1;

  -- extract all the metadata using the default mapping document.
  metadata := obj.extractMetadata();

  -- extract the standard metadata using the default mapping document.
  metadata := obj.extractMetadata('standard');

  -- extract the standard metadata by specifying the mapping document.
  metadata := obj.extractMetadata('standard', 'ordcmmmp.xml');
end;
/
```

## 8.4.3 getAttributeByName()

### Format

```
getAttributeByName(attributeName IN VARCHAR2,
  definerName IN VARCHAR2 DEFAULT 'DICOM')
RETURN VARCHAR2 DETERMINISTIC PARALLEL_ENABLE
```

### Description

Returns the value of a DICOM attribute, as a VARCHAR2 string, for DICOM attributes other than SQ type attributes. For SQ type attributes, this method returns a segment of XML code, as a VARCHAR2 string. Use this method to get a single attribute from the embedded DICOM content.

### Parameters

#### **attributeName**

The name of a specified attribute.

#### **definerName**

The name of the attribute definer. The default name is DICOM.

### Pragmas

None.

### Exceptions

None.

### Usage Notes

See [Task 4: Search and Retrieve DICOM Attributes](#) for more information about the best methods to use for searching and retrieving DICOM attributes.

### Examples

Return the name of a specified DICOM attribute:

```
declare
  obj orddicom;
  res varchar2(4000);
begin
  select dicom_src into obj from medical_image_obj where id = 1;
  obj.setProperties;

  -- Patient ID attribute, this will return patient ID value
  res := obj.getAttributeByName('Patient ID');
  dbms_output.put_line('Patient ID attribute: ' || res);

  -- attribute in SQ type, this will return an xml segment.
  res := obj.getAttributeByName('Source Image Sequence');
  dbms_output.put_line('Source Image Sequence attribute: ' || res);
end ;
/
```

## 8.4.4 getAttributeByTag()

### Format

```
getAttributeByTag(tag IN VARCHAR2,
                  definerName IN VARCHAR2 DEFAULT 'DICOM')
RETURN VARCHAR2 DETERMINISTIC PARALLEL_ENABLE
```

### Description

Returns the value of a DICOM attribute, as a VARCHAR2 string, for DICOM attributes other than SQ type attributes. For SQ type attributes, this method returns a segment of XML code, as a VARCHAR2 string. Use this method to get a single attribute of the embedded DICOM content.

### Parameters

**tag**

The code value used to specify a DICOM attribute or item tag, as a hexadecimal string.

**definerName**

The name of the attribute definer. The default name is DICOM.

### Pragmas

None.

### Exceptions

None.

### Usage Notes

See [Task 4: Search and Retrieve DICOM Attributes](#) for more information about the best methods to use for searching and retrieving DICOM attributes.

### Examples

Return the tag of a specified DICOM attribute:

```
declare
  obj orddicom;
  res varchar2(4000);
begin
  select dicom_src into obj from medical_image_obj where id = 1;
  obj.setProperties;

  -- Patient ID attribute, this will return patient ID value
  res := obj.getAttributeByTag('00100020');
  dbms_output.put_line('Patient ID attribute: ' || res);

  -- attribute in SQ type, this will return an xml segment.
  res := obj.getAttributeByTag('00082112');
  dbms_output.put_line('Source Image Sequence attribute: ' || res);
end ;
/
```

## 8.4.5 getContent( )

### Format

```
getContent( ) RETURN BLOB DETERMINISTIC
```

**Description**

Returns the embedded DICOM content stored in the source attribute of the ORDDicom object. This method returns the BLOB handle, or a null value if the DICOM content has not been imported.

**Parameters**

None.

**Pragmas**

None.

**Exceptions**

None.

**Usage Notes**

None.

**Examples**

Return the content of the source attribute for the ORDDicom object:

```
select t.dicom_src.getContent() from medical_image_obj t;
```

## 8.4.6 getContentLength()

**Format**

```
getContentLength( ) RETURN INTEGER DETERMINISTIC PARALLEL_ENABLE
```

**Description**

Returns the length of the embedded DICOM content. This method returns the value of the contentLength attribute of the ORDDicom object.

**Parameters**

None.

**Pragmas**

None.

**Exceptions**

None.

**Usage Notes**

Before invoking this method, you must call the [setProperties\( \)](#) method.

**Examples**

Return the value of the contentLength attribute for the ORDDicom object:

```
select t.dicom_src.getContentLength() from medical_image_obj t;
```

## 8.4.7 getSeriesInstanceUID()

### Format

```
getSeriesInstanceUID( ) RETURN VARCHAR2 DETERMINISTIC PARALLEL_ENABLE,
```

### Description

Returns the value of the SERIES\_INSTANCE\_UID attribute of the ORDDicom object.

### Parameters

None.

### Pragmas

None.

### Exceptions

None.

### Usage Notes

Before invoking this method, you must call the [setProperties\(\)](#) method.

### Examples

Return the value of the SERIES\_INSTANCE\_UID attribute for the ORDDicom object:

```
select t.dicom_src.getSeriesInstanceUID() from medical_image_obj t;
```

## 8.4.8 getSOPClassUID()

### Format

```
getSOPClassUID( ) RETURN VARCHAR2 DETERMINISTIC PARALLEL_ENABLE,
```

### Description

Returns the value of the SOP\_CLASS\_UID attribute of the ORDDicom object.

### Parameters

None.

### Pragmas

None.

### Exceptions

None.

### Usage Notes

Before invoking this method, you must call the [setProperties\(\)](#) method.

**Examples**

Return the value of the SOP\_CLASS\_UID attribute for the ORDDicom object:

```
select t.dicom_src.getSOPClassUID() from medical_image_obj t;
```

## 8.4.9 getSOPInstanceUID()

**Format**

```
getSOPInstanceUID( ) RETURN VARCHAR2 DETERMINISTIC PARALLEL_ENABLE
```

**Description**

Returns the value of the SOP\_INSTANCE\_UID attribute of the ORDDicom object.

**Parameters**

None.

**Pragmas**

None.

**Exceptions**

None.

**Usage Notes**

Before invoking this method, you must call the [setProperties\(\)](#) method.

**Examples**

Return the value of the SOP\_INSTANCE\_UID attribute for the ORDDicom object:

```
select t.dicom_src.getSOPInstanceUID() from medical_image_obj t;
```

## 8.4.10 getSourceInformation()

**Format**

```
getSourceInformation( ) RETURN VARCHAR2 DETERMINISTIC PARALLEL_ENABLE
```

**Description**

Returns the source information from the source attribute of the ORDDicom object as a URL in the form "source\_type://source\_location/source\_name".

**Parameters**

None.

**Pragmas**

None.

**Exceptions**

None.

**Usage Notes**

None.

**Examples**

Return the source information for the ORDDicom object:

```
select t.dicom_src.getSourceInformation() from medical_image_obj t;
```

## 8.4.11 getSourceLocation()

**Format**

```
getSourceLocation( ) RETURN VARCHAR2 DETERMINISTIC PARALLEL_ENABLE
```

**Description**

Returns the source location from the source attribute of the ORDDicom object.

**Parameters**

None.

**Pragmas**

None.

**Exceptions**

None.

**Usage Notes**

None.

**Examples**

Return the source location for the ORDDicom object:

```
select t.dicom_src.getSourceLocation() from medical_image_obj t;
```

## 8.4.12 getSourceName()

**Format**

```
getSourceName( ) RETURN VARCHAR2 DETERMINISTIC PARALLEL_ENABLE
```

**Description**

Returns the source name from the source attribute of the ORDDicom object.

**Parameters**

None.

**Pragmas**

None.

**Exceptions**

None.

**Usage Notes**

None.

**Examples**

Return the source name for the ORDDicom object:

```
select t.dicom_src.getSourceName() from medical_image_obj t;
```

## 8.4.13 getSourceType()

**Format**

```
getSourceType( ) RETURN VARCHAR2 DETERMINISTIC PARALLEL_ENABLE
```

**Description**

Returns the source type from the source attribute of the ORDDicom object.

**Parameters**

None.

**Pragmas**

None.

**Exceptions**

None.

**Usage Notes**

None.

**Examples**

Return the source type for the ORDDicom object:

```
select t.dicom_src.getSourceType() from medical_image_obj t;
```



## 8.4.14 getStudyInstanceUID()

### Format

```
getStudyInstanceUID( ) RETURN VARCHAR2 DETERMINISTIC PARALLEL_ENABLE,
```

### Description

Returns the value of the `STUDY_INSTANCE_UID` attribute of the ORDDicom object.

### Parameters

None.

### Pragmas

None.

### Exceptions

None.

### Usage Notes

Before invoking this method, you must call the [setProperties\(\)](#) method.

### Examples

Return the value of the `STUDY_INSTANCE_UID` attribute for the ORDDicom object:

```
select t.dicom_src.getStudyInstanceUID() from medical_image_obj t;
```

## 8.4.15 import()

### Format

```
import(SELF IN OUT NOCOPY ORDDicom,  
       setproperties IN INTEGER DEFAULT 1)
```

### Description

Imports DICOM content from the current source. This method assumes that the `source` attributes have been set in the ORDDicom object by passing the `source_type`, `source_location`, and `source_name` parameters to the constructor.

### Parameters

#### setproperties

Indicator flag that determines whether the DICOM attributes are extracted into the metadata attribute of the ORDDicom object. If the value is `1`, the DICOM attributes are extracted into the metadata attribute of the ORDDicom object, and the attributes of the ORDDicom object are populated. If the value is `0`, no DICOM attributes are extracted. The default is `1`.

### Pragmas

None.

## Exceptions

None.

## Usage Notes

Use this method when the ORDDicom object is constructed from a source other than a BLOB, and must be imported into a BLOB.

The import() method reads only from a database directory object that the user has privilege to access. That is, you can access a directory object that you have created using the SQL statement CREATE DIRECTORY, or one to which you have been granted READ access.

For example, the following SQL\*Plus commands create a directory object and grant the user <user> permission to read any file within the directory c:\mydir\work. Before executing these commands, you must be connected as a user with privileges to create a directory object.

```
CREATE OR REPLACE DIRECTORY DICOMDIR AS 'c:\mydir\work';
GRANT READ ON DIRECTORY DICOMDIR TO <user>;
```

Assuming that the DICOM object is inserted as follows:

```
insert into medical_image_obj (id, dicom_src) values
(1, ORDDicom('FILE', 'DICOMDIR', 'imported.dcm'));
```

The user can import DICOM content from the imported.dcm file in this directory using the import() method of the ORDDicom object:

```
obj.import();
```

See [ORDDicom Object Examples](#) for more information about directory and table definitions.

## Examples

Import the DICOM attributes:

```
declare
  obj orddicom;
begin
  select dicom_src into obj from medical_image_obj where id = 1 for update;
  if (obj.isLocal() = 0) then
    obj.import();
  end if;
  update medical_image_obj set dicom_src = obj where id = 1;
end;
/
```

## 8.4.16 isAnonymous()

### Format

```
isAnonymous(anonymityDocName IN VARCHAR2 DEFAULT 'ordcman.xml')
RETURN INTEGER
```

**Description**

Determines whether the embedded DICOM content is anonymous using a specified anonymity document, which is stored in the data model repository. This method returns a value of 1 if the data is anonymous; otherwise it returns a value of 0.

**Parameters****anonymityDocName**

The name of the anonymity document. The default name is `ordcman.xml`.

**Pragmas**

None.

**Exceptions**

None.

**Usage Notes**

Use this method before calling the `makeAnonymous()` method to find out whether patient identifying information has been removed from the embedded DICOM content. (See also the [makeAnonymous\(\)](#) method.)

**Examples**

Check if the embedded DICOM content is anonymous:

```
select t.dicom_src.isAnonymous('ordcman.xml') from medical_image_obj t;
```

## 8.4.17 isConformanceValid( )

**Format**

```
isConformanceValid(constraintName IN VARCHAR2) RETURN INTEGER
```

**Description**

Performs a conformance validation check to determine whether the embedded DICOM content conforms to a specific set of constraints identified by the `constraintName` parameter. This method returns a value of 1 if conformance is valid; otherwise it returns a value of 0.

This method also logs error messages from the constraint documents, which can be viewed by querying the public view [orddcm\\_conformance\\_vld\\_msgs](#). The public view [orddcm\\_constraint\\_names](#) contains the list of constraint names.

**Parameters****constraintName**

The name of the constraint to be used for conformance validation checking.

**Pragmas**

None.

## Exceptions

None.

## Usage Notes

If this method is called from a SQL query, ensure that the constraint rule definition does not contain any <ACTION> elements.

Use the preference parameter `EXP_IF_NULL_ATTR_IN_CONSTRAINT` to indicate whether to throw exceptions when encountering missing attributes or null attribute values during conformance validation. See [Defining the EXP\\_IF\\_NULL\\_ATTR\\_IN\\_CONSTRAINT Preference Parameter](#) for more information about this preference parameter.

## Examples

Check if the ORDDicom objects are conformance valid. Then, show any conformance validation messages that are generated.

```
declare
  cursor dicom_src_cur is
  select dicom_src from medical_image_obj order by id;
begin
  for rec in dicom_src_cur loop
    dbms_output.put_line('isConformanceValid(PatientModule): ' ||
      rec.dicom_src.isConformanceValid('PatientModule'));
  end loop;
end;
/

select t1.id, t2.message, t2.msg_time time
from medical_image_obj t1, orddcm_conformance_vld_msgs t2
where t1.dicom_src.sop_instance_uid = t2.sop_instance_uid and
      t2.rule_name = 'PatientModule';
```

## 8.4.18 isLocal()

### Format

```
isLocal( ) RETURN INTEGER DETERMINISTIC PARALLEL_ENABLE
```

### Description

Returns the local status of the source. If the DICOM content is stored in the source BLOB, the object is defined as local. If the DICOM content is stored externally in an operating system-specific file, the object is defined as not local. This method returns a value of 1 if the object is local; otherwise it returns a value of 0.

### Parameters

None.

### Pragmas

None.

**Exceptions**

None.

**Usage Notes**

None.

**Examples**

Check if the DICOM content is local:

```
select t.dicom_src.isLocal() from medical_image_obj t;
declare
  obj orddicom;
begin
  select dicom_src into obj from medical_image_obj where id = 1 for update;
  if (obj.isLocal() = 0) then
    obj.import();
  end if;
  update medical_image_obj set dicom_src = obj where id = 1;
end;
/
```

## 8.4.19 makeAnonymous( )

**Format**

```
makeAnonymous(SELF IN ORDDicom,
              dest_SOP_INSTANCE_UID IN VARCHAR2,
              dest IN OUT NOCOPY ORDDicom,
              anonymityDocName IN VARCHAR2 DEFAULT 'ordcman.xml')
```

**Description**

Removes patient identifying information from the ORDDicom object after copying it into another ORDDicom object, based on a specified anonymity document. Both the embedded DICOM content and the metadata attribute in the destination ORDDicom object are made anonymous.

**Parameters****dest\_SOP\_INSTANCE\_UID**

The SOP instance UID of the destination ORDDicom object. It must ensure that the destination DICOM content is globally unique.

**dest**

An empty ORDDicom object in which to store the anonymous ORDDicom object.

**anonymityDocName**

The name of the anonymity document. The default name is `ordcman.xml`.

**Pragmas**

None.

## Exceptions

None.

## Usage Notes

Use this method to remove patient identifying information from the embedded DICOM content for use in data sharing and research.

## Examples

Remove patient identifying information from the destination ORDDicom object:

 **Note:**

Replace *<unique-UID>* with the UID that identifies the organization producing the DICOM content and the DICOM content within that organization.

```

declare
  obj_src orddicom;
  obj_dest orddicom;
  dest_sop_instance_uid varchar2(128) := '<unique-UID>';
begin
  select dicom_src, dicom_dest into obj_src, obj_dest
  from medical_image_obj where id = 1 for update;
  obj_src.makeAnonymous(dest_sop_instance_uid, obj_dest, 'ordcman.xml');

  update medical_image_obj set dicom_dest = obj_dest where id = 1;
end;
/

```

## 8.4.20 processCopy( ) to BLOBs

### Format

```

processCopy(SELF IN ORDDicom,
            command IN VARCHAR2,
            dest IN OUT NOCOPY BLOB)

```

### Description

Uses the ORDDicom object as the source image to perform the specified processing operations on the image, and then stores the resulting image in the destination BLOB. The original ORDDicom object remains unchanged.

### Parameters

#### command

A command string that accepts a processing operator as input. Valid values include: `frame`, `contentFormat`, `fileFormat`, `compressionFormat`, `cut`, `scale`, and `rotate`. See [DICOM Processing and Supported Formats](#) for information about processing operators.

**dest**

The destination BLOB that contains the output of the process command on the ORDDicom object.

**Pragmas**

None.

**Exceptions**

None.

**Usage Notes**

Use this method to perform processing operations on an ORDDicom object and store the results in a BLOB. In this case, the output in the BLOB is image or video content.

See [DICOM Encoding Rules](#) for information about the encoding rules that support DICOM content processing. See [DICOM Processing and Supported Formats](#) for more information about DICOM processing.

Use the preference parameter `VALIDATE_METADATA` to specify whether the XML documents are validated against the Oracle default DICOM metadata schema. See [Defining the VALIDATE\\_METADATA Preference Parameter](#) for more information about this preference parameter.

**Examples**

Copy the DICOM content into a BLOB and then process it:

```
declare
  obj orddicom;
  dest blob;
begin
  select dicom_src, blob_dest into obj, dest
  from medical_image_obj where id = 1 for update;

  obj.processCopy('fileFormat=jpeg maxScale=100 100', dest);
end;
/
```

## 8.4.21 processCopy( ) to ORDDicom

**Format**

```
processCopy(SELF IN ORDDicom,
            command IN VARCHAR2,
            dest_SOP_INSTANCE_UID IN VARCHAR2,
            dest IN OUT NOCOPY ORDDicom,
            metadata IN SYS.XMLTYPE DEFAULT NULL)
```

**Description**

Uses the ORDDicom object as the source image to perform the specified processing operations on the image, and then stores the resulting image in the destination ORDDicom object. The original ORDDicom object remains unchanged.

## Parameters

### command

A command string that accepts a processing operator as input. Valid values include: `compressionFormat`, `frame`, `contentFormat`, `cut`, `scale`, and `rotate`. See [DICOM Processing and Supported Formats](#) for information about processing operators.

### dest\_SOP\_INSTANCE\_UID

The SOP instance UID of the destination ORDDicom object. It must ensure that the destination DICOM content is globally unique.

### dest

An empty ORDDicom object in which to store the new DICOM content with the new metadata.

### metadata

The new metadata to be written into the new DICOM content.

## Pragmas

None.

## Exceptions

None.

## Usage Notes

Use this method to perform processing operations on an ORDDicom object and store the results in an ORDDicom object. In this case, the output is image or video content.

See [DICOM Encoding Rules](#) for information about the encoding rules that support DICOM content processing. See [DICOM Processing and Supported Formats](#) for more information about DICOM processing.

Use the preference parameter `VALIDATE_METADATA` to specify whether the XML documents are validated against the Oracle default DICOM metadata schema. See [Defining the VALIDATE\\_METADATA Preference Parameter](#) for more information about this preference parameter.

## Examples

Copy the DICOM content into an ORDDicom object and then process it:

 **Note:**

Replace `<unique-UID>` with the UID that identifies the organization producing the DICOM content and the DICOM content within that organization.

```
declare
  obj_src orddicom;
  obj_dest orddicom;
  dest_sop_instance_uid varchar2(128) := '<unique-UID>';
begin
  select dicom_src, dicom_dest into obj_src, obj_dest
```



```
from medical_image_obj where id = 1 for update;
obj_src.processcopy('compressionFormat=jpeg',
                   dest_sop_instance_uid,
                   obj_dest);

update medical_image_obj set dicom_dest = obj_dest where id = 1;
end;
/
```

## 8.4.22 processCopy( ) to ORDImage

### Format

```
processCopy(SELF IN ORDDicom,
            command IN VARCHAR2,
            dest IN OUT NOCOPY ORDImage)
```

### Description

Uses the ORDDicom object as the source image to perform the specified processing operations on the image, and then stores the resulting image in the destination ORDImage object. The original ORDDicom object remains unchanged.

### Parameters

#### command

A command string that accepts an image processing operator as input. Valid values include: `frame`, `contentFormat`, `fileFormat`, `compressionFormat`, `cut`, `scale`, and `rotate`. See [DICOM Processing and Supported Formats](#) for information about image processing operators.

#### dest

An empty ORDImage object in which to store the new, processed ORDImage object without the DICOM metadata.

### Pragmas

None.

### Exceptions

None.

### Usage Notes

Use this method to get a non-DICOM image that is suitable for presentation on the Web from the embedded DICOM content.

See [DICOM Encoding Rules](#) for information about the encoding rules that support image content processing. See [DICOM Processing and Supported Formats](#) for more information about DICOM processing.

Use the preference parameter `VALIDATE_METADATA` to specify whether the XML documents are validated against the Oracle default DICOM metadata schema. See [Defining the VALIDATE\\_METADATA Preference Parameter](#) for more information about this preference parameter.

## Examples

Copy the DICOM content into an ORDImage object and then process it:

```
declare
  obj_src orddicom;
  obj_dest ordimage;
begin
  select dicom_src, image_dest into obj_src, obj_dest
  from medical_image_obj where id = 1 for update;
  obj_src.processcopy('fileFormat=jpeg maxScale=100 100', obj_dest);

  update medical_image_obj set image_dest = obj_dest where id = 1;
end;
/
```

## 8.4.23 setProperties()

### Format

```
setProperties(SELF IN OUT NOCOPY ORDDicom)
```

### Description

Sets the attributes of the ORDDicom object. The attributes of the ORDDicom object are populated and the embedded DICOM content attributes are extracted into the metadata attribute of the ORDDicom object. The XML metadata conforms to the default metadata schema namespace [http://xmlns.oracle.com/ord/dicom/metadata\\_1\\_0](http://xmlns.oracle.com/ord/dicom/metadata_1_0).

If the repository contains a stored tag list document, the XML metadata contains only the DICOM attributes specified by the stored tag list. Otherwise, the XML metadata contains all the attributes from the embedded DICOM content.

### Parameters

None.

### Pragmas

None.

### Exceptions

None.

### Usage Notes

Use this method to populate ORDDicom object attributes and to get the metadata from the embedded DICOM content.

Use the preference parameter XML\_SKIP\_ATTR to specify size limits for DICOM attributes to be omitted when encoding into XML. See [Defining the XML\\_SKIP\\_ATTR Preference Parameter](#) for more information about this preference parameter.

Use the preference parameter VALIDATE\_METADATA to specify whether the XML documents are validated against a specific XML schema that is registered with Oracle

XML DB. See [Defining the VALIDATE\\_METADATA Preference Parameter](#) for more information about this preference parameter.

### Examples

Set the attributes of the ORDDicom object:

```
declare
  obj orddicom;
begin
  select dicom_src into obj from medical_image_obj where id = 1 for update;
  obj.setProperties();
  update medical_image_obj set dicom_src = obj where id = 1;
end;
/
```

## 8.4.24 writeMetadata( )

### Format

```
writeMetadata(SELF IN ORDDicom,
              metadata IN SYS.XMLTYPE,
              dest IN OUT NOCOPY ORDDicom)
```

### Description

Modifies the current ORDDicom object with the metadata provided by making a copy of the existing ORDDicom object in the destination ORDDicom object, and then modifying the metadata. The original ORDDicom object remains unchanged. The attributes in the embedded DICOM content of the destination ORDDicom object are copied from the metadata that was input.

### Parameters

#### metadata

The input metadata stored in data type XMLType. In the destination ORDDicom object, the input metadata is used to update the values for attributes that are identical to attributes in the source ORDDicom object, or to add any new attributes. The metadata must conform to the default metadata schema with the namespace `http://xmlns.oracle.com/ord/dicom/metadata_1_0`. The SOP instance UID in the metadata must ensure that the destination DICOM content is globally unique.

#### dest

An empty ORDDicom object in which to store the new embedded DICOM content with the new metadata.

### Pragmas

None.

### Exceptions

None.

### Usage Notes

Use this method to update attributes in the embedded DICOM content.

In addition, you can use this method to add private attributes to the embedded DICOM content.

See [DICOM Encoding Rules](#) for information about the encoding rules that support metadata extraction.

Use the preference parameter `VALIDATE_METADATA` to specify whether the XML documents are validated against the Oracle default DICOM metadata schema. See [Defining the `VALIDATE\_METADATA` Preference Parameter](#) for more information about this preference parameter.

Use the preference parameter `SQ_WRITE_LEN` to specify how the DICOM sequence (SQ) types are encoded. See [Defining the `SQ\_WRITE\_LEN` Preference Parameter](#) for more information about this preference parameter.

### Examples

Write the new metadata to the copy of the embedded DICOM content:

```
declare
  obj_src orddicom;
  obj_dest orddicom;
  metadata xmltype;
begin
  metadata := xmltype(bfilename('DICOMDIR', 'wm_meta.xml'),
                    nls_charset_id('AL32UTF8'),
                    'http://xmlns.oracle.com/ord/dicom/metadata_1_0');

  select dicom_src, dicom_dest into obj_src, obj_dest
  from medical_image_obj where id = 1 for update;

  obj_src.writeMetadata(metadata, obj_dest);

  update medical_image_obj set dicom_dest = obj_dest where id = 1;

end;
/
```

# Part III

## DICOM Administration Usage and Reference

This part contains user and reference information for administrators of the DICOM data model repository.

This part includes these chapters:

- [Overview of DICOM Administration](#)
- [Creating DICOM Configuration Documents](#)
- [Administering the DICOM Repository](#)
- [ORD\\_DICOM\\_ADMIN Package Reference](#)

# 9

## Overview of DICOM Administration

This chapter briefly describes the tasks that are related to the administration of the Oracle Multimedia DICOM data model repository.

The Oracle Multimedia DICOM data model repository is a set of collectively managed, user-configurable XML documents that defines the run-time behavior of Oracle Multimedia DICOM (see [Configuration Documents in the Repository](#)). Because Oracle Multimedia DICOM is fully functional after installing Oracle Multimedia, administrators need not access the repository unless they want to update it to configure Oracle Multimedia DICOM for a particular database instance. Each database has its own set of configuration documents. Administrators can customize the repository by adding or deleting configuration documents. Only one administrator at a time is permitted to make changes in the data model repository. Administrators of the DICOM data model repository are assigned the ORDADMIN role.

Administrators can perform several repository management tasks. This chapter provides guidelines for loading the repository, and retrieving, adding, and removing content from the repository.

The DICOM data model repository provides an administrative (PL/SQL) application programming interface (API) for managing configuration documents. See [ORD\\_DICOM\\_ADMIN Package Reference](#) for reference information about the ORD\_DICOM\_ADMIN data model repository API.

This chapter includes these sections:

- [Assigning Administrator Roles and Privileges](#)
- [Managing XML Schemas](#)
- [Loading the Data Model Repository](#)
- [Managing the Impact of Oracle Data Guard Rolling Upgrades](#)
- [Browsing the Repository with Views](#)
- [Exporting Documents from the Repository](#)
- [Inserting Documents into the Repository](#)
- [Updating Documents in the Repository](#)
- [Deleting Documents from the Repository](#)
- [Oracle Data Pump Utilities Support for Oracle Multimedia DICOM](#)

 **See Also:**

- [Creating DICOM Configuration Documents](#) for detailed information about writing configuration documents
- [Table 3-1](#) for information about other application programming interfaces (APIs) that are available to administrators

## 9.1 Assigning Administrator Roles and Privileges

After installing Oracle Multimedia DICOM, the ORDADMIN role is created, with the database system privileges required for administration of the DICOM data model repository.

The ORDADMIN role must be assigned to the administrator of the DICOM data model repository. The following code segment shows a sample GRANT statement for the administrator `dcmadmin`:

```
GRANT ORDADMIN to dcmadmin;
```

Because of the way database roles behave, tasks for which the administrator must write PL/SQL named procedures require explicit privileges. The following code segment shows a sample of a GRANT statement for an administrator named `dcmadmin`:

```
GRANT EXECUTE on ORD_DICOM_ADMIN to dcmadmin;  
GRANT SELECT on orddcm_document_refs to dcmadmin;
```

Administrators must also be granted the WRITE privilege for specified directories. For example, during operations where configuration documents are exported, administrators must have WRITE access to the directory where those documents are to be stored.

All users can load the data model repository into memory structures and view several public views. Only administrators can export, insert, or delete configuration documents from the data model repository. And, only administrators can query administrator-only views.

 **Note:**

Keep these administrative guidelines in mind:

- The `editDataModel()` procedure enables administrators to lock the data model while making changes.
- Changes in the data model repository are committed only by using the `publishDataModel()` procedure. In addition to committing the changes, this procedure unlocks the data model, making it available to other administrators.

See the [editDataModel\(\) Procedure](#) and the [publishDataModel\(\) Procedure](#) for more information.

## 9.2 Managing XML Schemas

The DICOM XML schemas in Oracle Multimedia DICOM are registered as global XML schemas in Oracle Database with Oracle XML DB. If you define any custom XML schemas, they must be also registered as global or local schemas with Oracle XML DB. You can find and examine the registered XML schemas by querying the dictionary view `ALL_XML_SCHEMAS`.

### Note:

Custom XML schemas associated with user-defined mapping documents can be registered as local schemas with Oracle XML DB. Registering your custom XML schemas as local schemas with Oracle XML DB prevents other users from using them for validation. Register your custom XML schemas as global schemas with Oracle XML DB to allow other users to validate against them.

The following subsections briefly describe how you can use XML DB with your DICOM XML schemas:

- [Registering XML Schemas](#)
- [Finding User-Defined XML Schemas](#)

### See Also:

- *Oracle XML DB Developer's Guide* for more information about registering XML schemas
- *Oracle Database Reference* for more information about the dictionary view `ALL_XML_SCHEMAS`

### 9.2.1 Registering XML Schemas

The DICOM XML schemas that correspond to the default configuration documents supplied by Oracle are automatically registered during installation. (See [DICOM XML Schemas](#) for a list of the installed DICOM XML schemas.) Oracle requires that you manually register all user-defined (custom) XML schemas as global or local schemas, using Oracle XML DB.

### Note:

Setting the parameter `LOCAL` to `FALSE` indicates that the schema is global.



 **See Also:**

*Oracle XML DB Developer's Guide* for an example of how to register a custom schema as a global schema

## 9.2.2 Finding User-Defined XML Schemas

After registering the custom XML schemas for your DICOM data model repository, you can search for and examine them. Query the dictionary view `ALL_XML_SCHEMAS` to find all the registered XML schemas.

**Example 9-1** shows a sample of how to list the namespaces for the metadata schemas associated with the user-defined mapping documents in your DICOM data model repository.

 **Note:**

**Example 9-1** includes a call to the `setDataModel()` procedure. This procedure call might not be required in all situations.

See the [setDataModel\(\) Procedure](#) and [Loading the Data Model Repository](#) for more information.

 **See Also:**

*Oracle XML DB Developer's Guide* for more information about finding registered XML schemas

### Example 9-1 Finding User-Registered XML Schemas

```
exec ord_dicom.setdatamodel;

select t.doc_name, xmlcast(xmlquery(
  'declare default element namespace
  "http://xmlns.oracle.com/ord/dicom/mapping_1_0"; $x//NAMESPACE'
  passing ord_dicom_admin.getdocumentcontent(t.doc_name) as "x"
  returning content) as varchar2(4000) ) as schema_url
from orddcm_documents t
where t.installed_by_oracle=0 and t.doc_type= 'MAPPING'
order by t.doc_id asc;
```

DOC_NAME	SCHEMA_URL
sample_map_10.xml	http://www.mycompany.com/metatest10
sample_map_11.xml	http://www.mycompany.com/metatest11

## 9.3 Loading the Data Model Repository

At the start of every database session, administrators and users must load the data model repository from the database into memory structures. Users load the data model by calling the `setDataModel()` procedure. Administrators load the data model by calling either the `setDataModel()` procedure or the `editDataModel()` procedure.

After loading the repository into memory, administrators and users can call the `setDataModel()` procedure whenever the application requires the new data model changes.

### Note:

Keep these guidelines in mind:

- Administrators and users must call the `setDataModel()` procedure before calling any other DICOM methods, functions, or procedures.
- Administrators can call the `setDataModel()` procedure when no changes are being made to the data model (for example: when calling the `getDocumentContent()` procedure or the `exportDocument()` procedure only).
- Administrators can call the `editDataModel()` procedure when making changes to the data model (for example: when inserting or deleting documents).

See the [setDataModel\(\) Procedure](#) and the [editDataModel\(\) Procedure](#) for more information.

Using the DICOM data model utility in the `ORD_DICOM` package, administrators and users call the `setDataModel()` procedure as follows:

```
exec ord_dicom.setdatamodel;
```

See the [setDataModel\(\) Procedure](#) for more information.

Using the `ORD_DICOM_ADMIN` package, administrators call the `editDataModel()` procedure as follows:

```
exec ord_dicom_admin.editDataModel();
```

See the [editDataModel\(\) Procedure](#) for more information.

## 9.4 Managing the Impact of Oracle Data Guard Rolling Upgrades

Oracle Multimedia DICOM does not support making changes to the DICOM data model during a Data Guard rolling upgrade. Specifically, administrators cannot insert or delete documents from the repository while a rolling upgrade is in progress. Thus, avoid calling any of these procedures during a rolling upgrade:

- [deleteDocument\(\) Procedure](#)

- [editDataModel\( \) Procedure](#)
- [insertDocument\( \) Procedure](#)
- [publishDataModel\( \) Procedure](#)

 **Note:**

Administrators can call the `rollbackDataModel( )` procedure to terminate an editing session that began before starting a rolling upgrade operation (see the [rollbackDataModel\( \) Procedure](#)).

 **See Also:**

- *Oracle Database Upgrade Guide* for information about database rolling upgrades
- *Oracle Data Guard Concepts and Administration* for information about rolling upgrades and other Oracle Data Guard features

## 9.5 Browsing the Repository with Views

Several public views are available to all DICOM users for browsing the DICOM repository. Oracle Multimedia DICOM also provides the administrator view `orddcm_document_refs`, which lists the documents that are referenced by other documents in the repository.

Administrators commonly use the views `orddcm_documents`, `orddcm_document_types`, and `orddcm_document_refs` when inserting, updating, and deleting documents from the repository.

See [Table 3-2](#) for the list of repository views that are available to administrators.

## 9.6 Exporting Documents from the Repository

Before exporting documents from the repository (and possibly before making any changes to the configuration documents), administrators should perform the following tasks:

1. Call the `setDataModel( )` procedure at the beginning of each database session to load the repository from the database into memory structures. Locking the repository at this point is not required.

Administrators (and other users) can also call this procedure whenever the application requires the new data model changes.

See the [setDataModel\( \) Procedure](#) for more information.

2. Obtain copies of the existing documents in the repository, using either the `getDocumentContent( )` function or the `exportDocument( )` procedure.

The `getDocumentContent( )` function returns the specified document as data type `XMLType`.

The `exportDocument()` procedure writes the contents of the specified document to a specified file in a directory for which the administrator has been granted the `WRITE` privilege.

See the [getDocumentContent\(\) Function](#) and the [exportDocument\(\) Procedure](#) for more information.

## 9.7 Inserting Documents into the Repository

The process of inserting documents into the repository can involve the use of these procedures:

- `editDataModel()`
- `insertDocument()`
- `publishDataModel()`
- `rollbackDataModel()`

See [ORD\\_DICOM\\_ADMIN Package Reference](#) for reference information about these procedures. See [Administering the DICOM Repository](#) for examples of the insertion process.

The following subsections briefly describe the insertion process for different types of documents:

- [Inserting Anonymity, Mapping, and Constraint Documents](#)
- [Inserting Dictionary Documents](#)
- [Inserting Preference and UID Definition Documents](#)
- [Inserting Stored Tag List Documents](#)
- [Inserting DICOM Protocol Documents](#)

### 9.7.1 Inserting Anonymity, Mapping, and Constraint Documents

For anonymity documents and mapping documents, the order of insertion is irrelevant. For constraint documents, however, the order of insertion is important. If there are dependencies among any of the constraint documents to be inserted, insert the documents without dependencies first. Then, insert the remaining documents.

### 9.7.2 Inserting Dictionary Documents

Inserting standard or private dictionary documents requires merging all dictionary attributes each time a new dictionary document is inserted, in accordance with the following rules:

- Attribute tags must be unique, and must not match existing wildcard tags.
- Attribute tags must not be used in other document types.

In addition, for private dictionary documents, attribute tags must not be included in any existing range tags.

 **Note:**

Oracle recommends limiting insertions of standard dictionary documents to reflect changes or additions to the DICOM standard only.

See the XML schemas `ordcmsd.xsd` and `ordcmpv.xsd` in [DICOM XML Schemas](#) for more information about DICOM attributes and attribute tags in dictionary documents.

### 9.7.3 Inserting Preference and UID Definition Documents

The installed preference document (`ordcmpf.xml`) assigns default preference values. Administrators can insert a user-defined preference document into the repository to override some or all of the default preference values. Preference values that are not overridden by a user-defined preference document retain their Oracle-defined default values.

Administrators can also insert user-defined UID definition documents to add new private UID values, or to reflect updates in the DICOM standard.

To insert a user-defined preference or UID definition document, follow these steps:

1. Export the installed, Oracle-defined document and rename it.
2. Update the exported, renamed document, changing the parameter values as required.
3. Insert the updated user-defined document into the repository.

If a user-defined preference or UID definition document is later deleted, the Oracle-installed document is reapplied.

 **Note:**

Only one user-defined preference or UID definition document is permitted in the repository.

### 9.7.4 Inserting Stored Tag List Documents

Administrators can use the `generateTagListDocument()` function to create a stored tag list document, which is a list of the attribute tags used in a specified set of mapping and constraint documents in the repository.

The stored tag list document is an optional XML document that specifies the DICOM attributes to be extracted from the embedded DICOM content and stored in the XML metadata attribute of the `ORDDicom` object when the `setProperties()` method is called. Generally, stored tag list documents contain the attribute tags used in mapping and constraint documents.

See the [generateTagListDocument\(\) Function](#) for more information. See [Sample Session 4: Inserting a Stored Tag List Document](#) for an example of the stored tag list document insertion process.

## 9.7.5 Inserting DICOM Protocol Documents

Administrators can use the `insertDocument()` procedure (specifying `DICOM_PROTOCOL` as the value of the `docType` parameter) to insert a new DICOM protocol document into the data model.

The DICOM protocol document is an XML document that is a named container for user-configurable parameters that govern where DICOM images and metadata are stored in Oracle Database. Each instance of the Oracle DICOM protocol adapter that is configured to connect to Oracle Database must have an associated DICOM protocol document in order to store, query, and retrieve DICOM images and metadata to and from Oracle Database.

See the [insertDocument\(\) Procedure](#) for more information. See [Sample Session 5: Inserting a DICOM Protocol Document](#) for an example of the DICOM protocol document insertion process.

### See Also:

- [Configuring DICOM Protocol Support for Oracle Database](#) for details about configuring DICOM protocol documents
- [Creating DICOM Protocol Documents](#) for more information about creating DICOM protocol documents

## 9.8 Updating Documents in the Repository

The process of updating documents in the repository can involve the use of these procedures:

- `editDataModel()`
- `exportDocument()`
- `deleteDocument()`
- `insertDocument()`
- `publishDataModel()`
- `rollbackDataModel()`

See [ORD\\_DICOM\\_ADMIN Package Reference](#) for reference information about these procedures. See [Sample Session 2: Updating a Mapping Document](#) for an example of the update process.

The following subsections briefly describe the update process for different types of documents:

- [Updating Anonymity\\_ Mapping\\_ and Constraint Documents](#)
- [Updating Dictionary Documents](#)
- [Updating Preference and UID Definition Documents](#)

## 9.8.1 Updating Anonymity, Mapping, and Constraint Documents

Updating anonymity documents, mapping documents, and constraint documents involves a similar set of actions. For both anonymity documents and mapping documents, follow these steps:

1. Export the existing document.
2. Edit the exported document.
3. Delete the existing document.
4. Insert the edited document.

Constraint documents are updated in reverse order from their insertion order. In addition, if there are dependencies among any of the constraint documents to be updated, update the documents with no dependencies first. Then, update the remaining documents.

## 9.8.2 Updating Dictionary Documents

Updating standard or private dictionary documents requires checking the attribute tags and dependencies with other documents in the repository. Standard and private dictionary documents can be updated only if no other documents are using the attribute tags that are defined in the new documents. To update the attribute tags that are being used by other documents, first update the dependent documents to remove the referenced attribute tags. Then, update the dictionary tags in accordance with the following rules:

- Attribute tags must be unique, and must not match existing wildcard tags.
- Attribute tags must not be used in other document types.

In addition, for private dictionary documents, DICOM attribute tags must not be included in any existing range tags.

 **Note:**

Oracle recommends limiting updates of standard dictionary documents to reflect changes or additions to the DICOM standard only.

See the XML schemas `ordcmsd.xsd` and `ordcmpv.xsd` in [DICOM XML Schemas](#) for more information about DICOM attributes and attribute tags in dictionary documents.

## 9.8.3 Updating Preference and UID Definition Documents

To update existing user-defined preference documents or UID definition documents, follow these steps:

1. Export the user-defined document.
2. Edit the exported document.
3. Delete the existing user-defined document.
4. Insert the edited document.

 **Note:**

UID values defined by Oracle or the DICOM standard must not be changed.

## 9.9 Deleting Documents from the Repository

The process of deleting documents from the repository can involve the use of these procedures:

- `editDataModel()`
- `exportDocument()`
- `deleteDocument()`
- `publishDataModel()`
- `rollbackDataModel()`

Use the `exportDocument()` procedure to save a copy of an original document before deleting it from the repository.

Only user-defined documents can be deleted. Documents installed by Oracle are default documents that cannot be removed. Additionally, to ensure conformance with referenced constraints, remove documents in the reverse order from the order in which they were loaded.

See [ORD\\_DICOM\\_ADMIN Package Reference](#) for reference information about these procedures. See [Sample Session 3: Deleting a Constraint Document](#) for an example of the deletion process.

The following subsections briefly describe the deletion process for different types of documents:

- [Deleting Anonymity, Mapping, and Constraint Documents](#)
- [Deleting Dictionary Documents](#)
- [Deleting Preference and UID Definition Documents](#)

### 9.9.1 Deleting Anonymity, Mapping, and Constraint Documents

For anonymity documents and mapping documents, the order of deletion is irrelevant. Constraint documents, however, must be deleted in reverse order from their insertion order.

### 9.9.2 Deleting Dictionary Documents

Deleting standard or private dictionary documents requires checking dependencies with other documents in the repository. For example, a user-defined dictionary document can be deleted only if no other documents reference it.

### 9.9.3 Deleting Preference and UID Definition Documents

When a user-defined preference document is deleted, the values of the preference parameters revert to the installed values from the default Oracle-defined preference



document (`ordcmpf.xml`). Similarly, when a UID definition document is deleted, the UID values revert to the installed values from the default Oracle-defined UID definition document (`ordcmui.xml`).

## 9.10 Oracle Data Pump Utilities Support for Oracle Multimedia DICOM

Export and import operations using Oracle Data Pump are described in *Oracle Database Utilities*. This section provides guidelines and examples for using the Oracle Data Pump commands `expdp` and `impdp` to perform export and import operations on Oracle Multimedia DICOM.

DICOM data stored in user tables is automatically handled by Oracle Data Pump. The DICOM data model repository contains tables that are populated from Oracle-installed documents and user-supplied documents stored in the `ORDDATA` schema. On full mode export and import operations, user-supplied documents stored in the `ORDDATA` schema are exported and imported. Oracle-installed documents stored in the `ORDDATA` schema already exist in the source database and the target database, thus they are not exported or imported on these operations.

The examples in this section use the commands `expdp` and `impdp`. After you enter the command with your user name and the appropriate parameters, you are prompted for a password. The examples in this section do not show these prompts.

The following subsections provide information about roles and modes for export and import operations on the DICOM data model repository:

- [Roles for Export and Import Operations](#)
- [Mode for Export and Import Operations](#)



### See Also:

*Oracle Database Utilities* for more information about Oracle Data Pump and its command-line clients, `expdp` and `impdp`

### 9.10.1 Roles for Export and Import Operations

Many Data Pump export and import operations require that administrators have these roles, respectively:

- `DATAPUMP_EXP_FULL_DATABASE`
- `DATAPUMP_IMP_FULL_DATABASE`



### See Also:

*Oracle Database Utilities* for more information about the required roles for the Oracle Data Pump Export and Import utilities

## 9.10.2 Mode for Export and Import Operations

Export and import operations for multimedia data stored in user tables (whether in BLOB columns or in Oracle Multimedia data type columns) are supported in all export and import modes. However, when administrators use Oracle Multimedia DICOM to store user documents in the DICOM data model repository, export and import operations are supported in full mode only. User documents in the DICOM data model are only exported and imported in full mode.

The following subsections describe these operations:

- [Exporting in Full Mode](#)
- [Importing in Full Mode](#)

### 9.10.2.1 Exporting in Full Mode

Use full mode to export when you use Oracle Multimedia DICOM and the DICOM data model repository contains user documents that you want to export.

[Example 9-2](#) shows how to perform a full mode export.

[Example 9-2](#) defines the following parameters and values:

Parameter and Value	Definition
FULL=Y	Specifies full mode export. There is no default value.
CONTENT=ALL	Specifies the content to export. The default value ALL specifies to export data and metadata.
DIRECTORY=DUMP_DIR	Specifies the default directory location for the dump file and the log file. The directory DUMP_DIR must already exist, and you must have access to it.
DUMPFIL=exp_orddata.dmp	Specifies the name of the dump file for the export job.
LOGFILE=exp_orddata.dmp	Specifies the name of the log file for the export job.

#### See Also:

*Oracle Database Utilities* for more information about full mode export

#### Example 9-2 Full Mode Export

```
expdp FULL=Y CONTENT=ALL DIRECTORY=DUMP_DIR
      DUMPFIL=exp_orddata.dmp LOGFILE=exp_orddata.log
```

### 9.10.2.2 Importing in Full Mode

Use full mode to import when you use Oracle Multimedia DICOM and the DICOM data model repository contains user documents that you want to import.

[Example 9-3](#) shows how to perform a full mode import, using the parameters and settings recommended by Oracle.

Example 9-3 defines the following parameters and values:

Parameter and Value	Definition
FULL=Y	Specifies full mode import. There is no default value.
CONTENT=ALL	Specifies the content to import. The default value ALL specifies to import data and metadata.
DIRECTORY=DUMP_DIR	Specifies the default directory location for the dump file and the log file. The directory DUMP_DIR must already exist, and you must have access to it.
DUMPFILE=exp_orddata.dmp	Specifies the name of the dump file for the import job.
LOGFILE=imp_orddata.log	Specifies the name of the log file for the import job.



**See Also:**

*Oracle Database Utilities* for more information about full mode import

**Example 9-3 Full Mode Import**

```
impdp FULL=Y CONTENT=ALL DIRECTORY=DUMP_DIR DUMPFILE=exp_orddata.dmp
LOGFILE=imp_orddata.log
```

# 10

## Creating DICOM Configuration Documents

Administrators can perform several repository management tasks, including creating their own configuration documents.

This chapter describes the characteristics of configuration documents and provides instructions on how to write configuration documents that are specific to a particular organization or enterprise.

 **Note:**

In this chapter, names of attributes for XML elements appear in monospace type.

Oracle Multimedia DICOM supports the processing of DICOM files that contain private attribute definer names consisting of special characters. To enable referencing of DICOM metadata tags that refer to private attribute definers using these special characters, Oracle Multimedia DICOM extends the syntax for value locators used in the DICOM configuration documents to enable the expression of these definers. The [DICOM value locator](#) type identifies DICOM attributes or their child components within the DICOM content. See [General Format for DICOM Value Locators](#) for reference information.

Administrators can use DICOM value locators with anonymity, constraint, and mapping documents. The DICOM value locator is also used in the mid-tier Java API. See [Using DICOM Value Locators in Anonymity Documents](#), [Using DICOM Value Locators in Constraint Documents](#), and [Using DICOM Value Locators in Mapping Documents](#), respectively, for more information about using DICOM value locators in anonymity, constraint, and mapping documents. See [Overview of DICOM Administration](#) for more information about inserting, updating, and deleting configuration documents. See [Administering the DICOM Repository](#) for examples of these processes.

This chapter includes these sections:

- [Characteristics of Configuration Documents](#)
- [Writing Configuration Documents](#)

 **See Also:**

- *Oracle Multimedia Mid-Tier Java API Reference* for reference information about the Java classes that support DICOM value locators in the middle tier
- <http://medical.nema.org/> for more information about the data structure and encoding definitions of DICOM content, as defined in the DICOM standard

## 10.1 Characteristics of Configuration Documents

After installation, the Oracle Multimedia DICOM data model repository contains the following set of default configuration documents:

- Anonymity (`ordcman.xml`)
- Constraint (`ordcmct.xml`, `ordcmcmd.xml`, `ordcmcmc.xml`)
- Mapping (`ordcmap.xml`)
- Standard Dictionary (`ordcmsd.xml`)
- Private Dictionary (`ordcmpv.xml`)
- Preference (`ordcmpf.xml`)
- UID Definition (`ordcmui.xml`)

 **Note:**

In addition, users can:

- Install an optional stored tag list document that specifies the DICOM attributes to be extracted from the embedded DICOM content and stored in the XML metadata attribute of the ORDDicom object when the `setProperties()` method is called.
- Configure a DICOM protocol document to manage the behavior of a DICOM protocol adapter instance configured to use Oracle Database as the backing storage mechanism for DICOM images and metadata.

See [Configuration Documents in the Repository](#) for a brief definition of each configuration document.

Each type of configuration document has a specific set of characteristics, which are briefly described in these sections:

- [Characteristics of Anonymity Documents](#)
- [Characteristics of Constraint Documents](#)
- [Characteristics of DICOM Protocol Documents](#)
- [Characteristics of Mapping Documents](#)

- [Characteristics of Preference Documents](#)
- [Characteristics of Private Dictionary Documents](#)
- [Characteristics of Standard Dictionary Documents](#)
- [Characteristics of Stored Tag List Documents](#)
- [Characteristics of UID Definition Documents](#)

### 10.1.1 Characteristics of Anonymity Documents

Anonymity documents have these characteristics:

- No other document types depend on anonymity documents.
- There are no dependencies between anonymity documents.
- Anonymity documents depend on the standard and private dictionary documents.
- There is no maximum limit on the number of anonymity documents in the repository.
- Changes made to anonymity documents affect the results of the `isAnonymous()` and `makeAnonymous()` methods.

### 10.1.2 Characteristics of Constraint Documents

Constraint documents have these characteristics:

- No other document types depend on constraint documents.
- There may be dependencies between constraint documents.
- Constraint documents depend on the standard and private dictionary documents and the preference document.
- There is no limit on the number of constraint documents in the repository.
- Constraint documents can be written in such a way that later constraint documents depend on previously inserted constraint documents. As an example using installed constraint documents, `ordcmct.xml` depends on `ordcmcmd.xml`, and both of those documents depend on `ordcmcmc.xml`.
- The `isConformanceValid()` method depends on the specified constraint rule and the DICOM content. If the constraint rule (defined in a constraint document) is changed, the DICOM content may be validated differently.
- The preference parameter `EXP_IF_NULL_ATTR_IN_CONSTRAINT` in the preference document can be used to specify whether to raise an exception when encountering a null value for the attributes specified in the constraint rules. If this preference parameter is set to `true`, the `isConformanceValid()` method raises an exception; otherwise, the predicate that was encountered is evaluated to `false`.

### 10.1.3 Characteristics of DICOM Protocol Documents

DICOM protocol documents have these characteristics:

- No other document types depend on DICOM protocol documents.
- There are no dependencies between DICOM protocol documents.
- There is no limit on the number of DICOM protocol documents in the repository.

- Each DICOM protocol document must contain at least one storage configuration element (the `<storage>` tag), which can be repeated. This element enables you to specify a table in Oracle Database to use for DICOM image and metadata storage.
- Each DICOM protocol document must adhere to the `ordcmdp.xsd` schema.

## 10.1.4 Characteristics of Mapping Documents

Mapping documents have these characteristics:

- No other document types depend on mapping documents.
- There are no dependencies between mapping documents.
- Mapping documents depend on the standard and private dictionary documents and the preference document.
- There is no limit on the number of mapping documents in the repository.
- Changes made to mapping documents affect the results of the `extractMetadata()` method, when the mapping document is used as a parameter.
- If a mapping document specifies a metadata namespace value in the `<NAMESPACE>` element, the XML schema that corresponds to the metadata namespace value must be registered with Oracle XML DB.

### See Also:

*Oracle XML DB Developer's Guide* for more information about registering XML schemas

To enable the `extractMetadata()` method to function correctly, the structure of the mapping document must be consistent with the XML schema that corresponds to the value of the `<NAMESPACE>` element.

- Extracted metadata is schema validated only if both of these conditions exist:
  - The mapping document specifies a value in the `<NAMESPACE>` element.
  - The value of the preference parameter `VALIDATE_METADATA` in the preference document is `true`.

## 10.1.5 Characteristics of Preference Documents

Preference documents have these characteristics:

- A maximum of two (one Oracle-defined and one user-defined) preference documents are permitted in the repository. The installed, Oracle-defined preference document (`ordcmpf.xml`) includes Oracle-fixed preference parameter names and lists of values. The user-defined preference document can update the default preference parameter values that were set in the Oracle-defined preference document.
- Changes to preference parameter values in preference documents change the behavior of DICOM methods, functions, and procedures. Specifically, preference parameter values that are defined in the user-defined preference document override the default values defined in the Oracle-defined preference document.

## 10.1.6 Characteristics of Private Dictionary Documents

Private dictionary documents have these characteristics:

- One private dictionary document (`ordcmpv.xml`) is installed by Oracle.
- There is no limit on the number of private dictionary documents in the repository.

## 10.1.7 Characteristics of Standard Dictionary Documents

Standard dictionary documents have these characteristics:

- One standard dictionary document (`ordcmsd.xml`) is installed by Oracle.
- Changes to standard dictionary documents must be limited to updates in the DICOM standard.
- There is no limit on the number of standard dictionary documents in the repository.

## 10.1.8 Characteristics of Stored Tag List Documents

Stored tag list documents have these characteristics:

- Only one stored tag list document can exist in the repository.
- The stored tag list document depends on the standard and private dictionary documents and the preference document.
- The preference parameter `MANDATE_ATTR_TAGS_IN_STL` enforces the rule that all tags used by the constraint and mapping documents are listed in the stored tag list document. The value of the `MANDATE_ATTR_TAGS_IN_STL` preference parameter in the preference document is `false`, by default. If this preference parameter is set to `true`, the rule is enforced; otherwise it is not enforced.

## 10.1.9 Characteristics of UID Definition Documents

UID definition documents have these characteristics:

- A maximum of two (one Oracle-defined and one user-defined) UID definition documents are permitted in the repository. The installed, Oracle-defined UID definition document (`ordcmui.xml`) includes the UID definitions listed in Part 6 of the DICOM standard.
- Changes to user-defined UID definition documents must be limited to updates in the DICOM standard or additions of new UID values.

 **Note:**

Existing UID values must not be changed.



## 10.2 Writing Configuration Documents

Administrators can write one or more configuration documents to support specific applications or organizations. These subsections describe how to create each type of configuration document:

- [Creating Anonymity Documents](#)
- [Creating Constraint Documents](#)
- [Creating DICOM Protocol Documents](#)
- [Creating Mapping Documents and Metadata XML Schemas](#)
- [Creating Preference Documents](#)
- [Creating Private Dictionary Documents](#)
- [Creating Standard Dictionary Documents](#)
- [Creating Stored Tag List Documents](#)
- [Creating UID Definition Documents](#)

### 10.2.1 Creating Anonymity Documents

Anonymity documents specify the set of attributes to be made anonymous, and the actions to be taken to make those attributes anonymous. In the ORDDicom object, anonymity documents are used by the methods `isAnonymous()` and `makeAnonymous()` to create new objects in which personally identifying information has been removed or replaced.

The XML schema `ordcman.xsd` defines the XML schema that constrains anonymity documents. (See [DICOM XML Schemas](#) for more information about this schema.)

The default anonymity document, `ordcman.xml`, lists a subset of the attributes defined in the Basic Application Level Confidentiality Profile in Part 15 of the DICOM standard. These attributes are either removed or replaced with the string "anonymous" in the DICOM content. In addition, the default anonymity document removes all undefined standard attributes and all private attributes from the DICOM content.

Within each anonymity document, the `<ANONYMITY_ACTION>` element includes an `action` attribute. The value of the `action` attribute can apply to a single attribute or to a set of attributes within that anonymity document. Global actions apply to a set of attributes, such as all private attributes.

The following table describes the valid values for the `action` attribute.

**Table 10-1** action Attribute Values

Value	Description
none	No action is taken. The unchanged value of the specified attribute or the set of attributes appears in the resulting DICOM content.

Table 10-1 (Cont.) action Attribute Values

Value	Description
remove	<p>The default value. The specified attribute or the set of attributes is removed from the resulting DICOM content.</p> <p><b>Note:</b> Some imaging applications may depend on certain attributes (for example: SOP_INSTANCE_UID or SOP_CLASS_UID). In these cases, use the <code>replace</code> action with an appropriate value in place of the <code>remove</code> action.</p>
replace	<p>The attribute value is replaced by the specified value in the resulting DICOM content. The specified replacement value must be a string representation that matches the data type of the tag as defined by the &lt;VR&gt; element in the data dictionaries.</p> <p><b>Note:</b> This action value is not permitted for global actions.</p> <p>For example:</p> <p>The standard tag 00100022 represents the Patient ID, which has a &lt;VR&gt; value of CS (CODE_STRING) in the data dictionary. The data type CS is defined in the XML schema <code>ordcmrdt.xsd</code> as <code>xs:token</code> of length 16. The replacement value must be a string representation that conforms to this definition.</p> <p>The standard tag 00081160 represents the Referenced Frame Number, which has a &lt;VR&gt; value of IS (INTEGER_STRING). The data type IS is defined in the XML schema <code>ordcmrdt.xsd</code> as <code>xs:integer</code>. The replacement value must be a string representation that conforms to this definition.</p>

Attributes in anonymity documents can be standard or private. Standard and private attributes can be either defined or undefined. Defined standard attributes are defined in the DICOM standard and in the standard dictionary in the data model repository. Defined private attributes are defined by and specific to a particular organization. Defined private attributes known to Oracle Multimedia are defined in the private dictionary in the data model repository. Undefined attributes are defined in neither the standard dictionary nor the private dictionary in the data model repository.

The <INDIVIDUAL\_ATTRIBUTE> element defines the action taken to make a defined standard or private attribute anonymous. For private attributes, the action specified in this element always overrides the global action defined by the <PRIVATE\_ATTRIBUTES> element. In addition, standard or private attributes that are undefined cannot be specified as <INDIVIDUAL\_ATTRIBUTE> element values in an anonymity document.

The following table describes the elements that define the global actions in the anonymity document.

Table 10-2 Global Action Elements

Element	Description
<PRIVATE_ATTRIBUTES>	Specifies the action performed on all defined and undefined private attributes. <b>Note:</b> The action for a private attribute defined by the <INDIVIDUAL_ATTRIBUTE> element always overrides the global action defined by the <PRIVATE_ATTRIBUTES> element.
<UNDEFINED_STANDARD_ATTRIBUTES>	Specifies the action performed on all standard attributes that are not defined in the standard dictionaries in the data model repository. A DICOM attribute tag contains a group number and an element number. A standard attribute tag is identified by an even-numbered group number.
<UNDEFINED_PRIVATE_ATTRIBUTES>	Specifies the action performed on all private attributes that are not defined in the private dictionaries in the data model repository. <b>Note:</b> The action value defined by this element takes precedence over the action value defined by the <PRIVATE_ATTRIBUTES > element.

Examples of valid values for an <ATTRIBUTE\_TAG> element are as follows: 00100010, 00100010(DICOM), 10871100(PRIVATE ORG).

**Note:**

Currently, only these values are permitted for the definer name in a private attribute:

- The uppercase and lowercase letters: A-Z
- The numbers: 0-9
- The characters: '.' (dot), ' ' (space), and '/' (forward slash)

The following subsections contain examples that show how to create anonymity documents:

- [Making Standard Attributes Anonymous](#)
- [Making Undefined Standard Attributes Anonymous](#)
- [Making Selected Private Attributes Anonymous](#)
- [Making All Private Attributes Anonymous](#)
- [Using DICOM Value Locators in Anonymity Documents](#)

### 10.2.1.1 Making Standard Attributes Anonymous

This subsection shows how to replace a single standard attribute with specified values that make that attribute anonymous in the resulting DICOM content. [Example 10-1](#) shows a code segment for the standard attribute `Patient's Name`. The XML statements where these actions are defined are highlighted in bold.

The following code segment shows how the `<ATTRIBUTE_TAG>` value `00100010` is defined in the standard dictionary in the data model repository. If the definer name is not specified in the `<ATTRIBUTE_TAG>` value, the default value of "DICOM" is assumed. The value of the `00100010` tag is replaced with the value "anonymous" in the resulting DICOM content.

The standard attribute tag `00100010` is defined as follows in the standard dictionary:

```
<STANDARD_ATTRIBUTE_DEFINITION>
  <TAG>00100010</TAG>
  <NAME>Patient's Name</NAME>
  <VR>PN</VR>
  <VM>1</VM>
</STANDARD_ATTRIBUTE_DEFINITION>
```

The tag definition shown in the preceding code segment represents the standard attribute `Patient's Name`, of data type `PN` as defined by the `<VR>` element. The `<VR>` element is the value representation element used to specify standard data types, as defined in Part 5 of the DICOM standard. The data type `PN` is defined in the XML schema `ordcmrtd.xsd`. The replacement value for the attribute `Patient's Name` must be a string representation of the value defined by the `<VR>` element.

#### Example 10-1 Making a Standard Attribute Anonymous

```
<INDIVIDUAL_ATTRIBUTE>
  <ATTRIBUTE_TAG>00100010</ATTRIBUTE_TAG>
  <DESCRIPTION>Patient's Name </DESCRIPTION>
  <ANONYMITY_ACTION action="replace">anonymous</ANONYMITY_ACTION>
</INDIVIDUAL_ATTRIBUTE>
```

### 10.2.1.2 Making Undefined Standard Attributes Anonymous

This subsection shows how to use the action value `remove` to remove all undefined standard attributes from the resulting DICOM content. [Example 10-2](#) shows the XML statement where this action is defined.

#### Example 10-2 Removing All Undefined Standard Attributes

```
<UNDEFINED_STANDARD_ATTRIBUTES action="remove" />
```

### 10.2.1.3 Making Selected Private Attributes Anonymous

This subsection shows how to replace a single private attribute with specified values that make that attribute anonymous in the resulting DICOM content. [Example 10-3](#) shows a code segment for the private attribute `10871100(PRIVATE ORG)`. The XML statements where these actions are defined are highlighted in bold.

In [Example 10-3](#), the `<ATTRIBUTE_TAG>` value `10871100` with the definer name `PRIVATE ORG` must be defined in a private dictionary in the data model repository. The

value of the private attribute `10871100(PRIVATE ORG)` is replaced with the specified value in the resulting DICOM content.

The private attribute tag `10871100` is defined as follows in the private dictionary:

```
<PRIVATE_ATTRIBUTE_DEFINITION>
  <TAG>10871100</TAG>
  <NAME>Media Type</NAME>
  <DEFINER>PRIVATE ORG</DEFINER>
  <VR>CS</VR>
  <VM>1</VM>
</PRIVATE_ATTRIBUTE_DEFINITION>
```

This tag definition shown in the preceding code segment represents the private attribute `10871100(PRIVATE ORG)`, of data type `CS` and name `Media Type` as defined by the `<VR>` element. The data type `CS` is defined in the XML schema `ordcmrdt.xsd` as `xs:token` of length 16. The replacement value must be a string representation that conforms to the value defined by the `<VR>` element.

### Example 10-3 Making a Private Attribute Anonymous

```
<INDIVIDUAL_ATTRIBUTE>
  <ATTRIBUTE_TAG>10871100(PRIVATE ORG)</ATTRIBUTE_TAG>
  <DESCRIPTION>Media Type </DESCRIPTION>
  <ANONYMITY_ACTION action="replace"> replaced</ANONYMITY_ACTION>
</INDIVIDUAL_ATTRIBUTE>
```

## 10.2.1.4 Making All Private Attributes Anonymous

This subsection shows how to make several private attributes anonymous by removing or replacing those attributes with specified values that make them anonymous in the resulting DICOM content.

### Note:

Keep these guidelines in mind:

- The action value for a specified private attribute defined by the `<INDIVIDUAL_ATTRIBUTE>` element always overrides the global action defined by the `<PRIVATE_ATTRIBUTES>` element.
- The global action specified by the `<UNDEFINED_PRIVATE_ATTRIBUTES>` element overrides the global action defined by the `<PRIVATE_ATTRIBUTE>` element.

[Example 10-4](#) shows a code segment that uses the action value `remove` to remove all private attributes in the resulting DICOM content.

Similarly, [Example 10-5](#) shows a code segment that uses the action value `remove` to remove all undefined private attributes from the resulting DICOM content. And, this code segment uses the action value `replace` to replace the value of the tag for the defined private attribute `10871100(PRIVATE ORG)` with the string `"anonymous"` in the resulting DICOM content. The XML statements where these actions are defined are highlighted in bold.

**Example 10-6** shows a code segment that uses the action value `none` to include all defined private attributes in the resulting DICOM content. And, this code segment uses the action value `remove` to remove all undefined private attributes from the resulting DICOM content.

**Example 10-7** shows a code segment that uses the action value `remove` to remove all defined private attributes from the resulting DICOM content. And, this code segment uses the action value `none` to include all undefined private attributes in the resulting DICOM content.

#### Example 10-4 Removing All Private Attributes

```
<PRIVATE_ATTRIBUTES action="remove"></PRIVATE_ATTRIBUTES>
<UNDEFINED_PRIVATE_ATTRIBUTES action="remove" />
```

#### Example 10-5 Removing All Undefined Private Attributes

```
<PRIVATE_ATTRIBUTES action="remove"></PRIVATE_ATTRIBUTES>
<INDIVIDUAL_ATTRIBUTE>
  <ATTRIBUTE_TAG>10871100(PRIVATE ORG)</ATTRIBUTE_TAG>
  <DESCRIPTION>Media Type </DESCRIPTION>
  <ANONYMITY_ACTION action="replace"> anonymous</ANONYMITY_ACTION>
</INDIVIDUAL_ATTRIBUTE>
```

#### Example 10-6 Including Defined Private Attributes and Removing Undefined Private Attributes

```
<PRIVATE_ATTRIBUTES action="none"></PRIVATE_ATTRIBUTES>
<UNDEFINED_PRIVATE_ATTRIBUTES action="remove" />
```

#### Example 10-7 Removing Defined Private Attributes and Including Undefined Private Attributes

```
<PRIVATE_ATTRIBUTES action="remove"></PRIVATE_ATTRIBUTES>
<UNDEFINED_PRIVATE_ATTRIBUTES action="none" />
```

### 10.2.1.5 Using DICOM Value Locators in Anonymity Documents

This subsection shows how to use DICOM value locators to specify attributes in anonymity documents. **Example 10-8** shows how to specify the attribute `Person Name` with a DICOM value locator to make the attribute anonymous in the resulting DICOM content. This attribute is a child attribute of the attribute `Content Sequence` (data type `SQ`). The XML statement where this action is performed is highlighted in bold.

The standard attribute tags `0040A730` and `0040A123` are defined as follows in the standard dictionary:

```
<STANDARD_ATTRIBUTE_DEFINITION>
  <TAG>0040A730</TAG>
  <NAME>Content Sequence</NAME>
  <VR>SQ</VR>
  <VM>1</VM>
</STANDARD_ATTRIBUTE_DEFINITION>
<STANDARD_ATTRIBUTE_DEFINITION>
  <TAG>0040A123</TAG>
  <NAME>Person Name</NAME>
  <VR>PN</VR>
  <VM>1</VM>
</STANDARD_ATTRIBUTE_DEFINITION>
```

[Example 10-9](#) shows how to use a DICOM value locator with a wildcard character in an anonymity document to remove attributes with multiple values in the resulting DICOM content. The XML statement where the DICOM value locator is used is highlighted in bold.

The standard attribute tag **00081050** is defined as follows in the standard dictionary:

```
<STANDARD_ATTRIBUTE_DEFINITION>
  <TAG>00081050</TAG>
  <NAME>Performing Physician's Name</NAME>
  <VR>PN</VR>
  <VM>1-n</VM>
</STANDARD_ATTRIBUTE_DEFINITION>
```

In the tag definition shown in the preceding code segment, the <VM> element indicates that this attribute can contain multiple values. Using a wildcard character in the DICOM value locator ensures that all the values for this attribute are made anonymous.



#### Note:

DICOM value locators with the TAG\_FIELD component are not supported in anonymity documents.

See [General Format for DICOM Value Locators](#) for more information about the DICOM value locator type.

#### Example 10-8 Simple DICOM Value Locator in an Anonymity Document

```
<INDIVIDUAL_ATTRIBUTE>
  <ATTRIBUTE_TAG>0040A730[1].0040A123</ATTRIBUTE_TAG>
  <DESCRIPTION> Person Name </DESCRIPTION>
  <ANONYMITY_ACTION action="replace">anonymous</ANONYMITY_ACTION>
</INDIVIDUAL_ATTRIBUTE>
```

#### Example 10-9 DICOM Value Locator with a Wildcard Character in an Anonymity Document

```
<INDIVIDUAL_ATTRIBUTE>
  <ATTRIBUTE_TAG>00081050[*]</ATTRIBUTE_TAG>
  <DESCRIPTION> Performaing physician's name </DESCRIPTION>
  <ANONYMITY_ACTION action="remove"></ANONYMITY_ACTION>
</INDIVIDUAL_ATTRIBUTE>
```

## 10.2.2 Creating Constraint Documents

Constraint documents define one or more constraint rules. The XML schema `ordcmct.xsd` defines the XML schema that constrains constraint documents. (See [DICOM XML Schemas](#) for more information about this schema.)

The default constraint documents (`ordcmct.xml`, `ordcmcmd.xml`, `ordcmcmc.xml`), are XML representations of the rules to check the conformance of DICOM content, according to the DICOM standard and other organization-wide guidelines. (See [DICOM Configuration Documents](#) for more information about these configuration documents.)

At run time, users can invoke a PL/SQL or Java function to check the conformance of DICOM content according to one or more invocable constraint rules. Each invocable constraint rule is defined as a global rule (using the <GLOBAL\_RULE> element). Global rules are constraint rules that define requirements to be met by the DICOM content.

Constraint rules can comprise individual constraint predicates (using the <PREDICATE> element). A [constraint predicate](#) defines conditions on DICOM content. A predicate can be a logical statement, a relational statement that compares values, a function call evaluation that returns a Boolean type, or a reference to other predicate definitions. Predicate definitions are recursive. For example, when used as a logical statement, a predicate includes the logical OR of two other predicates. Each of the other predicates, in turn, can be a relational predicate.

Predicates operate on individual attributes or sets of attributes in the DICOM content. Within a predicate, attributes are specified with the <ATTRIBUTE\_TAG> element. Attributes are defined by the DICOM standard or by the private organizations or enterprises that create DICOM content. Attributes can be specified using simple DICOM value locators or more complex DICOM value locators, including those with macro substitution strings (see [General Format for DICOM Value Locators](#)).

Complex constraint rules can be defined more simply using constraint macros. Each [constraint macro](#) can be defined as a global macro (using the <GLOBAL\_MACRO> element). Constraint macros follow the same predicate definition grammar as constraint rules. They differ from constraint rules in that the predicate operands in constraint macros can contain macro parameters rather than the fixed values contained in constraint rules. The macro parameters in a constraint macro are replaced with parameter values when the macro is invoked (using the <INVOKE\_MACRO> element). Constraint macros can also be recursive. As an example, constraint macro A is recursive if it invokes itself or other constraint macros that invoke constraint macro A. Recursive constraint macros are useful when specifying validation requirements for hierarchical or recursive structured DICOM content, such as the content in a DICOM structured report.

Constraint definitions can be separated into multiple constraint document files, with each constraint file defining one or more constraint rules or constraint macros. Global rules and global macros can reference other internal and external global rules and global macros. Internal rules and internal macros are defined within the same constraint file. External rules and external macros are imported from other constraint document files that define those rules and macros. Before referencing a set of external constraint rules or external constraint macros in your constraint file, you must specify those rules or macros in your file (using the <EXTERNAL\_RULE\_INCLUDE> element or the <EXTERNAL\_MACRO\_INCLUDE> element, respectively). In addition, DICOM administrators must insert the *referenced* constraint document files into the repository before inserting the *referencing* constraint files.

In the XML constraint schema `ordcmct.xsd`, <ACTION> elements are defined to associate conformance validation messages with a predicate, a constraint rule, or a constraint macro. If predicates are evaluated to the conditions specified in the <ACTION> elements associated with the predicates, you can see these messages after conformance validation by querying the view `orddcm_conformance_vld_msgs`. (See [orddcm\\_conformance\\_vld\\_msgs](#) for reference information.)

The following subsections contain examples that show how to create a variety of constraint documents:

- [Defining a Simple Constraint Rule](#)



- [Defining Constraint Rules by Importing Other Constraint Rules](#)
- [Defining and Referencing Constraint Macros](#)
- [Defining Recursive Constraint Macros](#)
- [Using DICOM Value Locators in Constraint Documents](#)

**Note:**

These subsections contain references to tables in the DICOM standard. For more information about these tables, see the DICOM standard, which is available on the Web site for the National Electrical Manufacturers Association (NEMA) at

<http://medical.nema.org/>

### 10.2.2.1 Defining a Simple Constraint Rule

This subsection shows how to construct a simple constraint rule that checks two conditions required by the SOP Common Module, which is defined in the DICOM standard, in PS 3.3, Table C.12-1.

The following table shows the SOP Class UID and SOP Instance UID conditions as they are defined in the SOP Common Module of the DICOM standard.

Attribute Name	Tag	Type	Attribute Description
SOP Class UID	(0008,0016)	1	Uniquely identifies the SOP Class. See C.12.1.1.1 for further explanation. See also PS 3.4.
SOP Instance UID	(0008,0018)	1	Uniquely identifies the SOP Instance. See C.12.1.1.1 for further explanation. See also PS 3.4.

The two entries in the preceding table indicate that the attributes `SOP Class UID (0008,0016)` and `SOP Instance UID (0008,0018)` must exist and cannot be empty.

The code segment in [Example 10-10](#) shows a predicate that checks whether the attribute `SOP Class UID (0008,0016)` is not empty:

The code segment in [Example 10-11](#) shows a predicate that checks whether the attribute `SOP Instance UID (0008,0018)` is not empty:

Checking whether both of these attributes are not empty is equivalent to doing a logical AND operation for the two predicates shown in [Example 10-10](#) and [Example 10-11](#). The prescribed way to undertake this operation is to define another predicate that performs a logical AND operation on the preceding two predicates. [Example 10-12](#) shows a predicate with a logical AND operation for these two conditions:

A simpler way to define predicates having logical AND relations is by omitting the outer predicate that was shown in [Example 10-12](#). Thus, taking the complete constraint rule from the constraint document `ordcmcmd.xml`, the global rule `SOPCommonModule` can be defined as shown in [Example 10-13](#):

Each global rule must have a unique name. Furthermore, each global rule can include an optional <DESCRIPTION> element to provide descriptive information about that rule.

The code segment in [Example 10-13](#) shows how to define predicates that represent Boolean functions or logical relations. Predicates that represent relational relations can be defined similarly.

[Example 10-14](#) is a partial code segment that shows two sample predicates within a global rule. These predicates ensure that no error is raised when the DICOM content that is being validated does not contain attributes in the global rule. [Example 3-1](#) shows the complete code segment for this global rule (for the Patient Module).

The first predicate in [Example 10-14](#) tests the condition that the attribute `Patient's Sex (0010, 0040)` is not empty. This predicate ensures that all subsequent predicates that reference the attribute `Patient's Sex (0010, 0040)` are tested only when this predicate returns true during conformance validation. Thus, the second predicate is tested only when the DICOM content that is being validated contains the attribute `Patient's Sex (0010, 0040)` *and* the value is not empty. Therefore, no error is raised if the DICOM content does not contain the attribute `Patient's Sex (0010, 0040)`.

See [Defining Recursive Constraint Macros](#) for more examples of predicates that represent relational relations.

#### Example 10-10 Predicate for One Condition on SOP Class UID

```
<PREDICATE>
  <BOOLEAN_FUNC operator="notEmpty">
    <ATTRIBUTE_TAG>00080016</ATTRIBUTE_TAG>
  </BOOLEAN_FUNC>
</PREDICATE>
```

#### Example 10-11 Predicate for One Condition on SOP Instance UID

```
<PREDICATE>
  <BOOLEAN_FUNC operator="notEmpty">
    <ATTRIBUTE_TAG>00080018</ATTRIBUTE_TAG>
  </BOOLEAN_FUNC>
</PREDICATE>
```

#### Example 10-12 Predicate for Two Conditions

```
<PREDICATE>
  <LOGICAL operator="and">
    <PREDICATE>
      <BOOLEAN_FUNC operator="notEmpty">
        <ATTRIBUTE_TAG>00080016</ATTRIBUTE_TAG>
      </BOOLEAN_FUNC>
    </PREDICATE>
    <PREDICATE>
      <BOOLEAN_FUNC operator="notEmpty">
        <ATTRIBUTE_TAG>00080018</ATTRIBUTE_TAG>
      </BOOLEAN_FUNC>
    </PREDICATE>
  </LOGICAL>
</PREDICATE>
```

#### Example 10-13 Global Rule for Two Boolean Functions

```
<GLOBAL_RULE name="SOPCommonModule">
  <DESCRIPTION>
```

```

    A subset of SOP Common Module defined in DICOM standard
</DESCRIPTION>
<PREDICATE>
  <BOOLEAN_FUNC operator="notEmpty">
    <ATTRIBUTE_TAG>00080016</ATTRIBUTE_TAG>
  </BOOLEAN_FUNC>
</PREDICATE>
<PREDICATE>
  <BOOLEAN_FUNC operator="notEmpty">
    <ATTRIBUTE_TAG>00080018</ATTRIBUTE_TAG>
  </BOOLEAN_FUNC>
</PREDICATE>
</GLOBAL_RULE>

```

#### Example 10-14 Global Rule for Two Conditions on Patient's Sex

```

<GLOBAL_RULE name="PatientModule">
.
.
.
  <PREDICATE>
    <BOOLEAN_FUNC operator="notEmpty">
      <ATTRIBUTE_TAG>00100040</ATTRIBUTE_TAG>
    </BOOLEAN_FUNC>
  </PREDICATE>
  <PREDICATE>
    <DESCRIPTION>Patient's Sex</DESCRIPTION>
    <RELATIONAL operator="in">
      <ATTRIBUTE_TAG>00100040</ATTRIBUTE_TAG>
      <STRING_VALUE>M</STRING_VALUE>
      <STRING_VALUE>F</STRING_VALUE>
      <STRING_VALUE>O</STRING_VALUE>
    </RELATIONAL>
  </PREDICATE>
.
.
.
</GLOBAL_RULE>

```

### 10.2.2.2 Defining Constraint Rules by Importing Other Constraint Rules

This subsection shows how to construct constraint rules hierarchically by referencing other external constraint rules. This section also shows how to reference external constraint rules.

The constraint document `ordcmct.xml` defines the global rule `OracleOrdObject`. This constraint rule is defined as the logical AND relation of three constraint rules: `SOPCommonModule`, `GeneralSeriesModule`, and `GeneralStudyModule`. [Example 10-15](#) shows a global rule with a logical AND relation for these three constraint rules:

These three constraint rules are defined in the constraint document `ordcmcmd.xml` and imported into the DICOM constraint document `ordcmct.xml`. [Example 10-16](#) shows an external rule for these constraint rules:

Thus, the global rule `OracleOrdObject` references the global rule `SOPCommonModule` that is defined in [Defining a Simple Constraint Rule](#). Other constraint rules can also reference the global rule `SOPCommonModule`. In this way, constraint documents can be written in a modular and structured fashion.

**Example 10-15 Global Rule for a Logical Relation**

```

<GLOBAL_RULE name="OracleOrdObject">
  <PREDICATE>
    <GLOBAL_RULE_REF>SOPCommonModule</GLOBAL_RULE_REF>
  </PREDICATE>
  <PREDICATE>
    <GLOBAL_RULE_REF>GeneralSeriesModule</GLOBAL_RULE_REF>
  </PREDICATE>
  <PREDICATE>
    <GLOBAL_RULE_REF>GeneralStudyModule</GLOBAL_RULE_REF>
  </PREDICATE>
</GLOBAL_RULE>

```

**Example 10-16 External Rule for Three Constraint Rules**

```

<EXTERNAL_RULE_INCLUDE name="GeneralStudyModule">
  A subset of General Study Module defined in DICOM standard
</EXTERNAL_RULE_INCLUDE>
<EXTERNAL_RULE_INCLUDE name="GeneralSeriesModule">
  A subset of General Series Module defined in DICOM standard
</EXTERNAL_RULE_INCLUDE>
<EXTERNAL_RULE_INCLUDE name="SOPCommonModule">
  A subset of SOP Common Module defined in DICOM standard
</EXTERNAL_RULE_INCLUDE>

```

### 10.2.2.3 Defining and Referencing Constraint Macros

This subsection shows how to construct a constraint macro that checks whether a DICOM attribute is a code sequence attribute. The constraint macro performs this checking operation by following the first two conditions required by the Code Sequence Macro, which is defined in the DICOM standard, in PS 3.3, Table 8.8-1.

The following table shows the Code Value and Coding Scheme Designator conditions as they are defined in the Code Sequence Macro of the DICOM standard.

Attribute Name	Tag	Type	Attribute Description
Code Value	(0008,0100)	1C	See Section 8.1. Required if a sequence item is present.
Coding Scheme Designator	(0008,0102)	1C	See Section 8.2. Required if a sequence item is present.

The two entries in the preceding table indicate that the mandatory child attributes `Code Value (0008,0100)` and `Coding Scheme Designator (0008,0102)` must not be empty.

[Example 10-17](#) shows a global macro definition (from the default constraint document `ordcmcmc.xml`) that checks whether the attributes `Code Value (0008,0100)` and `Coding Scheme Designator (0008,0102)` are not empty:

Predicates that are included in constraint macros include operands that contain parameters. These parameters must be defined in `<PARAMETER_DECLARATION>` elements. When the parameters are referenced in these operands, the parameters must be preceded by the dollar sign symbol and enclosed within braces as in: `#{ }`. In the preceding code segment, the parameter `CodeAttr` represents the code sequence to be examined. Thus, checking whether the code value of the parameter `CodeAttr` is not empty is equivalent to checking whether the parameter `#{CodeAttr}.00080100` is not empty.

Constraint macros can be invoked by one or more constraint rules, with the macro parameters being set to different values. To invoke a constraint macro, you must specify the name of the macro with the name value pairs of all parameters for that macro.

**Example 10-18** shows the definition for the global rule `GeneralSeriesModule` (from the default constraint document `ordcmcmd.xml`), which invokes the constraint macro `CodeSequenceMacro`. The code statements where this macro is invoked are highlighted in bold.

Because the constraint macro `CodeSequenceMacro` is defined in a different constraint file, it is imported in the beginning of the constraint document `ordcmcmd.xml`, as follows:

```
<EXTERNAL_MACRO_INCLUDE name="CodeSequenceMacro">
Defines a code sequence macro</EXTERNAL_MACRO_INCLUDE>
```

When users check whether the DICOM content conforms to the constraint rule `GeneralSeriesModule`, the DICOM content is checked against the constraint macro `CodeSequenceMacro`, where the parameter `CodeAttr` is substituted as `00400260`. Specifically, the predicate to check the `<ATTRIBUTE_TAG>` element `${CodeAttr}`. `00080100 not empty` becomes `00400260.00080100 not empty`. And, the `<ATTRIBUTE_TAG>` element `${CodeAttr}.00080102 not empty` becomes `00400260.00080102 not empty`.

If the constraint macro `CodeSequenceMacro` with the parameter `CodeAttr` substituted as `00400260` evaluates to `false` on the DICOM content, the view `orddcm_conformance_vld_msgs` contains the message "missing attribute 00400260.00080100 or 00400260.00080102" for the DICOM content. These conformance validation messages can be used to provide information about specific attributes in the DICOM content that do not conform to the constraint rules.

See the `orddcm_conformance_vld_msgs` view for more information about these messages.

### Example 10-17 Global Macro for a Condition

```
<GLOBAL_MACRO name="CodeSequenceMacro">
  <DESCRIPTION>
    A subset of Code Sequence Macro defined in DICOM standard
  </DESCRIPTION>
  <PARAMETER_DECLARATION>CodeAttr</PARAMETER_DECLARATION>
  <PREDICATE>
    <DESCRIPTION>Code value must not be empty</DESCRIPTION>
    <BOOLEAN_FUNC operator="notEmpty">
      <ATTRIBUTE_TAG>${CodeAttr}.00080100</ATTRIBUTE_TAG>
    </BOOLEAN_FUNC>
  </PREDICATE>
  <PREDICATE>
    <DESCRIPTION>Coding scheme designator must not be empty</DESCRIPTION>
    <BOOLEAN_FUNC operator="notEmpty">
      <ATTRIBUTE_TAG>${CodeAttr}.00080102</ATTRIBUTE_TAG>
    </BOOLEAN_FUNC>
  </PREDICATE>
</GLOBAL_MACRO>
```

### Example 10-18 Global Rule with a Constraint Macro

```
<GLOBAL_RULE name="GeneralSeriesModule">
  <DESCRIPTION>
    A subset of General Series Module defined in DICOM standard
```

```

</DESCRIPTION>
<PREDICATE>
  <BOOLEAN_FUNC operator="notEmpty">
    <ATTRIBUTE_TAG>00080060</ATTRIBUTE_TAG>
  </BOOLEAN_FUNC>
  <ACTION action="warning" when="false">
    missing attribute 00080060
  </ACTION>
</PREDICATE>
<PREDICATE>
  <BOOLEAN_FUNC operator="notEmpty">
    <ATTRIBUTE_TAG>0020000E</ATTRIBUTE_TAG>
  </BOOLEAN_FUNC>
  <ACTION action="warning" when="false">
    missing attribute 0020000E
  </ACTION>
</PREDICATE>
<PREDICATE>
  <LOGICAL operator="derive">
    <PREDICATE>
      <BOOLEAN_FUNC operator="notEmpty">
        <ATTRIBUTE_TAG>00400260</ATTRIBUTE_TAG>
      </BOOLEAN_FUNC>
    </PREDICATE>
    <PREDICATE>
      <INVOKE_MACRO>
        <MACRO_NAME>CodeSequenceMacro</MACRO_NAME>
        <PARAMETER>
          <NAME>CodeAttr</NAME>
          <VALUE>00400260</VALUE>
        </PARAMETER>
      </INVOKE_MACRO>
      <ACTION action="warning" when="false">
        missing attribute 00400260.00080100 or 00400260.00080102
      </ACTION>
    </PREDICATE>
  </LOGICAL>
</PREDICATE>
<ACTION action="warning" when="false">
  GeneralSeriesModule is not satisfied
</ACTION>
</GLOBAL_RULE>

```

### 10.2.2.4 Defining Recursive Constraint Macros

This subsection shows two examples that check a subset of attributes required by the SR Document Content Module, which is defined in the DICOM standard, in PS 3.3, Section C.17.3.

The following table shows the Content Sequence and Relationship Type attributes as they are defined in the Document Relationship Macro Attributes in Table C.17-6. The table also shows the Value Type attribute as it is defined in the Document Content Macro Attributes in Table C.17-5.

Attribute Name	Tag	Type	Attribute Description
Content Sequence	(0040,A730)	1C	<p>A potentially recursively nested Sequence of items that conveys content that is the Target of Relationships with the enclosing Source Content Item.</p> <p>One or more Items may be included in this sequence.</p> <p>Required if the enclosing Content Item has relationships.</p> <p>Notes:</p> <ol style="list-style-type: none"> <li>1. If this Attribute is not present then the enclosing Item is a leaf.</li> <li>2. The order of Items within this Sequence is semantically significant for presentation.</li> </ol> <p>See C.17.3.2.4 for further explanation.</p>
Relationship Type	(0040,A010)	1	<p>The type of relationship between the (enclosing) Source Content Item and the Target Content Item.</p> <p>IODs specify additional constraints on Relationships (including lists of Enumerated Values).</p> <p>Defined Terms:</p> <p>CONTAINS HAS PROPERTIES HAS OBS CONTEXT HAS ACQ CONTEXT INFERRED FROM SELECTED FROM HAS CONCEPT MOD</p> <p>See C.17.3.2.4 for further explanation.</p>

Attribute Name	Tag	Type	Attribute Description
Value Type	(0040,A040)	1	<p>The type of the value encoded in this Content Item.</p> <p>Defined Terms:</p> <p>TEXT</p> <p>NUM</p> <p>CODE</p> <p>DATETIME</p> <p>DATE</p> <p>TIME</p> <p>UIDREF</p> <p>PNAME</p> <p>COMPOSITE</p> <p>IMAGE</p> <p>WAVEFORM</p> <p>SCOORD</p> <p>TCOORD</p> <p>CONTAINER</p> <p>See C.17.3.2.1 for further explanation.</p>

For example, the attribute `Content Sequence (0040,A730)` provides the hierarchical structuring of the Content Tree (DICOM standard, PS 3.3, Section C.17.3.1) by recursively nesting Content Items. A parent (or source) Content Item has an explicit relationship to each child (or target) Content Item, which is conveyed by the attribute `Relationship Type (0040,A010)` (DICOM standard, PS 3.3, Section C.17.3.2.4).

To avoid infinite loops and control how many levels of the hierarchy structure to evaluate, use the preference parameter `MAX_RECURSION_DEPTH` in the preference document to specify the number of levels of recursion for a constraint macro. See [Defining the MAX\\_RECURSION\\_DEPTH Preference Parameter](#) for information about defining this preference parameter in a preference document.

The code segment in [Example 10-19](#) is an example of recursion with a single constraint macro that invokes itself. The code segment in [Example 10-20](#) is an example of recursion between two different constraint macros, with the first macro invoking a second macro, which then invokes the first macro.

 **Note:**

The examples in this section are not shipped with the installation software.

### Recursion with a Single Constraint Macro

[Example 10-19](#) defines the recursive global constraint macro `DocumentContentMacro`. This macro is invoked by the global constraint rule `DocumentContentModule`. The code statements where this macro is defined and invoked are highlighted in bold.

During conformance validation, the ``${RUNTIME_TAG}` tags in `<ACTION>` elements are replaced by the DICOM value locators whose corresponding attributes in the DICOM content are evaluated to meet the condition specified by the `when` attribute of the



<ACTION> element. The first action creates a message that contains a list of DICOM value locators, all ending with tag 0040A040, whose corresponding attributes in the DICOM content are not empty. The second action creates a message that contains a list of DICOM value locators, all ending with tag 0040A040, whose corresponding attributes in the DICOM content do not match CONTAINER.

In [Example 10-19](#), the recursion occurs when the recursive constraint macro invokes itself by specifying the name value pair of the parameter defined for that macro.

In the definition of the macro `DocumentContentMacro`, the first predicate checks whether the attribute `#{tag}.0040A010` is not empty. The second predicate uses a relational operation to check whether this attribute has a valid value. The third predicate checks whether the attribute `#{tag}.0040A040` is not empty. The fourth predicate checks whether the value of `#{tag}.0040A040` is CONTAINER. If so, then the macro `DocumentContentMacro` is invoked on the content sequence of `#{tag}.0040A730[*]`. The code `[*]` is a wildcard character that represents the numbered series of attributes in the constraint document to be checked by the macro.

### Recursion with Two Constraint Macros

[Example 10-20](#) defines two recursive global constraint macros: `DocumentContentMacroA` and `DocumentContentMacroB`. The code statements where these macros are defined and invoked are highlighted in bold.

In [Example 10-20](#), the recursion occurs when `DocumentContentMacroB` invokes `DocumentContentMacroA`, and then `DocumentContentMacroA` invokes `DocumentContentMacroB`.

### Example 10-19 One Constraint Macro with Recursion

```
<GLOBAL_MACRO name="DocumentContentMacro">
  <PARAMETER_DECLARATION>tag</PARAMETER_DECLARATION>
  <PREDICATE>
    <BOOLEAN_FUNC operator="notEmpty">
      <ATTRIBUTE_TAG>#{tag}.0040A010</ATTRIBUTE_TAG>
    </BOOLEAN_FUNC>
  </PREDICATE>
  <PREDICATE>
    <RELATIONAL operator="in">
      <ATTRIBUTE_TAG>#{tag}.0040A010</ATTRIBUTE_TAG>
      <STRING_VALUE>CONTAINS</STRING_VALUE>
      <STRING_VALUE>HAS PROPERTIES</STRING_VALUE>
      <STRING_VALUE>HAS OBS CONTEXT</STRING_VALUE>
      <STRING_VALUE>HAS ACQ CONTEXT</STRING_VALUE>
      <STRING_VALUE>INFERRED FROM</STRING_VALUE>
      <STRING_VALUE>SELECTED FROM</STRING_VALUE>
      <STRING_VALUE>HAS CONCEPT MOD</STRING_VALUE>
    </RELATIONAL>
  </PREDICATE>
  <PREDICATE>
    <BOOLEAN_FUNC operator="notEmpty">
      <ATTRIBUTE_TAG>#{tag}.0040A040</ATTRIBUTE_TAG>
    </BOOLEAN_FUNC>
    <ACTION action="log" when="true">#{RUNTIME_TAG} is not empty</ACTION>
  </PREDICATE>
  <PREDICATE>
    <LOGICAL operator="derive">
      <PREDICATE>
        <RELATIONAL operator="eq">
          <ATTRIBUTE_TAG>#{tag}.0040A040</ATTRIBUTE_TAG>
          <STRING_VALUE>CONTAINER</STRING_VALUE>
        </RELATIONAL>
      </PREDICATE>
    </LOGICAL>
  </PREDICATE>
</GLOBAL_MACRO>
```

```

    </RELATIONAL>
    <ACTION action="log" when="false">${RUNTIME_TAG} value is not
        CONTAINER</ACTION>
</PREDICATE>
<PREDICATE>
    <INVOKE_MACRO>
        <MACRO_NAME>DocumentContentMacro</MACRO_NAME>
        <PARAMETER>
            <NAME>tag</NAME>
            <VALUE>${tag}.0040A730[*]</VALUE>
        </PARAMETER>
    </INVOKE_MACRO>
</PREDICATE>
</LOGICAL>
</PREDICATE>
</GLOBAL_MACRO>
<GLOBAL_RULE name="DocumentContentModule">
    <PREDICATE>
        <INVOKE_MACRO>
            <MACRO_NAME>DocumentContentMacro</MACRO_NAME>
            <PARAMETER>
                <NAME>tag</NAME>
                <VALUE>0040A730[*]</VALUE>
            </PARAMETER>
        </INVOKE_MACRO>
    </PREDICATE>
</GLOBAL_RULE>

```

### Example 10-20 Two Constraint Macros with Recursion

```

<GLOBAL_MACRO name="DocumentContentMacroA">
    <PARAMETER_DECLARATION>attr</PARAMETER_DECLARATION>
    <PREDICATE>
        <BOOLEAN_FUNC operator="notEmpty">
            <ATTRIBUTE_TAG>${attr}.0040A040</ATTRIBUTE_TAG>
        </BOOLEAN_FUNC>
    </PREDICATE>
    <PREDICATE>
        <LOGICAL operator="derive">
            <PREDICATE>
                <RELATIONAL operator="eq">
                    <ATTRIBUTE_TAG>${attr}.0040A040</ATTRIBUTE_TAG>
                    <STRING_VALUE>CONTAINER</STRING_VALUE>
                </RELATIONAL>
            </PREDICATE>
            <PREDICATE>
                <INVOKE_MACRO>
                    <MACRO_NAME>DocumentContentMacroB</MACRO_NAME>
                    <PARAMETER>
                        <NAME>tag</NAME>
                        <VALUE>${attr}.0040A730[*]</VALUE>
                    </PARAMETER>
                </INVOKE_MACRO>
            </PREDICATE>
        </LOGICAL>
    </PREDICATE>
</GLOBAL_MACRO>

<GLOBAL_MACRO name="DocumentContentMacroB">
    <PARAMETER_DECLARATION>tag</PARAMETER_DECLARATION>
    <PREDICATE>

```

```

<BOOLEAN_FUNC operator="notEmpty">
  <ATTRIBUTE_TAG>${tag}.0040A010</ATTRIBUTE_TAG>
</BOOLEAN_FUNC>
</PREDICATE>
<PREDICATE>
  <RELATIONAL operator="in">
    <ATTRIBUTE_TAG>${tag}.0040A010</ATTRIBUTE_TAG>
    <STRING_VALUE>CONTAINS</STRING_VALUE>
    <STRING_VALUE>HAS PROPERTIES</STRING_VALUE>
    <STRING_VALUE>HAS OBS CONTEXT</STRING_VALUE>
    <STRING_VALUE>HAS ACQ CONTEXT</STRING_VALUE>
    <STRING_VALUE>INFERRED FROM</STRING_VALUE>
    <STRING_VALUE>SELECTED FROM</STRING_VALUE>
    <STRING_VALUE>HAS CONCEPT MOD</STRING_VALUE>
  </RELATIONAL>
</PREDICATE>
<PREDICATE>
  <INVOKE_MACRO>
    <MACRO_NAME>DocumentContentMacroA</MACRO_NAME>
    <PARAMETER>
      <NAME>attr</NAME>
      <VALUE>${tag}</VALUE>
    </PARAMETER>
  </INVOKE_MACRO>
</PREDICATE>
</GLOBAL_MACRO>

```

### 10.2.2.5 Using DICOM Value Locators in Constraint Documents

This subsection shows how to use DICOM value locators to specify attributes in constraint documents. DICOM value locators can be used to specify predicates that include private attributes and their definers. DICOM value locators can contain macros for substitution when the constraint document is loaded into the repository.

The following list shows a few examples of valid macro substitution strings:

- A complete series of sublocators
- A tag, including the special wildcard tag ". "
- A definer name (DICOM, the default name, or the name of a private definer)
- An item number (a positive integer or the wildcard character '\*')

See [General Format for DICOM Value Locators](#) for complete reference information.

**Example 10-21** shows how to specify the attribute `Content Sequence` with a DICOM value locator in a global constraint macro and create a log of the results at run time. (This example uses some code from [Example 10-19](#).) The DICOM value locators are highlighted in bold.

The standard attribute tags `0040A010`, `0040A040`, and `0040A730` are defined as follows in the standard dictionary:

```

<STANDARD_ATTRIBUTE_DEFINITION>
  <TAG>0040A010</TAG>
  <NAME>Relationship Type</NAME>
  <VR>CS</VR>
  <VM>1</VM>
</STANDARD_ATTRIBUTE_DEFINITION>
<STANDARD_ATTRIBUTE_DEFINITION>
  <TAG>0040A040</TAG>

```

```

<NAME>Value Type</NAME>
<VR>CS</VR>
<VM>1</VM>
</STANDARD_ATTRIBUTE_DEFINITION>
<STANDARD_ATTRIBUTE_DEFINITION>
  <TAG>0040A730</TAG>
  <NAME>Content Sequence</NAME>
  <VR>SQ</VR>
  <VM>1</VM>
</STANDARD_ATTRIBUTE_DEFINITION>

```

In the tag definition shown in the preceding code segment, the <VR> element of tag 0040A730 indicates that this tag is a sequence tag and the corresponding attribute in the DICOM content can contain multiple sequence items. Using a wildcard character in the DICOM value locator ensures that all the items for this attribute are checked.

[Example 10-22](#) shows how to specify all the `Relationship Type` attributes with a DICOM value locator in a global rule. The DICOM value locator is highlighted in bold.

In [Example 10-22](#), the DICOM value locator for all 0040A010 attributes includes the special wildcard tag "." to indicate that the predicate performs a relational operation to check all the Relational Type attributes in the DICOM content.

#### Note:

The following restrictions apply to the use of the special wildcard tag "." in a DICOM value locator:

- It can be used by one predicate operand only.
- It cannot be used within a recursive constraint macro, or to call a recursive constraint macro.

See [General Format for DICOM Value Locators](#) for more information about the DICOM value locator type.

#### Example 10-21 DICOM Value Locator with a Wildcard Character in a Constraint Macro

```

<GLOBAL_MACRO name="DocumentContentMacro">
  <PARAMETER_DECLARATION>tag</PARAMETER_DECLARATION>
  <PREDICATE>
    <BOOLEAN_FUNC operator="notEmpty">
      <ATTRIBUTE_TAG>${tag}.0040A010</ATTRIBUTE_TAG>
    </BOOLEAN_FUNC>
  </PREDICATE>
  <PREDICATE>
    <RELATIONAL operator="in">
      <ATTRIBUTE_TAG>${tag}.0040A010</ATTRIBUTE_TAG>
      <STRING_VALUE>CONTAINS</STRING_VALUE>
      <STRING_VALUE>HAS PROPERTIES</STRING_VALUE>
      <STRING_VALUE>HAS OBS CONTEXT</STRING_VALUE>
      <STRING_VALUE>HAS ACQ CONTEXT</STRING_VALUE>
      <STRING_VALUE>INFERRED FROM</STRING_VALUE>
      <STRING_VALUE>SELECTED FROM</STRING_VALUE>
      <STRING_VALUE>HAS CONCEPT MOD</STRING_VALUE>
    </RELATIONAL>
  </PREDICATE>

```

```

<PREDICATE>
  <BOOLEAN_FUNC operator="notEmpty">
    <ATTRIBUTE_TAG>${tag}.0040A040</ATTRIBUTE_TAG>
  </BOOLEAN_FUNC>
  <ACTION action="log" when="true">${RUNTIME_TAG} is not empty</ACTION>
</PREDICATE>
<PREDICATE>
  <LOGICAL operator="derive">
    <PREDICATE>
      <RELATIONAL operator="eq">
        <ATTRIBUTE_TAG>${tag}.0040A040</ATTRIBUTE_TAG>
        <STRING_VALUE>CONTAINER</STRING_VALUE>
      </RELATIONAL>
      <ACTION action="log" when="false">${RUNTIME_TAG} value is not
        CONTAINER</ACTION>
    </PREDICATE>
  </LOGICAL>
  <PREDICATE>
    <INVOKE_MACRO>
      <MACRO_NAME>DocumentContentMacro</MACRO_NAME>
      <PARAMETER>
        <NAME>tag</NAME>
        <VALUE>${tag}.0040A730[*]</VALUE>
      </PARAMETER>
    </INVOKE_MACRO>
  </PREDICATE>
</PREDICATE>
</GLOBAL_MACRO>
<GLOBAL_RULE name="DocumentContentModule">
  <PREDICATE>
    <INVOKE_MACRO>
      <MACRO_NAME>DocumentContentMacro</MACRO_NAME>
      <PARAMETER>
        <NAME>tag</NAME>
        <VALUE>0040A730[*]</VALUE>
      </PARAMETER>
    </INVOKE_MACRO>
  </PREDICATE>
</GLOBAL_RULE>

```

### Example 10-22 DICOM Value Locator with a Special Wildcard Tag in a Global Rule

```

<GLOBAL_RULE name="MagicTagTest">
  <PREDICATE>
    <RELATIONAL operator="in">
      <ATTRIBUTE_TAG>.0040A010</ATTRIBUTE_TAG>
      <STRING_VALUE>CONTAINS</STRING_VALUE>
      <STRING_VALUE>HAS PROPERTIES</STRING_VALUE>
      <STRING_VALUE>HAS OBS CONTEXT</STRING_VALUE>
      <STRING_VALUE>HAS ACQ CONTEXT</STRING_VALUE>
      <STRING_VALUE>INFERRED FROM</STRING_VALUE>
      <STRING_VALUE>HAS CONCEPT MOD</STRING_VALUE>
    </RELATIONAL>
    <ACTION action="log" when="false">${RUNTIME_TAG} does not contain required
      values</ACTION>
  </PREDICATE>
</GLOBAL_RULE>

```

## 10.2.3 Creating DICOM Protocol Documents

DICOM protocol documents define the behavior of a DICOM protocol adapter instance configured to use Oracle Database as the backing storage mechanism for DICOM images and metadata. DICOM protocol XML configuration documents (such as `ordcmdp.xml`) must adhere to the `ordcmdp.xsd` schema. (See [DICOM XML Schemas](#) for more information about this schema.) This document has one element, the storage configuration element (the `<storage>` tag), which can be repeated. This element enables you to specify a table in Oracle Database to use for DICOM image and metadata storage.

The following table describes the XML attributes that the `<storage>` tag supports:

Attribute	Description
<code>table</code>	Required. Specifies the schema-qualified name of the table where DICOM images and metadata are to be stored.
<code>id_col</code>	Required. Identifies the column in the storage table (specified by the <code>table</code> attribute) where the SOP instance UID (0008,0018) of the DICOM image is stored. This UID serves to uniquely identify the image (and the corresponding metadata for the image).

Within the `<storage>` tag, you can add subelements that specify which column (the enclosing table for the column is identified in the `table` attribute of the enclosing `<storage>` tag) to use for storing DICOM images, metadata, and derived data (such as preview images). These optional tags are supported:

Tag	Description
<code>&lt;dicom&gt;</code>	Specifies where to store the original DICOM image (either as a SecureFiles BLOB or an ORDDicom object). The <code>column</code> attribute of this tag specifies the name of the column to use for storing the image. The <code>type</code> attribute (optional) of this tag specifies the type of DICOM storage: BLOB or ORDDicom.
<code>&lt;metadata&gt;</code>	Specifies where to store the XML representation of the DICOM image metadata (as XMLType). The <code>column</code> attribute of this tag specifies the name of the column to use for storing the XML metadata.
<code>&lt;preview&gt;</code>	Specifies where to store a preview version (as JPEG, TIF, and so on.) of the DICOM image. The <code>column</code> attribute of this tag specifies the name of the column to use for storing the DICOM image preview. The <code>options</code> attribute specifies the image transformation to use when generating the preview image. This includes (but is not limited to) the following parameters: <code>file format</code> , <code>size</code> , and <code>rotation</code> (see <i>Oracle Multimedia Reference</i> for a complete set of configuration options). The <code>type</code> attribute (optional) of this tag specifies the type of image storage: either as BLOB or ORDImage.
<code>&lt;attribute&gt;</code>	Specifies where to store the attribute value extracted from the DICOM image corresponding to the given DICOM tag. The <code>column</code> attribute of this tag specifies the name of the column to use for storing the metadata value. The <code>tag</code> attribute specifies which DICOM tag to use. The <code>type</code> attribute (optional) of this tag specifies the type of attribute storage (for ex. the type of the underlying column - <code>varchar2</code> , <code>number</code> , and so on).

[Example 10-23](#) shows an example of a DICOM protocol configuration document:

In [Example 10-23](#), DICOM images are stored in the column `dicomobj` of table `dcm_user.dcm_table` as type `ORDDicom`. DICOM attributes are stored in columns of the table `dcm_user.attr_table` according to their tag numbers. Previews of DICOM images are stored in columns of the table `dcm_user.img_table` according to different processing options. (See [DICOM Processing and Supported Formats](#) for details about processing options.) These tables must be created in the database before you can use the configuration document.

 **Note:**

To use the configuration document, you must deploy an instance of the DICOM protocol adapter that references the specified document.

You can also configure the storing of DICOM images in columns of type `BLOB` and specify a separate column for storing metadata such as in this code segment:

```
<STORAGE table='dcm_user.dcm_table' id_col="dicomID">
  <DICOM column="dicomblob" type="BLOB"/>
</STORAGE>
<STORAGE table='dcm_user.meta_table' id_col="metaID">
  <METADATA column="meta"/>
</STORAGE>
```

See [DICOM Protocol Support](#) for more information about DICOM protocol support for Oracle Database.

### Example 10-23 Sample DICOM Protocol Configuration Document

```
<DICOM_PROTOCOL xmlns="http://xmlns.oracle.com/ord/dicom/protocol_1_0"
xmlns:dt="http://xmlns.oracle.com/ord/dicom/datatype_1_0"
xmlns:xsi="http://www.w3.org/2001/XMLSchema-instance"
xsi:schemaLocation="http://xmlns.oracle.com/ord/dicom/protocol_1_0
http://xmlns.oracle.com/ord/dicom/protocol_1_0">
  <DOCUMENT_HEADER>
    <dt:DOCUMENT_CHANGE_LOG>
      <dt:DOCUMENT_MODIFIER>Anonymous user</dt:DOCUMENT_MODIFIER>
      <dt:DOCUMENT_MODIFICATION_DATE>2011-09-08</dt:DOCUMENT_MODIFICATION_DATE>
      <dt:DOCUMENT_VERSION>1.0</dt:DOCUMENT_VERSION>
      <dt:MODIFICATION_COMMENT>DICOM protocol doc for
orddicom</dt:MODIFICATION_COMMENT>
    </dt:DOCUMENT_CHANGE_LOG>
  </DOCUMENT_HEADER>
  <STORAGE table='dcm_user.dcm_table' id_col="dicomID">
    <DICOM column="dicomobj" type="ORDDicom"/>
  </STORAGE>
  <STORAGE table='dcm_user.attr_table' id_col="attrID">
    <ATTRIBUTE column="DICOM_00020002" tag="00020002"/>
    <ATTRIBUTE column="DICOM_00020003" tag="00020003"/>
    <ATTRIBUTE column="DICOM_00020010" tag="00020010"/>
    <ATTRIBUTE column="DICOM_00080016" tag="00080016"/>
    <ATTRIBUTE column="DICOM_00080018" tag="00080018"/>
    <ATTRIBUTE column="DICOM_00080020" tag="00080020"/>
    <ATTRIBUTE column="DICOM_00080030" tag="00080030"/>
    <ATTRIBUTE column="DICOM_00080050" tag="00080050"/>
    <ATTRIBUTE column="DICOM_00080056" tag="00080056"/>
    <ATTRIBUTE column="DICOM_00080060" tag="00080060"/>
    <ATTRIBUTE column="DICOM_00080061" tag="00080061"/>
    <ATTRIBUTE column="DICOM_00080064" tag="00080064"/>
    <ATTRIBUTE column="DICOM_00080068" tag="00080068"/>
```

```

<ATTRIBUTE column="DICOM_00080070" tag="00080070"/>
<ATTRIBUTE column="DICOM_00080080" tag="00080080"/>
<ATTRIBUTE column="DICOM_00080081" tag="00080081"/>
<ATTRIBUTE column="DICOM_00080090" tag="00080090"/>
<ATTRIBUTE column="DICOM_00080096" tag="00080096"/>
<ATTRIBUTE column="DICOM_00081030" tag="00081030"/>
<ATTRIBUTE column="DICOM_00081050" tag="00081050"/>
<ATTRIBUTE column="DICOM_00100010" tag="00100010"/>
<ATTRIBUTE column="DICOM_00100020" tag="00100020"/>
<ATTRIBUTE column="DICOM_00100030" tag="00100030"/>
<ATTRIBUTE column="DICOM_00100040" tag="00100040"/>
<ATTRIBUTE column="DICOM_0020000D" tag="0020000D"/>
<ATTRIBUTE column="DICOM_0020000E" tag="0020000E"/>
<ATTRIBUTE column="DICOM_00200010" tag="00200010"/>
<ATTRIBUTE column="DICOM_00200011" tag="00200011"/>
<ATTRIBUTE column="DICOM_00200012" tag="00200012"/>
<ATTRIBUTE column="DICOM_00200013" tag="00200013"/>
</STORAGE>
<STORAGE table='dcm_user.img_table' id_col="imageID">
  <PREVIEW column="imageobj" options="fileformat=jpeg scale=0.5"/>
  <PREVIEW column="imageblob" options="fileformat=jpeg"/>
</STORAGE>
</DICOM_PROTOCOL>

```

## 10.2.4 Creating Mapping Documents and Metadata XML Schemas

Mapping documents define how the DICOM attributes are mapped into an XML document. The metadata XML document can be constrained by an XML schema, or it can be a well-formed XML document with no XML schema constraints.

The XML schema `ordcmmmp.xsd` defines the XML schema that constrains mapping documents. (See [DICOM XML Schemas](#) for more information about this schema.)

The following subsections describe the structure of mapping documents and metadata XML schemas. The subsections also contain code examples that show how to create mapping documents and corresponding metadata schemas:

- [Structure of a Mapping Document](#)
- [Structure of a Metadata XML Schema](#)
- [Creating a Mapping Document for Metadata with No Schema Constraints](#)
- [Creating a Mapping Document for Metadata with Schema Constraints and a Mapped Section Only](#)
- [Creating a Mapping Document for Metadata with Schema Constraints](#)
- [Using DICOM Value Locators in Mapping Documents](#)

### 10.2.4.1 Structure of a Mapping Document

Each mapping document must include a root element and a namespace declaration, similar to the following:

```

<XML_MAPPING_DOCUMENT xmlns="http://xmlns.oracle.com/ord/dicom/mapping_1_0"
xmlns:xsi="http://www.w3.org/2001/XMLSchema-instance"
xsi:schemaLocation="http://xmlns.oracle.com/ord/dicom/mapping_1_0
http://xmlns.oracle.com/ord/dicom/mapping_1_0">

```

The remaining elements in the mapping document, in order of appearance, are as follows:



- `<dt:DOCUMENT_HEADER>`: This element is optional. It is used to keep the update record of the XML document. If this element is specified, add the following namespace declaration to the root element:

```
namespace: xmlns:dt=http://xmlns.oracle.com/ord/dicom/datatype_1_0"
```

- `<NAMESPACE>`: This mandatory element specifies the namespace of the metadata XML document. This namespace must match the target namespace of the corresponding metadata schema. If this element is empty, the extracted metadata XML is not schema constrained.
- `<ROOT_ELEM_TAG>`: This mandatory element specifies the root element name of the metadata XML document.
- `<UNMAPPED_ELEM>`: This element specifies the XML path to the element that is the parent element of all unmapped attributes. This XML path is relative to the root element (specified by the element `<ROOT_ELEM_TAG>`) of the metadata XML. If this element is omitted or empty, the parent element of the unmapped attributes is the root element of the metadata XML document. See [Extraction of Metadata from DICOM Content](#) for more information about unmapped attributes.
- `<MAPPED_ELEM>`: This element specifies the XML path to the element that is the parent element of all mapped attributes. This XML path is relative to the root element of the metadata XML (specified by the element `<ROOT_ELEM_TAG>`). If this element is omitted or empty, the parent element of the mapped attributes is the root element of the metadata XML document. See [Extraction of Metadata from DICOM Content](#) for more information about mapped attributes.
- `<MAPPED_PATH>`: This element specifies the XML path to a mapped attribute. This XML path is relative to the parent element of the mapped attributes as defined by the element `<MAPPED_ELEM>`. This element can be used multiple times within a mapping document to specify the XML paths to all mapped attributes. The order of appearance of each `<MAPPED_PATH>` element reflects the order of appearance of the mapped attributes in a metadata XML document. Within the `<MAPPED_PATH>` element, the `<ATTRIBUTE_TAG>` and `<PATH>` elements are used to define each mapped attribute tag and its XML path, respectively.

## 10.2.4.2 Structure of a Metadata XML Schema

During the process of extracting DICOM metadata and encoding it into an XML document, a mapping document is used to encode the DICOM attributes into an XML document, and an XML schema is used to validate the encoded metadata XML document. To extract DICOM metadata into a schema-valid XML document, the mapping document and the XML schema definition for the metadata XML document must be synchronized.

The general rules for creating an XML schema for a metadata XML document that is specific to a particular application are as follows:

- The order of the elements defined in the XML schema must match the order of the mapped XML paths for those elements.
- The XML schema must use data types that are either compatible with or less restrictive than the data types defined by Oracle in the schema `ordcmddt.xsd`.
- To extract unmapped DICOM attributes into the XML document, the parent element of the unmapped attributes must be defined as type `DATASET_T` (as in the schema `ordcmddt.xsd`).

- If the attributes `writeTag`, `writeName`, `writeDefiner`, and `writeRawValue` of the `<MAPPED_PATH>` element are set to `"true"` in the mapping document, the XML schema must define the corresponding attributes `tag`, `name`, `definer`, and `rawValue` for each element that is described by the `<MAPPED_PATH>` element in the mapping document.
- If the attribute `occurs` of the `<MAPPED_PATH>` element in the mapping document is set to `"false"` either implicitly or explicitly, the XML schema definition of the element must set the attribute `minOccurs` to `"0"`.
- If the attribute `notEmpty` of the `<MAPPED_PATH>` element in the mapping document is set to `"false"`, the XML schema definition for the element must set the attribute `xsi:nilable` to `"true"`. Otherwise, the element defined by the `<MAPPED_PATH>` element must permit an empty value.

### 10.2.4.3 Creating a Mapping Document for Metadata with No Schema Constraints

This subsection describes how to create a mapping document and a well-formed metadata XML document with no XML schema constraints. For applications that require only a well-formed metadata XML document, the mapping document can contain an empty `<NAMESPACE>` element because the extracted metadata need not conform to any XML schema.

This subsection also includes a code example of a mapping document, followed by a code example of the resulting metadata XML document. Appropriate XML statements are highlighted in bold to show where the main actions occur in both the mapping document and the related XML document. Descriptions of each bolded XML statement follow the examples.

[Example 10-24](#) shows a sample mapping document with an empty `<NAMESPACE>` element. This example also shows the values to be specified for the `occurs`, `notEmpty`, `writeTag`, `writeDefiner`, and `writeName` attributes in the `<MAPPED_PATH>` element to define the extracted metadata XML document. If these attributes are not specified, they are set to `"false"`, the default value.

[Example 10-25](#) shows the resulting metadata XML document whose XML metadata was extracted with the value of the `extractOption` parameter in the `extractMetadata()` method set to `MAPPED`.

In [Example 10-24](#) and [Example 10-25](#), these actions occur:

- In the mapping document, the `<NAMESPACE>` element is empty. As a result, the resulting extracted XML document does not include the default namespace declaration because it is not constrained by an XML schema.
- The `<ROOT_ELEM_TAG>` element in the mapping document matches the root element tag (shown in the `<DICOM_OBJECT>` element) in the extracted XML document.
- In the mapping document, the value of the `notEmpty` attribute of the `<MAPPED_PATH>` element for the DICOM attribute with tag `00100040` is `"false"`. In the extracted XML document, the value of the `xsi:nil` attribute in the `<BIRTH_DATE>` element is set to `"true"` because this DICOM attribute is empty in the DICOM content.
- In the mapping document, the `<MAPPED_PATH>` element for the DICOM attribute with tag `00200010`, the `writeTag`, `writeName`, and `writeDefiner` attributes are set to

"true". In the extracted XML document, the child element <ID> under the <STUDY> element has corresponding `definer`, `tag`, and `name` attributes.

- In the mapping document, the <MAPPED\_PATH> element for the DICOM attribute with tag 00081080 uses the default value ("false") for the `occurs` attribute. Because this DICOM attribute does not exist in the DICOM content, the element <ADMITTING\_DIAGNOSES\_DESCRIPTION> does not exist in the extracted XML document.

See [extractMetadata\(\)](#) for reference information about this method and the supported values for the `extractOption` parameter.

### Example 10-24 Sample Mapping Document for Metadata with No Schema Constraints

```
<?xml version="1.0" encoding="UTF-8"?>
<XML_MAPPING_DOCUMENT
  xmlns="http://xmlns.oracle.com/ord/dicom/mapping_1_0"
  xmlns:xsi="http://www.w3.org/2001/XMLSchema-instance"
  xsi:schemaLocation="http://xmlns.oracle.com/ord/dicom/mapping_1_0
    http://xmlns.oracle.com/ord/dicom/mapping_1_0">
  <NAMESPACE></NAMESPACE>
  <ROOT_ELEM_TAG>DICOM_OBJECT</ROOT_ELEM_TAG>
  <UNMAPPED_ELEM>OTHER_ATTRIBUTES</UNMAPPED_ELEM>
  <MAPPED_ELEM>KEY_ATTRIBUTES</MAPPED_ELEM>

  <MAPPED_PATH occurs="true" notEmpty="true">
    <ATTRIBUTE_TAG>00100010</ATTRIBUTE_TAG>
    <PATH>PATIENT/NAME</PATH>
  </MAPPED_PATH>

  <MAPPED_PATH occurs="true" notEmpty="true">
    <ATTRIBUTE_TAG>00100020</ATTRIBUTE_TAG>
    <PATH>PATIENT/ID</PATH>
  </MAPPED_PATH>

  <MAPPED_PATH occurs="true" notEmpty="false">
    <ATTRIBUTE_TAG>00100030</ATTRIBUTE_TAG>
    <PATH>PATIENT/BIRTH_DATE</PATH>
  </MAPPED_PATH>

  <MAPPED_PATH occurs="false" notEmpty="false">
    <ATTRIBUTE_TAG>00100040</ATTRIBUTE_TAG>
    <PATH>PATIENT/SEX</PATH>
  </MAPPED_PATH>

  <MAPPED_PATH writeTag="true" writeDefiner="true" writeName="true">
    <ATTRIBUTE_TAG>00200010</ATTRIBUTE_TAG>
    <PATH>STUDY/ID</PATH>
  </MAPPED_PATH>

  <MAPPED_PATH>
    <ATTRIBUTE_TAG>00080030</ATTRIBUTE_TAG>
    <PATH>STUDY/TIME</PATH>
  </MAPPED_PATH>

  <MAPPED_PATH>
    <ATTRIBUTE_TAG>00081080</ATTRIBUTE_TAG>
    <PATH>STUDY/ADMITTING_DIAGNOSES_DESCRIPTION</PATH>
  </MAPPED_PATH>
```

```
</XML_MAPPING_DOCUMENT>
```

### Example 10-25 Resulting XML Document for Metadata with No Schema Constraints

```
<?xml version="1.0" encoding="DEC-MCS"?>
<DICOM_OBJECT xmlns:xsi="http://www.w3.org/2001/XMLSchema-instance">
  <KEY_ATTRIBUTES>
    <PATIENT>
      <NAME>
        <NAME type="unibyte">
          <FAMILY>CANCIO 2HR A-02-013</FAMILY>
        </NAME>
        <VALUE>CANCIO 2HR A-02-013</VALUE>
      </NAME>
      <ID>ISRST610b</ID>
      <BIRTH_DATE xsi:nil="true"/>
      <SEX xsi:nil="true"/>
    </PATIENT>
    <STUDY>
      <ID definer="DICOM" tag="00200010" name="Study ID">352</ID>
      <TIME>18:48:41.000000</TIME>
    </STUDY>
  </KEY_ATTRIBUTES>
</DICOM_OBJECT>
```

## 10.2.4.4 Creating a Mapping Document for Metadata with Schema Constraints and a Mapped Section Only

This subsection describes how to create a mapping document and a metadata XML document with XML schema constraints, discarding the unmapped section. This example can be used in applications that require only the DICOM attributes defined in the mapped section of the XML metadata, and in metadata XML documents with XML schema constraints.

This subsection also includes code examples of a mapping document, an XML schema, and the resulting metadata XML document constrained by the schema. Appropriate XML statements are highlighted in bold to show where the main actions occur in both the mapping document and the related XML document. Descriptions of each bolded XML statement follow the examples.

The `extractMetadata()` method of the `ORDDicom` object can extract all or part of the metadata into an XML document based on the value of the `extractOption` parameter.

See [extractMetadata\(\)](#) for reference information about this method and the supported values for the `extractOption` parameter.

[Example 10-26](#) shows a sample mapping document that specifies the namespace of the metadata XML document, so that the metadata document can be constrained by an XML schema.

The mapping document in [Example 10-26](#) differs from the mapping document in [Example 10-24](#) as follows:

- The `<NAMESPACE>` element contains a value.
- The `<UNMAPPED_ELEM>` and the `<MAPPED_ELEM>` elements are empty, thus the mapped path is relative to the `<ROOT_ELEM_TAG>` element.

The XML schema for the mapping document in [Example 10-26](#) is defined in [Example 10-27](#):

In [Example 10-26](#) and the associated XML schema (in [Example 10-27](#)), the following elements and data types are defined:

- The namespace declaration of the metadata XML schema has the same value as the <NAMESPACE> element in the mapping document.
- For the <MAPPED\_PATH> element in the mapping document that has the value of the `notEmpty` attribute set to "false" either explicitly, as for tag `00100030`, or implicitly using the default value, as for tag `00800030`, the corresponding element defined in the XML schema has the value of the `nullable` attribute set to "true", as in the <BIRTH\_DATE> element and the <TIME> element.
- Any <MAPPED\_PATH> element in the mapping document that has the value of the `occurs` attribute set to "false" either explicitly, as for tag `00100040`, or implicitly using the default value, as for tag `00800030`, the corresponding element defined in the XML schema must have the value of the attribute `minOccurs` set to "0", as in the <SEX> element and the <TIME> element.
- The data type defined in the XML schema must be compatible with the data type defined by Oracle in the schema `ordcmmdt.xsd`. In [Example 2](#), the "PERSON\_NAME" data type definition is copied from the schema `ordcmmdt.xsd`, while the "ID\_TYPE" data type is defined so that the <ID> element under the <STUDY> element can have the `tag`, `definer`, and `name` attributes. The "ID\_TYPE" data type is compatible with the "SH\_ATTR\_T" data type defined by Oracle. The <SEX> element is defined to use the "xs:string" data type, which is compatible with the Oracle-defined data type "CS".
- The <UNMAPPED\_ELEM> element is empty in the mapping document, and the root element <DICOM\_OBJECT> of the metadata XML is not defined as the "DATASET\_T" type. With this schema constraint, a valid metadata XML document can include a mapped section only. Thus, if the application attempts to extract metadata using a value of "ALL" or "STANDARD" for the `extractOption` parameter, the attempt returns this error:

```
ORA-53259: cannot extract metadata that conforms to the schema definition
```

[Example 10-28](#) shows the resulting metadata XML document whose XML metadata was extracted with the value of the `extractOption` parameter in the `extractMetadata()` method set to `MAPPED`.

### Example 10-26 Sample Mapping Document for Metadata with Schema Constraints and a Mapped Section Only

```
<?xml version="1.0" encoding="UTF-8"?>
<XML_MAPPING_DOCUMENT
  xmlns="http://xmlns.oracle.com/ord/dicom/mapping_1_0"
  xmlns:xsi="http://www.w3.org/2001/XMLSchema-instance"
  xsi:schemaLocation="http://xmlns.oracle.com/ord/dicom/mapping_1_0
    http://xmlns.oracle.com/ord/dicom/mapping_1_0">
  <NAMESPACE>http://www.mycompany.com/dicom/example2</NAMESPACE>
  <ROOT_ELEM_TAG>DICOM_OBJECT</ROOT_ELEM_TAG>
  <UNMAPPED_ELEM></UNMAPPED_ELEM>
  <MAPPED_ELEM></MAPPED_ELEM>

  <MAPPED_PATH occurs="true" notEmpty="true">
    <ATTRIBUTE_TAG>00100010</ATTRIBUTE_TAG>
    <PATH>PATIENT/NAME</PATH>
  </MAPPED_PATH>
```

```

<MAPPED_PATH occurs="true" notEmpty="true">
  <ATTRIBUTE_TAG>00100020</ATTRIBUTE_TAG>
  <PATH>PATIENT/ID</PATH>
</MAPPED_PATH>
<MAPPED_PATH occurs="true" notEmpty="false">
  <ATTRIBUTE_TAG>00100030</ATTRIBUTE_TAG>
  <PATH>PATIENT/BIRTH_DATE</PATH>
</MAPPED_PATH>

<MAPPED_PATH occurs="false" notEmpty="false">
  <ATTRIBUTE_TAG>00100040</ATTRIBUTE_TAG>
  <PATH>PATIENT/SEX</PATH>
</MAPPED_PATH>

<MAPPED_PATH writeTag="true" writeDefiner="true" writeName="true">
  <ATTRIBUTE_TAG>00200010</ATTRIBUTE_TAG>
  <PATH>STUDY/ID</PATH>
</MAPPED_PATH>

<MAPPED_PATH>
  <ATTRIBUTE_TAG>00080030</ATTRIBUTE_TAG>
  <PATH>STUDY/TIME</PATH>
</MAPPED_PATH>

<MAPPED_PATH>
  <ATTRIBUTE_TAG>00081080</ATTRIBUTE_TAG>
  <PATH>STUDY/ADMITTING_DIAGNOSES_DESCRIPTION</PATH>
</MAPPED_PATH>

</XML_MAPPING_DOCUMENT>

```

### Example 10-27 Sample XML Schema for Metadata with Schema Constraints and a Mapped Section

```

<?xml version="1.0" encoding="UTF-8"?>
<xs:schema
  xmlns="http://www.mycompany.com/dicom/example2"
  xmlns:xdb="http://xmlns.oracle.com/xdb"
  xmlns:xs="http://www.w3.org/2001/XMLSchema"
  targetNamespace="http://www.mycompany.com/dicom/example2"
  elementFormDefault="qualified"
  attributeFormDefault="unqualified">
  <xs:element name="DICOM_OBJECT">
    <xs:complexType>
      <xs:sequence>
        <xs:element name="PATIENT">
          <xs:complexType>
            <xs:sequence>
              <xs:element name="NAME" type="PERSON_NAME"/>
              <xs:element name="ID" type="xs:string"/>
              <xs:element name="BIRTH_DATE" type="xs:date" nillable="true"/>
              <xs:element name="SEX" type="xs:string" minOccurs="0"
                nillable="true"/>
            </xs:sequence>
          </xs:complexType>
        </xs:element>
        <xs:element name="STUDY">
          <xs:complexType>
            <xs:sequence>
              <xs:element name="ID" type="ID_TYPE" minOccurs="0"

```

```
        nillable="true"/>
        <xs:element name="TIME" type="xs:time" minOccurs="0"
            nillable="true"/>
        <xs:element name="ADMITTING_DIAGNOSES_DESCRIPTION" type="xs:string"
            minOccurs="0" nillable="true"/>
    </xs:sequence>
</xs:complexType>
</xs:element>
</xs:sequence>
</xs:complexType>
</xs:element>
<xs:complexType name="PERSON_NAME">
    <xs:sequence>
        <xs:element name="NAME">
            <xs:complexType>
                <xs:sequence>
                    <xs:element name="FAMILY" type="xs:string" minOccurs="0"
                        nillable="true"/>
                    <xs:element name="GIVEN" type="xs:string" minOccurs="0"
                        nillable="true"/>
                    <xs:element name="MIDDLE" type="xs:string" minOccurs="0"
                        nillable="true"/>
                    <xs:element name="PREFIX" type="xs:string" minOccurs="0"
                        nillable="true"/>
                    <xs:element name="SUFFIX" type="xs:string" minOccurs="0"
                        nillable="true"/>
                </xs:sequence>
                <xs:attribute name="type" default="unibyte">
                    <xs:simpleType>
                        <xs:restriction base="xs:token">
                            <xs:enumeration value="unibyte"/>
                            <xs:enumeration value="ideographic"/>
                            <xs:enumeration value="phonetic"/>
                        </xs:restriction>
                    </xs:simpleType>
                </xs:attribute>
            </xs:complexType>
        </xs:element>
        <xs:element name="VALUE" minOccurs="0" nillable="true">
            <xs:simpleType>
                <xs:restriction base="xs:token">
                    <xs:maxLength value="64"/>
                </xs:restriction>
            </xs:simpleType>
        </xs:element>
    </xs:sequence>
</xs:complexType>
<xs:complexType name="ID_TYPE">
    <xs:simpleContent>
        <xs:extension base="xs:string">
            <xs:attribute name="tag" type="xs:string"/>
            <xs:attribute name="definer" type="xs:string"/>
            <xs:attribute name="name" type="xs:string"/>
        </xs:extension>
    </xs:simpleContent>
</xs:complexType>
</xs:schema>
```

### Example 10-28 Resulting XML Document for Metadata with Schema Constraints and a Mapped Section

```
<?xml version="1.0" encoding="DEC-MCS"?>
<DICOM_OBJECT xmlns="http://www.mycompany.com/dicom/example2"
  xmlns:xsi="http://www.w3.org/2001/XMLSchema-instance"
  xsi:schemaLocation="http://www.mycompany.com/dicom/example2
  http://www.mycompany.com/dicom/example2">
  <PATIENT>
    <NAME>
      <NAME type="unibyte">
        <FAMILY>CANCIO 2HR A-02-013</FAMILY>
      </NAME>
      <VALUE>CANCIO 2HR A-02-013</VALUE>
    </NAME>
    <ID>ISRSCT610b</ID>
    <BIRTH_DATE xsi:nil="true"/>
    <SEX xsi:nil="true"/>
  </PATIENT>
  <STUDY>
    <ID definer="DICOM" tag="00200010" name="Study ID">352</ID>
    <TIME>18:48:41.000000</TIME>
  </STUDY>
</DICOM_OBJECT>
```

## 10.2.4.5 Creating a Mapping Document for Metadata with Schema Constraints

This subsection describes how to create a mapping document and a metadata XML document with XML schema constraints, including the unmapped section.

This subsection also includes code examples of a mapping document, an XML schema, and the resulting metadata XML document constrained by the schema. Appropriate XML statements are highlighted in bold to show where the main actions occur in both the mapping document and the related XML document. Descriptions of each bolded XML statement follow the examples.

[Example 10-29](#) shows a sample mapping document that includes a sequence type attribute in the mapped section.

The mapping document in [Example 10-29](#) differs from the mapping document in [Example 10-26](#) as follows:

- The **<UNMAPPED\_ELEM>** and **<MAPPED\_ELEM>** elements are not empty.
- There is a **<MAPPED\_PATH>** element for tag 00081084, which is of DICOM sequence type.

The XML schema code segment in [Example 10-30](#) shows how to define the unmapped root element for the mapping document in [Example 10-29](#) to include the unmapped section in the extracted metadata XML document. This code segment also shows how to use Oracle-defined data types from the schema `ordcmddt.xsd`.

In [Example 10-29](#) and the associated XML schema (in [Example 10-30](#)), the following actions occur:

- Instead of defining its own data types as in [Creating a Mapping Document for Metadata with Schema Constraints and a Mapped Section Only](#), this XML schema uses the Oracle-defined data types by copying the schema `ordcmddt.xsd` into an application-specific XSD file and then changing the namespace declaration, as in this XML code segment:



```
<xs:schema
xmlns="http://www.mycompany.com/dicom/example3"
xmlns:xs="http://www.w3.org/2001/XMLSchema"
xmlns:xdb="http://xmlns.oracle.com/xdb"
targetNamespace="http://www.mycompany.com/dicom/example3"
elementFormDefault="qualified"
attributeFormDefault="unqualified">
```

This data type XML schema is registered as a global XML schema with Oracle XML DB, using the following namespace URL:

```
"http://www.mycompany.com/dicom/datatype_3"
```

Then, this registered namespace URL is included in the metadata XML schema.

See *Oracle XML DB Developer's Guide* for more information about registering global and local XML schemas.

- Because the Oracle-defined data types are included in the XML schema, they can be referenced directly, as shown in the <NAME>, <ADMITTING\_DIAGNOSES\_CODE\_SEQUENCE>, and <OTHER\_ATTRIBUTES> elements.
- The <OTHER\_ATTRIBUTES> element is defined as type "DATASET\_T" to enable the inclusion of all unmapped DICOM attributes under this element when a value of ALL or STANDARD is passed to the extractMetadata() method for the extractOption parameter. Because the minOccurs attribute is defined as 0, when the value MAPPED is passed to the extractMetadata() method, only the mapped section is included in the extracted XML document.

[Example 10-31](#) shows the resulting metadata XML document whose XML metadata was extracted with the value of the extractOption parameter in the extractMetadata() method set to MAPPED.

[Example 10-32](#) shows the resulting metadata XML document whose XML metadata was extracted with the value of the extractOption parameter in the extractMetadata() method set to ALL.

### Example 10-29 Sample Mapping Document for Metadata with Schema Constraints

```
<?xml version="1.0" encoding="UTF-8"?>
<XML_MAPPING_DOCUMENT
  xmlns="http://xmlns.oracle.com/ord/dicom/mapping_1_0"
  xmlns:xsi="http://www.w3.org/2001/XMLSchema-instance"
  xsi:schemaLocation="http://xmlns.oracle.com/ord/dicom/mapping_1_0
    http://xmlns.oracle.com/ord/dicom/mapping_1_0">
  <NAMESPACE>http://www.mycompany.com/dicom/example3</NAMESPACE>
  <ROOT_ELEM_TAG>DICOM_OBJECT</ROOT_ELEM_TAG>
  <UNMAPPED_ELEM>OTHER_ATTRIBUTES</UNMAPPED_ELEM>
  <MAPPED_ELEM>KEY_ATTRIBUTES</MAPPED_ELEM>

  <MAPPED_PATH occurs="true" notEmpty="true">
    <ATTRIBUTE_TAG>00100010</ATTRIBUTE_TAG>
    <PATH>PATIENT/NAME</PATH>
  </MAPPED_PATH>

  <MAPPED_PATH occurs="true" notEmpty="true">
    <ATTRIBUTE_TAG>00100020</ATTRIBUTE_TAG>
    <PATH>PATIENT/ID</PATH>
  </MAPPED_PATH>
```

```

    <MAPPED_PATH occurs="true" notEmpty="false">
<ATTRIBUTE_TAG>00100030</ATTRIBUTE_TAG>
    <PATH>PATIENT/BIRTH_DATE</PATH>
</MAPPED_PATH>

    <MAPPED_PATH occurs="false" notEmpty="false">
    <ATTRIBUTE_TAG>00100040</ATTRIBUTE_TAG>
    <PATH>PATIENT/SEX</PATH>
</MAPPED_PATH>

    <MAPPED_PATH writeTag="true" writeDefiner="true" writeName="true">
    <ATTRIBUTE_TAG>00200010</ATTRIBUTE_TAG>
    <PATH>STUDY/ID</PATH>
</MAPPED_PATH>

<MAPPED_PATH>
    <ATTRIBUTE_TAG>00081084</ATTRIBUTE_TAG>
    <PATH>
        STUDY/ADMITTING_DIAGNOSES_CODE_SEQUENCE
    </PATH>
</MAPPED_PATH>

</XML_MAPPING_DOCUMENT>

```

### Example 10-30 Sample XML Schema for Metadata with Schema Constraints

```

<?xml version="1.0" encoding="UTF-8"?>
<xs:schema xmlns="http://www.mycompany.com/dicom/example3"
    xmlns:xdb="http://xmlns.oracle.com/xdb"
    xmlns:xs="http://www.w3.org/2001/XMLSchema"
    targetNamespace="http://www.mycompany.com/dicom/example3"
    elementFormDefault="qualified"
    attributeFormDefault="unqualified">
    <xs:include schemaLocation="http://www.mycompany.com/dicom/datatype_3"/>
    <xs:element name="DICOM_OBJECT">
        <xs:complexType>
            <xs:sequence>
                <xs:element name="KEY_ATTRIBUTES">
                    <xs:complexType>
                        <xs:sequence>
                            <xs:element name="PATIENT">
                                <xs:complexType>
                                    <xs:sequence>
                                        <xs:element name="NAME" type="PN">
                                        </xs:element>
                                        <xs:element name="ID" type="xs:string">
                                        </xs:element>
                                        <xs:element name="BIRTH_DATE" type="xs:date" nillable="true">
                                        </xs:element>
                                        <xs:element name="SEX" type="xs:string" minOccurs="0"
                                            nillable="true">
                                        </xs:element>
                                    </xs:sequence>
                                </xs:complexType>
                            </xs:element>
                            <xs:element name="STUDY">
                                <xs:complexType>
                                    <xs:sequence>
                                        <xs:element name="ID" type="SH_ATTR_T" minOccurs="0"
                                            nillable="true"/>

```

```

        <xs:element name="ADMITTING_DIAGNOSES_CODE_SEQUENCE" type="SQ"
            nillable="true" minOccurs="0"/>
    </xs:sequence>
</xs:complexType>
</xs:element>
</xs:sequence>
</xs:complexType>
</xs:element>
</xs:element>
<xs:element name="OTHER_ATTRIBUTES" type="DATASET_T" minOccurs="0"
    maxOccurs="unbounded">
    </xs:element>
</xs:sequence>
</xs:complexType>
</xs:element>
</xs:schema>

```

### Example 10-31 Resulting XML Document for Metadata with Schema Constraints (MAPPED)

```

<?xml version="1.0" encoding="DEC-MCS"?>
<DICOM_OBJECT xmlns="http://www.mycompany.com/dicom/example3"
  xmlns:xsi="http://www.w3.org/2001/XMLSchema-instance"
  xsi:schemaLocation="http://www.mycompany.com/dicom/example3
  http://www.mycompany.com/dicom/example3">
  <KEY_ATTRIBUTES>
    <PATIENT>
      <NAME>
        <NAME type="unibyte">
          <FAMILY>CANCIO 2HR A-02-013</FAMILY>
        </NAME>
        <VALUE>CANCIO 2HR A-02-013</VALUE>
      </NAME>
      <ID>ISRST610b</ID>
      <BIRTH_DATE xsi:nil="true"/>
      <SEX xsi:nil="true"/>
    </PATIENT>
    <STUDY>
      <ID definer="DICOM" tag="00200010" name="Study ID">352</ID>
      <ADMITTING_DIAGNOSES_CODE_SEQUENCE>
        <ITEM>
          <SHORT_STRING tag="00080100" definer="DICOM" name="Code Value"
            offset="692" length="0"/>
          <SHORT_STRING tag="00080102" definer="DICOM" name="Coding Scheme
            Designator" offset="700" length="0"/>
          <SHORT_STRING tag="00080103" definer="DICOM" name="Coding Scheme
            Version" offset="708" length="0"/>
          <LONG_STRING tag="00080104" definer="DICOM" name="Code Meaning"
            offset="716" length="0"/>
          <CODE_STRING tag="00080105" definer="DICOM" name="Mapping Resource"
            offset="724" length="0"/>
          <DATE_TIME tag="00080106" definer="DICOM" name="Context Group Version"
            offset="732" length="0" xsi:nil="true" rawValue=""
            byteOrderLE="true"/>
          <DATE_TIME tag="00080107" definer="DICOM" name="Context Group Local
            Version" offset="740" length="0" xsi:nil="true" rawValue=""
            byteOrderLE="true"/>
          <CODE_STRING tag="0008010B" definer="DICOM" name="Context Group
            Extension Flag" offset="748" length="0"/>
          <UNIQUE_ID tag="0008010D" definer="DICOM" name="Context Group Extension
            Creator UID" offset="756" length="0" xsi:nil="true" rawValue=""

```

```

        byteOrderLE="true"/>
        <CODE_STRING tag="0008010F" definer="DICOM" name="Context Identifier"
            offset="764" length="0"/>
    </ITEM>
</ADMITTING_DIAGNOSES_CODE_SEQUENCE>
</STUDY>
</KEY_ATTRIBUTES>
</DICOM_OBJECT>

```

### Example 10-32 Resulting XML Document for Metadata with Schema Constraints (ALL)

```

<?xml version="1.0" encoding="DEC-MCS"?>
<DICOM_OBJECT xmlns="http://www.mycompany.com/dicom/example3"
  xmlns:xsi="http://www.w3.org/2001/XMLSchema-instance"
  xsi:schemaLocation="http://www.mycompany.com/dicom/example3
  http://www.mycompany.com/dicom/example3">
<KEY_ATTRIBUTES>
  <PATIENT>
    <NAME>
      <NAME type="unibyte">
        <FAMILY>CANCIO 2HR A-02-013</FAMILY>
      </NAME>
      <VALUE>CANCIO 2HR A-02-013</VALUE>
    </NAME>
    <ID>ISRST610b</ID>
    <BIRTH_DATE xsi:nil="true"/>
    <SEX xsi:nil="true"/>
  </PATIENT>
  <STUDY>
    <ID definer="DICOM" tag="00200010" name="Study ID">352</ID>
    <ADMITTING_DIAGNOSES_CODE_SEQUENCE>
      <ITEM>
        <SHORT_STRING tag="00080100" definer="DICOM" name="Code Value"
          offset="692" length="0"/>
        <SHORT_STRING tag="00080102" definer="DICOM" name="Coding Scheme
          Designator" offset="700" length="0"/>
        <SHORT_STRING tag="00080103" definer="DICOM" name="Coding Scheme
          Version" offset="708" length="0"/>
        <LONG_STRING tag="00080104" definer="DICOM" name="Code Meaning"
          offset="716" length="0"/>
        <CODE_STRING tag="00080105" definer="DICOM" name="Mapping Resource"
          offset="724" length="0"/>
        <DATE_TIME tag="00080106" definer="DICOM" name="Context Group Version"
          offset="732" length="0" xsi:nil="true" rawValue=""
          byteOrderLE="true"/>
        <DATE_TIME tag="00080107" definer="DICOM" name="Context Group Local
          Version" offset="740" length="0" xsi:nil="true" rawValue=""
          byteOrderLE="true"/>
        <CODE_STRING tag="0008010B" definer="DICOM" name="Context Group
          Extension Flag" offset="748" length="0"/>
        <UNIQUE_ID tag="0008010D" definer="DICOM" name="Context Group Extension
          Creator UID" offset="756" length="0" xsi:nil="true" rawValue=""
          byteOrderLE="true"/>
        <CODE_STRING tag="0008010F" definer="DICOM" name="Context Identifier"
          offset="764" length="0"/>
      </ITEM>
    </ADMITTING_DIAGNOSES_CODE_SEQUENCE>
  </STUDY>
</KEY_ATTRIBUTES>
<OTHER_ATTRIBUTES>

```

```

<OTHER_BYTE tag="00020001" definer="DICOM" name="File Meta Information
  Version" offset="156" length="2">AQA=
</OTHER_BYTE>
<UNIQUE_ID tag="00020002" definer="DICOM" name="Media Storage SOP Class UID"
  offset="166" length="26">1.2.840.10008.5.1.4.1.1.2</UNIQUE_ID>
<UNIQUE_ID tag="00020003" definer="DICOM" name="Media Storage SOP Instance
  UID" offset="200" length="54">1.2.392.200036.91</UNIQUE_ID>
<UNIQUE_ID tag="00020010" definer="DICOM" name="Transfer Syntax UID"
  offset="262" length="18">1.2.840.10008.1.2</UNIQUE_ID>
<UNIQUE_ID tag="00020012" definer="DICOM" name="Implementation Class UID"
  offset="288" length="16">1.2.804.114118.3</UNIQUE_ID>
<APPLICATION_ENTITY tag="00020016" definer="DICOM" name="Source Application Entity
  Title" offset="326" length="0" xsi:nil="true" rawValue="" byteOrderLE="true"/>
<CODE_STRING tag="00080008" definer="DICOM" name="Image Type" offset="334"
  length="22">ORIGINAL</CODE_STRING>
<CODE_STRING tag="00080008" definer="DICOM" name="Image Type" offset="334"
  length="22">PRIMARY</CODE_STRING>
<CODE_STRING tag="00080008" definer="DICOM" name="Image Type" offset="334"
  length="22">AXIAL</CODE_STRING>
<UNIQUE_ID tag="00080016" definer="DICOM" name="SOP Class UID" offset="364"
  length="26">1.2.840.10008.5.1.4.1.1.2</UNIQUE_ID>
<UNIQUE_ID tag="00080018" definer="DICOM" name="SOP Instance UID" offset="398"
  length="54">1.2.392.200036.91</UNIQUE_ID>
<DATE tag="00080020" definer="DICOM" name="Study Date" offset="460"
length="8">2004-02-23</DATE>
<DATE tag="00080022" definer="DICOM" name="Acquisition Date" offset="476"
length="8">2004-02-23</DATE>
<DATE tag="00080023" definer="DICOM" name="Content Date" offset="492"
length="8">2004-02-23</DATE>
<TIME tag="00080030" definer="DICOM" name="Study Time" offset="508"
length="14">18:48:41.000000</TIME>
<TIME tag="00080032" definer="DICOM" name="Acquisition Time" offset="530"
length="14">18:50:52.100000</TIME>
<TIME tag="00080033" definer="DICOM" name="Content Time" offset="552"
length="14">18:50:52.725000</TIME>
<SHORT_STRING tag="00080050" definer="DICOM" name="Accession Number"
offset="574" length="4">352</SHORT_STRING>
<CODE_STRING tag="00080060" definer="DICOM" name="Modality" offset="586"
length="2">CT</CODE_STRING>
.
.
.
<SHORT_STRING tag="00400253" definer="DICOM" name="Performed Procedure Step
  ID" offset="1742" length="4">351</SHORT_STRING>
<OTHER_WORD tag="7FE00010" definer="DICOM" name="Pixel Data" offset="1766"
  length="524288" truncated="true" xsi:nil="true" endian="little"/>
</OTHER_ATTRIBUTES>
</DICOM_OBJECT>

```

### 10.2.4.6 Using DICOM Value Locators in Mapping Documents

This subsection shows how to use DICOM value locators to specify attributes in mapping documents. [Example 10-33](#) shows how to use a DICOM value locator to specify the family name field of the Patient's Name attribute with unibyte encoding in a mapping document. The XML statement where this action is performed is highlighted in bold.

Using the mapping document that contains the code shown in [Example 10-33](#) in the `extractMetadata()` method results in an XML document that contains the tag `<FAMILY_NAME>` with the value that corresponds to the family name field of the attribute `00100010`.

[Example 10-34](#) shows how to use a DICOM value locator to specify an attribute embedded within a sequence attribute in a mapping document.

Using the mapping document that contains the code shown in [Example 10-34](#) in the `extractMetadata()` method results in an XML document that contains the tag `<RELATIONSHIP>` with the value that corresponds to the value of attribute `0040A010`. Attribute `0040A010` is embedded within the second item of the sequence attribute `0040A730`.

The standard attribute tags `0040A730` and `0040A010` are defined as follows in the standard dictionary:

```
<STANDARD_ATTRIBUTE_DEFINITION>
  <TAG>0040A730</TAG>
  <NAME>Content Sequence</NAME>
  <VR>SQ</VR>
  <VM>1</VM>
</STANDARD_ATTRIBUTE_DEFINITION>

<STANDARD_ATTRIBUTE_DEFINITION>
  <TAG>0040A010</TAG>
  <NAME>Relationship Type</NAME>
  <VR>CS</VR>
  <VM>1</VM>
</STANDARD_ATTRIBUTE_DEFINITION>
```

In the tag definition shown in the preceding code segment, the `<VR>` element shows that attribute `0040A730` is an attribute of sequence type. By using the DICOM value locator, any attribute that is embedded within a sequence type attribute can be retrieved individually into the resulting XML metadata document.

[Example 10-35](#) shows how to use a DICOM value locator to specify a single value of an attribute that contains multiple values in a mapping document.

Using the mapping document that contains the code shown in [Example 10-35](#) in the `extractMetadata()` method results in an XML document that contains the tag `<IMAGE_TYPE>` with the value that corresponds to the third value of the attribute `00080008`.

The standard attribute tag `00080008` is defined as follows in the standard dictionary:

```
<STANDARD_ATTRIBUTE_DEFINITION>
  <TAG>00080008</TAG>
  <NAME>Image Type</NAME>
  <VR>CS</VR>
  <VM>1-n</VM>
</STANDARD_ATTRIBUTE_DEFINITION>
```

In the tag definition shown in the preceding code segment, the `<VM>` element shows that the attribute can contain multiple values. Using the DICOM value locator with an item number such as `00080008[3]` ensures that the specific (third) value is retrieved.

See [General Format for DICOM Value Locators](#) for more information about the DICOM value locator type.

**Example 10-33 DICOM Value Locator for an Attribute with Unibyte Encoding in a Mapping Document**

```
<MAPPED_PATH>
  <ATTRIBUTE_TAG>00100010#UnibyteFamily</ATTRIBUTE_TAG>
  <PATH>FAMILY_NAME</PATH>
</MAPPED_PATH>
```

**Example 10-34 DICOM Value Locator for an Embedded Sequence Attribute in a Mapping Document**

```
<MAPPED_PATH>
  <ATTRIBUTE_TAG>0040A730[2].0040A010</ATTRIBUTE_TAG>
  <PATH>RELATIONSHIP</PATH>
</MAPPED_PATH>
```

**Example 10-35 DICOM Value Locator for a Single Attribute Value in a Mapping Document**

```
<MAPPED_PATH>
  <ATTRIBUTE_TAG>00080008[3]</ATTRIBUTE_TAG>
  <PATH>IMAGE_TYPE</PATH>
</MAPPED_PATH>
```

## 10.2.5 Creating Preference Documents

Preference documents are XML documents that list the set of preference parameters that define the run-time behavior of Oracle Multimedia DICOM.

The XML document `ordcmpf.xsd` defines the XML schema that constrains preference documents. (See [DICOM XML Schemas](#) for more information about this schema. The text within the `<xs: annotation>` element includes a detailed description of the preference parameters and their valid values.)

The default preference document `ordcmpf.xml` includes the default values for the run-time preference parameters for Oracle Multimedia DICOM. (See [DICOM Configuration Documents](#) for more information about this configuration document.)

Within a preference document, a `<PREFERENCE_DEF>` element is used to define each preference parameter and its value.

 **Note:**

Keep these additional guidelines in mind:

- A maximum of two (one Oracle-defined and one user-defined) preference documents are permitted in the repository.
- Changes to preference parameter values in preference documents change the behavior of DICOM methods, functions, and procedures. Specifically, preference parameter values that are defined in the user-defined preference document override the default values defined in the Oracle-defined preference document `ordcmpf.xml`.
- All preference parameter names and their associated values are defined by Oracle. User-defined preference documents can change the values of the Oracle-defined preference parameters.

The following subsections contain examples that show how to define preference parameter values in a preference document:

- [Defining the BINARY\\_SKIP\\_INVALID\\_ATTR Preference Parameter](#)
- [Defining the CONFORMANCE\\_LEVEL Preference Parameter](#)
- [Defining the EXP\\_IF\\_NULL\\_ATTR\\_IN\\_CONSTRAINT Preference Parameter](#)
- [Defining the IGNORED\\_EXP\\_LIST Preference Parameter](#)
- [Defining the MANDATE\\_ATTR\\_TAGS\\_IN\\_STL Preference Parameter](#)
- [Defining the MAX\\_RECURSION\\_DEPTH Preference Parameter](#)
- [Defining the SPECIFIC\\_CHARACTER\\_SET Preference Parameter](#)
- [Defining the SQ\\_WRITE\\_LEN Preference Parameter](#)
- [Defining the VALIDATE\\_METADATA Preference Parameter](#)
- [Defining the XML\\_SKIP\\_ATTR Preference Parameter](#)

### 10.2.5.1 Defining the BINARY\_SKIP\_INVALID\_ATTR Preference Parameter

The `BINARY_SKIP_INVALID_ATTR` preference parameter is used to specify whether Oracle Multimedia DICOM includes or skips invalid attributes and their values in the binary output of DICOM content when making a copy of the DICOM Part 10 file. Invalid attributes are attributes that do not conform to the specified DICOM standard.

[Example 10-36](#) shows how to define this preference parameter in a preference document.

The `<PARAMETER>` element specifies the Oracle-defined preference parameter `BINARY_SKIP_INVALID_ATTR`.

The `<VALUE>` element represents the value of the `BINARY_SKIP_INVALID_ATTR` preference parameter, which is `false` by default.

If the value of this preference parameter is `false`, invalid attributes and their values are included in the corresponding output. If the preference parameter value is set to `true`, the attribute values are included in the output with length 0.

#### **Example 10-36** Definition of the `BINARY_SKIP_INVALID_ATTR` Preference Parameter

```
<PREFERENCE_DEF>
  <PARAMETER>BINARY_SKIP_INVALID_ATTR</PARAMETER>
  <DESCRIPTION>
    Do not skip the value of attributes that do not conform to the
    DICOM specification when making a copy of a DICOM Part 10 file.
  </DESCRIPTION>
  <VALUE>false</VALUE>
</PREFERENCE_DEF>
```

### 10.2.5.2 Defining the CONFORMANCE\_LEVEL Preference Parameter

The `CONFORMANCE_LEVEL` preference parameter is used to specify which types of errors and exceptions Oracle Multimedia DICOM ignores or reports when processing DICOM content. [Example 10-37](#) shows how to define this preference parameter in a preference document.



The `<PARAMETER>` element specifies the Oracle-defined preference parameter `CONFORMANCE_LEVEL`.

The `<VALUE>` element represents the value of the `CONFORMANCE_LEVEL` parameter, which is `ignoreException` by default. Other valid values are: `leastConform` and `mostConform`.

The default value `ignoreException` instructs all functions to ignore the types of exceptions specified in the preference parameter `IGNORED_EXP_LIST`.

The value `leastConform` instructs all functions to ignore errors and exceptions to maximize the processing of DICOM content.

If the value is set to `mostConform`, all functions throw an exception when encountering DICOM content that does not conform to the DICOM standard. (This behavior does not include backward compatibility cases that are allowed by the DICOM standard.)

#### Example 10-37 Definition of the `CONFORMANCE_LEVEL` Preference Parameter

```
<PREFERENCE_DEF>
  <PARAMETER>CONFORMANCE_LEVEL</PARAMETER>
  <DESCRIPTION>
    Ignore selected exceptions.
  </DESCRIPTION>
  <VALUE>ignoreException</VALUE>
</PREFERENCE_DEF>
```

### 10.2.5.3 Defining the `EXP_IF_NULL_ATTR_IN_CONSTRAINT` Preference Parameter

The `EXP_IF_NULL_ATTR_IN_CONSTRAINT` preference parameter is used to specify whether Oracle Multimedia DICOM throws an exception when encountering a missing attribute or a null attribute value during conformance validation. [Example 10-38](#) shows how to define this preference parameter in a preference document.

The `<PARAMETER>` element specifies the Oracle-defined preference parameter `EXP_IF_NULL_ATTR_IN_CONSTRAINT`.

The `<VALUE>` element represents the value of the `EXP_IF_NULL_ATTR_IN_CONSTRAINT` preference parameter, which is `true` by default.

In a constraint predicate that is not preceded by a `notEmpty` Boolean function predicate on an attribute, when the value of this preference parameter is `true`, an exception is thrown at the first occurrence of either of these conditions:

- The attribute is missing.
- The attribute has a null value.

See [Example 10-14](#) for more information.

If the value is set to `false`, no exception is thrown.

This preference parameter affects the results of the method `isConformanceValid()`. See the [isConformanceValid\(\)](#) method for more information.

**Example 10-38 Definition of the EXP\_IF\_NULL\_ATTR\_IN\_CONSTRAINT Preference Parameter**

```
<PREFERENCE_DEF>
  <PARAMETER>EXP_IF_NULL_ATTR_IN_CONSTRAINT</PARAMETER>
  <DESCRIPTION>
    Throw an exception if a missing attribute or a null
    attribute value is encountered during conformance
    validation.
  </DESCRIPTION>
  <VALUE>>true</VALUE>
</PREFERENCE_DEF>
```

### 10.2.5.4 Defining the IGNORED\_EXP\_LIST Preference Parameter

The IGNORED\_EXP\_LIST preference parameter is used to specify the types of exceptions that Oracle Multimedia DICOM ignores when processing DICOM content. This preference parameter is effective only when the value of the CONFORMANCE\_LEVEL preference parameter is set to `ignoreException`.

[Example 10-39](#) shows how to define this preference parameter in a preference document.

The `<PARAMETER>` element specifies the Oracle-defined preference parameter IGNORED\_EXP\_LIST.

The `<VALUE>` element represents the value of the IGNORED\_EXP\_LIST preference parameter, which lists one or more exceptions to be ignored.

**Example 10-39 Definition of the IGNORED\_EXP\_LIST Preference Parameter**

```
<PREFERENCE_DEF>
  <PARAMETER>IGNORED_EXP_LIST</PARAMETER>
  <DESCRIPTION>
    Do not throw exceptions if: mandatory attributes are missing
    from the DICOM content (MISSING_ATTR), the DICOM file magic number
    "DICM" is missing (MISSING_MAGIC), an attribute has an invalid value
    representation value (INVALID_VR), an attribute has an incorrect
    value multiplicity (INVALID_VM), or a DICOM Part 10 file contains
    invalid data (PARSE_ERR).
  </DESCRIPTION>
  <VALUE>MISSING_ATTR MISSING_MAGIC INVALID_VR INVALID_VM PARSE_ERR</VALUE>
</PREFERENCE_DEF>
```

### 10.2.5.5 Defining the MANDATE\_ATTR\_TAGS\_IN\_STL Preference Parameter

The MANDATE\_ATTR\_TAGS\_IN\_STL preference parameter is used to specify whether Oracle Multimedia DICOM enforces the rule that all tags used by the constraint and mapping documents must be listed in the stored tag list document. [Example 10-40](#) shows how to define this preference parameter in a preference document.

The `<PARAMETER>` element specifies the Oracle-defined preference parameter MANDATE\_ATTR\_TAGS\_IN\_STL.

The `<VALUE>` element represents the value of the MANDATE\_ATTR\_TAGS\_IN\_STL preference parameter, which is `false` by default.

The value of this preference parameter determines whether to enforce the rule that all tags used by the constraint and mapping documents are listed in the stored tag list

document. If the value of this preference parameter is set to `true`, the rule is enforced. If the value is `false`, the rule is not enforced.

However, if an existing stored tag list document does not satisfy the rule, the value of the preference parameter cannot be set to `true` until the stored tag list document is updated. Also, if the value of this preference parameter is `true`, only constraint and mapping documents that use tags listed in the stored tag list document can be inserted into the repository.

#### Example 10-40 Definition of the MANDATE\_ATTR\_TAGS\_IN\_STL Preference Parameter

```
<PREFERENCE_DEF>
  <PARAMETER>MANDATE_ATTR_TAGS_IN_STL</PARAMETER>
  <DESCRIPTION>
    All tags in the constraint and mapping docs must be listed in the
    STORED_TAG_LIST document.
  </DESCRIPTION>
  <VALUE>true</VALUE>
</PREFERENCE_DEF>
```

### 10.2.5.6 Defining the MAX\_RECURSION\_DEPTH Preference Parameter

The `MAX_RECURSION_DEPTH` preference parameter is used to specify the maximum level of recursion Oracle Multimedia DICOM uses to evaluate recursive constraint macros during conformance validation. [Example 10-41](#) shows how to define this preference parameter in a preference document.

The `<PARAMETER>` element specifies the Oracle-defined preference parameter `MAX_RECURSION_DEPTH`.

The `<VALUE>` element represents the value of the `MAX_RECURSION_DEPTH` preference parameter. Valid values are integers from 1 to 32767. The default is 16. If the recursion level exceeds the value of this parameter, an exception is thrown.

See [Defining Recursive Constraint Macros](#) for more information about recursive constraint macros.

#### Example 10-41 Definition of the MAX\_RECURSION\_DEPTH Preference Parameter

```
<PREFERENCE_DEF>
  <PARAMETER>MAX_RECURSION_DEPTH</PARAMETER>
  <DESCRIPTION>
    The maximum level of recursion when evaluating a recursive constraint
    during conformation validation.
  </DESCRIPTION>
  <VALUE>16</VALUE>
</PREFERENCE_DEF>
```

### 10.2.5.7 Defining the SPECIFIC\_CHARACTER\_SET Preference Parameter

The `SPECIFIC_CHARACTER_SET` preference parameter is used to specify the character set Oracle Multimedia DICOM uses to decode certain data elements (those with value representations of SH, LO, ST, LT, PN, and UT) when the standard attribute Specific Character Set is not specified. [Example 10-42](#) shows how to define this preference parameter in a preference document.

The <PARAMETER> element specifies the Oracle-defined preference parameter `SPECIFIC_CHARACTER_SET`.

The <VALUE> element represents the value of the `SPECIFIC_CHARACTER_SET` preference parameter. Valid values include these character sets:

- ASCII (default value)
- ISO\_IR 100
- ISO\_IR 101
- ISO\_IR 109
- ISO\_IR 110
- ISO\_IR 144
- ISO\_IR 127
- ISO\_IR 126
- ISO\_IR 138
- ISO\_IR 148
- ISO\_IR 13
- ISO IR 166
- ISO\_IR 192
- GB18030

The value of this preference parameter determines how data elements with value representations of SH (Short String), LO (Long String), ST (Short Text) LT (Long Text), PN (Person Name), and UT (Unlimited Text) are decoded when the standard attribute `Specific Character Set (0008,0005)` is missing. The DICOM standard mandates using the default character set ISO-IR 6 or ASCII for decoding when the standard attribute `Specific Character Set` is not specified. This preference parameter enables applications to specify a character set other than the DICOM standard default character set in these cases.

#### Example 10-42 Definition of the `SPECIFIC_CHARACTER_SET` Preference Parameter

```
<PREFERENCE_DEF>
  <PARAMETER>SPECIFIC_CHARACTER_SET</PARAMETER>
  <DESCRIPTION>
    Use the ASCII character set to decode data elements SH (Short String),
    LO (Long String), ST (Short Text), LT (Long Text), PN (Person Name),
    and UT (Unlimited Text) when the Specific Character Set Attribute is
    missing.
  </DESCRIPTION>
  <VALUE>ASCII</VALUE>
</PREFERENCE_DEF>
```

### 10.2.5.8 Defining the `SQ_WRITE_LEN` Preference Parameter

The `SQ_WRITE_LEN` preference parameter is used to specify how the method `writeMetadata()` encodes DICOM sequence (SQ) types. [Example 10-43](#) shows how to define this preference parameter in a preference document.

The `<PARAMETER>` element specifies the Oracle-defined preference parameter `SQ_WRITE_LEN`.

The `<VALUE>` element represents the value of the `SQ_WRITE_LEN` preference parameter, which is `true` by default.

The value of this preference parameter specifies how the DICOM sequence (SQ) types are encoded by the method `writeMetadata()`. See the [writeMetadata\(\)](#) method for more information.

If the value of this preference parameter is `true`, the SQ types are encoded with explicit lengths and without item or sequence delimiters. This default behavior enables DICOM viewers to skip the sequence attributes.

If the value is set to `false`, the SQ types are encoded with variable (undefined) lengths and terminated with sequence delimiters. This option enables backward compatibility with older DICOM viewers and DICOM applications that support only undefined lengths for SQ types.

#### Example 10-43 Definition of the `SQ_WRITE_LEN` Preference Parameter

```
<PREFERENCE_DEF>
  <PARAMETER>SQ_WRITE_LEN</PARAMETER>
  <DESCRIPTION>
    All sequence types are encoded in XML with an explicit length and
    without sequence delimiters.
  </DESCRIPTION>
  <VALUE>true</VALUE>
</PREFERENCE_DEF>
```

### 10.2.5.9 Defining the `VALIDATE_METADATA` Preference Parameter

The `VALIDATE_METADATA` preference parameter is used to specify whether to validate XML documents that are used in DICOM functions and procedures. [Example 10-44](#) shows how to define this preference parameter in a preference document.

The `<PARAMETER>` element specifies the Oracle-defined preference parameter `VALIDATE_METADATA`.

The `<VALUE>` element represents the value of the preference parameter `VALIDATE_METADATA`, which is `false` by default.

The value of this preference parameter determines whether to validate the XML documents used in the DICOM functions and procedures. All XML documents used in the DICOM functions and procedures, except those that are generated by the method `extractMetadata()`, are validated against the Oracle default DICOM metadata schema. The XML documents generated by the method `extractMetadata()` are validated against the XML schema whose namespace is defined in the specified mapping document. See the [extractMetadata\(\)](#) method and [Characteristics of Mapping Documents](#) for more information.

If the value of this preference parameter is `false`, the XML documents are not validated.

If the value is set to `true`, the XML documents are validated against a specific XML schema that is registered with Oracle XML DB. However, if the metadata namespace in the mapping document is not available to the current user, invoking the `extractMetadata()` method with this value set to `true` raises an error.

**Example 10-44 Definition of the VALIDATE\_METADATA Preference Parameter**

```

<PREFERENCE_DEF>
  <PARAMETER>VALIDATE_METADATA</PARAMETER>
  <DESCRIPTION>
    Do not validate XML metadata documents.
  </DESCRIPTION>
  <VALUE>>false</VALUE>
</PREFERENCE_DEF>

```

### 10.2.5.10 Defining the XML\_SKIP\_ATTR Preference Parameter

The XML\_SKIP\_ATTR preference parameter is used to specify size limits for DICOM attributes to omit when encoding into XML. [Example 10-45](#) shows how to define this preference parameter in a preference document.

The <PARAMETER> element specifies the Oracle-defined preference parameter XML\_SKIP\_ATTR.

The <VALUE> element represents the value of the XML\_SKIP\_ATTR preference parameter. Valid values are integers from 128 to  $2^{32}-1$ . The default is 512.

The value of this preference parameter is used to specify size limits for DICOM attributes to be omitted when encoding into XML. Omit DICOM attributes whose size (in bytes) in the DICOM content is larger than the value of this preference parameter. If an attribute of type SQ is omitted, its child items are also omitted.

In addition, the value of this preference parameter affects the following:

- The metadata generated by the method `extractMetadata()`. See the [extractMetadata\(\)](#) method for more information.
- The behavior of the `setProperties()` method. See the [setProperties\(\)](#) method for more information.

**Example 10-45 Definition of the XML\_SKIP\_ATTR Preference Parameter**

```

<PREFERENCE_DEF>
  <PARAMETER>XML_SKIP_ATTR</PARAMETER>
  <DESCRIPTION>
    When encoding DICOM attributes into XML, omit the DICOM attributes
    with sizes larger than 512 bytes.
  </DESCRIPTION>
  <VALUE>512</VALUE>
</PREFERENCE_DEF>

```

## 10.2.6 Creating Private Dictionary Documents

Private dictionary documents are XML documents that list the attributes defined by modality manufacturers or organizations other than the DICOM Standards Committee.

Private organizations or manufacturers of modalities can include attributes that are specific to their particular organizations in their DICOM content. These private attributes must be defined in a private dictionary document and stored in the data model repository to enable Oracle Multimedia to process metadata associated with the private attributes in the DICOM content.

The XML schema `ordcmpv.xsd` defines the XML schema that constrains private dictionary documents. (See [DICOM XML Schemas](#) for more information about this schema.)

The default private dictionary document `ordcmpv.xml` lists the private attributes defined by Oracle. (See [DICOM Configuration Documents](#) for more information about this configuration document.)

The XML schema `ordcmrdt.xsd` defines the DICOM standard data types and Oracle extensions to those data types, which are used by all other DICOM XML schemas. (See [DICOM XML Schemas](#) for more information about this schema.)

The following subsections contain examples that show how to create private dictionary documents:

- [Defining Private Attributes](#)
- [Defining Attribute Definers](#)
- [Retiring Private Attributes](#)

### 10.2.6.1 Defining Private Attributes

The private attribute definition in the private dictionary permits three types of attribute tags: simple tags, wildcard tags, and range tags. An attribute tag value consists of the group number followed by an element number.

A simple attribute tag is 4-byte hexadecimal number that consists of a group number followed by an element number (for example: `10871100`).

A wildcard attribute tag represents a set of hexadecimal numbers. It also consists of a group number followed by an element number, where portions of the value are replaced by the character `x` or `X` (for example: `1087xx00`).

A range attribute tag represents a range of hexadecimal numbers. It consists of two simple attribute tags that define a range of values. The starting range value must be less than the ending range value.

Each private attribute in the private dictionary document is represented by a `<PRIVATE_ATTRIBUTE_DEFINITION>` element.

#### Note:

Keep these additional guidelines in mind:

- Do not use wildcard attribute tags within range attribute tags.
- The definer name "DICOM" and the UID "1.2.840.10008.1" are reserved by Oracle to refer to DICOM standard attributes. Do not use them in private dictionaries.
- Oracle recommends associating all DICOM private attributes in the DICOM content with a UID-qualified name.
- The value of a tag-definer pair must be unique within the private dictionary document.

#### Defining a Private Attribute Using a Simple Attribute Tag

[Example 10-46](#) shows how to define a private attribute with a simple attribute tag. The XML statements where this action is defined are highlighted in bold.

In [Example 10-46](#), the `<TAG>` element represents the hexadecimal value of the attribute tag `FFFF1001`. The `<NAME>` element represents the name of the organization defining the tag, `ORACLE`. The `<VR>` element represents the value representation of the attribute tag. The `<VR>` element is defined as type `VR_T` in the XML schema `ordcmrdt.xsd`. The `<VR>` element value must be one of the values that are listed for type `<VR_T>` in the XML schema `ordcmrdt.xsd`. The `<VM>` element represents the value multiplicity of the attribute tag. The `<VM>` element is defined as type `VM_T` in the XML schema `ordcmrdt.xsd`. The `<VM>` element value must be one of the values listed for type `VM_T` in the XML schema `ordcmrdt.xsd`. (See the type `<VR_T>` and the type `<VM_T>` listed in the XML schema `ordcmrdt.xsd` for more information about the value representation and value multiplicity data types supported by Oracle Multimedia DICOM.)

### Defining a Private Attribute Using a Wildcard Attribute Tag

[Example 10-47](#) shows how to define a private attribute with a wildcard attribute tag. The XML statements where this action is defined are highlighted in bold.

In [Example 10-47](#), the private attribute definition contains the wildcard tag `0119XX00` and the definer name `PRIVATE_ORG`.

### Defining a Private Attribute Using a Range Attribute Tag

[Example 10-48](#) shows how to define a private attribute with a range attribute tag. The XML statements where this action is defined are highlighted in bold.

In [Example 10-48](#), the private attribute definition contains a range tag that specifies all tag ranges from `A0110010` to `A01AAA10`. The definer name `1.2.840.423` is a UID value.

#### Note:

An attribute definition cannot match another attribute definition of the same tag-definer pair within a private dictionary document.

The following XML code segment shows an example of an attribute definition that is *not* permitted in the private dictionary:

```
<PRIVATE_ATTRIBUTE_DEFINITION>
  <TAG>0119XX00</TAG>
  <NAME>private tag</NAME>
  <DEFINER>PRIVATE_ORG</DEFINER>
  .
  .
  .
</PRIVATE_ATTRIBUTE_DEFINITION>

<PRIVATE_ATTRIBUTE_DEFINITION>
  <TAG>01191100</TAG>
  <NAME>private tag</NAME>
  <DEFINER>PRIVATE_ORG</DEFINER>
  .
  .
  .
</PRIVATE_ATTRIBUTE_DEFINITION>
```



In the preceding code segment, the tag-definer pair (01191100, PRIVATE\_ORG) matches the tag-definer pair (0119XX00, PRIVATE\_ORG).

#### Example 10-46 Definition of a Private Attribute with a Simple Attribute Tag

```
<PRIVATE_ATTRIBUTE_DEFINITION>
  <TAG>FFFF1001</TAG>
  <NAME>locator macro tag</NAME>
  <DEFINER>ORACLE</DEFINER>
  <VR>SQ</VR>
  <VM>1</VM>
</PRIVATE_ATTRIBUTE_DEFINITION>
```

#### Example 10-47 Definition of a Private Attribute with a Wildcard Attribute Tag

```
<PRIVATE_ATTRIBUTE_DEFINITION>
  <TAG>0119XX00</TAG>
  <NAME>PRIVATE_TAG1</NAME>
  <DEFINER>PRIVATE_ORG</DEFINER>
  <VR>IS</VR>
  <VM>1</VM>
</PRIVATE_ATTRIBUTE_DEFINITION>
```

#### Example 10-48 Definition of a Private Attribute with a Range Attribute Tag

```
<PRIVATE_ATTRIBUTE_DEFINITION>
  <TAG_RANGE>
    <dt:STARTING_TAG>A0110010</dt:STARTING_TAG>
    <dt:ENDING_TAG>A01AAA10</dt:ENDING_TAG>
  </TAG_RANGE>
  <NAME>Private Tag</NAME>
  <DEFINER>1.2.840.423</DEFINER>
  <VR>ST</VR>
  <VM>1</VM>
</PRIVATE_ATTRIBUTE_DEFINITION>
```

## 10.2.6.2 Defining Attribute Definers

An attribute definer refers to the definer name and UID of an organization defining private attributes.

The <ATTRIBUTE\_DEFINERS> element is an optional element that represents all private definer names and definer UIDs used in a private dictionary document.

### Note:

The definer name "DICOM" and the UID "1.2.840.10008.1" are reserved by Oracle to refer to DICOM standard attributes. Do not use them in private dictionaries.

The <ATTRIBUTE\_DEFINERS> element is of type ATTR\_DEFINERS\_T. This type is defined in the XML schema `ordcmrdt.xsd`.

[Example 10-49](#) shows how to define the definer name and UID for an organization that defines private attributes:

In [Example 10-49](#), the prefix `dt` is mapped to the namespace `http://xmlns.oracle.com/ord/dicom/datatype_1_0` where the `<ATTR_DEFINER>` element is defined. The value of the `<dt:NAME>` element represents the name of the private organization. The value of the `<dt:UID>` element represents the UID of the private organization.

#### Example 10-49 Definition of an Attribute Definer

```
<ATTRIBUTE_DEFINERS>
  <dt:ATTR_DEFINER>
    <dt:NAME>1.2.1234.12345.123456.2.0</dt:NAME>
    <dt:UID>1.2.1234.12345.123456.2.0</dt:UID>
  </dt:ATTR_DEFINER>
  <dt:ATTR_DEFINER>
    <dt:NAME>PRIVATE_ORG</dt:NAME>
    <dt:UID>1.2.123.1234</dt:UID>
  </dt:ATTR_DEFINER>
</ATTRIBUTE_DEFINERS>
```

### 10.2.6.3 Retiring Private Attributes

Private attributes included in private dictionary documents can be retired when they are no longer needed. [Example 10-50](#) shows how to define a private attribute as retired. The XML statement where this action is defined is highlighted in bold.

In [Example 10-50](#), for the `<RETIRED>` element, a value of `true` indicates that the attribute is retired and corresponds to the `RET` value used in the DICOM standard. Oracle recommends providing the `<VR>` and `<VM>` element values for a retired attribute to enable the metadata to be extracted from the DICOM content.

#### Example 10-50 Definition of a Private Attribute as Retired

```
<PRIVATE_ATTRIBUTE_DEFINITION>
  <TAG>01191100</TAG>
  <NAME>locator_macro_tag</NAME>
  <DEFINER>PRIVATE_ORG</DEFINER>
  <VR>SQ</VR>
  <VM>1</VM>
  <RETIRED>true</RETIRED>
</PRIVATE_ATTRIBUTE_DEFINITION>
```

## 10.2.7 Creating Standard Dictionary Documents

Standard dictionary documents are XML representations of the data dictionary defined by the DICOM standard.

The XML schema `ordcmsd.xsd` defines the XML schema that constrains standard dictionary documents. (See [DICOM XML Schemas](#) for more information about this schema. The text within the `<xs:annotation>` element includes a detailed description of the schema elements.)

The default standard dictionary document `ordcmsd.xml` is an XML representation of the data dictionary, as defined in Part 6 of the DICOM standard. (See [DICOM Configuration Documents](#) for more information about this configuration document.)

The XML schema `ordcmrdt.xsd` defines the DICOM standard data types and Oracle extensions to those data types, which are used by all other DICOM XML schemas. (See [DICOM XML Schemas](#) for more information about this schema.)

 **Note:**

Standard dictionary documents must not include any other attributes, such as attributes defined by manufacturers of modalities or organizations other than the DICOM Standards Committee.

Through the Oracle Technology Network, Oracle may release new standard dictionary documents along with installation instructions for DICOM administrators. These new standard dictionary documents reflect new releases of, or addendums to, the DICOM standard.

The following subsections contain examples that show how to create standard dictionary documents:

- [Defining Standard Attributes](#)
- [Retiring Standard Attributes](#)

### 10.2.7.1 Defining Standard Attributes

The standard attribute definition in the standard dictionary permits two types of attribute tags: simple tags and wildcard tags. An attribute tag value consists of the group number followed by an element number.

A simple attribute tag is 4-byte hexadecimal number that consists of a group number followed by an element number (for example: 10871100).

A wildcard attribute tag represents a set of hexadecimal numbers. It also consists of a group number followed by an element number, where portions of the value are replaced by the character `x` or `X` (for example: 1087xx00).

Each standard attribute in the standard dictionary document is represented by a `<STANDARD_ATTRIBUTE_DEFINITION>` element. Each standard attribute listed in the XML document corresponds to a related tag that is defined in Part 6 of the DICOM standard.

 **Note:**

The definer name "DICOM" and the UID "1.2.840.10008.1" are reserved by Oracle to refer to DICOM standard attributes.

#### Defining a Standard Attribute Using a Simple Attribute Tag

[Example 10-51](#) shows how to define a standard attribute with a simple attribute tag. The XML statements where this action is defined are highlighted in bold.

In [Example 10-51](#), the `<TAG>` element represents the hexadecimal value of the attribute tag 00080008, which is defined by the DICOM standard. This attribute tag value consists of a group number, followed by an element number. The `<NAME>` element represents the name of the attribute tag that is defined by the DICOM standard. The `<VR>` element represents the value representation of the attribute tag that is defined by the DICOM standard. The `<VM>` element represents the value multiplicity of the

attribute tag defined by the DICOM standard. (See the type <VR\_T> and the type <VM\_T> listed in the XML schema `ordcmrdt.xsd` for more information about the value representation and value multiplicity data types supported by Oracle Multimedia DICOM.)

### Defining a Standard Attribute Using a Wildcard Attribute Tag

[Example 10-52](#) shows how to define a standard attribute with a wildcard attribute tag. The XML statements where this action is defined are highlighted in bold.

In [Example 10-52](#), the standard attribute definition contains the wildcard tag `60xx0010`.

### Example 10-51 Definition of a Standard Attribute with a Simple Attribute Tag

```
<STANDARD_ATTRIBUTE_DEFINITION>
  <TAG>00080008</TAG>
  <NAME>Image Type</NAME>
  <VR>CS</VR>
  <VM>1-n</VM>
</STANDARD_ATTRIBUTE_DEFINITION>
```

### Example 10-52 Definition of a Standard Attribute with a Wildcard Attribute Tag

```
<STANDARD_ATTRIBUTE_DEFINITION>
  <TAG>60xx0010</TAG>
  <NAME>Overlay Rows</NAME>
  <VR>US</VR>
  <VM>1</VM>
</STANDARD_ATTRIBUTE_DEFINITION>
```

## 10.2.7.2 Retiring Standard Attributes

Standard attributes included in the standard dictionary document are retired in the DICOM standard when they are no longer needed. [Example 10-53](#) shows the definition of a standard attribute as retired. The XML statement where this action is defined is highlighted in bold.

In [Example 10-53](#), for the <RETIRED> element a value of `true` indicates that the attribute is retired and corresponds to the `RET` value used in the DICOM standard. Oracle recommends providing the <VR> and <VM> element values for a retired attribute to enable the metadata to be extracted from the DICOM content.

### Example 10-53 Definition of a Standard Attribute As Retired

```
<STANDARD_ATTRIBUTE_DEFINITION>
  <TAG>00080010</TAG>
  <NAME>Recognition Code</NAME>
  <VR>CS</VR>
  <VM>1</VM>
  <RETIRED>true</RETIRED>
</STANDARD_ATTRIBUTE_DEFINITION>
```

## 10.2.8 Creating Stored Tag List Documents

Stored tag list documents specify the DICOM attributes to be extracted from the embedded DICOM content and stored in the XML metadata attribute of the ORDDicom object when the `setProperties()` method is called. The XML schema `ordcmstl.xsd` defines the XML schema that constrains stored tag list documents. (See [DICOM XML Schemas](#) for more information about this schema.)

Generally, stored tag list documents contain the attribute tags used in mapping and constraint documents. Each attribute tag value in a stored tag list document is defined by an `<ATTRIBUTE_TAG>` element.

Oracle recommends using the [generateTagListDocument\(\) Function](#) to create a stored tag list document. For example, a stored tag list might include some tags shown in the following code segment:

```
<ATTRIBUTE_TAG>00080008[3]</ATTRIBUTE_TAG>
<ATTRIBUTE_TAG>00081155(DICOM)</ATTRIBUTE_TAG>
<ATTRIBUTE_TAG>00082112.00081150</ATTRIBUTE_TAG>
<ATTRIBUTE_TAG>00082112.0040A170.00080104</ATTRIBUTE_TAG>
<ATTRIBUTE_TAG>0040A730.0040A123[1]#PersonName</ATTRIBUTE_TAG>
<ATTRIBUTE_TAG>0040A730[2].0040A160</ATTRIBUTE_TAG>
```

See [Sample Session 4: Inserting a Stored Tag List Document](#) for examples of generating and inserting stored tag list documents into the repository. See [Task 10: Improve Storage When Extracting DICOM Attributes](#) for information about using a stored tag list to extract specific attributes from DICOM content.

## 10.2.9 Creating UID Definition Documents

UID definition documents are XML representations of the unique identifiers (UIDs) defined by the DICOM standard. The UID definitions are used by Oracle Multimedia DICOM to parse the DICOM content.

The XML schema `ordcmui.xsd` defines the XML schema that constrains UID definition documents. (See [DICOM XML Schemas](#) for more information about this schema. The text within the `<xs:annotation>` element includes a detailed description of the attributes used in the schema.)

The default UID definition document `ordcmui.xml` includes the UIDs listed in Part 6 of the DICOM standard.

Within a UID definition document, a `<UID_DEF>` element is used to define each UID definition.

### Note:

Keep these additional guidelines in mind:

- A maximum of two (one Oracle-defined and one user-defined) UID definition documents are permitted in the repository.
- Changes in user-defined UID definition documents must be limited to updates in the DICOM standard or additions of new UID values. See Part 5 of the DICOM standard for more information about creating privately defined unique identifiers.
- Existing UIDs defined by the DICOM standard can be changed *only* to include updates in the DICOM standard.

The following subsections contain examples that show how to create UID definitions in UID definition documents:

- [Defining UID Definitions](#)

- [Retiring UID Definitions](#)

### 10.2.9.1 Defining UID Definitions

[Example 10-54](#) shows how to define a storage class UID definition. The XML statements where this action is defined are highlighted in bold.

In [Example 10-54](#), the <UID> element value 1.2.840.10008.5.1.4.1.1.2 represents a UID value that is defined by the DICOM standard. The <NAME> element value CT Image Storage represents the UID name that is defined by the DICOM standard. The value of the classification attribute "storageClass" in the <UID\_DEF> element corresponds to the UID type SOP Class defined by the DICOM standard. The value of the contentType attribute "image" indicates that the DICOM content contains pixel data.

#### Example 10-54 Definition of a Storage Class UID Definition

```
<UID_DEF classification="storageClass" contentType="image">  
  <UID>1.2.840.10008.5.1.4.1.1.2</UID>  
  <NAME>CT Image Storage</NAME>  
</UID_DEF>
```

### 10.2.9.2 Retiring UID Definitions

[Example 10-55](#) shows how to define a UID definition for transfer syntax as retired. The XML statements where this action is defined are highlighted in bold.

In [Example 10-55](#), the <UID> element value 1.2.840.10008.1.2.4.52 represents a UID value that is defined by the DICOM standard. The <NAME> element value JPEG Extended (Process 3 and 5) (Retired) represents the UID name that is defined by the DICOM standard. The value of the classification attribute "transferSyntax" corresponds to the UID type Transfer Syntax defined by the DICOM standard. The values of the attributes isCompressed, isEVR (explicit VR), and isLE (little endian) are derived from the transfer syntax definitions listed in Part 5 of the DICOM standard. The value of the retired attribute "true" indicates that this UID definition is retired.

#### Example 10-55 Definition of a UID Definition as Retired

```
<UID_DEF classification="transferSyntax" isCompressed="true" isEVR="true"  
  isLE="true" retired="true">  
  <UID>1.2.840.10008.1.2.4.52</UID>  
  <NAME>JPEG Extended (Process 3 and 5) (Retired)</NAME>  
</UID_DEF>
```

# 11

## Administering the DICOM Repository

This chapter uses code examples to show how to manage configuration documents in the DICOM data model repository. The code examples are written in PL/SQL to match the ORD\_DICOM\_ADMIN package, which is provided in PL/SQL only.

Oracle Multimedia DICOM provides capabilities for several administrative operations related to the data model repository. For example, administrators can review the Oracle-defined configuration documents in the DICOM data model repository before determining whether to add custom configuration documents for a particular organization (Steps 2 and 4 in [Sample Session 2: Updating a Mapping Document](#) describe this process). Using views or invoking data model utility functions, administrators can obtain attributes and other detailed information about these configuration documents. Working with the procedures and functions in the ORD\_DICOM\_ADMIN package, administrators can insert, update, export, or delete configuration documents from the repository. Administrators of the DICOM data model repository are assigned the ORDADMIN role.

This chapter includes these sections:

- [Sample Session 1: Inserting Two Documents](#)
- [Sample Session 2: Updating a Mapping Document](#)
- [Sample Session 3: Deleting a Constraint Document](#)
- [Sample Session 4: Inserting a Stored Tag List Document](#)
- [Sample Session 5: Inserting a DICOM Protocol Document](#)

### See Also:

- [ORD\\_DICOM\\_ADMIN Package Reference](#) for reference information about the ORD\_DICOM\_ADMIN package
- *Oracle Multimedia* on the Oracle Technology Network Web site for additional examples, articles, and other information

### 11.1 Sample Session 1: Inserting Two Documents

The following sample session shows the steps for inserting a mapping document and a constraint document into the repository. This sample assumes that the following prerequisite tasks have been completed:

- The directory object (DICOMDIR) has been created, and the administrator has been granted READ access.
- The metadata schema associated with the mapping document has been registered with Oracle XML DB as a global or local XML schema.

**See Also:**

*Oracle XML DB Developer's Guide* for more information about registering XML schemas

Perform the following steps to insert a mapping document and a constraint document into the repository:

**Step 1 Edit the Data Model**

Prepare the data model for editing and lock it to prevent other administrators from making changes at the same time. For example:

```
exec ord_dicom_admin.editDataModel();
```

The data model remains locked until you publish the changes, perform a rollback operation, or exit the session.

Optionally, you can enter the following command to query the `orddcm_documents` view:

```
select * from orddcm_documents order by doc_id asc;
```

Review the list of documents.

**Step 2 Insert the New Documents**

First, insert the sample mapping document (`sample_map.xml`), as follows:

```
exec ord_dicom_admin.insertDocument('sample_map.xml', 'MAPPING',  
  xmltype(bfilename('DICOmdir', 'sample_map.xml'), nls_charset_id('AL32UTF8')));
```

See [Example 2-1](#) for the sample mapping document (`sample_map.xml`).

Then, insert the sample constraint document (`sample_ct.xml`), as follows:

```
exec ord_dicom_admin.insertDocument('sample_ct.xml', 'CONSTRAINT',  
  xmltype(bfilename('DICOmdir', 'sample_ct.xml'), nls_charset_id('AL32UTF8')));
```

See [Example 2-3](#) for the sample constraint document (`sample_ct.xml`).

Optionally, you can enter the following command to query the `orddcm_documents` view:

```
select * from orddcm_documents order by doc_id asc;
```

Review the list of documents to ensure that the inserted documents appear.

As another option, you can query the `orddcm_document_refs` view, and then review the document references, as follows:

```
select * from orddcm_document_refs order by doc_name, ref_by_doc_name asc;
```

At this point, you can run administrative tests as needed. In addition, you can call the `rollbackDataModel()` procedure to terminate the operation without publishing the changes. Or, you can continue with the next step.

**Step 3 Publish the Changes**

Publish the changes and unlock the data model, as follows:

```
exec ord_dicom_admin.publishDataModel();
```



The data model includes the inserted configuration documents.

## 11.2 Sample Session 2: Updating a Mapping Document

The following sample session shows the steps for updating a mapping document in the repository. This sample assumes that the following prerequisite tasks have been completed:

- The directory object (`DICOMDIR`) has been created, and the administrator has been granted `READ` and `WRITE` access.
- The referenced metadata schema associated with the mapping document has been registered with Oracle XML DB as a global or local XML schema.

See *Oracle XML DB Developer's Guide* for information about registering XML schemas.

Perform the following steps to update a mapping document in the repository:

### Step 1 Edit the Data Model

As in [Sample Session 1: Inserting Two Documents](#), prepare the data model for editing and lock it to prevent other administrators from making changes at the same time. For example:

```
exec ord_dicom_admin.editDataModel();
```

The data model remains locked until you publish the changes, perform a rollback operation, or exit the session.

Optionally, you can enter the following command to query the `orddcm_documents` view:

```
select * from orddcm_documents order by doc_id asc;
```

Review the list of documents.

### Step 2 Export the Existing Document

Export the sample mapping document (`sample_map.xml`) from the repository into a specified file (`sample_map_export.xml`) for editing. For example:

```
exec ord_dicom_admin.exportDocument('sample_map.xml', 'DICOMDIR',  
  'sample_map_export.xml');
```

See [Example 2-1](#) for the sample mapping document (`sample_map.xml`).

The `sample_map_export.xml` file is available for editing with an XML editor.

### Step 3 Delete the Existing Document

Delete the existing mapping document (`sample_map.xml`) from the repository, as follows:

```
exec ord_dicom_admin.deleteDocument('sample_map.xml');
```

The repository no longer includes the sample mapping document.

Optionally, you can enter the following command to query the `orddcm_documents` view:

```
select * from orddcm_documents order by doc_id asc;
```

Review the list of documents to ensure that the deleted document no longer appears.

**Step 4 Edit the Exported Document**

Use an XML editor to edit the file that was exported in Step 2. Then, save the changes and check the permissions on the file before inserting it into the repository.

**Step 5 Insert the Edited Document**

Insert the edited document (`sample_map_edited.xml`) into the repository, as follows:

```
exec ord_dicom_admin.insertDocument('sample_map_edited.xml', 'MAPPING',
  xmltype(bfilename('DICOMDIR', 'sample_map_edited.xml'),
  nls_charset_id('AL32UTF8')));
```

Optionally, you can enter the following command to query the `orddcm_documents` view:

```
select * from orddcm_documents order by doc_id asc;
```

Review the list of documents to ensure that the updated document appears. At this point, you can test your changes, run the `extractMetadata()` method on the edited mapping document to retrieve metadata from the embedded DICOM content as XML code, and then store it in a database table for searching or viewing. In addition, you can call the `rollbackDataModel()` procedure to terminate the operation without publishing the changes. Or, you can continue with the next step.

**Step 6 Publish the Changes**

As in [Sample Session 1: Inserting Two Documents](#), publish the changes and unlock the data model, as follows:

```
exec ord_dicom_admin.publishDataModel();
```

The data model includes the updated configuration document.

## 11.3 Sample Session 3: Deleting a Constraint Document

The following sample session shows the steps for deleting a constraint document from the repository. This sample assumes that the following prerequisite task has been completed:

The directory object (`DICOMDIR`) has been created, and the administrator has been granted `WRITE` access.

Perform the following steps to delete a constraint document from the repository:

**Step 1 Edit the Data Model**

As in [Sample Session 1: Inserting Two Documents](#), prepare the data model for editing and lock it to prevent other administrators from making changes at the same time. For example:

```
exec ord_dicom_admin.editDataModel();
```

The data model remains locked until you publish the changes, perform a rollback operation, or exit the session.

Optionally, you can enter the following command to query the `orddcm_documents` view:

```
select * from orddcm_documents order by doc_id asc;
```

Review the list of documents.

**Step 2 Export the Existing Document (Optional and Recommended)**

Export the sample constraint document (`sample_ct.xml`) from the repository into a specified file (`sample_ct_export.xml`) for editing. For example:

```
exec ord_dicom_admin.exportDocument('sample_ct.xml', 'DICOMDIR',
'sample_ct_export.xml');
```

See [Example 2-3](#) for the sample constraint document (`sample_ct.xml`).

Optionally, you can enter the following command to query the `orddcm_document_refs` view, which shows the list of documents that are referenced by other documents in the repository:

```
select * from orddcm_document_refs order by doc_name, ref_by_doc_name asc;
```

Review the list of documents to check the references for the constraint document that you intend to delete.

**Step 3 Delete the Document**

Delete the sample constraint document (`sample_ct.xml`), as follows:

```
exec ord_dicom_admin.deleteDocument('sample_ct.xml');
```

The repository no longer includes the sample constraint document.

Optionally, you can enter the following command to query the `orddcm_documents` view:

```
select * from orddcm_documents order by doc_id asc;
```

Review the list of documents to ensure that the deleted document no longer appears. At this point, you can call the `rollbackDataModel()` procedure to terminate the operation without publishing the changes. Or, you can continue with the next step.

**Step 4 Publish the Changes**

Publish the changes and unlock the data model, as follows:

```
exec ord_dicom_admin.publishDataModel();
```

The data model does not include the deleted configuration document.

## 11.4 Sample Session 4: Inserting a Stored Tag List Document

This section describes two different approaches you can take to insert a stored tag list document into the repository:

- [Inserting a Stored Tag List Document with a Known Set of Tags](#) describes how to insert a stored tag list document with a known set of attribute tags.

Follow the example in this section to create, and then insert, your own stored tag list document if you believe that you know the full set of attribute tags that all the constraint and mapping documents in your repository are likely to use.

- [Generating and Inserting a Stored Tag List Document](#) describes how to generate and insert a stored tag list document from an existing repository that is populated with constraint and mapping documents.

Follow the examples in this section if you have an existing repository and want to generate, and then insert, a stored tag list document from tags used by your existing constraint and mapping documents.

Select the appropriate approach to take advantage of the storage and performance benefits of the stored tag list feature.

The following subsections describe each approach:

- [Inserting a Stored Tag List Document with a Known Set of Tags](#)
- [Generating and Inserting a Stored Tag List Document](#)

## 11.4.1 Inserting a Stored Tag List Document with a Known Set of Tags

You can create your own stored tag list document, and then insert it into the repository. Include all the attribute tags to be defined in the constraint and mapping documents in the repository in your document. [Example 11-1](#) is a sample file (`sample_stl.xml`) that you can insert as the stored tag list document.

This approach assumes that the following prerequisite task has been completed:

The directory object (`DICOMDIR`) has been created, and the administrator has been granted READ access.

Perform the following steps to insert a stored tag list document with a known set of attribute tags into the repository:

### Step 1 Edit the Data Model

As in [Sample Session 1: Inserting Two Documents](#), prepare the data model for editing and lock it to prevent other administrators from making changes at the same time. For example:

```
exec ord_dicom_admin.editDataModel();
```

The data model remains locked until you publish the changes, perform a rollback operation, or exit the session.

At this point, to see which documents are stored in the repository, enter the following command to query the `orddcm_documents` view:

```
select doc_name from orddcm_documents order by doc_id asc;
```

### Step 2 Insert the Stored Tag List Document

Insert the sample stored tag list document file (`sample_stl.xml`), as follows:

```
exec ord_dicom_admin.insertDocument(
    'sample_stl.xml',
    'STORED_TAG_LIST',
    xmltype(bfilename('DICOMDIR', 'sample_stl.xml'),
    nls_charset_id('AL32UTF8') ) );
```

### Step 3 Publish the Changes

Publish the changes and unlock the data model, as follows:

```
exec ord_dicom_admin.publishDataModel;
```

The data model includes the inserted configuration documents.

**Example 11-1 Inserting a Stored Tag List Document with Known Attribute Tags**

```

<?xml version="1.0" encoding="UTF-8"?>
<!--
Copyright (c) 2008, Oracle. All rights reserved.

NAME
sample_stl.xml - sample stored tag list

-->
<ATTRIBUTE_TAG_LIST xmlns="http://xmlns.oracle.com/ord/dicom/attributeTag_1_0"
xmlns:dt="http://xmlns.oracle.com/ord/dicom/datatype_1_0"
xmlns:xsi="http://www.w3.org/2001/XMLSchema-instance"
xsi:schemaLocation="http://xmlns.oracle.com/ord/dicom/attributeTag_1_0
http://xmlns.oracle.com/ord/dicom/attributeTag_1_0">
  <DOCUMENT_HEADER>
    <dt:DOCUMENT_CHANGE_LOG>
      <dt:DOCUMENT_MODIFIER>ORACLE</dt:DOCUMENT_MODIFIER>
      <dt:DOCUMENT_MODIFICATION_DATE>2009-02-25</dt:DOCUMENT_MODIFICATION_DATE>
      <dt:DOCUMENT_VERSION>1.0</dt:DOCUMENT_VERSION>
    </dt:DOCUMENT_CHANGE_LOG>
  </DOCUMENT_HEADER>
  <ATTRIBUTE_TAG>00020002</ATTRIBUTE_TAG>
  <ATTRIBUTE_TAG>00020003</ATTRIBUTE_TAG>
  <ATTRIBUTE_TAG>00100010</ATTRIBUTE_TAG>
</ATTRIBUTE_TAG_LIST>

```

## 11.4.2 Generating and Inserting a Stored Tag List Document

If you have an existing repository that is populated with constraint and mapping documents, you can generate a stored tag list document from tags used by your existing constraint and mapping documents, make changes to the tags as needed, and insert the stored tag list document into the repository.

To enforce specific rules for the attributes you want to include in your stored tag list, insert a preference document that defines those attribute rules. [Example 11-2](#) shows a preference document (`sample_pf.xml`) that enforces the mandate attribute tags rule for mapping and constraint documents. The code statements where this operation is performed are highlighted in bold.

Because the value of the `MANDATE_ATTR_TAGS_IN_STL` parameter is set to `true`, all the tags used by the constraint and mapping documents are listed in the stored tag list document. See [Defining the MANDATE\\_ATTR\\_TAGS\\_IN\\_STL Preference Parameter](#) for more information about defining this parameter in preference documents.

This approach assumes that the following prerequisite task has been completed:

The directory object (`DICOMDIR`) has been created, and the administrator has been granted `READ` and `WRITE` access.

Perform the following steps to generate and insert a stored tag list document into the repository:

**Step 1 Edit the Data Model**

As in [Sample Session 1: Inserting Two Documents](#), prepare the data model for editing and lock it to prevent other administrators from making changes at the same time. For example:

```
exec ord_dicom_admin.editDataModel();
```

The data model remains locked until you publish the changes, perform a rollback operation, or exit the session. Optionally, you can enter the following command to query the `orddcm_documents` view:

```
select doc_name from orddcm_documents order by doc_id asc;
```

Review the list of documents to see which documents exist in your repository.

### Step 2 Generate and Export the Stored Tag List Document to a File

Generate and export the stored tag list document to the sample stored tag list document file (`sample_stl.xml`), as shown in [Example 11-3](#):

### Step 3 Optional: Edit the Stored Tag List Document

Use an XML editor to edit the stored tag list document file that was exported in Step 2. Make changes to the tags as needed, save the changes, and check the permissions on the file before inserting it into the repository.

### Step 4 Insert the Stored Tag List Document

Insert the generated stored tag list document (`sample_stl.xml`), as follows:

```
ord_dicom_admin.insertDocument(  
    'sample_stl.xml',  
    'STORED_TAG_LIST',  
    xmltype(bfilename('DICOMDIR', 'sample_stl.xml'),  
    nls_charset_id('AL32UTF8') ) );
```

### Step 5 Optional: Enforce the Mandate Attribute Tags Rule

To enforce the mandate attribute tags rule, insert a preference document with the value of the `MANDATE_ATTR_TAGS_IN_STL` parameter set to `true`, as follows:

```
exec ord_dicom_admin.insertDocument(  
    'sample_pf.xml',  
    'PREFERENCE',  
    xmltype(bfilename('DICOMDIR', 'sample_pf.xml'),  
    nls_charset_id('AL32UTF8') ) );
```

See [Example 11-2](#) for a sample preference document that enforces this rule.

#### Note:

If the `MANDATE_ATTR_TAGS_IN_STL` parameter is set to `true` in your preference document, and you attempt to insert any mapping or constraint documents that contain tags that are not listed in your stored tag list document, those documents are not inserted into the repository. See [Defining the MANDATE\\_ATTR\\_TAGS\\_IN\\_STL Preference Parameter](#) for more information about this preference parameter.

Optionally, you can enter the following command to query the `orddcm_documents` view:

```
select * from orddcm_documents order by doc_id asc;
```

Review the list of documents.

**Step 6 Publish the Changes**

Publish the changes and unlock the data model, as follows:

```
exec ord_dicom_admin.publishDataModel;
```

**Example 11-2 Sample Preference Document for the Mandate Attribute Tags Rule**

```
<?xml version="1.0" encoding="UTF-8"?>
<DICOM_RUNTIME_PREFERENCES xmlns="http://xmlns.oracle.com/ord/dicom/preference_1_0"
  xmlns:dt="http://xmlns.oracle.com/ord/dicom/datatype_1_0"
  xmlns:xsi="http://www.w3.org/2001/XMLSchema-instance"
  xsi:schemaLocation="http://xmlns.oracle.com/ord/dicom/preference_1_0
  http://xmlns.oracle.com/ord/dicom/preference_1_0">
<DOCUMENT_HEADER>
<dt:DOCUMENT_CHANGE_LOG>
  <dt:DOCUMENT_MODIFIER>Developer 1</dt:DOCUMENT_MODIFIER>
  <dt:DOCUMENT_MODIFICATION_DATE>2009-02-20</dt:DOCUMENT_MODIFICATION_DATE>
  <dt:DOCUMENT_VERSION>0.2</dt:DOCUMENT_VERSION>
  <dt:MODIFICATION_COMMENT> enable MANDATE_ATTR_TAGS_IN_STL</dt:MODIFICATION_COMMENT>
</dt:DOCUMENT_CHANGE_LOG>
</DOCUMENT_HEADER>
<PREFERENCE_DEF>
<PARAMETER>MANDATE_ATTR_TAGS_IN_STL</PARAMETER>
<DESCRIPTION> allowed values true or false</DESCRIPTION>
<VALUE>true</VALUE>
</PREFERENCE_DEF>
</DICOM_RUNTIME_PREFERENCES>
```

**Example 11-3 Generating and Exporting a Stored Tag List Document to a File**

```
--
-- Generate a tag list document and store in sample_stl.xml
-- in DICOMDIR
--
-- A stored tag list document must include all tags used by
-- mapping and constraint documents in the repository
-- to enforce the mandate_attr_tags_in_stl rule using a
-- preference document.
--
-- Use the 'ALL' option to ensure that the generated tag list
-- document contains all the tags used by mapping and constraint
-- documents.
--
set serveroutput on;
declare
  fid          UTL_FILE.FILE_TYPE;
  buf          VARCHAR2(32767);
  bytesLeft   INTEGER;
  pos         INTEGER;
  chunk       INTEGER;
  xml_clob    CLOB;
  xt          XMLType;
BEGIN

  xt := ORD_DICOM_ADMIN.generateTagListDocument('ALL');
  if (xt is null) then
    dbms_output.put_line('Repository has no documents');
    dbms_output.put_line('Tag list document is null');
    return;
  end if;

  -- write xml document to file using UTL_FILE
  -- let UTL_FILE report errors for directory and filename
  fid := utl_file.fopen( 'DICOMDIR', 'sample_stl.xml', 'w', 32767 );
```

```

-- Read from clob and write to file
select XMLSerialize(document xt as clob)          into xml_clob from dual;
bytesLeft := dbms_lob.getLength( xml_clob );
pos      := 1;
WHILE bytesLeft > 0 loop
  chunk := 32767;
  IF bytesLeft < chunk THEN
    chunk := bytesLeft;
  END IF;
  dbms_lob.read(xml_clob, chunk, pos, buf );
  utl_file.put( fid, buf);
  utl_file.fflush(fid);
  bytesLeft := bytesLeft - chunk;
  pos := pos + chunk;
end loop;

utl_file.fclose( fid );

--free the temporary blob returned by xmltype
if(dbms_lob.isTemporary(xml_clob) <> 0) then
  dbms_lob.freeTemporary(xml_clob);
end if;

exception
WHEN OTHERS then
  -- free temp lob
  if(dbms_lob.isTemporary(xml_clob) <> 0) then
    dbms_lob.freeTemporary(xml_clob);
  end if;

  raise; -- original exception
END;
/

```

## 11.5 Sample Session 5: Inserting a DICOM Protocol Document

The following sample session shows the steps for inserting a DICOM protocol document into the repository. This sample assumes that the following prerequisite tasks have been completed:

- One or more tables have been created (or selected) to be used as the storage for the DICOM protocol adapter. Each table must contain at least one column for the SOP instance UID. Tables can also contain columns that correspond to a DICOM image, a DICOM attribute value, all the DICOM metadata for an image (as XML), or a WADO link.

### Note:

Corresponding table columns are required only for the DICOM attributes that you want to retain.



- A user has been created (or selected) for the DICOM protocol adapter connection.
- The specified user has been granted the following privileges on the storage tables for the DICOM protocol adapter: SELECT, INSERT, UPDATE, and DELETE.

Perform the following steps to insert a DICOM protocol document into the repository:

### Step 1 Create a DICOM Protocol Document

Create a DICOM protocol document with one `<storage>` tag for each table you created. Each column from those tables (except the SOP instance UID column, which is specified in an attribute of the `<storage>` tag) must contain a corresponding subelement within the `<storage>` tag for that table, as shown in [Example 10-23](#). See [Creating DICOM Protocol Documents](#) for details about creating DICOM protocol documents.

### Step 2 Edit and Lock the Data Model

Prepare the data model for editing and lock it to prevent other administrators from making changes at the same time. For example:

```
exec ord_dicom_admin.editDataModel();
```

The data model remains locked until you publish the changes, perform a rollback operation, or exit the session.

Optionally, you can enter the following command to query the `orddcm_documents` view:

```
select * from orddcm_documents order by doc_id asc;
```

Review the list of documents.

### Step 3 Insert the DICOM Protocol Document

Insert the DICOM protocol document you created in Step 1 into the repository, as follows:

```
exec ord_dicom_admin.insertDocument('ordcmdp.xml', 'DICOM_PROTOCOL',
  xmltype(bfilename('DICOMDIR', 'ordcmdp.xml'), nls_charset_id('AL32UTF8')));
```

See the [insertDocument\(\) Procedure](#) for more information about inserting documents into the repository.

### Step 4 Publish the Changes and Unlock the Data Model

Publish the changes and unlock the data model, as follows:

```
exec ord_dicom_admin.publishDataModel;
```

### Step 5 Create a DICOM Protocol Adapter Configuration Document

Create a DICOM protocol adapter configuration document (`ordim_adapter_config.xml`) that specifies the credentials of the specified user and the name of the DICOM protocol document you created in Step 1.

See [Configuring the Oracle DICOM Protocol Adapter](#) for details about configuring the DICOM protocol adapter.

### Step 6 Deploy the DICOM Protocol Adapter to WebLogic

Deploy the DICOM protocol adapter to WebLogic, as described in [Deploying the Oracle DICOM Protocol Adapter Suite](#).

# ORD\_DICOM\_ADMIN Package Reference

Oracle Multimedia DICOM provides the ORD\_DICOM\_ADMIN data model repository interface in the ORD\_DICOM\_ADMIN package. Oracle Multimedia DICOM also defines a view for the DICOM repository to be used by DICOM administrators.

The ORD\_DICOM\_ADMIN package provides the data model repository interface, which is intended for use by DICOM administrators to maintain the Oracle Multimedia DICOM repository. The data model repository is a collection of documents. One set of documents is loaded during installation. After installation, DICOM administrators can add more documents to the data model repository using the procedures and functions in the ORD\_DICOM\_ADMIN package.

In addition, Oracle Multimedia provides DICOM value locators, which administrators can use to specify DICOM attributes or their child components within the DICOM content and with anonymity, constraint, and mapping documents.

The ORD\_DICOM\_ADMIN package is defined in the `ordcrpsp.sql` file. After installation, this file is available in the Oracle home directory at:

`<ORACLE_HOME>/ord/im/admin` (on Linux and UNIX)

`<ORACLE_HOME>\ord\im\admin` (on Windows)

This chapter describes the functions, procedures, and views in the ORD\_DICOM\_ADMIN data model repository interface. It also describes the syntax for DICOM value locators.

This chapter contains these sections:

- [Directory Definition and Setup for ORD\\_DICOM\\_ADMIN Examples](#)
- [Important Notes for DICOM Repository Administrators](#)
- [DICOM Data Model Repository Administrator Functions](#)
- [DICOM Data Model Repository Administrator Procedures](#)
- [DICOM Repository Administrator Views](#)
- [General Format for DICOM Value Locators](#)

## See Also:

[Table 3-1](#) for information about other DICOM application programming interfaces (APIs)

## 12.1 Directory Definition and Setup for ORD\_DICOM\_ADMIN Examples

In this chapter, some examples use `c:\mydir\work` to represent the directory specification where your test files can be located. Other examples use `DICOMDIR` to represent the directory specification for the test files. And, a few examples use `dcmadmin` to represent the user, who is acting as an administrator. See the example for each function or procedure for specific directory definitions for DICOM data files and other details specific to that function or procedure.

## 12.2 Important Notes for DICOM Repository Administrators

The following guidelines apply to administrative operations related to the Oracle Multimedia DICOM data model repository:

- Administrators must be assigned the `ORDADMIN` role. See [Assigning Administrator Roles and Privileges](#) for more information about administrator privileges.
- At the start of each database session, administrators must load the data model repository from the database into memory structures. To load the data model, administrators call either the `setDataModel()` procedure or the `editDataModel()` procedure, depending on the following situations:
  - When you *are not* making changes to the data model, call the `setDataModel()` procedure (see the [setDataModel\(\) Procedure](#)).
  - When you *are* making changes to the data model, call the `editDataModel()` procedure (see the [editDataModel\(\) Procedure](#)).

## 12.3 DICOM Data Model Repository Administrator Functions

The `ORD_DICOM_ADMIN` package defines these `ORD_DICOM_ADMIN` data model repository functions:

- [generateTagListDocument\(\) Function](#)
- [getDocumentContent\(\) Function](#)

### 12.3.1 generateTagListDocument() Function

#### Format

```
generateTagListDocument(docSet in varchar2 default 'USER')  
    return XMLType
```

#### Description

Returns a stored tag list document as a data type `XMLType` that contains the attribute tags from the mapping and constraint documents stored in the data model repository, and which conforms to the XML schema `ordcmst1.xsd`.

## Parameters

### docSet

A string that lists a specified set of documents in the repository. Valid values are: `USER`, `ALL`, and `ORACLE`. The default is `USER`.

When the value of this parameter is `USER`, the attribute tags from the user-defined mapping and constraint documents are listed in the generated stored tag list document. If there are no user-defined constraint or mapping documents in the repository, a null value is returned. When the value is set to `ALL`, the attribute tags from all the mapping and constraint documents are listed. And, when the value is set to `ORACLE`, only the attribute tags from the Oracle-defined mapping and constraint documents are listed.

## Pragmas

None.

## Exceptions

None.

## Usage Notes

Use this function to generate a stored tag list document that is consistent with the repository documents. (See [About Creating Stored Tag List Documents](#) for more information about creating stored tag list documents.)

Before calling this function, call the `setDataModel()` procedure (see the [setDataModel\(\) Procedure](#)).

## Examples

Generate a stored tag list document for the user-defined mapping and constraint documents in the repository:

```
exec ord_dicom.setDataModel;
set long 50000;
set pagesize 1000;
select ord_dicom_admin.generateTagListDocument from dual;
```

## 12.3.2 getDocumentContent() Function

### Format

```
getDocumentContent(docName IN VARCHAR2) RETURN XMLTYPE
```

### Description

Returns the document as data type `XMLType`. This function can be used to make copies of documents in the data model repository without changing the content of the original documents.

### Parameters

#### docName

The name of the document whose content is to be retrieved. The document content is returned as data type XMLType. The orddcm\_documents view includes the column DOC\_NAME, where docName is one of the documents listed.

### Pragmas

None.

### Exceptions

None.

### Usage Notes

Before calling this function, call either the setDataModel( ) procedure or the editDataModel( ) procedure in these situations:

- Call the setDataModel( ) procedure when you are not making changes to the data model, such as when calling the getDocumentContent( ) procedure or the exportDocument( ) procedure only.
- Call the editDataModel( ) procedure when you are making changes to the data model, such as when inserting or deleting documents.

See the [setDataModel\( \) Procedure](#) and the [editDataModel\( \) Procedure](#) for more information.

### Examples

Get the content of a specified document (ordcmpf.xml) in the repository:

```
exec ord_dicom.setDataModel;  
set long 5000;  
set pagesize 1000;  
select ord_dicom_admin.getDocumentContent('ordcmpf.xml') from dual;
```

## 12.4 DICOM Data Model Repository Administrator Procedures

The ORD\_DICOM\_ADMIN package defines these ORD\_DICOM\_ADMIN data model repository procedures:

- [deleteDocument\( \) Procedure](#)
- [editDataModel\( \) Procedure](#)
- [exportDocument\( \) Procedure](#)
- [insertDocument\( \) Procedure](#)
- [publishDataModel\( \) Procedure](#)
- [rollbackDataModel\( \) Procedure](#)

## 12.4.1 deleteDocument( ) Procedure

### Format

```
deleteDocument(docName IN VARCHAR2)
```

### Description

Deletes the specified document from the data model repository. Documents installed by Oracle are treated as default documents that cannot be removed.

See [About Deleting Documents from the Repository](#) for more information about deleting configuration documents.

### Parameters

#### docName

The name of the document to be removed from the repository, where docName is one of the documents listed in the orddcm\_documents view.

### Pragmas

None.

### Exceptions

None.

### Usage Notes

Before calling this procedure, call the editDataModel( ) procedure (see the [editDataModel\( \) Procedure](#)).

In addition, Oracle recommends calling the exportDocument( ) procedure to make a copy of the specified document before deleting it from the repository (see the [exportDocument\( \) Procedure](#)).

You cannot modify the data model during a rolling upgrade. Therefore, do not call this procedure if a rolling upgrade is in progress.

### Examples

Copy and then delete a document (sample\_pf.xml) from the repository:

```
exec ord_dicom_admin.editDataModel();
select doc_name from orddcm_documents order by doc_id asc;
exec ord_dicom_admin.exportDocument('sample_pf.xml', 'DICOMDIR',
                                   'sample_pf_export.xml');
exec ord_dicom_admin.deleteDocument('sample_pf.xml');
select doc_name from orddcm_documents order by doc_id asc;
exec ord_dicom_admin.publishDataModel();
```

where:

- DICOMDIR: an Oracle directory object for which the administrator has been granted the WRITE privilege, and to which the contents of the specified file are to be copied.

## 12.4.2 editDataModel( ) Procedure

### Format

```
editDataModel( )
```

### Description

Begins an administrator editing session for making changes to the data model repository. The administrator session maintains a lock on the repository until the `publishDataModel( )` or `rollbackDataModel( )` procedure is called, or until the session exits. Call this procedure before making changes to the repository. Upon successful completion, this procedure implicitly commits the current transaction.

### Parameters

None.

### Pragmas

None.

### Exceptions

None.

### Usage Notes

You cannot edit the data model during a rolling upgrade. If you begin a rolling upgrade after calling this procedure, call the `rollbackDataModel( )` procedure to terminate the editing session.

### Examples

Begin an editing session in the repository, while locking it from other administrators:

```
exec ord_dicom_admin.editDataModel();
```

## 12.4.3 exportDocument( ) Procedure

### Format

```
exportDocument(docName IN VARCHAR2,  
              dirName IN VARCHAR2,  
              fileName IN VARCHAR2)
```

### Description

Exports the contents of the document specified by the `docName` parameter to the specified file. This procedure writes the data to a file in a directory for which the administrator has been granted the `WRITE` privilege.

## Parameters

### docName

The name of the specified document in the repository, where docName is one of the documents listed in the orddcm\_documents view.

### dirName

The directory location of the specified file. This string is an Oracle directory object name, and it is case-sensitive. The default is uppercase. The WRITE privilege must be granted to the administrator for this directory object.

### fileName

The name of the file, including the file extension (file type), but excluding the directory path.

## Pragmas

None.

## Exceptions

None.

## Usage Notes

Before calling this procedure, call either the setDataModel() or the editDataModel() procedure in these situations:

- Call the setDataModel() procedure when you are not making changes to the data model, such as when calling the getDocumentContent() procedure or the exportDocument() procedure only.
- Call the editDataModel() procedure when you are making changes to the data model, such as when inserting or deleting documents.

See the [setDataModel\(\) Procedure](#) and the [editDataModel\(\) Procedure](#) for more information.

## Examples

Export the contents of an existing file in the repository (sample\_map.xml) into an external file (sample\_map\_export.xml):

```
exec ord_dicom.setDataModel();  
exec ord_dicom_admin.exportDocument('ordcmpf.xml', 'DICOMDIR', 'ordcmpf_exp.xml');
```

where:

- DICOMDIR: an Oracle directory object that contains the file where the contents of the specified file are to be copied.

## 12.4.4 insertDocument() Procedure

### Format

```
insertDocument(docName IN VARCHAR2,  
              docType IN VARCHAR2,  
              xmlDoc IN XMLType)
```



## Description

Loads the specified XML configuration document into the data model repository. The document name must be unique. Supported document types are listed in the public view [orddcm\\_document\\_types](#). The document is validated against the registered schema that is associated with the document type.

Documents must be loaded into the repository in the following order:

1. Standard data dictionary documents
2. Private data dictionary documents
3. Other configuration documents, including the following:
  - Constraint documents
  - XML mapping documents
  - Anonymity documents
  - Preference documents
  - UID definition documents
  - DICOM protocol documents

Other configuration documents can be loaded in any order, unless there are dependencies between constraint documents.

There are semantic dependencies between the documents. For example, elements referenced in an XML mapping document must exist in the standard or private data dictionary documents. The view [orddcm\\_documents](#) contains the details of the documents in the repository.

## Parameters

### docName

The unique name of the specified document. The name cannot exceed 100 characters in length, and it must not contain the reserved prefix `ORD`.

### docType

The type of the document to be loaded into the repository. Supported values are listed in the public view [orddcm\\_document\\_types](#). The value of this parameter must not be NULL.

### xmlDoc

The XML document to be loaded into the repository. The value of this parameter must not be NULL.

## Pragmas

None.

## Exceptions

None.

## Usage Notes

Before calling this procedure, call the `editDataModel()` procedure (see the [editDataModel\(\) Procedure](#)).

Before inserting a user-defined mapping document into the repository, its associated metadata schema must have been registered as a global or local schema with Oracle XML DB. (The metadata schema associated with the default mapping document is registered with Oracle XML DB upon installation of Oracle Multimedia DICOM. See [DICOM XML Schemas](#) for more information.)

**See Also:**

*Oracle XML DB Developer's Guide* for information about registering XML schemas

You cannot modify the data model during a rolling upgrade. Therefore, do not call this procedure if a rolling upgrade is in progress.

**Examples**

Insert a mapping document (`sample_map.xml`) into the repository:

```
exec ord_dicom_admin.editDataModel();
exec ord_dicom_admin.insertDocument('sample_map.xml', 'MAPPING',
  xmltype(bfilename('DICOMDIR', 'sample_map.xml'),
  nls_charset_id('AL32UTF8')));
select * from orddcm_documents order by doc_id asc;
exec ord_dicom_admin.publishDataModel();
```

where:

- **MAPPING**: the type of the document to be loaded into the repository.
- **DICOMDIR**: the Oracle directory object that contains the file to be loaded.

## 12.4.5 publishDataModel( ) Procedure

**Format**

```
publishDataModel( )
```

**Description**

Publishes changes to the data model repository. This procedure also unlocks the repository, making it available for updating by other administrators. By calling the `setDataModel( )` procedure to refresh the data model repository, users can access the latest published changes to the repository. Upon successful completion, this procedure implicitly commits the current transaction.

**Parameters**

None.

**Pragmas**

None.

**Exceptions**

None.

### Usage Notes

Before calling this procedure, call the `editDataModel()` procedure (see the [editDataModel\(\) Procedure](#)).

Depending on when the administrator publishes changes to the data model repository, users who are connected to the repository may have to call the `setDataModel()` procedure more than once to see the latest changes. Also, based on when they call the `setDataModel()` procedure, it is possible for two users who are connected to the same data model repository to access different versions of the repository. See [Figure 2-5](#) for more information about this possible scenario. See also the [setDataModel\(\) Procedure](#).

You cannot modify the data model during a rolling upgrade. Therefore, do not call this procedure if a rolling upgrade is in progress.

### Examples

Publish the changes to the repository:

```
exec ord_dicom_admin.editDataModel();
select doc_name from orddcm_documents order by doc_id asc;
exec ord_dicom_admin.insertDocument( 'sample_pf.xml', 'PREFERENCE',
  xmltype(bfilename('DICOMDIR', 'sample_pf.xml'),
  nls_charset_id('AL32UTF8') ) );
select doc_name from orddcm_documents order by doc_id asc;
exec ord_dicom_admin.publishDataModel();
```

## 12.4.6 rollbackDataModel() Procedure

### Format

```
rollbackDataModel( )
```

### Description

Terminates changes to the data model since the previous call to the `editDataModel()` procedure. Call this procedure to roll back the changes and unlock the data model, making it available for updating by other administrators. Upon successful completion, this procedure implicitly commits the current transaction.

### Parameters

None.

### Pragmas

None.

### Exceptions

None.

### Usage Notes

Before calling this procedure, call the `editDataModel()` procedure (see the [editDataModel\(\) Procedure](#)).

At end of the database session, call this procedure to roll back the data model. Because the changes to the data model were terminated rather than published, the views are populated with the data from the previously published data model.

You cannot modify the data model during a rolling upgrade. Therefore, if a data model editing session was in progress before a rolling upgrade was started, you must call this procedure to roll back the data model and terminate the editing session.

### Examples

Terminate the data model changes without publishing them to the repository:

```
exec ord_dicom_admin.editDataModel();
select doc_name from orddcm_documents order by doc_id asc;
exec ord_dicom_admin.deleteDocument('sample_pf.xml');
select doc_name from orddcm_documents order by doc_id asc;
exec ord_dicom_admin.rollbackDataModel();
```

## 12.5 DICOM Repository Administrator Views

This section describes this Oracle Multimedia DICOM repository view for administrators:

- [orddcm\\_document\\_refs](#)

See [DICOM Repository Public Views](#) for information about the Oracle Multimedia DICOM repository public views.

### 12.5.1 orddcm\_document\_refs

#### Format

Column Name	Data Type	Description
doc_name	VARCHAR2(100)	Document name
ref_by_doc_name	VARCHAR2(100)	Referenced by document name

#### Description

This read-only view lists the documents that are referenced by other documents. The SELECT privilege is granted to the ORDADMIN role for this view. This view is available to administrators only.

#### Usage Notes

Before querying this view, call either the setDataModel() or the editDataModel() procedure as follows:

- Call the setDataModel() procedure when you are not making changes to the data model, such as when calling the getDocumentContent() procedure or the exportDocument() procedure only.
- Call the editDataModel() procedure when you are making changes to the data model, such as when inserting or deleting documents.

If you call the setDataModel() procedure, call it again whenever the application requires the new data model changes.

See the [setDataModel\(\) Procedure](#) and the [editDataModel\(\) Procedure](#) for more information.

### Examples

Show the references between a set of Oracle-installed configuration documents:

DOC_NAME	REF_BY_DOC_NAME
ordcmpv.xml	ordcmcmc.xml
ordcmpv.xml	ordcmcmd.xml
ordcmsd.xml	ordcman.xml
ordcmsd.xml	ordcmcmc.xml
ordcmsd.xml	ordcmcmd.xml

## 12.6 General Format for DICOM Value Locators

### 12.6.1 Syntax

#### 12.6.1.1 *value\_locator*::=

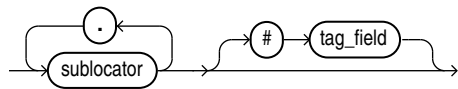

#### 12.6.1.2 *sublocator*::=

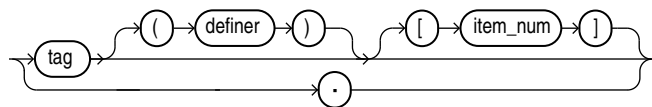

### 12.6.2 Description

Identifies an attribute in the DICOM content, either at the root level or from the root level down. Each level in the tree hierarchy is represented by a sublocator. DICOM value locators can include one or more sublocators, depending on the level of the attribute in the DICOM content.

DICOM value locators can be used within anonymity documents to specify the attributes to be made anonymous in the resulting DICOM content.

When DICOM value locators are used within constraint documents, they can contain macros for substitution when the constraint document is loaded into the repository. Define macro substitution strings either as valid DICOM value locators, or as one of the DICOM value locator parameters with no token separators.

DICOM value locators can be used within mapping documents to specify the attributes to be retrieved or extracted from the metadata in the resulting DICOM XML document.

## 12.6.3 Parameters

### tag

A DICOM standard compliant tag in the format of an 8-digit hexadecimal number.

**Example 1:** A hexadecimal tag for a root-level attribute

```
0040A730
```

**Example 2:** A hexadecimal tag for a root-level attribute

```
0040A123
```

### . (the dot character)

A sublocator separator or a special wildcard tag that matches to zero or a series of sublocators. (See **DICOM Value Locator Example 4.**)

### definer

A string that identifies the organization creating the tag. For tags that are defined by the DICOM standard, the default (which can be omitted) is DICOM. For private tags, the value must include a definer string (which can be empty) to uniquely identify each private attribute. This parameter is optional.

Definer strings cannot contain the following unescaped token separator characters: '(', ')', '[', ']', '{', '}', '\$', '#', and '\*'. Although it is possible to refer to definer strings that contain these characters, you must use an escape mechanism to express definer strings with these characters. Specifically, a single '#' (the escape character) must precede each token separator character in the definer string for a specified attribute.

**Example 1:** A definer string for a private organization

```
ORACLE
```

**Example 2:** A definer string with token separators that have been escaped. The original string was `$abc(#def)[ghi]`.

```
#$abc###def#[ghi#]
```

### item\_num

An integer that identifies a data element within an attribute, or a wildcard character ("\*") that identifies all data elements within an attribute. The default is 1, the first data element of an attribute. This parameter is optional.

- For the binary data types OF, OW, OB, and UN (defined in the data type definition schema `ordcmrdt.xsd`):

This parameter identifies one data value within a DICOM attribute that contains a list of data values, as shown in the following table.

Binary Data Type	Data Value Identification
OF	A floating-point number
OW	A word
OB	A byte
UN	A byte

- For the data type SQ:  
This parameter identifies one sequence item.
- For the data types ST, LT, and UT:  
The value of this parameter is always 1 because attributes of these types always contain single values.

 **Note:**

The concept of an item number is not well-defined by the DICOM standard. Do not confuse it with DICOM value multiplicity. DICOM value locators with a special wildcard tag ". " cannot be immediately followed by an item\_num parameter. Data elements are defined in Part 5 of the DICOM standard.

**Example 1:** An integer that represents a specific sequence item in an attribute  
The second sequence item in attribute 0040A730:

0040A730 [2]

**Example 2:** An integer with a wildcard character that represents all the data elements in an attribute

All items in the sequence attribute 0040A730:

0040A730[\*]

**tag\_field**

A string that identifies a derived value within an attribute. A tag that contains this string must be the last tag of a DICOM value locator. The default is NONE. This parameter is optional.

The following table shows the supported values for the tag\_field parameter:

Value	Meaning
NONE	N/A
UnibyteFamily	Family name, in unibyte characters <sup>1</sup>
UnibyteGiven	Given name, in unibyte characters <sup>1</sup>
UnibyteMiddle	Middle name, in unibyte characters <sup>1</sup>
UnibytePrefix	Prefix, in unibyte characters <sup>1</sup>
UnibyteSuffix	Suffix, in unibyte characters <sup>1</sup>
IdeographicFamily	Family name, in ideographic characters <sup>1</sup>
IdeographicGiven	Given name, in ideographic characters <sup>1</sup>
IdeographicMiddle	Middle name, in ideographic characters <sup>1</sup>
IdeographicPrefix	Prefix, in ideographic characters <sup>1</sup>
IdeographicSuffix	Suffix, in ideographic characters <sup>1</sup>
PhoneticFamily	Family name, in phonetic characters <sup>1</sup>
PhoneticGiven	Given name, in phonetic characters <sup>1</sup>
PhoneticMiddle	Middle name, in phonetic characters <sup>1</sup>
PhoneticPrefix	Prefix, in phonetic characters <sup>1</sup>
PhoneticSuffix	Suffix, in phonetic characters <sup>1</sup>

Value	Meaning
PersonName	Person name, as a concatenated string of characters in the convention of three groups of five components
AgeString	Age, as a string
AgeInDays	Age, in number of days
ByteLength	Binary length of the path
ByteOffset	Byte offset of the path
NumEntry	Total number of data elements within an attribute
VR <sup>2</sup>	In-stream value representation (VR) of an attribute

<sup>1</sup> This value is a component of the attribute `Person Name`.

<sup>2</sup> See the description of the `item_num` parameter for more information about data types.

For complete definitions of the values in the preceding table, see Part 5 of the DICOM standard on the Web site for the National Electrical Manufacturers Association (NEMA) at

<http://medical.nema.org/>

#### Note:

DICOM value locators with a `tag_field` parameter are not supported in anonymity and constraint documents.  
DICOM value locators with a special wildcard tag `" . "` cannot be immediately followed by a `tag_field` parameter.

## 12.6.4 Examples

### 12.6.4.1 DICOM Value Locator Example 1

A DICOM value locator with the required tag parameters only:

```
00080096.00401101.00080100
```

where:

- 00080096.00401101.00080100: the code value of the Person Identification Code Sequence in the Referring Physician Identification Sequence.

### 12.6.4.2 DICOM Value Locator Example 2

A DICOM value locator with the required tag parameter and the optional `item_num` parameter:

```
00080096[1].00401101[1].00080100[1]
```

where:

- [1]: the first data element of an attribute. This DICOM value locator is equivalent to the DICOM value locator shown in **DICOM Value Locator Example 1**.



### 12.6.4.3 DICOM Value Locator Example 3

A DICOM value locator with the required tag parameter and the optional definer and item\_num parameters:

```
00080096(DICOM)[1].00401101(DICOM)[1].00080100(DICOM)[1]
```

where:

- (DICOM): the default definer string. Because the tag is defined by the DICOM standard, the DICOM value locator can be represented without the definer string, as in **DICOM Value Locator Example 2**. This DICOM value locator is equivalent to the DICOM value locator in **DICOM Value Locator Example 1**.

### 12.6.4.4 DICOM Value Locator Example 4

A DICOM value locator with a special wildcard tag (".") for all code values in the DICOM content:

```
..00080100
```

### 12.6.4.5 DICOM Value Locator Example 5

A DICOM value locator with a special wildcard tag (".") for all code values in all the 0040A730 sequence items in the DICOM content:

```
0040A730[*]...00080100
```

### 12.6.4.6 DICOM Value Locator Example 6

A DICOM value locator with a private definer and escape characters:

```
00431028(#$abc##def#)#[ghi#]
```

where:

- (#\$abc##def#)#[ghi#]: the private definer string. Because the definer string contains token separator characters, it must be represented by preceding each token separator character with the escape character ("#").

# Part IV

## DICOM Supplementary Information

This part contains additional information related to the Oracle Multimedia DICOM feature.

This part includes these appendixes:

- [DICOM Configuration Documents](#)
- [DICOM XML Schemas](#)
- [DICOM Encoding Rules](#)
- [DICOM Processing and Supported Formats](#)
- [DICOM Sample Applications](#)

# A

## DICOM Configuration Documents

This appendix lists the names of the DICOM configuration documents. These documents are loaded into the DICOM data model repository when Oracle Multimedia DICOM is installed.

The following table lists the default DICOM configuration documents by name and type. It also lists an optional type and a type with no default configuration document.

**Table A-1 DICOM Configuration Documents**

Name	Type
ordcman.xml	Default anonymity document
ordcmct.xml	Default constraint documents
ordcmcmd.xml	
ordcmcmc.xml	
No default document	DICOM protocol document
ordcmap.xml	Default mapping document
ordcmpf.xml	Default preference document
ordcmpv.xml	Default private dictionary document
ordcmsd.xml	Default standard dictionary document
Optional	Stored tag list document
ordcmui.xml	UID definition document

The latest versions of these XML documents are available as files in the `ord/xml` directory under `<ORACLE_HOME>` when Oracle Multimedia DICOM is installed. See [Configuration Documents in the Repository](#) for more information about these documents.

The DICOM configuration documents are associated with one or more DICOM XML schemas. The latest versions of these XML schemas are available as files in the `ord/xml/xsd` directory under `<ORACLE_HOME>`. To locate and examine the schemas, query the dictionary view `ALL_XML_SCHEMAS` (see [Finding User-Defined XML Schemas](#)). For additional information, read the documentation embedded within each schema file.

### See Also:

*Oracle Database Reference* for more information about the dictionary view `ALL_XML_SCHEMAS`

# B

## DICOM XML Schemas

This appendix lists the names of the DICOM XML schemas used by the methods of the ORDDicom object type.

When Oracle Multimedia DICOM is installed, the DICOM XML schemas are automatically registered as global XML schemas in Oracle Database with Oracle XML DB (see [Registering XML Schemas](#)).

This appendix describes the XML schemas that define the structure of these DICOM configuration documents:

- Anonymity
- Constraint
- DICOM Protocol
- Mapping
- Preference
- Private Dictionary
- Standard Dictionary
- Stored Tag List
- UID Definition

This appendix also describes the XML schemas that define the DICOM standard data types, the default DICOM metadata schema, and the metadata data types used by DICOM metadata schemas.

The following table lists the DICOM XML schemas by .xsd file name, and includes a brief description and the namespace for each schema.

**Table B-1 DICOM XML Schemas**

Schema Name	Description	Namespace
ordcman.xsd	Defines the structure of anonymity documents.	http://xmlns.oracle.com/ord/dicom/anonymity_1_0
ordcmct.xsd	Defines the structure of constraint documents.	http://xmlns.oracle.com/ord/dicom/constraint_1_0
ordcmrdt.xsd	Defines the DICOM standard data types.	http://xmlns.oracle.com/ord/dicom/datatype_1_0
ordcmmd.xsd	Defines the default DICOM metadata schema.	http://xmlns.oracle.com/ord/dicom/metadata_1_0
ordcmdp.xsd	Defines the structure of DICOM protocol documents.	http://xmlns.oracle.com/ord/dicom/protocol_1_0
ordcmmp.xsd	Defines the structure of mapping documents.	http://xmlns.oracle.com/ord/dicom/mapping_1_0

**Table B-1 (Cont.) DICOM XML Schemas**

Schema Name	Description	Namespace
ordcmddt.xsd	Defines the metadata data types used by DICOM metadata schemas.	http://xmlns.oracle.com/ord/dicom/metadata_1_0
ordcmpf.xsd	Defines the structure of preference documents.	http://xmlns.oracle.com/ord/dicom/preference_1_0
ordcmpv.xsd	Defines the structure of private dictionary documents.	http://xmlns.oracle.com/ord/dicom/privateDictionary_1_0
ordcmsd.xsd	Defines the structure of standard dictionary documents.	http://xmlns.oracle.com/ord/dicom/standardDictionary_1_0
ordcmstl.xsd	Defines the structure of DICOM stored tag list documents.	http://xmlns.oracle.com/ord/dicom/attributeTag_1_0
ordcmui.xsd	Defines the structure of UID definition documents.	http://xmlns.oracle.com/ord/dicom/UIDdefinition_1_0

The latest versions of these XML schemas are available as files in the `ord/xml/xsd` directory under `<ORACLE_HOME>`. To locate and examine the schemas, query the dictionary view `ALL_XML_SCHEMAS` (see [Finding User-Defined XML Schemas](#)). For additional information, read the documentation embedded within each schema file.

The DICOM XML schemas are associated with one or more DICOM configuration documents. The latest versions of these XML documents are available as files in the `ord/xml` directory under `<ORACLE_HOME>` when Oracle Multimedia DICOM is installed. See [Configuration Documents in the Repository](#) for more information about these documents.

#### See Also:

- *Oracle XML DB Developer's Guide* for more information about registering XML schemas
- *Oracle Database Reference* for more information about the dictionary view `ALL_XML_SCHEMAS`
- <http://www.w3.org/XML/Schema> for more information about XML schemas

# C

## DICOM Encoding Rules

This appendix lists the encoding rules for medical imaging.

Digital Imaging and Communications in Medicine (DICOM) includes [transfer syntax](#). The transfer syntax is a complete set of [DICOM encoding rules](#) for medical images.

The following table contains the complete list of encoding rules that support medical imaging in Oracle Multimedia DICOM. The abbreviations used in the Support column are defined as follows:

- P: The processCopy( ), createDicomImage( ), and writeMetadata( ) procedures and methods are able to produce DICOM content of this transfer syntax.
- R: The extractMetadata( ), setProperties( ), and isConformanceValid( ) methods are able to read DICOM content of this transfer syntax. If the encoding rule is *not* changing between the source and destination DICOM content, then the processCopy( ), createDicomImage( ), and writeMetadata( ) procedures and methods are also supported for this transfer syntax.

**Table C-1 Encoding Rules for Transfer Syntax**

Value	Name	Support
1.2.840.10008.1.2	Implicit VR Little Endian Default Transfer Syntax	PR
1.2.840.10008.1.2.1	Explicit VR Little Endian Transfer Syntax	PR
1.2.840.10008.1.2.1.99	Deflated Explicit VR Little Endian	PR
1.2.840.10008.1.2.2	Explicit VR Big Endian	PR
1.2.840.10008.1.2.4.50	JPEG Baseline (Process 1)	PR
1.2.840.10008.1.2.4.51	JPEG Extended (Process 2 & 4)	R
1.2.840.10008.1.2.4.52	JPEG Extended (Process 3 & 5) (Retired)	R
1.2.840.10008.1.2.4.53	JPEG Spectral Selection, Non-Hierarchical (Process 6 & 8) (Retired)	R
1.2.840.10008.1.2.4.54	JPEG Spectral Selection, Non-Hierarchical (Process 7 & 9) (Retired)	R
1.2.840.10008.1.2.4.55	JPEG Full Progression, Non-Hierarchical (Process 10 & 12) (Retired)	R
1.2.840.10008.1.2.4.56	JPEG Full Progression, Non-Hierarchical (Process 11 & 13) (Retired)	R
1.2.840.10008.1.2.4.57	JPEG Lossless, Non-Hierarchical (Process 14)	R
1.2.840.10008.1.2.4.58	JPEG Lossless, Non-Hierarchical (Process 15) (Retired)	R
1.2.840.10008.1.2.4.59	JPEG Extended, Hierarchical (Process 16 & 18) (Retired)	R
1.2.840.10008.1.2.4.60	JPEG Extended, Hierarchical (Process 17 & 19) (Retired)	R
1.2.840.10008.1.2.4.61	JPEG Spectral Selection, Hierarchical (Process 20 & 22) (Retired)	R
1.2.840.10008.1.2.4.62	JPEG Spectral Selection, Hierarchical (Process 21 & 23) (Retired)	R
1.2.840.10008.1.2.4.63	JPEG Full Progression, Hierarchical (Process 24 & 26) (Retired)	R
1.2.840.10008.1.2.4.64	JPEG Full Progression, Hierarchical (Process 25 & 27) (Retired)	R
1.2.840.10008.1.2.4.65	JPEG Lossless, Hierarchical (Process 28) (Retired)	R

**Table C-1 (Cont.) Encoding Rules for Transfer Syntax**

Value	Name	Support
1.2.840.10008.1.2.4.66	JPEG Lossless, Hierarchical (Process 29) (Retired)	R
1.2.840.10008.1.2.4.70	JPEG Lossless, Non-Hierarchical, First-Order Prediction (Process 14 [Selection Value 1])	PR
1.2.840.10008.1.2.4.80	JPEG-LS Lossless Image Compression	PR
1.2.840.10008.1.2.4.81	JPEG-LS Lossy (Near-Lossless) Image Compression	PR
1.2.840.10008.1.2.4.90	JPEG 2000 Image Compression (Lossless Only)	PR
1.2.840.10008.1.2.4.91	JPEG 2000 Image Compression	PR
1.2.840.10008.1.2.4.100	MPEG2 Main Profile @ Main Level	PR
1.2.840.10008.1.2.5	RLE Lossless	PR

 **See Also:**

- *Oracle Multimedia Reference* for more information about image processing
- <http://medical.nema.org/> for more information about DICOM encoding rules (DICOM standard, Part 5 and Part 6)

# D

## DICOM Processing and Supported Formats

This appendix describes processing operations and supported formats for DICOM content.

This appendix includes these sections:

- [DICOM Image Content and Compression Formats](#)
- [The frame Image Processing Operator](#)
- [Other Image Processing Operators](#)
- [Multiframe Image Processing and Creation](#)
- [Multiframe DICOM Content Processing to AVI Format](#)
- [Order of Precedence with processCopy\( \) Method Arguments](#)

See [ORDDicom Object Type Reference](#) and [DICOM PL/SQL API Reference](#) for reference information about the processCopy( ) method.



### See Also:

*Oracle Multimedia Reference* for a complete list of image processing operators and details about each operator

### D.1 DICOM Image Content and Compression Formats

Photometric interpretation of DICOM image content is specified by the tag <00280004>. Compression format type in DICOM images is specified by the transfer syntax UID value or the tag <00020010>.

The following table shows the supported photometric interpretations for the processCopy( ) method with DICOM images.

**Table D-1 DICOM Content Photometric Interpretations**

Action	Supported Photometric Interpretation Values
READING	MONOCHROME1, MONOCHROME2, RGB, PALETTECOLOR, YBR_FULL, YBR_FULL_422, YBR_RCT, and YBR_ICT
WRITING	MONOCHROME1, MONOCHROME2, RGB, YBR_FULL, YBR_FULL_422, YBR_RCT, and YBR_ICT

For the action `READING`, DICOM images with the listed photometric interpretation values can be decoded and the pixel data can be extracted.



For the action `WRITING`, DICOM images with the listed photometric interpretation values can be encoded and the pixel data can be written with the corresponding photometric interpretations.

The following table shows the supported compression formats for the `processCopy()` method with DICOM images.

**Table D-2 DICOM Content Compression Formats**

Action	Supported Compression Format Values
READING	DEFLATE, JPEG, JPEG 2000, JPEG-LOSSLESS, JPEG-LS, MPEG, RAW, and RLE
WRITING	DEFLATE, JPEG, JPEG 2000, JPEG-LOSSLESS, JPEG-LS, MPEG, RAW, and RLE

For the action `READING`, DICOM images with the listed compression format values can be decoded and the pixel data can be decompressed.

 **Note:**

In addition:

- Oracle Multimedia supports extracting MPEG content from DICOM format to MPEG format with the `processCopy()` method only. No other processing operations are supported.
- Oracle Multimedia supports the RAW compression format with multibit from 8-bit to 16-bit, inclusive.

For the action `WRITING`, DICOM images with the compression format values can be encoded and the pixel data can be compressed with the corresponding compression format types.

 **Note:**

In addition:

- Oracle Multimedia supports encapsulating MPEG content into DICOM format with the `createDicomImage()` method only.
- Oracle Multimedia supports the RAW compression format with multibit from 8-bit to 16-bit, inclusive.
- Specify `DICOMRLE` as the compression format value when writing DICOM images with RLE compression.

To specify the compression format for the `processCopy()` method, use the `compressionFormat` operator. If the image is not compressed (the compression format value is `RAW`), the encoding bits of each pixel are specified in the user's metadata, which is passed as one argument of the `processCopy()` method.

See [ORDDicom Object Type Reference](#) and [DICOM PL/SQL API Reference](#) for reference information about the `processCopy()` method, and for more information about the `compressionFormat` operator.

The following subsections describe some content compression formats in more detail:

- [DEFLATE Compression Format](#)
- [JPEG-LOSSLESS Compression Format](#)
- [JPEG-LS Compression Format](#)
- [MPEG Compression Format](#)
- [RLE Compression Format](#)

## D.1.1 DEFLATE Compression Format

For the DEFLATE compression format, you can specify the speed or the amount of compression with the `deflateLevel` operator. This operator accepts either a string or an integer from 1 to 9.

The valid values are further defined in the following table:

Value	Type	Description
<code>bestspeed</code>	String	Fastest compression rate
<code>bestcompression</code>	String	Highest compression level
<code>defaultcompression</code>	String	Default value
1 through 9	Integer	A range of values, representing these results: <ul style="list-style-type: none"> <li>• The lower the value, the faster the compression rate</li> <li>• The higher the value, the higher the compression level</li> </ul>

To specify the highest DEFLATE compression level using a string value for the `deflateLevel` operator (highlighted in bold), use the following syntax:

```
dicom.processcopy('fileformat=dicom, compressionFormat=deflate,
  deflateLevel=bestcompression', sop_instance_uid, dest);
```

This processing operation, which is performed at a relatively slow rate, results in an image with a high amount of compression. Specifying the string value `bestspeed`, by contrast, would cause the image to be processed at a fast rate and result in an image with a low amount of compression.

To specify the highest DEFLATE compression level using an integer value for the `deflateLevel` operator (highlighted in bold), use the following syntax:

```
dicom.processcopy('fileformat=dicom, compressionFormat=deflate,
  deflateLevel=9', sop_instance_uid, dest);
```

This processing operation is also performed at a slow rate. Similar to the previous example, it results in an image with a high amount of compression. In general, using an integer value enables you to fine-tune the speed and the level of compression. In this example, specifying the highest integer value (9) results in the same level of compression as with the string value `bestcompression`.

## D.1.2 JPEG-LOSSLESS Compression Format

This topic uses an example to show how to write DICOM images with JPEG-LOSSLESS compression.

You can write DICOM images with JPEG-LOSSLESS compression using the following syntax:

```
'fileFormat=dicom, compressionFormat=jpeg-lossless'
```

## D.1.3 JPEG-LS Compression Format

This topic uses an example to show how to write DICOM images with JPEG-LS compression.

You can write DICOM images with JPEG-LS compression using the following syntax:

```
'fileFormat=dicom, compressionFormat=jpeg-ls'
```

## D.1.4 MPEG Compression Format

This topic describes the methods you can use to read, extract, and write MPEG content.

With the `processCopy()` method, you can read MPEG content from DICOM format and extract it to MPEG format.

With the `createDicomImage()` method, you can write MPEG content into DICOM format.

## D.1.5 RLE Compression Format

This topic uses an example to show how to write DICOM images with RLE compression.

You can write DICOM images with RLE compression using the following syntax:

```
'fileFormat=dicom, compressionFormat=dicomrle'
```

## D.2 The frame Image Processing Operator

Oracle Multimedia provides the frame operator for DICOM image processing. You can use the frame operator to extract a specific frame image from a multiframe DICOM image. You can also combine the frame operator with other image processing operators, such as `scale` and `rotate`, to perform multiple operations on a single frame extracted from a multiframe DICOM image.

To extract a specific frame by the number of the frame, use the following syntax:

```
frame = <frame number>
```

If the specified frame number is less than 1 or greater than the maximum number of frames in the DICOM image, the attempted operation returns an invalid frame exception. The frame operator can be used for DICOM images with only one frame. However, in this case, the value for the frame number must always be 1.

## D.3 Other Image Processing Operators

Other image processing operators include `fileFormat`, `contentFormat`, `compressionFormat`, `cut`, `scale`, and `rotate`.

### See Also:

*Oracle Multimedia Reference* for a complete list of image processing operators and details about each operator

## D.4 Multiframe Image Processing and Creation

Oracle Multimedia supports the creation and processing of multiframe DICOM images.

To process a single frame in a multiframe DICOM image, specify the frame within the frame operator statement in the `processCopy` command (see [The frame Image Processing Operator](#) for an example of this syntax). You can also combine the frame operator with other operators, such as `scale` and `rotate`, to perform multiple operations on a single frame extracted from a multiframe DICOM image.

To create a multiframe DICOM image, use the following syntax:

```
frame = ALL
```

Alternatively, you can combine the frame operator with other operators, such as `scale` and `rotate`, to perform multiple operations on all the frames in a multiframe DICOM image.

You can also use the `frame = ALL` syntax to specify processing operations to be performed on single-frame DICOM images.

### See Also:

*Oracle Multimedia Reference* for a complete list of image processing operators and details about each operator

## D.5 Multiframe DICOM Content Processing to AVI Format

Oracle Multimedia supports the processing of multiframe DICOM content to the Microsoft Video for Windows Audio Video Interleave (AVI) format. You can generate output in AVI format from multiframe DICOM content (such as MRIs, CTs, and Ultrasound videos).

To process multiframe DICOM content into AVI output, invoke the `processCopy()` procedure or method on the DICOM content and convert it into AVI format. Use the following syntax to specify the `processCopy()` procedure or method with the value of the `fileFormat` operator set to `avi`, as shown in the example:

```
'fileFormat=avi'
```

The preceding example shows the fileFormat operator set to `avi`, with no other parameters. Optionally, in addition to specifying `avi` as the value of the fileFormat operator, you can also specify *either* the framerate *or* the frametime parameter. The framerate parameter represents the number of frames or images of the resulting AVI video that are displayed each second. The frametime parameter represents the duration or time, in number of seconds, that each frame or image in the resulting AVI video is displayed. The default value for both of these optional parameters is `1`.

The following code segment shows how to specify the framerate parameter for a display of ten frames of AVI video in each second:

```
'fileFormat=avi, framerate=10'
```

The following code segment shows how to specify the frametime parameter for a display of one frame of AVI video for every one-tenth of a second:

```
'fileFormat=avi, frametime=0.1'
```

 **Note:**

Specify at most one optional parameter each time you invoke the `processCopy( )` procedure or method with the fileFormat operator set to `avi`. Specifying both optional parameters at the same time causes an exception to be thrown.

When the value of the fileFormat operator is set to `avi`, you can also combine this operator with other operators, such as `scale` and `rotate`, to perform multiple operations on multiframe DICOM content.

See [processCopy\( \) for BFILES](#) and [processCopy\( \) for BLOBs](#) for reference information about the `processCopy( )` procedures that support this feature. See [processCopy\( \) to BLOBs](#) for reference information about the `processCopy( )` method that supports this feature.

 **See Also:**

*Oracle Multimedia Reference* for more information about the AVI data format

## D.6 Order of Precedence with processCopy( ) Method Arguments

When you use the `processCopy( )` method to process a DICOM image to another DICOM image, you can include the optional metadata argument, `SYS.XMLTYPE`, to specify the encoding rules for the output DICOM image.

If a conflict exists between the command argument and the metadata argument, the command argument takes precedence over the metadata argument. The encoding information in the output DICOM image is updated with the result of the processing operation, as specified by the command argument and the metadata argument (in that order).

 **See Also:**

*Oracle XML DB Developer's Guide* for more information about XMLType operations

# E

## DICOM Sample Applications

This appendix briefly describes some sample SQL and PL/SQL scripts that you can use with Oracle Multimedia DICOM.

The sample scripts in [DICOM Application Development](#) are provided to help you learn to develop applications using Oracle Multimedia DICOM to upload to the database, retrieve from it, and manipulate DICOM content.

Some sample scripts were extracted from the tutorial **Managing DICOM Format Data in Oracle Database 12c**, and adapted for this manual. To access this tutorial, enter the URL listed in the following table.

**Table E-1 Oracle Multimedia DICOM Sample Programs**

Name	DICOM Sample Programs on OTN
Managing DICOM Format Data in Oracle Database 12c	<a href="https://apexapps.oracle.com/pls/apex/f?p=44785:24:0::NO:24:P24_CONTENT_ID:16951">https://apexapps.oracle.com/pls/apex/f?p=44785:24:0::NO:24:P24_CONTENT_ID:16951</a>



### See Also:

[DICOM Application Development](#) for more information about using these sample scripts with Oracle Multimedia DICOM

# Glossary

## **anonymity document**

An XML document that specifies the set of attributes to be made anonymous, and defines the actions required to make those attributes anonymous.

## **application conformance**

The semantic consistency of DICOM content with regard to application-specific constraint rules, which can be stronger or weaker than rules in the DICOM standard. Administrators can define constraint documents to include user-defined rules that are specific to a particular organization.

## **Application Entity title**

A unique identifier for each DICOM client running on the network.

## **configuration document**

A unique document for each database instance that is applicable to all DICOM content stored in the database. Configuration documents are managed by the repository. Examples include private and standard dictionary documents, mapping documents, constraint documents, and preference documents.

## **conformance validation**

The process of checking the conformance of DICOM content against a set of constraint documents that define rules with which to validate conformance. Oracle extends conformance validation to DICOM metadata documents as well.

## **constraint document**

An XML document that defines a collection of rules to validate the conformance of DICOM content, according to the DICOM standard and other organization-wide guidelines. Constraint documents specify the relationships and semantic constraints of attributes that are not expressed by the DICOM metadata schema. Constraint documents are based on the SOP class specification defined in Part 3 of the DICOM standard. Administrators can define constraint documents to include user-defined rules that are specific to a particular organization.

## **constraint macro**

A simplified definition of a complex constraint rule. Constraint macros can be defined as global macros, and follow the same predicate definition grammar as constraint rules. Constraint macros can include predicate operands, which can contain macro parameters that are replaced with parameter values when the macro is invoked.



Constraint macros can also be recursive, which is useful when specifying validation requirements for hierarchical or recursive structured DICOM content.

**constraint predicate**

A definition of a condition that operates on individual attributes or sets of attributes in the DICOM content. A constraint predicate can be a logical statement, a relational statement that compares values, a function call evaluation that returns a Boolean type, or a reference to other predicate definitions. Predicate definitions are recursive.

**constraint rule**

A collection of rules to validate the conformance of DICOM content according to the DICOM standard. These rules are defined in constraint documents, which specify the relationships and semantic rules of attributes that are not expressed by the DICOM metadata schema. Administrators can define constraint documents to include user-defined rules that are specific to a particular organization.

**data model repository**

A set of collectively managed, user-configurable documents that defines the run-time behavior of Oracle Multimedia DICOM. Administrators can update the repository to configure Oracle Multimedia DICOM for a particular database instance.

**DICOM**

Digital Imaging and Communications in Medicine. A medical imaging standard initiated by the American College of Radiology (ACR) and the National Electrical Manufacturers Association (NEMA) to enhance the connectivity of radiological devices. The DICOM standard specifies an imaging file format and a networking protocol designed to be used in the medical imaging domain. It is the dominant standard for medical imaging and communication.

**DICOM attribute tag**

An encoded representation of the metadata within DICOM content that can be used with XML schemas. DICOM attribute tags include standard tags, which are supported by the DICOM standard, and user-defined private tags. DICOM attribute tags contain a group number and an element number.

**DICOM client**

An application or system that uses the DICOM network protocol to communicate. PACS and DICOM viewers are examples of DICOM clients.

**DICOM conformance validator**

A utility that checks the syntactical and semantic consistency of DICOM content in accordance with constraint rules specified in the data model repository.

**DICOM content**

Multiple standalone DICOM Information Objects that are structured and encoded as defined in Part 10 of the DICOM standard (commonly referred to as DICOM Part 10 files). For more information, see the DICOM standard on the NEMA Web site at

<http://medical.nema.org/>

**DICOM crawler**

A scheduled service of the Oracle DICOM protocol adapter suite. The Oracle DICOM crawler periodically queries a set of PACS using the DICOM protocol to import new DICOM images and DICOM metadata into Oracle Database.

**DICOM data type**

See [value representation](#).

**DICOM data type definition schema**

An XML schema that defines the value representations (DICOM data types) provided in Part 5 of the DICOM standard. This data type definition schema is strongly coupled with the DICOM parser. It is designed by Oracle, the content is fixed, and it ships with Oracle Multimedia.

**DICOM encoding rules**

See [transfer syntax](#).

**DICOM image**

Any DICOM content that can be decomposed into 2-D pixel arrays. Examples include a video segment, a volume scan, and a single-frame dental image.

**DICOM metadata document**

An XML document that contains the metadata, as encoded attributes, extracted from DICOM content. Oracle provides methods to build a metadata document from DICOM content. Each metadata schema requires a mapping document that defines how attributes from the DICOM content are to be mapped into an XML document that conforms to the schema. In addition, each metadata schema references the DICOM data type definition schema.

**DICOM parser**

A utility that extracts metadata from DICOM content into a structure in memory.

**DICOM Part 10 file**

A standalone DICOM Information Object, which is constructed in accordance with the data structure and encoding definitions specified in Part 10 of the DICOM standard. For more information, see the DICOM standard on the NEMA Web site at

<http://medical.nema.org/>

**DICOM protocol adapter**

The core application of the Oracle DICOM protocol adapter suite. The Oracle DICOM protocol adapter serves as a bridge between standard DICOM clients and Oracle Database.

**DICOM protocol adapter suite**

A set of Oracle WebLogic applications that interact with Oracle Database to perform operations based on the communications with the DICOM clients to store, query, and retrieve images from Oracle Database. These WebLogic applications are available as adapters to communicate with PACS, viewers, and other DICOM clients. They include the DICOM protocol adapter, the DICOM crawler, and the DICOM WADO proxy.

**DICOM protocol document**

An XML document that defines how to manage the behavior of a DICOM protocol adapter instance that is configured to use Oracle Database as the backing storage mechanism for DICOM images and metadata. DICOM protocol documents are named containers for user-configurable parameters that govern where DICOM images and metadata are stored in Oracle Database.

**DICOM standard**

The dominant standard for radiology imaging and communication to which all major manufacturers conform. The DICOM standard is primarily developed and maintained by working groups of domain experts. A new version is usually published once a year. The standard is available worldwide from the National Electrical Manufacturers Association (NEMA) Web site at

<http://medical.nema.org/>

**DICOM value locator**

A DICOM type that identifies an attribute in the DICOM content, either at the root level or from the root level down. Each level in the tree hierarchy is represented by a sublocator.

**DICOM viewer**

A specialized software application designed to query, retrieve, and examine DICOM images, which doctors can analyze and use in diagnosis. DICOM viewers use the DICOM protocol to communicate directly with a DICOM image archive system.

**DICOM volume scan**

A set of images gathered in a single imaging operation. These images can be stored as separate slices in multiple ORDDicom objects. Or, they can be stored as single ORDDicom multiframe objects.

**DICOM WADO proxy**

A service of the Oracle DICOM protocol adapter suite. The Oracle DICOM WADO proxy is used to retrieve DICOM images from remote DICOM clients by way of a WADO-formatted URL.

**DICOM XML encoder**

A utility that converts the in-memory structure of the extracted DICOM attributes into an XML document.

**Digital Imaging and Communications in Medicine (DICOM)**

See [DICOM](#).

**image processor**

A utility that provides support for operations such as producing thumbnail-size images and converting between DICOM and other supported image formats. When used with Oracle Multimedia DICOM methods, this utility supports import and export operations between the database and operating system files (external file storage).

**information object**

An object-oriented representation of a real world entity in DICOM. Examples include images and waveforms captured by imaging devices.

**mapped attribute**

A part of a DICOM data element whose XML path is explicitly defined in a mapping document.

See also [unmapped attribute](#).

**mapping document**

An XML document that defines how each attribute maps to a particular element of a DICOM XML metadata document. This document determines the structure of the extracted XML representation of the DICOM metadata.

**metadata encoding**

The process of encoding the extracted DICOM attributes into a DICOM metadata document.

**metadata extraction**

The process of extracting attributes from DICOM content.

**metadata schema**

The XML schema document that constrains the DICOM metadata document. This schema references the DICOM data type definition schema. Oracle supports customization of the metadata schema for each instance of the database. Oracle ships a default metadata schema with Oracle Multimedia. Administrators can update the default metadata schema and the corresponding mapping document to define a schema that is specific to the database instance.

**nonscalar attribute**

A property of DICOM value locators that exists when the last attribute tag in an array is specified as DICOM type SQ, OW, OB, OF, or UN.

See also [scalar attribute](#).

**Oracle *interMedia***

In Oracle Database 11g Release 1 (11.1), the name Oracle *interMedia* was changed to Oracle Multimedia.

**PACS**

Picture Archiving and Communication Systems. Systems designed to store and transfer medical images that are stored in the DICOM format using the DICOM network protocol. Medical imaging devices communicate with one or more PACS to store images resulting from study procedures.

**Picture Archiving and Communication Systems (PACS)**

See [PACS](#).

**preference document**

An XML document that defines a set of run-time parameters, such as specifying whether Oracle Multimedia DICOM skips invalid attributes and their values in the binary output of DICOM content when making a copy of DICOM content. Oracle ships a default preference document with Oracle Multimedia. Administrators can update the default preference document to change the run-time behavior. For example, administrators can specify whether to validate XML documents used in DICOM functions and procedures or cause attributes larger than a specified size to be omitted when encoding attributes into XML.

**private attributes**

A set of attributes defined by an organization and encoded in DICOM content according to the encoding rules set by that organization for those attributes. Private attributes can add modality-specific, manufacturer-specific, or site-specific information to DICOM content. Private attributes are not administered by the DICOM standard, and they are generally not known or used by any organization other than the one that defined the private attributes.

**private dictionary document**

A document that lists the private attributes in the data dictionary. A data dictionary can contain one or more private dictionary documents. Each private dictionary document contains the definitions for a set of private attributes and the UID of the organization that defined the private attributes. Private dictionary documents can be published by Oracle or a third party. DICOM administrators can add new private dictionary documents to the data dictionary as they become available. Private dictionary documents enable users to extend the standard dictionary document definitions by adding manufacturer-specific or enterprise-specific attributes to DICOM content. Private dictionary documents are constrained by private dictionary schemas.

**repository**

A library used to store documents that are applicable to all ORDDicom objects stored in a database instance. Administrators can access the repository and update the documents stored in it. Changes made to these documents change the outcome of the affected Oracle Multimedia DICOM methods and procedures. Examples of documents

stored in the repository include mapping documents, data dictionary documents, and constraint documents. At run time, a specified method is used to query the repository to obtain the latest copy of these documents. For example, a DICOM administrator can update an attribute definition in a data dictionary document and change its data type from DA (date) to DT (date time). From that point forward, after setting to the new data model the parser interprets the attribute as an instance of the DT data type, and the metadata encoder encodes the attribute as DT in all future metadata documents.

**scalar attribute**

A property of DICOM value locators in an array of attribute tags for supported DICOM types.

See also [nonscalar attribute](#).

**schema validation**

The process of using an XML schema definition to validate an XML document that is constrained by the schema. Schema validation enables users to confirm the correctness of data types, data formats, and data hierarchies. Schema validation applies to XML documents only. It does not apply to DICOM content.

**service object pair (SOP)**

See [SOP](#).

**SOP**

Service object pair. The combination of services and information objects.

**SOP class**

A service object pair (SOP) class. This class is used to model a category of information object and a set of operations associated with that information object.

**standard attributes**

The set of attributes defined by the DICOM Standards Committee, which is published in Part 6 of the DICOM standard. Standard attributes can be modified or deprecated by the DICOM Standards Committee in the future. The number of standard attributes increases each year as the DICOM standard expands to include new areas of technology.

**standard dictionary document**

A document that lists the attributes defined by the DICOM standard. The DICOM standard dictionary document is converted from Part 6 of the DICOM standard. The DICOM Standards Committee expects to publish this document in XML format in the future. Oracle software releases include a copy of the standard dictionary document tied to a particular release of the DICOM standard. Administrators can update this standard dictionary document to reflect the most recent changes made by the DICOM Standards Committee.

**standards conformance**

The syntactical and semantic consistency of DICOM content with regard to the DICOM standard. The default constraint document that Oracle ships with Oracle Multimedia defines rules that enforce conformance with parts of the DICOM standard.

**stored tag list document**

An optional XML document that specifies the DICOM attributes to be extracted from the embedded DICOM content and stored in the XML metadata attribute of the ORDDicom object when the `setProperties()` method is called. Generally, stored tag list documents contain the attribute tags used in mapping and constraint documents.

**transfer syntax**

Encoding rules for medical imaging that specify how to encode DICOM content into a binary stream. These rules also specify how to compress the data content. Supported DICOM compression schemes (codecs) include RLE, JPEG, and JPEG2000.

**UID**

Unique identifier. A 64-byte, dot-concatenated, numeric string (similar to an IP address). The UID is based on an ISO object identifier (OID). It is commonly constructed with a root that uniquely identifies the organization producing the DICOM content, and a suffix that uniquely identifies the DICOM content within that organization.

**UID definition document**

An XML document that lists unique identifiers (UIDs) defined by the DICOM standard or a private organization. Rather than defining the DICOM content UIDs, UID definition documents contain a registry of standard UIDs that classify the DICOM content and express standard semantics.

See also [UID](#).

**unique identifier (UID)**

See [UID](#).

**unmapped attribute**

A part of a DICOM data element whose XML path is not explicitly defined in a mapping document.

See also [mapped attribute](#).

**value multiplicity**

A constraint rule that specifies how many times the value of an attribute can be repeated. It is part of the standard attribute specification (defined in Part 6 of the DICOM standard).

**value representation**

The data type, as defined by the DICOM standard. The DICOM standard defines standard data types in Part 5. See the XML schema `ordcmrtdt.xsd` (available in the `ord/`

dicom/xml/xsd directory under <ORACLE\_HOME>) for more information about the data types supported by Oracle Multimedia DICOM.

**WADO**

Web Access to DICOM Objects. An HTTP-based protocol defined as part of the DICOM standard (in Part 18). It allows standard HTTP clients to retrieve DICOM images by way of a WADO-formatted HTTP URL.

**Web Access to DICOM Objects (WADO)**

See [WADO](#).

**XML mapping document**

An XML document used to define how to map DICOM attributes to elements in the DICOM metadata document. The XML mapping document is used by the metadata encoder to produce a DICOM metadata document. Because the metadata document is constrained by the metadata schema, the XML mapping document must match the metadata schema. Oracle Multimedia defines a default mapping document that coincides with the DICOM metadata schema. Administrators can update the mapping document and the corresponding metadata schema to define a schema that is specific to each database instance.



# Index

## A

---

- administrator views, [3-2](#), [9-6](#), [12-11](#)
- anonymity documents
  - characteristics, [10-3](#)
  - defined, [2-7](#)
  - examples, [2-18](#)
  - writing, [10-6](#)
  - XML schemas, [B-1](#)
- APIs
  - DICOM PL/SQL, [7-1](#)
  - ORD\_DICOM data model utility, [5-1](#)
  - ORD\_DICOM\_ADMIN data model repository API, [12-1](#)
  - ORDDicom object, [8-1](#)

## C

---

- compression format types, [D-1](#)
- configuration documents
  - anonymity documents, [2-7](#)
  - characteristics, [10-2](#)
  - constraint documents, [2-7](#)
  - creating, [10-6](#)
  - default, [3-1](#)
  - defined, [2-5](#)
  - deleting from the repository, [9-11](#)
  - DICOM protocol, [4-22](#)
  - DICOM protocol documents, [2-7](#)
  - exporting from the repository, [9-6](#)
  - inserting into the repository, [9-7](#)
  - mapping documents, [2-7](#)
  - preference documents, [2-7](#)
  - private dictionary documents, [2-7](#)
  - standard dictionary documents, [2-7](#)
  - stored tag list documents, [2-7](#)
  - UID definition documents, [2-8](#)
  - updating in the repository, [9-9](#)
  - writing, [10-6](#)
- conformance validation, [2-15](#), [3-9](#)
- constraint documents
  - characteristics, [10-3](#)
  - defined, [2-7](#)
  - examples, [2-15](#), [3-10](#)
  - writing, [10-12](#)

- constraint documents (*continued*)
  - XML schemas, [B-1](#)
- constructors
  - ORDDicom, [8-3](#)
  - ORDDicom() for BLOBs, [8-4](#)
  - ORDDicom() for ORDImage, [8-5](#)
  - ORDDicom() for other sources, [8-6](#)
- converting images
  - illustrated, [2-16](#)
- createDicomImage() for BFILES procedure, [7-13](#)
- createDicomImage() for BLOBs procedure, [7-14](#)
- createDicomImage() for ORDImage procedure, [7-15](#)

## D

---

- data type definitions
  - XML schemas, [B-2](#)
- default DICOM metadata
  - XML schema, [B-1](#)
- deleteDocument() procedure, [12-5](#)
- deleting constraint documents, [11-4](#), [11-5](#)
- deleting mapping documents, [11-3](#)
- DICOM
  - communication protocol, [1-2](#)
  - file format, [1-2](#)
- DICOM administrator
  - creating configuration documents, [10-1](#)
  - managing configuration documents, [11-1](#)
  - ORDADMIN role, [9-2](#)
  - privileges, [9-2](#)
- DICOM attributes
  - accessing, [6-8](#)
  - examples, [6-8](#)
  - retrieving, [3-6](#)
  - searching, [3-6](#)
- DICOM conformance validator, [2-2](#)
- DICOM content, [1-2](#), [2-1](#)
  - creating tables, [6-2](#)
  - loading into tables, [3-4](#), [6-3](#)
  - storing, [6-2](#)
- DICOM crawler, [4-5](#)
  - schemas, [4-17](#)
- DICOM data model
  - defined, [2-4](#)

- DICOM data model functions
  - getDictionaryTag(), 5-2
  - getMappingXPath(), 5-3
- DICOM data model procedures
  - setDataModel(), 5-5
- DICOM data model repository, 2-2
- DICOM data model utility interface
  - ORD\_DICOM package, 5-1
- DICOM image processor, 2-2
- DICOM images
  - compressing, 3-7
  - converting, 3-7
  - creating from other formats, 3-8
  - multiframe, D-5
  - processing, 3-7, D-1
  - supported formats, D-1
- DICOM metadata
  - editing, 3-7
  - writing, 3-7
- DICOM metadata documents
  - defined, 2-11
- DICOM parser, 2-2
- DICOM PL/SQL API, 7-1
  - ORD\_DICOM package, 7-1
- DICOM protocol, 1-2, 4-2
- DICOM protocol adapter, 4-3
  - archive files, 4-7
  - configuration files, 4-9
  - schemas, 4-11
- DICOM protocol adapter suite, 4-2
- DICOM protocol configuration document, 4-22
- DICOM protocol documents, 4-22
  - characteristics, 10-3
  - defined, 2-7
  - schemas, 10-27
  - writing, 10-27
  - XML schemas, B-1
- DICOM protocol roles, 4-3
- DICOM standard, 1-1, 4-2
- DICOM standard data types
  - XML schemas, B-1
- DICOM value locator type, 10-1
- DICOM WADO proxy, 4-5
  - schemas, 4-20
- DICOM XML encoder, 2-2
- DICOM\_PROTOCOL documents
  - example, 10-28
  - inserting into the repository, 9-9

## E

---

- editDataModel() procedure, 12-6
- exception handling
  - PL/SQL, 6-13
- export() method, 8-8

- export() procedure, 7-17
- exportDocument() procedure, 12-6
- exporting constraint documents, 11-5
- exporting mapping documents, 11-3
- extracting DICOM metadata
  - administrator tasks, 3-5
  - developer tasks, 3-6
- extracting DICOM metadata stored in BLOBs
  - DICOM protocol adapter, 4-24
- extracting private attributes
  - DICOM protocol adapter, 4-23
- extractMetadata() for BFILES function, 7-3
- extractMetadata() for BLOBs function, 7-4
- extractMetadata() for ORDImage function, 7-5
- extractMetadata() method, 8-9

## F

---

- frame operator
  - image processing, D-4
- frames
  - multiple in DICOM images, D-5
- functions
  - extractMetadata() for BFILES, 7-3
  - extractMetadata() for BLOBs, 7-4
  - extractMetadata() for ORDImage, 7-5
  - generateTagListDocument(), 12-2
  - getDictionaryTag(), 5-2
  - getDocumentContent(), 12-3
  - getMappingXPath(), 5-3
  - isAnonymous() for BFILES, 7-6
  - isAnonymous() for BLOBs, 7-7
  - isAnonymous() for ORDImage, 7-8
  - isConformanceValid() for BFILES, 7-9
  - isConformanceValid() for BLOBs, 7-10
  - isConformanceValid() for ORDImage, 7-11

## G

---

- generateTagListDocument() function, 12-2
- generating stored tag list documents, 11-8
- getAttributeByName() method, 8-10
- getAttributeByTag() method, 8-11
- getContent() method, 8-12
- getContentLength() method, 8-13
- getDictionaryTag() function, 5-2
- getDocumentContent() function, 12-3
- getMappingXPath() function, 5-3
- getSeriesInstanceUID() method, 8-14
- getSOPClassUID() method, 8-14
- getSOPInstanceUID() method, 8-15
- getSourceInformation() method, 8-15
- getSourceLocation() method, 8-16
- getSourceName() method, 8-16
- getSourceType() method, 8-17

getStudyInstanceUID() method, [8-18](#)

## H

---

handling exceptions

PL/SQL, [6-13](#)

## I

---

IHE

Integrating the Healthcare Enterprise, [1-1](#)

image processing, [6-9](#)

image processing operators

frame, [D-4](#)

other, [D-5](#)

image versioning

DICOM protocol adapter, [4-23](#)

import() method, [8-18](#)

importFrom() procedure, [7-18](#)

insertDocument() procedure, [12-7](#)

inserting constraint documents, [11-2](#)

inserting DICOM protocol documents, [11-10](#)

inserting generated stored tag list documents,  
[11-8](#)

inserting mapping documents, [11-2](#)

inserting stored tag list documents, [11-6](#)

interfaces

ORD\_DICOM\_ADMIN data model repository,  
[12-1](#)

ORDDicom object, [8-1](#)

isAnonymous() for BFILES function, [7-6](#)

isAnonymous() for BLOBs function, [7-7](#)

isAnonymous() for ORDImage function, [7-8](#)

isAnonymous() method, [8-19](#)

isConformanceValid() for BFILES function, [7-9](#)

isConformanceValid() for BLOBs function, [7-10](#)

isConformanceValid() for ORDImage function,  
[7-11](#)

isConformanceValid() method, [8-20](#)

isLocal() method, [8-21](#)

## L

---

loading the data model, [3-4](#), [9-5](#)

## M

---

makeAnonymous() for BFILES procedure, [7-19](#)

makeAnonymous() for BLOBs procedure, [7-20](#)

makeAnonymous() for ORDImage procedure,  
[7-21](#)

makeAnonymous() method, [8-22](#)

Managing DICOM Format Data sample  
application, [6-1](#), [E-1](#)

mapping documents

characteristics, [10-4](#)

defined, [2-7](#)

examples, [2-14](#)

writing, [10-29](#)

XML schemas, [B-1](#)

MEDICAL\_IMAGE\_OBJ table, [8-2](#)

MEDICAL\_IMAGE\_REL table, [7-2](#)

message handling

DICOM protocol adapter, [4-4](#)

metadata XML schemas, [A-1](#), [B-1](#)

methods

export(), [8-8](#)

extractMetadata(), [8-9](#)

getAttributeByName(), [8-10](#)

getAttributeByTag(), [8-11](#)

getContent(), [8-12](#)

getContentLength(), [8-13](#)

getSeriesInstanceUID(), [8-14](#)

getSOPClassUID(), [8-14](#)

getSOPInstanceUID(), [8-15](#)

getSourceInformation(), [8-15](#)

getSourceLocation(), [8-16](#)

getSourceName(), [8-16](#)

getSourceType(), [8-17](#)

getStudyInstanceUID(), [8-18](#)

import(), [8-18](#)

isAnonymous(), [8-19](#)

isConformanceValid(), [8-20](#)

isLocal(), [8-21](#)

makeAnonymous(), [8-22](#)

ORDDicom, [8-7](#)

processCopy() to BLOBs, [8-23](#)

processCopy() to ORDDicom, [8-24](#)

processCopy() to ORDImage, [8-26](#)

setProperties(), [8-27](#)

writeMetadata(), [8-28](#)

## N

---

NEMA

National Electrical Manufacturers  
Association, [1-1](#)

## O

---

object types

ORDDicom, [8-3](#)

Oracle Data Pump utilities, [9-12](#)

Oracle *interMedia* DICOM See Oracle Multimedia  
DICOM, [1-1](#)

Oracle Multimedia DICOM, [1-1](#)

ORD\_DICOM data model utility API, [5-1](#)

ORD\_DICOM package, [5-2](#), [5-5](#)

DICOM data model utility interface, [5-1](#)

- ORD\_DICOM package (*continued*)
    - DICOM PL/SQL API, 7-1
    - ordcpksp.sql file, 5-1, 7-1
  - ORD\_DICOM PL/SQL package, 7-2, 7-12
  - ORD\_DICOM PL/SQL package functions
    - extractMetadata() for BFILES, 7-3
    - extractMetadata() for BLOBs, 7-4
    - extractMetadata() for ORDImage, 7-5
    - isAnonymous() for BFILES, 7-6
    - isAnonymous() for BLOBs, 7-7
    - isAnonymous() for ORDImage, 7-8
    - isConformanceValid() for BFILES, 7-9
    - isConformanceValid() for BLOBs, 7-10
    - isConformanceValid() for ORDImage, 7-11
  - ORD\_DICOM PL/SQL package procedures
    - createDicomImage() for BFILES, 7-13
    - createDicomImage() for BLOBs, 7-14
    - createDicomImage() for ORDImage, 7-15
    - export(), 7-17
    - importFrom(), 7-18
    - makeAnonymous() for BFILES, 7-19
    - makeAnonymous() for BLOBs, 7-20
    - makeAnonymous() for ORDImage, 7-21
    - processCopy() for BFILES, 7-22
    - processCopy() for BFILES with SOP instance UID, 7-23
    - processCopy() for BLOBs, 7-25
    - processCopy() for BLOBs with SOP instance UID, 7-26
    - processCopy() for ORDImage, 7-27
    - processCopy() for ORDImage with SOP instance UID, 7-28
    - writeMetadata() for BFILES, 7-30
    - writeMetadata() for BLOBs, 7-31
    - writeMetadata() for ORDImage, 7-32
  - ORD\_DICOM\_ADMIN data model repository API, 12-1
  - ORD\_DICOM\_ADMIN data model repository interface, 12-1
  - ORD\_DICOM\_ADMIN functions
    - generateTagListDocument(), 12-2
    - getDocumentContent(), 12-3
  - ORD\_DICOM\_ADMIN package, 12-1, 12-2, 12-4
    - ordcrpsp.sql file, 12-1
  - ORD\_DICOM\_ADMIN procedures
    - deleteDocument(), 12-5
    - editDataModel(), 12-6
    - exportDocument(), 12-6
    - insertDocument(), 12-7
    - publishDataModel(), 12-9
    - rollbackDataModel(), 12-10
  - ORDADMIN role, 9-2
  - orddcm\_conformance\_vld\_msgs view, 5-6
  - orddcm\_constraint\_names view, 5-7
  - orddcm\_document\_refs view, 12-11
  - orddcm\_document\_types view, 5-9
  - orddcm\_documents view, 5-8
  - ORDDicom constructors, 8-3
    - ORDDicom() for BLOBs, 8-4
    - ORDDicom() for ORDImage, 8-5
    - ORDDicom() for other sources, 8-6
  - ORDDicom methods, 8-7
    - export(), 8-8
    - extractMetadata(), 8-9
    - getAttributeByName(), 8-10
    - getAttributeByTag(), 8-11
    - getContent(), 8-12
    - getContentLength(), 8-13
    - getSeriesInstanceUID(), 8-14
    - getSOPClassUID(), 8-14
    - getSOPInstanceUID(), 8-15
    - getSourceInformation(), 8-15
    - getSourceLocation(), 8-16
    - getSourceName(), 8-16
    - getSourceType(), 8-17
    - getStudyInstanceUID(), 8-18
    - import(), 8-18
    - isAnonymous(), 8-19
    - isConformanceValid(), 8-20
    - isLocal(), 8-21
    - makeAnonymous(), 8-22
    - processCopy() to BLOBs, 8-23
    - processCopy() to ORDDicom, 8-24
    - processCopy() to ORDImage, 8-26
    - setProperties(), 8-27
    - writeMetadata(), 8-28
  - ORDDicom object
    - illustrated, 2-3
    - illustrated within a table, 2-4
  - ORDDicom object API, 8-1
  - ORDDicom object type, 8-3
    - ordcspec.sql file, 8-1
  - ORDDicom object type interface, 8-1
  - ORDDicom objects
    - anonymity, 6-10
  - ORDDicom() for BLOBs constructor, 8-4
  - ORDDicom() for ORDImage constructor, 8-5
  - ORDDicom() for other sources constructor, 8-6
- ## P
- 
- packages
    - ORD\_DICOM, 5-2, 5-5
    - ORD\_DICOM\_ADMIN, 12-1, 12-2, 12-4
  - PACS, 4-2
  - photometric interpretation, D-1
  - Picture Archiving and Communication Systems (PACS), 4-2
  - PL/SQL
    - configuring your environment, 6-1

PL/SQL (*continued*)

- errors, [6-13](#)
- examples, [6-7](#), [6-9](#), [6-11](#), [6-12](#), [11-2–11-6](#), [11-8](#), [11-10](#)
- exceptions, [6-13](#)

PL/SQL packages

- ORD\_DICOM, [7-2](#), [7-12](#)

preference documents

- characteristics, [10-4](#)
- defined, [2-7](#)
- parameters defined, [10-44](#)
- writing, [10-44](#)
- XML schemas, [B-2](#)

private dictionary documents

- characteristics, [10-5](#)
- defined, [2-7](#)
- writing, [10-51](#)
- XML schemas, [B-2](#)

privileges

- DICOM administrator, [9-2](#)

procedures

- createDicomImage() for BFILES, [7-13](#)
- createDicomImage() for BLOBs, [7-14](#)
- createDicomImage() for ORDIImage, [7-15](#)
- deleteDocument(), [12-5](#)
- editDataModel(), [12-6](#)
- export(), [7-17](#)
- exportDocument(), [12-6](#)
- importFrom(), [7-18](#)
- insertDocument(), [12-7](#)
- makeAnonymous() for BFILES, [7-19](#)
- makeAnonymous() for BLOBs, [7-20](#)
- makeAnonymous() for ORDIImage, [7-21](#)
- processCopy() for BFILES, [7-22](#)
- processCopy() for BFILES with SOP instance UID, [7-23](#)
- processCopy() for BLOBs, [7-25](#)
- processCopy() for BLOBs with SOP instance UID, [7-26](#)
- processCopy() for ORDIImage, [7-27](#)
- processCopy() for ORDIImage with SOP instance UID, [7-28](#)
- publishDataModel(), [12-9](#)
- rollbackDataModel(), [12-10](#)
- setDataModel(), [5-5](#)
- writeMetadata() for BFILES, [7-30](#)
- writeMetadata() for BLOBs, [7-31](#)
- writeMetadata() for ORDIImage, [7-32](#)

processCopy() for BFILES procedure, [7-22](#)

processCopy() for BFILES with SOP instance UID procedure, [7-23](#)

processCopy() for BLOBs procedure, [7-25](#)

processCopy() for BLOBs with SOP instance UID procedure, [7-26](#)

processCopy() for ORDIImage procedure, [7-27](#)

processCopy() for ORDIImage with SOP instance UID procedure, [7-28](#)

processCopy() method, [D-1](#)

- order of operations for DICOM images, [D-6](#)

processCopy() to BLOBs method, [8-23](#)

processCopy() to ORDDicom method, [8-24](#)

processCopy() to ORDIImage method, [8-26](#)

protecting patient privacy, [6-10](#), [6-11](#)

- administrator tasks, [3-12](#)
- developer tasks, [3-12](#)

public views, [3-2](#), [5-6](#)

publishDataModel() procedure, [12-9](#)

---

## R

roles

- DICOM administrator, [9-2](#)
- DICOM protocol, [4-3](#)

rollbackDataModel() procedure, [12-10](#)

---

## S

sample applications

- Managing DICOM Format Data, [6-1](#), [E-1](#)

schemas

- DICOM crawler, [4-17](#)
- DICOM protocol adapter, [4-11](#)
- DICOM protocol documents, [10-27](#)
- DICOM WADO proxy, [4-20](#)

service object pair

- defined, [1-2](#)

services

- DICOM crawler, [4-5](#)
- DICOM WADO proxy, [4-5](#)

setDataModel() procedure, [5-5](#)

setProperties() method, [8-27](#)

SOP

- service object pair, [1-2](#)

standard dictionary documents

- characteristics, [10-5](#)
- defined, [2-7](#)
- writing, [10-55](#)
- XML schemas, [B-2](#)

stored tag list documents

- characteristics, [10-5](#)
- defined, [2-7](#)
- inserting into the repository, [9-8](#)
- writing, [10-57](#)
- XML schemas, [B-2](#)

---

## T

transfer syntax, [C-1](#)

- defined, [1-2](#)

---

## U

---

UID definition documents  
  characteristics, [10-5](#)  
  defined, [2-8](#)  
  writing, [10-58](#)  
  XML schemas, [B-2](#)  
updating mapping documents, [11-3](#)  
updating the data model, [3-4](#), [9-5](#)

---

## V

---

validating conformance, [6-12](#)  
  administrator tasks, [3-9](#)  
  developer tasks, [3-10](#)  
views  
  administrator, [3-2](#), [9-6](#), [12-11](#)  
  orddcm\_conformance\_vld\_msgs, [5-6](#)  
  orddcm\_constraint\_names, [5-7](#)  
  orddcm\_document\_refs, [12-11](#)  
  orddcm\_document\_types, [5-9](#)  
  orddcm\_documents, [5-8](#)

views (*continued*)  
  public, [3-2](#), [5-6](#)

---

## W

---

WADO, [4-3](#)  
Web Access to DICOM Objects (WADO), [1-2](#),  
  [4-3](#)  
writeMetadata() for BFILEs procedure, [7-30](#)  
writeMetadata() for BLOBs procedure, [7-31](#)  
writeMetadata() for ORDImage procedure, [7-32](#)  
writeMetadata() method, [8-28](#)

---

## X

---

XML metadata documents  
  examples, [2-14](#)  
XML schemas  
  finding user-defined, [9-4](#)  
  metadata, [A-1](#), [B-1](#)  
  registering with Oracle XML DB, [3-5](#), [9-3](#),  
  [10-38](#), [11-1](#), [11-3](#), [12-9](#), [B-1](#)