

Oracle® Database

Advanced Queuing User's Guide



12c Release 2 (12.2)

E83733-01

March 2017

The Oracle logo, consisting of a solid red square with the word "ORACLE" in white, uppercase, sans-serif font centered within it.

ORACLE®

Oracle Database Advanced Queuing User's Guide, 12c Release 2 (12.2)

E83733-01

Copyright © 1996, 2017, Oracle and/or its affiliates. All rights reserved.

Primary Author: Maitreyee Chaliha

Contributing Authors: Denis Raphaely, Neerja Bhatt, Charles Hall

Contributors: Alan Downing, Padmanabha Bhat, Longxing Deng , John Leinaweaver , Stella Kister, Qiang Liu, Anil Madan, Abhishek Saxena, James Wilson

This software and related documentation are provided under a license agreement containing restrictions on use and disclosure and are protected by intellectual property laws. Except as expressly permitted in your license agreement or allowed by law, you may not use, copy, reproduce, translate, broadcast, modify, license, transmit, distribute, exhibit, perform, publish, or display any part, in any form, or by any means. Reverse engineering, disassembly, or decompilation of this software, unless required by law for interoperability, is prohibited.

The information contained herein is subject to change without notice and is not warranted to be error-free. If you find any errors, please report them to us in writing.

If this is software or related documentation that is delivered to the U.S. Government or anyone licensing it on behalf of the U.S. Government, then the following notice is applicable:

U.S. GOVERNMENT END USERS: Oracle programs, including any operating system, integrated software, any programs installed on the hardware, and/or documentation, delivered to U.S. Government end users are "commercial computer software" pursuant to the applicable Federal Acquisition Regulation and agency-specific supplemental regulations. As such, use, duplication, disclosure, modification, and adaptation of the programs, including any operating system, integrated software, any programs installed on the hardware, and/or documentation, shall be subject to license terms and license restrictions applicable to the programs. No other rights are granted to the U.S. Government.

This software or hardware is developed for general use in a variety of information management applications. It is not developed or intended for use in any inherently dangerous applications, including applications that may create a risk of personal injury. If you use this software or hardware in dangerous applications, then you shall be responsible to take all appropriate fail-safe, backup, redundancy, and other measures to ensure its safe use. Oracle Corporation and its affiliates disclaim any liability for any damages caused by use of this software or hardware in dangerous applications.

Oracle and Java are registered trademarks of Oracle and/or its affiliates. Other names may be trademarks of their respective owners.

Intel and Intel Xeon are trademarks or registered trademarks of Intel Corporation. All SPARC trademarks are used under license and are trademarks or registered trademarks of SPARC International, Inc. AMD, Opteron, the AMD logo, and the AMD Opteron logo are trademarks or registered trademarks of Advanced Micro Devices. UNIX is a registered trademark of The Open Group.

This software or hardware and documentation may provide access to or information about content, products, and services from third parties. Oracle Corporation and its affiliates are not responsible for and expressly disclaim all warranties of any kind with respect to third-party content, products, and services unless otherwise set forth in an applicable agreement between you and Oracle. Oracle Corporation and its affiliates will not be responsible for any loss, costs, or damages incurred due to your access to or use of third-party content, products, or services, except as set forth in an applicable agreement between you and Oracle.

Contents

Preface

Audience	xxxii
Documentation Accessibility	xxxii
Related Documents	xxxii
Conventions	xxxiii

Changes in This Release for Oracle Database Advanced Queuing User's Guide

Changes in Oracle Database Advanced Queuing 12c Release 2 (12.2.)	xxxiv
Changes in Oracle Database Advanced Queuing 12c Release 1 (12.1.0.2)	xxxv
Changes in Oracle Database Advanced Queuing 12c Release 1 (12.1)	xxxv

1 Introduction to Oracle Database Advanced Queuing

1.1	What Is Queuing?	1-1
1.2	Oracle Database Advanced Queuing Leverages Oracle Database	1-2
1.3	Oracle Database Advanced Queuing in Integrated Application Environments	1-6
1.3.1	Oracle Database Advanced Queuing Client/Server Communication	1-7
1.3.2	Multiconsumer Dequeuing of the Same Message	1-8
1.3.3	Oracle Database Advanced Queuing Implementation of Workflows	1-10
1.3.4	Oracle Database Advanced Queuing Implementation of Publish/Subscribe	1-11
1.4	Buffered Messaging	1-14
1.5	Asynchronous Notifications	1-18
1.5.1	Views on Registration	1-21
1.5.2	Event-Based Notification	1-21
1.5.3	Notification Grouping by Time	1-21
1.6	Enqueue Features	1-22
1.7	Dequeue Features	1-24
1.8	Propagation Features	1-31
1.9	Message Format Transformation	1-38
1.10	Other Oracle Database Advanced Queuing Features	1-39

2 Basic Components of Oracle Database Advanced Queuing

2.1	Object Name	2-1
2.2	Type Name	2-2
2.3	AQ Agent Type	2-2
2.4	AQ Recipient List Type	2-3
2.5	AQ Agent List Type	2-3
2.6	AQ Subscriber List Type	2-3
2.7	AQ Registration Information List Type	2-3
2.8	AQ Post Information List Type	2-3
2.9	AQ Registration Information Type	2-3
2.10	AQ Notification Descriptor Type	2-5
2.11	AQ Message Properties Type	2-5
2.12	AQ Post Information Type	2-6
2.13	AQ\$_NTFN_MSGID_ARRAY Type	2-6
2.14	Enumerated Constants for AQ Administrative Interface	2-7
2.15	Enumerated Constants for AQ Operational Interface	2-7
2.16	AQ Background Processes	2-8
2.16.1	Queue Monitor Processes	2-8
2.16.2	Job Queue Processes	2-9
2.16.3	AQ Background Architecture	2-9

3 Oracle Database Advanced Queuing: Programmatic Interfaces

3.1	Programmatic Interfaces for Accessing Oracle Database Advanced Queuing	3-1
3.2	Using PL/SQL to Access Oracle Database Advanced Queuing	3-2
3.3	Using OCI and the Thin JDBC Driver to Access Oracle Database Advanced Queuing	3-3
3.4	Using OCCI to Access Oracle Database Advanced Queuing	3-3
3.5	Using Oracle Java Message Service (Oracle JMS) to Access Oracle Database Advanced Queuing	3-4
3.6	Using Oracle Database Advanced Queuing XML Servlet to Access Oracle Database Advanced Queuing	3-6
3.7	Comparing Oracle Database Advanced Queuing Programmatic Interfaces	3-6
3.7.1	Oracle Database Advanced Queuing Administrative Interfaces	3-6
3.7.2	Oracle Database Advanced Queuing Operational Interfaces	3-9

4 Managing Oracle Database Advanced Queuing

4.1	Oracle Database Advanced Queuing Compatibility Parameters	4-1
-----	---	-----

4.2	Queue Security and Access Control	4-2
4.2.1	Oracle Database Advanced Queuing Security	4-2
4.2.1.1	Administrator Role	4-2
4.2.1.2	User Role	4-3
4.2.1.3	Access to Oracle Database Advanced Queuing Object Types	4-3
4.2.2	Queue Security	4-3
4.2.3	Queue Privileges and Access Control	4-3
4.2.4	OCI Applications and Queue Access	4-4
4.2.5	Security Required for Propagation	4-4
4.2.6	Security Required for Non-Sharded Buffered Messages on Oracle RAC	4-4
4.3	Queue Table Export/Import	4-4
4.3.1	Exporting Queue Table Data	4-5
4.3.2	Importing Queue Table Data	4-6
4.3.3	Data Pump Export and Import	4-7
4.4	Oracle Enterprise Manager Support for Non-Sharded Queues	4-7
4.5	Using Oracle Database Advanced Queuing with XA	4-8
4.6	Restrictions on Queue Management	4-8
4.6.1	Subscribers	4-9
4.6.2	DML Not Supported on Queue Tables or Associated IOTs	4-9
4.6.3	Propagation from Object Queues with REF Payload Attributes	4-9
4.6.4	Collection Types in Message Payloads	4-9
4.6.5	Synonyms on Queue Tables and Queues	4-10
4.6.6	Synonyms on Object Types	4-10
4.6.7	Tablespace Point-in-Time Recovery	4-10
4.6.8	Virtual Private Database	4-10
4.7	Managing Propagation	4-10
4.7.1	EXECUTE Privileges Required for Propagation	4-11
4.7.2	Propagation from Object Queues	4-11
4.7.3	Optimizing Propagation	4-11
4.7.4	Handling Failures in Propagation	4-12

5 Oracle Database Advanced Queuing Performance and Scalability

5.1	Sharded Queues	5-1
5.1.1	Sharded Queues and the Message Cache	5-1
5.1.2	Sharded Queues and Enqueuing / Dequeuing Messages	5-2
5.1.3	Sharded Queues and Native JMS Support	5-2
5.1.4	Sharded Queues and Partitioning	5-3
5.1.5	Sharded Queues and Oracle Real Application Clusters (Oracle RAC)	5-3
5.1.6	Sharded Queue Restrictions	5-4
5.1.7	Sharded Queues Tuning	5-4

5.2	Non-Sharded Queues	5-5
5.2.1	Persistent Messaging Basic Tuning Tips	5-5
5.2.1.1	Memory Requirements	5-6
5.2.1.2	Using Storage Parameters	5-6
5.2.1.3	I/O Configuration	5-6
5.2.1.4	Running Enqueue and Dequeue Processes Concurrently in a Single Non-Sharded Queue Table	5-7
5.2.1.5	Running Enqueue and Dequeue Processes Serially in a Single Non-Sharded Queue Table	5-7
5.2.1.6	Creating Indexes on a Queue Table	5-7
5.2.1.7	Other Tips for Non-Sharded Queues	5-8
5.2.2	Propagation Tuning Tips	5-8
5.2.3	Buffered Messaging Tuning	5-9
5.2.3.1	Persistent Messaging Performance Overview for Non-Sharded Queues	5-9
5.2.3.2	Non-Sharded Queues and Oracle Real Application Clusters	5-9
5.2.3.3	Oracle Database Advanced Queuing in a Shared Server Environment	5-10
5.3	Performance Views	5-10

6 Internet Access to Oracle Database Advanced Queuing

6.1	Overview of Oracle Database Advanced Queuing Operations Over the Internet	6-1
6.1.1	Oracle Database Advanced Queuing Internet Operations Architecture	6-1
6.1.2	Internet Message Payloads	6-2
6.1.3	Configuring the Web Server to Authenticate Users Sending POST Requests	6-3
6.1.4	Client Requests Using HTTP	6-3
6.1.5	Oracle Database Advanced Queuing Servlet Responses Using HTTP	6-4
6.1.6	Oracle Database Advanced Queuing Propagation Using HTTP and HTTPS	6-4
6.2	Deploying the Oracle Database Advanced Queuing XML Servlet	6-5
6.3	Internet Data Access Presentation (IDAP)	6-6
6.3.1	SOAP Message Structure	6-7
6.3.1.1	SOAP Envelope	6-7
6.3.1.2	SOAP Header	6-7
6.3.1.3	SOAP Body	6-7
6.3.2	SOAP Method Invocation	6-7
6.3.2.1	HTTP Headers	6-7
6.3.2.2	Method Invocation Body	6-8
6.3.2.3	Results from a Method Request	6-9
6.4	Request and Response IDAP Documents	6-9

6.4.1	IDAP Client Requests for Enqueue	6-9
6.4.2	IDAP Client Requests for Dequeue	6-12
6.4.3	IDAP Client Requests for Registration	6-13
6.4.4	IDAP Client Requests to Commit a Transaction	6-14
6.4.5	IDAP Client Requests to Roll Back a Transaction	6-14
6.4.6	IDAP Server Response to an Enqueue Request	6-14
6.4.7	IDAP Server Response to a Dequeue Request	6-15
6.4.8	IDAP Server Response to a Register Request	6-15
6.4.9	IDAP Commit Response	6-15
6.4.10	IDAP Rollback Response	6-15
6.4.11	IDAP Notification	6-16
6.4.12	IDAP Response in Case of Error	6-16
6.5	Notification of Messages by E-Mail	6-16

7 Troubleshooting Oracle Database Advanced Queuing

7.1	Debugging Oracle Database Advanced Queuing Propagation Problems	7-1
7.2	Oracle Database Advanced Queuing Error Messages	7-3

8 Oracle Database Advanced Queuing Administrative Interface

8.1	Managing Non-Sharded Queue Tables	8-1
8.1.1	Creating a Queue Table	8-2
8.1.2	Altering a Queue Table	8-9
8.1.3	Dropping a Queue Table	8-10
8.1.4	Purging a Queue Table	8-11
8.1.5	Migrating a Queue Table	8-13
8.2	Managing Non-Sharded Queues	8-14
8.2.1	Creating a Queue	8-14
8.2.2	Altering a Queue	8-17
8.2.3	Starting a Queue	8-17
8.2.4	Stopping a Queue	8-18
8.2.5	Dropping a Queue	8-18
8.3	Managing Sharded Queues	8-18
8.3.1	Creating a Sharded Queue	8-19
8.3.2	Dropping a Sharded Queue	8-20
8.3.3	Altering a Sharded Queue	8-20
8.3.4	Setting a Queue Parameter	8-21
8.3.5	Unsetting a Queue Parameter	8-21
8.3.6	Getting a Queue Parameter	8-22
8.3.7	Creating an Exception Queue	8-22

8.4	Managing Transformations	8-23
8.4.1	Creating a Transformation	8-23
8.4.2	Modifying a Transformation	8-24
8.4.3	Dropping a Transformation	8-24
8.5	Granting and Revoking Privileges	8-25
8.5.1	Granting Oracle Database Advanced Queuing System Privileges	8-25
8.5.2	Revoking Oracle Database Advanced Queuing System Privileges	8-25
8.5.3	Granting Queue Privileges	8-26
8.5.4	Revoking Queue Privileges	8-26
8.6	Managing Subscribers	8-27
8.6.1	Adding a Subscriber	8-27
8.6.2	Altering a Subscriber	8-29
8.6.3	Removing a Subscriber	8-30
8.7	Managing Propagations	8-30
8.7.1	Scheduling a Queue Propagation	8-31
8.7.2	Verifying Propagation Queue Type	8-33
8.7.3	Altering a Propagation Schedule	8-34
8.7.4	Enabling a Propagation Schedule	8-35
8.7.5	Disabling a Propagation Schedule	8-35
8.7.6	Unscheduling a Queue Propagation	8-35
8.8	Managing Oracle Database Advanced Queuing Agents	8-36
8.8.1	Creating an Oracle Database Advanced Queuing Agent	8-36
8.8.2	Altering an Oracle Database Advanced Queuing Agent	8-37
8.8.3	Dropping an Oracle Database Advanced Queuing Agent	8-37
8.8.4	Enabling Database Access	8-37
8.8.5	Disabling Database Access	8-38
8.9	Adding an Alias to the LDAP Server	8-38
8.10	Deleting an Alias from the LDAP Server	8-38

9 Oracle Database Advanced Queuing and Messaging Gateway Views

9.1	DBA_QUEUE_TABLES: All Queue Tables in Database	9-3
9.2	USER_QUEUE_TABLES: Queue Tables in User Schema	9-3
9.3	ALL_QUEUE_TABLES: Queue Tables Accessible to the Current User	9-3
9.4	DBA_QUEUES: All Queues in Database	9-4
9.5	USER_QUEUES: Queues In User Schema	9-4
9.6	ALL_QUEUES: Queues for Which User Has Any Privilege	9-4
9.7	DBA_QUEUE_SCHEDULES: All Propagation Schedules	9-5
9.8	USER_QUEUE_SCHEDULES: Propagation Schedules in User Schema	9-5
9.9	QUEUE_PRIVILEGES: Queues for Which User Has Queue Privilege	9-5

9.10	AQ\$<Queue_Table_Name>: Messages in Queue Table	9-5
9.11	AQ\$<Queue_Table_Name_S>: Queue Subscribers	9-10
9.12	AQ\$<Queue_Table_Name_R>: Queue Subscribers and Their Rules	9-10
9.13	AQ\$Queue_Name_R: Queue Subscribers and Their Rules for Multi-consumer Queue	9-11
9.14	AQ\$Queue_Name_S: Queue Subscribers and Their Rules for Multi-consumer Queue	9-11
9.15	DBA_QUEUE_SUBSCRIBERS: All Queue Subscribers in Database	9-12
9.16	USER_QUEUE_SUBSCRIBERS: Queue Subscribers in User Schema	9-12
9.17	ALL_QUEUE_SUBSCRIBERS: Subscribers for Queues Where User Has Queue Privileges	9-12
9.18	DBA_TRANSFORMATIONS: All Transformations	9-13
9.19	DBA_ATTRIBUTE_TRANSFORMATIONS: All Transformation Functions	9-13
9.20	USER_TRANSFORMATIONS: User Transformations	9-13
9.21	USER_ATTRIBUTE_TRANSFORMATIONS: User Transformation Functions	9-14
9.22	DBA_SUBSCR_REGISTRATIONS: All Subscription Registrations	9-14
9.23	USER_SUBSCR_REGISTRATIONS: User Subscription Registrations	9-14
9.24	AQ\$INTERNET_USERS: Oracle Database Advanced Queuing Agents Registered for Internet Access	9-15
9.25	V\$AQ: Number of Messages in Different States in Database	9-15
9.26	V\$BUFFERED_QUEUES: All Buffered Queues in the Instance	9-16
9.27	V\$BUFFERED_SUBSCRIBERS: Subscribers for All Buffered Queues in the Instance	9-16
9.28	V\$BUFFERED_PUBLISHERS: All Buffered Publishers in the Instance	9-16
9.29	V\$PERSISTENT_QUEUES: All Active Persistent Queues in the Instance	9-17
9.30	V\$PERSISTENT_QMN_CACHE: Performance Statistics on Background Tasks for Persistent Queues	9-17
9.31	V\$PERSISTENT_SUBSCRIBERS: All Active Subscribers of the Persistent Queues in the Instance	9-17
9.32	V\$PERSISTENT_PUBLISHERS: All Active Publishers of the Persistent Queues in the Instance	9-18
9.33	V\$PROPAGATION_SENDER: Buffer Queue Propagation Schedules on the Sending (Source) Side	9-18
9.34	V\$PROPAGATION_RECEIVER: Buffer Queue Propagation Schedules on the Receiving (Destination) Side	9-18
9.35	V\$SUBSCR_REGISTRATION_STATS: Diagnosability of Notifications	9-19
9.36	V\$METRICGROUP: Information About the Metric Group	9-19
9.37	V\$AQ_MESSAGE_CACHE_STAT: Memory Management for Sharded Queues	9-19
9.38	V\$AQ_SHARDED_SUBSCRIBER_STAT: Sharded Queue Subscriber Statistics	9-20
9.39	V\$AQ_MESSAGE_CACHE_ADVICE: Simulated Metrics	9-21
9.40	V\$AQ_REMOTE_DEQUEUE_AFFINITY: Dequeue Affinity Instance List	9-23

9.41	V\$AQ_BACKGROUND_COORDINATOR: Performance Statistics for AQ's Master Background Coordinator Process (AQPC)	9-23
9.42	V\$AQ_JOB_COORDINATOR: Performance Statistics per Coordinator	9-24
9.43	V\$AQ_SERVER_POOL: Performance Statistics for all Servers	9-24
9.44	V\$AQ_CROSS_INSTANCE_JOBS: Cross Process Jobs Description	9-24
9.45	V\$AQ_NONDUR_REGISTRATIONS: Non-Durable Registrations	9-25
9.46	V\$AQ_NOTIFICATION_CLIENTS: Secure OCI Client Connections	9-25
9.47	V\$AQ_SUBSCRIBER_LOAD: Durable Subscribers	9-25
9.48	V\$AQ_NONDUR_SUBSCRIBER: Non-Durable Subscribers	9-26
9.49	V\$AQ_NONDUR_SUBSCRIBER_LWM: LWM of Non Durable Subscriber	9-26
9.50	V\$AQ_MESSAGE_CACHE: Performance Statistics	9-26
9.51	MGW_GATEWAY: Configuration and Status Information	9-26
9.52	MGW_AGENT_OPTIONS: Supplemental Options and Properties	9-28
9.53	MGW_LINKS: Names and Types of Messaging System Links	9-28
9.54	MGW_MQSERIES_LINKS: WebSphere MQ Messaging System Links	9-29
9.55	MGW_TIBRV_LINKS: TIB/Rendezvous Messaging System Links	9-30
9.56	MGW_FOREIGN_QUEUES: Foreign Queues	9-30
9.57	MGW_JOBS: Messaging Gateway Propagation Jobs	9-31
9.58	MGW_SUBSCRIBERS: Information for Subscribers	9-32
9.59	MGW_SCHEDULES: Information About Schedules	9-33

10 Oracle Database Advanced Queuing Operations Using PL/SQL

10.1	Using Secure Queues	10-1
10.2	Enqueuing Messages	10-2
10.3	Enqueuing an Array of Messages	10-11
10.4	Listening to One or More Queues	10-12
10.5	Dequeuing Messages	10-13
10.6	Dequeuing an Array of Messages	10-21
10.7	Registering for Notification	10-23
10.8	Unregistering for Notification	10-24
10.9	Posting for Subscriber Notification	10-24
10.10	Adding an Agent to the LDAP Server	10-25
10.11	Removing an Agent from the LDAP Server	10-26

11 Introduction to Oracle Java Message Service

11.1	General Features of JMS and Oracle JMS	11-1
11.1.1	JMS Connection and Session	11-1
11.1.1.1	ConnectionFactory Objects	11-2
11.1.1.2	Using AQjmsFactory to Obtain ConnectionFactory Objects	11-2
11.1.1.3	Using JNDI to Look Up ConnectionFactory Objects	11-2

11.1.1.4	JMS Connection	11-3
11.1.1.5	JMS Session	11-5
11.1.2	JMS Destination	11-6
11.1.2.1	Using a JMS Session to Obtain Destination Objects	11-6
11.1.2.2	Using JNDI to Look Up Destination Objects	11-7
11.1.2.3	JMS Destination Methods	11-7
11.1.3	System-Level Access Control in JMS	11-8
11.1.4	Destination-Level Access Control in JMS	11-8
11.1.5	Retention and Message History in JMS	11-8
11.1.6	Supporting Oracle Real Application Clusters in JMS	11-9
11.1.7	Supporting Statistics Views in JMS	11-9
11.2	Structured Payload/Message Types in JMS	11-10
11.2.1	JMS Message Headers	11-10
11.2.2	JMS Message Properties	11-11
11.2.3	JMS Message Bodies	11-12
11.2.3.1	StreamMessage	11-13
11.2.3.2	BytesMessage	11-13
11.2.3.3	MapMessage	11-13
11.2.3.4	TextMessage	11-14
11.2.3.5	ObjectMessage	11-14
11.2.3.6	AdtMessage	11-14
11.2.4	Using Message Properties with Different Message Types	11-15
11.2.5	Buffered Messaging with Oracle JMS	11-16
11.3	Buffered Messaging in JMS	11-17
11.4	JMS Point-to-Point Model Features	11-20
11.5	JMS Publish/Subscribe Model Features	11-22
11.5.1	JMS Publish/Subscribe Overview	11-22
11.5.2	DurableSubscriber	11-22
11.5.3	RemoteSubscriber	11-23
11.5.4	TopicPublisher	11-23
11.5.5	Recipient Lists	11-24
11.5.6	TopicReceiver	11-24
11.5.7	TopicBrowser	11-24
11.5.8	Setting Up JMS Publish/Subscribe Operations	11-25
11.6	JMS Message Producer Features	11-26
11.6.1	Priority and Ordering of Messages	11-26
11.6.2	Specifying a Message Delay	11-26
11.6.3	Specifying a Message Expiration	11-27
11.6.4	Message Grouping	11-27
11.7	JMS Message Consumer Features	11-27
11.7.1	Receiving Messages	11-28

11.7.2	Message Navigation in Receive	11-28
11.7.3	Browsing Messages	11-29
11.7.4	Remove No Data	11-29
11.7.5	Retry with Delay Interval	11-29
11.7.6	Asynchronously Receiving Messages Using MessageListener	11-30
11.7.7	Exception Queues	11-30
11.8	JMS Propagation	11-31
11.8.1	RemoteSubscriber	11-32
11.8.2	Scheduling Propagation	11-32
11.8.3	Enhanced Propagation Scheduling Capabilities	11-33
11.8.4	Exception Handling During Propagation	11-34
11.9	Message Transformation with JMS AQ	11-35
11.10	JMS Streaming	11-35
11.10.1	JMS Streaming with Enqueue	11-36
11.10.2	JMS Streaming with Dequeue	11-37
11.11	Java EE Compliance	11-40

12 Oracle Java Message Service Basic Operations

12.1	EXECUTE Privilege on DBMS_AQIN	12-1
12.2	Registering a ConnectionFactory	12-1
12.2.1	Registering Through the Database Using JDBC Connection Parameters	12-1
12.2.2	Registering Through the Database Using a JDBC URL	12-2
12.2.3	Registering Through LDAP Using JDBC Connection Parameters	12-3
12.2.4	Registering Through LDAP Using a JDBC URL	12-4
12.3	Unregistering a Queue/Topic ConnectionFactory	12-5
12.3.1	Unregistering Through the Database	12-5
12.3.2	Unregistering Through LDAP	12-5
12.4	Getting a QueueConnectionFactory or TopicConnectionFactory	12-6
12.4.1	Getting a QueueConnectionFactory with JDBC URL	12-6
12.4.2	Getting a QueueConnectionFactory with JDBC Connection Parameters	12-7
12.4.3	Getting a TopicConnectionFactory with JDBC URL	12-7
12.4.4	Getting a TopicConnectionFactory with JDBC Connection Parameters	12-8
12.4.5	Getting a QueueConnectionFactory or TopicConnectionFactory in LDAP	12-8
12.5	Getting a Queue or Topic in LDAP	12-9
12.6	Creating a Non-Sharded Queue Table	12-10
12.7	Creating a Queue	12-10
12.7.1	Creating a Point-to-Point Queue	12-11
12.7.2	Creating a Publish/Subscribe Topic	12-11

12.7.3	Creating a Sharded Queue for Point-to-Point Queue and Publish/Subscribe Topic	12-13
12.8	Getting a Non-Sharded Queue Table	12-13
12.9	Granting and Revoking Privileges	12-14
12.9.1	Granting Oracle Database Advanced Queuing System Privileges	12-14
12.9.2	Revoking Oracle Database Advanced Queuing System Privileges	12-15
12.9.3	Granting Publish/Subscribe Topic Privileges	12-15
12.9.4	Revoking Publish/Subscribe Topic Privileges	12-16
12.9.5	Granting Point-to-Point Queue Privileges	12-16
12.9.6	Revoking Point-to-Point Queue Privileges	12-17
12.10	Managing Destinations	12-17
12.10.1	Starting a Destination	12-17
12.10.2	Stopping a Destination	12-18
12.10.3	Altering a Destination	12-18
12.10.4	Dropping a Destination	12-19
12.11	Propagation Schedules	12-19
12.11.1	Scheduling a Propagation	12-19
12.11.2	Enabling a Propagation Schedule	12-20
12.11.3	Altering a Propagation Schedule	12-21
12.11.4	Disabling a Propagation Schedule	12-21
12.11.5	Unscheduling a Propagation	12-22

13 Oracle Java Message Service Point-to-Point

13.1	Creating a Connection with User Name/Password	13-1
13.2	Creating a Connection with Default ConnectionFactory Parameters	13-2
13.3	Creating a QueueConnection with User Name/Password	13-2
13.4	Creating a QueueConnection with an Open JDBC Connection	13-2
13.5	Creating a QueueConnection with Default ConnectionFactory Parameters	13-3
13.6	Creating a QueueConnection with an Open OracleOCIConnectionPool	13-3
13.7	Creating a Session	13-4
13.8	Creating a QueueSession	13-4
13.9	Creating a QueueSender	13-4
13.10	Sending Messages Using a QueueSender with Default Send Options	13-5
13.11	Sending Messages Using a QueueSender by Specifying Send Options	13-6
13.12	Creating a QueueBrowser for Standard JMS Type Messages	13-7
13.13	Creating a QueueBrowser for Standard JMS Type Messages, Locking Messages	13-7
13.14	Creating a QueueBrowser for Oracle Object Type Messages	13-8
13.15	Creating a QueueBrowser for Oracle Object Type Messages, Locking Messages	13-9
13.16	Creating a QueueReceiver for Standard JMS Type Messages	13-10

13.17	Creating a QueueReceiver for Oracle Object Type Messages	13-11
-------	--	-------

14 Oracle Java Message Service Publish/Subscribe

14.1	Creating a Connection with User Name/Password	14-2
14.2	Creating a Connection with Default ConnectionFactory Parameters	14-2
14.3	Creating a TopicConnection with User Name/Password	14-2
14.4	Creating a TopicConnection with Open JDBC Connection	14-3
14.5	Creating a TopicConnection with an Open OracleOCIConnectionPool	14-3
14.6	Creating a Session	14-3
14.7	Creating a TopicSession	14-4
14.8	Creating a TopicPublisher	14-4
14.9	Publishing Messages with Minimal Specification	14-4
14.10	Publishing Messages Specifying Topic	14-6
14.11	Publishing Messages Specifying Delivery Mode, Priority, and TimeToLive	14-6
14.12	Publishing Messages Specifying a Recipient List	14-7
14.13	Creating a DurableSubscriber for a JMS Topic Without Selector	14-8
14.14	Creating a DurableSubscriber for a JMS Topic with Selector	14-9
14.15	Creating a DurableSubscriber for an Oracle Object Type Topic Without Selector	14-10
14.16	Creating a DurableSubscriber for an Oracle Object Type Topic with Selector	14-11
14.17	Specifying Transformations for Topic Subscribers	14-13
14.18	Creating a Remote Subscriber for JMS Messages	14-14
14.19	Creating a Remote Subscriber for Oracle Object Type Messages	14-15
14.20	Specifying Transformations for Remote Subscribers	14-17
14.21	Unsubscribing a Durable Subscription for a Local Subscriber	14-18
14.22	Unsubscribing a Durable Subscription for a Remote Subscriber	14-19
14.23	Creating a TopicReceiver for a Topic of Standard JMS Type Messages	14-20
14.24	Creating a TopicReceiver for a Topic of Oracle Object Type Messages	14-21
14.25	Creating a TopicBrowser for Standard JMS Messages	14-22
14.26	Creating a TopicBrowser for Standard JMS Messages, Locking Messages	14-23
14.27	Creating a TopicBrowser for Oracle Object Type Messages	14-23
14.28	Creating a TopicBrowser for Oracle Object Type Messages, Locking Messages	14-24
14.29	Browsing Messages Using a TopicBrowser	14-25

15 Oracle Java Message Service Shared Interfaces

15.1	Oracle Database Advanced Queuing JMS Operational Interface: Shared Interfaces	15-1
15.1.1	Starting a JMS Connection	15-2

15.1.2	Getting a JMS Connection	15-2
15.1.3	Committing All Operations in a Session	15-2
15.1.4	Rolling Back All Operations in a Session	15-2
15.1.5	Getting the JDBC Connection from a Session	15-2
15.1.6	Getting the OracleOCIConnectionPool from a JMS Connection	15-2
15.1.7	Creating a BytesMessage	15-3
15.1.8	Creating a MapMessage	15-3
15.1.9	Creating a StreamMessage	15-3
15.1.10	Creating an ObjectMessage	15-3
15.1.11	Creating a TextMessage	15-3
15.1.12	Creating a JMS Message	15-4
15.1.13	Creating an AdtMessage	15-4
15.1.14	Setting a JMS Correlation Identifier	15-4
15.2	Specifying JMS Message Properties	15-4
15.2.1	Setting a Boolean Message Property	15-5
15.2.2	Setting a String Message Property	15-5
15.2.3	Setting an Integer Message Property	15-6
15.2.4	Setting a Double Message Property	15-6
15.2.5	Setting a Float Message Property	15-6
15.2.6	Setting a Byte Message Property	15-6
15.2.7	Setting a Long Message Property	15-7
15.2.8	Setting a Short Message Property	15-7
15.2.9	Setting an Object Message Property	15-7
15.3	Setting Default TimeToLive for All Messages Sent by a MessageProducer	15-8
15.4	Setting Default Priority for All Messages Sent by a MessageProducer	15-8
15.5	Creating an AQjms Agent	15-9
15.6	Receiving a Message Synchronously	15-9
15.6.1	Using a Message Consumer by Specifying Timeout	15-9
15.6.2	Using a Message Consumer Without Waiting	15-10
15.6.3	Receiving Messages from a Destination Using a Transformation	15-11
15.7	Specifying the Navigation Mode for Receiving Messages	15-12
15.8	Receiving a Message Asynchronously	15-12
15.8.1	Specifying a Message Listener at the Message Consumer	15-12
15.8.2	Specifying a Message Listener at the Session	15-14
15.9	Getting Message ID	15-14
15.9.1	Getting the Correlation Identifier	15-14
15.9.2	Getting the Message Identifier	15-14
15.10	Getting JMS Message Properties	15-14
15.10.1	Getting a Boolean Message Property	15-15
15.10.2	Getting a String Message Property	15-15
15.10.3	Getting an Integer Message Property	15-15

15.10.4	Getting a Double Message Property	15-15
15.10.5	Getting a Float Message Property	15-15
15.10.6	Getting a Byte Message Property	15-16
15.10.7	Getting a Long Message Property	15-16
15.10.8	Getting a Short Message Property	15-16
15.10.9	Getting an Object Message Property	15-16
15.11	Closing and Shutting Down	15-17
15.11.1	Closing a MessageProducer	15-17
15.11.2	Closing a Message Consumer	15-17
15.11.3	Stopping a JMS Connection	15-17
15.11.4	Closing a JMS Session	15-17
15.11.5	Closing a JMS Connection	15-17
15.12	Troubleshooting	15-18
15.12.1	Getting a JMS Error Code	15-18
15.12.2	Getting a JMS Error Number	15-18
15.12.3	Getting an Exception Linked to a JMS Exception	15-18
15.12.4	Printing the Stack Trace for a JMS Exception	15-18
15.12.5	Setting an Exception Listener	15-19
15.12.6	Getting an Exception Listener	15-19

16 Oracle Java Message Service Types Examples

16.1	How to Set Up the Oracle Database Advanced Queuing JMS Type Examples	16-1
16.2	JMS BytesMessage Examples	16-5
16.3	JMS StreamMessage Examples	16-9
16.4	JMS MapMessage Examples	16-14
16.5	More Oracle Database Advanced Queuing JMS Examples	16-20

17 Introduction to Oracle Messaging Gateway

17.1	Oracle Messaging Gateway Overview	17-1
17.2	Oracle Messaging Gateway Features	17-1
17.3	Oracle Messaging Gateway Architecture	17-3
17.3.1	Administration Package DBMS_MGWADM	17-3
17.3.2	Oracle Messaging Gateway Agent	17-4
17.3.3	Oracle Database	17-4
17.3.4	Non-Oracle Messaging Systems	17-4
17.4	Propagation Processing Overview	17-5
17.5	Oracle Database AQ Buffered Messages and Messaging Gateway	17-6

18 Getting Started with Oracle Messaging Gateway

18.1	Oracle Messaging Gateway Prerequisites	18-1
18.2	Loading and Setting Up Oracle Messaging Gateway	18-1
18.2.1	Loading Database Objects into the Database	18-2
18.2.2	Modifying listener.ora for the External Procedure	18-2
18.2.3	Modifying tnsnames.ora for the External Procedure	18-3
18.2.4	Setting Up an mgw.ora Initialization File	18-4
18.2.5	Creating an Oracle Messaging Gateway Administrator User	18-5
18.2.6	Creating an Oracle Messaging Gateway Agent User	18-5
18.2.7	Configuring Oracle Messaging Gateway Connection Information	18-5
18.2.8	Configuring Oracle Messaging Gateway in an Oracle RAC Environment	18-6
18.2.8.1	Configuring Connection Information for the MGW Agent Connections	18-6
18.2.8.2	Setting the Oracle RAC Instance for the Messaging Gateway Agent	18-7
18.3	Setting Up Non-Oracle Messaging Systems	18-7
18.3.1	Setting Up for TIB/Rendezvous	18-7
18.3.2	Setting Up for WebSphere MQ Base Java or JMS	18-8
18.4	Verifying the Oracle Messaging Gateway Setup	18-9
18.5	Unloading Oracle Messaging Gateway	18-9
18.6	Understanding the mgw.ora Initialization File	18-10
18.6.1	mgw.ora Initialization Parameters	18-10
18.6.2	mgw.ora Environment Variables	18-11
18.6.3	mgw.ora Java Properties	18-12
18.6.4	mgw.ora Comment Lines	18-14

19 Working with Oracle Messaging Gateway

19.1	Configuring the Oracle Messaging Gateway Agent	19-1
19.1.1	Creating a Messaging Gateway Agent	19-2
19.1.2	Removing a Messaging Gateway Agent	19-2
19.1.3	Setting Database Connection	19-2
19.1.4	Setting the Resource Limits	19-3
19.2	Starting and Shutting Down the Oracle Messaging Gateway Agent	19-3
19.2.1	Starting the Oracle Messaging Gateway Agent	19-3
19.2.2	Shutting Down the Oracle Messaging Gateway Agent	19-3
19.2.3	Oracle Messaging Gateway Agent Scheduler Job	19-4
19.2.4	Running the Oracle Messaging Gateway Agent on Oracle RAC	19-5
19.3	Configuring Messaging System Links	19-5
19.3.1	Creating a WebSphere MQ Base Java Link	19-6

19.3.2	Creating a WebSphere MQ JMS Link	19-8
19.3.3	Creating a WebSphere MQ Link to Use SSL	19-9
19.3.4	Creating a TIB/Rendezvous Link	19-11
19.3.5	Altering a Messaging System Link	19-12
19.3.6	Removing a Messaging System Link	19-12
19.3.7	Views for Messaging System Links	19-13
19.4	Configuring Non-Oracle Messaging System Queues	19-13
19.4.1	Registering a Non-Oracle Queue	19-13
19.4.1.1	Registering a WebSphere MQ Base Java Queue	19-14
19.4.1.2	Registering a WebSphere MQ JMS Queue or Topic	19-14
19.4.1.3	Registering a TIB/Rendezvous Subject	19-15
19.4.2	Unregistering a Non-Oracle Queue	19-15
19.4.3	View for Registered Non-Oracle Queues	19-15
19.5	Configuring Oracle Messaging Gateway Propagation Jobs	19-15
19.5.1	Propagation Job Overview	19-16
19.5.2	Creating an Oracle Messaging Gateway Propagation Job	19-17
19.5.3	Enabling and Disabling a Propagation Job	19-17
19.5.4	Resetting a Propagation Job	19-18
19.5.5	Altering a Propagation Job	19-18
19.5.6	Removing a Propagation Job	19-19
19.6	Propagation Jobs, Subscribers, and Schedules	19-19
19.6.1	Propagation Job, Subscriber, Schedule Interface Interoperability	19-20
19.6.2	Propagation Job, Subscriber, Schedule Views	19-21
19.6.3	Single Consumer Queue as Propagation Source	19-21
19.7	Configuration Properties	19-21
19.7.1	WebSphere MQ System Properties	19-22
19.7.2	TIB/Rendezvous System Properties	19-24
19.7.3	Optional Link Configuration Properties	19-25
19.7.4	Optional Foreign Queue Configuration Properties	19-27
19.7.5	Optional Job Configuration Properties	19-28

20 Oracle Messaging Gateway Message Conversion

20.1	Converting Oracle Messaging Gateway Non-JMS Messages	20-1
20.1.1	Overview of the Non-JMS Message Conversion Process	20-1
20.1.2	Oracle Messaging Gateway Canonical Types	20-2
20.1.3	Message Header Conversion	20-2
20.1.4	Handling Arbitrary Payload Types Using Message Transformations	20-3
20.1.5	Handling Logical Change Records	20-5
20.2	Message Conversion for WebSphere MQ	20-6
20.2.1	WebSphere MQ Message Header Mappings	20-7

20.2.2	WebSphere MQ Outbound Propagation	20-10
20.2.3	WebSphere MQ Inbound Propagation	20-11
20.3	Message Conversion for TIB/Rendezvous	20-12
20.3.1	AQ Message Property Mapping for TIB/Rendezvous	20-13
20.3.2	TIB/Rendezvous Outbound Propagation	20-14
20.3.3	TIB/Rendezvous Inbound Propagation	20-15
20.4	JMS Messages	20-16
20.4.1	JMS Outbound Propagation	20-17
20.4.2	JMS Inbound Propagation	20-17

21 Monitoring Oracle Messaging Gateway

21.1	Oracle Messaging Gateway Log Files	21-1
21.1.1	Sample Oracle Messaging Gateway Log File	21-1
21.1.2	Interpreting Exception Messages in an Oracle Messaging Gateway Log File	21-2
21.2	Monitoring the Oracle Messaging Gateway Agent Status	21-3
21.2.1	MGW_GATEWAY View	21-3
21.2.2	Oracle Messaging Gateway Irrecoverable Error Messages	21-4
21.2.3	Other Oracle Messaging Gateway Error Conditions	21-7
21.3	Monitoring Oracle Messaging Gateway Propagation	21-8
21.4	Oracle Messaging Gateway Agent Error Messages	21-9

22 Using ANYDATA Queues for User Messages

22.1	ANYDATA Queues and User Messages	22-1
22.1.1	ANYDATA Wrapper for User Messages Payloads	22-2
22.1.2	Programmatic Interfaces for Enqueue and Dequeue of User Messages	22-2
22.1.2.1	Enqueuing User Messages Using PL/SQL	22-3
22.1.2.2	Enqueuing User Messages Using OCI or JMS	22-3
22.1.2.3	Dequeuing User Messages Using PL/SQL	22-4
22.1.2.4	Dequeuing User Messages Using OCI or JMS	22-4
22.2	Message Propagation and ANYDATA Queues	22-5
22.3	Enqueuing User Messages in ANYDATA Queues	22-6
22.4	Dequeuing User Messages from ANYDATA Queues	22-8
22.5	Propagating User Messages from ANYDATA Queues to Typed Queues	22-10
22.6	Propagating User-Enqueued LCRs from ANYDATA Queues to Typed Queues	22-13

23 Oracle Streams Messaging Examples

23.1	Overview of Messaging Example	23-1
23.2	Setting Up Users and Creating an ANYDATA Queue	23-2
23.3	Creating Enqueue Procedures	23-4
23.4	Configuring an Apply Process	23-7
23.5	Configuring Explicit Dequeue	23-11
23.6	Enqueuing Messages	23-13
23.7	Dequeuing Messages Explicitly and Querying for Applied Messages	23-16
23.8	Enqueuing and Dequeuing Messages Using JMS	23-18

A Nonpersistent Queues

A.1	Creating Nonpersistent Queues	A-1
A.2	Managing Nonpersistent Queues	A-2
A.3	Compatibility of Nonpersistent Queues	A-2
A.4	Nonpersistent Queue Notification	A-2
A.5	Restrictions on Nonpersistent Queues	A-3

B Oracle JMS and Oracle AQ XML Servlet Error Messages

B.1	Oracle JMS Error Messages	B-1
B.2	Oracle AQ XML Servlet Error Messages	B-14

Glossary

Index

List of Examples

4-1	Creating Objects Containing VARRAYs	4-9
8-1	Setting Up AQ Administrative Users	8-7
8-2	Setting Up AQ Administrative Example Types	8-7
8-3	Creating a Queue Table for Messages of Object Type	8-7
8-4	Creating a Queue Table for Messages of RAW Type	8-7
8-5	Creating a Queue Table for Messages of LOB Type	8-8
8-6	Creating a Queue Table for Messages of XMLType	8-8
8-7	Creating a Queue Table for Grouped Messages	8-8
8-8	Creating Queue Tables for Prioritized Messages and Multiple Consumers	8-8
8-9	Creating a Queue Table with Commit-Time Ordering	8-8
8-10	Creating an 8.1-Compatible Queue Table for Multiple Consumers	8-9
8-11	Creating a Queue Table in a Specified Tablespace	8-9
8-12	Creating a Queue Table with Freelists or Freelist Groups	8-9
8-13	Altering a Queue Table by Changing the Primary and Secondary Instances	8-10
8-14	Altering a Queue Table by Changing the Comment	8-10
8-15	Dropping a Queue Table	8-11
8-16	Dropping a Queue Table with force Option	8-11
8-17	Purging All Messages in a Queue Table	8-12
8-18	Purging All Messages in a Named Queue	8-12
8-19	Purging All PROCESSED Messages in a Named Queue	8-12
8-20	Purging All Messages in a Named Queue and for a Named Consumer	8-13
8-21	Purging All Messages from a Named Sender	8-13
8-22	Upgrading a Queue Table from 8.1-Compatible to 10.0-Compatible	8-14
8-23	Creating a Queue for Messages of Object Type	8-15
8-24	Creating a Queue for Messages of RAW Type	8-16
8-25	Creating a Queue for Messages of LOB Type	8-16
8-26	Creating a Queue for Grouped Messages	8-16
8-27	Creating a Queue for Prioritized Messages	8-16
8-28	Creating a Queue for Prioritized Messages and Multiple Consumers	8-16
8-29	Creating a Queue to Demonstrate Propagation	8-16
8-30	Creating an 8.1-Style Queue for Multiple Consumers	8-17
8-31	Altering a Queue by Changing Retention Time	8-17
8-32	Starting a Queue with Both Enqueue and Dequeue Enabled	8-17
8-33	Starting a Queue for Dequeue Only	8-18
8-34	Stopping a Queue	8-18

8-35	Dropping a Standard Queue	8-18
8-36	Creating a Transformation	8-24
8-37	Granting AQ System Privileges	8-25
8-38	Revoking AQ System Privileges	8-26
8-39	Granting Queue Privilege	8-26
8-40	Revoking Dequeue Privilege	8-27
8-41	Adding a Subscriber at a Designated Queue at a Database Link	8-28
8-42	Adding a Single Consumer Queue at a Database Link as a Subscriber	8-28
8-43	Adding a Subscriber with a Rule	8-29
8-44	Adding a Subscriber and Specifying a Transformation	8-29
8-45	Propagating from a Multiple-Consumer Queue to a Single Consumer Queue	8-29
8-46	Altering a Subscriber Rule	8-29
8-47	Removing a Subscriber	8-30
8-48	Scheduling a Propagation to Queues in the Same Database	8-32
8-49	Scheduling a Propagation to Queues in Another Database	8-33
8-50	Scheduling Queue-to-Queue Propagation	8-33
8-51	Verifying a Queue Type	8-34
8-52	Altering a Propagation Schedule to Queues in the Same Database	8-34
8-53	Altering a Propagation Schedule to Queues in Another Database	8-34
8-54	Enabling a Propagation to Queues in the Same Database	8-35
8-55	Enabling a Propagation to Queues in Another Database	8-35
8-56	Disabling a Propagation to Queues in the Same Database	8-35
8-57	Disabling a Propagation to Queues in Another Database	8-35
8-58	Unscheduling a Propagation to Queues in the Same Database	8-36
8-59	Unscheduling a Propagation to Queues in Another Database	8-36
10-1	Enqueuing a Message, Specifying Queue Name and Payload	10-6
10-2	Enqueuing a Message, Specifying Priority	10-7
10-3	Creating an Enqueue Procedure for LOB Type Messages	10-7
10-4	Enqueuing a LOB Type Message	10-8
10-5	Enqueuing Multiple Messages	10-8
10-6	Adding Subscribers RED and GREEN	10-9
10-7	Enqueuing Multiple Messages to a Multiconsumer Queue	10-9
10-8	Enqueuing Grouped Messages	10-9
10-9	Enqueuing a Message, Specifying Delay and Expiration	10-10
10-10	Enqueuing a Message, Specifying a Transformation	10-10
10-11	Enqueuing an Array of Messages	10-11
10-12	Listening to a Single-Consumer Queue with Zero Timeout	10-13

10-13	Dequeuing Object Type Messages	10-18
10-14	Creating a Dequeue Procedure for LOB Type Messages	10-18
10-15	Dequeuing LOB Type Messages	10-19
10-16	Dequeuing Grouped Messages	10-19
10-17	Dequeuing Messages for RED from a Multiconsumer Queue	10-19
10-18	Dequeue in Browse Mode and Remove Specified Message	10-20
10-19	Dequeue in Locked Mode and Remove Specified Message	10-20
10-20	Dequeuing an Array of Messages	10-22
10-21	Registering for Notifications	10-24
10-22	Posting Object-Type Messages	10-25
12-1	Registering Through the Database Using JDBC Connection Parameters	12-2
12-2	Registering Through the Database Using a JDBC URL	12-3
12-3	Registering Through LDAP Using JDBC Connection Parameters	12-3
12-4	Registering Through LDAP Using a JDBC URL	12-4
12-5	Unregistering Through the Database	12-5
12-6	Unregistering Through LDAP	12-6
12-7	Getting a QueueConnectionFactory with JDBC URL	12-7
12-8	Getting a QueueConnectionFactory with JDBC Connection Parameters	12-7
12-9	Getting a TopicConnectionFactory with JDBC URL	12-8
12-10	Getting a TopicConnectionFactory with JDBC Connection Parameters	12-8
12-11	Getting a QueueConnectionFactory or TopicConnectionFactory in LDAP	12-9
12-12	Getting a Queue or Topic in LDAP	12-9
12-13	Creating a Queue Table	12-10
12-14	Creating a Point-to-Point Queue	12-11
12-15	Creating a Publish/Subscribe Topic	12-12
12-16	Specifying Max Retries and Max Delays in Messages	12-12
12-17	Getting a Queue Table	12-14
12-18	Granting Oracle Database Advanced Queuing System Privileges	12-15
12-19	Revoking Oracle Database Advanced Queuing System Privileges	12-15
12-20	Granting Publish/Subscribe Topic Privileges	12-16
12-21	Revoking Publish/Subscribe Topic Privileges	12-16
12-22	Granting Point-to-Point Queue Privileges	12-16
12-23	Revoking Point-to-Point Queue Privileges	12-17
12-24	Starting a Destination	12-18
12-25	Stopping a Destination	12-18
12-26	Altering a Destination	12-19
12-27	Dropping a Destination	12-19

12-28	Scheduling a Propagation	12-20
12-29	Enabling a Propagation Schedule	12-20
12-30	Altering a Propagation Schedule	12-21
12-31	Disabling a Propagation Schedule	12-21
12-32	Unscheduling a Propagation	12-22
13-1	Creating a QueueConnection with User Name/Password	13-2
13-2	Creating a QueueConnection with an Open JDBC Connection	13-3
13-3	Creating a QueueConnection from a Java Procedure Inside Database	13-3
13-4	Creating a QueueConnection with an Open OracleOCIConnectionPool	13-4
13-5	Creating a Transactional QueueSession	13-4
13-6	Creating a Sender to Send Messages to Any Queue	13-5
13-7	Creating a Sender to Send Messages to a Specific Queue	13-5
13-8	Sending Messages Using a QueueSender by Specifying Send Options 1	13-6
13-9	Sending Messages Using a QueueSender by Specifying Send Options 2	13-6
13-10	Creating a QueueBrowser Without a Selector	13-7
13-11	Creating a QueueBrowser With a Specified Selector	13-7
13-12	Creating a QueueBrowser Without a Selector, Locking Messages	13-8
13-13	Creating a QueueBrowser With a Specified Selector, Locking Messages	13-8
13-14	Creating a QueueBrowser for ADTMessages	13-9
13-15	Creating a QueueBrowser for AdtMessages, Locking Messages	13-10
13-16	Creating a QueueReceiver Without a Selector	13-11
13-17	Creating a QueueReceiver With a Specified Selector	13-11
13-18	Creating a QueueReceiver for AdtMessage Messages	13-12
14-1	Creating a TopicConnection with User Name/Password	14-2
14-2	Creating a TopicConnection with Open JDBC Connection	14-3
14-3	Creating a TopicConnection with New JDBC Connection	14-3
14-4	Creating a TopicConnection with Open OracleOCIConnectionPool	14-3
14-5	Creating a TopicSession	14-4
14-6	Publishing Without Specifying Topic	14-5
14-7	Publishing Specifying Correlation and Delay	14-5
14-8	Publishing Specifying Topic	14-6
14-9	Publishing Specifying Priority and TimeToLive	14-7
14-10	Publishing Specifying a Recipient List Overriding Topic Subscribers	14-8
14-11	Creating a Durable Subscriber for a JMS Topic Without Selector	14-9
14-12	Creating a Durable Subscriber for a JMS Topic With Selector	14-10
14-13	Creating a Durable Subscriber for an Oracle Object Type Topic Without Selector	14-11
14-14	Creating a Durable Subscriber for an Oracle Object Type Topic With Selector	14-12

14-15	Sending Messages to a Destination Using a Transformation	14-13
14-16	Specifying Transformations for Topic Subscribers	14-13
14-17	Creating a Remote Subscriber for Topics of JMS Messages	14-15
14-18	Creating a Remote Subscriber for Topics of Oracle Object Type Messages	14-16
14-19	Specifying Transformations for Remote Subscribers	14-17
14-20	Unsubscribing a Durable Subscription for a Local Subscriber	14-18
14-21	Unsubscribing a Durable Subscription for a Remote Subscriber	14-19
14-22	Creating a TopicReceiver for Standard JMS Type Messages	14-20
14-23	Creating a TopicReceiver for Oracle Object Type Messages	14-21
14-24	Creating a TopicBrowser Without a Selector	14-22
14-25	Creating a TopicBrowser With a Specified Selector	14-22
14-26	Creating a TopicBrowser Without a Selector, Locking Messages While Browsing	14-23
14-27	Creating a TopicBrowser With a Specified Selector, Locking Messages	14-23
14-28	Creating a TopicBrowser for AdtMessage Messages	14-24
14-29	Creating a TopicBrowser for AdtMessage Messages, Locking Messages	14-25
14-30	Creating a TopicBrowser with a Specified Selector	14-26
15-1	Getting Underlying JDBC Connection from JMS Session	15-2
15-2	Getting Underlying OracleOCIConnectionPool from JMS Connection	15-3
15-3	Setting Default TimeToLive for All Messages Sent by a MessageProducer	15-8
15-4	Setting Default Priority Value for All Messages Sent by QueueSender	15-8
15-5	Setting Default Priority Value for All Messages Sent by TopicPublisher	15-8
15-6	Using a Message Consumer by Specifying Timeout	15-9
15-7	JMS: Blocking Until a Message Arrives	15-10
15-8	JMS: Nonblocking Messages	15-10
15-9	JMS: Receiving Messages from a Destination Using a Transformation	15-11
15-10	Specifying Navigation Mode for Receiving Messages	15-12
15-11	Specifying Message Listener at Message Consumer	15-13
15-12	Getting Message Property as an Object	15-17
15-13	Specifying Exception Listener for Connection	15-19
15-14	Using ExceptionListener with MessageListener	15-19
15-15	Getting the Exception Listener for the Connection	15-23
16-1	Setting Up Environment for Running JMS Types Examples	16-1
16-2	Setting Up the Examples	16-5
16-3	Populating and Enqueuing a BytesMessage	16-5
16-4	Dequeuing and Retrieving JMS BytesMessage Data	16-7
16-5	Populating and Enqueuing a JMS StreamMessage	16-9
16-6	Dequeuing and Retrieving Data From a JMS StreamMessage	16-11

16-7	Populating and Enqueuing a JMS MapMessage	16-15
16-8	Dequeuing and Retrieving Data From a JMS MapMessage	16-17
16-9	Enqueuing a Large TextMessage	16-20
16-10	Enqueuing a Large BytesMessage	16-21
18-1	Adding Static Service Information for a Listener	18-2
18-2	Configuring MGW_AGENT	18-4
18-3	Creating a Messaging Gateway Administrator User	18-5
18-4	Creating a Messaging Gateway Agent User	18-5
18-5	Configuring Messaging Gateway Connection Information	18-6
18-6	Setting Java Properties	18-8
19-1	Creating a Messaging Gateway Agent	19-2
19-2	Removing a Messaging Gateway Agent	19-2
19-3	Setting Database Connection Information	19-2
19-4	Setting the Resource Limits	19-3
19-5	Starting the Messaging Gateway Agent	19-3
19-6	Shutting Down the Messaging Gateway Agent	19-4
19-7	Configuring a WebSphere MQ Base Java Link	19-7
19-8	Configuring a WebSphere MQ JMS Link	19-9
19-9	Configuring a WebSphere MQ Base Java Link for SSL	19-10
19-10	Configuring a TIB/Rendezvous Link	19-12
19-11	Altering a WebSphere MQ Link	19-12
19-12	Removing a Messaging Gateway Link	19-13
19-13	Listing All Messaging Gateway Links	19-13
19-14	Checking Messaging System Link Configuration Information	19-13
19-15	Registering a WebSphere MQ Base Java Queue	19-14
19-16	Unregistering a Non-Oracle Queue	19-15
19-17	Checking Which Queues Are Registered	19-15
19-18	Creating a Messaging Gateway Propagation Job	19-17
19-19	Enabling a Messaging Gateway Propagation Job	19-18
19-20	Disabling a Messaging Gateway Propagation Job	19-18
19-21	Resetting a Propagation Job	19-18
19-22	Altering Propagation Job by Adding an Exception Queue	19-18
19-23	Altering Propagation Job by Changing the Polling Interval	19-18
19-24	Removing a Propagation Job	19-19
20-1	Transformation Function Signature	20-4
20-2	Creating a Transformation	20-4
20-3	Registering a Transformation	20-4

20-4	Outbound LCR Transformation	20-6
20-5	Inbound LCR Transformation	20-6
21-1	Sample Messaging Gateway Log File	21-1
21-2	Sample Exception Message	21-3
22-1	Creating ANYDATA Users	22-7
22-2	Creating an ANYDATA Queue	22-7
22-3	Adding a Subscriber to the ANYDATA Queue	22-7
22-4	Associating a User with an AQ_AGENT	22-8
22-5	Creating an Enqueue Procedure	22-8
22-6	Enqueuing a VARCHAR2 Message into an ANYDATA Queue	22-8
22-7	Enqueuing a NUMBER Message into an ANYDATA Queue	22-8
22-8	Enqueuing a User-Defined Type Message into an ANYDATA Queue	22-8
22-9	Determining the Consumer of Messages in a Queue	22-9
22-10	Creating a Dequeue Procedure for an ANYDATA Queue	22-9
22-11	Dequeuing Messages from an ANYDATA Queue	22-10
22-12	Granting EXECUTE Privilege on a Type	22-11
22-13	Creating a Typed Destination Queue	22-11
22-14	Creating a Database Link	22-12
22-15	Creating a Function to Extract a Typed Object from an ANYDATA Object	22-12
22-16	Creating an ANYDATA to Typed Object Transformation	22-12
22-17	Creating Subscriber ADDRESS_AGENT_REMOTE	22-12
22-18	Scheduling Propagation from an ANYDATA Queue to a Typed Queue	22-13
22-19	Enqueuing a Typed Message in an ANYDATA Wrapper	22-13
22-20	Viewing the Propagated Message	22-13
22-21	Creating a Queue of Type LCR\$_ROW_RECORD	22-15
22-22	Creating an ANYDATA to LCR\$_ROW_RECORD Transformation	22-15
22-23	Creating Subscriber ROW_LCR_AGENT_REMOTE	22-15
22-24	Creating a Procedure to Construct and Enqueue a Row LCR	22-15
22-25	Creating and Enqueuing a Row LCR	22-16
22-26	Viewing the Propagated LCR	22-17
23-1	Setting Up ANYDATA Users	23-3
23-2	Creating an ANYDATA Queue	23-3
23-3	Enabling Enqueue on the ANYDATA Queue	23-4
23-4	Creating an Orders Type	23-5
23-5	Creating a Customers Type	23-5
23-6	Creating a Procedure to Enqueue Non-LCR Messages	23-6
23-7	Creating a Procedure to Construct and Enqueue Row LCR Events	23-6

23-8	Creating a Function to Determine the Value of the Action Attribute	23-8
23-9	Creating a Message Handler	23-8
23-10	Creating an Evaluation Context for the Rule Set	23-9
23-11	Creating a Rule Set for the Apply Process	23-9
23-12	Creating a Rule that Evaluates to TRUE if Action Is Apply	23-9
23-13	Creating a Rule that Evaluates to TRUE for Row LCR Events	23-10
23-14	Adding Rules to the Rule Set	23-10
23-15	Creating an Apply Process	23-10
23-16	Granting EXECUTE Privilege on the Rule Set To oe User	23-10
23-17	Starting the Apply Process	23-11
23-18	Creating an Agent for Explicit Dequeue	23-11
23-19	Associating User oe with Agent explicit_dq	23-12
23-20	Adding a Subscriber to the oe_queue Queue	23-12
23-21	Creating a Procedure to Dequeue Messages Explicitly	23-12
23-22	Enqueuing Non-LCR Messages to Be Dequeued by an Apply Process	23-14
23-23	Enqueuing Non-LCR Messages to Be Dequeued Explicitly	23-15
23-24	Enqueuing Row LCRs to Be Dequeued by an Apply Process	23-15
23-25	Dequeuing Messages Explicitly	23-17
23-26	Querying for Applied Messages	23-17
23-27	Granting EXECUTE on DBMS_AQIN to User oe	23-21
23-28	Enabling JMS Types on an ANYDATA Queue	23-21
23-29	Creating Oracle Object Types address and person	23-21
23-30	Creating Java Classes That Map to Oracle Object Types	23-21
23-31	Java Code for Enqueuing Messages	23-21
23-32	Java Code for Dequeuing Messages	23-24
23-33	Compiling StreamsEnq.java and StreamsDeq.java	23-27
23-34	Running StreamsEnq	23-27
23-35	Running StreamsDeq	23-27

List of Figures

1-1	Integrated Application Environment Using Oracle Database Advanced Queuing	1-6
1-2	Client/Server Communication Using Oracle Database Advanced Queuing	1-7
1-3	Communication Using a Multiconsumer Queue	1-9
1-4	Explicit and Implicit Recipients of Messages	1-10
1-5	Implementing a Workflow using Oracle Database Advanced Queuing	1-11
1-6	Point-to-Point Messaging	1-12
1-7	Publish/Subscribe Mode	1-12
1-8	Implementing Publish/Subscribe using Oracle Database Advanced Queuing	1-13
1-9	Message Propagation in Oracle Database Advanced Queuing	1-34
1-10	Transformations in Application Integration	1-39
1-11	Architecture for Performing Oracle Database Advanced Queuing Operations Using HTTP	1-42
6-1	Architecture for Performing Oracle Database Advanced Queuing Operations Using HTTP	6-2
6-2	HTTP Oracle Database Advanced Queuing Propagation	6-5
11-1	Structure of Oracle Database Advanced Queuing Entries in LDAP Server	11-3
17-1	Messaging Gateway Architecture	17-3
20-1	Non-JMS Message Conversion	20-2
20-2	Oracle Database Advanced Queuing Message Conversion	20-3
20-3	Message Conversion for WebSphere MQ Using MGW_BASIC_MSG_T	20-7
20-4	Message Conversion for TIB/Rendezvous	20-12
20-5	JMS Message Propagation	20-16
23-1	Example Oracle Streams Messaging Environment	23-2

List of Tables

2-1	AQ\$_REG_INFO Type Attributes	2-4
2-2	AQ\$_DESCRIPTOR Attributes	2-5
2-3	Enumerated Constants in the Oracle Database Advanced Queuing Administrative Interface	2-7
2-4	Enumerated Constants in the Oracle Database Advanced Queuing Operational Interface	2-7
3-1	Oracle Database Advanced Queuing Programmatic Interfaces	3-1
3-2	Comparison of Oracle Database Advanced Queuing Programmatic Interfaces: Administrative Interface	3-7
3-3	Comparison of Oracle Database Advanced Queuing Programmatic Interfaces: Operational Interface—Create Connection, Session, Message Use Cases	3-10
3-4	Comparison of Oracle Database Advanced Queuing Programmatic Interfaces: Operational Interface—Enqueue Messages to a Single-Consumer Queue, Point-to-Point Model Use Cases	3-10
3-5	Comparison of Oracle Database Advanced Queuing Programmatic Interfaces: Operational Interface—Publish Messages to a Multiconsumer Queue/Topic, Publish/Subscribe Model Use Cases	3-12
3-6	Comparison of Oracle Database Advanced Queuing Programmatic Interfaces: Operational Interface—Subscribing for Messages in a Multiconsumer Queue/Topic, Publish/Subscribe Model Use Cases	3-14
3-7	Comparison of Oracle Database Advanced Queuing Programmatic Interfaces: Operational Interface—Browse Messages in a Queue Use Cases	3-15
3-8	Comparison of Oracle Database Advanced Queuing Programmatic Interfaces: Operational Interface—Receive Messages from a Queue/Topic Use Cases	3-15
3-9	Comparison of Oracle Database Advanced Queuing Programmatic Interfaces: Operational Interface—Register to Receive Messages Asynchronously from a Queue/Topic Use Cases	3-17
4-1	Operations and Required Privileges	4-3
8-1	CREATE_SHARDED_QUEUE Procedure Parameters	8-20
8-2	ALTER_SHARDED_QUEUE Procedure Parameters	8-21
8-3	SET_QUEUE_PARAMETER Procedure Parameters	8-21
8-4	UNSET_QUEUE_PARAMETER Procedure Parameters	8-22
8-5	GET_QUEUE_PARAMETER Procedure Parameters	8-22
8-6	CREATE_EXCEPTION_QUEUE Procedure Parameters	8-23
9-1	AQ\$<Queue_Table_Name> View	9-7
9-2	AQ\$<Queue_Table_Name_S> View	9-10

9-3	AQ\$<Queue_Table_Name_R> View	9-10
9-4	AQ\$Queue_Name_R: Queue Subscribers and Their Rules for Multi-consumer Queue	9-11
9-5	AQ\$Queue_Name_S: Queue Subscribers and Their Rules for Multi-consumer Queue	9-11
9-6	AQ\$INTERNET_USERS View	9-15
9-7	V\$AQ_MESSAGE_CACHE_STAT View	9-19
9-8	V\$AQ_SHARDED_SUBSCRIBER_STAT View	9-21
9-9	V\$AQ_MESSAGE_CACHE_ADVICE View	9-21
9-10	V\$AQ_REMOTE_DEQUEUE_AFFINITY View	9-23
9-11	MGW_GATEWAY View Properties	9-27
9-12	MGW_AGENT_OPTIONS View	9-28
9-13	MGW_LINKS View Properties	9-29
9-14	MGW_MQSERIES_LINKS View Properties	9-29
9-15	MGW_TIBRV_LINKS View Properties	9-30
9-16	MGW_FOREIGN_QUEUES View Properties	9-30
9-17	MGW_JOBS View	9-31
9-18	MGW_SUBSCRIBERS View Properties	9-32
9-19	MGW_SCHEDULES View Properties	9-33
11-1	StreamMessage Conversion	11-13
11-2	MapMessage Conversion	11-14
11-3	Oracle Database AQ and Oracle JMS Buffered Messaging Constants	11-17
18-1	SID_DESC Parameters	18-3
19-1	Messaging Gateway Propagation Job Subprograms	19-20
19-2	WebSphere MQ Link Properties	19-22
19-3	Optional Configuration Properties for WebSphere MQ Base Java	19-23
19-4	Optional Configuration Properties for WebSphere MQ JMS	19-23
19-5	TIB/Rendezvous Link Properties	19-24
19-6	Optional Properties for TIB/Rendezvous	19-25
20-1	MGW Names for WebSphere MQ Header Values	20-8
20-2	Default Priority Mappings for Propagation	20-10
20-3	TIB/Rendezvous Datatype Mapping	20-13
20-4	TIB/Rendezvous and MGW Names for Oracle Database Advanced Queuing Message Properties	20-14
20-5	Oracle JMS Message Conversion	20-16
22-1	Propagation Between Different Types of Queues	22-5
A-1	Actions Performed for Nonpersistent Queues When RAW Presentation Specified	A-2
A-2	Actions Performed for Nonpersistent Queues When XML Presentation Specified	A-3

Preface

This guide describes features of application development and integration using Oracle Database Advanced Queuing (AQ). This information applies to versions of the Oracle Database server that run on all platforms, unless otherwise specified.

This Preface contains these topics:

- [Audience](#)
- [Documentation Accessibility](#)
- [Related Documents](#)
- [Conventions](#)

Audience

This guide is intended for developers of applications that use Oracle Database Advanced Queuing.

To use this guide, you need knowledge of an application development language and object-relational database management concepts.

Documentation Accessibility

For information about Oracle's commitment to accessibility, visit the Oracle Accessibility Program website at <http://www.oracle.com/pls/topic/lookup?ctx=acc&id=docacc>.

Access to Oracle Support

Oracle customers that have purchased support have access to electronic support through My Oracle Support. For information, visit <http://www.oracle.com/pls/topic/lookup?ctx=acc&id=info> or visit <http://www.oracle.com/pls/topic/lookup?ctx=acc&id=trs> if you are hearing impaired.

Related Documents

For more information, see these Oracle resources:

- *Oracle Database Development Guide*
- *Oracle Database PL/SQL Language Reference*
- *Oracle Database Advanced Queuing Java API Reference*
- *Oracle Database PL/SQL Packages and Types Reference*
- *Oracle Streams Concepts and Administration*

- *Oracle XML DB Developer's Guide*

Many of the examples in this guide use the sample schemas, which are installed by default when you select the Basic Installation option with an Oracle Database installation. See *Oracle Database Sample Schemas* for information on how these schemas were created and how you can use them.

Conventions

The following text conventions are used in this guide:

Convention	Meaning
boldface	Boldface type indicates graphical user interface elements associated with an action, or terms defined in text or the glossary.
<i>italic</i>	Italic type indicates book titles, emphasis, or placeholder variables for which you supply particular values.
monospace	Monospace type indicates commands within a paragraph, URLs, code in examples, text that appears on the screen, or text that you enter.

Changes in This Release for Oracle Database Advanced Queuing User's Guide

This preface contains:

- [Changes in Oracle Database Advanced Queuing 12c Release 2 \(12.2\)](#)
- [Changes in Oracle Database Advanced Queuing 12c Release 1 \(12.1.0.2\)](#)
- [Changes in Oracle Database Advanced Queuing 12c Release 1 \(12.1\)](#)

Changes in Oracle Database Advanced Queuing 12c Release 2 (12.2.)

The following are changes in *Oracle Database Advanced Queuing User's Guide* for Oracle Database 12c Release 2 (12.2).

New Features

The following features are new in this release:

- PL/SQL enqueue and dequeue support for JMS and non-JMS (ADT or RAW) payload in Sharded Queues

Oracle Database 12c Release 2 (12.2) extends and supports PL/SQL APIs to perform enqueue and dequeue operations for JMS, ADT, and RAW payload in sharded queues. The PL/SQL Array APIs also support sharded queues. Many existing non-JMS applications can now use sharded queues with little or no change.

Starting from Oracle Database 12c Release 2 (12.2), JMS customers using sharded queues can make use of PL/SQL notification to register a PL/SQL procedure that gets automatically invoked by AQ Server on successful enqueue. PL/SQL notification can eliminate the need for clients to poll the queue for messages because messages can be automatically dequeued and processed at the server.

See [Managing Sharded Queues](#) for more information.

- Sharded Queue Diagnosability and Manageability

Starting from 12c Release 2 (12.2), AQ sharded queues provides an advisor, views, and automated management for its message cache to optimize `STREAMS_POOL` memory allocation and throughput.

See [Sharded Queues Tuning](#) for more information.

- Longer Identifiers for Oracle Database Advanced Queuing

Starting from 12c Release 2 (12.2), the maximum length of AQ queue names has been increased to 122 bytes. The maximum length of subscriber and recipient names is increased to 128 characters. For the AQ Rules Engine, the maximum length of rule names and rule set names is now 128 bytes.

Changes in Oracle Database Advanced Queuing 12c Release 1 (12.1.0.2)

The following are changes in *Oracle Database Advanced Queuing User's Guide* for Oracle Database 12c Release 1 (12.1.0.2).

New Features

The following feature is new in this release:

- JMS Streaming

In Oracle Database 12c Release 1 (12.1.0.2), Advanced Queuing introduces JMS Streaming with enqueue and dequeue for sharded queues through `AQjmsBytesMessage` and `AQjmsStreamMessage`, for the applications interested in sending and receiving large message data or payload.

See "[JMS Streaming](#)" for more information.

Changes in Oracle Database Advanced Queuing 12c Release 1 (12.1)

The following are changes in *Oracle Database Advanced Queuing User's Guide* for Oracle Database 12c Release 1 (12.1).

New Features

The following features are new in this release:

- JMS Sharded Queues

In Oracle Database 12c Release 1 (12.1), Advanced Queuing introduces high performing and scalable sharded JMS Queues. A sharded queue is a single logical queue that is divided into multiple, independent, physical queues through system-maintained partitioning. A [sharded queue](#) increases enqueue-dequeue throughput, especially across Oracle RAC instances, because ordering between two messages on different queue shards is best effort. Each shard is ordered based on enqueue time within a session. Sharded queues automatically manage table partitions so that enqueueers and dequeuers do not contend among themselves. In addition, sharded queues use an in-memory message cache to optimize performance and reduce the disk and CPU overhead of AQ-JMS enqueues and dequeues. Sharded queues are the preferred JMS queues for queues used across Oracle RAC instances, for queues with high enqueue or dequeue rates, or for queues with many subscribers.

In 12.2, Sharded Queues have been enhanced to support more than JMS. See [Sharded Queues](#) for more information.

- Result Cache Enhancement

In Oracle Database 12c Release 1 (12.1), the Rules Engine introduces a [result cache](#) to improve the performance of many commonly used rules. The result cache will bypass the evaluation phase if an expression with the same attributes has already been evaluated earlier. Not all rule results are cached, such as when rule results are potentially non-deterministic or when not all rules are evaluated or when attributes include non-scalar data types. For Advanced Queues, the cache is most useful when subscriptions and their dequeue sessions are long-lived.

- **LONG VARCHAR Support**

The `LONG VARCHAR` data type is supported by Oracle Database Advanced Queuing in Oracle Database 12c Release 1 (12.1).

- **3-Tier Background Architecture**

Oracle Database 12c Release 1 (12.1) introduces the AQ background process architecture with a new a 3-tier design.

See "[AQ Background Architecture](#)" for more information.

- **Support for Data Guard Database Rolling Upgrade**

Databases that use Oracle Database Advanced Queuing can now be upgraded to new Oracle database releases and patch sets in rolling fashion using Data Guard database rolling upgrades (transient logical standby database only). Rolling upgrades are supported beginning in Oracle Database 12c Release 1 (12.1).

Data Guard database rolling upgrades reduce planned downtime by enabling the upgrade to new database releases or patch sets in rolling fashion. Total database downtime for such an upgrade is limited to the small amount of time required to execute a Data Guard switchover.

The following packages will have support for rolling upgrade using logical standby:

- DBMS_AQ
- DBMS_AQJMS
- DBMS_AQADM, except for the following procedures:
 - * SCHEDULE_PROPAGATION
 - * UNSCHEDULE_PROPAGATION
 - * ALTER_PROPAGATION_SCHEDULE
 - * ENABLE_PROPAGATION_SCHEDULE
 - * DISABLE_PROPAGATION_SCHEDULE

 **See Also:**

- *Oracle Database High Availability Overview* for more information on Data Guard transient logical rolling upgrades
- *Oracle Database PL/SQL Packages and Types Reference* for more information on the Oracle Database AQ packages

1

Introduction to Oracle Database Advanced Queuing

Advanced Queuing (AQ) is a robust and feature-rich message queuing system integrated with Oracle Database. These topics discuss Oracle Database Advanced Queuing (AQ) and the requirements for complex information handling in an integrated environment.

- [What Is Queuing?](#)
- [Oracle Database Advanced Queuing Leverages Oracle Database](#)
- [Oracle Database Advanced Queuing in Integrated Application Environments](#)
- [Buffered Messaging](#)
- [Asynchronous Notifications](#)
- [Enqueue Features](#)
- [Dequeue Features](#)
- [Propagation Features](#)
- [Message Format Transformation](#)
- [Other Oracle Database Advanced Queuing Features](#)
- [Interfaces to Oracle Database Advanced Queuing](#)

1.1 What Is Queuing?

Advanced Queuing stores user messages in abstract storage units called queues. When Web-based business applications communicate with each other, producer applications enqueue messages and consumer applications dequeue messages.

At the most basic level of queuing, one producer enqueues one or more messages into one queue. Each [message](#) is dequeued and processed once by one of the consumers. A message stays in the [queue](#) until a consumer dequeues it or the message expires. A [producer](#) can stipulate a delay before the message is available to be consumed, and a time after which the message expires. Likewise, a [consumer](#) can wait when trying to [dequeue](#) a message if no message were available. An agent program or application could act as both a producer and a consumer.

Producers can [enqueue](#) messages in any sequence. Messages are not necessarily dequeued in the order in which they are enqueued. Messages can be enqueued without being dequeued.

At a slightly higher level of complexity, many producers enqueue messages into a queue, all of which are processed by one consumer. Or many producers enqueue messages, each message being processed by a different consumer depending on type and correlation identifier.

Enqueued messages are said to be propagated when they are reproduced on another queue, which can be in the same database or in a remote database.

Applications often use data in different formats. A [transformation](#) defines a mapping from one data type to another. The transformation is represented by a SQL function that takes the source data type as input and returns an object of the target data type. You can arrange transformations to occur when a message is enqueued, when it is dequeued, or when it is propagated to a remote [subscriber](#).

1.2 Oracle Database Advanced Queuing Leverages Oracle Database

Oracle Database Advanced Queuing provides database-integrated message queuing functionality. This functionality is built on top of Oracle Streams and leverages the functions of Oracle Database so that messages can be stored persistently, propagated between queues on different computers and databases, and transmitted using Oracle Net Services and HTTP(S).

Because Oracle Database Advanced Queuing is implemented in database tables, all operational benefits of high availability, scalability, and reliability are also applicable to queue data. Standard database features such as recovery, restart, and security are supported by Oracle Database Advanced Queuing. You can use database development and management tools such as Oracle Enterprise Manager to monitor queues. Like other database tables, queue tables can be imported and exported. Similarly, advanced queues are supported by Oracle Data Guard for high availability, which can be critical to preserve your messages when using a stateless middle tier. By being in the database, enqueues and dequeues can be incorporated in database transactions without requiring distributed transactions. For example, Oracle XA.

Messages can be queried using standard SQL. This means that you can use SQL to access the message properties, the message history, and the payload. With SQL access you can also audit and track messages. All available SQL technology, such as indexes, can be used to optimize access to messages.

Note:

Oracle Database Advanced Queuing does not support [data manipulation language](#) (DML) operations on a queue table, or associated [index-organized table](#) (IOT), or associated system-partitioned tables used by sharded queues, if any. The only supported means of modifying queue tables is through the supplied APIs. Queue tables and IOTs can become inconsistent and therefore effectively ruined, if DML operations are performed on them.

System-Level Access Control

Oracle Database Advanced Queuing supports system-level access control for all queuing operations, allowing an application developer or DBA to designate users as queue administrators. A queue administrator can invoke Oracle Database Advanced Queuing administrative and operational interfaces on any queue in the database. This simplifies administrative work because all administrative scripts for the queues in a database can be managed under one schema.

Queue-Level Access Control

Oracle Database Advanced Queuing supports queue-level access control for enqueue and dequeue operations. This feature allows the application developer to protect queues created in one schema from applications running in other schemas. The application developer can grant only minimal access privileges to applications that run outside the queue schema.

Performance

Requests for service must be separated from the supply of services to increase efficiency and enable complex scheduling. Oracle Database Advanced Queuing exhibits high performance as measured by:

- Number of messages enqueued and dequeued each second
- Time to evaluate a complex query on a message warehouse
- Time to recover and restart the messaging process after a failure

Scalability

Queuing systems must be scalable. Oracle Database Advanced Queuing exhibits high performance when the number of programs using the application increases, when the number of messages increases, and when the size of the message warehouse increases.

Persistence for Security

Messages that constitute requests for service must be stored persistently and processed exactly once for deferred execution to work correctly in the presence of network, computer, and application failures. Oracle Database Advanced Queuing can meet requirements in the following situations:

- Applications do not have the resources to handle multiple unprocessed messages arriving simultaneously from external clients or from programs internal to the application.
- Communication links between databases are not available all the time or are reserved for other purposes. If the system falls short in its capacity to deal with these messages immediately, then the application must be able to store the messages until they can be processed.
- External clients or internal programs are not ready to receive messages that have been processed.

Persistence for Scheduling

Queuing systems must deal with priorities, and those priorities can change:

- Messages arriving later can be of higher priority than messages arriving earlier.
- Messages may wait for later messages before actions are taken.
- The same message may be accessed by different processes.
- Messages in a specific queue can become more important, and so must be processed with less delay or interference from messages in other queues.
- Messages sent to some destinations can have a higher priority than others.

Persistence for Accessing and Analyzing Metadata

Queuing systems must preserve message metadata, which can be as important as the payload data. For example, the time that a message is received or dispatched can be crucial for business and legal reasons. With the persistence features of Oracle Database Advanced Queuing, you can analyze periods of greatest demand or evaluate the lag between receiving and completing an order.

Object Type Support

Oracle Database Advanced Queuing supports enqueue, dequeue, and propagation operations where the queue type is an abstract datatype, [ADT](#). It also supports enqueue and dequeue operations if the types are inherited types of a base ADT. Propagation between two queues where the types are inherited from a base ADT is not supported.

Oracle Database Advanced Queuing also supports `ANYDATA` queues, which enable applications to enqueue different message types in a single queue. Oracle Database Advanced Queuing supports the `LONG VARCHAR` data type from 12c Release 1 (12.1) onwards.

If you plan to enqueue, propagate, or dequeue user-defined type messages, then each type used in these messages must exist at every database where the message can be enqueued in a queue. Some environments use directed networks to route messages through intermediate databases before they reach their destination. In such environments, the type must exist at each intermediate database, even if the messages of this type are never enqueued or dequeued at a particular intermediate database.

In addition, the following requirements must be met for such types:

- Type name must be the same at each database.
- Type must be in the same schema at each database.
- Shape of the type must match exactly at each database.
- Type cannot use inheritance or type evolution at any database.
- Type cannot contain varrays, nested tables, LOBs, rowids, or urowids.

The object identifier need not match at each database.

Structured and XMLType Payloads

You can use object types to structure and manage message payloads. Relational database systems in general have a richer typing system than messaging systems. Because Oracle Database is an object-relational database system, it supports traditional relational and user-defined types. Many powerful features are enabled because of having strongly typed content, such as content whose format is defined by an external type system. These include:

- Content-based routing
Oracle Database Advanced Queuing can examine the content and automatically route the message to another queue based on the content.
- Content-based subscription

A publish and subscribe system is built on top of a messaging system so that you can create subscriptions based on content.

- Querying
The ability to run queries on the content of the message enables message warehousing.

You can create queues that use the new opaque type, `XMLType`. These queues can be used to transmit and store messages that are XML documents. Using `XMLType`, you can do the following:

- Store any type of message in a queue
- Store more than one type of payload in a queue
- Query `XMLType` columns using the operator `ExistsNode()`
- Specify the operators in subscriber rules or dequeue conditions

Integration with Oracle Internet Directory

You can register system events, user events, and notifications on queues with Oracle Internet Directory. System events are database startup, database shutdown, and system error events. User events include user log on and user log off, DDL statements (create, drop, alter), and DML statement triggers. Notifications on queues include OCI notifications, PL/SQL notifications, and e-mail notifications.

You can also create aliases for Oracle Database Advanced Queuing agents in Oracle Internet Directory. These aliases can be specified while performing Oracle Database Advanced Queuing enqueue, dequeue, and notification operations. This is useful when you do not want to expose an internal agent name.

 **Note:**

Sharded Queues does not support OCI and thick drivers in 12c Release 2 (12.2.0.1).

Support for Oracle Real Application Clusters(Oracle RAC)

Oracle Real Application Clusters can be used to improve Oracle Database Advanced Queuing performance by allowing different queues to be managed by different instances. You do this by specifying different instance affinities (preferences) for the queue tables that store the queues. This allows queue operations (enqueue and dequeue) on different queues to occur in parallel. Sharded queues are recommended for applications with enqueueers or dequeueers on multiple Oracle RAC instances. Refer to [Sharded Queues and Oracle Real Application Clusters \(Oracle RAC\)](#) for more information.

If compatibility is set to Oracle8i release 8.1.5 or higher, then an application can specify the instance affinity for a queue table. When Oracle Database Advanced Queuing is used with Oracle RAC and multiple instances, this information is used to partition the queue tables between instances for queue-monitor scheduling and, also for propagation. The queue table is monitored by the queue monitors of the instance specified by the user. If the owner of the queue table is terminated, then the secondary instance or some available instance takes over the ownership for the queue table.

If an instance affinity is not specified, then the queue tables are arbitrarily partitioned among the available instances. This can result in pinging between the application accessing the queue table and the queue monitor monitoring it. Specifying the

instance affinity prevents this, but does not prevent the application from accessing the queue table and its queues from other instances.

1.3 Oracle Database Advanced Queuing in Integrated Application Environments

Oracle Database Advanced Queuing provides the message management and communication needed for application integration. In an integrated environment, messages travel between the Oracle Database server, applications, and users. This is shown in [Figure 1-1](#).

Figure 1-1 Integrated Application Environment Using Oracle Database Advanced Queuing

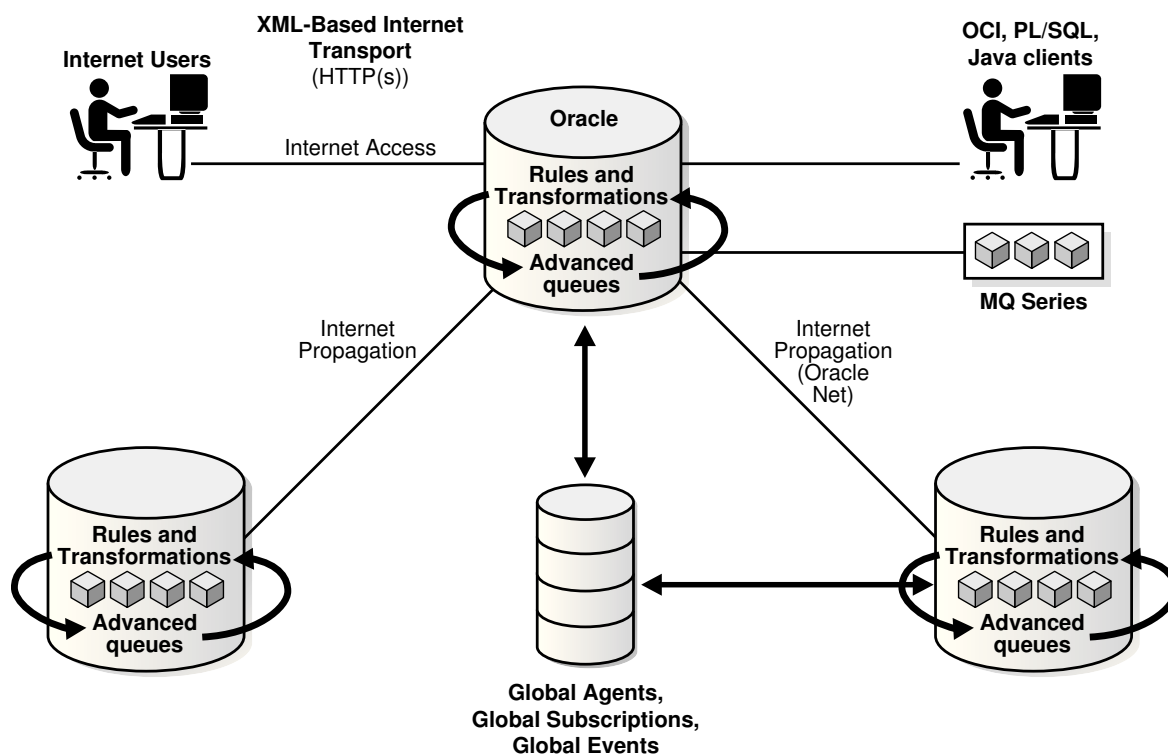

Messages are exchanged between a client and the Oracle Database server or between two Oracle Database servers using Oracle Net Services. Oracle Net Services also propagates messages from one Oracle Database queue to another. Or, as shown in [Figure 1-1](#), you can perform Oracle Database Advanced Queuing operations over the Internet using HTTP(S). In this case, the client, a user or Internet application, produces structured XML messages. During [propagation](#) over the Internet, Oracle Database servers communicate using structured XML also.

Application integration also involves the integration of heterogeneous messaging systems. Oracle Database Advanced Queuing seamlessly integrates with existing non-Oracle Database messaging systems like IBM WebSphere MQ through Messaging Gateway, thus allowing existing WebSphere MQ-based applications to be integrated into an Oracle Database Advanced Queuing environment.

Topics:

- [Oracle Database Advanced Queuing Client/Server Communication](#)
- [Multiconsumer Dequeuing of the Same Message](#)
- [Oracle Database Advanced Queuing Implementation of Workflows](#)
- [Oracle Database Advanced Queuing Implementation of Publish/Subscribe](#)

1.3.1 Oracle Database Advanced Queuing Client/Server Communication

Oracle Database Advanced Queuing provides an asynchronous alternative to the synchronous manner in which Client/Server applications usually run. This figure exemplifies Client/Server Communication Using Oracle Database Advanced Queuing. In this example Application B (a server) provides service to Application A (a client) using a request/response queue.

Figure 1-2 Client/Server Communication Using Oracle Database Advanced Queuing

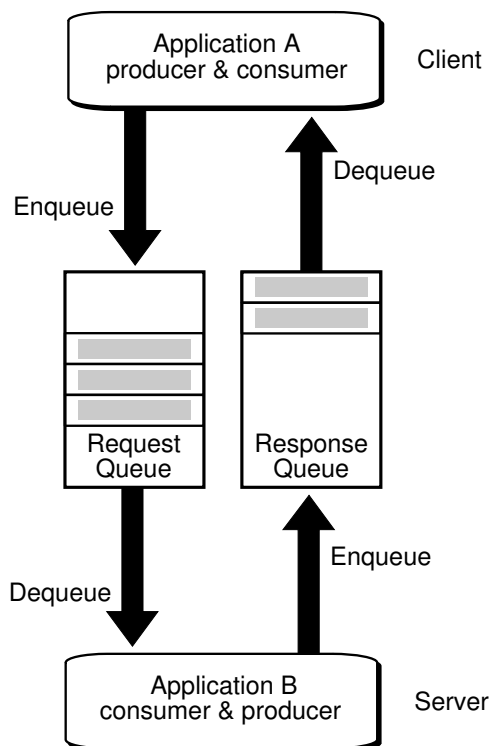

Application A enqueues a request into the request queue. In a different transaction, Application B dequeues and processes the request. Application B enqueues the result in the response queue, and in yet another transaction, Application A dequeues it.

The client need not wait to establish a connection with the server, and the server dequeues the message at its own pace. When the server is finished processing the message, there is no need for the client to be waiting to receive the result. A process of double-deferral frees both client and server.

1.3.2 Multiconsumer Dequeuing of the Same Message

A message can only be enqueued into one queue at a time. If a producer had to insert the same message into several queues in order to reach different consumers, then this would require management of a very large number of queues. Oracle Database Advanced Queuing provides for queue subscribers and message recipients to allow multiple consumers to dequeue the same message.

To allow for [subscriber](#) and [recipient](#) lists, the queue must reside in a [queue table](#) that is created with the multiple consumer option. Each message remains in the queue until it is consumed by all its intended consumers.

Queue Subscribers

Multiple consumers, which can be either applications or other queues, can be associated with a queue as subscribers. This causes all messages enqueued in the queue to be made available to be consumed by each of the queue subscribers. The subscribers to the queue can be changed dynamically without any change to the messages or message producers.

You cannot add subscriptions to single-consumer queues or exception queues. A consumer that is added as a subscriber to a queue is only able to dequeue messages that are enqueued after the subscriber is added. No two subscribers can have the same values for name, address, and protocol. At least one of these attributes must be different for two subscribers.

It cannot be known which subscriber will dequeue which message first, second, and so on, because there is no priority among subscribers. More formally, the order of dequeuing by subscribers is indeterminate.

Subscribers can also be rule-based. Similar in syntax to the `WHERE` clause of a SQL query, rules are expressed in terms of attributes that represent message properties or message content. These subscriber rules are evaluated against incoming messages, and those rules that match are used to determine message recipients.

In [Figure 1-3](#), Application B and Application C each need messages produced by Application A, so a multiconsumer queue is specially configured with Application B and Application C as queue subscribers. Each receives every message placed in the queue.

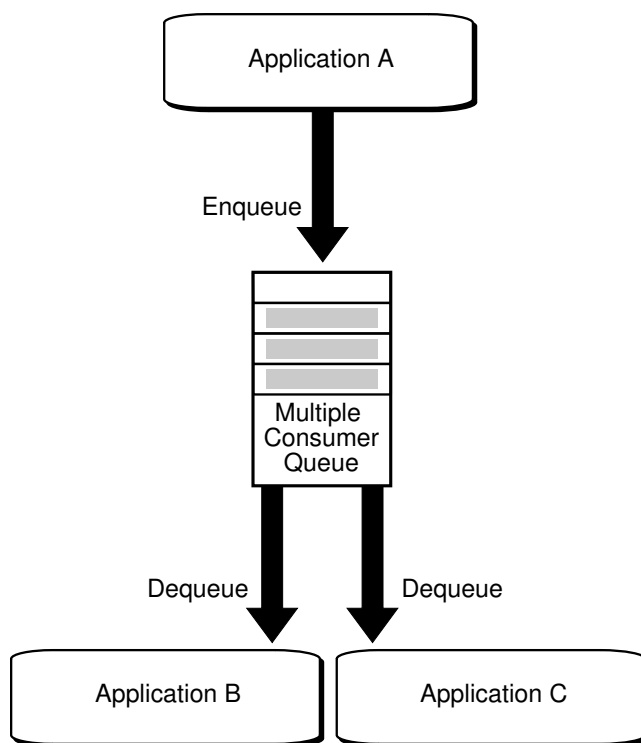
Figure 1-3 Communication Using a Multiconsumer Queue**Message Recipients**

A message producer can submit a list of recipients at the time a message is enqueued into a non-sharded queue. This allows for a unique set of recipients for each message in the queue. The recipient list associated with the message overrides the subscriber list associated with the queue, if there is one. The recipients need not be in the subscriber list. However, recipients can be selected from among the subscribers.

A recipient can be specified only by its name, in which case the recipient must dequeue the message from the queue in which the message was enqueued. It can be specified by its name and an address with a protocol value of 0. The address should be the name of another queue in the same database or another installation of Oracle Database (identified by the database link), in which case the message is propagated to the specified queue and can be dequeued by a consumer with the specified name. If the recipient's name is NULL, then the message is propagated to the specified queue in the address and can be dequeued by the subscribers of the queue specified in the address. If the protocol field is nonzero, then the name and address are not interpreted by the system and the message can be dequeued by a special consumer.

Subscribing to a queue is like subscribing to a magazine: each subscriber can dequeue all the messages placed into a specific queue, just as each magazine subscriber has access to all its articles. Being a recipient, however, is like getting a letter: each recipient is a designated target of a particular message.

Figure 1-4 shows how Oracle Database Advanced Queuing can accommodate both kinds of consumers. Application A enqueues messages. Application B and Application C are subscribers. But messages can also be explicitly directed toward recipients like Application D, which may or may not be subscribers to the queue. The list of such

recipients for a given message is specified in the enqueue call for that message. It overrides the list of subscribers for that queue.

Figure 1-4 Explicit and Implicit Recipients of Messages

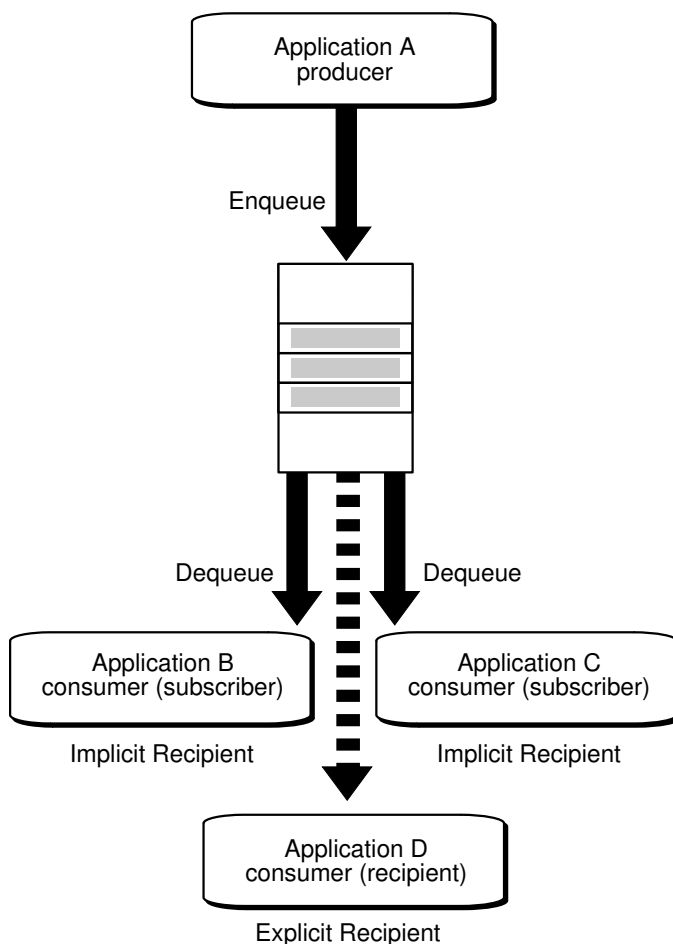

 **Note:**

Multiple producers can simultaneously enqueue messages aimed at different targeted recipients.

1.3.3 Oracle Database Advanced Queuing Implementation of Workflows

Oracle Database Advanced Queuing allows us to implement a workflow, also known as a chained application transaction. The figure exemplifies how a workflow is implemented using Oracle Database Advanced Queuing.

1. Application A begins a [workflow](#) by enqueueing Message 1.
2. Application B dequeues it, performs whatever activity is required, and enqueues Message 2.

3. Application C dequeues Message 2 and generates Message 3.
4. Application D, the final step in the workflow, dequeues it.

Figure 1-5 Implementing a Workflow using Oracle Database Advanced Queuing

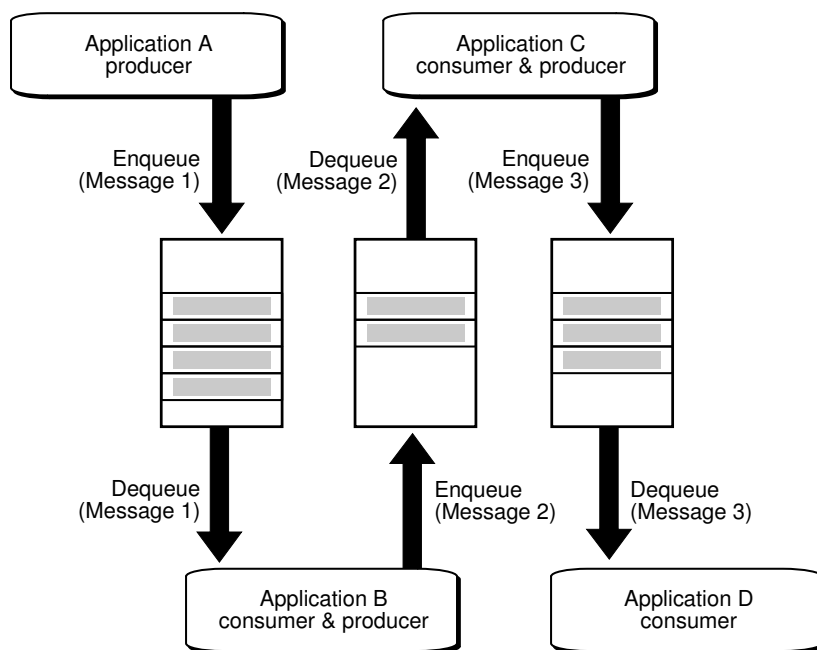

Note:

The contents of the messages 1, 2 and 3 can be the same or different. Even when they are different, messages can contain parts of the contents of previous messages.

The queues are used to buffer the flow of information between different processing stages of the business process. By specifying delay interval and expiration time for a message, a window of execution can be provided for each of the applications.

From a workflow perspective, knowledge of the volume and timing of message flows is a business asset quite apart from the value of the payload data. Oracle Database Advanced Queuing helps you gain this knowledge by supporting the optional retention of messages for analysis of historical patterns and prediction of future trends.

1.3.4 Oracle Database Advanced Queuing Implementation of Publish/Subscribe

A point-to-point message is aimed at a specific target. Senders and receivers decide on a common queue in which to exchange messages. Each message is consumed by only one receiver.

Figure 1-6 shows that each application has its own message queue, known as a single-consumer queue.

Figure 1-6 Point-to-Point Messaging

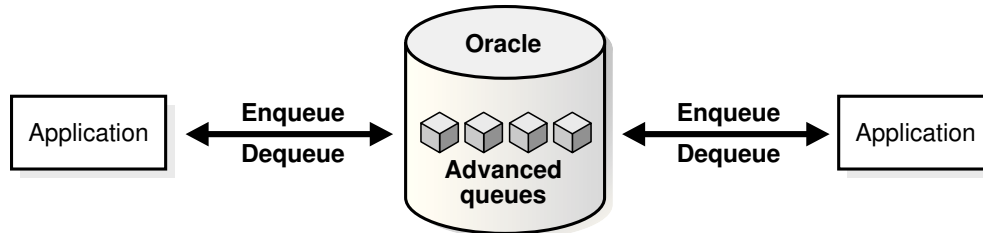

A [publish/subscribe](#) message can be consumed by multiple receivers, as shown in [Figure 1-7](#). Publish/subscribe messaging has a wide dissemination mode called [broadcast](#) and a more narrowly aimed mode called [multicast](#).

Broadcasting is like a radio station not knowing exactly who the audience is for a given program. The dequeuers are subscribers to multiconsumer queues. In contrast, multicast is like a magazine publisher who knows who the subscribers are. Multicast is also referred to as point-to-multipoint, because a single publisher sends messages to multiple receivers, called recipients, who may or may not be subscribers to the queues that serve as exchange mechanisms.

Figure 1-7 Publish/Subscribe Mode

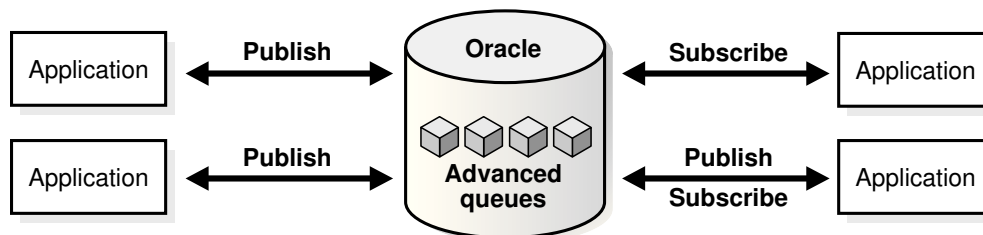

Publish/subscribe describes a situation in which a publisher application enqueues messages to a queue anonymously (no recipients specified). The messages are then delivered to subscriber applications based on [rules](#) specified by each application. The rules can be defined on message properties, message data content, or both.

You can implement a publish/subscribe model of communication using Oracle Database Advanced Queuing as follows:

1. Set up one or more queues to hold messages. These queues should represent an area or subject of interest. For example, a queue can be used to represent billed orders.
2. Set up a set of rule-based subscribers. Each subscriber can specify a rule which represents a specification for the messages that the subscriber wishes to receive. A null rule indicates that the subscriber wishes to receive all messages.
3. Publisher applications publish messages to the queue by invoking an enqueue call.

4. Subscriber applications can receive messages with a dequeue call. This retrieves messages that match the subscription criteria.
5. Subscriber applications can also use a listen call to monitor multiple queues for subscriptions on different queues. This is a more scalable solution in cases where a subscriber application has subscribed to many queues and wishes to receive messages that arrive in any of the queues.
6. Subscriber applications can also use the Oracle Call Interface (OCI) notification mechanism. This allows a push mode of message delivery. The subscriber application registers the queues (and subscriptions specified as subscribing agent) from which to receive messages. This registers a callback to be invoked when messages matching the subscriptions arrive.

Figure 1-8 illustrates the use of Oracle Database Advanced Queuing for implementing a publish/subscribe relationship between publisher Application A and subscriber Applications B, C, and D:

- Application B subscribes with rule "priority = 1".
- Application C subscribes with rule "priority > 1".
- Application D subscribes with rule "priority = 3".

Figure 1-8 Implementing Publish/Subscribe using Oracle Database Advanced Queuing

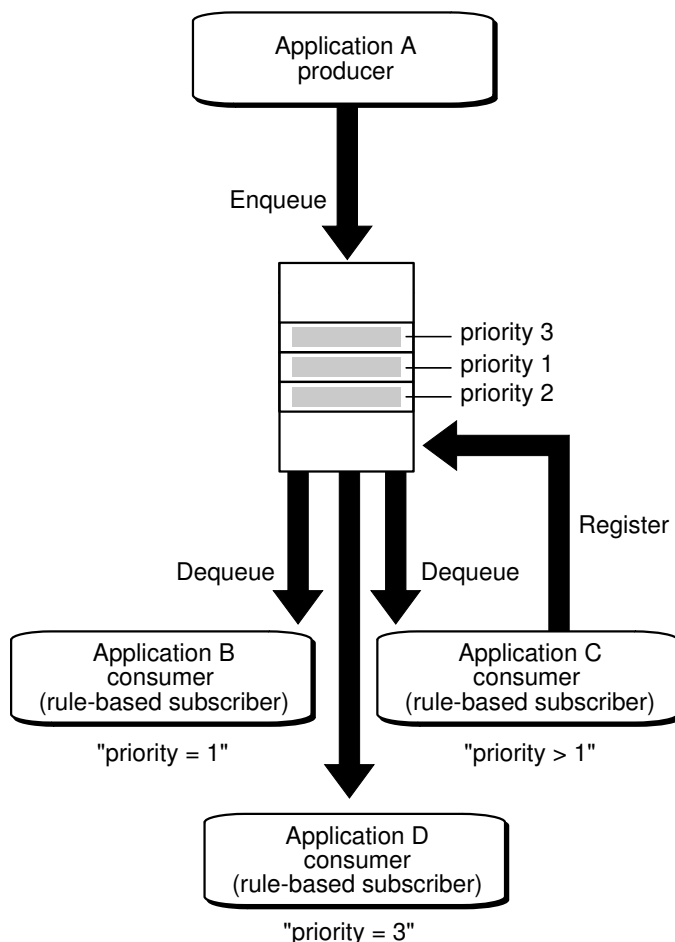

If Application A enqueues three messages with priorities 1, 2, and 3 respectively, then the messages will be delivered as follows:

- Application B receives a single message (priority 1).
- Application C receives two messages (priority 2, 3).
- Application D receives a single message (priority 3).

1.4 Buffered Messaging

Buffered messaging combines the rich functionality that this product has always offered with a much faster queuing implementation. Buffered messaging is ideal for applications that do not require the reliability and transaction support of Oracle Database Advanced Queuing persistent messaging.

Buffered messaging is faster than persistent messaging, because its messages reside in shared memory. They are usually written to disk only when the total memory consumption of buffered messages approaches the available shared memory limit.

Note:

The portion of a queue that stores buffered messages in memory is sometimes referred to as a buffered queue.

Message retention is not supported for buffered messaging.

When using buffered messaging, Oracle recommends that you do one of the following:

- Set parameter `streams_pool_size`

This parameter controls the size of shared memory available to Oracle Database Advanced Queuing. If unspecified, up to 10% of the shared pool size may be allocated for the Oracle Database Advanced Queuing pool from the database cache.

Refer to [manually tuning sharded queues](#) for more information about setting the message cache for buffered messaging with sharded queues.
- Turn on SGA autotuning

Oracle will automatically allocate the appropriate amount of memory from the SGA for Oracle Database Advanced Queuing, based on Oracle Database Advanced Queuing usage and, also usage of other components that use the SGA. Examples of such other components are buffer cache and library cache. If `streams_pool_size` is specified, it is used as the lower bound.

See Also:

"Setting Initialization Parameters Relevant to Streams" in *Oracle Streams Concepts and Administration*

Topics:

- [Enqueuing Buffered Messages](#)
- [Dequeuing Buffered Messages](#)
- [Propagating Buffered Messages](#)
- [Flow Control](#)
- [Buffered Messaging with Oracle Real Application Clusters \(Oracle RAC\)](#)
- [Buffered Messaging Restrictions](#)
- [Error Handling](#)

Enqueuing Buffered Messages

Buffered and persistent messages use the same single-consumer or multiconsumer queues and the same administrative and operational interfaces. They are distinguished from each other by a delivery mode parameter, set by the application when enqueueing the message to an Oracle Database Advanced Queuing queue.

Recipient lists are supported for buffered messaging enqueue.

Buffered messaging is supported in all queue tables created with compatibility 8.1 or higher. Transaction grouping queues and array enqueuees are not supported for buffered messages in this release. You can still use the array enqueue procedure to enqueue buffered messages, but the array size must be set to one.

Buffered messages can be queried using the `AQ$Queue_Table_Name` view. They appear with states `IN-MEMORY` or `SPILLED`.

The queue type for buffered messaging can be `ADT`, `XML`, `ANYDATA`, or `RAW`. For `ADT` types with `LOB` attributes, only buffered messages with null `LOB` attributes can be enqueued.

All ordering schemes available for persistent messages are also available for buffered messages, but only within each message class. Ordering among persistent and buffered messages enqueued in the same session is not currently supported.

Both enqueue and dequeue buffered messaging operations must be with `IMMEDIATE` visibility mode. Thus they cannot be part of another transaction. You cannot specify delay when enqueueing buffered messages.

See Also:

- ["Enqueuing Messages"](#)
- ["AQ\\$<Queue_Table_Name>: Messages in Queue Table"](#)
- ["Priority and Ordering of Messages in Enqueuing"](#)

Dequeuing Buffered Messages

Rule-based subscriptions are supported with buffered messaging. The procedure for adding subscribers is enhanced to allow an application to express interest in persistent messages only, buffered messages only, or both.

For non-sharded queues, array dequeue is not supported for buffered messaging, but you can still use the array dequeue procedure by setting array size to one message.

Dequeuing applications can choose to dequeue persistent messages only, buffered messages only, or both types. Visibility must be set to `IMMEDIATE` for dequeuing buffered messages. All of the following dequeue options are supported:

- Dequeue modes `BROWSE`, `LOCK`, `REMOVE`, and `REMOVE_NO_DATA`
- Navigation modes `FIRST_MESSAGE` and `NEXT_MESSAGE`
- Correlation identifier
- Dequeue condition
- Message identifier

 **See Also:**

- ["Adding a Subscriber"](#)
- ["Dequeue Options"](#)

Propagating Buffered Messages

Propagation of buffered messages is supported. A single propagation schedule serves both persistent and buffered messages. The `DBA_QUEUE_SCHEDULES` view displays statistics and error information.

Oracle Database AQ deletes buffered messages once they are propagated to the remote sites. If the receiving site fails before these messages are consumed, then these messages will be lost. The source site will not be able to re-send them. Duplicate delivery of messages is also possible.

 **See Also:**

- ["DBA_QUEUE_SCHEDULES: All Propagation Schedules"](#)
- ["Buffered Messaging with Oracle Real Application Clusters \(Oracle RAC\)"](#)

Flow Control

Oracle Database Advanced Queuing implements a flow control system that prevents applications from flooding the shared memory with messages. If the number of outstanding messages per sender exceeds a system-defined threshold, the enqueue call will block and timeout with an error message. A message sender is identified by `sender_id.name` in the enqueue options. A sender blocked due to flow control on a queue does not affect other message senders. The resolution is to dequeue messages, thereby resolving flow control, after which new messages can be enqueued.

Flow control threshold varies with memory pressure and could come down to the system-defined limit if streams pool usage becomes significant. Message senders will block on event `Streams AQ: enqueue blocked due to flow control` and time out with error `ORA-25307` if flow control is not resolved. Applications are expected to handle this error, and re-enqueue the failed message.

Even with flow control, slow consumers of a multiconsumer queue can cause the number of messages stored in memory to grow without limit. Provided there is at least one subscriber who is keeping pace, older messages are spilled to disk and removed from the pool to free up memory. This ensures that the cost of disk access is paid by the slower consumers, and faster subscribers can proceed unhindered.

Buffered Messaging with Oracle Real Application Clusters (Oracle RAC)

Sharded and non-sharded queues handle buffered messaging with Oracle RAC differently.

Sharded queues perform cross-instance communication but avoid simultaneous writes to the same block across Oracle RAC instances. Typically, dequeues occur on a shard that is local to a message's enqueueing instance, but in certain situations, Oracle will efficiently forward messages across instances for dequeuing on another instance. For example, if a sharded queue has a single enqueueing session on one Oracle RAC instance and a single dequeuing session on another instance, then sharded queues will forward messages between the Oracle RAC instances. The forwarding of messages is done asynchronously to the enqueueing transaction to improve performance. Dequeuers may get an ORA-25228 if they are connected to an instance whose shards have no messages.

For non-sharded queues, an application can enqueue and dequeue buffered messages from any Oracle RAC instance as long as it uses password-based authentication to connect to the database. The structures required for buffered messaging are implemented on one Oracle RAC instance. The instance where the buffered messaging structures are implemented is the `OWNER_INSTANCE` of the queue table containing the queue. Enqueue and dequeue requests received at other instances are forwarded to the `OWNER_INSTANCE` over the interconnect. The `REMOTE_LISTENER` parameter in `listener.ora` must also be set to enable forwarding of buffered messaging requests to correct instance. Internally, buffered queues on Oracle RAC may use `dblinks` between instances. Definer's rights packages that enqueue or dequeue into buffered queues on Oracle RAC must grant `INHERIT REMOTE PRIVILEGES` to users of the package.

A service name is associated with each queue in Oracle RAC and displayed in the `DBA_QUEUES` and `USER_QUEUES` views. This service name always points to the instance with the most efficient access for buffered messaging, minimizing pinging between instances. OCI clients can use the service name for buffered messaging operations.

Oracle recommends that you specify instance affinity when using buffered messaging with queue-to-queue propagation. This results in transparent failover when propagating messages to a destination Oracle RAC system. You do not need to re-point your database links if the primary AQ Oracle RAC instance fails.

 **See Also:**

- "[ALL_QUEUE_TABLES: Queue Tables Accessible to the Current User](#)" for more information on `OWNER_INSTANCE`
- "REMOTE_LISTENER" in *Oracle Database Reference* for more information on setting the `REMOTE_LISTENER` parameter
- "[DBA_QUEUES: All Queues in Database](#)" or "[USER_QUEUES: Queues In User Schema](#)"
- "[Support for Oracle Real Application Clusters\(Oracle RAC\)](#)"

Buffered Messaging Restrictions

The following Oracle Database Advanced Queuing features are only supported for buffered messaging on sharded queues:

- Message delay
- Array enqueue
- Array dequeue
- PL/SQL Notification

The following Oracle Database Advanced Queuing features are not currently supported for buffered messaging:

- Message retention
- Transaction grouping
- Message export and import
- Messaging Gateway
- OCI notification

Error Handling

Retry count and retry delay are not supported for buffered messages. Message expiration is supported. When a buffered message has been in the queue beyond its expiration period, it is moved into the exception queue as a persistent message.

1.5 Asynchronous Notifications

Asynchronous notification allows clients to receive notifications of messages of interest.

The client can use these notifications to monitor multiple subscriptions. The client need not be connected to the database to receive notifications regarding its subscriptions. Asynchronous notification is supported for buffered messages. The delivery mode of the message is available in the message descriptor of the notification descriptor.

The client specifies a callback function which is run for each message. Asynchronous notification cannot be used to invoke an executable, but it is possible for the callback function to invoke a stored procedure.

Clients can receive notifications procedurally using PL/SQL, Java Message Service (JMS), or OCI callback functions, or clients can receive notifications through e-mail or HTTP post. Clients can also specify the presentation for notifications as either `RAW` or `XML`.

 **Note:**

Sharded queues only support PL/SQL notification.

For JMS queues, the dequeue is accomplished as part of the notification; explicit dequeue is not required. For RAW queues, clients can specify payload delivery; but they still must dequeue the message in `REMOVE_NO_DATA` mode. For all other persistent queues, the notification contains only the message properties; clients explicitly dequeue to receive the message.

Payload Delivery for RAW Queues

For RAW queues, Oracle Database Advanced Queuing clients can now specify that the message payload be delivered along with its notification.

 **See Also:**

["AQ Registration Information Type"](#)

Reliable Notification

Clients can specify persistent message notification. If an Oracle RAC instance fails, its notifications are delivered by another Oracle RAC node. If a standalone instance fails, its notifications are delivered when the instance restarts.

 **Note:**

Notification reliability refers only to server failures. If Oracle Database Advanced Queuing cannot deliver client notifications for any other reason, then the notifications are purged along with the client registration.

Designated Port Notification

For non-sharded queues, Oracle Database Advanced Queuing clients can use the OCI subscription handle attribute `OCI_ATTR_SUBSCR_PORTNO` to designate the port at which notifications are delivered. This is especially useful for clients on a computer behind a firewall. The port for the listener thread can be designated before the first registration, using an attribute in the environment handle. The thread is started the first time an `OCISubscriptionRegister` is called. If the client attempts to start another thread on a different port using a different environment handle, then Oracle Database Advanced Queuing returns an error.

 **Note:**

Designated port notification and IP address notification apply only to OCI clients.

 **See Also:**

"Publish-Subscribe Registration Functions in OCI" in *Oracle Call Interface Programmer's Guide*

IPv6 Compliance and Designated IP Support

For non-sharded queues, Oracle Database AQ supports IPv6 and Oracle Database AQ clients can use the OCI subscription handle attribute `OCI_ATTR_SUBSCR_IPADDR` to designate the IP address at which notifications are delivered. This is especially useful for clients on a computer that has multiple network interface cards or IP addresses. The IP address for the listener thread can be designated before the first registration using an attribute in the environment handle. The thread is started the first time an `OCISubscriptionRegister` is called. If the client attempts to start another thread on a different IP address using a different environment handle, Oracle Database AQ returns an error. If no IP address is specified, Oracle Database AQ will deliver notifications on all IP addresses of the computer the client is on.

Registration Timeout

In earlier releases of Oracle Database Advanced Queuing, registrations for notification persisted until explicitly removed by the client or purged in case of extended client failure. From Oracle Database Advanced Queuing 10g Release 2 (10.2) onwards, clients can register for a specified time, after which the registration is automatically purged.

When the registration is purged, Oracle Database Advanced Queuing sends a notification to the client, so the client can invoke its callback and take any necessary action.

 **See Also:**

"[AQ Registration Information Type](#)" for information on the `timeout` parameter

Purge on Notification

Clients can also register to receive only the first notification, after which the registration is automatically purged.

An example where purge on notification is useful is a client waiting for enqueues to start. In this case, only the first notification is useful; subsequent notifications provide no additional information. Previously, this client would be required to unregister once enqueueing started; now the registration can be configured to go away automatically.

Buffered Message Notification

Clients can register for notification of buffered messages. The registration requests apply to both buffered and persistent messages. The message properties delivered with the PL/SQL or OCI notification specify whether the message is buffered or persistent.

See Also:

- "[Registering for Notification](#)" for more information on PL/SQL notification
- Appendix C, "OCI Examples", which appears only in the HTML version of this guide, for an example of OCI notification

Reliable notification is not supported.

1.5.1 Views on Registration

The dictionary views `DBA_SUBSCR_REGISTRATIONS` and `USER_SUBSCR_REGISTRATIONS` display the various registrations in the system.

The diagnostic view `GV$SUBSCR_REGISTRATION_STATS` may be used to monitor notification statistics and performance.

1.5.2 Event-Based Notification

Event-based notifications are processed by a set of coordinator (EMNC) and subordinate processes.

The event notification load is distributed among these processes. These processes work on the system notifications in parallel, offering a capability to process a larger volume of notifications, a faster response time and lower shared memory use for staging notifications.

1.5.3 Notification Grouping by Time

Notification applications may register to receive a single notification for all events that occur within a specified time interval. Notification Clients may specify a start time for the notifications. Additionally, they must specify a time as the grouping class and the time interval as the grouping value.

A repeat count may be used to limit the number of notifications delivered. Clients can receive two types of grouping events, Summary or Last. A summary notification is a list of Message Identifiers of all the messages for the subscription. If last was specified as a grouping type, notification would have information about the last message in the notification interval. A count of the number of messages in the interval is also sent. The registration interfaces in PLSQL and OCI allow for specification of the `START_TIME`, `REPEAT_COUNT`, `GROUPING CLASS`, `GROUPING VALUE`, `GROUPING TYPE` in the `AQ$REGISTRATION_INFO` and the OCI subscription Handle.

The notification descriptor received by the client initiated AQ notification provides information about the group of message identifiers and the number of notifications in the group.

 **See Also:**

- *Oracle Database PL/SQL Packages and Types Reference*
- *Oracle Call Interface Programmer's Guide*

1.6 Enqueue Features

This topic describes the enqueue features Enqueuing an Array of Messages, Correlation Identifiers, Priority and Ordering of Messages in Enqueuing, Message Grouping, Sender Identification, and Time Specification and Scheduling.

The following features apply to enqueueing messages:

- [Enqueue an Array of Messages](#)
- [Correlation Identifiers](#)
- [Priority and Ordering of Messages in Enqueuing](#)
- [Message Grouping](#)
- [Sender Identification](#)
- [Time Specification and Scheduling](#)

Enqueue an Array of Messages

When enqueueing messages into a queue, you can operate on an array of messages simultaneously, instead of one message at a time. This can improve the performance of enqueue operations. When enqueueing an array of messages into a queue, each message shares the same enqueue options, but each message can have different message properties. You can perform array enqueue operations using PL/SQL or OCI.

Array enqueueing is not supported for buffered messages in this release.

Correlation Identifiers

You can assign an identifier to each message, thus providing a means to retrieve specific messages at a later time.

Priority and Ordering of Messages in Enqueuing

You can specify the priority of an enqueued message and its exact position in the queue. This means that users can specify the order in which messages are consumed in three ways:

- A priority can be assigned to each message.
- A sort order specifies which properties are used to order all messages in a queue. This is set when the queue table is created and cannot be changed. You can choose to sort messages by priority, enqueue time, or commit time.

 **See Also:**

- "Commit-Time Queues" in *Oracle Streams Concepts and Administration*
- "[Creating a Queue Table](#)" for more information on sort order

- A sequence deviation positions a message in relation to other messages.

 **Note:**

The sequence deviation feature is deprecated in 10g Release 2 (10.2).

If several consumers act on the same queue, then each consumer gets the first message that is available for immediate consumption. A message that is in the process of being consumed by another consumer is skipped.

Priority ordering of messages is achieved by specifying priority, enqueue time as the sort order. If priority ordering is chosen, then each message is assigned a priority at enqueue time by the enqueueing agent. At dequeue time, the messages are dequeued in the order of the priorities assigned. If two messages have the same priority, then the order in which they are dequeued is determined by the enqueue time. A first-in, first-out (FIFO) priority queue can also be created by specifying enqueue time, priority as the sort order of the messages.

Message Grouping

Messages belonging to one queue can be grouped to form a set that can only be consumed by one user at a time. This requires that the queue be created in a queue table that is enabled for message grouping. All messages belonging to a group must be created in the same transaction, and all messages created in one transaction belong to the same group.

This feature allows users to segment complex messages into simple messages. For example, messages directed to a queue containing invoices can be constructed as a group of messages starting with a header message, followed by messages representing details, followed by a trailer message.

Message grouping is also useful if the message payload contains complex large objects such as images and video that can be segmented into smaller objects.

Group message properties priority, delay, and expiration are determined solely by the message properties specified for the first message in a group, irrespective of which properties are specified for subsequent messages in the group.

The message grouping property is preserved across propagation. However, the destination queue where messages are propagated must also be enabled for transactional grouping. There are also some restrictions you must keep in mind if the message grouping property is to be preserved while dequeuing messages from a queue enabled for transactional grouping.

Sender Identification

Applications can mark the messages they send with a custom identification. Oracle Database Advanced Queuing also automatically identifies the queue from which a message was dequeued. This allows applications to track the pathway of a propagated message or a string message within the same database.

Time Specification and Scheduling

Messages can be enqueued with an expiration that specifies the interval of time the message is available for dequeuing. The default for expiration is never. When a message expires, it is moved to an exception queue. Expiration processing requires that the queue monitor be running.

1.7 Dequeue Features

This topic discusses the dequeue features Concurrent Dequeues, Dequeue Methods, Dequeue Modes, Dequeue an Array of Messages, Message States, Navigation of Messages in Dequeuing, Waiting for Messages, Retries with Delays, Optional Transaction Protection, and Exception Queues.

The following features apply to dequeuing messages:

- [Concurrent Dequeues](#)
- [Dequeue Methods](#)
- [Dequeue Modes](#)
- [Dequeue an Array of Messages](#)
- [Message States](#)
- [Navigation of Messages in Dequeuing](#)
- [Waiting for Messages](#)
- [Retries with Delays](#)
- [Optional Transaction Protection](#)
- [Exception Queues](#)

Concurrent Dequeues

When there are multiple processes dequeuing from a single-consumer queue or dequeuing for a single consumer on the multiconsumer queue, different processes skip the messages that are being worked on by a concurrent process. This allows multiple processes to work concurrently on different messages for the same consumer.

Dequeue Methods

A message can be dequeued using one of the following dequeue methods:

- [Specifying a correlation identifier](#)

A correlation identifier is a user-defined message property. Multiple messages with the same correlation identifier can be present in a queue, which means that the ordering (enqueue order) between messages might not be preserved on dequeue calls.

- Specifying a message identifier
A message identifier is a system-assigned value (of `RAW` datatype). Only one message with a given message identifier can be present in the queue.
- Specifying a dequeue condition
A dequeue condition is expressed in terms of message properties or message content and is similar in syntax to the `WHERE` clause of a SQL query. Messages in the queue are evaluated against the condition, and messages that satisfy the given condition are returned. When a dequeue condition is used, the order of the messages dequeued is indeterminate, and the sort order of the queue is not honored.
- Default dequeue
A default dequeue retrieves the first available message.

 **Note:**

Dequeuing with correlation identifier, message identifier, or dequeue condition does not preserve the message grouping property.

Dequeue Modes

A dequeue request can browse a message, remove it, or remove it with no data. If a message is browsed, then it remains available for further processing. If a message is removed or removed with no data, then it is no longer available for dequeue requests. Depending on the queue properties, a removed message can be retained in the queue table. A message is retained in the queue table after it has been consumed only if a retention time is specified for its queue.

The browse mode has three risks. First, there is no guarantee that the message can be dequeued again after it is browsed, because a dequeue call from a concurrent user might have removed the message. To prevent a viewed message from being dequeued by a concurrent user, you should view the message in the locked mode.

Second, your dequeue position in browse mode is automatically changed to the beginning of the queue if a nonzero wait time is specified and the navigating position reaches the end of the queue. If you repeat a dequeue call in the browse mode with the `NEXT_MESSAGE` navigation option and a nonzero wait time, then you can end up dequeuing the same message over and over again. Oracle recommends that you use a nonzero wait time for the first dequeue call on a queue in a session, and then use a zero wait time with the `NEXT_MESSAGE` navigation option for subsequent dequeue calls. If a dequeue call gets an "end of queue" error message, then the dequeue position can be explicitly set by the dequeue call to the beginning of the queue using the `FIRST_MESSAGE` navigation option, following which the messages in the queue can be browsed again.

Third, if the sort order of the queue is `ENQ_TIME`, `PRIORITY`, or a combination of these two, then results may not be repeatable from one browse to the next. If you must have consistent browse results, then you should use a [commit-time queue](#).

 **See Also:**

- "Commit-Time Queues" in *Oracle Streams Concepts and Administration*
- "Creating a Queue Table"

When a message is dequeued using `REMOVE_NODATA` mode, the payload of the message is not retrieved. This mode can be useful when the user has already examined the message payload, possibly by means of a previous `BROWSE` dequeue.

Dequeue an Array of Messages

When dequeuing messages from a queue, you can operate on an array of messages simultaneously, instead of one message at a time. This can improve the performance of dequeue operations. If you are dequeuing from a transactional queue, you can dequeue all the messages for a transaction with a single call, which makes application programming easier.

When dequeuing an array of messages from a queue, each message shares the same dequeue options, but each message can have different message properties. You can perform array enqueue and array dequeue operations using PL/SQL or OCI.

Array dequeuing is not supported for buffered messages in this release.

Message States

Multiple processes or operating system threads can use the same consumer name to dequeue concurrently from a queue. In that case Oracle Database Advanced Queuing provides the first unlocked message that is at the head of the queue and is intended for the consumer. Unless the message identifier of a specific message is specified during dequeue, consumers can dequeue messages that are in the `READY` state.

A message is considered `PROCESSED` only when all intended consumers have successfully dequeued the message. A message is considered `EXPIRED` if one or more consumers did not dequeue the message before the `EXPIRATION` time. When a message has expired, it is moved to an exception queue.

Expired messages from multiconsumer queues cannot be dequeued by the intended recipients of the message. However, they can be dequeued in the `REMOVE` mode exactly once by specifying a `NULL` consumer name in the dequeue options.

 **Note:**

If the multiconsumer exception queue was created in a queue table with the `compatible` parameter set to `8.0`, then expired messages can be dequeued only by specifying a message identifier.

Queues created in a queue table with `compatible` set to `8.0` (referred to in this guide as 8.0-style queues) are deprecated in Oracle Database Advanced Queuing 10g Release 2 (10.2). Oracle recommends that any new queues you create be 8.1-style or newer and that you migrate existing 8.0-style queues at your earliest convenience.

Beginning with Oracle Database Advanced Queuing release 8.1.6, only the queue monitor removes messages from multiconsumer queues. This allows dequeuers to complete the dequeue operation by not locking the message in the queue table. Because the queue monitor removes messages that have been processed by all consumers from multiconsumer queues approximately once every minute, users can see a delay between when the messages have been completely processed and when they are physically removed from the queue.

Navigation of Messages in Dequeuing

You have several options for selecting a message from a queue. You can select the first message with the `FIRST_MESSAGE` navigation option. Alternatively, once you have selected a message and established its position in the queue, you can then retrieve the next message with the `NEXT_MESSAGE` navigation option.

The `FIRST_MESSAGE` navigation option performs a `SELECT` on the queue. The `NEXT_MESSAGE` navigation option fetches from the results of the `SELECT` run in the `FIRST_MESSAGE` navigation. Thus performance is optimized because subsequent dequeues need not run the entire `SELECT` again.

If the queue is enabled for transactional grouping, then the navigation options work in a slightly different way. If `FIRST_MESSAGE` is requested, then the dequeue position is still reset to the beginning of the queue. But if `NEXT_MESSAGE` is requested, then the position is set to the next message in the same *transaction*. Transactional grouping also offers a `NEXT_TRANSACTION` option. It sets the dequeue position to the first message of the next transaction.

Transaction grouping has no effect if you dequeue by specifying a correlation identifier or message identifier, or if you dequeue some of the messages of a transaction and then commit.

If you reach the end of the queue while using the `NEXT_MESSAGE` or `NEXT_TRANSACTION` option, and you have specified a nonzero wait time, then the navigating position is automatically changed to the beginning of the queue. If a zero wait time is specified, then you can get an exception when the end of the queue is reached.

Waiting for Messages

Oracle Database Advanced Queuing allows applications to block on one or more queues waiting for the arrival of either a newly enqueued message or a message that becomes ready. You can use the `DEQUEUE` operation to wait for the arrival of a message in a single queue or the `LISTEN` operation to wait for the arrival of a message in more than one queue.

 **Note:**

Applications can also perform a blocking dequeue on exception queues to wait for arrival of `EXPIRED` messages.

When the blocking `DEQUEUE` call returns, it returns the message properties and the message payload. When the blocking `LISTEN` call returns, it discloses only the name of the queue where a message has arrived. A subsequent `DEQUEUE` operation is needed to dequeue the message.

When there are messages for multiple agents in the agent list, `LISTEN` returns with the first agent for whom there is a message. To prevent one agent from starving other agents for messages, the application can change the order of the agents in the agent list.

Applications can optionally specify a timeout of zero or more seconds to indicate the time that Oracle Database Advanced Queuing must wait for the arrival of a message. The default is to wait forever until a message arrives in the queue. This removes the burden of continually polling for messages from the application, and it saves CPU and network resources because the application remains blocked until a new message is enqueued or becomes `READY` after its `DELAY` time.

An application that is blocked on a dequeue is either awakened directly by the enqueuer if the new message has no `DELAY` or is awakened by the queue monitor process when the `DELAY` or `EXPIRATION` time has passed. If an application is waiting for the arrival of a message in a remote queue, then the Oracle Database Advanced Queuing propagator wakes up the blocked dequeuer after a message has been propagated.

Retries with Delays

If the transaction dequeuing a message from a queue fails, then it is regarded as an unsuccessful attempt to consume the message. Oracle Database Advanced Queuing records the number of failed attempts to consume the message in the message history. Applications can query the `RETRY_COUNT` column of the queue table view to find out the number of unsuccessful attempts on a message. In addition, Oracle Database Advanced Queuing allows the application to specify, at the queue level, the maximum number of retries for messages in the queue. The default value for maximum retries is 5. If the number of failed attempts to remove a message exceeds this number, then the message is moved to the exception queue and is no longer available to applications.

 **Note:**

If a dequeue transaction fails because the server process dies (including `ALTER SYSTEM KILL SESSION`) or `SHUTDOWN ABORT` on the instance, then `RETRY_COUNT` is not incremented.

A bad condition can cause the transaction receiving a message to end. Oracle Database Advanced Queuing allows users to hide the bad message for a specified retry delay interval, during which it is in the `WAITING` state. After the retry delay, the failed message is again available for dequeue. The Oracle Database Advanced Queuing time manager enforces the retry delay property. The default value for retry delay is 0.

If multiple sessions are dequeuing messages from a queue simultaneously, then `RETRY_COUNT` information might not always be updated correctly. If session one dequeues a message and rolls back the transaction, then Oracle Database AQ notes that the `RETRY_COUNT` information for this message must be updated. However `RETRY_COUNT` cannot be incremented until session one completes the rollback. If session two attempts to dequeue the same message after session one has completed the rollback but before it has incremented `RETRY_COUNT`, then the dequeue by session two succeeds. When session one attempts to increment `RETRY_COUNT`, it finds that the message is locked by session two and `RETRY_COUNT` is not incremented. A trace file is

then generated in the `USER_DUMP_DESTINATION` for the instance with the following message:

```
Error on rollback: ORA-25263: no message in queue schema.qname with message ID ...
```

 **Note:**

Maximum retries and retry delay are not available with 8.0-style multiconsumer queues.

Queues created in a queue table with `compatible` set to 8.0 (referred to in this guide as 8.0-style queues) are deprecated in Oracle Database Advanced Queuing 10g Release 2 (10.2). Oracle recommends that any new queues you create be 8.1-style or newer and that you migrate existing 8.0-style queues at your earliest convenience.

Optional Transaction Protection

Enqueue and dequeue requests are usually part of a transaction that contains the requests, thereby providing the wanted [transactional](#) action. You can, however, specify that a specific request is a transaction by itself, making the result of that request immediately visible to other transactions. This means that messages can be made visible to the external world when the enqueue or dequeue statement is applied or after the transaction is committed.

 **Note:**

Transaction protection is not supported for buffered messaging.

Exception Queues

An exception queue is a repository for expired or unserviceable messages. Applications cannot directly enqueue into exception queues. Also, a multiconsumer exception queue cannot have subscribers associated with it. However, an application that intends to handle these expired or unserviceable messages can dequeue them exactly once from the exception queue using remove mode. The consumer name specified while dequeuing should be null. Messages can also be dequeued from the exception queue by specifying the message identifier.

 **Note:**

Expired or unserviceable buffered messages are moved to an exception queue as persistent messages.

Messages intended for single-consumer queues, or for 8.0-style multiconsumer queues, can only be dequeued by their message identifiers once the messages have been moved to an exception queue.

Queues created in a queue table with `compatible` set to 8.0 (referred to in this guide as 8.0-style queues) are deprecated in Oracle Database Advanced Queuing 10g Release 2 (10.2). Oracle recommends that any new queues you create be 8.1-style or newer and that you migrate existing 8.0-style queues at your earliest convenience.

After a message has been moved to an exception queue, there is no way to identify which queue the message resided in before moving to the exception queue. If this information is important, then the application must save this information in the message itself.

The exception queue is a message property that can be specified during enqueue time. If an exception queue is not specified, then a default exception queue is used. The default exception queue is automatically created when the queue table is created.

A message is moved to an exception queue under the following conditions:

- It was not dequeued within the specified expiration interval.
For a message intended for multiple recipients, the message is moved to the exception queue if one or more of the intended recipients was not able to dequeue the message within the specified expiration interval. The default expiration interval is never, meaning the messages does not expire.
- The message was dequeued successfully, but the application that dequeued it rolled back the transaction because of an error that arose while processing the message. If the message has been dequeued but rolled back more than the number of times specified by the retry limit, then the message is moved to the exception queue.

For a message intended for multiple recipients, a separate retry count is kept for each recipient. The message is moved to the exception queue only when retry counts for all recipients of the message have exceeded the specified retry limit.

The default retry limit is five for single-consumer queues and 8.1-style multiconsumer queues. No retry limit is supported for 8.0-style multiconsumer queues, which are deprecated in Oracle Database Advanced Queuing 10g Release 2 (10.2).

 **Note:**

If a dequeue transaction fails because the server process dies (including `ALTER SYSTEM KILL SESSION`) or `SHUTDOWN ABORT` on the instance, then `RETRY_COUNT` is not incremented.

- The statement processed by the client contains a dequeue that succeeded but the statement itself was undone later due to an exception.

If the dequeue procedure succeeds but the PL/SQL procedure raises an exception, then Oracle Database Advanced Queuing increments the retry count of the message returned by the dequeue procedure.

- The client program successfully dequeued a message but terminated before committing the transaction.

1.8 Propagation Features

Messages can be propagated from one queue to another, allowing applications to communicate with each other without being connected to the same database or to the same queue. The destination queue can be located in the same database or in a remote database.

Propagation enables you to fan out messages to a large number of recipients without requiring them all to dequeue messages from a single queue. You can also use propagation to combine messages from different queues into a single queue. This is known as compositing or funneling messages.

Note:

- You can propagate messages from a multi-consumer queue to a single-consumer queue. Propagation from a single-consumer queue to a multi-consumer queue is not possible.
- For non-sharded queues, you can propagate messages from a multi-consumer queue to a single-consumer non-sharded queue. Propagation from a single-consumer queue to a multi-consumer non-sharded queue is not possible.
- For sharded queues, you can propagate between single-consumer and multi-consumer sharded queues.
- You cannot propagate between sharded and non-sharded queues.

A message is marked as processed in the source queue immediately after the message has been propagated, even if the consumer has not dequeued the message at the remote queue. Similarly, when a propagated message expires at the remote queue, the message is moved to the exception queue of the remote queue, and not to the exception queue of the local queue. Oracle Database Advanced Queuing does not currently propagate the exceptions to the source queue.

To enable propagation, one or more subscribers are defined for the queue from which messages are to be propagated and a schedule is defined for each destination where messages are to be propagated from the queue.

Oracle Database Advanced Queuing automatically checks if the type of the remote queue is structurally equivalent to the type of the local queue within the context of the character sets in which they are created. Messages enqueued in the source queue are then propagated and automatically available for dequeuing at the destination queue or queues.

When messages arrive at the destination queues, sessions based on the source queue schema name are used for enqueueing the newly arrived messages into the destination queues. This means that you must grant schemas of the source queues enqueue privileges to the destination queues.

Propagation runs as an Oracle Scheduler job. A background process, the `JOB_QUEUE_PROCESS` will run the job. Propagation scheduling may be a dedicated process, running continuously and without end, or it may be event driven, in which case it runs only if there is a message to be propagated.

Oracle Database Advanced Queuing offers two kinds of propagation:

- Queue-to-dblink propagation
- Queue-to-queue propagation

Queue-to-dblink propagation delivers messages or events from the source queue to all subscribing queues at the destination database identified by the dblink.

A single propagation schedule is used to propagate messages to all subscribing queues. Hence any changes made to this schedule will affect message delivery to all the subscribing queues.

Queue-to-queue propagation delivers messages or events from the source queue to a specific destination queue identified on the dblink. This allows the user to have fine-grained control on the propagation schedule for message delivery.

This new propagation mode also supports transparent failover when propagating to a destination Oracle RAC system. With queue-to-queue propagation, you are no longer required to re-point a database link if the owner instance of the queue fails on Oracle RAC.

Oracle Database Advanced Queuing provides detailed statistics about the messages propagated and the schedule itself. This information can be used to tune propagation schedules for best performance.

Remote Consumers

Consumers of a message in multiconsumer queues can be local or remote. Local consumers dequeue messages from the same queues into which the producer enqueued the messages. Local consumers have a name but no address or protocol in their agent descriptions.

Remote consumers dequeue from queues that are different from the queues where the messages were enqueued. Remote consumers fall into three categories:

- The address refers to a queue in the same database.

In this case the consumer dequeues the message from a different queue in the same database. These addresses are of the form `[schema].queue_name`. If the schema is not specified, then the schema of the current user is used.

- The address refers to a queue in a different database.

In this case the database must be reachable using database links and the protocol must be either `NULL` or `0`. These addresses are of the form `[schema].queue_name@dblink`. If the schema is not specified, then the schema of the current user is used. If the database link does not have a domain name specified, then the default domain as specified by the `DB_DOMAIN` `init.ora` parameter is used.

- The address refers to a destination that can be reached by a third party protocol.

You must refer to the documentation of the third party software to determine how to specify the address and the protocol database link and schedule propagation.

Propagation to Remote Subscribers

Oracle Database Advanced Queuing validates the database link specified in a propagation schedule when the schedule runs, but not when the schedule is created. It is possible, therefore, to create a queue-to-dblink or queue-to-queue propagation before creating its associated database link. Also, the propagation schedule is not disabled if you remove the database link.

Oracle Database AQ offers two kinds of propagation:

A) **Queue-to-dblink propagation** - specified by providing a (source) queue and (destination) databaselink. Messages from the source queue for any queues at the destination specified by the dblink will be handled by this propagation.

In this scenario, we cannot have multiple propagations from a source queue, with dblinks connecting to the same database. Thus (q1, dblink1) and (q1, dblink2) cannot coexist if both dblinks connect to the same database. However (q1, dblink1) and (q2, dblink1) OR (q1, dblink1) and (q2, dblink2) can coexist as source queues are different.

B) **Queue-to-queue propagation** - specified by providing a (source) queue, (destination) dblink and (destination) queue. Messages from the source queue for the indicated queue at the destination dblink will be handled by this propagation. Here, either (q1, dblink1, dq1), (q1, dblink1, dq2) OR (q1, dblink1, dq1), (q1, dblink2, dq2) succeeds. This strategy works because the destination queues are different even though source queue is the same and dblink connects to the same database.

In this scenario, we cannot have multiple propagations between a source queue, destination queue, even if using different dblinks: (q1, dblink1, q2) and (q1, dblink2, q2) cannot coexist, if dblink1 and dblink2 are pointing to the same database.

Priority and Ordering of Messages in Propagation

The delay, expiration, and priority parameters apply identically to both local and remote consumers in both queue-to-dblink and queue-to-queue propagation. Oracle Database Advanced Queuing accounts for any delay in propagation by adjusting the delay and expiration parameters accordingly. For example, if expiration is set to one hour, and the message is propagated after 15 minutes, then the expiration at the remote queue is set to 45 minutes.

Inboxes and Outboxes

[Figure 1-9](#) illustrates applications on different databases communicating using Oracle Database Advanced Queuing. Each application has an inbox for handling incoming messages and an outbox for handling outgoing messages. Whenever an application enqueues a message, it goes into its outbox regardless of the message destination. Similarly, an application dequeues messages from its inbox no matter where the message originates.

Figure 1-9 Message Propagation in Oracle Database Advanced Queuing

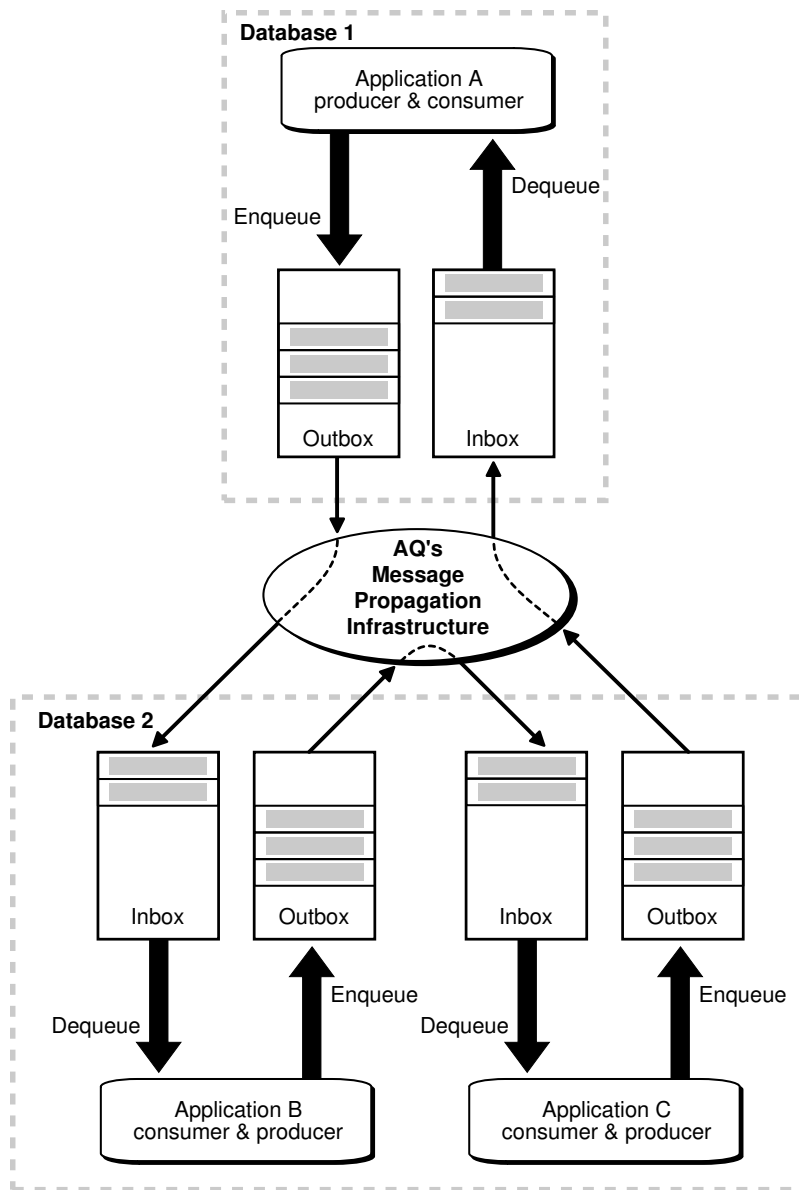

Propagation Scheduling

A queue-to-dblink propagation schedule is defined for a pair of source and destination database links. A queue-to-queue propagation schedule is defined for a pair of source and destination queues. If a queue has messages to be propagated to several queues, then a schedule must be defined for each of the destination queues. With queue-to-dblink propagation, all schedules for a particular remote database have the same frequency. With queue-to-queue propagation, the frequency of each schedule can be adjusted independently of the others.

A schedule indicates the time frame during which messages can be propagated from the source queue. This time frame can depend on several factors such as network traffic, load at the source database, and load at the destination database. If the duration is unspecified, then the time frame is an infinite single window. If a window

must be repeated periodically, then a finite duration is specified along with a `NEXT_TIME` function that defines the periodic interval between successive windows.

When a schedule is created, a job is automatically submitted to the job queue facility to handle propagation.

The propagation schedules defined for a queue can be changed or dropped at any time during the life of the queue. You can also temporarily disable a schedule instead of dropping it. All administrative calls can be made irrespective of whether the schedule is active or not. If a schedule is active, then it takes a few seconds for the calls to be processed.

Propagation of Messages with LOBs

Large Objects can be propagated using Oracle Database Advanced Queuing using two methods:

- Propagation from `RAW` queues

In `RAW` queues the message payload is stored as a BLOB. This allows users to store up to 32KB of data when using the PL/SQL interface and as much data as can be contiguously allocated by the client when using OCI. This method is supported by all releases after 8.0.4 inclusive.

- Propagation from object queues with LOB attributes

The user can populate the `LOB` and read from the `LOB` using Oracle Database `LOB` handling routines. The `LOB` attributes can be `BLOBS` or `CLOBs` (not `NCLOBs`). If the attribute is a `CLOB`, then Oracle Database Advanced Queuing automatically performs any necessary character set conversion between the source queue and the destination queue. This method is supported by all releases from 8.1.3 inclusive.

Note:

Payloads containing LOBs require users to grant explicit `Select`, `Insert` and `Update` privileges on the queue table for doing enqueues and dequeues.

See Also:

Oracle Database SecureFiles and Large Objects Developer's Guide

Propagation Statistics

Detailed runtime information about propagation is gathered and stored in the `DBA_QUEUE_SCHEDULES` view for each propagation schedule. This information can be used by queue designers and administrators to fix problems or tune performance. Similarly, errors reported by the view can be used to diagnose and fix problems. The view also describes additional information such as the session ID of the session handling the propagation and the process name of the job queue process handling the propagation.

For each schedule, detailed propagation statistics are maintained:

- Total number of messages propagated in a schedule

- Total number of bytes propagated in a schedule
- Maximum number of messages propagated in a window
- Maximum number of bytes propagated in a window
- Average number of messages propagated in a window
- Average size of propagated messages
- Average time to propagate a message

Propagation Error Handling

Propagation has built-in support for handling failures and reporting errors. For example, if the specified database link is invalid, if the remote database is unavailable, or if the remote queue is not enabled for enqueueing, then the appropriate error message is reported. Propagation uses a linear backoff scheme for retrying propagation from a schedule that encountered a failure.

If a schedule continuously encounters failures, then the first retry happens after 30 seconds, the second after 60 seconds, the third after 120 seconds and so forth. If the retry time is beyond the expiration time of the current window, then the next retry is attempted at the start time of the next window. A maximum of 16 retry attempts is made, after which the schedule is automatically disabled.

 **Note:**

Once a retry attempt slips to the next propagation window, it will always do so; the exponential backoff scheme no longer governs retry scheduling. If the date function specified in the `next_time` parameter of `DBMS_AQADM.SCHEDULE_PROPAGATION` results in a short interval between windows, then the number of unsuccessful retry attempts can quickly reach 16, disabling the schedule.

When a schedule is disabled automatically due to failures, the relevant information is written into the alert log. A check for scheduling failures indicates:

- How many successive failures were encountered
- The error message indicating the cause for the failure
- The time at which the last failure was encountered

By examining this information, a queue administrator can fix the failure and enable the schedule. If propagation is successful during a retry, then the number of failures is reset to 0.

In some situations that indicate application errors in queue-to-dblink propagations, Oracle Database Advanced Queuing marks messages as `UNDELIVERABLE` and logs a message in `alert.log`. Examples of such errors are when the remote queue does not exist or when there is a type mismatch between the source queue and the remote queue. The trace files in the `background_dump_dest` directory can provide additional information about the error.

When a new job queue process starts, it clears the mismatched type errors so the types can be reverified. If you have capped the number of job queue processes and propagation remains busy, then you might not want to wait for the job queue process

to terminate and restart. Queue types can be reverified at any time using `DBMS_AQADM.VERIFY_QUEUE_TYPES`.

 **Note:**

When a type mismatch is detected in queue-to-queue propagation, propagation stops and throws an error. In such situations you must query the `DBA_SCHEDULES` view to determine the last error that occurred during propagation to a particular destination. The message is not marked as `UNDELIVERABLE`.

Propagation with Oracle Real Application Clusters

Propagation has support built-in for Oracle Real Application Clusters. It is transparent to the user and the queue administrator. The job that handles propagation is submitted to the same instance as the owner of the queue table where the queue resides.

If there is a failure at an instance and the queue table that stores the source queue is migrated to a different instance, then the propagation job is also migrated to the new instance. This minimizes pinging between instances and thus offers better performance.

The destination can be identified by a database link or by destination queue name. Specifying the destination database results in queue-to-dblink propagation. If you propagate messages to several queues in another database, then all queue-to-dblink propagations to that database have the same frequency. Specifying the destination queue name results in queue-to-queue propagation. If you propagate messages to several queues in another database, then queue-to-queue propagation enables you to adjust the frequency of each schedule independently of the others. You can even enable or disable individual propagations.

This new queue-to-queue propagation mode also supports transparent failover when propagating to a destination Oracle RAC system. With queue-to-queue propagation, you are no longer required to re-point a database link if the owner instance of the queue fails on Oracle RAC.

 **See Also:**

["Scheduling a Queue Propagation"](#) for more information on queue-to-queue propagation

Propagation has been designed to handle any number of concurrent schedules. The number of job queue processes is limited to a maximum of 1000, and some of these can be used to handle jobs unrelated to propagation. Hence, propagation has built-in support for multitasking and load balancing.

The propagation algorithms are designed such that multiple schedules can be handled by a single job queue process. The propagation load on a job queue process can be skewed based on the arrival rate of messages in the different source queues.

If one process is overburdened with several active schedules while another is less loaded with many passive schedules, then propagation automatically redistributes the schedules so they are loaded uniformly.

Third-Party Support

If the protocol number for a recipient is in the range 128 - 255, then the address of the recipient is not interpreted by Oracle Database Advanced Queuing and the message is not propagated by the Oracle Database Advanced Queuing system. Instead, a third-party propagator can dequeue the message by specifying a reserved consumer name in the dequeue operation. The reserved consumer names are of the form `AQ$_Pprotocol_number`. For example, the consumer name `AQ$_P128` can be used to dequeue messages for recipients with protocol number 128. The list of recipients for a message with the specific protocol number is returned in the `recipient_list` message property on dequeue.

Another way for Oracle Database Advanced Queuing to propagate messages to and from third-party messaging systems is through Messaging Gateway. Messaging Gateway dequeues messages from an Oracle Database Advanced Queuing queue and guarantees delivery to supported third-party messaging systems. Messaging Gateway can also dequeue messages from these systems and enqueue them to an Oracle Database Advanced Queuing queue.

Propagation Using HTTP

In Oracle Database 10g you can set up Oracle Database Advanced Queuing propagation over HTTP and HTTPS (HTTP over SSL). HTTP propagation uses the Internet access infrastructure and requires that the Oracle Database Advanced Queuing servlet that connects to the destination database be deployed. The database link must be created with the connect string indicating the Web server address and port and indicating HTTP as the protocol. The source database must be created for running Java and XML. Otherwise, the setup for HTTP propagation is more or less the same as Oracle Net Services propagation.

1.9 Message Format Transformation

Applications often use data in different formats. A transformation defines a mapping from one Oracle data type to another.

The [transformation](#) is represented by a SQL function that takes the source data type as input and returns an object of the target data type. Only one-to-one message transformations are supported.

To transform a message during enqueue, specify a mapping in the enqueue options. To transform a message during dequeue, specify a mapping either in the dequeue options or when you add a subscriber. A dequeue mapping overrides a subscriber mapping. To transform a message during propagation, specify a mapping when you add a subscriber.

You can create transformations by creating a single PL/SQL function or by creating an expression for each target type attribute. The PL/SQL function returns an object of the target type or the constructor of the target type. This representation is preferable for simple transformations or those not easily broken down into independent transformations for each attribute.

Creating a separate expression specified for each attribute of the target type simplifies transformation mapping creation and management for individual attributes of the destination type. It is useful when the destination type has many attributes.

As [Figure 1-10](#) shows, queuing, routing, and transformation are essential building blocks to an integrated application architecture. The figure shows how data from the Out queue of a CRM application is routed and transformed in the integration hub and then propagated to the In queue of the Web application. The transformation engine maps the message from the format of the Out queue to the format of the In queue.

Figure 1-10 Transformations in Application Integration

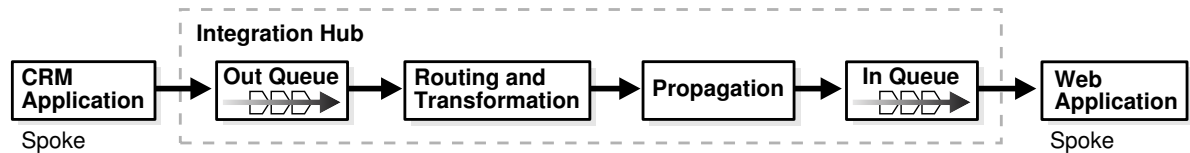

XML Data Transformation

You can transform XML data using the `extract()` method supported on `XMLType` to return an object of `XMLType` after applying the supplied `XPath` expression. You can also create a PL/SQL function that transforms the `XMLType` object by applying an XSLT transformation to it, using the package `XSLPROCESSOR`.

1.10 Other Oracle Database Advanced Queuing Features

This topic describes the AQ features Queue Monitor Coordinator, Integration with Oracle Internet Directory, Integration with Oracle Enterprise Manager, Retention and Message History, Cleaning Up Message Queues, Tracking and Event Journals, Non-repudiation, and Internet Integration.

- [Queue Monitor Coordinator](#)
- [Integration with Oracle Internet Directory](#)
- [Integration with Oracle Enterprise Manager](#)
- [Retention and Message History](#)
- [Cleaning Up Message Queues](#)
- [Tracking and Event Journals](#)
- [Non-repudiation](#)
- [Internet Integration](#)

Queue Monitor Coordinator

Before 10g Release 1 (10.1), the Oracle Database Advanced Queuing time manager process was called queue monitor (`QMn`), a background process controlled by setting the dynamic `init.ora` parameter `AQ_TM_PROCESSES`. Beginning with 10g Release 1 (10.1), time management and many other background processes are automatically controlled by a coordinator-slave architecture called Queue Monitor Coordinator (`QMNC`). `QMNC` dynamically spawns slaves named `qXXX` depending on the system load. The slaves provide mechanisms for:

- Message delay

- Message expiration
- Retry delay
- Garbage collection for the queue table
- Memory management tasks for buffered messages

Because the number of processes is determined automatically and tuned constantly, you are saved the trouble of setting it with `AQ_TM_PROCESSES`.

Although it is no longer necessary to set `init.ora` parameter `AQ_TM_PROCESSES`, it is still supported. If you do set it (up to a maximum of 40), then QMNC still autotunes the number of processes. But you are guaranteed at least the set number of processes for persistent queues. Processes for a [buffered queue](#) and other Oracle Streams tasks, however, are not affected by this parameter.

 **Note:**

If you want to disable the Queue Monitor Coordinator, then you must set `AQ_TM_PROCESSES = 0` in your `pfile` or `spfile`. Oracle strongly recommends that you do NOT set `AQ_TM_PROCESSES = 0`. If you are using Oracle Streams, setting this parameter to zero (which Oracle Database respects no matter what) can cause serious problems.

Integration with Oracle Internet Directory

Oracle Internet Directory is a native LDAPv3 directory service built on Oracle Database that centralizes a wide variety of information, including e-mail addresses, telephone numbers, passwords, security certificates, and configuration data for many types of networked devices. You can look up enterprise-wide queuing information—queues, subscriptions, and events—from one location, the Oracle Internet Directory. Refer to the *Oracle Fusion Middleware Administrator's Guide for Oracle Internet Directory* for more information.

Integration with Oracle Enterprise Manager

You can use Oracle Enterprise Manager to:

- Create and manage queues, queue tables, propagation schedules, and transformations
- Monitor your Oracle Database Advanced Queuing environment using its topology at the database and queue levels, and by viewing queue errors and queue and session statistics

Retention and Message History

The systems administrator specifies the retention duration to retain messages after consumption. Oracle Database Advanced Queuing stores information about the history of each message, preserving the queue and message properties of delay, expiration, and retention for messages destined for local or remote receivers. The information contains the enqueue and dequeue times and the identification of the transaction that executed each request. This allows users to keep a history of relevant messages. The history can be used for tracking, data warehouse, data mining operations, and, also specific auditing functions.

Message retention is not supported for buffered messaging.

Cleaning Up Message Queues

The Oracle Database Advanced Queuing retention feature can be used to automatically clean up messages after the user-specified duration after consumption.

If messages are accidentally inserted into a queue for the wrong subscriber, you can dequeue them with the subscriber name or by message identifier. This consumes the messages, which are cleaned up after their retention time expires.

To clean up messages for a particular subscriber, you can remove the subscriber and add the subscriber again. Removing the subscriber removes all the messages for that subscriber.

Tracking and Event Journals

Retained messages can be related to each other to form sequences. These sequences represent event journals, which are often constructed by applications. Oracle Database Advanced Queuing is designed to let applications create event journals automatically.

Non-repudiation

Oracle Database Advanced Queuing maintains the entire history of information about a message along with the message itself. This information serves as proof of sending and receiving of messages and can be used for non-repudiation of the sender and non-repudiation of the receiver.

The following information is kept at enqueue for non-repudiation of the enqueueer:

- Oracle Database Advanced Queuing agent doing the enqueue
- Database user doing the enqueue
- Enqueue time
- Transaction ID of the transaction doing enqueue

The following information is kept at dequeue for non-repudiation of the dequeueer:

- Oracle Database Advanced Queuing agent doing dequeue
- Database user doing dequeue
- Dequeue time
- Transaction ID of the transaction doing dequeue

After propagation, the `ORIGINAL_MSGID` field in the destination queue of the propagation corresponds to the message ID of the source message. This field can be used to correlate the propagated messages. This is useful for non-repudiation of the dequeueer of propagated messages.

Stronger non-repudiation can be achieved by enqueueing the digital signature of the sender at the time of enqueue with the message and by storing the digital signature of the dequeueer at the time of dequeue.

Internet Integration

You can access Oracle Database Advanced Queuing over the Internet by using [Simple Object Access Protocol \(SOAP\)](#). [Internet Data Access Presentation \(IDAP\)](#) is

the SOAP specification for Oracle Database Advanced Queuing operations. IDAP defines the XML message structure for the body of the SOAP request.

An IDAP message encapsulates the Oracle Database Advanced Queuing request and response in XML. IDAP is used to perform Oracle Database Advanced Queuing operations such as enqueue, dequeue, send notifications, register for notifications, and propagation over the Internet standard transports—HTTP(s) and e-mail. In addition, IDAP encapsulates transactions, security, transformation, and the character set ID for requests.

You can create an alias to an Oracle Database Advanced Queuing agent in Oracle Internet Directory and then use the alias in IDAP documents sent over the Internet to perform Oracle Database Advanced Queuing operations. Using aliases prevents exposing the internal name of the Oracle Database Advanced Queuing agent.

Figure 1-11 shows the architecture for performing Oracle Database Advanced Queuing operations over HTTP. The major components are:

- Oracle Database Advanced Queuing client program
- Web server/servlet runner hosting the Oracle Database Advanced Queuing [servlet](#)
- Oracle Database server

The Oracle Database Advanced Queuing client program sends XML messages (conforming to IDAP) to the Oracle Database Advanced Queuing servlet, which understands the XML message and performs Oracle Database Advanced Queuing operations. Any HTTP client, a Web browser for example, can be used. The Web server/servlet runner hosting the Oracle Database Advanced Queuing servlet, Apache/Jserv or Tomcat for example, interprets the incoming XML messages. The Oracle Database Advanced Queuing servlet connects to the Oracle Database server and performs operations on user queues.

 **Note:**

This feature is certified to work with Apache, along with the Tomcat or Jserv servlet execution engines. However, the code does not prevent the servlet from working with other Web server and servlet execution engines that support Java Servlet 2.0 or higher interfaces.

Figure 1-11 Architecture for Performing Oracle Database Advanced Queuing Operations Using HTTP

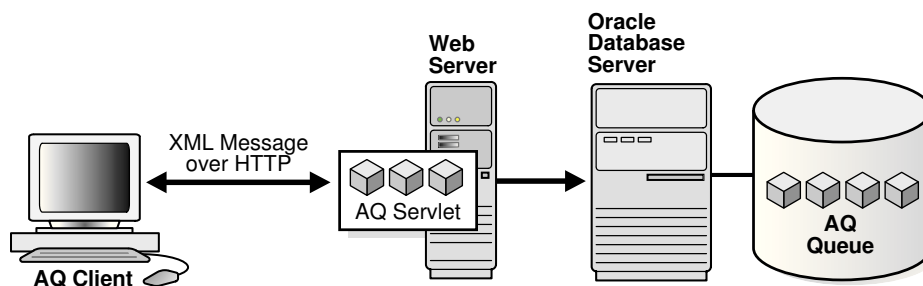

1.11 Interfaces to Oracle Database Advanced Queuing

You can access Oracle Database Advanced Queuing functionality through the interfaces listed in this topic.

- PL/SQL using `DBMS_AQ`, `DBMS_AQADM`, and `DBMS_AQELM`
- Java Message Service (JMS) using the `oracle.jms` Java package
- Internet access using HTTP(S)

Note:

The `oracle.AQ` Java package was deprecated in Oracle Database Advanced Queuing 10g Release 1 (10.1). Oracle recommends that you migrate existing Java AQ applications to Oracle JMS and use Oracle JMS to design your future Java AQ applications.

See Also:

- *Oracle Database PL/SQL Packages and Types Reference*

2

Basic Components of Oracle Database Advanced Queuing

This topic lists the basic components of Oracle Database Advanced Queuing.

- [Object Name](#)
- [Type Name](#)
- [AQ Agent Type](#)
- [AQ Recipient List Type](#)
- [AQ Agent List Type](#)
- [AQ Subscriber List Type](#)
- [AQ Registration Information List Type](#)
- [AQ Post Information List Type](#)
- [AQ Registration Information Type](#)
- [AQ Notification Descriptor Type](#)
- [AQ Message Properties Type](#)
- [AQ Post Information Type](#)
- [AQ\\$_NTFN_MSGID_ARRAY Type](#)
- [Enumerated Constants for AQ Administrative Interface](#)
- [Enumerated Constants for AQ Operational Interface](#)
- [AQ Background Processes](#)

See Also:

- [Oracle Database Advanced Queuing Administrative Interface](#)
- [Oracle Database Advanced Queuing Operations Using PL/SQL](#)

2.1 Object Name

This component names database objects.

```
object_name := VARCHAR2  
object_name := [schema_name.]name
```

This naming convention applies to queues, queue tables, and object types.

Names for objects are specified by an optional [schema](#) name and a name. If the schema name is not specified, then the current schema is assumed. The name must

follow the reserved character guidelines in *Oracle Database SQL Language Reference*. The schema name, agent name, and the [object type](#) name can each be up to 128 bytes long. However starting from 12c Release 2 (12.2.), [queue](#) names and [queue table](#) names can be a maximum of 122 bytes.

2.2 Type Name

This component defines queue types.

```
type_name := VARCHAR2  
type_name := object_type | "RAW"
```

The maximum number of attributes in the object type is limited to 900.

To store payloads of type `RAW`, Oracle Database Advanced Queuing creates a queue table with a `LOB` column as the payload repository. The size of the payload is limited to 32K bytes of data. Because `LOB` columns are used for storing `RAW` payload, the Oracle Database Advanced Queuing administrator can choose the `LOB` tablespace and configure the `LOB` storage by constructing a `LOB` storage string in the `storage_clause` parameter during queue table creation time.

Note:

Payloads containing LOBs require users to grant explicit `Select`, `Insert` and `Update` privileges on the queue table for doing enqueues and dequeues.

2.3 AQ Agent Type

This component identifies a producer or consumer of a message.

```
TYPE AQ$_AGENT IS OBJECT (  
    name          VARCHAR2(30),  
    address       VARCHAR2(1024),  
    protocol      NUMBER);
```

All consumers that are added as subscribers to a multiconsumer queue must have unique values for the `AQ$_AGENT` parameters. Two subscribers cannot have the same values for the `NAME`, `ADDRESS`, and `PROTOCOL` attributes for the `AQ$_AGENT` type. At least one of the three attributes must be different for two subscribers.

You can add subscribers by repeatedly using the `DBMS_AQADM.ADD_SUBSCRIBER` procedure up to a maximum of 1024 subscribers for a multiconsumer queue.

This type has three attributes:

- `name`
This attribute specifies the name of a [producer](#) or a [consumer](#) of a [message](#). It can be the name of an application or a name assigned by an application. A queue can itself be an agent, enqueueing or dequeuing from another queue. The name must follow the reserved character guidelines in *Oracle Database SQL Language Reference*.
- `address`

This attribute is interpreted in the context of `protocol`. If `protocol` is 0 (default), then address is of the form `[schema.]queue[@dblink]`.

- `protocol`

This attribute specifies the protocol to interpret the address and propagate the message. The default value is 0.

2.4 AQ Recipient List Type

This component identifies the list of agents that receive a message.

```
TYPE AQ$RECIPIENT_LIST_T IS TABLE OF aq$agent
INDEX BY BINARY_INTEGER;
```

2.5 AQ Agent List Type

This component identifies the list of agents for `DBMS_AQ.LISTEN` to listen for.

```
TYPE AQ$AGENT_LIST_T IS TABLE OF aq$agent
INDEX BY BINARY_INTEGER;
```

2.6 AQ Subscriber List Type

This component identifies the list of subscribers that subscribe to this queue.

```
TYPE AQ$SUBSCRIBER_LIST_T IS TABLE OF aq$agent
INDEX BY BINARY_INTEGER;
```

2.7 AQ Registration Information List Type

This component identifies the list of registrations to a queue.

```
TYPE AQ$REG_INFO_LIST AS VARRAY(1024) OF sys.aq$reg_info;
```

2.8 AQ Post Information List Type

This component identifies the list of anonymous subscriptions to which messages are posted.

```
TYPE AQ$POST_INFO_LIST AS VARRAY(1024) OF sys.aq$post_info;
```

2.9 AQ Registration Information Type

This component identifies a producer or a consumer of a message.

```
TYPE SYS.AQ$REG_INFO IS OBJECT (
  name                VARCHAR2(128),
  namespace           NUMBER,
  callback            VARCHAR2(4000),
  context             RAW(2000) DEFAULT NULL,
  qosflags            NUMBER,
  timeout             NUMBER,
  ntfn_grouping_class NUMBER,
```

```
ntfn_grouping_value          NUMBER    DEFAULT 600,
ntfn_grouping_type          NUMBER,
ntfn_grouping_start_time    TIMESTAMP WITH TIME ZONE,
ntfn_grouping_repeat_count  NUMBER);
```

Its attributes are described in the following list.

Table 2-1 AQ\$ REG_INFO Type Attributes

Attribute	Description
name	Specifies the name of the subscription. The subscription name is of the form <i>schema.queue</i> if the registration is for a single consumer queue or <i>schema.queue:consumer_name</i> if the registration is for a multiconsumer queues.
namespace	Specifies the namespace of the subscription. To receive notification from Oracle Database AQ queues, the namespace must be <code>DBMS_AQ.NAMESPACE_AQ</code> . To receive notifications from other applications through <code>DBMS_AQ.POST</code> or <code>OCISubscriptionPost()</code> , the namespace must be <code>DBMS_AQ.NAMESPACE_ANONYMOUS</code> .
callback	Specifies the action to be performed on message notification. For HTTP notifications, use <code>http://www.company.com:8080</code> . For e-mail notifications, use <code>mailto://xyz@company.com</code> . For raw message payload for the <code>PLSQLCALLBACK</code> procedure, use <code>plsql://schema.procedure?PR=0</code> . For user-defined type message payload converted to XML for the <code>PLSQLCALLBACK</code> procedure, use <code>plsql://schema.procedure?PR=1</code> .
context	Specifies the context that is to be passed to the callback function
qosflags	Can be set to one or more of the following values to specify the notification quality of service: <ul style="list-style-type: none"> • <code>NTFN_QOS_RELIABLE</code>- This value specifies that reliable notification is required. Reliable notifications persist across instance and database restarts. • <code>NTFN_QOS_PAYLOAD</code> - This value specifies that payload delivery is required. It is supported only for client notification and only for <code>RAW</code> queues. • <code>NTFN_QOS_PURGE_ON_NTFN</code> - This value specifies that the registration is to be purged automatically when the first notification is delivered to this registration location.
ntfn_grouping_class	Currently, only the following flag can be set to specify criterion for grouping. The default value will be 0. If <code>ntfn_grouping_class</code> is 0, all other notification grouping attributes must be 0. <ul style="list-style-type: none"> • <code>NTFN_GROUPING_CLASS_TIME</code> - Notifications grouped by time, that is, the user specifies a time value and a single notification gets published at the end of that time.
ntfn_grouping_value	Time-period of grouping notifications specified in seconds, meaning the time after which grouping notification would be sent periodically until <code>ntfn_grouping_repeat_count</code> is exhausted.
ntfn_grouping_type	<ul style="list-style-type: none"> • <code>NTFN_GROUPING_TYPE_SUMMARY</code> - Summary of all notifications that occurred in the time interval. (Default) • <code>NTFN_GROUPING_TYPE_LAST</code> - Last notification that occurred in the interval.

Table 2-1 (Cont.) AQ\$_REG_INFO Type Attributes

Attribute	Description
ntfn_grouping_start_time	Notification grouping start time. Notification grouping can start from a user-specified time that should be a valid timestamp with time zone. If ntfn_grouping_start_time is not specified when using grouping, the default is to current timestamp with time zone
ntfn_grouping_repeat_count	Grouping notifications will be sent as many times as specified by the notification grouping repeat count and after that revert to regular notifications. The ntfn_grouping_repeat_count, if not specified, will default to <ul style="list-style-type: none"> NTFN_GROUPING_FOREVER - Keep sending grouping notifications forever.

2.10 AQ Notification Descriptor Type

This component specifies the Oracle Database Advanced Queuing descriptor received by AQ PL/SQL callbacks upon notification.

```
TYPE SYS.AQ$_DESCRIPTOR IS OBJECT (
  queue_name      VARCHAR2(61),
  consumer_name   VARCHAR2(30),
  msg_id          RAW(16),
  msg_prop        MSG_PROP_T,
  gen_desc        AQ$_NTFN_DESCRIPTOR,
  msgid_array     SYS.AQ$_NTFN_MSGID_ARRAY,
  ntfnRecdInGrp  NUMBER);
```

It has the following attributes:

Table 2-2 AQ\$_DESCRIPTOR Attributes

Attribute	Description
queue_name	Name of the queue in which the message was enqueued which resulted in the notification
consumer_name	Name of the consumer for the multiconsumer queue
msg_id	Identification number of the message
msg_prop	Message properties specified by the MSG_PROP_T type
gen_desc	Indicates the timeout specifications
msgid_array	Group notification message ID list
ntfnRecdInGrp	Notifications received in group

2.11 AQ Message Properties Type

The message properties type `msg_prop_t` has these components.

```
TYPE AQ$_MSG_PROP_T IS OBJECT(
  priority      number,
  delay         number,
  expiration    number,
```

```

correlation    varchar2(128),
attempts       number,
recipient_list aq$_recipient_list_t,
exception_queue varchar2(51),
enqueue_time   date,
state          number,
sender_id      aq$_agent,
original_msgid raw(16),
delivery_mode  number);

```

The timeout specifications type `AQ$_NTFN_DESCRIPTOR` has a single component:

```

TYPE AQ$_NTFN_DESCRIPTOR IS OBJECT(
    NTFN_FLAGS    number);

```

`NTFN_FLAGS` is set to 1 if the notifications are already removed after a stipulated timeout; otherwise the value is 0.



See Also:

"MESSAGE_PROPERTIES_T Type" in *Oracle Database PL/SQL Packages and Types Reference*

2.12 AQ Post Information Type

This component specifies anonymous subscriptions to which you want to post messages.

```

TYPE SYS.AQ$_POST_INFO IS OBJECT (
    name          VARCHAR2(128),
    namespace     NUMBER,
    payload       RAW(2000));

```

It has three attributes:

- `name`
This attribute specifies the name of the anonymous subscription to which you want to post.
- `namespace`
This attribute specifies the namespace of the anonymous subscription. To receive notifications from other applications using `DBMS_AQ.POST` or `OCISubscriptionPost()`, the namespace must be `DBMS_AQ.NAMESPACE_ANONYMOUS`.
- `payload`
This attribute specifies the payload to be posted to the anonymous subscription. The default is `NULL`.

2.13 AQ\$_NTFN_MSGID_ARRAY Type

This component is for storing grouping notification data for AQ namespace, value 2^{30} which is the max varray size.

```
TYPE SYS.AQ$_NTFN_MSGID_ARRAY AS VARRAY(1073741824)OF RAW(16);
```

2.14 Enumerated Constants for AQ Administrative Interface

When enumerated constants such as `INFINITE`, `TRANSACTIONAL`, and `NORMAL_QUEUE` are selected as values, the symbol must be specified with the scope of the packages defining it.

All types associated with the administrative interfaces must be prepended with `DBMS_AQADM`. For example:

```
DBMS_AQADM.NORMAL_QUEUE
```

[Table 2-3](#) lists the enumerated constants in the Oracle Database Advanced Queuing administrative interface.

Table 2-3 Enumerated Constants in the Oracle Database Advanced Queuing Administrative Interface

Parameter	Options
<code>retention</code>	<code>0,1,2...INFINITE</code>
<code>message_grouping</code>	<code>TRANSACTIONAL, NONE</code>
<code>queue_type</code>	<code>NORMAL_QUEUE, EXCEPTION_QUEUE, NON_PERSISTENT_QUEUE</code>
<code>delivery_mode</code>	<code>BUFFERED, PERSISTENT, PERSISTENT_OR_BUFFERED</code>

 **Note:**

Nonpersistent queues are deprecated in Oracle Database Advanced Queuing 10g Release 2 (10.2). Oracle recommends that you use buffered messaging instead.

2.15 Enumerated Constants for AQ Operational Interface

When using enumerated constants such as `BROWSE`, `LOCKED`, and `REMOVE`, the PL/SQL constants must be specified with the scope of the packages defining them.

All types associated with the operational interfaces must be prepended with `DBMS_AQ`. For example:

```
DBMS_AQ.BROWSE
```

[Table 2-4](#) lists the enumerated constants in the Oracle Database Advanced Queuing operational interface.

Table 2-4 Enumerated Constants in the Oracle Database Advanced Queuing Operational Interface

Parameter	Options
<code>visibility</code>	<code>IMMEDIATE, ON_COMMIT</code>

Table 2-4 (Cont.) Enumerated Constants in the Oracle Database Advanced Queuing Operational Interface

Parameter	Options
dequeue mode	BROWSE, LOCKED, REMOVE, REMOVE_NODATA
navigation	FIRST_MESSAGE, NEXT_MESSAGE, NEXT_TRANSACTION
state	WAITING, READY, PROCESSED, EXPIRED
wait	FOREVER, NO_WAIT
delay	NO_DELAY
expiration	NEVER
namespace	NAMESPACE_AQ, NAMESPACE_ANONYMOUS
delivery_mode	BUFFERED, PERSISTENT, PERSISTENT_OR_BUFFERED
quosflags	NTFN_QOS_RELIABLE, NTFN_QOS_PAYLOAD, NTFN_QOS_PURGE_ON_NTFN
ntfn_grouping_class	NTFN_GROUPING_CLASS_TIME
ntfn_grouping_type	NTFN_GROUPING_TYPE_SUMMARY, NTFN_GROUPING_TYPE_LAST
ntfn_grouping_repeat_co unt	NTFN_GROUPING_FOREVER

2.16 AQ Background Processes

These topics describe the background processes of Oracle Database Advanced Queuing.

- [Queue Monitor Processes](#)
- [Job Queue Processes](#)
- [AQ Background Architecture](#)

2.16.1 Queue Monitor Processes

Oracle recommends leaving the `AQ_TM_PROCESSES` parameter unspecified and let the system autotune.

Many Oracle Database Advanced Queuing or Streams tasks are executed in the background. These include converting messages with `DELAY` specified into the `READY` state, expiring messages, moving messages to exception queues, spilling and recovering of buffered messages, and similar operations.

It is no longer necessary to set `AQ_TM_PROCESSES` when Oracle Database AQ or Streams is used. If a value is specified, that value is taken into account when starting the `Qxx` processes. However, the number of `Qxx` processes can be different from what was specified by `AQ_TM_PROCESSES`.

No separate [API](#) is needed to disable or enable the background processes. This is controlled by setting `AQ_TM_PROCESSES` to zero or nonzero. Oracle recommends, however, that you leave the `AQ_TM_PROCESSES` parameter unspecified and let the system autotune.

 **Note:**

If you want to disable the Queue Monitor Coordinator, then you must set `AQ_TM_PROCESSES = 0` in your `pfile` or `spfile`. Oracle strongly recommends that you do NOT set `AQ_TM_PROCESSES = 0`. If you are using Oracle Streams, then setting this parameter to zero (which Oracle Database respects no matter what) can cause serious problems.

2.16.2 Job Queue Processes

Propagation and PL/SQL notifications are handled by job queue (Jnnn) processes.

The parameter `JOB_QUEUE_PROCESSES` no longer needs to be specified. The database scheduler automatically starts the job queue processes that are needed for the propagation and notification jobs.

2.16.3 AQ Background Architecture

Oracle Database Advanced Queuing 12c Release 1 (12.1) introduces a new AQ background architecture with a 3-tier design.

- Tier1 (AQPC): A single background process called the Advanced Queueing Process Coordinator is created at instance startup. It will be responsible for creating and managing various master processes. The coordinator statistics can be viewed using `GV$AQ_BACKGROUND_COORDINATOR`.
- Tier2 (QM**): There will be many master processes named Queue Monitors. Each will be responsible for handling a distinct type of job. Jobs could be of type notification (Emon pool), queue monitors (handling sharded queues time manager etc), cross process etc.

 **Note:**

The old processes like QMNC and EMNC will be subsumed within one of new master processes.

A job can be defined as a type of work which needs own scheduling mechanism across multiple server processes (Q***) to perform its task. The master process statistics and their jobs can be viewed using `GV$AQ_JOB_COORDINATOR`.

- Tier3(Q***): There will be a single pool of server processes for all above mentioned master processes. Each process will be associated to a single master process at a time. But can be rescheduled to another once original master relinquishes its need to use it. These servers will perform jobs for respective masters providing performance and scalability. The server process statistics and its current master association can be viewed using `GV$AQ_SERVER_POOL`.

3

Oracle Database Advanced Queuing: Programmatic Interfaces

These topics describe the various language options and elements you must work with and issues to consider in preparing your Oracle Database Advanced Queuing (AQ) application environment.

 **Note:**

Java package `oracle.AQ` was deprecated in 10g Release 1 (10.1). Oracle recommends that you migrate existing Java AQ applications to Oracle JMS (or other Java APIs) and use Oracle JMS (or other Java APIs) to design your future Java AQ applications.

Topics:

- [Programmatic Interfaces for Accessing Oracle Database Advanced Queuing](#)
- [Using PL/SQL to Access Oracle Database Advanced Queuing](#)
- [Using OCI to Access Oracle Database Advanced Queuing](#)
- [Using OCCI to Access Oracle Database Advanced Queuing](#)
- [Using Oracle Java Message Service \(Oracle JMS\) to Access Oracle Database Advanced Queuing](#)
- [Using Oracle Database Advanced Queuing XML Servlet to Access Oracle Database Advanced Queuing](#)
- [Comparing Oracle Database Advanced Queuing Programmatic Interfaces](#)

3.1 Programmatic Interfaces for Accessing Oracle Database Advanced Queuing

The table lists Oracle Database Advanced Queuing programmatic interfaces, functions supported in each interface, and syntax references.

Table 3-1 Oracle Database Advanced Queuing Programmatic Interfaces

Language	Precompiler or Interface Program	Functions Supported	Syntax References
PL/SQL	DBMS_AQADM and DBMS_AQ Packages	Administrative and operational	<i>Oracle Database PL/SQL Packages and Types Reference</i>

Table 3-1 (Cont.) Oracle Database Advanced Queuing Programmatic Interfaces

Language	Precompiler or Interface Program	Functions Supported	Syntax References
C	Oracle Call Interface (OCI)	Operational only	<i>Oracle Call Interface Programmer's Guide</i>
Java (JMS)	oracle.JMS package using JDBC API	Administrative and operational	<i>Oracle Database Advanced Queuing Java API Reference</i>
AQ XML servlet	Internet Data Access Presentation (IDAP)	Operational only	<i>Oracle XML DB Developer's Guide</i>

3.2 Using PL/SQL to Access Oracle Database Advanced Queuing

The PL/SQL packages `DBMS_AQADM` and `DBMS_AQ` support access to Oracle Database Advanced Queuing administrative and operational functions using the native Oracle Database Advanced Queuing interface.

These functions include:

- Create [queue](#), [queue table](#), [nonpersistent queue](#), [sharded queue](#), multiconsumer queue/topic, RAW [message](#), or message with structured data
- Get queue table, queue, or multiconsumer queue/topic
- Alter queue table or queue/topic
- Drop queue/topic
- Start or stop queue/topic
- Grant and revoke privileges
- Add, remove, or alter [subscriber](#)
- Add, remove, or alter an Oracle Database Advanced Queuing Internet agent
- Grant or revoke privileges of database users to Oracle Database Advanced Queuing Internet agents
- Enable, disable, or alter [propagation](#) schedule
- Enqueue messages to single [consumer](#) queue (point-to-point model)
- Publish messages to multiconsumer queue/topic ([publish/subscribe](#) model)
- Subscribe for messages in multiconsumer queue
- Browse messages in a queue
- Receive messages from queue/topic
- Register to receive messages asynchronously
- Listen for messages on multiple queues/topics
- Post messages to anonymous subscriptions
- Bind or unbind agents in a [Lightweight Directory Access Protocol](#) (LDAP) server

- Add or remove aliases to Oracle Database Advanced Queuing objects in a LDAP server

Available PL/SQL `DBMS_AQADM` and `DBMS_AQ` functions are listed in detail in Table 3–2 through Table 3–9.

 **See Also:**

Oracle Database PL/SQL Packages and Types Reference for detailed documentation of `DBMS_AQADM` and `DBMS_AQ`, including syntax, parameters, parameter types, return values, and examples

3.3 Using OCI and the Thin JDBC Driver to Access Oracle Database Advanced Queuing

An Oracle Call Interface (OCI) provides an interface to Oracle Database Advanced Queuing functions using the native Oracle Database Advanced Queuing interface.

An OCI client can perform the following actions:

- Enqueue messages
- Dequeue messages
- Listen for messages on sets of queues
- Register to receive message notifications

In addition, OCI clients can receive [asynchronous](#) notifications for new messages in a queue using `OCISubscriptionRegister`. Sharded queues do not support OCI clients.

Oracle Type Translator

For queues with user-defined payload types, the Oracle type translator must be used to generate the OCI/OCCI mapping for the Oracle type. The OCI client is responsible for freeing the memory of the Oracle Database Advanced Queuing descriptors and the message payload.

 **See Also:**

"OCI and Advanced Queuing" and "Publish-Subscribe Notification" in *Oracle Call Interface Programmer's Guide* for syntax details

3.4 Using OCCI to Access Oracle Database Advanced Queuing

C++ applications can use OCCI, which has a set of Oracle Database Advanced Queuing interfaces that enable messaging clients to access Oracle Database Advanced Queuing.

OCCI AQ supports all the operational functions required to send/receive and publish/subscribe messages in a message-enabled database. Synchronous and asynchronous message consumption is available, based on a message selection rule. Sharded queues do not support OCCI clients.



See Also:

"Oracle Database Advanced Queuing" in *Oracle C++ Call Interface Programmer's Guide*

3.5 Using Oracle Java Message Service (Oracle JMS) to Access Oracle Database Advanced Queuing

Java Message Service (JMS) is a messaging standard defined by Sun Microsystems, Oracle, IBM, and other vendors. JMS is a set of interfaces and associated semantics that define how a JMS client accesses the facilities of an enterprise messaging product. Oracle Java Message Service (Oracle JMS) provides a Java API for Oracle Database Advanced Queuing based on the JMS standard.

[Oracle Java Message Service](#) (Oracle JMS) supports the standard JMS interfaces and has extensions to support administrative operations and other features that are not a part of the standard.

Standard [Java Message Service](#)(JMS) features include:

- Point-to-point model of communication using queues
- Publish/subscribe model of communication using topics
- `ObjectMessage`, `StreamMessage`, `TextMessage`, `BytesMessage`, and `MapMessage` message types
- Asynchronous and [synchronous](#) delivery of messages
- Message selection based on message header fields or properties

Oracle JMS extensions include:

- Administrative API to create queue tables, queues and topics
- Point-to-multipoint communication using [recipient](#) lists for topics
- Message propagation between destinations, which allows the application to define remote subscribers
- Support for transactional sessions, enabling JMS and SQL operations in one transaction
- Message retention after messages have been dequeued
- Message delay, allowing messages to be made visible after a certain delay
- Exception handling, allowing messages to be moved to exception queues if they cannot be processed successfully
- Support for `AdtMessage`

These are stored in the database as Oracle objects, so the payload of the message can be queried after it is enqueued. Subscriptions can be defined on the contents of these messages as opposed to just the message properties.

- Topic browsing

This allows durable subscribers to browse through the messages in a publish/subscribe (topic) destination. It optionally allows these subscribers to purge the browsed messages, so they are no longer retained by Oracle Database Advanced Queuing for that subscriber.

See Also:

- *Java Message Service Specification*, version 1.1, March 18, 2002, Sun Microsystems, Inc.
- *Oracle Database Advanced Queuing Java API Reference*

Accessing Standard and Oracle JMS Applications

Standard JMS interfaces are in the `javax.jms` package. Oracle JMS interfaces are in the `oracle.jms` package. You must have `EXECUTE` privilege on the `DBMS_AQIN` and `DBMS_AQJMS` packages to use the Oracle JMS interfaces. You can also acquire these rights through the `AQ_USER_ROLE` or the `AQ_ADMINISTRATOR_ROLE`. You also need the appropriate system and queue or topic privileges to [send](#) or receive messages.

Because Oracle JMS uses [Java Database Connectivity](#) (JDBC) to connect to the database, its applications can run outside the database using the JDBC OCI driver or JDBC thin driver.

Using JDBC OCI Driver or JDBC Thin Driver

To use JMS with clients running outside the database, you must include the appropriate [JDBC driver](#), [Java Naming and Directory Interface](#) (JNDI) jar files, and Oracle Database Advanced Queuing jar files in your `CLASSPATH`.

Note that the Oracle Database does not support JDK 1.2, JDK 1.3, JDK 1.4, JDK5.n and all `classes12*.jar` files. You need to use the `ojdbc6.jar` and `ojdbc7.jar` files with JDK 6.n and JDK 7.n, respectively. The following jar and zip files should be in the `CLASSPATH` based on the release of JDK you are using.

For JDK 1.5.x, the `CLASSPATH` must contain:

```
ORACLE_HOME/jdbc/lib/ojdbc6.jar
```

For JDK 1.6.x, the `CLASSPATH` must contain:

```
ORACLE_HOME/jdbc/lib/ojdbc7.jar
```

The following files are used for either JDK version:

```
ORACLE_HOME/lib/jta.jar
ORACLE_HOME/xdk/lib/xmlparserv2.jar
ORACLE_HOME/rdbms/jlib/xdm.jar
ORACLE_HOME/rdbms/jlib/raqapi.jar
ORACLE_HOME/rdbms/jlib/jmscommon.jar
```

Using Oracle Server Driver in JServer

If your application is running inside the **JServer**, then you should be able to access the Oracle JMS classes that have been automatically loaded when the JServer was installed. If these classes are not available, then you must load `jmscommon.jar` followed by `aqapi.jar` using the `$ORACLE_HOME/rdbms/admin/initjms` SQL script.

3.6 Using Oracle Database Advanced Queuing XML Servlet to Access Oracle Database Advanced Queuing

You can use Oracle Database Advanced Queuing XML servlet to access Oracle Database Advanced Queuing over HTTP using Simple Object Access Protocol (SOAP) and an Oracle Database Advanced Queuing XML message format called Internet Data Access Presentation (IDAP).

Using the Oracle Database Advanced Queuing servlet, a client can perform the following actions:

- Send messages to single-consumer queues
- Publish messages to multiconsumer queues/topics
- Receive messages from queues
- Register to receive message notifications

3.7 Comparing Oracle Database Advanced Queuing Programmatic Interfaces

These topics list and compare the Oracle Database Advanced Queuing Administrative Interfaces and the Oracle Database Advanced Queuing Operational Interfaces.

Available functions for the Oracle Database Advanced Queuing programmatic interfaces are listed by use case in Table 3-2 through Table 3-9. Use cases are described in [Oracle Database Advanced Queuing Administrative Interface](#) through [Oracle Database Advanced Queuing Operations Using PL/SQL](#) and [Oracle Java Message Service Basic Operations](#) through [Oracle Java Message Service Shared Interfaces](#).

3.7.1 Oracle Database Advanced Queuing Administrative Interfaces

The table lists the equivalent Oracle Database Advanced Queuing administrative functions for the PL/SQL and Java (JMS) programmatic interfaces.

Table 3-2 Comparison of Oracle Database Advanced Queuing Programmatic Interfaces: Administrative Interface

Use Case	PL/SQL	Java (JMS)
Create a connection factory	N/A	AQjmsFactory.getQueueConnectionFactory AQjmsFactory.getTopicConnectionFactory
Register a ConnectionFactory in an LDAP server	N/A	AQjmsFactory.registerConnectionFactory
Create a queue table	DBMS_AQADM.CREATE_QUEUE_TABLE	AQjmsSession.createQueueTable
Get a queue table	Use <i>schema.queue_table_name</i>	AQjmsSession.getQueueTable
Alter a queue table	DBMS_AQADM.ALTER_QUEUE_TABLE	AQQueueTable.alter
Drop a queue table	DBMS_AQADM.DROP_QUEUE_TABLE	AQQueueTable.drop
Create a queue	DBMS_AQADM.CREATE_QUEUE	AQjmsSession.createQueue
Get a queue	Use <i>schema.queue_name</i>	AQjmsSession.getQueue
Create a multiconsumer queue/topic in a queue table with multiple consumers enabled	DBMS_AQADM.CREATE_QUEUE	AQjmsSession.createTopic
Get a multiconsumer queue/topic	Use <i>schema.queue_name</i>	AQjmsSession.getTopic
Alter a queue/topic	DBMS_AQADM.ALTER_QUEUE	AQjmsDestination.alter
Start a queue/topic	DBMS_AQADM.START_QUEUE	AQjmsDestination.start
Stop a queue/topic	DBMS_AQADM.STOP_QUEUE	AQjmsDestination.stop
Drop a queue/topic	DBMS_AQADM.DROP_QUEUE	AQjmsDestination.drop
Create a sharded queue	DBMS_AQADM.CREATE_SHARDED_QUEUE	AQjmsDestination.createJMSShardedQueue
Drop a sharded queue	DBMS_AQADM.DROP_SHARDED_QUEUE	AQjmsDestination.dropJMSShardedQueue

Table 3-2 (Cont.) Comparison of Oracle Database Advanced Queuing Programmatic Interfaces: Administrative Interface

Use Case	PL/SQL	Java (JMS)
Alter a sharded queue	DBMS_AQADM.ALTER_SHARDED_QUEUE	None. Use PL/SQL API.
Grant system privileges	DBMS_AQADM.GRANT_SYSTEM_PRIVILEGE	AQjmsSession.grantSystemPrivilege
Revoke system privileges	DBMS_AQADM.REVOKE_SYSTEM_PRIVILEGE	AQjmsSession.revokeSystemPrivilege
Grant a queue/topic privilege	DBMS_AQADM.GRANT_QUEUE_TOPIC_PRIVILEGE	AQjmsDestination.grantQueuePrivilege AQjmsDestination.grantTopicPrivilege
Revoke a queue/topic privilege	DBMS_AQADM.REVOKE_QUEUE_TOPIC_PRIVILEGE	AQjmsDestination.revokeQueuePrivilege AQjmsDestination.revokeTopicPrivilege
Verify a queue type	DBMS_AQADM.VERIFY_QUEUE_TYPES	Not supported
Add a subscriber	DBMS_AQADM.ADD_SUBSCRIBER	See Table 3-6
Alter a subscriber	DBMS_AQADM.ALTER_SUBSCRIBER	See Table 3-6
Remove a subscriber	DBMS_AQADM.REMOVE_SUBSCRIBER	See Table 3-6
Schedule propagation	DBMS_AQADM.SCHEDULE_PROPAGATION	AQjmsDestination.schedulePropagation
Enable a propagation schedule	DBMS_AQADM.ENABLE_PROPAGATION_SCHEDULE	AQjmsDestination.enablePropagationSchedule
Alter a propagation schedule	DBMS_AQADM.ALTER_PROPAGATION_SCHEDULE	AQjmsDestination.alterPropagationSchedule

Table 3-2 (Cont.) Comparison of Oracle Database Advanced Queuing Programmatic Interfaces: Administrative Interface

Use Case	PL/SQL	Java (JMS)
Disable a propagation schedule	DBMS_AQADM.DISABLE_PROPAGATION_SCHEDULE	AQjmsDestination.disablePropagationSchedule
Unschedule a propagation	DBMS_AQADM.UNSCHEDULE_PROPAGATION	AQjmsDestination.unschedulePropagation
Create an Oracle Database Advanced Queuing Internet Agent	DBMS_AQADM.CREATE_AQ_AGENT	Not supported
Alter an Oracle Database Advanced Queuing Internet Agent	DBMS_AQADM.ALTER_AQ_AGENT	Not supported
Drop an Oracle Database Advanced Queuing Internet Agent	DBMS_AQADM.DROP_AQ_AGENT	Not supported
Grant database user privileges to an Oracle Database Advanced Queuing Internet Agent	DBMS_AQADM.ENABLE_AQ_AGENT	Not supported
Revoke database user privileges from an Oracle Database Advanced Queuing Internet Agent	DBMS_AQADM.DISABLE_AQ_AGENT	Not supported
Add alias for queue, agent, ConnectionFactory in a LDAP server	DBMS_AQADM.ADD_ALIAS_TOM_LDAP	Not supported
Delete alias for queue, agent, ConnectionFactory in a LDAP server	DBMS_AQADM.DEL_ALIAS_FROM_LDAP	Not supported

3.7.2 Oracle Database Advanced Queuing Operational Interfaces

These tables list equivalent Oracle Database Advanced Queuing operational functions for the programmatic interfaces PL/SQL, OCI, Oracle Database Advanced Queuing XML Servlet, and JMS, for various use cases.

Table 3-3 Comparison of Oracle Database Advanced Queuing Programmatic Interfaces: Operational Interface—Create Connection, Session, Message Use Cases

Use Case	PL/SQL	OCI	AQ XML Servlet	JMS
Create a connection	N/A	OCIServer Attach	Open an HTTP connection after authenticating with the Web server	AQjmsQueueConnectionFactory .createQueueConnection AQjmsTopicConnectionFactory .createTopicConnection
Create a session	N/A	OCISession Begin	An HTTP servlet session is automatically started with the first SOAP request	QueueConnection.createQueueSession TopicConnection.createTopicSession
Create a RAW message	Use SQL RAW type for message	Use OCIRaw for Message	Supply the hex representation of the message payload in the XML message. For example, <raw>023f4523</raw>	Not supported
Create a message with structured data	Use SQL Oracle object type for message	Use SQL Oracle object type for message	For Oracle object type queues that are not JMS queues (that is, they are not type AQ\$_JMS_*), the XML specified in <message payload> must map to the SQL type of the payload for the queue table. For JMS queues, the XML specified in the <message_payload> must be one of the following: <jms_text_message>, <jms_map_message>, <jms_bytes_message>, <jms_object_message>	Session.createTextMessage Session.createObjectMessage Session.createMapMessage Session.createBytesMessage Session.createStreamMessage AQjmsSession.createAdtMessage
Create a message producer	N/A	N/A	N/A	QueueSession.createSender TopicSession.createPublisher

Table 3-4 Comparison of Oracle Database Advanced Queuing Programmatic Interfaces: Operational Interface—Enqueue Messages to a Single-Consumer Queue, Point-to-Point Model Use Cases

Use Case	PL/SQL	OCI	AQ XML Servlet	JMS
Enqueue a message to a single-consumer queue	DBMS_AQ.enqueue	OCIAQEnq	<AQXmlSend>	QueueSender.send

Table 3-4 (Cont.) Comparison of Oracle Database Advanced Queuing Programmatic Interfaces: Operational Interface—Enqueue Messages to a Single-Consumer Queue, Point-to-Point Model Use Cases

Use Case	PL/SQL	OCI	AQ XML Servlet	JMS
Enqueue a message to a queue and specify visibility options	DBMS_AQ.enqueue Specify visibility in ENQUEUE_OPTIONS	OCIAQEnq Specify OCI_ATTR_VISIBILITY in OCIAQEnqOptions OCIAQEnqOptions	<AQXmlSend> Specify <visibility> in <producer_options>	Not supported
Enqueue a message to a single-consumer queue and specify message properties priority and expiration	DBMS_AQ.enqueue Specify priority, expiration in MESSAGE_PROPERTIES	OCIAQEnq Specify OCI_ATTR_PRIORITY, OCI_ATTR_EXPIRATION in OCIAQMsgProperties	<AQXmlSend> Specify <priority>, <expiration> in <message_header>	Specify priority and TimeToLive during QueueSender.send or .setTimeToLive and MessageProducer. setPriority followed by QueueSender.send
Enqueue a message to a single-consumer queue and specify message properties correlationID, delay, and exception queue	DBMS_AQ.enqueue Specify correlation, delay, exception_queue in MESSAGE_PROPERTIES	OCIAQEnq Specify OCI_ATTR_CORRELATION, OCI_ATTR_DELAY, OCI_ATTR_EXCEPTION_QUEUE in OCIAQMsgProperties	<AQXmlSend> Specify <correlation_id>, <delay>, <exception_queue> in <message_header>	Message.setJMS CorrelationID Delay and exception queue specified as provider specific message properties JMS_OracleDelay JMS_OracleExcpQ followed by QueueSender.send

Table 3-4 (Cont.) Comparison of Oracle Database Advanced Queuing Programmatic Interfaces: Operational Interface—Enqueue Messages to a Single-Consumer Queue, Point-to-Point Model Use Cases

Use Case	PL/SQL	OCI	AQ XML Servlet	JMS
Enqueue a message to a single-consumer queue and specify user-defined message properties	Not supported Properties should be part of payload	Not supported Properties should be part of payload	<AQXmlSend> Specify <name> and <int_value>, <string_value>, <long_value>, and so on in <user_properties>	Message.setIntProperty Message.setStringProperty Message.setBooleanProperty and so forth, followed by QueueSender.send
Enqueue a message to a single-consumer queue and specify message transformation	DBMS_AQ.enqueue Specify transformation in ENQUEUE_OPTIONS	OCIAQEnq Specify OCI_ATTR_TRANSFORMATION in OCIAQEnqOptions	<AQXmlSend> Specify <transformation> in <producer_options>	AQjmsQueueSender.setTransformation followed by QueueSender.send

Table 3-5 Comparison of Oracle Database Advanced Queuing Programmatic Interfaces: Operational Interface—Publish Messages to a Multiconsumer Queue/Topic, Publish/Subscribe Model Use Cases

Use Case	PL/SQL	OCI	AQ XML Servlet	JMS
Publish a message to a multiconsumer queue/topic using default subscription list	DBMS_AQ.enqueue Set recipient_list to NULL in MESSAGE_PROPERTIES	OCIAQEnq Set OCI_ATTR_RECIPIENT_LIST to NULL in OCIAQMsgProperties	<AQXmlPublish>	TopicPublisher.publish
Publish a message to a multiconsumer queue/topic using specific recipient list See footnote-1	DBMS_AQ.enqueue Specify recipient list in MESSAGE_PROPERTIES	OCIAQEnq Specify OCI_ATTR_RECIPIENT_LIST in OCIAQMsgProperties	<AQXmlPublish> Specify <recipient_list> in <message_header>	AQjmsTopicPublisher.publish Specify recipients as an array of AQjmsAgent

Table 3-5 (Cont.) Comparison of Oracle Database Advanced Queuing Programmatic Interfaces: Operational Interface—Publish Messages to a Multiconsumer Queue/Topic, Publish/Subscribe Model Use Cases

Use Case	PL/SQL	OCI	AQ XML Servlet	JMS
Publish a message to a multiconsumer queue/topic and specify message properties priority and expiration	DBMS_AQ.enqueue	OCIAQEnq	<AQXmlPublish>	Specify priority and TimeToLive during
	Specify priority, expiration in MESSAGE_PROPERTIES	Specify OCI_ATTR_PRIORITY, OCI_ATTR_EXPIRATION in OCIAQMsgProperties	Specify <priority>, <expiration> in <message_header>	TopicPublisher.publish or MessageProducer.setTimeToLive and MessageProducer.setPriority followed by TopicPublisher.publish
Publish a message to a multiconsumer queue/topic and specify send options correlationID, delay, and exception queue	DBMS_AQ.enqueue	OCIAQEnq	<AQXmlPublish>	Message.setJMSCorrelationID
	Specify correlation, delay, exception_queue in MESSAGE_PROPERTIES	Specify OCI_ATTR_CORRELATION, OCI_ATTR_DELAY, OCI_ATTR_EXCEPTION_QUEUE in OCIAQMsgProperties	Specify <correlation_id>, <delay>, <exception_queue> in <message_header>	Delay and exception queue specified as provider-specific message properties JMS_OracleDelay JMS_OracleExcpQ followed by TopicPublisher.publish
Publish a message to a topic and specify user-defined message properties	Not supported Properties should be part of payload	Not supported Properties should be part of payload	<AQXmlPublish> Specify <name> and <int_value>, <string_value>, <long_value>, and so on in <user_properties>	Message.setIntProperty Message.setStringProperty Message.setBooleanProperty and so forth, followed by TopicPublisher.publish

Table 3-5 (Cont.) Comparison of Oracle Database Advanced Queuing Programmatic Interfaces: Operational Interface—Publish Messages to a Multiconsumer Queue/Topic, Publish/Subscribe Model Use Cases

Use Case	PL/SQL	OCI	AQ XML Servlet	JMS
Publish a message to a topic and specify message transformation	DBMS_AQ.enqueue Specify transformation in ENQUEUE_OPTIONS	OCIAQEnq Specify OCI_ATTR_TRANSFORMATION in OCIAQEnqOptions	<AQXmlPublish> Specify <transformation> in <producer_options>	AQjmsTopic Publisher.setTransformation followed by TopicPublisher.publish

Table 3-6 Comparison of Oracle Database Advanced Queuing Programmatic Interfaces: Operational Interface—Subscribing for Messages in a Multiconsumer Queue/Topic, Publish/Subscribe Model Use Cases

Use Case	PL/SQL	OCI	AQ XML Servlet	JMS
Add a subscriber	See administrative interfaces	Not supported	Not supported	TopicSession.createDurableSubscriber AQjmsSession.createDurableSubscriber
Alter a subscriber	See administrative interfaces	Not supported	Not supported	TopicSession.createDurableSubscriber AQjmsSession.createDurableSubscriber using the new selector
Remove a subscriber	See administrative interfaces	Not supported	Not supported	AQjmsSession.unsubscribe

Table 3-7 Comparison of Oracle Database Advanced Queuing Programmatic Interfaces: Operational Interface—Browse Messages in a Queue Use Cases

Use Case	PL/SQL	OCI	AQ XML Servlet	JMS
Browse messages in a queue/topic	DBMS_AQ.dequeue	OCIAQDeq	<AQXmlReceive>	QueueSession.createBrowser
	Set dequeue_mode to BROWSE in DEQUEUE_OPTIONS	Set OCI_ATTR_DEQ_MODE to BROWSE in OCIAQDeqOptions	Specify <dequeue_mode> BROWSE in	QueueBrowser.getEnumeration Not supported on topics
			<consumer_options>	oracle.jms.AQjmsSession.createBrowser oracle.jms.TopicBrowser.getEnumeration
Browse messages in a queue/topic and lock messages while browsing	DBMS_AQ.dequeue	OCIAQDeq	<AQXmlReceive>	AQjmsSession.createBrowser
	Set dequeue_mode to LOCKED in DEQUEUE_OPTIONS	Set OCI_ATTR_DEQ_MODE to LOCKED in OCIAQDeqOptions	Specify <dequeue_mode> LOCKED in	set locked to TRUE. QueueBrowser.getEnumeration
			<consumer_options>	Not supported on topics oracle.jms.AQjmsSession.createBrowser oracle.jms.TopicBrowser.getEnumeration

Table 3-8 Comparison of Oracle Database Advanced Queuing Programmatic Interfaces: Operational Interface—Receive Messages from a Queue/Topic Use Cases

Use Case	PL/SQL	OCI	AQ XML Servlet	JMS
Start a connection for receiving messages	N/A	N/A	N/A	Connection.start
Create a message consumer	N/A	N/A	N/A	QueueSession.createQueueReceiver
				TopicSession.createDurableSubscriber
				AQjmsSession.createTopicReceiver

Table 3-8 (Cont.) Comparison of Oracle Database Advanced Queuing Programmatic Interfaces: Operational Interface—Receive Messages from a Queue/Topic Use Cases

Use Case	PL/SQL	OCI	AQ XML Servlet	JMS
Dequeue a message from a queue/topic and specify visibility	DBMS_AQ.dequeue Specify visibility in DEQUEUE_OPTIONS	OCIAQDeq Specify OCI_ATTR_VISIBILITY in OCIAQDeqOptions	<AQXmlReceive> Specify <visibility> in <consumer_options>	Not supported
Dequeue a message from a queue/topic and specify transformation	DBMS_AQ.dequeue Specify transformation in DEQUEUE_OPTIONS	OCIAQDeq Specify OCI_ATTR_TRANSFORMATION in OCIAQDeqOptions	<AQXmlReceive> Specify <transformation> in <consumer_options>	AQjmsQueueReceiver. setTransformation AQjmsTopicSubscriber. setTransformation AQjmsTopicReceiver. setTransformation
Dequeue a message from a queue/topic and specify navigation mode	DBMS_AQ.dequeue Specify navigation in DEQUEUE_OPTIONS	OCIAQDeq Specify OCI_ATTR_NAVIGATION in OCIAQDeqOptions	<AQXmlReceive> Specify <navigation> in <consumer_options>	AQjmsQueueReceiver. setNavigationMode AQjmsTopicSubscriber. setNavigationMode AQjmsTopicReceiver. setNavigationMode
Dequeue a message from a single-consumer queue	DBMS_AQ.dequeue Set dequeue_mode to REMOVE in DEQUEUE_OPTIONS	OCIAQDeq Set OCI_ATTR_DEQ_MODE to REMOVE in OCIAQDeqOptions	<AQXmlReceive>	QueueReceiver.receive or QueueReceiver.receive NoWait or AQjmsQueueReceiver. receiveNoData

Table 3-8 (Cont.) Comparison of Oracle Database Advanced Queuing Programmatic Interfaces: Operational Interface—Receive Messages from a Queue/Topic Use Cases

Use Case	PL/SQL	OCI	AQ XML Servlet	JMS
Dequeue a message from a multiconsumer queue/topic using subscription name	DBMS_AQ.dequeue	OCIAQDeq	<AQXmlReceive>	Create a durable TopicSubscriber on the topic using the subscription name, then
	Set dequeue_mode to REMOVE and set consumer_name to subscription name in DEQUEUE_OPTIONS	Set OCI_ATTR_DEQ_MODE to REMOVE and set OCI_ATTR_CONSUMER_NAME to subscription name in OCIAQDeqOptions	Specify <consumer_name> in <consumer_options>	TopicSubscriber.receive or TopicSubscriber.receiveNoWait or AQjmsTopicSubscriber.receiveNoData
Dequeue a message from a multiconsumer queue/topic using recipient name	DBMS_AQ.dequeue	OCIAQDeq	<AQXmlReceive>	Create a TopicReceiver on the topic using the recipient name, then
	Set dequeue_mode to REMOVE and set consumer_name to recipient name in DEQUEUE_OPTIONS	Set OCI_ATTR_DEQ_MODE to REMOVE and set OCI_ATTR_CONSUMER_NAME to recipient name in OCIAQDeqOptions	Specify <consumer_name> in <consumer_options>	AQjmsSession.createTopicReceiver AQjmsTopicReceiver.receive or AQjmsTopicReceiver.receiveNoWait or AQjmsTopicReceiver.receiveNoData

Table 3-9 Comparison of Oracle Database Advanced Queuing Programmatic Interfaces: Operational Interface—Register to Receive Messages Asynchronously from a Queue/Topic Use Cases

Use Case	PL/SQL	OCI	AQ XML Servlet	JMS
Receive messages asynchronously from a single-consumer queue	Define a PL/SQL callback procedure Register it using	OCISubscriptionRegister	<AQXmlRegister>	Create a QueueReceiver on the queue, then
	DBMS_AQ.REGISTER	Specify queue_name as subscription name OCISubscriptionEnable	Specify queue name in <destination> and notification mechanism in <notify_url>	QueueReceiver.setMessageListener

Table 3-9 (Cont.) Comparison of Oracle Database Advanced Queuing Programmatic Interfaces: Operational Interface—Register to Receive Messages Asynchronously from a Queue/Topic Use Cases

Use Case	PL/SQL	OCI	AQ XML Servlet	JMS
Receive messages asynchronously from a multiconsumer queue/topic	Define a PL/SQL callback procedure Register it using <code>DBMS_AQ.REGISTER</code>	<code>OCISubscription</code> <code>Register</code> Specify <code>queue:OCI_ATTR_CONSUMER_NAME</code> as subscription name <code>OCISubscription</code> <code>Enable</code>	<code><AQXmlRegister></code> Specify queue name in <code><destination></code> , consumer in <code><consumer_name></code> and notification mechanism in <code><notify_url></code>	Create a <code>TopicSubscriber</code> or <code>TopicReceiver</code> on the topic, then <code>TopicSubscriber</code> . <code>setMessageListener</code>
Listen for messages on multiple queues/topics	-	-	-	-
Listen for messages on one (many) single-consumer queues	<code>DBMS_AQ.LISTEN</code> Use <code>agent_name</code> as NULL for all agents in <code>agent_list</code>	<code>OCIAQListen</code> Use <code>agent_name</code> as NULL for all agents in <code>agent_list</code>	Not supported	Create multiple <code>QueueReceivers</code> on a <code>QueueSession</code> , then <code>QueueSession.set</code> <code>MessageListener</code>
Listen for messages on one (many) multiconsumer queues/Topics	<code>DBMS_AQ.LISTEN</code> Specify <code>agent_name</code> for all agents in <code>agent_list</code>	<code>OCIAQListen</code> Specify <code>agent_name</code> for all agents in <code>agent_list</code>	Not supported	Create multiple <code>TopicSubscribers</code> or <code>TopicReceivers</code> on a <code>TopicSession</code> , then <code>TopicSession.set</code> <code>MessageListener</code>

4

Managing Oracle Database Advanced Queuing

These topics discuss how to manage Oracle Database Advanced Queuing.

- [Oracle Database Advanced Queuing Compatibility Parameters](#)
- [Queue Security and Access Control](#)
- [Queue Table Export/Import](#)
- [Oracle Enterprise Manager Support](#)
- [Using Oracle Database Advanced Queuing with XA](#)
- [Restrictions on Queue Management](#)
- [Managing Propagation](#)

4.1 Oracle Database Advanced Queuing Compatibility Parameters

The queues in which buffered messages are stored must be created with compatibility set to 8.1 or higher.

The `compatible` parameter of `init.ora` and the `compatible` parameter of the [queue table](#) should be set to 8.1 or higher to use the following features:

- Queue-level access control
- Support for Oracle Real Application Clusters environments
- Rule-based subscribers for [publish/subscribe](#)
- Asynchronous notification
- Sender identification
- Separate storage of history management information
- Secure queues

Mixed case (upper and lower case together) queue names, queue table names, and subscriber names are supported if database compatibility is 10.0, but the names must be enclosed in double quote marks. So `abc.efg` means the schema is `ABC` and the name is `EFG`, but `"abc"."efg"` means the schema is `abc` and the name is `efg`.

See Also:

Oracle Streams Concepts and Administration for more information on secure queues

4.2 Queue Security and Access Control

These topics discuss Oracle Database Advanced Queuing queue security and access control.

- [Oracle Database Advanced Queuing Security](#)
- [Queue Security](#)
- [Queue Privileges and Access Control](#)
- [OCI Applications and Queue Access](#)
- [Security Required for Propagation](#)

4.2.1 Oracle Database Advanced Queuing Security

Configuration information can be managed through procedures in the `DBMS_AQADM` package.

Initially, only `SYS` and `SYSTEM` have execution privilege for the procedures in `DBMS_AQADM` and `DBMS_AQ`. Users who have been granted `EXECUTE` rights to these two packages are able to create, manage, and use queues in their own schemas. The `MANAGE_ANY AQ` system privilege is used to create and manage queues in other schemas.

Users of the [Java Message Service \(JMS\) API](#) need `EXECUTE` privileges on `DBMS_AQJMS` and `DBMS_AQIN`.

Topics:

- [Administrator Role](#)
- [User Role](#)
- [Access to Oracle Database Advanced Queuing Object Types](#)



See Also:

["Granting Oracle Database Advanced Queuing System Privileges"](#) for more information on AQ system privileges

4.2.1.1 Administrator Role

The `AQ_ADMINISTRATOR_ROLE` has all the required privileges to administer queues.

The privileges granted to the role let the grantee:

- Perform any [queue](#) administrative operation, including create queues and queue tables on any [schema](#) in the database
- Perform [enqueue](#) and [dequeue](#) operations on any queues in the database
- Access statistics views used for monitoring the queue workload
- Create transformations using `DBMS_TRANSFORM`
- Run all procedures in `DBMS_AQELM`

- Run all procedures in `DBMS_AQJMS`

4.2.1.2 User Role

You should avoid granting `AQ_USER_ROLE`, because this role does not provide sufficient privileges for enqueueing or dequeueing.

Your database administrator has the option of granting the system privileges `ENQUEUE_ANY` and `DEQUEUE_ANY`, exercising `DBMS_AQADM.GRANT_SYSTEM_PRIVILEGE` and `DBMS_AQADM.REVOKE_SYSTEM_PRIVILEGE` directly to a database user, if you want the user to have this level of control.

You as the application developer give rights to a queue by granting and revoking privileges at the object level by exercising `DBMS_AQADM.GRANT_QUEUE_PRIVILEGE` and `DBMS_AQADM.REVOKE_QUEUE_PRIVILEGE`.

As a database user, you do not need any explicit object-level or system-level privileges to enqueue or dequeue to queues in your own schema other than the `EXECUTE` right on `DBMS_AQ`.

4.2.1.3 Access to Oracle Database Advanced Queuing Object Types

All internal Oracle Database Advanced Queuing objects are accessible to `PUBLIC`.

4.2.2 Queue Security

Oracle Database Advanced Queuing administrators of Oracle Database can create queues. When you create queues, the default value of the `compatible` parameter in `DBMS_AQADM.CREATE_QUEUE_TABLE` is that of the `compatible` parameter.

To enqueue or dequeue, users need `EXECUTE` rights on `DBMS_AQ` and either enqueue or dequeue privileges on target queues, or `ENQUEUE_ANY/DEQUEUE_ANY` system privileges.

4.2.3 Queue Privileges and Access Control

You can grant or revoke privileges at the object level on queues. You can also grant or revoke various system-level privileges.

[Table 4-1](#) lists all common Oracle Database Advanced Queuing operations and the privileges needed to perform these operations.

Table 4-1 Operations and Required Privileges

Operation(s)	Privileges Required
CREATE/DROP/MONITOR own queues	Must be granted <code>EXECUTE</code> rights on <code>DBMS_AQADM</code> . No other privileges needed.
CREATE/DROP/MONITOR any queues	Must be granted <code>EXECUTE</code> rights on <code>DBMS_AQADM</code> and be granted <code>AQ_ADMINISTRATOR_ROLE</code> by another user who has been granted this role (<code>SYS</code> and <code>SYSTEM</code> are the first granters of <code>AQ_ADMINISTRATOR_ROLE</code>)
ENQUEUE/ DEQUEUE to own queues	Must be granted <code>EXECUTE</code> rights on <code>DBMS_AQ</code> . No other privileges needed.

Table 4-1 (Cont.) Operations and Required Privileges

Operation(s)	Privileges Required
ENQUEUE/ DEQUEUE to another's queues	Must be granted EXECUTE rights on DBMS_AQ and be granted privileges by the owner using DBMS_AQADM.GRANT_QUEUE_PRIVILEGE.
ENQUEUE/ DEQUEUE to any queues	Must be granted EXECUTE rights on DBMS_AQ and be granted ENQUEUE ANY QUEUE or DEQUEUE ANY QUEUE system privileges by an Oracle Database Advanced Queuing administrator using DBMS_AQADM.GRANT_SYSTEM_PRIVILEGE.

4.2.4 OCI Applications and Queue Access

For an Oracle Call Interface (OCI) application to access a queue, the session user must be granted either the object privilege of the queue he intends to access or the ENQUEUE ANY QUEUE or DEQUEUE ANY QUEUE system privileges.

The EXECUTE right of DBMS_AQ is not checked against the session user's rights.

4.2.5 Security Required for Propagation

Oracle Database Advanced Queuing propagates messages through database links.

The [propagation](#) driver dequeues from the source queue as owner of the source queue; hence, no explicit access rights need be granted on the source queue. At the destination, the login user in the database link should either be granted ENQUEUE ANY QUEUE privilege or be granted the right to enqueue to the destination queue. However, if the login user in the database link also owns the queue tables at the destination, then no explicit Oracle Database Advanced Queuing privileges must be granted.



See Also:

["Propagation from Object Queues"](#)

4.2.6 Security Required for Non-Sharded Buffered Messages on Oracle RAC

Internally, buffered queues on Oracle RAC may use `dblinks` between instances. Definer's rights packages that enqueue or dequeue into buffered queues on Oracle RAC must grant INHERIT REMOTE PRIVILEGES to users of the package.

4.3 Queue Table Export/Import

When a queue table is exported, the queue table data and anonymous blocks of PL/SQL code are written to the export dump file. When a queue table is imported, the import utility executes these PL/SQL anonymous blocks to write the metadata to the data dictionary.

Oracle AQ does not export registrations with a user export. All applications that make use of client registrations should take this into account as the client may not be present in the imported database.

 **Note:**

You cannot export or import buffered messages.

If there exists a queue table with the same name in the same schema in the database as in the export dump, then ensure that the database queue table is empty before importing a queue table with queues. Failing to do so has a possibility of ruining the metadata for the imported queue.

Topics:

- [Exporting Queue Table Data](#)
- [Importing Queue Table Data](#)
- [Data Pump Export and Import](#)

4.3.1 Exporting Queue Table Data

The export of queues entails the export of the underlying queue tables and related dictionary tables. Export of queues can also be accomplished at queue-table granularity.

Exporting Queue Tables with Multiple Recipients

For non-sharded queues, a queue table that supports multiple recipients is associated with the following tables:

- Dequeue [index-organized table](#) (IOT)
- Time-management index-organized table
- Subscriber table
- A history IOT

Sharded queues are associated with the following objects:

- A queue table
- A dequeue table
- A time management table
- An optional exception queue map table
- Indexes for the above tables
- Sequences
- Rules sets and evaluation contexts

These tables are exported automatically during full database mode, user mode and table mode exports. See [Export Modes](#) .

Because the metadata tables contain ROWIDs of some rows in the queue table, the import process generates a note about the ROWIDs being made obsolete when importing the metadata tables. This message can be ignored, because the queuing system automatically corrects the obsolete ROWIDs as a part of the import operation. However, if another problem is encountered while doing the import (such as running out of rollback segment space), then you should correct the problem and repeat the import.

Export Modes

Exporting operates in full database mode, user mode, and table mode. Incremental exports on queue tables are not supported.

In full database mode, queue tables, all related tables, system-level grants, and primary and secondary object grants are exported automatically.

In user mode, queue tables, all related tables, and primary object grants are exported automatically. However, doing a user-level export from one schema to another using the `FROMUSER TOUSER` clause is not supported.

In table mode, queue tables, all related tables, and primary object grants are exported automatically. For example, when exporting a non-sharded multiconsumer queue table, the following tables are automatically exported:

- `AQ$_queue_table_I` (the dequeue IOT)
- `AQ$_queue_table_T` (the time-management IOT)
- `AQ$_queue_table_S` (the subscriber table)
- `AQ$_queue_table_H` (the history IOT)

For sharded queues, the following tables are automatically exported:

- `queue_table`
- `AQ$_queue_name_I` (dequeue table)
- `AQ$_queue_name_T` (time-management table)
- `AQ$_queue_name` (exception map table)
- `AQ$_queue_name_V` (evaluation context)
- `queue_name_R` (rule set)

4.3.2 Importing Queue Table Data

Similar to exporting queues, importing queues entails importing the underlying queue tables and related dictionary data. After the queue table data is imported, the import utility executes the PL/SQL anonymous blocks in the dump file to write the metadata to the data dictionary.

Importing Queue Tables with Multiple Recipients

A non-sharded queue table that supports multiple recipients is associated with the following tables:

- A dequeue IOT
- A time-management IOT
- A subscriber table

- A history IOT

Sharded queues are associated with the following objects:

- A queue table
- A dequeue log table
- A time management table
- An optional exception queue map table
- Indexes for the above tables
- Sequences
- Rules sets and evaluation contexts

These objects must be imported along with the queue table itself.

Import IGNORE Parameter

You must not import queue data into a queue table that already contains data. The `IGNORE` parameter of the import utility must always be set to `NO` when importing queue tables. If the `IGNORE` parameter is set to `YES`, and the queue table that already exists is compatible with the table definition in the dump file, then the rows are loaded from the dump file into the existing table. At the same time, the old queue table definition is lost and re-created. Queue table definition prior to the import is lost and duplicate rows appear in the queue table.

4.3.3 Data Pump Export and Import

The Data Pump replace and skip modes are supported for queue tables.

In the replace mode an existing queue table is dropped and replaced by the new queue table from the export dump file. In the skip mode, a queue table that already exists is not imported.

The truncate and append modes are not supported for queue tables. The behavior in this case is the same as the replace mode.

See Also:

Oracle Database Utilities for more information on Data Pump Export and Data Pump Import

4.4 Oracle Enterprise Manager Support for Non-Sharded Queues

Oracle Enterprise Manager supports most of the administrative functions of Oracle Database Advanced Queuing. Oracle Database Advanced Queuing functions are found under the Distributed node in the navigation tree of the Enterprise Manager console.

Functions available through Oracle Enterprise Manager include:

- Using queues as part of the schema manager to view properties
- Creating, starting, stopping, and dropping queues
- Scheduling and unscheduling propagation
- Adding and removing subscribers
- Viewing propagation schedules for all queues in the database
- Viewing errors for all queues in the database
- Viewing the message queue
- Granting and revoking privileges
- Creating, modifying, or removing transformations

4.5 Using Oracle Database Advanced Queuing with XA

You must specify "objects=T" in the `xa_open` string if you want to use the Oracle Database Advanced Queuing OCI interface. This forces XA to initialize the client-side cache in Objects mode. You are not required to do this if you plan to use Oracle Database Advanced Queuing through PL/SQL wrappers from OCI or Pro*C.

The [large object](#) (LOB) memory management concepts from the Pro* documentation are not relevant for Oracle Database Advanced Queuing raw messages because Oracle Database Advanced Queuing provides a simple RAW buffer abstraction (although they are stored as LOBs).

When using the Oracle Database Advanced Queuing navigation option, you must reset the dequeue position by using the `FIRST_MESSAGE` option if you want to continue dequeuing between services (such as `xa_start` and `xa_end` boundaries). This is because XA cancels the cursor fetch state after an `xa_end`. If you do not reset, then you get an error message stating that the navigation is used out of sequence (ORA-25237).

See Also:

- "Working with Transaction Monitors with Oracle XA" in *Oracle Database Development Guide* for more information on XA
- "Large Objects (LOBs)" in *Pro*C/C++ Programmer's Guide*

4.6 Restrictions on Queue Management

These topics discuss restrictions on queue management.

- [Subscribers](#)
- [DML Not Supported on Queue Tables or Associated IOTs](#)
- [Propagation from Object Queues with REF Payload Attributes](#)
- [Collection Types in Message Payloads](#)
- [Synonyms on Queue Tables and Queues](#)

- [Synonyms on Object Types](#)
- [Tablespace Point-in-Time Recovery](#)
- [Virtual Private Database](#)

**Note:**

Mixed case (upper and lower case together) queue names, queue table names, and subscriber names are supported if database compatibility is 10.0, but the names must be enclosed in double quote marks. So `abc.efg` means the schema is `ABC` and the name is `EFG`, but `"abc"."efg"` means the schema is `abc` and the name is `efg`.

4.6.1 Subscribers

You cannot have more than 1,000 local subscribers for each queue.

Also, only 32 remote subscribers are allowed for each remote destination database.

4.6.2 DML Not Supported on Queue Tables or Associated IOTs

Oracle Database Advanced Queuing does not support data manipulation language (DML) operations on queue tables or associated index-organized tables (IOTs), if any.

The only supported means of modifying queue tables is through the supplied APIs. Queue tables and IOTs can become inconsistent and therefore effectively ruined, if [data manipulation language](#) (DML) operations are performed on them.

4.6.3 Propagation from Object Queues with REF Payload Attributes

Oracle Database Advanced Queuing does not support propagation from object queues that have REF attributes in the payload.

4.6.4 Collection Types in Message Payloads

You cannot construct a message payload using a VARRAY that is not itself contained within an object.

You also cannot currently use a NESTED Table even as an embedded object within a [message](#) payload. However, you can create an [object type](#) that contains one or more [VARRAYs](#), and create a queue table that is founded on this object type, as shown in [Example 4-1](#).

Example 4-1 Creating Objects Containing VARRAYs

```
CREATE TYPE number_varray AS VARRAY(32) OF NUMBER;
CREATE TYPE embedded_varray AS OBJECT (coll number_varray);
EXECUTE DBMS_AQADM.CREATE_QUEUE_TABLE(
  queue_table      => 'QT',
  queue_payload_type => 'embedded_varray');
```

4.6.5 Synonyms on Queue Tables and Queues

No Oracle Database Advanced Queuing PL/SQL calls resolve synonyms on queues and queue tables.

Although you can create synonyms, you should not apply them to the Oracle Database Advanced Queuing interface.

4.6.6 Synonyms on Object Types

If you have created synonyms on object types, you cannot use them in `DBMS_AQADM.CREATE_QUEUE_TABLE`. Error ORA-24015 results.

4.6.7 Tablespace Point-in-Time Recovery

Oracle Database Advanced Queuing currently does not support tablespace point-in-time recovery.

Creating a queue table in a tablespace disables that particular tablespace for point-in-time recovery. Oracle Database Advanced Queuing does support regular point-in-time recovery.

4.6.8 Virtual Private Database

You can use Oracle Database Advanced Queuing with Virtual Private Database by specifying a security policy with Oracle Database Advanced Queuing queue tables.

While dequeuing, use the dequeue condition (`deq_cond`) or the correlation identifier for the policy to be applied. You can use "1=1" as the dequeue condition. If you do not use a dequeue condition or correlation ID, then the dequeue results in an error.



Note:

When a dequeue condition or correlation identifier is used, the order of the messages dequeued is indeterminate, and the sort order of the queue is not honored.

4.7 Managing Propagation

These topics discuss managing Oracle Database Advanced Queuing propagation.

- [EXECUTE Privileges Required for Propagation](#)
- [Propagation from Object Queues](#)
- [Optimizing Propagation](#)
- [Handling Failures in Propagation](#)

 **Note:**

For propagation to work correctly, the queue `aq$_prop_notify_X` should never be stopped or dropped and the table `aq$_prop_table_X` should never be dropped.

4.7.1 EXECUTE Privileges Required for Propagation

Propagation jobs are owned by `sys`, but the propagation occurs in the security context of the queue table owner.

Previously propagation jobs were owned by the user scheduling propagation, and propagation occurred in the security context of the user setting up the propagation schedule. The queue table owner must be granted `EXECUTE` privileges on the `DBMS_AQADM` package. Otherwise, the Oracle Database snapshot processes do not propagate and generate trace files with the error identifier `SYS.DBMS_AQADM` not defined. Private database links owned by the queue table owner can be used for propagation. The user name specified in the connection string must have `EXECUTE` access on the `DBMS_AQ` and `DBMS_AQADM` packages on the remote database.

4.7.2 Propagation from Object Queues

Propagation from object queues with `BFILE` objects is supported.

To be able to propagate object queues with `BFILE` objects, the source queue owner must have read privileges on the directory object corresponding to the directory in which the `BFILE` is stored. The database link user must have write privileges on the directory object corresponding to the directory of the `BFILE` at the destination database.

AQ propagation does not support non-final types. Propagation of `BFILE` objects from object queues without specifying a database link is not supported.

 **See Also:**

"CREATE DIRECTORY" in *Oracle Database SQL Language Reference* for more information on directory objects

4.7.3 Optimizing Propagation

AQ propagation jobs are run by the Oracle Scheduler. Propagation may be scheduled in these ways.

- A dedicated schedule in which the propagation runs forever or for a specified duration. This mode provides the lowest propagation latencies.
- A periodic schedule in which the propagation runs periodically for a specified interval. This may be used when propagation can be run in a batched mode.
- An event based system in which propagation is started when there are messages to be propagated. This mode makes more efficient use of available resources, while still providing a fast response time.

The administrator may choose a schedule that best meets the application performance requirements.

Oracle Scheduler will start the required number of job queue processes for the propagation schedules. Since the scheduler optimizes for throughput, if the system is heavily loaded, it may not run some propagation jobs. The resource manager may be used to have better control over the scheduling decisions. In particular, associating propagation jobs with different resource groups can allow for fairness in scheduling which may be important in heavy load situations.

In setting the number of `JOB_QUEUE_PROCESSES`, DBAs should be aware that this number is determined by the number of queues from which the messages must be propagated and the number of destinations (rather than queues) to which messages must be propagated.

A scheduling algorithm handles propagation. The algorithm optimizes available job queue processes and minimizes the time it takes for a message to show up at a destination after it has been enqueued into the source queue, thereby providing near-OLTP action. The algorithm can handle an unlimited number of schedules and various types of failures. While propagation tries to make the optimal use of the available job queue processes, the number of job queue processes to be started also depends on the existence of jobs unrelated to propagation, such as replication jobs. Hence, it is important to use the following guidelines to get the best results from the scheduling algorithm.

The scheduling algorithm uses the job queue processes as follows (for this discussion, an active schedule is one that has a valid current window):

- If the number of active schedules is fewer than half the number of job queue processes, then the number of job queue processes acquired corresponds to the number of active schedules.
- If the number of active schedules is more than half the number of job queue processes, after acquiring half the number of job queue processes, then multiple active schedules are assigned to an acquired job queue process.
- If the system is overloaded (all schedules are busy propagating), depending on availability, then additional job queue processes are acquired up to one fewer than the total number of job queue processes.
- If none of the active schedules handled by a process has messages to be propagated, then that job queue process is released.
- The algorithm performs automatic load balancing by transferring schedules from a heavily loaded process to a lightly load process such that no process is excessively loaded.

4.7.4 Handling Failures in Propagation

The scheduling algorithm has robust support for handling failures. These are the common failures that prevent message propagation.

- Database link failed
- Remote database is not available
- Remote queue does not exist
- Remote queue was not started
- Security violation while trying to enqueue messages into remote queue

Under all these circumstances the appropriate error messages are reported in the `DBA_QUEUE_SCHEDULES` view.

When an error occurs in a schedule, propagation of messages in that schedule is attempted again after a retry period that is a function of the number of failures. After the retries have exceeded a system defined maximum, the schedule is disabled.

If the problem causing the error is fixed and the schedule is enabled, then the error fields that indicate the last error date, time, and message continue to show the error information. These fields are reset only when messages are successfully propagated in that schedule.



See Also:

[Troubleshooting Oracle Database Advanced Queuing](#)

5

Oracle Database Advanced Queuing Performance and Scalability

These topics discuss performance and scalability issues relating to Oracle Database Advanced Queuing (AQ).

- [Sharded Queues](#)
- [Non-Sharded Queues](#)
- [Performance Views](#)

5.1 Sharded Queues

A [sharded queue](#) increases enqueue-dequeue throughput, especially across Oracle RAC instances, because messages from different enqueue sessions are allowed to be dequeued in parallel. Each shard of the queue is ordered based on enqueue time within a session and ordering across shards is best-effort. Sharded queues automatically manage table partitions so that enqueueers and dequeuers do not contend among themselves. In addition, sharded queues use an in-memory message cache to optimize performance and reduce the disk and CPU overhead of enqueues and dequeues.

The advantages and tradeoffs of sharded queues include the following:

- Sharded queues provide scalability of a single queue on Oracle Real Application Clusters (Oracle RAC), especially in the case where each subscriber has multiple dequeuers on each instance.
- Sharded queues trades off increased memory usage to obtain performance.

This section contains the following topics:

- [Sharded Queues and the Message Cache](#)
- [Sharded Queues and Enqueuing / Dequeuing Messages](#)
- [Sharded Queues and Native JMS Support](#)
- [Sharded Queues and Partitioning](#)
- [Sharded Queues and Oracle Real Application Clusters \(Oracle RAC\)](#)
- [Sharded Queue Restrictions](#)
- [Sharded Queues Tuning](#)

5.1.1 Sharded Queues and the Message Cache

Sharded queues introduce a special purpose message cache which lets you trade off SGA usage for increased throughput, reduced latency, and increased concurrency. When combined with partitioning, the message cache reduces the need for some queries, DML operations, and indexes. The message cache is most effective when all dequeuers keep up with enqueueers and when the message cache is big enough to

store messages (including payloads) for each sharded queue's enqueueers and dequeuers. The message cache uses the Streams pool. If sharded queues share the Streams pool on the same instance as Streams replication functionality, you can use DBMS_AQADM procedures such as `SET_MIN_STREAMS_POOL` and `SET_MAX_STREAMS_POOL` to fine tune the allocation of Streams Pool memory.



See Also:

Oracle Database PL/SQL Packages and Types Reference for information

5.1.2 Sharded Queues and Enqueuing / Dequeuing Messages

To improve throughput and reduce overhead and latency, enqueuees and dequeues are optimized to use the message cache, the rules engine, and background processing when possible. For example,

- sharded queues take advantage of new rules engine improvements
- a message that has its payload in the message cache does not have to be re-read from disk during a dequeue
- dequeue by correlation id or other JMS properties can often be evaluated without accessing the disk
- partition operations on sharded queues implements efficient bulk processing.

5.1.3 Sharded Queues and Native JMS Support

Sharded queues have native support for:

- Non-Durable Subscribers
- JMS payloads
- Priorities

Sharded queues support both persistent and nonpersistent messages. Nonpersistent messages are stored in memory inside the message cache and are not stored on disk. As a result, nonpersistent messages are lost upon instance crash or shutdown.

Sharded queues natively support two kinds of subscribers to meet the JMS requirements:

- Non-durable subscribers: These subscribers receive messages on their chosen topic, only if the messages are published while the subscriber is active. This subscription is not sharable among different sessions.
- Durable subscribers: These subscribers receive all the messages published on a topic, including those that are published while the subscriber is inactive. Multiple database sessions can share the same subscription.

Sharded queues do not use ADTs to store the JMS payload. The JMS message is stored in scalar columns of the database. JMS message types such as `TEXT`, `BYTES`, `MAP`, `STREAM` and `OBJECT` store the JMS payload in scalar `TEXT/RAW` or `CLOB/BLOB` columns in the queue table depending on payload size and type. The JMS message properties are stored in a `CLOB` (SecureFile) column in the queue table with attribute access functions defined for the user defined properties. The payload and user properties are

pickled into RAW, VARCHAR2 or Secure File columns instead of being stored as an ADT. JMS Header properties and JMS provider information are stored in their own scalar columns.

Sharded queues support integer priority values ranging between 0 (lowest priority) and 9 (highest priority), with the default being priority 4, as defined by the JMS standard.

5.1.4 Sharded Queues and Partitioning

Sharded queues automatically manage the underlying partitioned tables used for the queue table. Such partition management may occur in the foreground or the background. Each shard provides session-level ordering of enqueued messages. Each enqueueing session is assigned a shard. Each shard is composed of a series of subshards. Each subshard maps to a single partition. Messages are automatically assigned to a table partition upon enqueue.

New partitions are automatically created as needed, as when the queue table needs to grow when dequeuers do not keep up with enqueueers. Partitions are truncated and reused when all messages in the partition are dequeued and no longer needed. The message cache automatically loads messages from partitions into memory as required by dequeuers. Global indexes should not be created on the partitioned table underlying a sharded queue. Local indexes are not typically recommended on the partitioned table either. If such indexes are desired and result in performance degradation, then non-sharded queues should be considered.

5.1.5 Sharded Queues and Oracle Real Application Clusters (Oracle RAC)

Sharded queues automatically provides enqueue session ordering while avoiding cross-instance communication when possible. Sometimes cross instance communication is required. For example, if a sharded queue has a single enqueueing session on one Oracle RAC instance and a single dequeuing session on another instance, then sharded queues will forward messages between the Oracle RAC instances. The forwarding of messages is non-atomic to the enqueueing transaction to improve performance. Dequeuers may get an ORA-25228 if they are connected to an instance that has no messages in its shards.

In most cases, consider having multiple dequeuers for each subscriber or single consumer queue on each Oracle RAC instance to improve throughput and reduce cross-instance overhead. An exception to this guideline is when you are using dequeue selectors that specify a single message. If you want to dequeue a message from a sharded queue by its message identifier in an Oracle RAC database, then you have to connect to the instance that is assigned dequeue ownership for the shard containing the message. Otherwise, the message will not be available for dequeue to the dequeue session. If all dequeues are performed at a single instance, then messages will be automatically forwarded to this instance. Hence, for a sharded single-consumer queue that extensively dequeues by message ID, consider having all dequeue sessions for the sharded queue connect to a single instance. Similarly, for a sharded multiconsumer queue that extensively dequeues by message ID, consider having all dequeue sessions for each subscriber connect to a single instance. Services can be used to simplify connecting dequeue sessions to a particular instance.

5.1.6 Sharded Queue Restrictions

The following Oracle Database features are not currently supported for sharded queues:

- Message retention
- Transaction grouping
- Anonymous posting for subscriber notification and OCI callback notification are not supported. PL/SQL callback notification is supported.
- Messaging Gateway
- Oracle extensions for JMS such as JMS propagation and remote subscribers
- Multiple queues per queue table. Sharded queues are created via the `CREATE_SHARDED_QUEUE` interface.
- Ordering other than message priority followed by enqueue time (as specified in the JMS standard)
- The JDBC thick (OCI) driver.
- Propagation between sharded and non-sharded queues
- Message transformations

5.1.7 Sharded Queues Tuning

Sharded queues perform best under the following conditions:

- Dequeuers for each subscriber are located on each instance
- Subscribers keep up with the enqueueers. Consider having multiple dequeuers for each subscriber on each Oracle RAC instance

The message cache is most effective when dequeuers keep up with enqueueers and where the cache is big enough to store messages (including payloads) for each sharded queue's enqueueers and dequeuers. When using sharded queues, Oracle requires that you do one of the following:

- Setting parameter `STREAMS_POOL_SIZE`

This parameter controls the size of shared memory available to the Oracle Database for the sharded queue message cache. If unspecified, up to 10% of the shared pool size may be allocated for the Streams pool.

Oracle's Automatic Shared Memory Management feature manages the size of the Streams pool when the `SGA_TARGET` initialization parameter is set to a nonzero value. If the `STREAMS_POOL_SIZE` initialization parameter also is set to a nonzero value, then Automatic Shared Memory Management uses this value as a minimum for the Streams pool.

If the `STREAMS_POOL_SIZE` initialization parameter is set to a nonzero value, and the `SGA_TARGET` parameter is set to 0 (zero), then the Streams pool size is the value specified by the `STREAMS_POOL_SIZE` parameter, in bytes.

If both the `STREAMS_POOL_SIZE` and the `SGA_TARGET` initialization parameters are set to 0 (zero), then, by default, the first use of the Streams pool in a database transfers an amount of memory equal to 10% of the shared pool from the buffer cache to the Streams pool.

 **See Also:**

- `DBMS_AQADM.set_min_streams_pool()` and `DBMS_AQADM.set_max_streams_pool()` in *Oracle Database PL/SQL Packages and Types Reference* for a finer grained control over `STREAMS_POOL` sharing with Streams processing.

- Turning on SGA autotuning

Oracle will automatically allocate the appropriate amount of memory from the SGA for the Streams pool, based on Streams pool usage as well as usage of other components that use the SGA. Examples of such other components are buffer cache and library cache. If `STREAMS_POOL_SIZE` is specified, it is used as the lower bound.

- Manually tuning sharded queues

Sharded queues can be tuned by allocating `STREAMS_POOL` memory for the message cache. The view `GV$AQ_MESSAGE_CACHE_ADVICE` provides advice on how much `STREAMS_POOL` should be allocated for sharded queues based on a snapshot of the current messaging load. During periods of high load, select the columns `INST_ID`, `SIZE_FOR_ESTIMATE`, and `ESTD_SIZE_TYPE`. `ESTD_SIZE_TYPE` is one of three values: `MINIMUM`, `PREFERRED`, or `MAXIMUM`. Find the maximum value of `SIZE_FOR_ESTIMATE` across Oracle RAC instances for each of the `ESTD_SIZE_TYPE` values. It is highly recommended that `STREAMS_POOL` be set at least to the `MINIMUM` recommendation to provide any message cache performance gains. There is little additional performance gains to setting `STREAMS_POOL` greater than the `MAXIMUM` recommendation value. Setting `STREAMS_POOL` to the `PREFERRED` recommendation tries to provide a reasonable space-performance tradeoff. If the `MAXIMUM` size recommendation is much greater than the `PREFERRED` recommendation, then check that the sharded queue has no orphaned subscribers, or whether more dequeuers should be added to the instance, so that dequeuers can keep up with the enqueue load. `STREAMS_POOL` tuning should be done over multiple periods of high load and whenever messaging load characteristics change.

5.2 Non-Sharded Queues

This section includes the following topics:

- [Persistent Messaging Performance Overview for Non-Sharded Queues](#)
- [Persistent Messaging Basic Tuning Tips](#)
- [Propagation Tuning Tips](#)
- [Buffered Messaging Tuning](#)

5.2.1 Persistent Messaging Basic Tuning Tips

Oracle Database Advanced Queuing table layout is similar to a layout with ordinary database tables and indexes.

**See Also:**

Oracle Database Performance Tuning Guide for tuning recommendations

5.2.1.1 Memory Requirements

Streams pool size should be at least 20 MB for optimal multi-consumer dequeue performance in a non-Oracle RAC database.

Persistent queuing dequeue operations use the streams pool to optimize performance, especially under concurrency situations. This is, however, not a requirement and the code automatically switches to a less optimal code path.

Sharded queues introduces a message cache for optimal performance of high throughput messaging systems. Ideally the Streams pool size should be large enough to cache the expected backlog of messages in sharded queues.

5.2.1.2 Using Storage Parameters

Storage parameters can be specified when creating a queue table using the `storage_clause` parameter.

Storage parameters are inherited by other IOTs and tables created with the queue table. The tablespace of the queue table should have sufficient space to accommodate data from all the objects associated with the queue table. With retention specified, the history table and, also the queue table can grow to be quite big.

Oracle recommends you use automatic segment-space management (ASSM). Otherwise `initrans`, freelists and freelist groups must be tuned for AQ performance under high concurrency.

Increasing `PCTFREE` will reduce the number of messages in a queue table/IOT block. This will reduce block level contention when there is concurrency.

Storage parameters specified at queue table creation are shared by the queue table, IOTs and indexes. These may be individually altered by an online redefinition using `DBMS_REDEFINITION`.

5.2.1.3 I/O Configuration

Because Oracle Database Advanced Queuing is very I/O intensive, you will usually need to tune I/O to remove any bottlenecks.

**See Also:**

"I/O Configuration and Design" in *Oracle Database Performance Tuning Guide*

5.2.1.4 Running Enqueue and Dequeue Processes Concurrently in a Single Non-Sharded Queue Table

Some environments must process messages in a constant flow, requiring that enqueue and dequeue processes run concurrently. If the message delivery system has only one queue table and one queue, then all processes must work on the same segment area at the same time. This precludes reasonable performance levels when delivering a high number of messages.

The best number for concurrent processes depends on available system resources. For example, on a four-CPU system, it is reasonable to start with two concurrent enqueue and two concurrent dequeue processes. If the system cannot deliver the wanted number of [messages](#), then use several subscribers for load balancing rather than increasing the number of processes.

Tune the enqueue and dequeue rates on the queue so that in the common case the queue size remains small and bounded. A queue that grows and shrinks considerably will have indexes and IOTs that are out of balance, which will affect performance.

With multi-consumer queues, using several subscribers for load balancing rather than increasing the number of processes will reduce contention. Multiple queue tables may be used garnering horizontal scalability.

For information about tuning sharded queues refer to [Sharded Queues Tuning](#).

5.2.1.5 Running Enqueue and Dequeue Processes Serially in a Single Non-Sharded Queue Table

When enqueue and dequeue processes are running serially, contention on the same data segment is lower than in the case of concurrent processes. The total time taken to deliver messages by the system, however, is longer than when they run concurrently.

Increasing the number of processes helps both enqueueing and dequeueing. The message throughput rate may be higher for enqueueers than for dequeueers when the number of processes is increased, especially with single consumer queues. Dequeue processes on multi-consumer queues scale much better.

5.2.1.6 Creating Indexes on a Queue Table

Creating an index on a non-sharded queue table is useful if you meet these conditions.

- Dequeue using correlation ID

An index created on the column `corr_id` of the underlying queue table `AQ$_QueueTableName` expedites dequeues.

- Dequeue using a condition

This is like adding the condition to the where-clause for the `SELECT` on the underlying queue table. An index on `QueueTableName` expedites performance on this `SELECT` statement.

5.2.1.7 Other Tips for Non-Sharded Queues

These are some other persistent messaging basic tuning tips.

- Ensure that statistics are being gathered so that the optimal query plans for retrieving messages are being chosen. By default, queue tables are locked out from automatic gathering of statistics. The recommended use is to gather statistics with a representative queue message load and lock them.
- The queue table indexes and IOTs are automatically coalesced by AQ background processes. However, they must continue to be monitored and coalesced if needed. With automatic space segment management (ASSM), an online shrink operation may be used for the same purpose. A well balanced index reduces queue monitor CPU consumption, and ensures optimal enqueue-dequeue performance.
- Ensure that there are enough queue monitor processes running to perform the background tasks. The queue monitor must also be running for other crucial background activity. Multiple `qmn` processes share the load; make sure that there are enough of them. These are auto-tuned, but can be forced to a minimum number, if needed.
- It is recommended that dequeue with a wait time is only used with dedicated server processes. In a shared server environment, the shared server process is dedicated to the dequeue operation for the duration of the call, including the wait time. The presence of many such processes can cause severe performance and scalability problems and can result in deadlocking the shared server processes.
- Long running dequeue transactions worsen dequeue contention on the queue, and must be avoided.
- Batching multiple dequeue operations on multi-consumer queues into a single transaction gives best throughput.
- Use `NEXT` as navigation mode, if not using message priorities. This offers the same semantics but improved performance.
- Use the `REMOVE_NODATA` dequeue mode if dequeuing in `BROWSE` mode followed by a `REMOVE`.

5.2.2 Propagation Tuning Tips

Propagation can be considered a special kind of dequeue operation with an additional `INSERT` at the remote (or local) queue table. Propagation from a single schedule is not parallelized across multiple job queue processes. Rather, they are load balanced. Propagation can be considered a special kind of dequeue operation with an additional `INSERT` at the remote (or local) queue table. Propagation from a single schedule is not parallelized across multiple job queue processes. Rather, they are load balanced.

For better scalability, configure the number of [propagation](#) schedules according to the available system resources (CPUs).

Propagation rates from [transactional](#) and [nontransactional](#) (default) queue tables vary to some extent because Oracle Database Advanced Queuing determines the batching size for nontransactional queues, whereas for transactional queues, batch size is mainly determined by the user application.

Optimized propagation happens in batches. If the remote queue is in a different database, then Oracle Database Advanced Queuing uses a sequencing algorithm to avoid the need for a two-phase commit. When a message must be sent to multiple queues in the same destination, it is sent multiple times. If the message must be sent to multiple consumers in the same queue at the destination, then it is sent only once.

5.2.3 Buffered Messaging Tuning

Buffered messaging operations in a Oracle Real Application Clusters environment will be fastest on the `OWNER_INSTANCE` of the queue.

5.2.3.1 Persistent Messaging Performance Overview for Non-Sharded Queues

When persistent messages are enqueued, they are stored in database tables. The performance characteristics of queue operations on persistent messages are similar to underlying database operations.

The code path of an `enqueue` operation is comparable to `SELECT` and `INSERT` into a multicolumn `queue table` with three index-organized tables. The code path of a `dequeue` operation is comparable to a `SELECT` operation on the multi-column table and a `DELETE` operation on the dequeue index-organized table. In many scenarios, for example when Oracle RAC is not used and there is adequate streams pool memory, the dequeue operation is optimized and is comparable to a `SELECT` operation on a multi-column table.

 **Note:**

Performance is not affected by the number of `queues` in a table.

5.2.3.2 Non-Sharded Queues and Oracle Real Application Clusters

Oracle Real Application Clusters (Oracle RAC) can be used to ensure highly available access to queue data.

The entry and exit points of a queue, commonly called its tail and head respectively, can be extreme hot spots. Because Oracle RAC may not scale well in the presence of hot spots, limit usual access to a queue from one instance only. If an instance failure occurs, then messages managed by the failed instance can be processed immediately by one of the surviving instances. If non-sharded queues are experiencing hot spots, then consider using sharded queues instead.

You can associate Oracle RAC instance affinities with 8.1-compatible queue tables. If you are using `q1` and `q2` in different instances, then you can use `ALTER_QUEUE_TABLE` or `CREATE_QUEUE_TABLE` on the queue table and set `primary_instance` to the appropriate `instance_id`.

 **See Also:**

- [Creating a Queue Table](#)
- [Altering a Queue Table](#)
- [Sharded Queues and Oracle Real Application Clusters \(Oracle RAC\)](#)

5.2.3.3 Oracle Database Advanced Queuing in a Shared Server Environment

Queue operation scalability is similar to the underlying database operation scalability.

If a dequeue operation with wait option is applied, then it does not return until it is successful or the wait period has expired. In a shared server environment, the shared server process is dedicated to the dequeue operation for the duration of the call, including the wait time. The presence of many such processes can cause severe performance and scalability problems and can result in deadlocking the shared server processes. For this reason, Oracle recommends that dequeue requests with wait option be applied using dedicated server processes. This restriction is not enforced.

 **See Also:**

"DEQUEUE_OPTIONS_T Type" in *Oracle Database PL/SQL Packages and Types Reference* for more information on the wait option

5.3 Performance Views

Oracle provides these views to monitor system performance and troubleshooting.

- [V\\$AQ_MESSAGE_CACHE_STAT](#): Memory Management for Sharded Queues
- [V\\$AQ_SHARDED_SUBSCRIBER_STAT](#): Sharded Queue Subscriber Statistics
- [V\\$AQ_MESSAGE_CACHE_ADVICE](#): Simulated Metrics
- [V\\$AQ_REMOTE_DEQUEUE_AFFINITY](#): Dequeue Affinity Instance List
- [V\\$PERSISTENT_QUEUES](#): All Active Persistent Queues in the Instance
- [V\\$PERSISTENT_SUBSCRIBERS](#): All Active Subscribers of the Persistent Queues in the Instance
- [V\\$PERSISTENT_PUBLISHERS](#): All Active Publishers of the Persistent Queues in the Instance
- [V\\$BUFFERED_QUEUES](#): All Buffered Queues in the Instance.
- [V\\$BUFFERED_SUBSCRIBERS](#): Subscribers for All Buffered Queues in the Instance
- [V\\$BUFFERED_PUBLISHERS](#): All Buffered Publishers in the Instance
- [V\\$PERSISTENT_QMN_CACHE](#): Performance Statistics on Background Tasks for Persistent Queues
- [V\\$AQ](#): Number of Messages in Different States in Database

- V\$AQ_BACKGROUND_COORDINATOR: Performance Statistics for AQ's Master Background Coordinator Process (AQPC)
- V\$AQ_JOB_COORDINATOR: Performance Statistics per Coordinator
- V\$AQ_NONDUR_REGISTRATIONS: Non-Durable Registrations
- V\$AQ_SERVER_POOL: Performance Statistics for all Servers
- V\$AQ_CROSS_INSTANCE_JOBS: Cross Process Jobs Description
- V\$AQ_NONDUR_REGISTRATIONS: Non-Durable Registrations
- V\$AQ_NOTIFICATION_CLIENTS: Secure OCI Client Connections
- V\$AQ_SUBSCRIBER_LOAD: Durable Subscribers
- V\$AQ_NONDUR_SUBSCRIBER: Non-Durable Subscribers
- V\$AQ_NONDUR_SUBSCRIBER_LWM: LWM of Non Durable Subscriber
- V\$AQ_MESSAGE_CACHE: Performance Statistics

These views are integrated with the Automatic Workload Repository (AWR). Users can generate a report based on two AWR snapshots to compute enqueue rate, dequeue rate, and other statistics per queue/subscriber.

6

Internet Access to Oracle Database Advanced Queuing

You can access Oracle Database Advanced Queuing (AQ) over the Internet by using SOAP with non-sharded queues. IDAP is the SOAP specification for Oracle Database Advanced Queuing operations.

IDAP defines XML [message](#) structure for the body of the [Simple Object Access Protocol](#) (SOAP) request. An [Internet Data Access Presentation](#) (IDAP)-structured message is transmitted over the Internet using HTTP.

Users can register for notifications using the IDAP interface.

Topics:

- [Overview of Oracle Database Advanced Queuing Operations Over the Internet](#)
- [Deploying the Oracle Database Advanced Queuing XML Servlet](#)
- [Internet Data Access Presentation \(IDAP\)](#)
- [Request and Response IDAP Documents](#)
- [Notification of Messages by E-Mail](#)

6.1 Overview of Oracle Database Advanced Queuing Operations Over the Internet

The section discusses these topics.

- [Oracle Database Advanced Queuing Internet Operations Architecture](#)
- [Internet Message Payloads](#)
- [Configuring the Web Server to Authenticate Users Sending POST Requests](#)
- [Client Requests Using HTTP](#)
- [Oracle Database Advanced Queuing Servlet Responses Using HTTP](#)
- [Oracle Database Advanced Queuing Propagation Using HTTP and HTTPS](#)

6.1.1 Oracle Database Advanced Queuing Internet Operations Architecture

The figure shows the architecture for performing Oracle Database Advanced Queuing operations over HTTP.

The major components are:

- Oracle Database Advanced Queuing client program
- Web server/servlet runner hosting the Oracle Database Advanced Queuing [servlet](#)

- Oracle Database server

A Web browser or any other HTTP client can serve as an Oracle Database Advanced Queuing client program, sending XML messages conforming to IDAP to the Oracle Database Advanced Queuing servlet, which interprets the incoming XML messages. The Oracle Database Advanced Queuing servlet connects to the Oracle Database server and performs operations on user queues.

Figure 6-1 Architecture for Performing Oracle Database Advanced Queuing Operations Using HTTP

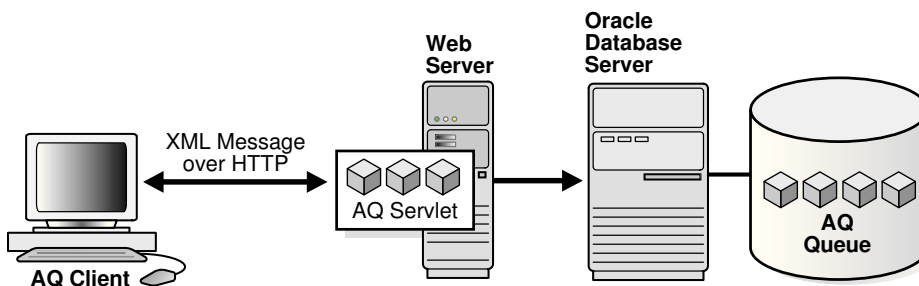

6.1.2 Internet Message Payloads

Oracle Database Advanced Queuing supports messages of three types: RAW, Oracle object, and JMS. All these message types can be accessed using SOAP and Web services.

If the queue holds messages in RAW, Oracle object, or [Java Message Service \(JMS\)](#) format, then XML payloads are transformed to the appropriate internal format during enqueue and stored in the queue. During dequeue, when messages are obtained from queues containing messages in any of the preceding formats, they are converted to XML before being sent to the client.

The message payload type depends on the queue type on which the operation is being performed:

RAW Queues

The contents of RAW queues are raw bytes. You must supply the hex representation of the message payload in the XML message. For example, `<raw>023f4523</raw>`.

Oracle Object Type Queues

For Oracle [object type](#) queues that are not JMS queues (that is, they are not type `AQ$_JMS_*`), the type of the payload depends on the type specified while creating the queue table that holds the queue. The content of the XML elements must map to the attributes of the object type of the queue table.

JMS Type Queues/Topics

For queues with JMS types (that is, those with payloads of type `AQ$_JMS_*`), there are four XML elements, depending on the JMS type. IDAP supports queues or topics with the following JMS types:

- TextMessage

- MapMessage
- BytesMessage
- ObjectMessage

JMS queues with payload type `StreamMessage` are not supported through IDAP.

6.1.3 Configuring the Web Server to Authenticate Users Sending POST Requests

After the servlet is installed, the Web server must be configured to authenticate all users that send `POST` requests to the Oracle Database Advanced Queuing servlet. The Oracle Database Advanced Queuing servlet allows only authenticated users to access the servlet. If the user is not authenticated, then an error is returned by the servlet.

The Web server can be configured in multiple ways to restrict access. Some of the common techniques are basic authentication (user name/password) over SSL and client certificates. Consult your Web server documentation to see how you can restrict access to servlets.

In the context of the Oracle Database Advanced Queuing servlet, the user name that is used to connect to the Web server is known as the Oracle Database Advanced Queuing HTTP agent or Oracle Database Advanced Queuing Internet user.

6.1.4 Client Requests Using HTTP

An Oracle Database Advanced Queuing client begins a request to the Oracle Database Advanced Queuing servlet using HTTP by opening a connection to the server. The client logs in to the server using HTTP basic authentication (with or without SSL) or SSL certificate-based client authentication. The client constructs an XML message representing the send, publish, receive or register request.

The client sends an HTTP `POST` to the servlet at the remote server.



See Also:

["Request and Response IDAP Documents"](#)

User Sessions and Transactions

After a client is authenticated and connects to the Oracle Database Advanced Queuing servlet, an HTTP session is created on behalf of the user. The first request in the session also implicitly starts a new database transaction. This transaction remains open until it is explicitly committed or terminated. The responses from the servlet includes the session ID in the HTTP headers as cookies.

If the client wishes to continue work in the same transaction, then it must include this HTTP header containing the session ID cookie in subsequent requests. This is automatically accomplished by most Web browsers. However, if the client is using a Java or C client to post requests, then this must be accomplished programmatically.

An explicit commit or rollback must be applied to end the transaction. The commit or rollback requests can also be included as part of other Oracle Database Advanced Queuing operations.

6.1.5 Oracle Database Advanced Queuing Servlet Responses Using HTTP

The server accepts the client HTTP(S) connection and authenticates the user (Oracle Database Advanced Queuing agent) specified by the client. The server receives the `POST` request and invokes the Oracle Database Advanced Queuing servlet.

If this is the first request from this client, then a new HTTP session is created. The XML message is parsed and its contents are validated. If a session ID is passed by the client in the HTTP headers, then this operation is performed in the context of that session.

The servlet determines which object (queue/topic) the agent is trying to perform operations on. The servlet looks through the list of database users that map to this Oracle Database Advanced Queuing agent. If any one of these users has privileges to access the queue/topic specified in the request, then the Oracle Database Advanced Queuing servlet superuser creates a session on behalf of this user.

If no transaction is active in the HTTP session, then a new database transaction is started. Subsequent requests in the session are part of the same transaction until an explicit `COMMIT` or `ROLLBACK` request is made. The effects of the transaction are visible only after it is committed. If the transaction remains inactive for 120 seconds, then it is automatically terminated.

The requested operation is performed. The response is formatted as an XML message and sent back the client. The response also includes the session ID in the HTTP headers as a cookie.



See Also:

["User Sessions and Transactions"](#)

6.1.6 Oracle Database Advanced Queuing Propagation Using HTTP and HTTPS

You can propagate over HTTP and HTTPS (HTTP over SSL) instead of Oracle Net Services. HTTP, unlike Oracle Net Services, is easy to configure for firewalls. The background process doing propagation pushes messages to an Oracle Database Advanced Queuing servlet that enqueues them into the destination database, as shown in the figure.

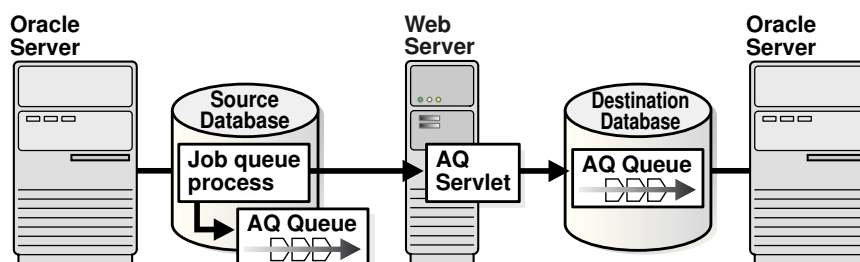
Figure 6-2 HTTP Oracle Database Advanced Queuing Propagation

You can set up any application to use Oracle Database Advanced Queuing HTTP propagation without any change to the existing code. An application using Oracle Database Advanced Queuing HTTP propagation can easily switch back to Net Services propagation just by re-creating the database link with a Net Services connection string, without any other changes.

6.2 Deploying the Oracle Database Advanced Queuing XML Servlet

The AQ servlet can be deployed with any Web server, for example, Tomcat. Follow these steps to deploy the AQ XML servlet using Tomcat:

1. For JDK1.8.x, include the following in your CLASSPATH:

```
ORACLE_HOME/jdbc/lib/ojdbc8.jar
ORACLE_HOME/jlib/jndi.jar
ORACLE_HOME/jlib/jta.jar
ORACLE_HOME/jlib/orai18n.jar
ORACLE_HOME/jlib/orai18n-collation.jar
ORACLE_HOME/jlib/orai18n-mapping.jar
ORACLE_HOME/jlib/orai18n-utility.jar
ORACLE_HOME/lib/http_client.jar
ORACLE_HOME/lib/lclasses12.zip
ORACLE_HOME/lib/servlet.jar
ORACLE_HOME/lib/xmlparserv2.jar
ORACLE_HOME/lib/xschem.jar
ORACLE_HOME/lib/xsul2.jar
ORACLE_HOME/rdbms/jlib/aqapi.jar
ORACLE_HOME/rdbms/jlib/aqxml.jar
ORACLE_HOME/rdbms/jlib/jmscommon.jar
ORACLE_HOME/rdbms/jlib/xdb.jar
```

2. Copy the following jar files into the tomcat/lib directory:

```
ORACLE_HOME/jdbc/lib/ojdbc8.jar
ORACLE_HOME/jlib/jndi.jar
ORACLE_HOME/jlib/jta.jar
ORACLE_HOME/lib/http_client.jar
ORACLE_HOME/lib/lclasses12.zip
ORACLE_HOME/lib/servlet.jar
ORACLE_HOME/lib/xmlparserv2.jar
ORACLE_HOME/lib/xschem.jar
ORACLE_HOME/lib/xsul2.jar
ORACLE_HOME/rdbms/jlib/aqapi.jar
ORACLE_HOME/rdbms/jlib/aqxml.jar
```

```
ORACLE_HOME/rdbms/jlib/jmscommon.jar
ORACLE_HOME/rdbms/jlib/xdm.jar
```

3. Create or update `tomcat-users.xml` file appropriately for Web applications users accessing queues. For example:

```
User          Password
-----
john          welcome
```

4. Set up queues in database and create AQ agents so that Tomcat users created in step 3 get authenticated before it can access AQ queues. DBA needs to make use of `DBMS_AQADM.CREATE_AQ_AGENT` and `DBMS_AQADM.ENABLE_DB_ACCESS` procedures. For example, if we assume `JOHN` is the user created in Tomcat and `AQXMLUSER` is the AQ agent created on the database, then in order to access AQ servlet using HTTP, run the following queries:

```
EXECUTE dbms_aqadm.create_aq_agent(agent_name=>'JOHN', enable_http =>true);
EXECUTE dbms_aqadm.enable_db_access('JOHN', 'AQXMLUSER');
```

Here `AQXMLUSER` is the AQ user that is created in the database.

DBA can check internet AQ users agents details using the following query :

```
SELECT agent_name, db_username, http_enabled FROM aq$internet_users ;
```

5. Deploy the AQ XML servlet, which extends `oracle.AQ.xml.AQxmlServlet` class.
6. Start or stop the Tomcat instance as follows:
 - a. Start the Tomcat instance using `sh tomcat/bin/startup.sh`
 - b. Shutdown the Tomcat instance using `sh tomcat/bin/shutdown.sh`
 - c. For logs in Tomcat check `tomcat/logs/catalina.out` file

Related Topics:

- Fusion Middleware Configuring and Managing JMS for Oracle WebLogic Server

6.3 Internet Data Access Presentation (IDAP)

Internet Data Access Presentation (IDAP) uses the Content-Type of `text/xml` to specify the body of the SOAP request.

XML provides the presentation for IDAP request and response messages as follows:

- All request and response tags are scoped in the SOAP namespace.
- Oracle Database Advanced Queuing operations are scoped in the IDAP namespace.
- The sender includes namespaces in IDAP elements and attributes in the SOAP body.
- The receiver processes SOAP messages that have correct namespaces and returns an invalid request error for requests with incorrect namespaces.
- The SOAP namespace has the value `http://schemas.xmlsoap.org/soap/envelope/`
- The IDAP namespace has the value `http://ns.oracle.com/AQ/schemas/access`

6.3.1 SOAP Message Structure

These topics show how SOAP structures a message request or response.

- [SOAP Envelope](#)
- [SOAP Header](#)
- [SOAP Body](#)

6.3.1.1 SOAP Envelope

This is the root or top element in an XML tree. Its tag is `SOAP:Envelope`. SOAP defines a global attribute `SOAP:encodingStyle` that indicates serialization rules used instead of those described by the SOAP specification.

This attribute can appear on any element and is scoped to that element and all child elements not themselves containing such an attribute. Omitting this attribute means that type specification has been followed unless overridden by a parent element.

The SOAP envelope also contains namespace declarations and additional attributes, provided they are namespace-qualified. Additional namespace-qualified subelements can follow the body.

6.3.1.2 SOAP Header

This is the first element under the root. Its tag is `SOAP:Header`. A SOAP header passes necessary information, such as the transaction identifier.

The header is encoded as a child of the `SOAP:Envelope` XML element. Headers are identified by the name element and are namespace-qualified. A header entry is encoded as an embedded element.

6.3.1.3 SOAP Body

This is the Oracle Database Advanced Queuing XML document. Its tag is `SOAP:Body`, and it contains a first subelement whose name is the method name.

This method request element contains elements for each input and output parameter. The element names are the parameter names. The body also contains `SOAP:Fault`, indicating information about an error. The Oracle Database Advanced Queuing XML document has the namespace `http://ns.oracle.com/AQ/schemas/access`

6.3.2 SOAP Method Invocation

A method invocation is performed by creating the request header and body and processing the returned response header and body. The request and response headers can consist of standard transport protocol-specific and extended headers.

6.3.2.1 HTTP Headers

The `POST` method within the HTTP request header performs the SOAP method invocation. The request should include the header `SOAPMethodName`, whose value indicates the method to be invoked on the target. The value is of the form `URI#methodName`.

For example:

```
SOAPMethodName: http://ns.oracle.com/AQ/schemas/access#AQxmlSend
```

The URI used for the interface must match the implied or specified namespace qualification of the method name element in the `SOAP:Body` part of the payload. The method name must not include the "#" character.

6.3.2.2 Method Invocation Body

SOAP method invocation consists of a method request and optionally a method response. The SOAP method request and method response are an HTTP request and response, respectively, whose contents are XML documents consisting of the root and mandatory body elements.

These XML documents are referred to as SOAP payloads in the rest of the sections.

A SOAP payload is defined as follows:

- The SOAP root element is the top element in the XML tree.
- The SOAP payload headers contain additional information that must travel with the request.
- The method request is represented as an XML element with additional elements for parameters. It is the first child of the `SOAP:Body` element. This request can be one of the Oracle Database Advanced Queuing XML client requests described in the next section.
- The response is the return value or an error or exception that is passed back to the client.

At the receiving site, a request can have one of the following outcomes:

- The HTTP infrastructure on the receiving site can receive and process the request. In this case, the HTTP infrastructure passes the headers and body to the SOAP infrastructure.
- The HTTP infrastructure on the receiving site cannot receive and process the request. In this case, the result is an HTTP response containing an HTTP error in the status field and no XML body.
- The SOAP infrastructure on the receiving site can decode the input parameters, dispatch to an appropriate server indicated by the server address, and invoke an application-level function corresponding semantically to the method indicated in the method request. In this case, the result of the method request consists of a response or error.
- The SOAP infrastructure on the receiving site cannot decode the input parameters, dispatch to an appropriate server indicated by the server address, and invoke an application-level function corresponding semantically to the interface or method indicated in the method request. In this case, the result of the method is an error that prevented the dispatching infrastructure on the receiving side from successful completion.

In the last two cases, additional message headers can be present in the results of the request for extensibility.

6.3.2.3 Results from a Method Request

The results of the request are to be provided in the form of a request response. The HTTP response must be of Content-Type `text/xml`.

A SOAP result indicates success and an error indicates failure. The method response never contains both a result and an error.

6.4 Request and Response IDAP Documents

The body of a SOAP message is an IDAP message. This XML document has the namespace `http://ns.oracle.com/AQ/schemas/access`.

The body represents:

- Client requests for [enqueue](#), [dequeue](#), and registration
- Server responses to client requests for enqueue, dequeue, and registration
- Notifications from the server to the client

**Note:**

Oracle Database Advanced Queuing Internet access is supported only for 8.1 or higher style queues.

Sharded queues do not support internet access through SOAP.

This section contains these topics:

- [IDAP Client Requests for Enqueue](#)
- [IDAP Client Requests for Dequeue](#)
- [IDAP Client Requests for Registration](#)
- [IDAP Client Requests to Commit a Transaction](#)
- [IDAP Client Requests to Roll Back a Transaction](#)
- [IDAP Server Response to an Enqueue Request](#)
- [IDAP Server Response to a Dequeue Request](#)
- [IDAP Server Response to a Register Request](#)
- [IDAP Commit Response](#)
- [IDAP Rollback Response](#)
- [IDAP Notification](#)
- [IDAP Response in Case of Error](#)

6.4.1 IDAP Client Requests for Enqueue

Client send and publish requests use `AQXmlSend` to enqueue to a single-consumer queue and `AQXmlPublish` to enqueue to multiconsumer queues/topics.

AQXmlSend and AQXmlPublish contain the following elements:

- [producer_options](#)
- [message_set](#)
- [message_header](#)
- [message_payload](#)
- [AQXmlCommit](#)

producer_options

This is a required element. It contains the following child elements:

- [destination](#)

This element is required. It specifies the [queue](#)/topic to which messages are to be sent. It has an optional `lookup_type` attribute, which determines how the destination value is interpreted. If `lookup_type` is `DATABASE`, which is the default, then the destination is interpreted as `schema.queue_name`. If `lookup_type` is `LDAP`, then the LDAP server is used to resolve the destination.
- [visibility](#)

This element is optional. It determines when an enqueue becomes visible. The default is `ON_COMMIT`, which makes the enqueue visible when the current transaction commits. If `IMMEDIATE` is specified, then the effects of the enqueue are visible immediately after the request is completed. The enqueue is not part of the current transaction. The operation constitutes a transaction on its own.
- [transformation](#)

This element is optional. It specifies the PL/SQL [transformation](#) to be invoked before the message is enqueued.

message_set

This is a required element and contains one or more messages. Each message consists of a [message_header](#) and a [message_payload](#).

message_header

This element is optional. It contains the following child elements:

- [sender_id](#)

If a `message_header` element is included, then it must contain a `sender_id` element, which specifies an application-specific identifier. The `sender_id` element can contain `agent_name`, `address`, `protocol`, and `agent_alias` elements. The `agent_alias` element resolves to a name, address, and protocol using LDAP.
- [message_id](#)

This element is optional. It is a unique identifier of the message, supplied during dequeue.
- [correlation](#)

This element is optional. It is the correlation identifier of the message.
- [delay](#)

This element is optional. It specifies the duration in seconds after which a message is available for processing.

- `expiration`

This element is optional. It specifies the duration in seconds that a message is available for dequeuing. This parameter is an offset from the delay. By default messages never expire. If a message is not dequeued before it expires, then it is moved to an [exception queue](#) in the `EXPIRED` state.

- `priority`

This element is optional. It specifies the priority of the message. The priority can be any number, including negative numbers. A smaller number indicates higher priority.

- `recipient_list`

This element is optional. It is a list of recipients which overrides the default subscriber list. Each recipient is represented in `recipient_list` by a `recipient` element, which can contain `agent_name`, `address`, `protocol`, and `agent_alias` elements. The `agent_alias` element resolves to a name, address, and protocol using LDAP.

- `message_state`

This element is optional. It specifies the state of the message. It is filled in automatically during dequeue. If `message_state` is 0, then the message is ready to be processed. If it is 1, then the message delay has not yet been reached. If it is 2, then the message has been processed and is retained. If it is 3, then the message has been moved to an exception queue.

- `exception_queue`

This element is optional. It specifies the name of the queue to which the message is moved if the number of unsuccessful dequeue attempts has exceeded `max_retries` or the message has expired. All messages in the exception queue are in the `EXPIRED` state.

If the exception queue specified does not exist at the time of the move, then the message is moved to the default exception queue associated with the queue table, and a warning is logged in the alert log. If the default exception queue is used, then the parameter returns a `NULL` value at dequeue time.

message_payload

This is a required element. It can contain different elements based on the payload type of the destination queue/topic. The different payload types are described in "[IDAP Client Requests for Dequeue](#)".

AQXmlCommit

This is an optional empty element. If it is included, then the transaction is committed at the end of the request.

 **See Also:**

"[Internet Message Payloads](#)" for an explanation of IDAP message payloads

6.4.2 IDAP Client Requests for Dequeue

Client requests for dequeue use `AQXmlReceive`, which contains these elements.

- [consumer_options](#)
- [AQXmlCommit](#)

consumer_options

This is a required element. It contains the following child elements:

- `destination`

This element is required. It specifies the queue/topic from which messages are to be received. The `destination` element has an optional `lookup_type` attribute, which determines how the destination value is interpreted. If `lookup_type` is `DATABASE`, which is the default, then the destination is interpreted as `schema.queue_name`. If `lookup_type` is `LDAP`, then the LDAP server is used to resolve the destination.
- `consumer_name`

This element is optional. It specifies the name of the [consumer](#). Only those messages matching the consumer name are accessed. If a queue is not set up for multiple consumers, then this field should not be specified.
- `wait_time`

This element is optional. It specifies the number of seconds to wait if there is no message currently available which matches the search criteria.
- `selector`

This element is optional. It specifies criteria used to select the message. It can contain child elements `correlation`, `message_id`, or `condition`.

A dequeue `condition` element is a Boolean expression using syntax similar to the `WHERE` clause of a SQL query. This Boolean expression can include conditions on message properties, user object payload data properties, and PL/SQL or SQL functions. Message properties include `priority`, `corrid` and other columns in the queue table.

To specify dequeue conditions on a message payload, use attributes of the [object type](#) in clauses. You must prefix each attribute with `tab.user_data` as a qualifier to indicate the specific column of the queue table that stores the payload.

A dequeue `condition` element cannot exceed 4000 characters.

 **Note:**

When a dequeue condition or correlation identifier is used, the order of the messages dequeued is indeterminate, and the sort order of the queue is not honored.

- `visibility`

This element is optional. It determines when a dequeue becomes visible. The default is `ON_COMMIT`, which makes the dequeue visible when the current transaction commits. If `IMMEDIATE` is specified, then the effects of the dequeue are visible

immediately after the request is completed. The dequeue is not part of the current transaction. The operation constitutes a transaction on its own.

- `dequeue_mode`

This element is optional. It specifies the locking action associated with the dequeue. The possible values are `REMOVE`, `BROWSE`, and `LOCKED`.

`REMOVE` is the default and causes the message to be read and deleted. The message can be retained in the queue table based on the retention properties. `BROWSE` reads the message without acquiring any lock on it. This is equivalent to a `select` statement. `LOCKED` reads the message and obtains a write lock on it. The lock lasts for the duration of the transaction. This is equivalent to a `select for update` statement.

- `navigation_mode`

This element is optional. It specifies the position of the message that is retrieved. First, the position is determined. Second, the search criterion is applied. Finally, the message is retrieved. Possible values are `FIRST_MESSAGE`, `NEXT_MESSAGE`, and `NEXT_TRANSACTION`.

`FIRST_MESSAGE` retrieves the first message which is available and which matches the search criteria. This resets the position to the beginning of the queue. `NEXT_MESSAGE` is the default and retrieves the next message which is available and which matches the search criteria. If the previous message belongs to a message group, then Oracle Database Advanced Queuing retrieves the next available message which matches the search criteria and which belongs to the message group. `NEXT_TRANSACTION` skips the remainder of the current transaction group and retrieves the first message of the next transaction group. This option can only be used if message grouping is enabled for the current queue.

- `transformation`

This element is optional. It specifies the PL/SQL [transformation](#) to be invoked after the message is dequeued.

AQXmlCommit

This is an optional empty element. If it is included, then the transaction is committed at the end of the request.

6.4.3 IDAP Client Requests for Registration

Client requests for registration use `AQXmlRegister`, which must contain a `register_options` element. The `register_options` element contains these child elements.

- `destination`

This element is required. It specifies the queue/topic on which notifications are registered. The `destination` element has an optional `lookup_type` attribute, which determines how the destination value is interpreted. If `lookup_type` is `DATABASE`, which is the default, then the destination is interpreted as `schema.queue_name`. If `lookup_type` is `LDAP`, then the LDAP server is used to resolve the destination.

- `consumer_name`

This element is optional. It specifies the consumer name for multiconsumer queues or topics. This parameter must not be specified for single-consumer queues.

- `notify_url`
This element is required. It specifies where notification is sent when a message is enqueued. The form can be `http://url`, `mailto://email address` or `plsqr://pl/sql procedure`.

6.4.4 IDAP Client Requests to Commit a Transaction

A request to commit all actions performed by the user in a session uses `AQXmlCommit`.

A commit request has the following format:

```
<?xml version="1.0"?>
<Envelope xmlns="http://schemas.xmlsoap.org/soap/envelope/">
  <Body>
    <AQXmlCommit xmlns="http://ns.oracle.com/AQ/schemas/access"/>
  </Body>
</Envelope>
```

6.4.5 IDAP Client Requests to Roll Back a Transaction

A request to roll back all actions performed by the user in a session uses `AQXmlRollback`. Actions performed with `IMMEDIATE` visibility are not rolled back.

An IDAP client rollback request has the following format:

```
<?xml version="1.0"?>
<Envelope xmlns="http://schemas.xmlsoap.org/soap/envelope/">
  <Body>
    <AQXmlRollback xmlns="http://ns.oracle.com/AQ/schemas/access"/>
  </Body>
</Envelope>
```

6.4.6 IDAP Server Response to an Enqueue Request

The response to an enqueue request to a single-consumer queue uses `AQXmlSendResponse`.

It contains the following elements:

- `status_response`
This element contains child elements `status_code`, `error_code`, and `error_message`. The `status_code` element takes value 0 for success or -1 for failure. The `error_code` element contains an Oracle error code. The `error_message` element contains a description of the error.
- `send_result`
This element contains child elements `destination` and `message_id`. The `destination` element specifies where the message was sent. The `message_id` element uniquely identifies every message sent.

The response to an enqueue request to a multiconsumer queue or topic uses `AQXmlPublishResponse`. It contains the following elements:

- `status_response`
This element contains child elements `status_code`, `error_code`, and `error_message`. The `status_code` element takes value 0 for success or -1 for failure. The `error_code`

element contains an Oracle error code. The `error_message` element contains a description of the error.

- `publish_result`

This element contains child elements `destination` and `message_id`. The `destination` element specifies where the message was sent. The `message_id` element uniquely identifies every message sent.

6.4.7 IDAP Server Response to a Dequeue Request

The response to a dequeue request uses `AQXmlReceiveResponse`.

It contains the following elements:

- `status_response`

This element contains child elements `status_code`, `error_code`, and `error_message`. The `status_code` element takes value 0 for success or -1 for failure. The `error_code` element contains an Oracle error code. The `error_message` element contains a description of the error.

- `receive_result`

This element contains child elements `destination` and `message_set`. The `destination` element specifies where the message was sent. The `message_set` element specifies the set of messages dequeued.

6.4.8 IDAP Server Response to a Register Request

The response to a register request uses `AQXmlRegisterResponse`.

It contains the `status_response` element described in ["IDAP Server Response to a Dequeue Request"](#).

6.4.9 IDAP Commit Response

The response to a commit request uses `AQXmlCommitResponse`.

It contains the `status_response` element described in ["IDAP Server Response to a Dequeue Request"](#). The response to a commit request has the following format:

```
<?xml version = '1.0'?>
<Envelope xmlns="http://schemas.xmlsoap.org/soap/envelope/">
  <Body>
    <AQXmlCommitResponse xmlns="http://ns.oracle.com/AQ/schemas/access">
      <status_response>
        <status_code>0</status_code>
      </status_response>
    </AQXmlCommitResponse>
  </Body>
</Envelope>
```

6.4.10 IDAP Rollback Response

The response to a rollback request uses `AQXmlRollbackResponse`.

It contains the `status_response` element described in ["IDAP Server Response to a Dequeue Request"](#).

6.4.11 IDAP Notification

When an event for which a client has registered occurs, a notification is sent to the client at the URL specified in the REGISTER request using AQXmlNotification.

It contains the following elements:

- `notification_options`
This element has child elements `destination` and `consumer_name`. The `destination` element specifies the destination queue/topic on which the event occurred. The `consumer_name` element specifies the consumer name for which the event occurred. It applies only to multiconsumer queues/topics.
- `message_set`
This element specifies the set of message properties.

6.4.12 IDAP Response in Case of Error

In case of an error in any of the preceding requests, a FAULT is generated.

The FAULT element contains the following elements:

- `faultcode`
This element specifies the error code for the fault.
- `faultstring`
This element indicates a client error or a server error. A client error means that the request is not valid. A server error indicates that the Oracle Database Advanced Queuing servlet has not been set up correctly.
- `detail`
This element contains the `status_response` element, which is described in "[IDAP Server Response to a Dequeue Request](#)".

6.5 Notification of Messages by E-Mail

These are the steps for setting up your database for e-mail notifications.

1. Set the SMTP mail host by invoking `DBMS_AQELM.SET_MAILHOST` as an Oracle Database Advanced Queuing administrator.
2. Set the SMTP mail port by invoking `DBMS_AQELM.SET_MAILPORT` as an Oracle Database Advanced Queuing administrator. If not explicit, set defaults to 25.
3. Set the SendFrom address by invoking `DBMS_AQELM.SET_SENDFROM`.
4. After setup, you can register for e-mail notifications using the Oracle Call Interface (OCI) or PL/SQL API.

7

Troubleshooting Oracle Database Advanced Queuing

These topics describe how to troubleshoot Oracle Database Advanced Queuing (AQ).

- [Debugging Oracle Database Advanced Queuing Propagation Problems](#)
- [Oracle Database Advanced Queuing Error Messages](#)

7.1 Debugging Oracle Database Advanced Queuing Propagation Problems

These tips should help with debugging propagation problems. This discussion assumes that you have created queue tables and queues in source and target databases and defined a database link for the destination database.

The notation assumes that you supply the actual name of the entity (without the brackets).



See Also:

["Optimizing Propagation"](#)

To begin debugging, do the following:

1. Check that the propagation schedule has been created and that a job queue process has been assigned.

Look for the entry in the `DBA_QUEUE_SCHEDULES` view and make sure that the status of the schedule is enabled. `SCHEDULE_DISABLED` must be set to 'N'. Check that it has a nonzero entry for `JOBNO` in table `AQ$_SCHEDULES`, and that there is an entry in table `JOB$` with that `JOBNO`.

To check if propagation is occurring, monitor the `DBA_QUEUE_SCHEDULES` view for the number of messages propagated (`TOTAL_NUMBER`).

If propagation is not occurring, check the view for any errors. Also check the `NEXT_RUN_DATE` and `NEXT_RUN_TIME` in `DBA_QUEUE_SCHEDULES` to see if propagation is scheduled for a later time, perhaps due to errors or the way it is set up.

2. Check if the database link to the destination database has been set up properly. Make sure that the queue owner can use the database link. You can do this with:

```
select count(*) from table_name@dblink_name;
```

3. Make sure that at least two job queue processes are running.
4. Check for messages in the source [queue](#) with:

```
select count (*) from AQ$<source_queue_table>
  where q_name = 'source_queue_name';
```

5. Check for messages in the destination queue with:

```
select count (*) from AQ$<destination_queue_table>
  where q_name = 'destination_queue_name';
```

6. Check to see who is using job queue processes.

Check which jobs are being run by querying `dba_jobs_running`. It is possible that other jobs are starving the propagation jobs.

7. Check to see that the queue table `sys.aq$_prop_table_instno` exists in `DBA_QUEUE_TABLES`. The queue `sys.aq$_prop_notify_queue_instno` must also exist in `DBA_QUEUES` and must be enabled for enqueue and dequeue.

In case of Oracle Real Application Clusters (Oracle RAC), this queue table and queue pair must exist for each Oracle RAC node in the system. They are used for communication between job queue processes and are automatically created.

8. Check that the [consumer](#) attempting to [dequeue a message](#) from the destination queue is a recipient of the propagated messages.

For 8.1-style queues, you can do the following:

```
select consumer_name, deq_txn_id, deq_time, deq_user_id,
  propagated_msgid from aq$<destination_queue_table>
  where queue = 'queue_name';
```

For 8.0-style queues, you can obtain the same information from the history column of the [queue table](#):

```
select h.consumer, h.transaction_id, h.deq_time, h.deq_user,
  h.propagated_msgid from aq$<destination_queue_table> t, table(t.history) h
  where t.q_name = 'queue_name';
```

Note:

Queues created in a queue table with `compatible` set to 8.0 (referred to in this guide as 8.0-style queues) are deprecated in Oracle Database Advanced Queuing 10g Release 2 (10.2). Oracle recommends that any new queues you create be 8.1-style or newer and that you migrate existing 8.0-style queues at your earliest convenience.

9. Turn on [propagation](#) tracing at the highest level using event 24040, level 10.

Debugging information is logged to job queue trace files as propagation takes place. You can check the trace file for errors and for statements indicating that messages have been sent.

7.2 Oracle Database Advanced Queuing Error Messages

The Oracle Database Advanced Queuing Error Messages are listed here.

ORA-1555

You might get this error when using the `NEXT_MESSAGE` navigation option for dequeue. `NEXT_MESSAGE` uses the snapshot created during the first dequeue call. After that, undo information may not be retained.

The workaround is to use the `FIRST_MESSAGE` option to dequeue the message. This reexecutes the cursor and gets a new snapshot. `FIRST_MESSAGE` does not perform as well as `NEXT_MESSAGE`, so Oracle recommends that you dequeue messages in batches: `FIRST_MESSAGE` for one, `NEXT_MESSAGE` for the next 1000 messages, then `FIRST_MESSAGE` again, and so on.

ORA-24033

This error is raised if a message is enqueued to a multiconsumer queue with no recipient and the queue has no subscribers (or rule-based subscribers that match this message). This is a warning that the message will be discarded because there are no recipients or subscribers to whom it can be delivered.

ORA-25237

When using the Oracle Database Advanced Queuing navigation option, you must reset the dequeue position by using the `FIRST_MESSAGE` option if you want to continue dequeuing between services (such as `xa_start` and `xa_end` boundaries). This is because XA cancels the cursor fetch state after an `xa_end`. If you do not reset, then you get an error message stating that the navigation is used out of sequence.

ORA-25307

Flow control has been enabled for the message sender. This means that the fastest subscriber of the sender's message is not able to keep pace with the rate at which messages are enqueued. The buffered messaging application must handle this error and attempt again to enqueue messages after waiting for some time.

8

Oracle Database Advanced Queuing Administrative Interface

These topics describe the Oracle Database Advanced Queuing (AQ) administrative interface.

- [Managing Non-Sharded Queue Tables](#)
- [Managing Non-Sharded Queues](#)
- [Managing Sharded Queues](#)
- [Managing Transformations](#)
- [Granting and Revoking Privileges](#)
- [Managing Subscribers](#)
- [Managing Propagations](#)
- [Managing Oracle Database Advanced Queuing Agents](#)
- [Adding an Alias to the LDAP Server](#)
- [Deleting an Alias from the LDAP Server](#)

See Also:

- [Oracle Database Advanced Queuing: Programmatic Interfaces](#) for a list of available functions in each programmatic interface
- [Oracle Database PL/SQL Packages and Types Reference](#) for information on the DBMS_AQADM Package

8.1 Managing Non-Sharded Queue Tables

These topics describe how to manage non-sharded queue tables.

- [Creating a Queue Table](#)
- [Altering a Queue Table](#)
- [Dropping a Queue Table](#)
- [Purging a Queue Table](#)
- [Migrating a Queue Table](#)

8.1.1 Creating a Queue Table

DBMS_AQADM.CREATE_QUEUE_TABLE creates a non-sharded queue table for messages of a predefined type.

```
DBMS_AQADM.CREATE_QUEUE_TABLE(
  queue_table          IN      VARCHAR2,
  queue_payload_type   IN      VARCHAR2,
  storage_clause       IN      VARCHAR2          DEFAULT NULL,
  sort_list            IN      VARCHAR2          DEFAULT NULL,
  multiple_consumers   IN      BOOLEAN           DEFAULT FALSE,
  message_grouping     IN      BINARY_INTEGER   DEFAULT NONE,
  comment              IN      VARCHAR2          DEFAULT NULL,
  auto_commit          IN      BOOLEAN           DEFAULT TRUE,
  primary_instance     IN      BINARY_INTEGER   DEFAULT 0,
  secondary_instance   IN      BINARY_INTEGER   DEFAULT 0,
  compatible           IN      VARCHAR2          DEFAULT NULL,
  secure               IN      BOOLEAN           DEFAULT FALSE,
  replication_mode     IN      BINARY_INTEGER   DEFAULT NONE);
```

It has the following required and optional parameters:

Parameter	Description
queue_table	This required parameter specifies the queue table name. Mixed case (upper and lower case together) queue table names are supported if database compatibility is 10.0, but the names must be enclosed in double quote marks. So <code>abc.efg</code> means the schema is <code>ABC</code> and the name is <code>EFG</code> , but <code>"abc"."efg"</code> means the schema is <code>abc</code> and the name is <code>efg</code> . Starting from 12c Release 2 (12.2.), the maximum length of AQ queue table names is 122 bytes. If you attempt to create a queue table with a longer name, error ORA-24019 results.
queue_payload_type	This required parameter specifies the payload type as RAW or an object type. See " Payload Type " for more information.
storage_clause	This optional parameter specifies a tablespace for the queue table. See " Storage Clause " for more information.
sort_list	This optional parameter specifies one or two columns to be used as sort keys in ascending order. It has the format <code>sort_column1,sort_column2</code> . See " Sort Key " for more information.
multiple_consumers	This optional parameter specifies the queue table as single-consumer or multiconsumer. The default <code>FALSE</code> means queues created in the table can have only one consumer for each message. <code>TRUE</code> means queues created in the table can have multiple consumers for each message.

Parameter	Description
message_grouping	This optional parameter specifies whether messages are grouped or not. The default <code>NONE</code> means each message is treated individually. <code>TRANSACTIONAL</code> means all messages enqueued in one transaction are considered part of the same group and can be dequeued as a group of related messages.
comment	This optional parameter is a user-specified description of the queue table. This user comment is added to the queue catalog.
auto_commit	<code>TRUE</code> causes the current transaction, if any, to commit before the <code>CREATE_QUEUE_TABLE</code> operation is carried out. The <code>CREATE_QUEUE_TABLE</code> operation becomes persistent when the call returns. This is the default. <code>FALSE</code> means the operation is part of the current transaction and becomes persistent only when the caller enters a commit. Note: This parameter has been deprecated.
primary_instance	This optional parameter specifies the primary owner of the queue table. Queue monitor scheduling and propagation for the queues in the queue table are done in this instance. The default value <code>0</code> means queue monitor scheduling and propagation is done in any available instance. You can specify and modify this parameter only if <code>compatible</code> is 8.1 or higher.
secondary_instance	This optional parameter specifies the owner of the queue table if the primary instance is not available. The default value <code>0</code> means that the queue table will fail over to any available instance. You can specify and modify this parameter only if <code>primary_instance</code> is also specified and <code>compatible</code> is 8.1 or higher.
compatible	This optional parameter specifies the lowest database version with which the queue table is compatible. The possible values are 8.0, 8.1, and 10.0. If the database is in 10.1-compatible mode, then the default value is 10.0. If the database is in 8.1-compatible or 9.2-compatible mode, then the default value is 8.1. If the database is in 8.0-compatible mode, then the default value is 8.0. The 8.0 value is deprecated in Oracle Database Advanced Queuing 10g Release 2 (10.2). For more information on compatibility, see "Oracle Database Advanced Queuing Compatibility Parameters" .

Parameter	Description
secure	This optional parameter must be set to <code>TRUE</code> if you want to use the queue table for secure queues. Secure queues are queues for which AQ agents must be associated explicitly with one or more database users who can perform queue operations, such as enqueue and dequeue. The owner of a secure queue can perform all queue operations on the queue, but other users cannot unless they are configured as secure queue users
replication_mode	Reserved for future use. DBMS_AQADM.REPLICATION_MODE if queue is being created in the Replication Mode or else DBMS_AQADM.NONE. Default is DBMS_AQADM.NONE.

Payload Type

To specify the payload type as an object type, you must define the object type.

Note:

If you have created synonyms on object types, then you cannot use them in `DBMS_AQADM.CREATE_QUEUE_TABLE`. Error `ORA-24015` results.

`CLOB`, `BLOB`, and `BFILE` objects are valid in an Oracle Database Advanced Queuing message. You can propagate these object types using Oracle Database Advanced Queuing propagation with Oracle software since Oracle8i release 8.1.x. To enqueue an object type that has a `LOB`, you must first set the `LOB_attribute` to `EMPTY_BLOB()` and perform the enqueue. You can then select the `LOB` locator that was generated from the queue table's view and use the standard `LOB` operations.

Note:

Payloads containing `LOBs` require users to grant explicit `Select`, `Insert` and `Update` privileges on the queue table for doing enqueues and dequeues.

Storage Clause

The `storage_clause` argument can take any text that can be used in a standard `CREATE TABLE storage_clause` argument.

Once you pick the tablespace, any index-organized table (IOT) or index created for that queue table goes to the specified tablespace. You do not currently have a choice to split them between different tablespaces.

 **Note:**

The qmon processes in the 11g Release 2 (11.2) perform auto-coalesce of the the dequeue IOT, history IOT, and the time manager IOT. It is not required to manually coalesce AQ IOTs. However, it can be performed as a workaround if a performance degradation is observed.

If you choose to create the queue table in a locally managed tablespace or with freelist groups > 1, then Queue Monitor Coordinator will skip the cleanup of those blocks. This can cause a decline in performance over time.

Coalesce the dequeue IOT by running

```
ALTER TABLE AQ$queue_table_I COALESCE;
```

You can run this command while there are concurrent dequeuers and enqueueers of the queue, but these concurrent users might see a slight decline in performance while the command is running.

Sort Key

The `sort_list` parameter determines the order in which messages are dequeued. You cannot change the message sort order after you have created the queue table. Your choices are:

- `ENQ_TIME`
- `ENQ_TIME,PRIORITY`
- `PRIORITY`
- `PRIORITY,ENQ_TIME`
- `PRIORITY,COMMIT_TIME`
- `COMMIT_TIME`

If `COMMIT_TIME` is specified, then any queue that uses the queue table is a [commit-time queue](#), and Oracle Database Advanced Queuing computes an [approximate CSCN](#) for each enqueued message when its transaction commits.

If you specify `COMMIT_TIME` as the sort key, then you must also specify the following:

- `multiple_consumers = TRUE`
- `message_grouping = TRANSACTIONAL`
- `compatible = 8.1 or higher`

Commit-time ordering is useful when transactions are interdependent or when browsing the messages in a queue must yield consistent results.

Other Tables and Views

The following objects are created at table creation time:

- `AQ$queue_table_name`, a read-only view which is used by Oracle Database Advanced Queuing applications for querying [queue](#) data
- `AQ$queue_table_name_E`, the default [exception queue](#) associated with the queue table

- `AQ$_queue_table_name_I`, an index or an [index-organized table](#) (IOT) in the case of multiple [consumer](#) queues for dequeue operations
- `AQ$_queue_table_name_T`, an index for the queue monitor operations
- `AQ$_queue_table_name_L`, dequeue log table, used for storing message identifiers of committed dequeue operations on the queue

The following objects are created only for 8.1-compatible multiconsumer queue tables:

- `AQ$_queue_table_name_S`, a table for storing information about subscribers
- `AQ$_queue_table_name_H`, an index organized table (IOT) for storing dequeue history data

 **Note:**

Oracle Database Advanced Queuing does not support the use of triggers on these internal AQ queue tables.

If you do not specify a schema, then you default to the user's schema.

If `GLOBAL_TOPIC_ENABLED = TRUE` when a queue table is created, then a corresponding [Lightweight Directory Access Protocol](#) (LDAP) entry is also created.

If the queue type is `ANYDATA`, then a [buffered queue](#) and two additional objects are created. The buffered queue stores logical change records created by a capture process. The logical change records are staged in a memory buffer associated with the queue; they are not ordinarily written to disk.

If they have been staged in the buffer for a period of time without being dequeued, or if there is not enough space in memory to hold all of the captured events, then they are spilled to:

- `AQ$_queue_table_name_P`, a table for storing the captured events that spill from memory
- `AQ$_queue_table_name_D`, a table for storing information about the propagations and apply processes that are eligible for processing each event

 **See Also:**

- ["Dequeue Modes"](#)
- ["Commit-Time Queues"](#) in *Oracle Streams Concepts and Administration*
- *Oracle Database SecureFiles and Large Objects Developer's Guide*
- Chapter 3, "Streams Staging and Propagation" in *Oracle Streams Concepts and Administration*

Examples

The following examples assume you are in a SQL*Plus testing environment. In [Example 8-1](#), you create users in preparation for the other examples in this chapter.

For this example, you must connect as a user with administrative privileges. For most of the other examples in this chapter, you can connect as user `test_adm`. A few examples must be run as `test` with `EXECUTE` privileges on `DBMS_AQADM`.

Example 8-1 Setting Up AQ Administrative Users

```
CREATE USER test_adm IDENTIFIED BY test_adm DEFAULT TABLESPACE example;
GRANT DBA, CREATE ANY TYPE TO test_adm;
GRANT EXECUTE ON DBMS_AQADM TO test_adm;
GRANT aq_administrator_role TO test_adm;
BEGIN
    DBMS_AQADM.GRANT_SYSTEM_PRIVILEGE(
        privilege      => 'MANAGE_ANY',
        grantee        => 'test_adm',
        admin_option   => FALSE);
END;
/
CREATE USER test IDENTIFIED BY test;
GRANT EXECUTE ON dbms_aq TO test;
```

Example 8-2 Setting Up AQ Administrative Example Types

```
CREATE TYPE test.message_typ AS object(
    sender_id          NUMBER,
    subject            VARCHAR2(30),
    text              VARCHAR2(1000));
/
CREATE TYPE test.msg_table AS TABLE OF test.message_typ;
/
CREATE TYPE test.order_typ AS object(
    custno            NUMBER,
    item             VARCHAR2(30),
    description       VARCHAR2(1000));
/
CREATE TYPE test.lob_typ AS object(
    id               NUMBER,
    subject          VARCHAR2(100),
    data            BLOB,
    trailer         NUMBER);
/
```

Example 8-3 Creating a Queue Table for Messages of Object Type

```
BEGIN
    DBMS_AQADM.CREATE_QUEUE_TABLE(
        queue_table      => 'test.obj_qtab',
        queue_payload_type => 'test.message_typ');
END;
/
```

Example 8-4 Creating a Queue Table for Messages of RAW Type

```
BEGIN
    DBMS_AQADM.CREATE_QUEUE_TABLE(
        queue_table      => 'test.raw_qtab',
        queue_payload_type => 'RAW');
END;
/
```

Example 8-5 Creating a Queue Table for Messages of LOB Type

```
BEGIN
  DBMS_AQADM.CREATE_QUEUE_TABLE(
    queue_table      => 'test.lob_qtab',
    queue_payload_type => 'test.lob_typ');
END;
/
```

Example 8-6 Creating a Queue Table for Messages of XMLType

```
BEGIN
  DBMS_AQADM.CREATE_QUEUE_TABLE(
    queue_table      => 'test.xml_qtab',
    queue_payload_type => 'SYS.XMLType',
    multiple_consumers => TRUE,
    compatible      => '8.1',
    comment          => 'Overseas Shipping multiconsumer orders queue table');
END;
/
```

Example 8-7 Creating a Queue Table for Grouped Messages

```
BEGIN
  DBMS_AQADM.CREATE_QUEUE_TABLE(
    queue_table      => 'test.group_qtab',
    queue_payload_type => 'test.message_typ',
    message_grouping => DBMS_AQADM.TRANSACTIONAL);
END;
/
```

Example 8-8 Creating Queue Tables for Prioritized Messages and Multiple Consumers

```
BEGIN
  DBMS_AQADM.CREATE_QUEUE_TABLE(
    queue_table      => 'test.priority_qtab',
    queue_payload_type => 'test.order_typ',
    sort_list        => 'PRIORITY,ENQ_TIME',
    multiple_consumers => TRUE);
  DBMS_AQADM.CREATE_QUEUE_TABLE(
    queue_table      => 'test.multiconsumer_qtab',
    queue_payload_type => 'test.message_typ',
    sort_list        => 'PRIORITY,ENQ_TIME',
    multiple_consumers => TRUE);
END;
/
```

Example 8-9 Creating a Queue Table with Commit-Time Ordering

```
BEGIN
  DBMS_AQADM.CREATE_QUEUE_TABLE(
    queue_table      => 'test.commit_time_qtab',
    queue_payload_type => 'test.message_typ',
    sort_list        => 'COMMIT_TIME',
    multiple_consumers => TRUE,
    message_grouping => DBMS_AQADM.TRANSACTIONAL,
    compatible      => '10.0');
END;
/
```

Example 8-10 Creating an 8.1-Compatible Queue Table for Multiple Consumers

```

BEGIN
  DBMS_AQADM.CREATE_QUEUE_TABLE(
    queue_table      => 'test.multiconsumer_81_qtab',
    queue_payload_type => 'test.message_typ',
    multiple_consumers => TRUE,
    compatible       => '8.1');
END;
/

```

Example 8-11 Creating a Queue Table in a Specified Tablespace

```

BEGIN
  DBMS_AQADM.CREATE_QUEUE_TABLE(
    queue_table      => 'test.example_qtab',
    queue_payload_type => 'test.message_typ',
    storage_clause   => 'tablespace example');
END;
/

```

Example 8-12 Creating a Queue Table with Freelists or Freelist Groups

```

BEGIN
  DBMS_AQADM.CREATE_QUEUE_TABLE(
    queue_table      => 'test.freelist_qtab',
    queue_payload_type => 'RAW',
    storage_clause   => 'STORAGE (FREELISTS 4 FREELIST GROUPS 2)',
    compatible       => '8.1');
END;
/

```

8.1.2 Altering a Queue Table

DBMS_AQADM.ALTER_QUEUE_TABLE alters the existing properties of a non-sharded queue table.

```

DBMS_AQADM.ALTER_QUEUE_TABLE (
  queue_table      IN  VARCHAR2,
  comment          IN  VARCHAR2          DEFAULT NULL,
  primary_instance IN  BINARY_INTEGER DEFAULT NULL,
  secondary_instance IN BINARY_INTEGER DEFAULT NULL,
  replication_mode IN  BINARY_INTEGER DEFAULT NULL);

```

Parameter	Description
queue_table	This required parameter specifies the queue table name.
comment	This optional parameter is a user-specified description of the queue table. This user comment is added to the queue catalog.
primary_instance	This optional parameter specifies the primary owner of the queue table. Queue monitor scheduling and propagation for the queues in the queue table are done in this instance. You can specify and modify this parameter only if <code>compatible</code> is 8.1 or higher.
secondary_instance	This optional parameter specifies the owner of the queue table if the primary instance is not available. You can specify and modify this parameter only if <code>primary_instance</code> is also specified and <code>compatible</code> is 8.1 or higher.

Parameter	Description
<code>replication_mode</code>	Reserved for future use. <code>DBMS_AQADM.REPLICATION_MODE</code> if Queue is being altered to be in the Replication Mode or else <code>DBMS_AQADM.NONE</code> . Default value is <code>NULL</code> .

 **Note:**

In general, DDL statements are not supported on queue tables and may even render them inoperable. For example, issuing an `ALTER TABLE ... SHRINK` statement against a queue table results in an internal error, and all subsequent attempts to use the queue table will also result in errors. Oracle recommends that you not use DDL statements on queue tables.

If `GLOBAL_TOPIC_ENABLED = TRUE` when a queue table is modified, then a corresponding LDAP entry is also altered.

Example 8-13 Altering a Queue Table by Changing the Primary and Secondary Instances

```
BEGIN
  DBMS_AQADM.ALTER_QUEUE_TABLE(
    queue_table      => 'test.obj_qtab',
    primary_instance => 3,
    secondary_instance => 2);
END;
/
```

Example 8-14 Altering a Queue Table by Changing the Comment

```
BEGIN
  DBMS_AQADM.ALTER_QUEUE_TABLE(
    queue_table      => 'test.obj_qtab',
    comment          => 'revised usage for queue table');
END;
/
```

8.1.3 Dropping a Queue Table

`DBMS_AQADM.DROP_QUEUE_TABLE` drops an existing non-sharded queue table.

```
DBMS_AQADM.DROP_QUEUE_TABLE(
  queue_table      IN   VARCHAR2,
  force            IN   BOOLEAN DEFAULT FALSE,
```

You must stop and drop all the queues in a queue table before the queue table can be dropped. You must do this explicitly if `force` is set to `FALSE`. If `force` is set to `TRUE`, then all queues in the queue table and their associated propagation schedules are dropped automatically.

If `GLOBAL_TOPIC_ENABLED = TRUE` when a queue table is dropped, then a corresponding LDAP entry is also dropped.

Example 8-15 Dropping a Queue Table

```
BEGIN
  DBMS_AQADM.DROP_QUEUE_TABLE(
    queue_table => 'test.obj_qtab');
END;
/
```

Example 8-16 Dropping a Queue Table with force Option

```
BEGIN
  DBMS_AQADM.DROP_QUEUE_TABLE(
    queue_table => 'test.raw_qtab',
    force       => TRUE);
END;
/
```

8.1.4 Purging a Queue Table

DBMS_AQADM.PURGE_QUEUE_TABLE purges messages from a non-sharded queue table.

```
DBMS_AQADM.PURGE_QUEUE_TABLE(
  queue_table      IN  VARCHAR2,
  purge_condition  IN  VARCHAR2,
  purge_options    IN  aq$_purge_options_t);
```

It has the following parameters:

Parameter	Description
queue_table	This required parameter specifies the queue table name.
purge_condition	The purge condition must be in the format of a SQL WHERE clause, and it is case-sensitive. The condition is based on the columns of aq\$queue_table_name view. Each column name in the purge condition must be prefixed with "qtview." All purge conditions supported for persistent messages are also supported for buffered messages. To purge all queues in a queue table, set purge_condition to either NULL (a bare null word, no quotes) or '' (two single quotes).
purge_options	Type aq\$_purge_options_t contains a block parameter. If block is TRUE, then an exclusive lock on all the queues in the queue table is held while purging the queue table. This will cause concurrent enqueueers and dequeuers to block while the queue table is purged. The purge call always succeeds if block is TRUE. The default for block is FALSE. This will not block enqueueers and dequeuers, but it can cause the purge to fail with an error during high concurrency times. Type aq\$_purge_options_t also contains a delivery_mode parameter. If it is the default PERSISTENT, then only persistent messages are purged. If it is set to BUFFERED, then only buffered messages are purged. If it is set to PERSISTENT_OR_BUFFERED, then both types are purged.

A trace file is generated in the udump destination when you run this procedure. It details what the procedure is doing. The procedure commits after it has processed all the messages.

 **See Also:**

"DBMS_AQADM" in *Oracle Database PL/SQL Packages and Types Reference* for more information on `DBMS_AQADM.PURGE_QUEUE_TABLE`

 **Note:**

Some purge conditions, such as `consumer_name` in [Example 8-20](#) and `sender_name` in [Example 8-21](#), are supported only in 8.1-compatible queue tables. For more information, see [Table 9-1](#).

Example 8-17 Purging All Messages in a Queue Table

```
DECLARE
po dbms_aqadm.aq$_purge_options_t;
BEGIN
  po.block := FALSE;
  DBMS_AQADM.PURGE_QUEUE_TABLE(
    queue_table => 'test.obj_qtab',
    purge_condition => NULL,
    purge_options => po);
END;
/
```

Example 8-18 Purging All Messages in a Named Queue

```
DECLARE
po dbms_aqadm.aq$_purge_options_t;
BEGIN
  po.block := TRUE;
  DBMS_AQADM.PURGE_QUEUE_TABLE(
    queue_table => 'test.obj_qtab',
    purge_condition => 'qtvview.queue = ''TEST.OBJ_QUEUE''',
    purge_options => po);
END;
/
```

Example 8-19 Purging All PROCESSED Messages in a Named Queue

```
DECLARE
po dbms_aqadm.aq$_purge_options_t;
BEGIN
  po.block := TRUE;
  DBMS_AQADM.PURGE_QUEUE_TABLE(
    queue_table => 'test.obj_qtab',
    purge_condition => 'qtvview.queue = ''TEST.OBJ_QUEUE''
      and qtvview.msg_state = ''PROCESSED''',
    purge_options => po);
END;
/
```

Example 8-20 Purging All Messages in a Named Queue and for a Named Consumer

```

DECLARE
po dbms_aqadm.aq$_purge_options_t;
BEGIN
  po.block := TRUE;
  DBMS_AQADM.PURGE_QUEUE_TABLE(
    queue_table => 'test.multiconsumer_81_qtab',
    purge_condition => 'qtview.queue = 'TEST.MULTICONSUMER_81_QUEUE''
                      and qtview.consumer_name = 'PAYROLL_APP'',
    purge_options => po);
END;
/

```

Example 8-21 Purging All Messages from a Named Sender

```

DECLARE
po dbms_aqadm.aq$_purge_options_t;
BEGIN
  po.block := TRUE;
  DBMS_AQADM.PURGE_QUEUE_TABLE(
    queue_table => 'test.multiconsumer_81_qtab',
    purge_condition => 'qtview.sender_name = 'TEST.OBJ_QUEUE'',
    purge_options => po);
END;
/

```

8.1.5 Migrating a Queue Table

`DBMS_AQADM.MIGRATE_QUEUE_TABLE` migrates a non-sharded queue table from 8.0, 8.1, or 10.0 to 8.0, 8.1, or 10.0. Only the owner of the queue table can migrate it.

```

DBMS_AQADM.MIGRATE_QUEUE_TABLE(
  queue_table IN VARCHAR2,
  compatible IN VARCHAR2);

```

Note:

This procedure requires that the `EXECUTE` privilege on `DBMS_AQADM` be granted to the queue table owner, who is probably an ordinary queue user. If you do not want ordinary queue users to be able to create and drop queues and queue tables, add and delete subscribers, and so forth, then you must revoke the `EXECUTE` privilege as soon as the migration is done.

Note:

Queues created in a queue table with `compatible` set to 8.0 (referred to in this guide as 8.0-style queues) are deprecated in Oracle Database Advanced Queuing 10g Release 2 (10.2). Oracle recommends that any new queues you create be 8.1-style or newer and that you migrate existing 8.0-style queues at your earliest convenience.

If a schema was created by an import of an export dump from a lower release or has Oracle Database Advanced Queuing queues upgraded from a lower release, then attempts to drop it with `DROP USER CASCADE` will fail with `ORA-24005`. To drop such schemas:

1. Event 10851 should be set to level 1.
2. Drop all tables of the form `AQ$_queue_table_name_NR` from the schema.
3. Turn off event 10851.
4. Drop the schema.

Example 8-22 Upgrading a Queue Table from 8.1-Compatible to 10.0-Compatible

```
BEGIN
  DBMS_AQADM.MIGRATE_QUEUE_TABLE (
    queue_table => 'test.xml_qtab',
    compatible  => '10.0');
END;
/
```

8.2 Managing Non-Sharded Queues

These topics describe how to manage non-sharded queues.



Note:

Starting and stopping a sharded queue use the same APIs as non-sharded queues.

- [Creating a Queue](#)
- [Altering a Queue](#)
- [Starting a Queue](#)
- [Stopping a Queue](#)
- [Dropping a Queue](#)

8.2.1 Creating a Queue

`DBMS_AQADM.CREATE_QUEUE` creates a non-sharded queue.

```
DBMS_AQADM.CREATE_QUEUE(
  queue_name      IN      VARCHAR2,
  queue_table     IN      VARCHAR2,
  queue_type      IN      BINARY_INTEGER DEFAULT NORMAL_QUEUE,
  max_retries     IN      NUMBER          DEFAULT NULL,
  retry_delay     IN      NUMBER          DEFAULT 0,
  retention_time  IN      NUMBER          DEFAULT 0,
  dependency_tracking IN  BOOLEAN          DEFAULT FALSE,
  comment         IN      VARCHAR2       DEFAULT NULL,
```

It has the following parameters:

Parameter	Description
queue_name	This required parameter specifies the name of the new queue. Mixed case (upper and lower case together) queue names are supported if database compatibility is 10.0, but the names must be enclosed in double quote marks. So <code>abc.efg</code> means the schema is <code>ABC</code> and the name is <code>EFG</code> , but <code>"abc"."efg"</code> means the schema is <code>abc</code> and the name is <code>efg</code> . Starting from 12c Release 2 (12.2.), the maximum length of user-generated queue names is 122 bytes. If you attempt to create a queue with a longer name, error <code>ORA-24019</code> results. Queue names generated by Oracle Database Advanced Queuing, such as those listed in "Other Tables and Views", cannot be longer than 128 characters.
queue_table	This required parameter specifies the queue table in which the queue is created.
queue_type	This parameter specifies what type of queue to create. The default <code>NORMAL_QUEUE</code> produces a normal queue. <code>EXCEPTION_QUEUE</code> produces an exception queue.
max_retries	This parameter limits the number of times a dequeue with the <code>REMOVE</code> mode can be attempted on a message. The maximum value of <code>max_retries</code> is $2^{31} - 1$.
retry_delay	This parameter specifies the number of seconds after which this message is scheduled for processing again after an application rollback. The default is 0, which means the message can be retried as soon as possible. This parameter has no effect if <code>max_retries</code> is set to 0. This parameter is supported for single-consumer queues and 8.1-style or higher multiconsumer queues but not for 8.0-style multiconsumer queues, which are deprecated in Oracle Database Advanced Queuing 10g Release 2 (10.2).
retention_time	This parameter specifies the number of seconds a message is retained in the queue table after being dequeued from the queue. When <code>retention_time</code> expires, messages are removed by the time manager process. <code>INFINITE</code> means the message is retained forever. The default is 0, no retention.
dependency_tracking	This parameter is reserved for future use. <code>FALSE</code> is the default. <code>TRUE</code> is not permitted in this release.
comment	This optional parameter is a user-specified description of the queue. This user comment is added to the queue catalog.

All queue names must be unique within a [schema](#). Once a queue is created with `CREATE_QUEUE`, it can be enabled by calling `START_QUEUE`. By default, the queue is created with both enqueue and dequeue disabled. To view retained messages, you can either dequeue by message ID or use SQL. If `GLOBAL_TOPIC_ENABLED = TRUE` when a queue is created, then a corresponding LDAP entry is also created.

The following examples ([Example 8-23](#) through [Example 8-30](#)) use data structures created in [Example 8-1](#) through [Example 8-12](#).

Example 8-23 Creating a Queue for Messages of Object Type

```
BEGIN
  DBMS_AQADM.CREATE_QUEUE(
    queue_name      => 'test.obj_queue',
```

```
        queue_table      => 'test.obj_qtab');  
END;  
/
```

Example 8-24 Creating a Queue for Messages of RAW Type

```
BEGIN  
  DBMS_AQADM.CREATE_QUEUE(  
    queue_name      => 'test.raw_queue',  
    queue_table     => 'test.raw_qtab');  
END;  
/
```

Example 8-25 Creating a Queue for Messages of LOB Type

```
BEGIN  
  DBMS_AQADM.CREATE_QUEUE(  
    queue_name      => 'test.lob_queue',  
    queue_table     => 'test.lob_qtab');  
END;  
/
```

Example 8-26 Creating a Queue for Grouped Messages

```
BEGIN  
  DBMS_AQADM.CREATE_QUEUE(  
    queue_name      => 'test.group_queue',  
    queue_table     => 'test.group_qtab');  
END;  
/
```

Example 8-27 Creating a Queue for Prioritized Messages

```
BEGIN  
  DBMS_AQADM.CREATE_QUEUE(  
    queue_name      => 'test.priority_queue',  
    queue_table     => 'test.priority_qtab');  
END;  
/
```

Example 8-28 Creating a Queue for Prioritized Messages and Multiple Consumers

```
BEGIN  
  DBMS_AQADM.CREATE_QUEUE(  
    queue_name      => 'test.multiconsumer_queue',  
    queue_table     => 'test.multiconsumer_qtab');  
END;  
/
```

Example 8-29 Creating a Queue to Demonstrate Propagation

```
BEGIN  
  DBMS_AQADM.CREATE_QUEUE(  
    queue_name      => 'test.another_queue',  
    queue_table     => 'test.multiconsumer_qtab');  
END;  
/
```

Example 8-30 Creating an 8.1-Style Queue for Multiple Consumers

```

BEGIN
  DBMS_AQADM.CREATE_QUEUE(
    queue_name      => 'test.multiconsumer_81_queue',
    queue_table     => 'test.multiconsumer_81_qtab');
END;
/

```

8.2.2 Altering a Queue

`DBMS_AQADM.ALTER_QUEUE` alters existing properties of a non-shared queue.

```

DBMS_AQADM.ALTER_QUEUE(
  queue_name      IN    VARCHAR2,
  max_retries     IN    NUMBER   DEFAULT NULL,
  retry_delay     IN    NUMBER   DEFAULT NULL,
  retention_time  IN    NUMBER   DEFAULT NULL,
  comment         IN    VARCHAR2 DEFAULT NULL);

```

Only `max_retries`, `comment`, `retry_delay`, and `retention_time` can be altered. To view retained messages, you can either dequeue by message ID or use SQL. If `GLOBAL_TOPIC_ENABLED = TRUE` when a queue is modified, then a corresponding LDAP entry is also altered.

The following example changes retention time, saving messages for 1 day after dequeuing:

Example 8-31 Altering a Queue by Changing Retention Time

```

BEGIN
  DBMS_AQADM.ALTER_QUEUE(
    queue_name      => 'test.another_queue',
    retention_time  => 86400);
END;
/

```

8.2.3 Starting a Queue

`DBMS_AQADM.START_QUEUE` enables the specified non-shared queue for enqueueing or dequeuing.

```

DBMS_AQADM.START_QUEUE(
  queue_name      IN    VARCHAR2,
  enqueue        IN    BOOLEAN  DEFAULT TRUE,
  dequeue        IN    BOOLEAN  DEFAULT TRUE);

```

After creating a queue, the administrator must use `START_QUEUE` to enable the queue. The default is to enable it for both enqueue and dequeue. Only dequeue operations are allowed on an exception queue. This operation takes effect when the call completes and does not have any [transactional](#) characteristics.

Example 8-32 Starting a Queue with Both Enqueue and Dequeue Enabled

```

BEGIN
  DBMS_AQADM.START_QUEUE (
    queue_name      => 'test.obj_queue');
END;
/

```

Example 8-33 Starting a Queue for Dequeue Only

```
BEGIN
  DBMS_AQADM.START_QUEUE(
    queue_name      => 'test.raw_queue',
    dequeue         => TRUE,
    enqueue         => FALSE);
END;
/
```

8.2.4 Stopping a Queue

`DBMS_AQADM.STOP_QUEUE` disables enqueueing, dequeuing, or both on the specified non-sharded queue.

```
DBMS_AQADM.STOP_QUEUE(
  queue_name      IN   VARCHAR2,
  enqueue         IN   BOOLEAN DEFAULT TRUE,
  dequeue         IN   BOOLEAN DEFAULT TRUE,
  wait            IN   BOOLEAN DEFAULT TRUE);
```

By default, this call disables both enqueue and dequeue. A queue cannot be stopped if there are outstanding transactions against the queue. This operation takes effect when the call completes and does not have any transactional characteristics.

Example 8-34 Stopping a Queue

```
BEGIN
  DBMS_AQADM.STOP_QUEUE(
    queue_name      => 'test.obj_queue');
END;
/
```

8.2.5 Dropping a Queue

This procedure drops an existing non-sharded queue. `DROP_QUEUE` is not allowed unless `STOP_QUEUE` has been called to disable the queue for both enqueueing and dequeuing. All the queue data is deleted as part of the drop operation.

```
DBMS_AQADM.DROP_QUEUE(
  queue_name      IN   VARCHAR2,
```

If `GLOBAL_TOPIC_ENABLED = TRUE` when a queue is dropped, then a corresponding LDAP entry is also dropped.

Example 8-35 Dropping a Standard Queue

```
BEGIN
  DBMS_AQADM.DROP_QUEUE(
    queue_name      => 'test.obj_queue');
END;
/
```

8.3 Managing Sharded Queues

These topics describe how to manage sharded queues.

 **Note:**

Starting and stopping a sharded queue use the same APIs as non-sharded queues.

- [Creating a Sharded Queue](#)
- [Dropping a Sharded Queue](#)
- [Altering a Sharded Queue](#)
- [Setting a Queue Parameter](#)
- [Unsetting a Queue Parameter](#)
- [Getting a Queue Parameter](#)
- [Creating an Exception Queue](#)

8.3.1 Creating a Sharded Queue

The `CREATE_SHARDED_QUEUE` API creates a sharded queue.

```
PROCEDURE CREATE_SHARDED_QUEUE (
  queue_name          IN VARCHAR2,
  storage_clause      IN VARCHAR2      DEFAULT NULL,
  multiple_consumers  IN BOOLEAN       DEFAULT FALSE,
  max_retries         IN NUMBER        DEFAULT NULL,
  comment             IN VARCHAR2      DEFAULT NULL,
  queue_payload_type  IN VARCHAR2      DEFAULT JMS_TYPE,
  queue_properties    IN QUEUE_PROPS_T DEFAULT NULL,
  replication_mode    IN BINARY_INTEGER DEFAULT NONE);
```

It has the following parameters:

Parameter	Description
<code>queue_name</code>	This required parameter specifies the name of the new queue. Maximum of 128 characters allowed.
<code>storage_clause</code>	The storage parameter is included in the <code>CREATE TABLE</code> statement when the queue table is created. The <code>storage_clause</code> argument can take any text that can be used in a standard <code>CREATE TABLE storage_clause</code> argument. The storage parameter can be made up of any combinations of the following parameters: <code>PCTFREE</code> , <code>PCTUSED</code> , <code>INITTRANS</code> , <code>MAXTRANS</code> , <code>TABLESPACE</code> , <code>LOB</code> , and a table storage clause. If a tablespace is not specified here, then the queue table and all its related objects are created in the default user tablespace. If a tablespace is specified here, then the queue table and all its related objects are created in the tablespace specified in the storage clause. See <i>Oracle Database SQL Language Reference</i> for the usage of these parameters.
<code>multiple_consumers</code>	<code>FALSE</code> means queues can only have one consumer for each message. This is the default. <code>TRUE</code> means queues created in the table can have multiple consumers for each message.

Parameter	Description
<code>max_retries</code>	This optional parameter limits the number of times that a dequeue can be reattempted on a message after a failure. The maximum value of <code>max_retries</code> is $2^{31} - 1$. After the retry limit has been exceeded, the message will be purged from the queue. <code>RETRY_COUNT</code> is incremented when the application issues a rollback after executing the dequeue. If a dequeue transaction fails because the server process dies (including <code>ALTER SYSTEM KILL SESSION</code>) or <code>SHUTDOWN ABORT</code> on the instance, then <code>RETRY_COUNT</code> is not incremented.
<code>comment</code>	This optional parameter is a user-specified description of the queue table. This user comment is added to the queue catalog.
<code>queue_payload_type</code>	Payload can be <code>RAW</code> , <code>DBMS_AQADM.JMS_TYPE</code> , or an object type. Default is <code>DBMS_AQADM.JMS_TYPE</code> .
<code>queue_properties</code>	Properties such as Normal or Exception Queue, Retry delay, retention time, sort list and cache hint. <i>See also Oracle Database PL/SQL Packages and Types Reference for more information about <code>queue_properties</code>.</i>
<code>replication_mode</code>	Reserved for future use. <code>DBMS_AQADM.REPLICATION_MODE</code> if queue is being created in the Replication Mode or else <code>DBMS_AQADM.NONE</code> . Default is <code>DBMS_AQADM.NONE</code> .

8.3.2 Dropping a Sharded Queue

This procedure drops an existing sharded queue from the database queuing system. You must stop the queue before calling `DROP_SHARDED_QUEUE`. User must stop the queue explicitly if `force` is set to `FALSE` before calling `DROP_SHARDED_QUEUE`. If `force` is set to `TRUE` then queue will be stopped internally and then dropped.

Syntax

```
DBMS_AQADM.DROP_SHARDED_QUEUE(
    queue_name IN VARCHAR2,
    force      IN BOOLEAN DEFAULT FALSE )
```

Parameters

Table 8-1 CREATE_SHARDED_QUEUE Procedure Parameters

Parameter	Description
<code>queue_name</code>	This required parameter specifies the name of the sharded queue.
<code>force</code>	The sharded queue is dropped even if the queue is not stopped.

8.3.3 Altering a Sharded Queue

This procedure provides user the ability to alter `queue_properties` of a sharded queue.

Syntax

```
PROCEDURE ALTER_SHARDED_QUEUE(
    queue_name          IN VARCHAR2,
```

```

max_retries          IN NUMBER          DEFAULT NULL,
comment              IN VARCHAR2        DEFAULT NULL,
queue_properties     IN QUEUE_PROPS_T   DEFAULT NULL,
replication_mode     IN BINARY_INTEGER DEFAULT NULL);

```

Parameters

Table 8-2 ALTER_SHARDED_QUEUE Procedure Parameters

Parameter	Description
queue_name	This parameter specifies the name of the sharded queue. A maximum of 128 characters are allowed.
max_retries	The maximum number of retries allowed.
comment	The parameter comment.
queue_properties	Properties such as Normal or Exception Queue, Retry delay, retention time, sort list and cache hint. <i>See also Oracle Database PL/SQL Packages and Types Reference for more information about queue_properties.</i>
replication_mode	Reserved for future use. DBMS_AQADM.REPLICATION_MODE if queue is being altered to be in the Replication Mode or else DBMS_AQADM.NONE. Default is NULL.

8.3.4 Setting a Queue Parameter

This procedure allows user to set different parameters for sharded queues at queue or database level. For database level the `queue_name` should be `NULL`. Note that queue overrides database level parameter values.

Syntax

```

PROCEDURE SET_QUEUE_PARAMETER(
  queue_name          IN VARCHAR2,
  param_name          IN VARCHAR2,
  param_value         IN NUMBER);

```

Parameters

Table 8-3 SET_QUEUE_PARAMETER Procedure Parameters

Parameter	Description
queue_name	The name of the sharded queue.
param_name	The name of the parameter.
param_value	The value of the parameter.

8.3.5 Unsetting a Queue Parameter

This procedure allows user to unset different parameters for sharded queues at queue or database level. For database level the `queue_name` should be `NULL`. Note that queue overrides database level parameter values.

Syntax

```
PROCEDURE UNSET_QUEUE_PARAMETER(
    queue_name      IN VARCHAR2,
    param_name      IN VARCHAR2);
```

Parameters**Table 8-4 UNSET_QUEUE_PARAMETER Procedure Parameters**

Parameter	Description
queue_name	The name of the sharded queue.
param_name	The name of the parameter.

8.3.6 Getting a Queue Parameter

This procedure allows user to get different parameters for sharded queues at queue or database level. For database level the `queue_name` should be `NULL`. Note that queue overrides database level parameter values.

Syntax

```
PROCEDURE GET_QUEUE_PARAMETER(
    queue_name      IN VARCHAR2,
    param_name      IN VARCHAR2,
    param_value     OUT NUMBER);
```

Parameters**Table 8-5 GET_QUEUE_PARAMETER Procedure Parameters**

Parameter	Description
queue_name	The name of the sharded queue.
param_name	The name of the parameter.
param_value	The value of the parameter.

8.3.7 Creating an Exception Queue

This procedure allows a user to create an exception queue for a sharded queue.

Syntax

```
PROCEDURE CREATE_EXCEPTION_QUEUE(
    sharded_queue_name IN VARCHAR2,
    exception_queue_name IN VARCHAR2 DEFAULT NULL
);
```

Parameters

Table 8-6 CREATE_EXCEPTION_QUEUE Procedure Parameters

Parameter	Description
sharded_queue_name	The name of the sharded queue.
exception_queue_name	The name of the exception queue.

8.4 Managing Transformations

Transformations change the format of a message, so that a message created by one application can be understood by another application. You can use transformations on both persistent and buffered messages. These topics describe how to manage queue tables.

- [Creating a Transformation](#)
- [Modifying a Transformation](#)
- [Dropping a Transformation](#)

**Note:**

Sharded queues do not support transformations.

8.4.1 Creating a Transformation

DBMS_TRANSFORM.CREATE_TRANSFORMATION creates a message format transformation.

```
DBMS_TRANSFORM.CREATE_TRANSFORMATION(
  schema          VARCHAR2(30),
  name            VARCHAR2(30),
  from_schema     VARCHAR2(30),
  from_type       VARCHAR2(30),
  to_schema       VARCHAR2(30),
  to_type         VARCHAR2(30),
  transformation  VARCHAR2(4000));
```

The **transformation** must be a SQL function with input type `from_type`, returning an object of type `to_type`. It can also be a SQL expression of type `to_type`, referring to `from_type`. All references to `from_type` must be of the form `source.user_data`.

You must be granted `EXECUTE` privilege on `dbms_transform` to use this feature. This privilege is included in the `AQ_ADMINISTRATOR_ROLE`.

You must also have `EXECUTE` privilege on the user-defined types that are the source and destination types of the transformation, and have `EXECUTE` privileges on any PL/SQL function being used in the transformation function. The transformation cannot write the database state (that is, perform [DML](#) operations) or commit or rollback the current transaction.

Example 8-36 Creating a Transformation

```
BEGIN
  DBMS_TRANSFORM.CREATE_TRANSFORMATION(
    schema      => 'test',
    name        => 'message_order_transform',
    from_schema => 'test',
    from_type   => 'message_typ',
    to_schema   => 'test',
    to_type     => 'order_typ',
    transformation => 'test.order_typ(
      source.user_data.sender_id,
      source.user_data.subject,
      source.user_data.text)');
END;
/
```



See Also:

["Oracle Database Advanced Queuing Security"](#) for more information on administrator and user roles

8.4.2 Modifying a Transformation

`DBMS_TRANSFORM.MODIFY_TRANSFORMATION` changes the transformation function and specifies transformations for each attribute of the target type.

```
DBMS_TRANSFORM.MODIFY_TRANSFORMATION(
  schema      VARCHAR2(30),
  name        VARCHAR2(30),
  attribute_number INTEGER,
  transformation VARCHAR2(4000));
```

If the attribute number 0 is specified, then the transformation expression singularly defines the transformation from the source to target types.

All references to `from_type` must be of the form `source.user_data`. All references to the attributes of the source type must be prefixed by `source.user_data`.

You must be granted `EXECUTE` privileges on `dbms_transform` to use this feature. You must also have `EXECUTE` privileges on the user-defined types that are the source and destination types of the transformation, and have `EXECUTE` privileges on any PL/SQL function being used in the transformation function.

8.4.3 Dropping a Transformation

`DBMS_TRANSFORM.DROP_TRANSFORMATION` drops a transformation.

```
DBMS_TRANSFORM.DROP_TRANSFORMATION (
  schema      VARCHAR2(30),
  name        VARCHAR2(30));
```

You must be granted `EXECUTE` privileges on `dbms_transform` to use this feature. You must also have `EXECUTE` privileges on the user-defined types that are the source and

destination types of the transformation, and have `EXECUTE` privileges on any PL/SQL function being used in the transformation function.

8.5 Granting and Revoking Privileges

These topics describe how to grant and revoke privileges.

- [Granting Oracle Database Advanced Queuing System Privileges](#)
- [Revoking Oracle Database Advanced Queuing System Privileges](#)
- [Granting Queue Privileges](#)
- [Revoking Queue Privileges](#)

8.5.1 Granting Oracle Database Advanced Queuing System Privileges

`DBMS_AQADM.GRANT_SYSTEM_PRIVILEGE` grants Oracle Database Advanced Queuing system privileges to users and roles. The privileges are `ENQUEUE_ANY`, `DEQUEUE_ANY`, `MANAGE_ANY`. Initially, only `SYS` and `SYSTEM` can use this procedure successfully.

```
DBMS_AQADM.GRANT_SYSTEM_PRIVILEGE(  
  privilege      IN   VARCHAR2,  
  grantee       IN   VARCHAR2,  
  admin_option  IN   BOOLEAN := FALSE);
```

Users granted the `ENQUEUE_ANY` privilege are allowed to enqueue messages to any queues in the database. Users granted the `DEQUEUE_ANY` privilege are allowed to dequeue messages from any queues in the database. Users granted the `MANAGE_ANY` privilege are allowed to run `DBMS_AQADM` calls on any schemas in the database.

Example 8-37 Granting AQ System Privileges

```
BEGIN  
  DBMS_AQADM.GRANT_SYSTEM_PRIVILEGE(  
    privilege      => 'ENQUEUE_ANY',  
    grantee       => 'test',  
    admin_option  => FALSE);  
  DBMS_AQADM.GRANT_SYSTEM_PRIVILEGE(  
    privilege      => 'DEQUEUE_ANY',  
    grantee       => 'test',  
    admin_option  => FALSE);  
END;  
/
```

8.5.2 Revoking Oracle Database Advanced Queuing System Privileges

`DBMS_AQADM.REVOKE_SYSTEM_PRIVILEGE` revokes Oracle Database Advanced Queuing system privileges from users and roles. The privileges are `ENQUEUE_ANY`, `DEQUEUE_ANY` and `MANAGE_ANY`.

```
DBMS_AQADM.REVOKE_SYSTEM_PRIVILEGE(  
  privilege      IN   VARCHAR2,  
  grantee       IN   VARCHAR2);
```

The `ADMIN` option for a system privilege cannot be selectively revoked.

Users granted the `ENQUEUE_ANY` privilege are allowed to enqueue messages to any queues in the database. Users granted the `DEQUEUE_ANY` privilege are allowed to dequeue messages from any queues in the database. Users granted the `MANAGE_ANY` privilege are allowed to run `DBMS_AQADM` calls on any schemas in the database.

Example 8-38 Revoking AQ System Privileges

```
BEGIN
  DBMS_AQADM.REVOKE_SYSTEM_PRIVILEGE(
    privilege      => 'DEQUEUE_ANY',
    grantee        => 'test');
END;
/
```

8.5.3 Granting Queue Privileges

`DBMS_AQADM.GRANT_QUEUE_PRIVILEGE` grants privileges on a queue to users and roles. The privileges are `ENQUEUE`, `DEQUEUE`, or `ALL`. Initially, only the queue table owner can use this procedure to grant privileges on the queues.

```
DBMS_AQADM.GRANT_QUEUE_PRIVILEGE(
  privilege      IN   VARCHAR2,
  queue_name     IN   VARCHAR2,
  grantee        IN   VARCHAR2,
  grant_option   IN   BOOLEAN := FALSE);
```

Note:

This procedure requires that `EXECUTE` privileges on `DBMS_AQADM` be granted to the queue table owner, who is probably an ordinary queue user. If you do not want ordinary queue users to be able to create and drop queues and queue tables, add and delete subscribers, and so forth, then you must revoke the `EXECUTE` privilege as soon as the initial `GRANT_QUEUE_PRIVILEGE` is done.

Example 8-39 Granting Queue Privilege

```
BEGIN
  DBMS_AQADM.GRANT_QUEUE_PRIVILEGE (
    privilege      => 'ALL',
    queue_name     => 'test.multiconsumer_81_queue',
    grantee        => 'test_adm',
    grant_option   => TRUE);
END;
/
```

8.5.4 Revoking Queue Privileges

`DBMS_AQADM.REVOKE_QUEUE_PRIVILEGE` revokes privileges on a queue from users and roles. The privileges are `ENQUEUE` or `DEQUEUE`.

```
DBMS_AQADM.REVOKE_QUEUE_PRIVILEGE (
  privilege      IN   VARCHAR2,
  queue_name     IN   VARCHAR2,
  grantee        IN   VARCHAR2);
```

To revoke a privilege, the revoker must be the original grantor of the privilege. The privileges propagated through the `GRANT` option are revoked if the grantor's privileges are revoked.

You can revoke the dequeue right of a grantee on a specific queue, leaving the grantee with only the enqueue right as in [Example 8-40](#).

Example 8-40 Revoking Dequeue Privilege

```
BEGIN
  DBMS_AQADM.REVOKE_QUEUE_PRIVILEGE(
    privilege => 'DEQUEUE',
    queue_name => 'test.multiconsumer_81_queue',
    grantee   => 'test_admin');
END;
```

8.6 Managing Subscribers

These topics describe how to manage subscribers.

- [Adding a Subscriber](#)
- [Altering a Subscriber](#)
- [Removing a Subscriber](#)

8.6.1 Adding a Subscriber

`DBMS_AQADM.ADD_SUBSCRIBER` adds a default subscriber to a queue.

```
DBMS_AQADM.ADD_SUBSCRIBER (
  queue_name   IN   VARCHAR2,
  subscriber   IN   sys.aq$_agent,
  rule         IN   VARCHAR2 DEFAULT NULL,
  transformation IN VARCHAR2 DEFAULT NULL,
  queue_to_queue IN BOOLEAN DEFAULT FALSE,
  delivery_mode IN   PLS_INTEGER DEFAULT PERSISTENT);
```

An application can enqueue messages to a specific list of recipients or to the default list of [subscribers](#). This operation succeeds only on queues that allow multiple consumers, and the total number of subscribers must be 1024 or less. This operation takes effect immediately and the containing transaction is committed. Enqueue requests that are executed after the completion of this call reflect the new action. Any string within the `rule` must be quoted (with single quotation marks) as follows:

```
rule => 'PRIORITY <= 3 AND CORRID = ''FROM JAPAN'''
```

User data properties or attributes apply only to object payloads and must be prefixed with `tab.userdata` in all cases.

If `GLOBAL_TOPIC_ENABLED` is set to true when a subscriber is created, then a corresponding LDAP entry is also created.

Specify the name of the transformation to be applied during dequeue or propagation. The transformation must be created using the `DBMS_TRANSFORM` package.

For queues that contain payloads with XMLType attributes, you can specify rules that contain operators such as `XMLType.existsNode()` and `XMLType.extract()`.

If parameter `queue_to_queue` is set to `TRUE`, then the added subscriber is a queue-to-queue subscriber. When queue-to-queue propagation is set up between a source queue and a destination queue, queue-to-queue subscribers receive messages through that propagation schedule.

If the `delivery_mode` parameter is the default `PERSISTENT`, then the subscriber receives only persistent messages. If it is set to `BUFFERED`, then the subscriber receives only buffered messages. If it is set to `PERSISTENT_OR_BUFFERED`, then the subscriber receives both types. You cannot alter this parameter with `ALTER_SUBSCRIBER`.

The agent name should be `NULL` if the destination queue is a single consumer queue.

Note:

`ADD_SUBSCRIBER` is an administrative operation on a queue. Although Oracle Database AQ does not prevent applications from issuing administrative and operational calls concurrently, they are executed serially. `ADD_SUBSCRIBER` blocks until pending calls that are enqueueing or dequeuing messages complete. It will not wait for the pending transactions to complete.

See Also:

- *Oracle Database PL/SQL Packages and Types Reference* for more information on the `DBMS_TRANSFORM` package
- ["Scheduling a Queue Propagation"](#)

Example 8-41 Adding a Subscriber at a Designated Queue at a Database Link

```
DECLARE
    subscriber          sys.aq$_agent;
BEGIN
    subscriber := sys.aq$_agent('subscriber1', 'test2.msg_queue2@london', null);
    DBMS_AQADM.ADD_SUBSCRIBER(
        queue_name      => 'test.multiconsumer_81_queue',
        subscriber      => subscriber);
END;
/
```

Example 8-42 Adding a Single Consumer Queue at a Database Link as a Subscriber

```
DECLARE
    subscriber          sys.aq$_agent;
BEGIN
    subscriber := sys.aq$_agent('subscriber1', 'test2.msg_queue2@london', null);
    DBMS_AQADM.ADD_SUBSCRIBER(
        queue_name      => 'test.multiconsumer_81_queue',
        subscriber      => subscriber);
END;
/
```

Example 8-43 Adding a Subscriber with a Rule

```

DECLARE
    subscriber      sys.aq$_agent;
BEGIN
    subscriber := sys.aq$_agent('subscriber2', 'test2.msg_queue2@london', null);
    DBMS_AQADM.ADD_SUBSCRIBER(
        queue_name => 'test.multiconsumer_81_queue',
        subscriber => subscriber,
        rule       => 'priority < 2');
END;
/

```

Example 8-44 Adding a Subscriber and Specifying a Transformation

```

DECLARE
    subscriber      sys.aq$_agent;
BEGIN
    subscriber := sys.aq$_agent('subscriber3', 'test2.msg_queue2@london', null);
    DBMS_AQADM.ADD_SUBSCRIBER(
        queue_name     => 'test.multiconsumer_81_queue',
        subscriber     => subscriber,
        transformation => 'test.message_order_transform');
END;
/

```

Example 8-45 Propagating from a Multiple-Consumer Queue to a Single Consumer Queue

```

DECLARE
    subscriber      SYS.AQ$_AGENT;
BEGIN
    subscriber := SYS.AQ$_AGENT(NULL, 'test2.single_consumer__queue@london',
null);
    DBMS_AQADM.ADD_SUBSCRIBER(
        queue_name     => 'test.multiconsumer_81_queue',
        subscriber     => subscriber);
END;

```

8.6.2 Altering a Subscriber

`DBMS_AQADM.ALTER_SUBSCRIBER` alters existing properties of a subscriber to a specified queue.

```

DBMS_AQADM.ALTER_SUBSCRIBER (
    queue_name      IN      VARCHAR2,
    subscriber      IN      sys.aq$_agent,
    rule            IN      VARCHAR2,
    transformation  IN      VARCHAR2);

```

The rule, the transformation, or both can be altered. If you alter only one of these attributes, then specify the existing value of the other attribute to the alter call. If `GLOBAL_TOPIC_ENABLED = TRUE` when a subscriber is modified, then a corresponding LDAP entry is created.

Example 8-46 Altering a Subscriber Rule

```

DECLARE
    subscriber      sys.aq$_agent;
BEGIN
    subscriber := sys.aq$_agent('subscriber2', 'test2.msg_queue2@london', null);

```

```

DBMS_AQADM.ALTER_SUBSCRIBER(
    queue_name => 'test.multiconsumer_81_queue',
    subscriber => subscriber,
    rule       => 'priority = 1');
END;
/

```

8.6.3 Removing a Subscriber

DBMS_AQADM.REMOVE_SUBSCRIBER removes a default subscriber from a queue.

```

DBMS_AQADM.REMOVE_SUBSCRIBER (
    queue_name      IN      VARCHAR2,
    subscriber      IN      sys.aq$_agent);

```

This operation takes effect immediately and the containing transaction is committed. All references to the subscriber in existing messages are removed as part of the operation. If `GLOBAL_TOPIC_ENABLED = TRUE` when a subscriber is dropped, then a corresponding LDAP entry is also dropped.

It is not an error to run the `REMOVE_SUBSCRIBER` procedure even when there are pending messages that are available for dequeue by the consumer. These messages are automatically made unavailable for dequeue when the `REMOVE_SUBSCRIBER` procedure finishes.

Note:

`REMOVE_SUBSCRIBER` is an administrative operation on a queue. Although Oracle Database AQ does not prevent applications from issuing administrative and operational calls concurrently, they are executed serially. `REMOVE_SUBSCRIBER` blocks until pending calls that are enqueueing or dequeuing messages complete. It will not wait for the pending transactions to complete.

Example 8-47 Removing a Subscriber

```

DECLARE
    subscriber      sys.aq$_agent;
BEGIN
    subscriber := sys.aq$_agent ('subscriber2', 'test2.msg_queue2@london', null);
    DBMS_AQADM.REMOVE_SUBSCRIBER(
        queue_name => 'test.multiconsumer_81_queue',
        subscriber => subscriber);
END;
/

```

8.7 Managing Propagations

The propagation schedules defined for a queue can be changed or dropped at any time during the life of the queue.

You can also temporarily disable a schedule instead of dropping it. All administrative calls can be made irrespective of whether the schedule is active or not. If a schedule is active, then it takes a few seconds for the calls to be processed.

These topics describe how to manage propagations.

- [Scheduling a Queue Propagation](#)
- [Verifying Propagation Queue Type](#)
- [Altering a Propagation Schedule](#)
- [Enabling a Propagation Schedule](#)
- [Disabling a Propagation Schedule](#)
- [Unschedulering a Queue Propagation](#)

8.7.1 Scheduling a Queue Propagation

DBMS_AQADM.SCHEDULE_PROPAGATION schedules propagation of messages.

```
DBMS_AQADM.SCHEDULE_PROPAGATION (  
  queue_name          IN  VARCHAR2,  
  destination         IN  VARCHAR2 DEFAULT NULL,  
  start_time          IN  DATE      DEFAULT SYSDATE,  
  duration            IN  NUMBER    DEFAULT NULL,  
  next_time           IN  VARCHAR2  DEFAULT NULL,  
  latency             IN  NUMBER    DEFAULT 60,  
  destination_queue   IN  VARCHAR2  DEFAULT NULL);
```

The destination can be identified by a database link in the `destination` parameter, a queue name in the `destination_queue` parameter, or both. Specifying only a database link results in queue-to-dblink propagation. If you propagate messages to several queues in another database, then all propagations have the same frequency.

If a private database link in the schema of the queue table owner has the same name as a public database link, AQ always uses the private database link.

Specifying the destination queue name results in queue-to-queue propagation. If you propagate messages to several queues in another database, queue-to-queue propagation enables you to configure each schedule independently of the others. You can enable or disable individual propagations.

Note:

If you want queue-to-queue propagation to a queue in another database, then you must specify parameters `destination` and `destination_queue`.

Queue-to-queue propagation mode supports transparent failover when propagating to a destination Oracle Real Application Clusters (Oracle RAC) system. With queue-to-queue propagation, it is not required to repoint a database link if the owner instance of the queue fails on Oracle RAC.

Messages can also be propagated to other queues in the same database by specifying a `NULL` destination. If a message has multiple recipients at the same destination in either the same or different queues, then the message is propagated to all of them at the same time.

The source queue must be in a queue table meant for multiple consumers. If you specify a single-consumer queue, than error ORA-24039 results. Oracle Database Advanced Queuing does not support the use of synonyms to refer to queues or database links.

If you specify a propagation `next_time` and `duration`, propagation will run periodically for the specified duration. If you specify a latency of zero with no `next_time` or `duration`, the resulting propagation will run forever, propagating messages as they appear in the queue, and idling otherwise. If a non-zero latency is specified, with no `next_time` or `duration` (default), the propagation schedule will be event-based. It will be scheduled to run when there are messages in the queue to be propagated. When there are no more messages for a system-defined period of time, the job will stop running until there are new messages to be propagated. The time at which the job runs depends on other factors, such as the number of ready jobs and the number of job queue processes.

Propagation uses a linear backoff scheme for retrying propagation from a schedule that encountered a failure. If a schedule continuously encounters failures, then the first retry happens after 30 seconds, the second after 60 seconds, the third after 120 seconds and so forth. If the retry time is beyond the expiration time of the current window, then the next retry is attempted at the start time of the next window. A maximum of 16 retry attempts are made after which the schedule is automatically disabled.

 **Note:**

Once a retry attempt slips to the next propagation window, it will always do so; the exponential backoff scheme no longer governs retry scheduling. If the date function specified in the `next_time` parameter of `DBMS_AQADM.SCHEDULE_PROPAGATION` results in a short interval between windows, then the number of unsuccessful retry attempts can quickly reach 16, disabling the schedule.

If you specify a value for `destination` that does not exist, then this procedure still runs without throwing an error. You can query runtime propagation errors in the `LAST_ERROR_MSG` column of the `USER_QUEUE_SCHEDULES` view.

 **See Also:**

- "Managing Job Queues" in *Oracle Database Administrator's Guide* for more information on job queues and `Jnnn` background processes
- [Internet Access to Oracle Database Advanced Queuing](#)
- ["USER_QUEUE_SCHEDULES: Propagation Schedules in User Schema"](#)

Example 8-48 Scheduling a Propagation to Queues in the Same Database

```
BEGIN
  DBMS_AQADM.SCHEDULE_PROPAGATION(
    queue_name => 'test.multiconsumer_queue');
END;
/
```

Example 8-49 Scheduling a Propagation to Queues in Another Database

```

BEGIN
  DBMS_AQADM.SCHEDULE_PROPAGATION(
    queue_name => 'test.multiconsumer_queue',
    destination => 'another_db.world');
END;
/

```

Example 8-50 Scheduling Queue-to-Queue Propagation

```

BEGIN
  DBMS_AQADM.SCHEDULE_PROPAGATION(
    queue_name => 'test.multiconsumer_queue',
    destination => 'another_db.world'
    destination_queue => 'target_queue');
END;
/

```

8.7.2 Verifying Propagation Queue Type

DBMS_AQADM.VERIFY_QUEUE_TYPES verifies that the source and destination queues have identical types. The result of the verification is stored in the dictionary table SYS.AQ\$MESSAGE_TYPES, overwriting all previous output of this command.

```

DBMS_AQADM.VERIFY_QUEUE_TYPES(
  src_queue_name  IN  VARCHAR2,
  dest_queue_name IN  VARCHAR2,
  destination     IN  VARCHAR2 DEFAULT NULL,
  rc              OUT BINARY_INTEGER);

```

If the source and destination queues do not have identical types and a transformation was specified, then the transformation must map the source queue type to the destination queue type.

Note:

- SYS.AQ\$MESSAGE_TYPES can have multiple entries for the same source queue, destination queue, and database link, but with different transformations.
- VERIFY_QUEUE_TYPES check happens once per AQ propagation schedule and *not* for every propagated message send
- In case the payload of the queue is modified then the existing propagation schedule between source and destination queue needs to be dropped and recreated.

Example 8-51 involves two queues of the same type. It returns:

```

VQT: new style queue
Compatible: 1

```

If the same example is run with test.raw_queue (a queue of type RAW) in place of test.another_queue, then it returns:

```
VQT: new style queue  
Compatible: 0
```

Example 8-51 Verifying a Queue Type

```
SET SERVEROUTPUT ON  
DECLARE  
rc      BINARY_INTEGER;  
BEGIN  
  DBMS_AQADM.VERIFY_QUEUE_TYPES(  
    src_queue_name => 'test.multiconsumer_queue',  
    dest_queue_name => 'test.another_queue',  
    rc              => rc);  
  DBMS_OUTPUT.PUT_LINE('Compatible: '||rc);  
END;  
/
```

8.7.3 Altering a Propagation Schedule

DBMS_AQADM.ALTER_PROPAGATION_SCHEDULE alters parameters for a propagation schedule. The `destination_queue` parameter for queue-to-queue propagation cannot be altered.

```
DBMS_AQADM.ALTER_PROPAGATION_SCHEDULE(  
  queue_name      IN  VARCHAR2,  
  destination     IN  VARCHAR2 DEFAULT NULL,  
  duration        IN  NUMBER   DEFAULT NULL,  
  next_time       IN  VARCHAR2 DEFAULT NULL,  
  latency         IN  NUMBER   DEFAULT 60,  
  destination_queue IN  VARCHAR2 DEFAULT NULL);
```

Example 8-52 Altering a Propagation Schedule to Queues in the Same Database

```
BEGIN  
  DBMS_AQADM.ALTER_PROPAGATION_SCHEDULE(  
    queue_name => 'test.multiconsumer_queue',  
    duration   => '2000',  
    next_time  => 'SYSDATE + 3600/86400',  
    latency    => '32');  
END;  
/
```

Example 8-53 Altering a Propagation Schedule to Queues in Another Database

```
BEGIN  
  DBMS_AQADM.ALTER_PROPAGATION_SCHEDULE(  
    queue_name  => 'test.multiconsumer_queue',  
    destination => 'another_db.world',  
    duration    => '2000',  
    next_time   => 'SYSDATE + 3600/86400',  
    latency     => '32');  
END;  
/
```

8.7.4 Enabling a Propagation Schedule

`DBMS_AQADM.ENABLE_PROPAGATION_SCHEDULE` enables a previously disabled propagation schedule.

```
DBMS_AQADM.ENABLE_PROPAGATION_SCHEDULE(  
    queue_name      IN   VARCHAR2,  
    destination     IN   VARCHAR2 DEFAULT NULL,  
    destination_queue IN  VARCHAR2 DEFAULT NULL);
```

Example 8-54 Enabling a Propagation to Queues in the Same Database

```
BEGIN  
    DBMS_AQADM.ENABLE_PROPAGATION_SCHEDULE(  
        queue_name => 'test.multiconsumer_queue');  
END;  
/
```

Example 8-55 Enabling a Propagation to Queues in Another Database

```
BEGIN  
    DBMS_AQADM.ENABLE_PROPAGATION_SCHEDULE(  
        queue_name => 'test.multiconsumer_queue',  
        destination => 'another_db.world');  
END;  
/
```

8.7.5 Disabling a Propagation Schedule

`DBMS_AQADM.DISABLE_PROPAGATION_SCHEDULE` disables a previously enabled propagation schedule.

```
DBMS_AQADM.DISABLE_PROPAGATION_SCHEDULE(  
    queue_name      IN   VARCHAR2,  
    destination     IN   VARCHAR2 DEFAULT NULL,  
    destination_queue IN  VARCHAR2 DEFAULT NULL);
```

Example 8-56 Disabling a Propagation to Queues in the Same Database

```
BEGIN  
    DBMS_AQADM.DISABLE_PROPAGATION_SCHEDULE(  
        queue_name => 'test.multiconsumer_queue');  
END;  
/
```

Example 8-57 Disabling a Propagation to Queues in Another Database

```
BEGIN  
    DBMS_AQADM.DISABLE_PROPAGATION_SCHEDULE(  
        queue_name => 'test.multiconsumer_queue',  
        destination => 'another_db.world');  
END;  
/
```

8.7.6 Unsheduling a Queue Propagation

`DBMS_AQADM.UNSCHEDULE_PROPAGATION` unschedules a previously scheduled propagation of messages from a queue to a destination. The destination is identified by a specific

database link in the `destination` parameter or by name in the `destination_queue` parameter.

```
DBMS_AQADM.UNSCHEDULE_PROPAGATION (
  queue_name      IN  VARCHAR2,
  destination     IN  VARCHAR2 DEFAULT NULL,
  destination_queue IN VARCHAR2 DEFAULT NULL);
```

Example 8-58 Unscheduling a Propagation to Queues in the Same Database

```
BEGIN
  DBMS_AQADM.UNSCHEDULE_PROPAGATION(
    queue_name => 'test.multiconsumer_queue');
END;
/
```

Example 8-59 Unscheduling a Propagation to Queues in Another Database

```
BEGIN
  DBMS_AQADM.UNSCHEDULE_PROPAGATION(
    queue_name  => 'test.multiconsumer_queue',
    destination => 'another_db.world');
END;
/
```

8.8 Managing Oracle Database Advanced Queuing Agents

These topics describe how to manage Oracle Database Advanced Queuing Agents.

- [Creating an Oracle Database Advanced Queuing Agent](#)
- [Altering an Oracle Database Advanced Queuing Agent](#)
- [Dropping an Oracle Database Advanced Queuing Agent](#)
- [Enabling Database Access](#)
- [Disabling Database Access](#)

8.8.1 Creating an Oracle Database Advanced Queuing Agent

`DBMS_AQADM.CREATE_AQ_AGENT` registers an agent for Oracle Database Advanced Queuing Internet access using HTTP protocols.

```
DBMS_AQADM.CREATE_AQ_AGENT (
  agent_name          IN VARCHAR2,
  certificate_location IN VARCHAR2 DEFAULT NULL,
  enable_http        IN BOOLEAN DEFAULT FALSE,
  enable_anyp        IN BOOLEAN DEFAULT FALSE);
```

The `SYS.AQ$INTERNET_USERS` view has a list of all Oracle Database Advanced Queuing Internet agents. When an agent is created, altered, or dropped, an LDAP entry is created for the agent if the following are true:

- `GLOBAL_TOPIC_ENABLED = TRUE`
- `certificate_location` is specified

8.8.2 Altering an Oracle Database Advanced Queuing Agent

`DBMS_AQADM.ALTER_AQ_AGENT` alters an agent registered for Oracle Database Advanced Queuing Internet access.

```
DBMS_AQADM.ALTER_AQ_AGENT (
  agent_name          IN VARCHAR2,
  certificate_location IN VARCHAR2 DEFAULT NULL,
  enable_http        IN BOOLEAN DEFAULT FALSE,
  enable_anyp        IN BOOLEAN DEFAULT FALSE);
```

When an Oracle Database Advanced Queuing agent is created, altered, or dropped, an LDAP entry is created for the agent if the following are true:

- `GLOBAL_TOPIC_ENABLED = TRUE`
- `certificate_location` is specified

8.8.3 Dropping an Oracle Database Advanced Queuing Agent

`DBMS_AQADM.DROP_AQ_AGENT` drops an agent that was previously registered for Oracle Database Advanced Queuing Internet access.

```
DBMS_AQADM.DROP_AQ_AGENT (
  agent_name IN VARCHAR2);
```

When an Oracle Database Advanced Queuing agent is created, altered, or dropped, an LDAP entry is created for the agent if the following are true:

- `GLOBAL_TOPIC_ENABLED = TRUE`
- `certificate_location` is specified

8.8.4 Enabling Database Access

`DBMS_AQADM.ENABLE_DB_ACCESS` grants an Oracle Database Advanced Queuing Internet agent the privileges of a specific database user. The agent should have been previously created using the `CREATE_AQ_AGENT` procedure.

```
DBMS_AQADM.ENABLE_DB_ACCESS (
  agent_name      IN VARCHAR2,
  db_username     IN VARCHAR2)
```

The `SYS.AQ$INTERNET_USERS` view has a list of all Oracle Database Advanced Queuing Internet agents and the names of the database users whose privileges are granted to them.

See Also:

Oracle Streams Concepts and Administration for information about secure queues

8.8.5 Disabling Database Access

DBMS_AQADM.DISABLE_DB_ACCESS revokes the privileges of a specific database user from an Oracle Database Advanced Queuing Internet agent. The agent should have been previously granted those privileges using the ENABLE_DB_ACCESS procedure.

```
DBMS_AQADM.DISABLE_DB_ACCESS (  
  agent_name          IN VARCHAR2,  
  db_username         IN VARCHAR2)
```



See Also:

Oracle Streams Concepts and Administration for information about secure queues

8.9 Adding an Alias to the LDAP Server

DBMS_AQADM.ADD_ALIAS_TO_LDAP adds an alias to the LDAP server.

```
DBMS_AQADM.ADD_ALIAS_TO_LDAP(  
  alias              IN VARCHAR2,  
  obj_location      IN VARCHAR2);
```

This call takes the name of an alias and the distinguished name of an Oracle Database Advanced Queuing object in LDAP, and creates the alias that points to the Oracle Database Advanced Queuing object. The alias is placed immediately under the distinguished name of the database server. The object to which the alias points can be a queue, an agent, or a [ConnectionFactory](#).



See Also:

Oracle Streams Concepts and Administration for information about secure queues

8.10 Deleting an Alias from the LDAP Server

DBMS_AQADM.DEL_ALIAS_FROM_LDAP removes an alias from the LDAP server.

```
DBMS_AQADM.DEL_ALIAS_FROM_LDAP(  
  alias IN VARCHAR2);
```

This call takes the name of an alias as the argument, and removes the alias entry in the LDAP server. It is assumed that the alias is placed immediately under the database server in the LDAP directory.

9

Oracle Database Advanced Queuing and Messaging Gateway Views

These topics describe the Oracle Database Advanced Queuing (AQ) administrative interface views and Oracle Messaging Gateway (MGW) views.

Note:

All views not detailed in the following sections are described in the *Oracle Database Reference*.

Oracle AQ Views

- [V\\$AQ_MESSAGE_CACHE_STAT](#): Memory Management for Sharded Queues
- [V\\$AQ_SHARDED_SUBSCRIBER_STAT](#): Sharded Queue Subscriber Statistics
- [V\\$AQ_MESSAGE_CACHE_ADVICE](#): Simulated Metrics
- [V\\$AQ_REMOTE_DEQUEUE_AFFINITY](#): Dequeue Affinity Instance List
- [DBA_QUEUE_TABLES](#): All Queue Tables in Database
- [USER_QUEUE_TABLES](#): Queue Tables in User Schema
- [ALL_QUEUE_TABLES](#): Queue Tables Accessible to the Current User
- [DBA_QUEUES](#): All Queues in Database
- [USER_QUEUES](#): Queues In User Schema
- [ALL_QUEUES](#): Queues for Which User Has Any Privilege
- [DBA_QUEUE_SCHEDULES](#): All Propagation Schedules
- [USER_QUEUE_SCHEDULES](#): Propagation Schedules in User Schema
- [QUEUE_PRIVILEGES](#): Queues for Which User Has Queue Privilege
- [AQ\\$<Queue_Table_Name>](#): Messages in Queue Table
- [AQ\\$<Queue_Table_Name_S>](#): Queue Subscribers
- [AQ\\$<Queue_Table_Name_R>](#): Queue Subscribers and Their Rules
- [DBA_QUEUE_SUBSCRIBERS](#): All Queue Subscribers in Database
- [USER_QUEUE_SUBSCRIBERS](#): Queue Subscribers in User Schema
- [ALL_QUEUE_SUBSCRIBERS](#): Subscribers for Queues Where User Has Queue Privileges
- [DBA_TRANSFORMATIONS](#): All Transformations
- [DBA_ATTRIBUTE_TRANSFORMATIONS](#): All Transformation Functions
- [USER_TRANSFORMATIONS](#): User Transformations

- USER_ATTRIBUTE_TRANSFORMATIONS: User Transformation Functions
- DBA_SUBSCR_REGISTRATIONS: All Subscription Registrations
- USER_SUBSCR_REGISTRATIONS: User Subscription Registrations
- AQ\$INTERNET_USERS: Oracle Database Advanced Queuing Agents Registered for Internet Access
- V\$AQ: Number of Messages in Different States in Database
- V\$BUFFERED_QUEUES: All Buffered Queues in the Instance.
- V\$BUFFERED_SUBSCRIBERS: Subscribers for All Buffered Queues in the Instance
- V\$BUFFERED_PUBLISHERS: All Buffered Publishers in the Instance
- V\$PERSISTENT_QUEUES: All Active Persistent Queues in the Instance
- V\$PERSISTENT_SUBSCRIBERS: All Active Subscribers of the Persistent Queues in the Instance
- V\$PERSISTENT_PUBLISHERS: All Active Publishers of the Persistent Queues in the Instance
- V\$PROPAGATION_SENDER: Buffer Queue Propagation Schedules on the Sending (Source) Side
- V\$PROPAGATION_RECEIVER: Buffer Queue Propagation Schedules on the Receiving (Destination) Side
- V\$SUBSCR_REGISTRATION_STATS: Diagnosability of Notifications
- V\$METRICGROUP: Information About the Metric Group
- V\$AQ_BACKGROUND_COORDINATOR: Performance Statistics for AQ's Master Background Coordinator Process (AQPC)
- V\$AQ_JOB_COORDINATOR: Performance Statistics per Coordinator
- V\$AQ_SERVER_POOL: Performance Statistics for all Servers
- V\$AQ_CROSS_INSTANCE_JOBS: Cross Process Jobs Description
- V\$AQ_NONDUR_REGISTRATIONS: Non-Durable Registrations
- V\$AQ_NOTIFICATION_CLIENTS: Secure OCI Client Connections
- V\$AQ_SUBSCRIBER_LOAD: Durable Subscribers
- V\$AQ_NONDUR_SUBSCRIBER: Non-Durable Subscribers
- V\$AQ_NONDUR_SUBSCRIBER_LWM: LWM of Non Durable Subscriber
- V\$AQ_MESSAGE_CACHE: Performance Statistics

Oracle Messaging Gateway Views

- MGW_GATEWAY: Configuration and Status Information
- MGW_AGENT_OPTIONS: Supplemental Options and Properties
- MGW_LINKS: Names and Types of Messaging System Links
- MGW_MQSERIES_LINKS: WebSphere MQ Messaging System Links
- MGW_TIBRV_LINKS: TIB/Rendezvous Messaging System Links
- MGW_FOREIGN_QUEUES: Foreign Queues

- [MGW_JOBS](#): Messaging Gateway Propagation Jobs
- [MGW_SUBSCRIBERS](#): Information for Subscribers
- [MGW_SCHEDULES](#): Information About Schedules

9.1 DBA_QUEUE_TABLES: All Queue Tables in Database

This view contains information about the owner instance for a queue table.

A queue table can contain multiple queues. In this case, each queue in a queue table has the same owner instance as the queue table. The `DBA_QUEUE_TABLES` columns are the same as those in `ALL_QUEUE_TABLES`.



See Also:

Oracle Database Reference for more information about `DBA_QUEUE_TABLES`.

9.2 USER_QUEUE_TABLES: Queue Tables in User Schema

This view is the same as `DBA_QUEUE_TABLES` with the exception that it only shows queue tables in the user's schema.

`USER_QUEUE_TABLES` does not contain a column for `OWNER`.



See Also:

Oracle Database Reference for more information about `USER_QUEUE_TABLES`.

9.3 ALL_QUEUE_TABLES: Queue Tables Accessible to the Current User

This view describes queue tables accessible to the current user.



See Also:

Oracle Database Reference for more information about `ALL_QUEUE_TABLES`.

9.4 DBA_QUEUES: All Queues in Database

The `DBA_QUEUES` view specifies operational characteristics for every queue in a database.

Its columns are the same as those `ALL_QUEUES`. Oracle Database 12c Release 1 (12.1) introduces a new column `SHARDED` with data type `VARCHAR2(5)`. The value for this column is `TRUE` for sharded queue, otherwise `FALSE`.

 **See Also:**

Oracle Database Reference for more information about `DBA_QUEUES`.

9.5 USER_QUEUES: Queues In User Schema

The `USER_QUEUES` view is the same as `DBA_QUEUES` with the exception that it only shows queues in the user's schema.

Oracle Database 12c Release 1 (12.1) introduces a new column `SHARDED` with data type `VARCHAR2(5)`. The value for this column is `TRUE` for sharded queue, otherwise `FALSE`.

 **See Also:**

Oracle Database Reference for more information about `USER_QUEUES`.

9.6 ALL_QUEUES: Queues for Which User Has Any Privilege

The `ALL_QUEUES` view describes all queues on which the current user has enqueue or dequeue privileges.

If the user has any Advanced Queuing system privileges, like `MANAGE ANY QUEUE`, `ENQUEUE ANY QUEUE` or `DEQUEUE ANY QUEUE`, this view describes all queues in the database. Oracle Database 12c Release 1 (12.1) introduces a new column `SHARDED` with data type `VARCHAR2(5)`. The value for this column is `TRUE` for sharded queue, otherwise `FALSE`.

 **See Also:**

Oracle Database Reference for more information about `ALL_QUEUES`.

9.7 DBA_QUEUE_SCHEDULES: All Propagation Schedules

The `DBA_QUEUE_SCHEDULES` view describes all the current schedules in the database for propagating messages.

 **See Also:**

Oracle Database Reference for more information about `DBA_QUEUE_SCHEDULES`.

9.8 USER_QUEUE_SCHEDULES: Propagation Schedules in User Schema

The `USER_QUEUE_SCHEDULES` view is the same as `DBA_QUEUE_SCHEDULES` with the exception that it only shows queue schedules in the user's schema.

 **See Also:**

Oracle Database Reference for more information about `USER_QUEUE_SCHEDULES`.

9.9 QUEUE_PRIVILEGES: Queues for Which User Has Queue Privilege

The `QUEUE_PRIVILEGES` view describes queues for which the user is the grantor, grantee, or owner.

It also shows queues for which an enabled role on the queue is granted to `PUBLIC`.

 **See Also:**

Oracle Database Reference for more information about `QUEUE_PRIVILEGES`.

9.10 AQ\$<Queue_Table_Name>: Messages in Queue Table

The `AQ$<Queue_Table_Name>` view describes the queue table in which message data is stored.

This view is automatically created with each queue table and should be used for querying the queue data. The dequeue history data (time, user identification and transaction identification) is only valid for single-consumer queues.

In a queue table that is created with the `compatible` parameter set to '8.1' or higher, messages that were not dequeued by the consumer are shown as "UNDELIVERABLE". You can dequeue these messages by `msgid`. If the Oracle Database Advanced Queuing queue process monitor is running, then the messages are eventually moved to an exception queue. You can dequeue these messages from the exception queue with an ordinary dequeue.

A multiconsumer queue table created without the `compatible` parameter, or with the `compatible` parameter set to '8.0', does not display the state of a message on a consumer basis, but only displays the global state of the message.

 **Note:**

Queues created in a queue table with `compatible` set to 8.0 (referred to in this guide as 8.0-style queues) are deprecated in Oracle Database Advanced Queuing 10g Release 2 (10.2). Oracle recommends that any new queues you create be 8.1-style or newer and that you migrate existing 8.0-style queues at your earliest convenience.

When a message is dequeued using the `REMOVE` mode, `DEQ_TIME`, `DEQ_USER_ID`, and `DEQ_TXN_ID` are updated for the consumer that dequeued the message.

You can use `MSGID` and `ORIGINAL_MSGID` to chain propagated messages. When a message with message identifier `m1` is propagated to a remote queue, `m1` is stored in the `ORIGINAL_MSGID` column of the remote queue.

Beginning with Oracle Database 10g, `AQ$Queue_Table_Name` includes buffered messages. For buffered messages, the value of `MSG_STATE` is one of the following:

- `IN MEMORY`
Buffered messages enqueued by a user
- `DEFERRED`
Buffered messages enqueued by a capture process
- `SPILED`
User-enqueued buffered messages that have been spilled to disk
- `DEFERRED SPILED`
Capture-enqueued buffered messages that have been spilled to disk
- `BUFFERED EXPIRED`
Expired buffered messages

For JMS Sharded Queues, the columns `RETRY_COUNT`, `EXCEPTION_QUEUE_OWNER`, `EXCEPTION_QUEUE`, `PROPAGATED_MSGID`, `SENDER_NAME`, `SENDER_ADDRESS`, `SENDER_PROTOCOL`, `ORIGINAL_MSGID`, `ORIGINAL_QUEUE_NAME`, `ORIGINAL_QUEUE_OWNER`, `EXPIRATION_REASON` are always `NULL`.

For JMS Sharded Queues, this view shows messages only for durable subscribers because non durable subscribers are session specific. The view returns data from the in-memory Sharded Queue message cache if available, otherwise from the values on disk. A user is required to be one of the following in order to query from `AQ$<queue_name>` view for Sharded Queues:

- user is the owner
- user has "dequeue" privilege on queue
- user has "dequeue any queue" privilege

The view has the following difference for Sharded Queues for 12c and future releases:

- MSG_PRIORITY is defined as NUMBER(38)
- MSG_STATE in a queue table does not have BUFFERED_EXPIRED hence the max length of UNDELIVERABLE is taken as length got MSG_STATE.
- EXPIRATION is defined as TIMESTAMP(6) WITH TIME ZONE in a queue table.
- USER_DATA column is defined using a decode on USERDATA_RAW and USERDATA_BLOB with UTL_RAW.CAST_TO_VARCHAR2.
- CONSUMER_NAME is defined as VARCHAR2(128)

Table 9-1 AQ\$<Queue_Table_Name> View

Column	Datatype	NULL	For JMS Sharded Queues 12c Release 1 (12.1)	Description
QUEUE	VARCHAR2(30)	-		Queue name
SHARD_ID	NUMBER	-		N/A for 11g
SUBSHARD_ID	NUMBER	-		N/A for 11g
MSG_ID	RAW(16)	NOT NULL		Unique identifier of the message
CORR_ID	VARCHAR2(128)	-		User-provided correlation identifier
MSG_PRIORITY	NUMBER	-	NUMBER(38)	Message priority
MSG_STATE	VARCHAR2(16)	-		Message state. 12c Release 1 (12.1) queue table doesnt have BUFFERED_EXPIRED. Hence for 12c Release 1 (12.1) the max length of UNDELIVERABLE is taken as length got MSG_STATE
DELAY	DATE	-		Time in date format at which the message in waiting state would become ready. Equals ENQUEUE_TIME + user specified DELAY
DELAY_TIMESTAMP	TIMESTAMP	-		Time as a timestamp format at which the message in waiting state would become ready. Equals ENQUEUE_TIMESTAMP + user specified DELAY
EXPIRATION	NUMBER	-	TIMESTAMP(6) WITH TIME ZONE	Number of seconds in which the message expires after being READY
RETENTION_TIMESTAMP	TIMESTAMP(6)	-		N/A for 11g
ENQ_TIME	DATE	-		Enqueue time
ENQ_TIMESTAMP	TIMESTAMP	-		Enqueue time

Table 9-1 (Cont.) AQ\$<Queue_Table_Name> View

Column	Datatype	NULL	For JMS Sharded Queues 12c Release 1 (12.1)	Description
ENQ_USER_ID	NUMBER	-		Enqueue user ID
ENQ_USER_ID (10.1 queue tables)	VARCHAR2(30)	-		Enqueue user name
ENQ_TXN_ID	VARCHAR2(30)	-		Enqueue transaction ID
DEQ_TIME	DATE	-		Dequeue time
DEQ_TIMESTAMP	TIMESTAMP	-		Dequeue time
DEQ_USER_ID	NUMBER	-		Dequeue user ID
DEQ_USER_ID (10.1 queue tables)	VARCHAR2(30)	-		Dequeue user name
DEQ_TXN_ID	VARCHAR2(30)	-		Dequeue transaction ID
RETRY_COUNT	NUMBER	-	NULL	Number of retries
EXCEPTION_QUEUE_OWNER	VARCHAR2(30)	-	NULL	Exception queue schema
EXCEPTION_QUEUE	VARCHAR2(30)	-	NULL	Exception queue name
USER_DATA	-	-		User data. USER_DATA column is defined using a decode on USERDATA_RAW and USERDATA_BLOB with UTL_RAW.CAST_TO_VARCHAR2 for 12c Release 1 (12.1).
SENDER_NAME	VARCHAR2(30)	-	NULL	Name of the agent enqueueing the message (valid only for 8.1-compatible queue tables)
SENDER_ADDRESS	VARCHAR2(1024)	-	NULL	Queue name and database name of the source (last propagating) queue (valid only for 8.1-compatible queue tables). The database name is not specified if the source queue is in the local database.
SENDER_PROTOCOL	NUMBER	-	NULL	Protocol for sender address (reserved for future use and valid only for 8.1-compatible queue tables)
ORIGINAL_MSGID	RAW(16)	-	NULL	Message ID of the message in the source queue (valid only for 8.1-compatible queue tables)
CONSUMER_NAME	VARCHAR2(30)	-	VARCHAR2(128)	Name of the agent receiving the message (valid only for 8.1-compatible multiconsumer queue tables)

Table 9-1 (Cont.) AQ\$<Queue_Table_Name> View

Column	Datatype	NULL	For JMS Sharded Queues 12c Release 1 (12.1)	Description
ADDRESS	VARCHAR2(1024)	-		Queue name and database link name of the agent receiving the message. The database link name is not specified if the address is in the local database. The address is NULL if the receiving agent is local to the queue (valid only for 8.1-compatible multiconsumer queue tables)
PROTOCOL	NUMBER	-		Protocol for address of receiving agent (valid only for 8.1-compatible queue tables)
PROPAGATED_MSGID	RAW(16)	-	NULL	Message ID of the message in the queue of the receiving agent (valid only for 8.1-compatible queue tables)
ORIGINAL_QUEUE_NAME	VARCHAR2(30)	-	NULL	Name of the queue the message came from
ORIGINAL_QUEUE_OWNER	VARCHAR2(30)	-	NULL	Owner of the queue the message came from
EXPIRATION_REASON	VARCHAR2(19)	-	NULL	Reason the message came into exception queue. Possible values are <code>TIME_EXPIRATION</code> (message expired after the specified expired time), <code>MAX_RETRY_EXCEEDED</code> (maximum retry count exceeded), and <code>PROPAGATION_FAILURE</code> (message became undeliverable during propagation).

 **Note:**

A message is moved to an exception queue if `RETRY_COUNT` is greater than `MAX_RETRIES`. If a dequeue transaction fails because the server process dies (including `ALTER SYSTEM KILL SESSION`) or `SHUTDOWN ABORT` on the instance, then `RETRY_COUNT` is not incremented.

9.11 AQ\$<Queue_Table_Name_S>: Queue Subscribers

The AQ\$<Queue_Table_Name_S> view provides information about subscribers for all the queues in any given queue table.

It shows subscribers created by users with DBMS_AQADM.ADD_SUBSCRIBER and subscribers created for the apply process to apply user-created events. It also displays the [transformation](#) for the [subscriber](#), if it was created with one. It is generated when the queue table is created.

This view provides functionality that is equivalent to the DBMS_AQADM.QUEUE_SUBSCRIBERS() procedure. For these queues, Oracle recommends that the view be used instead of this procedure to view queue subscribers. This view is created only for 8.1-compatible queue tables.

Table 9-2 AQ\$<Queue_Table_Name_S> View

Column	Datatype	NULL	Description
QUEUE	VARCHAR2(30)	NOT NULL	Name of queue for which subscriber is defined
NAME	VARCHAR2(30)	-	Name of agent
ADDRESS	VARCHAR2(1024)	-	Address of agent
PROTOCOL	NUMBER	-	Protocol of agent
TRANSFORMATION	VARCHAR2(61)	-	Name of the transformation (can be null)

9.12 AQ\$<Queue_Table_Name_R>: Queue Subscribers and Their Rules

The AQ\$<Queue_Table_Name_R> view displays only the subscribers based on rules for all queues in a given queue table, including the text of the rule defined by each subscriber.

It also displays the transformation for the subscriber, if one was specified. It is generated when the queue table is created.

This view is created only for 8.1-compatible queue tables.

Table 9-3 AQ\$<Queue_Table_Name_R> View

Column	Datatype	NULL	Description
QUEUE	VARCHAR2(30)	NOT NULL	Name of queue for which subscriber is defined
NAME	VARCHAR2(30)	-	Name of agent
ADDRESS	VARCHAR2(1024)	-	Address of agent
PROTOCOL	NUMBER	-	Protocol of agent
RULE	CLOB	-	Text of defined rule
RULE_SET	VARCHAR2(65)	-	Set of rules

Table 9-3 (Cont.) AQ\$<Queue_Table_Name_R> View

Column	Datatype	NULL	Description
TRANSFORMATION	VARCHAR2(61)	-	Name of the transformation (can be null)

9.13 AQ\$Queue_Name_R: Queue Subscribers and Their Rules for Multi-consumer Queue

This table shows queue subscribers and their rules for multi-consumer queue.

Table 9-4 AQ\$Queue_Name_R: Queue Subscribers and Their Rules for Multi-consumer Queue

Column	Datatype	NULL
QUEUE	VARCHAR2(30)	NOT NULL
NAME	VARCHAR2(30)	-
ADDRESS	VARCHAR2(1024)	-
PROTOCOL	NUMBER	-
RULE	CLOB	-
RULE_SET	VARCHAR2(65)	-
TRANSFORMATION	VARCHAR2(65)	-

9.14 AQ\$Queue_Name_S: Queue Subscribers and Their Rules for Multi-consumer Queue

This table shows queue subscribers and their rules for multi-consumer queue.

Table 9-5 AQ\$Queue_Name_S: Queue Subscribers and Their Rules for Multi-consumer Queue

Column	Datatype	NULL
QUEUE	VARCHAR2(30)	NOT NULL
NAME	VARCHAR2(30)	-
ADDRESS	VARCHAR2(1024)	-
PROTOCOL	NUMBER	-
TRANSFORMATION	VARCHAR2(65)	-
QUEUE_TO_QUEUE	VARCHAR2(5)	-

9.15 DBA_QUEUE_SUBSCRIBERS: All Queue Subscribers in Database

The `DBA_QUEUE_SUBSCRIBERS` view returns a list of all subscribers on all queues in the database.

Its columns are the same as those in `ALL_QUEUE_SUBSCRIBERS`.

 **See Also:**

Oracle Database Reference for more information about `DBA_QUEUE_SUBSCRIBERS`.

9.16 USER_QUEUE_SUBSCRIBERS: Queue Subscribers in User Schema

The `USER_QUEUE_SUBSCRIBERS` view returns a list of subscribers on queues in the schema of the current user.

Its columns are the same as those in `ALL_QUEUE_SUBSCRIBERS` except that it does not contain the `OWNER` column.

 **See Also:**

Oracle Database Reference for more information about `USER_QUEUE_SUBSCRIBERS`.

9.17 ALL_QUEUE_SUBSCRIBERS: Subscribers for Queues Where User Has Queue Privileges

The `ALL_QUEUE_SUBSCRIBERS` view returns a list of subscribers to queues that the current user has privileges to dequeue from.

 **See Also:**

Oracle Database Reference for more information about `ALL_QUEUE_SUBSCRIBERS`.

9.18 DBA_TRANSFORMATIONS: All Transformations

The `DBA_TRANSFORMATIONS` view displays all the transformations in the database.

These transformations can be specified with Advanced Queue operations like `enqueue`, `dequeue` and `subscribe` to automatically integrate transformations in messaging. This view is accessible only to users having DBA privileges.

 **See Also:**

Oracle Database Reference for more information about `DBA_TRANSFORMATIONS`.

9.19 DBA_ATTRIBUTE_TRANSFORMATIONS: All Transformation Functions

The `DBA_ATTRIBUTE_TRANSFORMATIONS` view displays the transformation functions for all the transformations in the database.

 **See Also:**

Oracle Database Reference for more information about `DBA_ATTRIBUTE_TRANSFORMATIONS`.

9.20 USER_TRANSFORMATIONS: User Transformations

The `USER_TRANSFORMATIONS` view displays all the transformations owned by the user.

To view the transformation definition, query `USER_ATTRIBUTE_TRANSFORMATIONS`.

 **See Also:**

Oracle Database Reference for more information about `USER_TRANSFORMATIONS`.

9.21 USER_ATTRIBUTE_TRANSFORMATIONS: User Transformation Functions

The `USER_ATTRIBUTE_TRANSFORMATIONS` view displays the transformation functions for all the transformations of the user.

 **See Also:**

Oracle Database Reference for more information about `USER_ATTRIBUTE_TRANSFORMATIONS`.

9.22 DBA_SUBSCR_REGISTRATIONS: All Subscription Registrations

The `DBA_SUBSCR_REGISTRATIONS` view lists all the subscription registrations in the database.

 **See Also:**

Oracle Database Reference for more information about `DBA_SUBSCR_REGISTRATIONS`.

9.23 USER_SUBSCR_REGISTRATIONS: User Subscription Registrations

The `USER_SUBSCR_REGISTRATIONS` view lists the subscription registrations in the database for the current user.

Its columns are the same as those in `DBA_SUBSCR_REGISTRATIONS`.

 **See Also:**

Oracle Database Reference for more information about `USER_SUBSCR_REGISTRATIONS`.

9.24 AQ\$INTERNET_USERS: Oracle Database Advanced Queuing Agents Registered for Internet Access

The `AQ$INTERNET_USERS` view provides information about the agents registered for Internet access to Oracle Database Advanced Queuing. It also provides the list of database users that each Internet agent maps to.

Table 9-6 AQ\$INTERNET_USERS View

Column	Datatype	NULL	Description
AGENT_NAME	VARCHAR2(30)	-	Name of the Oracle Database Advanced Queuing Internet agent
DB_USERNAME	VARCHAR2(30)	-	Name of database user that this Internet agent maps to
HTTP_ENABLED	VARCHAR2(4)	-	Indicates whether this agent is allowed to access Oracle Database Advanced Queuing through HTTP (YES or NO)
FTP_ENABLED	VARCHAR2(4)	-	Indicates whether this agent is allowed to access Oracle Database Advanced Queuing through FTP (always NO in current release)

9.25 V\$AQ: Number of Messages in Different States in Database

The `V$AQ` view provides information about the number of messages in different states for the whole database.

In a Oracle Real Application Clusters environment, each instance keeps its own Oracle Database Advanced Queuing statistics information in its own System Global Area (SGA), and does not have knowledge of the statistics gathered by other instances. When a `GV$AQ` view is queried by an instance, all other instances funnel their Oracle Database Advanced Queuing statistics information to the instance issuing the query.

See Also:

Oracle Database Reference for more information about `V$AQ`.

9.26 V\$BUFFERED_QUEUES: All Buffered Queues in the Instance

The `V$BUFFERED_QUEUES` view displays information about all buffered queues in the instance. There is one row per queue.



See Also:

Oracle Database Reference for more information about `V$BUFFERED_QUEUES`.

9.27 V\$BUFFERED_SUBSCRIBERS: Subscribers for All Buffered Queues in the Instance

The `V$BUFFERED_SUBSCRIBERS` view displays information about the subscribers for all buffered queues in the instance. There is one row per subscriber per queue.



See Also:

Oracle Database Reference for more information about `V$BUFFERED_SUBSCRIBERS`.

9.28 V\$BUFFERED_PUBLISHERS: All Buffered Publishers in the Instance

The `V$BUFFERED_PUBLISHERS` view displays information about all buffered publishers in the instance.

There is one row per queue per sender. The values are reset to zero when the database (or instance in an Oracle RAC environment) restarts.



See Also:

Oracle Database Reference for more information about `V$BUFFERED_PUBLISHERS`.

9.29 V\$PERSISTENT_QUEUES: All Active Persistent Queues in the Instance

The `V$PERSISTENT_QUEUES` view displays information about all active persistent queues in the database since the queues' first activity time.

There is one row per queue. The rows are deleted when the database (or instance in an Oracle RAC environment) restarts.

See Also:

Oracle Database Reference for more information about `V$PERSISTENT_QUEUES`.

9.30 V\$PERSISTENT_QMN_CACHE: Performance Statistics on Background Tasks for Persistent Queues

The `V$PERSISTENT_QMN_CACHE` view displays detailed statistics about all background activities relating to all queue tables in the database.

There is one row per queue table. The values are reset when the database (or instance in an Oracle RAC environment) restarts.

See Also:

Oracle Database Reference for more information about `V$PERSISTENT_QMN_CACHE`.

9.31 V\$PERSISTENT_SUBSCRIBERS: All Active Subscribers of the Persistent Queues in the Instance

The `V$PERSISTENT_SUBSCRIBERS` view displays information about all active subscribers of the persistent queues in the database.

There is one row per instance per queue per subscriber. The rows are deleted when the database (or instance in an Oracle RAC environment) restarts.

See Also:

Oracle Database Reference for more information about `V$PERSISTENT_SUBSCRIBERS`.

9.32 V\$PERSISTENT_PUBLISHERS: All Active Publishers of the Persistent Queues in the Instance

The `V$PERSISTENT_PUBLISHERS` view displays information about all active publishers of the persistent queues in the database.

There is one row per instance per queue per publisher. The rows are deleted when the database (or instance in an Oracle RAC environment) restarts.

 **See Also:**

Oracle Database Reference for more information about `V$PERSISTENT_PUBLISHERS`.

9.33 V\$PROPAGATION_SENDER: Buffer Queue Propagation Schedules on the Sending (Source) Side

The `V$PROPAGATION_SENDER` view displays information about buffer queue propagation schedules on the sending (source) side.

The values are reset to zero when the database (or instance in a Oracle Real Application Clusters (Oracle RAC) environment) restarts, when propagation migrates to another instance, or when an unscheduled propagation is attempted.

 **See Also:**

Oracle Database Reference for more information about `V$PROPAGATION_SENDER`.

9.34 V\$PROPAGATION_RECEIVER: Buffer Queue Propagation Schedules on the Receiving (Destination) Side

The `V$PROPAGATION_RECEIVER` view displays information about buffer queue propagation schedules on the receiving (destination) side.

The values are reset to zero when the database (or instance in a Oracle Real Application Clusters (Oracle RAC) environment) restarts, when propagation migrates to another instance, or when an unscheduled propagation is attempted.

 **See Also:**

Oracle Database Reference for more information about `V$PROPAGATION_RECEIVER`.

9.35 V\$SUBSCR_REGISTRATION_STATS: Diagnosability of Notifications

The `V$SUBSCR_REGISTRATION_STATS` view provides information for diagnosability of notifications.

See Also:

Oracle Database Reference for more information about `V$SUBSCR_REGISTRATION_STATS`.

9.36 V\$METRICGROUP: Information About the Metric Group

This `V$METRICGROUP` view displays information about the metric group for each of the four major Streams components: capture, propagation, apply, and queue.

See Also:

Oracle Database Reference for more information about `V$METRICGROUP`.

9.37 V\$AQ_MESSAGE_CACHE_STAT: Memory Management for Sharded Queues

The `V$AQ_MESSAGE_CACHE_STAT` view displays statistics about memory management for sharded queues in `streams_pool` within the System Global Area (SGA). Sharded queue uses `streams_pool` in units of subshards. Thus columns of this view shows statistics at subshard level irrespective of the queue. This view shows statistics across all sharded queues.

Table 9-7 V\$AQ_MESSAGE_CACHE_STAT View

Column	Datatype	Description
INST_ID	NUMBER	The instance id of the sharded queue
NUM_EVICTED	NUMBER	Number of evicted subshards across all sharded queues
NUM_PREFETCHED	NUMBER	Number of subshards pre-fetched by AQ background Process
NUM_UNEVICTION	NUMBER	Number of subshards un-evicted by foreground process. (like dequeue process)

Table 9-7 (Cont.) V\$AQ_MESSAGE_CACHE_STAT View

Column	Datatype	Description
NUM_UNCACHED	NUMBER	Number of subshards stored as uncached.
NUM_TRACKED	NUMBER	Number of subshards which are actively tracking dequeue rates
NUM_CACHED	NUMBER	Number of subshards stored cached in memory
MAX_SUBSH_SIZE	NUMBER	Maximum subshard size seen till now, in terms of number of messages per subshard
MIN_SUBSH_SIZE	NUMBER	Minimum subshard size seen till now, in terms of number of messages per subshard
MEAN_SUBSH_SIZE	NUMBER	Mean subshard size seen till now, in terms of number of messages per subshard
AVG_EVICTION_RATE	NUMBER	Average number of subshard evicted per second
AVG_LOAD_RATE	NUMBER	Average number of subshards pre-fetched or un-evicted per second
AVG_EVICTION_TIME	NUMBER	Average time taken to evict one subshard (in milliseconds)
AVG_LOAD_TIME	NUMBER	Average time taken to un-evict one subshard (in milliseconds)
AVG_MISS_RATIO	NUMBER	Average ratio of number of foreground un-evictions versus background pre-fetch
AVG_THRASH_RATIO	NUMBER	Average ratio of number of subshard pre-fetched by background without dequeue attempt versus total number of subshards prefetched
CON_ID	NUMBER	The ID of the container to which the data pertains. Possible values include: <ul style="list-style-type: none"> 0: This value is used for rows containing data that pertain to the entire CDB. This value is also used for rows in non-CDBs. 1: This value is used for rows containing data that pertain to only the root n: Where n is the applicable container ID for the rows containing data

 **Note:**

Some of the above mentioned columns will be used by sharded queue memory advisor during analysis.

9.38 V\$AQ_SHARDED_SUBSCRIBER_STAT: Sharded Queue Subscriber Statistics

The V\$AQ_SHARDED_SUBSCRIBER_STAT view displays statistical information about the subscribers of sharded queues. This statistics is used by the memory advisor.

Table 9-8 V\$AQ_SHARDED_SUBSCRIBER_STAT View

Column	Datatype	Description
INST_ID	NUMBER	Instance Identifier
QUEUE_ID	NUMBER	Queue Identifier
SUBSCRIBER_ID	NUMBER	Subscriber Identifier
SHARD_ID	NUMBER	Shard Identifier
PRIORITY	NUMBER	Priority value of the shard
DEQUEUE_SUBSHARD	NUMBER	Last known dequeue position in this shard
ENQUEUED_MSGS	NUMBER	Number of enqueued messages
DEQUEUED_MSGS	NUMBER	Number of dequeued messages
ELAPSED_DEQUEUE_TIME	NUMBER	Amount of time spent performing dequeues (in seconds)
CPU_DEQUEUE_TIME	NUMBER	Actual amount of CPU time spent performing dequeues (in seconds)
DEQUEUE_RATE	NUMBER	Number of messages dequeued per second
TIME_SINCE_LAST_DEQUEUE	NUMBER	Time since last dequeue activity (in seconds)
ESTD_TIME_TO_DRAIN	NUMBER	Estimated amount of time to drain the shard (in seconds) with current enqueue and dequeue rates. Null, if enqueue rate is greater than dequeue rate
ESTD_TIME_TO_DRAIN_NO_ENQ	NUMBER	Estimated amount of time to drain the shard (in seconds) with no new enqueues
CON_ID	NUMBER	The ID of the container to which the data pertains.

9.39 V\$AQ_MESSAGE_CACHE_ADVICE: Simulated Metrics

The V\$AQ_MESSAGE_CACHE_ADVICE view shows simulated metrics for a range of potential message cache sizes. This view assists in cache sizing by providing information in form of metrics as described below.

Table 9-9 V\$AQ_MESSAGE_CACHE_ADVICE View

Column	Datatype	Description
INST_ID	NUMBER	Instance id
SIZE_FOR_ESTIMATE	NUMBER	Cache size for simulation (in megabytes)
SIZE_FACTOR	NUMBER	Size factor with respect to the current cache size (in %)

Table 9-9 (Cont.) V\$AQ_MESSAGE_CACHE_ADVICE View

Column	Datatype	Description
ESTD_SIZE_TYPE	VARCHAR2	This column can have one of the following values: <ul style="list-style-type: none"> MINIMUM - This cache size is required to have all dequeues in-memory (no uncached) CURRENT - This is current size of message cache MAXIMUM - This cache size is required to have zero evictions Null - otherwise
ESTD_CACHED_SUBSHARDS	NUMBER	Estimated number of cached subshards for this size
ESTD_UNCACHED_SUBSHARDS	NUMBER	Estimated number of uncached subshards for this size
ESTD_EVICTIONS	NUMBER	Estimated number of subshards evicted for this size
ESTD_EVICTION_RATE	NUMBER	Estimated number of subshards getting evicted per minute
ESTD_FG_UNEVICTIONS	NUMBER	Estimated number of subshards unevicted by foreground processes
ESTD_FG_UNEVICTION_RATE	NUMBER	Estimated number of subshards getting unevicted by foreground processes
ESTD_BG_UNEVICTIONS	NUMBER	Estimated number of subshards unevicted by background processes
ESTD_BG_UNEVICTION_RATE	NUMBER	Estimated number of subshards getting unevicted by background processes
ESTD_BG_PROCESSES	NUMBER	Estimated number of background processes required for this size
TOTAL_ENQUEUE_RATE	NUMBER	Simulated number of messages being enqueued per second
TOTAL_DEQUEUE_RATE	NUMBER	Simulated number of messages being dequeued per second
AVG_SUBSHARD_SIZE	NUMBER	Simulated average number of messages per cached subshard
AVG_SUBSHARD_MEMORY	NUMBER	Simulated average memory per cached subshard (in megabytes)
AVG_EVICTION_TIME	NUMBER	Simulated average time to evict a cached subshard (in milliseconds)
AVG_UNEVICTION_TIME	NUMBER	Simulated average time to unevict a cached subshard (in milliseconds)
FLAGS	NUMBER	Reserved for internal and future use
SIMULATION_TIME	NUMBER	Amount of time that was simulated for (in minutes)
CON_ID	NUMBER	The ID of the container to which the data pertains.

9.40 V\$AQ_REMOTE_DEQUEUE_AFFINITY: Dequeue Affinity Instance List

The V\$AQ_REMOTE_DEQUEUE_AFFINITY view lists the dequeue affinity instance of the subscribers not dequeuing locally from the shard's owner instance. Cross instance message forwarding is used for these subscribers.

Table 9-10 V\$AQ_REMOTE_DEQUEUE_AFFINITY View

Column	Datatype	Description
QUEUE_ID	NUMBER	Queue Identifier
QUEUE_SCHEMA	VARCHAR2	Queue schema name
QUEUE_NAME	VARCHAR2	Queue name
SUBSCRIBER_ID	NUMBER	Subscriber identifier
SHARD_ID	NUMBER	Shard identifier which is being forwarded from SOURCE_INSTANCE to INST_ID for the subscriber
SOURCE_INSTANCE	NUMBER	Owner instance from where the shard is being forwarded
INST_ID	NUMBER	Dequeue instance id of the subscriber for the shard. Destination instance where shard is forwarded for the subscriber

See Also:

Oracle Database Reference for more information about V\$AQ_REMOTE_DEQUEUE_AFFINITY.

9.41 V\$AQ_BACKGROUND_COORDINATOR: Performance Statistics for AQ's Master Background Coordinator Process (AQPC)

The V\$AQ_BACKGROUND_COORDINATOR view is applicable for Oracle Database 12c Release 1 (12.1) onwards.

This view lists performance statistics for the Oracle Database Advanced Queueing master background coordinator process (AQPC).

See Also:

Oracle Database Reference for more information about V\$AQ_BACKGROUND_COORDINATOR.

9.42 V\$AQ_JOB_COORDINATOR: Performance Statistics per Coordinator

The `V$AQ_JOB_COORDINATOR` view is applicable for Oracle Database 12c Release 1 (12.1) onwards.

This view lists performance statistics per coordinator, for every AQ coordinator controlled by the AQ's Master coordinator.

 **See Also::**

Oracle Database Reference for more information about `V$AQ_JOB_COORDINATOR`.

9.43 V\$AQ_SERVER_POOL: Performance Statistics for all Servers

The `V$AQ_SERVER_POOL` view is applicable for Oracle Database 12c Release 1 (12.1) onwards. This view lists performance statistics for all the servers in the pool.

 **See Also::**

Oracle Database Reference for more information about `V$AQ_SERVER_POOL`.

9.44 V\$AQ_CROSS_INSTANCE_JOBS: Cross Process Jobs Description

The `V$AQ_CROSS_INSTANCE_JOBS` view is applicable for Oracle Database 12c Release 1 (12.1) onwards. This view describes each of the cross process jobs.

Each job serves for forwarding messages for a shard from source instance to destination instance for a set of subscribers.

 **See Also::**

Oracle Database Reference for more information about `V$AQ_CROSS_INSTANCE_JOBS`.

9.45 V\$AQ_NONDUR_REGISTRATIONS: Non-Durable Registrations

The V\$AQ_NONDUR_REGISTRATIONS view is applicable for Oracle Database 12c Release 1 (12.1) onwards. This view provides information about non-durable subscriptions.

See Also::

Oracle Database Reference for more information about V\$AQ_NONDUR_REGISTRATIONS.

9.46 V\$AQ_NOTIFICATION_CLIENTS: Secure OCI Client Connections

The V\$AQ_NOTIFICATION_CLIENTS view is applicable for Oracle Database 12c Release 1 (12.1) onwards. This view displays performance statistics for secure OCI client connections.

See Also::

Oracle Database Reference for more information about V\$AQ_NOTIFICATION_CLIENTS.

9.47 V\$AQ_SUBSCRIBER_LOAD: Durable Subscribers

The V\$AQ_SUBSCRIBER_LOAD view is applicable for Oracle Database 12c Release 1 (12.1) onwards. This view describes the load of all subscribers of sharded queues in terms of latency at every instance in an Oracle RAC environment.

Latency denotes the predicted amount of time (in seconds) required from the current time to drain all the messages for that subscriber at each respective instance. The latency calculation considers past enqueue/dequeue rates and future enqueue/dequeue rates based on history.

See Also::

Oracle Database Reference for more information about V\$AQ_SUBSCRIBER_LOAD.

9.48 V\$AQ_NONDUR_SUBSCRIBER: Non-Durable Subscribers

The `V$AQ_NONDUR_SUBSCRIBER` view is applicable for Oracle Database 12c Release 1 (12.1) onwards. `V$AQ_NONDUR_SUBSCRIBER` provides information about non-durable subscribers on sharded queues.

See Also::

Oracle Database Reference for more information about `V$AQ_NONDUR_SUBSCRIBER`.

9.49 V\$AQ_NONDUR_SUBSCRIBER_LWM: LWM of Non Durable Subscriber

The `V$AQ_NONDUR_SUBSCRIBER_LWM` view is applicable for Oracle Database 12c Release 1 (12.1) onwards. The LWM of a non durable subscriber is a combination of shard, priority and LWM (sub-shard).

See Also::

Oracle Database Reference for more information about `V$AQ_NONDUR_SUBSCRIBER_LWM`.

9.50 V\$AQ_MESSAGE_CACHE: Performance Statistics

The `V$AQ_MESSAGE_CACHE` view provides performance statistics of the message cache for sharded queues at the subshard level in the instance.

See Also::

Oracle Database Reference for more information about `V$AQ_MESSAGE_CACHE`.

9.51 MGW_GATEWAY: Configuration and Status Information

This view lists configuration and status information for Messaging Gateway.

Table 9-11 MGW_GATEWAY View Properties

Name	Type	Description
AGENT_DATABASE	VARCHAR2	The database connect string used by the Messaging Gateway agent. NULL indicates that a local connection is used.
AGENT_INSTANCE	NUMBER	The database instance on which the Messaging Gateway agent is currently running. This should be NULL if the agent is not running.
AGENT_JOB	NUMBER	[Deprecated] Job number of the queued job used to start the Messaging Gateway agent process. The job number is set when Messaging Gateway is started and cleared when it shuts down.
AGENT_NAME	VARCHAR2	Name of the Messaging Gateway agent
AGENT_PING	VARCHAR2	Gateway agent ping status. Values: <ul style="list-style-type: none"> • NULL means no ping attempt was made. • REACHABLE means ping attempt was successful. • UNREACHABLE means ping attempt failed. AGENT_PING attempts to contact the Messaging Gateway agent. There is a short delay (up to 5 seconds) if the ping attempt fails. No ping is attempted if the AGENT_STATUS is NOT_STARTED or START_SCHEDULED.
AGENT_START_TIME	TIMESTAMP	The time when the Messaging Gateway agent job currently running was started. This should be NULL if the agent is not running.
AGENT_STATUS	VARCHAR2	Status of the Messaging Gateway agent. Values: <ul style="list-style-type: none"> • NOT_STARTED means the Messaging Gateway agent has not been started • START_SCHEDULED means Messaging Gateway agent has been scheduled to start. That is, Messaging Gateway has been started using DBMS_MGWADM.STARTUP, but the queued job used to start the Messaging Gateway agent has not yet run. • STARTING means Messaging Gateway agent is starting. That is, Messaging Gateway has been started using DBMS_MGWADM.STARTUP, the queued job has run, and the Messaging Gateway agent is starting up. • INITIALIZING means the Messaging Gateway agent has started and is initializing • RUNNING means the Messaging Gateway agent is running • SHUTTING_DOWN means the Messaging Gateway agent is shutting down • BROKEN means an unexpected condition has been encountered that prevents the Messaging Gateway agent from starting. DBMS_MGWADM.CLEANUP_GATEWAY must be called before the agent can be started.
AGENT_USER	VARCHAR2	Database user name used by the Messaging Gateway agent to connect to the database
COMMENTS	VARCHAR2	Comments for the agent
CONNTYPE	VARCHAR2	Connection type used by the agent: <ul style="list-style-type: none"> • JDBC_OCI if the JDBC OCI driver is used • JDBC_THIN if the JDBC Thin driver is used
INITFILE	VARCHAR2	Name of the Messaging Gateway initialization file used by the agent. NULL indicates that the default initialization file is used.

Table 9-11 (Cont.) MGW_GATEWAY View Properties

Name	Type	Description
LAST_ERROR_DATE	DATE	Date of last Messaging Gateway agent error. The last error information is cleared when Messaging Gateway is started. It is set if the Messaging Gateway agent fails to start or terminates due to an abnormal condition.
LAST_ERROR_MSG	VARCHAR2	Message for last Messaging Gateway agent error
LAST_ERROR_TIME	VARCHAR2	Time of last Messaging Gateway agent error
MAX_CONNECTIONS	NUMBER	[Deprecated] Maximum number of messaging connections to Oracle Database
MAX_MEMORY	NUMBER	Maximum heap size used by the Messaging Gateway agent (in MB)
MAX_THREADS	NUMBER	Maximum number of messaging threads created by the Messaging Gateway agent
SERVICE	VARCHAR2	Name of the database service that is associated with an Oracle Scheduler job class used by the agent

9.52 MGW_AGENT_OPTIONS: Supplemental Options and Properties

This view lists supplemental options and properties for a Messaging Gateway agent.

Table 9-12 MGW_AGENT_OPTIONS View

Column	Type	Description
AGENT_NAME	VARCHAR2	Name of the Messaging Gateway agent
ENCRYPTED	VARCHAR2	Indicates whether the value is stored as encrypted: <ul style="list-style-type: none"> TRUE if the value is stored encrypted FALSE if the value is stored as cleartext
NAME	VARCHAR2	Name of the option
TYPE	VARCHAR2	Option type or usage: JAVA_SYSTEM_PROP if the option is used to set a Java System property
VALUE	VARCHAR2	Value for the option. This will be <<ENCRYPTED>> if the value is stored in an encrypted form.

9.53 MGW_LINKS: Names and Types of Messaging System Links

This view lists the names and types of messaging system links currently defined.

Table 9-13 MGW_LINKS View Properties

Name	Type	Description
AGENT_NAME	VARCHAR2	Name of the Messaging Gateway agent that will process propagation jobs for this link
LINK_COMMENT	VARCHAR2	User comment for the link
LINK_NAME	VARCHAR2	Name of the messaging system link
LINK_TYPE	VARCHAR2	Type of messaging system link. Values <ul style="list-style-type: none"> MQSERIES is for WebSphere MQ links. TIBRV is for TIB/Rendezvous links.

9.54 MGW_MQSERIES_LINKS: WebSphere MQ Messaging System Links

This view lists information for the WebSphere MQ messaging system links. The view includes most of the messaging system properties specified when the link is created.

Table 9-14 MGW_MQSERIES_LINKS View Properties

Name	Type	Description
AGENT_NAME	VARCHAR2	Name of the Messaging Gateway agent that will process propagation jobs for this link
CHANNEL	VARCHAR2	Connection channel
HOSTNAME	VARCHAR2	Name of the WebSphere MQ host
INBOUND_LOG_QUEUE	VARCHAR2	Inbound propagation log queue
INTERFACE_TYPE	VARCHAR2	Messaging interface type. Values: <ul style="list-style-type: none"> BASE_JAVA is for WebSphere MQ Base Java interface JMS_CONNECTION is for WebSphere MQ JMS unified, domain-independent connections JMS_QUEUE_CONNECTION is for WebSphere MQ JMS queue connections JMS_TOPIC_CONNECTION is for WebSphere MQ JMS topic connections
LINK_COMMENT	VARCHAR2	User comment for the link
LINK_NAME	VARCHAR2	Name of the messaging system link
MAX_CONNECTIONS	NUMBER	Maximum number of messaging connections
OPTIONS	SYS.MGW_PROPERTIES	Link options
OUTBOUND_LOG_QUEUE	VARCHAR2	Outbound propagation log queue
PORT	NUMBER	Port number
QUEUE_MANAGER	VARCHAR2	Name of the WebSphere MQ queue manager

9.55 MGW_TIBRV_LINKS: TIB/Rendezvous Messaging System Links

This view lists information for TIB/Rendezvous messaging system links. The view includes most of the messaging system properties specified when the link was created.

Table 9-15 MGW_TIBRV_LINKS View Properties

Property Name	Type	Description
AGENT_NAME	VARCHAR2	Name of the Messaging Gateway agent that will process propagation jobs for this link
CM_LEDGER	VARCHAR2	TIB/Rendezvous CM ledger file name
CM_NAME	VARCHAR2	TIB/Rendezvous CM correspondent name
DAEMON	VARCHAR2	TIB/Rendezvous daemon parameter for RVD transport
LINK_COMMENT	VARCHAR2	User comment for the link
LINK_NAME	VARCHAR2	Name of the messaging system link
NETWORK	VARCHAR2	TIB/Rendezvous network parameter for rvd transport
OPTIONS	SYS.MGW_PROPERTYES	Link options
SERVICE	VARCHAR2	TIB/Rendezvous service parameter for rvd transport

9.56 MGW_FOREIGN_QUEUES: Foreign Queues

This view lists information for foreign queues. The view includes most of the queue properties specified when the queue is registered.

Table 9-16 MGW_FOREIGN_QUEUES View Properties

Name	Type	Description
DOMAIN	VARCHAR2	Queue domain type. Values: <ul style="list-style-type: none"> • NULL means the queue domain type is automatically determined by the messaging system • QUEUE is for a queue (point-to-point) model • TOPIC is for a topic (publish-subscribe) model
LINK_NAME	VARCHAR2	Name of the messaging system link
NAME	VARCHAR2	Name of the registered queue
OPTIONS	SYS.MGW_PROPERTIES	Optional queue properties
PROVIDER_QUEUE	VARCHAR2	Message provider (native) queue name
QUEUE_COMMENT	VARCHAR2	User comment for the foreign queue

9.57 MGW_JOBS: Messaging Gateway Propagation Jobs

This view lists information for Messaging Gateway propagation jobs. The view includes most of the job properties specified when the propagation job was created, as well as other status and statistical information.

Table 9-17 MGW_JOBS View

Column	Type	Description
AGENT_NAME	VARCHAR2	Name of the Messaging Gateway agent that processes this job
COMMENTS	VARCHAR2	Comments for the propagation job
DESTINATION	VARCHAR2	Destination queue to which messages are propagated
ENABLED	VARCHAR2	Indicates whether the job is enabled or not: <ul style="list-style-type: none"> • TRUE if the job is enabled • FALSE if the job is disabled
EXCEPTION_QUEUE	VARCHAR2	Exception queue used for propagation logging purposes
EXCEPTIONQ_MSGS	NUMBER	Option type or usage: JAVA_SYSTEM_PROP if the option is used to set a Java System property
FAILURES	NUMBER	Number of messages moved to exception queue since the last time the agent was started
JOB_NAME	VARCHAR2	Name of the propagation job
LAST_ERROR_MSG	VARCHAR2	Message for the last propagation error
LAST_ERROR_DATE	DATE	Date of the last propagation error
LAST_ERROR_TIME	VARCHAR2	Time of the last propagation error
LINK_NAME	VARCHAR2	Name of the Messaging Gateway link used by this job
OPTIONS	SYS.MGW_PROPERTIES	Job options
POLL_INTERVAL	INTEGER	Propagation poll interval (in seconds)
PROPAGATED_MSGS	NUMBER	Number of messages propagated since the last time the agent was started
PROP_STYLE	VARCHAR2	Message propagation style: <ul style="list-style-type: none"> • NATIVE for native message propagation • JMS for JMS message propagation
PROPAGATION_TYPE	VARCHAR2	Propagation type: <ul style="list-style-type: none"> • OUTBOUND is for Oracle Database AQ to non-Oracle propagation • INBOUND is for non-Oracle to Oracle Database AQ propagation
RULE	VARCHAR2	Subscription rule used for the propagation source
SOURCE	VARCHAR2	Source queue from which messages are propagated

Table 9-17 (Cont.) MGW_JOBS View

Column	Type	Description
STATUS	VARCHAR2	<p>Job status:</p> <ul style="list-style-type: none"> READY means the job is ready for propagation. The job must be enabled and the Messaging Gateway agent running before messages are actually propagated. RETRY means the agent encountered errors when attempting to propagate messages for the job and will retry the operation FAILED means the job has failed and agent has stopped trying to propagate messages. Usually this is due to an unrecoverable error or the propagation failure limit being reached. The job must be reset before the agent will attempt to propagate messages. The job is automatically reset each time the agent is started and can be manually reset by <code>DBMS_MGWADM.RESET_JOB</code>. DELETE_PENDING means that job removal is pending. <code>DBMS_MGWADM.REMOVE_JOB</code> has been called but certain cleanup tasks for this job are still outstanding. SUBSCRIBER_DELETE_PENDING means that removal is pending for the subscriber associated with the job. <code>DBMS_MGWADM.REMOVE_SUBSCRIBER</code> has been called but certain cleanup tasks are still outstanding.
TRANSFORMATION	VARCHAR2	Transformation used for message conversion

9.58 MGW_SUBSCRIBERS: Information for Subscribers

This view lists configuration and status information for Messaging Gateway subscribers. The view includes most of the subscriber properties specified when the subscriber is added, as well as other status and statistical information.

Table 9-18 MGW_SUBSCRIBERS View Properties

Name	Type	Description
DESTINATION	VARCHAR2	Destination queue to which messages are propagated
EXCEPTIONQ_MSGS	NUMBER	Number of messages moved to the propagation exception queue since the last time the agent was started
EXCEPTION_QUEUE	VARCHAR2	Exception queue used for logging purposes
FAILURES	NUMBER	Number of propagation failures
LAST_ERROR_DATE	DATE	Date of last propagation error
LAST_ERROR_MSG	VARCHAR2	Message for last propagation error
LAST_ERROR_TIME	VARCHAR2	Time of last propagation error
OPTIONS	<code>SYS.MGW_PROPERTIES</code>	Subscriber options
PROP_STYLE	VARCHAR2	<p>Message propagation style. Values:</p> <ul style="list-style-type: none"> NATIVE is for native message propagation JMS is for JMS message propagation
PROPAGATED_MSGS	NUMBER	Number of messages propagated to the destination queue since the last time the agent was started

Table 9-18 (Cont.) MGW_SUBSCRIBERS View Properties

Name	Type	Description
PROPAGATION_TYPE	VARCHAR2	Propagation type. Values: <ul style="list-style-type: none"> OUTBOUND is for Oracle Database AQ to non-Oracle propagation INBOUND is for non-Oracle to Oracle Database AQ propagation
QUEUE_NAME	VARCHAR2	Subscriber source queue
RULE	VARCHAR2	Subscription rule
STATUS	VARCHAR2	Subscriber status. Values: <ul style="list-style-type: none"> ENABLED means the subscriber is enabled DELETE_PENDING means subscriber removal is pending, usually because DBMS_MGWADM.REMOVE_SUBSCRIBER has been called but certain cleanup tasks pertaining to this subscriber are still outstanding
SUBSCRIBER_ID	VARCHAR2	Propagation subscriber identifier
TRANSFORMATION	VARCHAR2	Transformation used for message conversion

9.59 MGW_SCHEDULES: Information About Schedules

This view lists configuration and status information for Messaging Gateway schedules. The view includes most of the schedule properties specified when the schedule is created, as well as other status information.

Table 9-19 MGW_SCHEDULES View Properties

Name	Type	Description
DESTINATION	VARCHAR2	Propagation destination
LATENCY	NUMBER	Propagation window latency (in seconds)
NEXT_TIME	VARCHAR2	Reserved for future use
PROPAGATION_TYPE	VARCHAR2	Propagation type. Values: <ul style="list-style-type: none"> OUTBOUND is for Oracle Database AQ to non-Oracle propagation INBOUND is for non-Oracle to Oracle Database AQ propagation
PROPAGATION_WINDOW	NUMBER	Reserved for future use
SCHEDULE_DISABLED	VARCHAR2	Indicates whether the schedule is disabled. Y means the schedule is disabled. N means the schedule is enabled.
SCHEDULE_ID	VARCHAR2	Propagation schedule identifier
SOURCE	VARCHAR2	Propagation source
START_DATE	DATE	Reserved for future use
START_TIME	VARCHAR2	Reserved for future use

10

Oracle Database Advanced Queuing Operations Using PL/SQL

These topics describes the Oracle Database Advanced Queuing (AQ) PL/SQL operational interface.

- [Using Secure Queues](#)
- [Enqueuing Messages](#)
- [Enqueuing an Array of Messages](#)
- [Listening to One or More Queues](#)
- [Dequeuing Messages](#)
- [Dequeuing an Array of Messages](#)
- [Registering for Notification](#)
- [Posting for Subscriber Notification](#)
- [Adding an Agent to the LDAP Server](#)
- [Removing an Agent from the LDAP Server](#)

See Also:

- [Oracle Database Advanced Queuing: Programmatic Interfaces](#) for a list of available functions in each programmatic interface
- "DBMS_AQ" in *Oracle Database PL/SQL Packages and Types Reference* for more information on the PL/SQL interface
- *Oracle Database Advanced Queuing Java API Reference* for more information on the Java interface
- "More OCI Relational Functions" in *Oracle Call Interface Programmer's Guide*
- "OCI Programming Advanced Topics" in *Oracle Call Interface Programmer's Guide* for more information on the [Oracle Call Interface \(OCI\)](#)

10.1 Using Secure Queues

For secure queues, you must specify the `sender_id` in the `messages_properties` parameter.

See "MESSAGE_PROPERTIES_T Type" in *Oracle Database PL/SQL Packages and Types Reference* for more information about `sender_id`.

When you use secure queues, the following are required:

- You must have created a valid Oracle Database Advanced Queuing agent using `DBMS_AQADM.CREATE_AQ_AGENT`.
- You must map `sender_id` to a database user with enqueue privileges on the secure queue. Use `DBMS_AQADM.ENABLE_DB_ACCESS` to do this.

See Also:

- ["Creating an Oracle Database Advanced Queuing Agent"](#)
- ["Enabling Database Access"](#)
- *Oracle Streams Concepts and Administration* for information about secure queues

10.2 Enqueuing Messages

This procedure adds a message to the specified queue.

```
DBMS_AQ.ENQUEUE(
  queue_name      IN      VARCHAR2,
  enqueue_options IN      enqueue_options_t,
  message_properties IN    message_properties_t,
  payload         IN      "type_name",
  msgid          OUT     RAW);
```

It is not possible to update the `message` payload after a message has been enqueued. If you want to change the message payload, then you must dequeue the message and enqueue a new message.

To store a payload of type `RAW`, Oracle Database Advanced Queuing creates a [queue table](#) with `LOB` column as the payload repository. The maximum size of the payload is determined by which programmatic interface you use to access Oracle Database Advanced Queuing. For PL/SQL, Java and precompilers the limit is 32K; for the OCI the limit is 4G.

If a message is enqueued to a multiconsumer queue with no [recipient](#) and the [queue](#) has no subscribers (or rule-based subscribers that match this message), then Oracle error ORA 24033 is raised. This is a warning that the message will be discarded because there are no recipients or subscribers to whom it can be delivered.

If several messages are enqueued in the same second, then they all have the same `enq_time`. In this case the order in which messages are dequeued depends on `step_no`, a variable that is monotonically increasing for each message that has the same `enq_time`. There is no situation when both `enq_time` and `step_no` are the same for two messages enqueued in the same session.

Enqueue Options

The `enqueue_options` parameter specifies the options available for the enqueue operation. It has the following attributes:

- `visibility`

The `visibility` attribute specifies the transactional behavior of the enqueue request. `ON_COMMIT` (the default) makes the enqueue is part of the current transaction. `IMMEDIATE` makes the enqueue operation an autonomous transaction which commits at the end of the operation.

Do not use the `IMMEDIATE` option when you want to use `LOB` locators. `LOB` locators are valid only for the duration of the transaction. Your locator will not be valid, because the `immediate` option automatically commits the transaction.

You must set the `visibility` attribute to `IMMEDIATE` to use buffered messaging.

- `relative_msgid`

The `relative_msgid` attribute specifies the message identifier of the message referenced in the sequence deviation operation. This parameter is ignored unless `sequence_deviation` is specified with the `BEFORE` attribute.

- `sequence_deviation`

The `sequence_deviation` attribute specifies when the message should be dequeued, relative to other messages already in the queue. `BEFORE` puts the message ahead of the message specified by `relative_msgid`. `TOP` puts the message ahead of any other messages.

Specifying `sequence_deviation` for a message introduces some restrictions for the delay and priority values that can be specified for this message. The delay of this message must be less than or equal to the delay of the message before which this message is to be enqueued. The priority of this message must be greater than or equal to the priority of the message before which this message is to be enqueued.

Note:

The `sequence_deviation` attribute has no effect in releases prior to Oracle Database Advanced Queuing 10g Release 1 (10.1) if `message_grouping` is set to `TRANSACTIONAL`.

The sequence deviation feature is deprecated in Oracle Database Advanced Queuing 10g Release 2 (10.2).

- `transformation`

The `transformation` attribute specifies a transformation that will be applied before enqueueing the message. The return type of the transformation function must match the type of the queue.

- `delivery_mode`

If the `delivery_mode` attribute is the default `PERSISTENT`, then the message is enqueued as a persistent message. If it is set to `BUFFERED`, then the message is enqueued as an buffered message. Null values are not allowed.

Message Properties

The `message_properties` parameter contains the information that Oracle Database Advanced Queuing uses to manage individual messages. It has the following attributes:

- `priority`

The `priority` attribute specifies the priority of the message. It can be any number, including negative numbers. A smaller number indicates higher priority.

- `delay`

The `delay` attribute specifies the number of seconds during which a message is in the `WAITING` state. After this number of seconds, the message is in the `READY` state and available for dequeuing. If you specify `NO_DELAY`, then the message is available for immediate dequeuing. Dequeuing by `msgid` overrides the `delay` specification.

 **Note:**

Delay is not supported with buffered messaging.

- `expiration`

The `expiration` attribute specifies the number of seconds during which the message is available for dequeuing, starting from when the message reaches the `READY` state. If the message is not dequeued before it expires, then it is moved to the exception queue in the `EXPIRED` state. If you specify `NEVER`, then the message does not expire.

 **Note:**

Message delay and expiration are enforced by the queue monitor (QMN) background processes. You must start the QMN processes for the database if you intend to use the delay and expiration features of Oracle Database Advanced Queuing.

- `correlation`

The `correlation` attribute is an identifier supplied by the producer of the message at enqueue time.

- `attempts`

The `attempts` attribute specifies the number of attempts that have been made to dequeue the message. This parameter cannot be set at enqueue time.

- `recipient_list`

The `recipient_list` parameter is valid only for queues that allow multiple consumers. The default recipients are the queue subscribers.

- `exception_queue`

The `exception_queue` attribute specifies the name of the queue into which the message is moved if it cannot be processed successfully. If the exception queue specified does not exist at the time of the move, then the message is moved to the default exception queue associated with the queue table, and a warning is logged in the alert log.

- `delivery_mode`

Any value for `delivery_mode` specified in message properties at enqueue time is ignored. The value specified in enqueue options is used to set the delivery mode

of the message. If the delivery mode in enqueue options is left unspecified, then it defaults to persistent.

- `enqueue_time`

The `enqueue_time` attribute specifies the time the message was enqueued. This value is determined by the system and cannot be set by the user at enqueue time.

 **Note:**

Because information about seasonal changes in the system clock (switching between standard time and daylight-saving time, for example) is stored with each queue table, seasonal changes are automatically reflected in `enqueue_time`. If the system clock is changed for some other reason, then you must restart the database for Oracle Database Advanced Queuing to pick up the changed time.

- `state`

The `state` attribute specifies the state of the message at the time of the dequeue. This parameter cannot be set at enqueue time.

- `sender_id`

The `sender_id` attribute is an identifier of type `aq$_agent` specified at enqueue time by the message producer.

- `original_msgid`

The `original_msgid` attribute is used by Oracle Database AQ for propagating messages.

- `transaction_group`

The `transaction_group` attribute specifies the transaction group for the message. This attribute is set only by `DBMS_AQ.DEQUEUE_ARRAY`. This attribute cannot be used to set the transaction group of a message through `DBMS_AQ.ENQUEUE` or `DBMS_AQ.ENQUEUE_ARRAY`.

- `user_property`

The `user_property` attribute is optional. It is used to store additional information about the payload.

The examples in the following topics use the same users, message types, queue tables, and queues as do the examples in [Oracle Database Advanced Queuing Administrative Interface](#). If you have not already created these structures in your test environment, then you must run the following examples:

- [Example 8-1](#)
- [Example 8-2](#)
- [Example 8-3](#)
- [Example 8-5](#)
- [Example 8-7](#)
- [Example 8-8](#)
- [Example 8-23](#)

- [Example 8-25](#)
- [Example 8-26](#)
- [Example 8-27](#)
- [Example 8-28](#)
- [Example 8-36](#)

For [Example 8-1](#), you must connect as a user with administrative privileges. For the other examples in the preceding list, you can connect as user `test_adm`. After you have created the queues, you must start them as shown in "[Starting a Queue](#)". Except as noted otherwise, you can connect as ordinary queue user `'test'` to run all examples.

Enqueuing a LOB Type Message

[Example 10-3](#) creates procedure `blobenqueue()` using the `test.lob_type` message payload object type created in [Example 8-1](#). On enqueue, the LOB attribute is set to `EMPTY_BLOB`. After the enqueue completes, but before the transaction is committed, the LOB attribute is selected from the `user_data` column of the `test.lob_qtab` queue table. The LOB data is written to the queue using the `LOB` interfaces (which are available through both OCI and PL/SQL). The actual enqueue operation is shown in

On dequeue, the message payload will contain the LOB locator. You can use this LOB locator after the dequeue, but before the transaction is committed, to read the LOB data. This is shown in [Example 10-14](#).

Enqueuing Multiple Messages to a Single-Consumer Queue

[Example 10-5](#) enqueues six messages to `test.obj_queue`. These messages are dequeued in [Example 10-17](#).

Enqueuing Multiple Messages to a Multiconsumer Queue

[Example 10-6](#) requires that you connect as user `'test_adm'` to add subscribers `RED` and `GREEN` to queue `test.multiconsumer_queue`. The subscribers are required for [Example 10-7](#).

[Example 10-7](#) enqueues multiple messages from sender `001`. `MESSAGE 1` is intended for all queue subscribers. `MESSAGE 2` is intended for `RED` and `BLUE`. These messages are dequeued in [Example 10-17](#).

Enqueuing Grouped Messages

[Example 10-8](#) enqueues three groups of messages, with three messages in each group. These messages are dequeued in [Example 10-16](#).

Enqueuing a Message with Delay and Expiration

In [Example 10-9](#), an application wants a message to be dequeued no earlier than a week from now, but no later than three weeks from now. Because expiration is calculated from the earliest dequeue time, this requires setting the expiration time for two weeks.

Example 10-1 Enqueuing a Message, Specifying Queue Name and Payload

```
DECLARE
  enqueue_options    DBMS_AQ.enqueue_options_t;
  message_properties DBMS_AQ.message_properties_t;
  message_handle     RAW(16);
```

```

message          test.message_typ;
BEGIN
message := test.message_typ(001, 'TEST MESSAGE', 'First message to obj_queue');
DBMS_AQ.ENQUEUE(
  queue_name      => 'test.obj_queue',
  enqueue_options => enqueue_options,
  message_properties => message_properties,
  payload         => message,
  msgid          => message_handle);
  COMMIT;
END;
/

```

Example 10-2 Enqueuing a Message, Specifying Priority

```

DECLARE
  enqueue_options DBMS_AQ.enqueue_options_t;
  message_properties DBMS_AQ.message_properties_t;
  message_handle RAW(16);
  message test.order_typ;
BEGIN
message := test.order_typ(002, 'PRIORITY MESSAGE', 'priority 30');
message_properties.priority := 30;
DBMS_AQ.ENQUEUE(
  queue_name      => 'test.priority_queue',
  enqueue_options => enqueue_options,
  message_properties => message_properties,
  payload         => message,
  msgid          => message_handle);
  COMMIT;
END;
/

```

Example 10-3 Creating an Enqueue Procedure for LOB Type Messages

```

CREATE OR REPLACE PROCEDURE blobenqueue(msgno IN NUMBER) AS
  enq_userdata test.lob_typ;
  enq_msgid RAW(16);
  enqueue_options DBMS_AQ.enqueue_options_t;
  message_properties DBMS_AQ.message_properties_t;
  lob_loc BLOB;
  buffer RAW(4096);
BEGIN
  buffer := HEXTORAW(RPAD('FF', 4096, 'FF'));
  enq_userdata := test.lob_typ(msgno, 'Large Lob data', EMPTY_BLOB(), msgno);
  DBMS_AQ.ENQUEUE(
    queue_name      => 'test.lob_queue',
    enqueue_options => enqueue_options,
    message_properties => message_properties,
    payload         => enq_userdata,
    msgid          => enq_msgid);
  SELECT t.user_data.data INTO lob_loc
    FROM lob_qtab t
   WHERE t.msgid = enq_msgid;
  DBMS_LOB.WRITE(lob_loc, 2000, 1, buffer );
  COMMIT;
END;
/

```

Example 10-4 Enqueuing a LOB Type Message

```
BEGIN
  FOR i IN 1..5 LOOP
    blobenqueue(i);
  END LOOP;
END;
/
```

Example 10-5 Enqueuing Multiple Messages

```
SET SERVEROUTPUT ON
DECLARE
  enqueue_options    DBMS_AQ.enqueue_options_t;
  message_properties DBMS_AQ.message_properties_t;
  message_handle     RAW(16);
  message            test.message_typ;
BEGIN
  message := test.message_typ(001, 'ORANGE', 'ORANGE enqueued first.');
```

```
  DBMS_AQ.ENQUEUEE(
    queue_name          => 'test.obj_queue',
    enqueue_options    => enqueue_options,
    message_properties => message_properties,
    payload             => message,
    msgid               => message_handle);
  message := test.message_typ(001, 'ORANGE', 'ORANGE also enqueued second.');
```

```
  DBMS_AQ.ENQUEUEE(
    queue_name          => 'test.obj_queue',
    enqueue_options    => enqueue_options,
    message_properties => message_properties,
    payload             => message,
    msgid               => message_handle);
  message := test.message_typ(001, 'YELLOW', 'YELLOW enqueued third.');
```

```
  DBMS_AQ.ENQUEUEE(
    queue_name          => 'test.obj_queue',
    enqueue_options    => enqueue_options,
    message_properties => message_properties,
    payload             => message,
    msgid               => message_handle);
  message := test.message_typ(001, 'VIOLET', 'VIOLET enqueued fourth.');
```

```
  DBMS_AQ.ENQUEUEE(
    queue_name          => 'test.obj_queue',
    enqueue_options    => enqueue_options,
    message_properties => message_properties,
    payload             => message,
    msgid               => message_handle);
  message := test.message_typ(001, 'PURPLE', 'PURPLE enqueued fifth.');
```

```
  DBMS_AQ.ENQUEUEE(
    queue_name          => 'test.obj_queue',
    enqueue_options    => enqueue_options,
    message_properties => message_properties,
    payload             => message,
    msgid               => message_handle);
  message := test.message_typ(001, 'PINK', 'PINK enqueued sixth.');
```

```
  DBMS_AQ.ENQUEUEE(
    queue_name          => 'test.obj_queue',
    enqueue_options    => enqueue_options,
    message_properties => message_properties,
    payload             => message,
    msgid               => message_handle);
COMMIT;
```

```
END;
/
```

Example 10-6 Adding Subscribers RED and GREEN

```
DECLARE
    subscriber          sys.aq$_agent;
BEGIN
    subscriber          := sys.aq$_agent('RED', NULL, NULL);
    DBMS_AQADM.ADD_SUBSCRIBER(
        queue_name => 'test.multiconsumer_queue',
        subscriber => subscriber);

    subscriber          := sys.aq$_agent('GREEN', NULL, NULL);
    DBMS_AQADM.ADD_SUBSCRIBER(
        queue_name => 'test.multiconsumer_queue',
        subscriber => subscriber);
END;
/
```

Example 10-7 Enqueuing Multiple Messages to a Multiconsumer Queue

```
DECLARE
    enqueue_options    DBMS_AQ.enqueue_options_t;
    message_properties  DBMS_AQ.message_properties_t;
    recipients          DBMS_AQ.aq$_recipient_list_t;
    message_handle      RAW(16);
    message             test.message_typ;
BEGIN
    message := test.message_typ(001, 'MESSAGE 1', 'For queue subscribers');
    DBMS_AQ.ENQUEUE(
        queue_name          => 'test.multiconsumer_queue',
        enqueue_options     => enqueue_options,
        message_properties   => message_properties,
        payload             => message,
        msgid               => message_handle);

    message := test.message_typ(001, 'MESSAGE 2', 'For two recipients');
    recipients(1) := sys.aq$_agent('RED', NULL, NULL);
    recipients(2) := sys.aq$_agent('BLUE', NULL, NULL);
    message_properties.recipient_list := recipients;
    DBMS_AQ.ENQUEUE(
        queue_name          => 'test.multiconsumer_queue',
        enqueue_options     => enqueue_options,
        message_properties   => message_properties,
        payload             => message,
        msgid               => message_handle);
    COMMIT;
END;
/
```

Example 10-8 Enqueuing Grouped Messages

```
DECLARE
    enqueue_options    DBMS_AQ.enqueue_options_t;
    message_properties  DBMS_AQ.message_properties_t;
    message_handle      RAW(16);
    message             test.message_typ;
BEGIN
    FOR groupno in 1..3 LOOP
        FOR msgno in 1..3 LOOP
            message := test.message_typ(
```

```

        001,
        'GROUP ' || groupno,
        'Message ' || msgno || ' in group ' || groupno);
DBMS_AQ.ENQUEUE(
    queue_name           => 'test.group_queue',
    enqueue_options     => enqueue_options,
    message_properties   => message_properties,
    payload              => message,
    msgid               => message_handle);
END LOOP;
COMMIT;
END LOOP;
END;
/

```

Example 10-9 Enqueuing a Message, Specifying Delay and Expiration

```

DECLARE
    enqueue_options     DBMS_AQ.enqueue_options_t;
    message_properties  DBMS_AQ.message_properties_t;
    message_handle      RAW(16);
    message             test.message_typ;
BEGIN
    message := test.message_typ(001, 'DELAYED', 'Message is delayed one week.');
```

```

    message_properties.delay      := 7*24*60*60;
    message_properties.expiration := 2*7*24*60*60;
    DBMS_AQ.ENQUEUE(
        queue_name           => 'test.obj_queue',
        enqueue_options     => enqueue_options,
        message_properties   => message_properties,
        payload              => message,
        msgid               => message_handle);
    COMMIT;
END;
/

```

Example 10-10 Enqueuing a Message, Specifying a Transformation

```

DECLARE
    enqueue_options     DBMS_AQ.enqueue_options_t;
    message_properties  DBMS_AQ.message_properties_t;
    message_handle      RAW(16);
    message             test.message_typ;
BEGIN
    message := test.message_typ(001, 'NORMAL MESSAGE', 'enqueued to obj_queue');
```

```

    enqueue_options.transformation := 'message_order_transform';
    DBMS_AQ.ENQUEUE(
        queue_name           => 'test.priority_queue',
        enqueue_options     => enqueue_options,
        message_properties   => message_properties,
        payload              => message,
        msgid               => message_handle);
    COMMIT;
END;
/

```

10.3 Enqueuing an Array of Messages

Use the `ENQUEUE_ARRAY` function to enqueue an array of payloads using a corresponding array of message properties.

```
DBMS_AQ.ENQUEUE_ARRAY(
  queue_name           IN   VARCHAR2,
  enqueue_options     IN   enqueue_options_t,
  array_size          IN   PLS_INTEGER,
  message_properties_array IN message_properties_array_t,
  payload_array       IN   VARRAY,
  msgid_array         OUT  msgid_array_t)
RETURN PLS_INTEGER;
```

The output is an array of message identifiers of the enqueued messages. The function returns the number of messages successfully enqueued.

Array enqueueing is not supported for buffered messages, but you can still use `DBMS_AQ.ENQUEUE_ARRAY()` to enqueue buffered messages by setting `array_size` to 1.

The `message_properties_array` parameter is an array of message properties. Each element in the payload array must have a corresponding element in this record. All messages in an array have the same delivery mode.

The payload structure can be a `VARRAY` or nested table. The message IDs are returned into an array of `RAW(16)` entries of type `DBMS_AQ.msgid_array_t`.

As with array operations in the relational world, it is not possible to provide a single optimum array size that will be correct in all circumstances. Application developers must experiment with different array sizes to determine the optimal value for their particular applications.

See Also:

- ["Enqueue Options"](#)
- ["Message Properties"](#)

Example 10-11 Enqueuing an Array of Messages

```
DECLARE
  enqueue_options     DBMS_AQ.enqueue_options_t;
  msg_prop_array      DBMS_AQ.message_properties_array_t;
  msg_prop            DBMS_AQ.message_properties_t;
  payload_array       test.msg_table;
  msgid_array         DBMS_AQ.msgid_array_t;
  retval              PLS_INTEGER;
BEGIN
  payload_array := msg_table(
    message_typ(001, 'MESSAGE 1', 'array enqueued to obj_queue'),
    message_typ(001, 'MESSAGE 2', 'array enqueued to obj_queue'));
  msg_prop_array := DBMS_AQ.message_properties_array_t(msg_prop, msg_prop);

  retval := DBMS_AQ.ENQUEUE_ARRAY(
    queue_name           => 'test.obj_queue',
```

```

enqueue_options      => enqueue_options,
array_size           => 2,
message_properties_array => msg_prop_array,
payload_array        => payload_array,
msgid_array          => msgid_array);

COMMIT;
END;/

```

10.4 Listening to One or More Queues

This procedure specifies which queue or queues to monitor.

```

DBMS_AQ.LISTEN(
  agent_list          IN      aq$_agent_list_t,
  wait                IN      BINARY_INTEGER DEFAULT FOREVER,
  listen_delivery_mode IN    PLS_INTEGER DEFAULT PERSISTENT,
  agent               OUT     sys.aq$_agent
  message_delivery_mode OUT   PLS_INTEGER);

TYPE aq$_agent_list_t IS TABLE OF aq$_agent INDEXED BY BINARY_INTEGER;

```

This call takes a list of agents as an argument. Each agent is identified by a unique combination of name, address, and protocol.

You specify the queue to be monitored in the address field of each agent listed. Agents must have dequeue privileges on each monitored queue. You must specify the name of the agent when monitoring multiconsumer queues; but you must not specify an agent name for single-consumer queues. Only local queues are supported as addresses. Protocol is reserved for future use.

Note:

Listening to multiconsumer queues is not supported in the Java [API](#).

The `listen_delivery_mode` parameter specifies what types of message interest the agent. If it is the default `PERSISTENT`, then the agent is informed about persistent messages only. If it is set to `BUFFERED`, then the agent is informed about buffered messages only. If it is set to `PERSISTENT_OR_BUFFERED`, then the agent is informed about both types.

This is a blocking call that returns the agent and message type when there is a message ready for consumption for an agent in the list. If there are messages for more than one agent, then only the first agent listed is returned. If there are no messages found when the wait time expires, then an error is raised.

A successful return from the `listen` call is only an indication that there is a message for one of the listed agents in one of the specified queues. The interested agent must still dequeue the relevant message.

Note:

You cannot call `LISTEN` on [nonpersistent](#) queues.

Even though both `test.obj_queue` and `test.priority_queue` contain messages (enqueued in [Example 10-1](#) and [Example 10-2](#) respectively) [Example 10-12](#) returns only:

```
Message in Queue: "TEST"."OBJ_QUEUE"
```

If the order of agents in `test_agent_list` is reversed, so `test.priority_queue` appears before `test.obj_queue`, then the example returns:

```
Message in Queue: "TEST"."PRIORITY_QUEUE"
```



See Also:

["AQ Agent Type"](#)

Example 10-12 Listening to a Single-Consumer Queue with Zero Timeout

```
SET SERVEROUTPUT ON
DECLARE
    agent          sys.aq$_agent;
    test_agent_list DBMS_AQ.aq$_agent_list_t;
BEGIN
    test_agent_list(1) := sys.aq$_agent(NULL, 'test.obj_queue', NULL);
    test_agent_list(2) := sys.aq$_agent(NULL, 'test.priority_queue', NULL);
    DBMS_AQ.LISTEN(
        agent_list => test_agent_list,
        wait       => 0,
        agent      => agent);
    DBMS_OUTPUT.PUT_LINE('Message in Queue: ' || agent.address);
END;
/
```

10.5 Dequeuing Messages

This procedure dequeues a message from the specified queue.

```
DBMS_AQ.DEQUEUE(
    queue_name          IN          VARCHAR2,
    dequeue_options    IN          dequeue_options_t,
    message_properties OUT         message_properties_t,
    payload             OUT         "type_name",
    msgid              OUT         RAW);
```

You can choose to dequeue only persistent messages, only buffered messages, or both. See `delivery_mode` in the following list of dequeue options.



See Also:

["Message Properties"](#)

Dequeue Options

The `dequeue_options` parameter specifies the options available for the dequeue operation. It has the following attributes:

- `consumer_name`

A consumer can dequeue a message from a queue by supplying the name that was used in the `AQ$_AGENT` type of the `DBMS_AQADM.ADD_SUBSCRIBER` procedure or the recipient list of the message properties. If a value is specified, then only those messages matching `consumer_name` are accessed. If a queue is not set up for multiple consumers, then this field must be set to `NULL` (the default).
- `dequeue_mode`

The `dequeue_mode` attribute specifies the locking behavior associated with the dequeue. If `BROWSE` is specified, then the message is dequeued without acquiring any lock. If `LOCKED` is specified, then the message is dequeued with a write lock that lasts for the duration of the transaction. If `REMOVE` is specified, then the message is dequeued and deleted (the default). The message can be retained in the queue table based on the retention properties. If `REMOVE_NO_DATA` is specified, then the message is marked as updated or deleted.
- `navigation`

The `navigation` attribute specifies the position of the dequeued message. If `FIRST_MESSAGE` is specified, then the first available message matching the search criteria is dequeued. If `NEXT_MESSAGE` is specified, then the next available message matching the search criteria is dequeued (the default). If the previous message belongs to a message group, then the next available message matching the search criteria in the message group is dequeued.

If `NEXT_TRANSACTION` is specified, then any messages in the current transaction group are skipped and the first message of the next transaction group is dequeued. This setting can only be used if message grouping is enabled for the queue.
- `visibility`

The `visibility` attribute specifies when the new message is dequeued. If `ON_COMMIT` is specified, then the dequeue is part of the current transaction (the default). If `IMMEDIATE` is specified, then the dequeue operation is an autonomous transaction that commits at the end of the operation. The `visibility` attribute is ignored in `BROWSE` dequeue mode.

Visibility must always be `IMMEDIATE` when dequeuing messages with delivery mode `DBMS_AQ.BUFFERED` or `DBMS_AQ.PERSISTENT_OR_BUFFERED`.
- `wait`

The `wait` attribute specifies the wait time if there is currently no message available matching the search criteria. If a number is specified, then the operation waits that number of seconds. If `FOREVER` is specified, then the operation waits forever (the default). If `NO_WAIT` is specified, then the operation does not wait.
- `msgid`

The `msgid` attribute specifies the message identifier of the dequeued message. Only messages in the `READY` state are dequeued unless `msgid` is specified.
- `correlation`

The correlation attribute specifies the correlation identifier of the dequeued message. The correlation identifier cannot be changed between successive dequeue calls without specifying the `FIRST_MESSAGE` navigation option.

Correlation identifiers are application-defined identifiers that are not interpreted by Oracle Database Advanced Queuing. You can use special pattern matching characters, such as the percent sign and the underscore. If more than one message satisfies the pattern, then the order of dequeuing is indeterminate, and the sort order of the queue is not honored.

 **Note:**

Although dequeue options `correlation` and `deq_condition` are both supported for buffered messages, it is not possible to create indexes to optimize these queries.

- `deq_condition`

The `deq_condition` attribute is a Boolean expression similar to the WHERE clause of a SQL query. This Boolean expression can include conditions on message properties, user data properties (object payloads only), and PL/SQL or SQL functions.

To specify dequeue conditions on a message payload (object payload), use attributes of the object type in clauses. You must prefix each attribute with `tab.user_data` as a qualifier to indicate the specific column of the queue table that stores the payload.

The `deq_condition` attribute cannot exceed 4000 characters. If more than one message satisfies the dequeue condition, then the order of dequeuing is indeterminate, and the sort order of the queue is not honored.

- `transformation`

The `transformation` attribute specifies a transformation that will be applied after the message is dequeued but before returning the message to the caller.

- `delivery_mode`

The `delivery_mode` attribute specifies what types of messages to dequeue. If it is set to `DBMS_AQ.PERSISTENT`, then only persistent messages are dequeued. If it is set to `DBMS_AQ.BUFFERED`, then only buffered messages are dequeued.

If it is the default `DBMS_AQ.PERSISTENT_OR_BUFFERED`, then both persistent and buffered messages are dequeued. The `delivery_mode` attribute in the message properties of the dequeued message indicates whether the dequeued message was buffered or persistent.

The dequeue order is determined by the values specified at the time the queue table is created unless overridden by the message identifier and correlation identifier in dequeue options.

The database consistent read mechanism is applicable for queue operations. For example, a `BROWSE` call may not see a message that is enqueued after the beginning of the browsing transaction.

In a [commit-time queue](#), messages are not visible to `BROWSE` or `DEQUEUE` calls until a deterministic order can be established among them based on an [approximate CSCN](#).

If the `navigation` attribute of the `dequeue_conditions` parameter is `NEXT_MESSAGE` (the default), then subsequent dequeues retrieve messages from the queue based on the snapshot obtained in the first dequeue. A message enqueued after the first dequeue command, therefore, will be processed only after processing all remaining messages in the queue. This is not a problem if all the messages have already been enqueued or if the queue does not have priority-based ordering. But if an application must process the highest-priority message in the queue, then it must use the `FIRST_MESSAGE` navigation option.

 **Note:**

It can also be more efficient to use the `FIRST_MESSAGE` navigation option when there are messages being concurrently enqueued. If the `FIRST_MESSAGE` option is not specified, then Oracle Database Advanced Queuing continually generates the snapshot as of the first dequeue command, leading to poor performance. If the `FIRST_MESSAGE` option is specified, then Oracle Database Advanced Queuing uses a new snapshot for every dequeue command.

Messages enqueued in the same transaction into a queue that has been enabled for message grouping form a group. If only one message is enqueued in the transaction, then this effectively forms a group of one message. There is no upper limit to the number of messages that can be grouped in a single transaction.

In queues that have not been enabled for message grouping, a dequeue in `LOCKED` or `REMOVE` mode locks only a single message. By contrast, a dequeue operation that seeks to dequeue a message that is part of a group locks the entire group. This is useful when all the messages in a group must be processed as a unit.

When all the messages in a group have been dequeued, the dequeue returns an error indicating that all messages in the group have been processed. The application can then use `NEXT_TRANSACTION` to start dequeuing messages from the next available group. In the event that no groups are available, the dequeue times out after the period specified in the `wait` attribute of `dequeue_options`.

Typically, you expect the consumer of messages to access messages using the dequeue interface. You can view processed messages or messages still to be processed by browsing by message ID or by using `SELECT` commands.

Example 10-13 returns the message enqueued in **Example 10-1**. It returns:

```
From Sender No.1
Subject: TEST MESSAGE
Text: First message to obj_queue
```

 **See Also:**

- "Commit-Time Queues" in *Oracle Streams Concepts and Administration*
- "Dequeue Modes"

Dequeuing LOB Type Messages

[Example 10-14](#) creates procedure `blobdequeue()` to dequeue the LOB type messages enqueued in [Example 10-4](#). The actual dequeue is shown in [Example 10-15](#). It returns:

```
Amount of data read: 2000
Amount of data read: 2000
Amount of data read: 2000
Amount of data read: 2000
Amount of data read: 2000
```

Dequeuing Grouped Messages

You can dequeue the grouped messages enqueued in [Example 10-8](#) by running [Example 10-16](#). It returns:

```
GROUP 1: Message 1 in group 1
GROUP 1: Message 2 in group 1
GROUP 1: Message 3 in group 1
Finished GROUP 1
GROUP 2: Message 1 in group 2
GROUP 2: Message 2 in group 2
GROUP 2: Message 3 in group 2
Finished GROUP 2
GROUP 3: Message 1 in group 3
GROUP 3: Message 2 in group 3
GROUP 3: Message 3 in group 3
Finished GROUP 3
No more messages
```

Dequeuing from a Multiconsumer Queue

You can dequeue the messages enqueued for `RED` in [Example 10-7](#) by running [Example 10-17](#). If you change `RED` to `GREEN` and then to `BLUE`, you can use it to dequeue their messages as well. The output of the example will be different in each case.

`RED` is a subscriber to the multiconsumer queue and is also a specified recipient of `MESSAGE 2`, so it gets both messages:

```
Message: MESSAGE 1 .. For queue subscribers
Message: MESSAGE 2 .. For two recipients
No more messages for RED
```

`GREEN` is only a subscriber, so it gets only those messages in the queue for which no recipients have been specified (in this case, `MESSAGE 1`):

```
Message: MESSAGE 1 .. For queue subscribers
No more messages for GREEN
```

`BLUE`, while not a subscriber to the queue, is nevertheless specified to receive `MESSAGE 2`.

```
Message: MESSAGE 2 .. For two recipients
No more messages for BLUE
```

[Example 10-18](#) browses messages enqueued in [Example 10-5](#) until it finds `PINK`, which it removes. The example returns:

```
Browsed Message Text: ORANGE enqueued first.
Browsed Message Text: ORANGE also enqueued second.
```

```
Browsed Message Text: YELLOW enqueued third.
Browsed Message Text: VIOLET enqueued fourth.
Browsed Message Text: PURPLE enqueued fifth.
Browsed Message Text: PINK enqueued sixth.
Removed Message Text: PINK enqueued sixth.
```

Dequeue Modes

[Example 10-19](#) previews in locked mode the messages enqueued in [Example 10-5](#) until it finds PURPLE, which it removes. The example returns:

```
Locked Message Text: ORANGE enqueued first.
Locked Message Text: ORANGE also enqueued second.
Locked Message Text: YELLOW enqueued third.
Locked Message Text: VIOLET enqueued fourth.
Locked Message Text: PURPLE enqueued fifth.
Removed Message Text: PURPLE enqueued fifth.
```

Example 10-13 Dequeuing Object Type Messages

```
SET SERVEROUTPUT ON
DECLARE
dequeue_options    DBMS_AQ.dequeue_options_t;
message_properties DBMS_AQ.message_properties_t;
message_handle     RAW(16);
message            test.message_typ;
BEGIN
    dequeue_options.navigation := DBMS_AQ.FIRST_MESSAGE;
    DBMS_AQ.DEQUEUE(
        queue_name      => 'test.obj_queue',
        dequeue_options => dequeue_options,
        message_properties => message_properties,
        payload         => message,
        msgid           => message_handle);
    DBMS_OUTPUT.PUT_LINE('From Sender No.' || message.sender_id);
    DBMS_OUTPUT.PUT_LINE('Subject: ' || message.subject);
    DBMS_OUTPUT.PUT_LINE('Text: ' || message.text);
    COMMIT;
END;
/
```

Example 10-14 Creating a Dequeue Procedure for LOB Type Messages

```
CREATE OR REPLACE PROCEDURE blobdequeue(msgno IN NUMBER) AS
dequeue_options    DBMS_AQ.dequeue_options_t;
message_properties DBMS_AQ.message_properties_t;
msgid              RAW(16);
payload            test.lob_typ;
lob_loc            BLOB;
amount             BINARY_INTEGER;
buffer             RAW(4096);
BEGIN
    DBMS_AQ.DEQUEUE(
        queue_name      => 'test.lob_queue',
        dequeue_options => dequeue_options,
        message_properties => message_properties,
        payload         => payload,
        msgid           => msgid);
    lob_loc             := payload.data;
    amount              := 2000;
    DBMS_LOB.READ(lob_loc, amount, 1, buffer);
    DBMS_OUTPUT.PUT_LINE('Amount of data read: ' || amount);
```

```

    COMMIT;
END;
/

```

Example 10-15 Dequeuing LOB Type Messages

```

BEGIN
  FOR i IN 1..5 LOOP
    blobdequeue(i);
  END LOOP;
END;
/

```

Example 10-16 Dequeuing Grouped Messages

```

SET SERVEROUTPUT ON
DECLARE
  dequeue_options      DBMS_AQ.dequeue_options_t;
  message_properties   DBMS_AQ.message_properties_t;
  message_handle       RAW(16);
  message              test.message_typ;
  no_messages          exception;
  end_of_group         exception;
  PRAGMA EXCEPTION_INIT (no_messages, -25228);
  PRAGMA EXCEPTION_INIT (end_of_group, -25235);
BEGIN
  dequeue_options.wait      := DBMS_AQ.NO_WAIT;
  dequeue_options.navigation := DBMS_AQ.FIRST_MESSAGE;
  LOOP
    BEGIN
      DBMS_AQ.DEQUEUE(
        queue_name      => 'test.group_queue',
        dequeue_options => dequeue_options,
        message_properties => message_properties,
        payload         => message,
        msgid           => message_handle);
      DBMS_OUTPUT.PUT_LINE(message.subject || ' : ' || message.text );
      dequeue_options.navigation := DBMS_AQ.NEXT_MESSAGE;
    EXCEPTION
      WHEN end_of_group THEN
        DBMS_OUTPUT.PUT_LINE ('Finished ' || message.subject);
        COMMIT;
        dequeue_options.navigation := DBMS_AQ.NEXT_TRANSACTION;
      END;
    END LOOP;
  EXCEPTION
    WHEN no_messages THEN
      DBMS_OUTPUT.PUT_LINE ('No more messages');
END;
/

```

Example 10-17 Dequeuing Messages for RED from a Multiconsumer Queue

```

SET SERVEROUTPUT ON
DECLARE
  dequeue_options      DBMS_AQ.dequeue_options_t;
  message_properties   DBMS_AQ.message_properties_t;
  message_handle       RAW(16);
  message              test.message_typ;
  no_messages          exception;
  PRAGMA EXCEPTION_INIT (no_messages, -25228);
BEGIN

```

```

dequeue_options.wait          := DBMS_AQ.NO_WAIT;
dequeue_options.consumer_name := 'RED';
dequeue_options.navigation    := DBMS_AQ.FIRST_MESSAGE;
LOOP
BEGIN
  DBMS_AQ.DEQUEUE(
    queue_name          => 'test.multiconsumer_queue',
    dequeue_options    => dequeue_options,
    message_properties => message_properties,
    payload             => message,
    msgid               => message_handle);
  DBMS_OUTPUT.PUT_LINE('Message: ' || message.subject || ' .. ' || message.text );
  dequeue_options.navigation := DBMS_AQ.NEXT_MESSAGE;
END;
END LOOP;
EXCEPTION
  WHEN no_messages THEN
    DBMS_OUTPUT.PUT_LINE ('No more messages for RED');
COMMIT;
END;
/

```

Example 10-18 Dequeue in Browse Mode and Remove Specified Message

```

SET SERVEROUTPUT ON
DECLARE
  dequeue_options    DBMS_AQ.dequeue_options_t;
  message_properties DBMS_AQ.message_properties_t;
  message_handle     RAW(16);
  message            test.message_typ;
BEGIN
  dequeue_options.dequeue_mode := DBMS_AQ.BROWSE;
  LOOP
    DBMS_AQ.DEQUEUE(
      queue_name          => 'test.obj_queue',
      dequeue_options    => dequeue_options,
      message_properties => message_properties,
      payload             => message,
      msgid               => message_handle);
    DBMS_OUTPUT.PUT_LINE ('Browsed Message Text: ' || message.text);
    EXIT WHEN message.subject = 'PINK';
  END LOOP;
  dequeue_options.dequeue_mode := DBMS_AQ.REMOVE;
  dequeue_options.msgid        := message_handle;
  DBMS_AQ.DEQUEUE(
    queue_name          => 'test.obj_queue',
    dequeue_options    => dequeue_options,
    message_properties => message_properties,
    payload             => message,
    msgid               => message_handle);
  DBMS_OUTPUT.PUT_LINE('Removed Message Text: ' || message.text);
  COMMIT;
END;
/

```

Example 10-19 Dequeue in Locked Mode and Remove Specified Message

```

SET SERVEROUTPUT ON
DECLARE
  dequeue_options    DBMS_AQ.dequeue_options_t;
  message_properties DBMS_AQ.message_properties_t;

```



```

message_handle      RAW(16);
message             test.message_typ;
BEGIN
  dequeue_options.dequeue_mode := DBMS_AQ.LOCKED;
  LOOP
    DBMS_AQ.dequeue(
      queue_name      => 'test.obj_queue',
      dequeue_options => dequeue_options,
      message_properties => message_properties,
      payload         => message,
      msgid           => message_handle);
    DBMS_OUTPUT.PUT_LINE('Locked Message Text: ' || message.text);
    EXIT WHEN message.subject = 'PURPLE';
  END LOOP;
  dequeue_options.dequeue_mode := DBMS_AQ.REMOVE;
  dequeue_options.msgid        := message_handle;
  DBMS_AQ.DEQUEUE(
    queue_name      => 'test.obj_queue',
    dequeue_options => dequeue_options,
    message_properties => message_properties,
    payload         => message,
    msgid           => message_handle);
  DBMS_OUTPUT.PUT_LINE('Removed Message Text: ' || message.text);
  COMMIT;
END;
/

```

10.6 Dequeuing an Array of Messages

Use the `DEQUEUE_ARRAY` function to dequeue an array of payloads and a corresponding array of message properties.

```

DBMS_AQ.DEQUEUE_ARRAY(
  queue_name          IN      VARCHAR2,
  dequeue_options    IN      dequeue_options_t,
  array_size         IN      PLS_INTEGER,
  message_properties_array OUT message_properties_array_t,
  payload_array      OUT      VARRAY,
  msgid_array        OUT      msgid_array_t)
RETURN PLS_INTEGER;

```

The output is an array of payloads, message IDs, and message properties of the dequeued messages. The function returns the number of messages successfully dequeued.

Array dequeuing is not supported for buffered messages, but you can still use `DBMS_AQ.DEQUEUE_ARRAY()` to dequeue buffered messages by setting `array_size` to 1.

The payload structure can be a `VARRAY` or nested table. The message identifiers are returned into an array of `RAW(16)` entries of type `DBMS_AQ.msgid_array_t`. The message properties are returned into an array of type `DBMS_AQ.message_properties_array_t`.

As with array operations in the relational world, it is not possible to provide a single optimum array size that will be correct in all circumstances. Application developers must experiment with different array sizes to determine the optimal value for their particular applications.

All dequeue options available with `DBMS_AQ.DEQUEUE` are also available with `DBMS_AQ.DEQUEUE_ARRAY`. You can choose to dequeue only persistent messages, only

buffered messages, or both. In addition, the `navigation` attribute of `dequeue_options` offers two options specific to `DBMS_AQ.DEQUEUE_ARRAY`.

When dequeuing messages, you might want to dequeue all the messages for a transaction group with a single call. You might also want to dequeue messages that span multiple transaction groups. You can specify either of these methods by using one of the following navigation methods:

- `NEXT_MESSAGE_ONE_GROUP`
- `FIRST_MESSAGE_ONE_GROUP`
- `NEXT_MESSAGE_MULTI_GROUP`
- `FIRST_MESSAGE_MULTI_GROUP`

Navigation method `NEXT_MESSAGE_ONE_GROUP` dequeues messages that match the search criteria from the next available transaction group into an array. Navigation method `FIRST_MESSAGE_ONE_GROUP` resets the position to the beginning of the queue and dequeues all the messages in a single transaction group that are available and match the search criteria.

The number of messages dequeued is determined by an array size limit. If the number of messages in the transaction group exceeds `array_size`, then multiple calls to `DEQUEUE_ARRAY` must be made to dequeue all the messages for the transaction group.

Navigation methods `NEXT_MESSAGE_MULTI_GROUP` and `FIRST_MESSAGE_MULTI_GROUP` work like their `ONE_GROUP` counterparts, but they are not limited to a single transaction group. Each message that is dequeued into the array has an associated set of message properties. Message property `transaction_group` determines which messages belong to the same transaction group.

Example 10-20 dequeues the messages enqueued in **Example 10-11**. It returns:

```
Number of messages dequeued: 2
```



See Also:

["Dequeuing Messages"](#)

Example 10-20 Dequeuing an Array of Messages

```
SET SERVEROUTPUT ON
DECLARE
  dequeue_options      DBMS_AQ.dequeue_options_t;
  msg_prop_array       DBMS_AQ.message_properties_array_t :=
    DBMS_AQ.message_properties_array_t();
  payload_array        test.msg_table;
  msgid_array          DBMS_AQ.msgid_array_t;
  retval               PLS_INTEGER;
BEGIN
  retval := DBMS_AQ.DEQUEUE_ARRAY(
    queue_name          => 'test.obj_queue',
    dequeue_options     => dequeue_options,
    array_size          => 2,
    message_properties_array => msg_prop_array,
    payload_array       => payload_array,
    msgid_array         => msgid_array);
```

```
DBMS_OUTPUT.PUT_LINE('Number of messages dequeued: ' || retval);  
END;/
```

10.7 Registering for Notification

This procedure registers an e-mail address, user-defined PL/SQL procedure, or HTTP URL for message notification.

```
DBMS_AQ.REGISTER(  
  reg_list      IN SYS.AQ$_REG_INFO_LIST,  
  reg_count     IN NUMBER);
```

Note:

Starting from 12c Release 2 (12.2.), the maximum length of user-generated queue names is 122 bytes. See "[Creating a Queue](#)".

The `reg_list` parameter is a list of `SYS.AQ$REG_INFO` objects. You can specify notification quality of service with the `qosflags` attribute of `SYS.AQ$REG_INFO`.

The `reg_count` parameter specifies the number of entries in the `reg_list`. Each subscription requires its own `reg_list` entry. Interest in several subscriptions can be registered at one time.

When PL/SQL notification is received, the Oracle Database Advanced Queuing message properties descriptor that the callback is invoked with specifies the `delivery_mode` of the message notified as `DBMS_AQ.PERSISTENT` or `DBMS_AQ.BUFFERED`.

If you register for e-mail notifications, then you must set the host name and port name for the SMTP server that will be used by the database to send e-mail notifications. If required, you should set the send-from e-mail address, which is set by the database as the `sent from` field. You need a Java-enabled database to use this feature.

If you register for HTTP notifications, then you might want to set the host name and port number for the proxy server and a list of no-proxy domains that will be used by the database to post HTTP notifications.

An internal queue called `SYS.AQ_SRVNTFN_TABLE_Q` stores the notifications to be processed by the job queue processes. If notification fails, then Oracle Database Advanced Queuing retries the failed notification up to `MAX_RETRIES` attempts.

Note:

You can change the `MAX_RETRIES` and `RETRY_DELAY` properties of `SYS.AQ_SRVNTFN_TABLE_Q`. The new settings are applied across all notifications.

 See Also:

- ["AQ Registration Information Type"](#) for more information on SYS.AQ\$_REG_INFO objects
- ["AQ Notification Descriptor Type"](#) for more information on the message properties descriptor

Example 10-21 Registering for Notifications

```

DECLARE
    reginfo          sys.aq$_reg_info;
    reg_list         sys.aq$_reg_info_list;
BEGIN
    reginfo := sys.aq$_reg_info(
        'test.obj_queue',
        DBMS_AQ.NAMESPACE_ANONYMOUS,
        'http://www.company.com:8080',
        HEXTORAW('FF'));
    reg_list := sys.aq$_reg_info_list(reginfo);
    DBMS_AQ.REGISTER(
        reg_list      => reg_list,
        reg_count     => 1);
    COMMIT;
END;
/

```

10.8 Unregistering for Notification

This procedure unregisters an e-mail address, user-defined PL/SQL procedure, or HTTP URL for message notification.

```

DBMS_AQ.UNREGISTER(
    reg_list      IN SYS.AQ$_REG_INFO_LIST,
    reg_count     IN NUMBER);

```

10.9 Posting for Subscriber Notification

This procedure posts to a list of anonymous subscriptions, allowing all clients who are registered for the subscriptions to get notifications of persistent messages.

```

DBMS_AQ.POST(
    post_list     IN SYS.AQ$_POST_INFO_LIST,
    post_count    IN NUMBER);

```

This feature is not supported with buffered messages.

The `count` parameter specifies the number of entries in the `post_list`. Each posted subscription must have its own entry in the `post_list`. Several subscriptions can be posted to at one time.

The `post_list` parameter specifies the list of anonymous subscriptions to which you want to post. It has three attributes:

- `name`

The `name` attribute specifies the name of the anonymous subscription to which you want to post.

- `namespace`

The `namespace` attribute specifies the namespace of the subscription. To receive notifications from other applications through `DBMS_AQ.POST` the namespace must be `DBMS_AQ.NAMESPACE_ANONYMOUS`.

- `payload`

The `payload` attribute specifies the payload to be posted to the anonymous subscription. It is possible for no payload to be associated with this call.

This call provides a best-effort guarantee. A notification goes to registered clients at most once. This call is primarily used for lightweight notification. If an application needs more rigid guarantees, then it can enqueue to a queue.

Example 10-22 Posting Object-Type Messages

```
DECLARE
    postinfo          sys.aq$_post_info;
    post_list         sys.aq$_post_info_list;
BEGIN
    postinfo := sys.aq$_post_info('test.obj_queue',0,HEXTORAW('FF'));
    post_list := sys.aq$_post_info_list(postinfo);
    DBMS_AQ.POST(
        post_list      => post_list,
        post_count     => 1);
    COMMIT;
END;
/
```

10.10 Adding an Agent to the LDAP Server

This procedure creates an entry for an Oracle Database Advanced Queuing agent in the LDAP server.

```
DBMS_AQ.BIND_AGENT(
    agent          IN SYS.AQ$_AGENT,
    certificate    IN VARCHAR2 default NULL);
```

The `agent` parameter specifies the Oracle Database Advanced Queuing Agent that is to be registered in [Lightweight Directory Access Protocol](#) (LDAP) server.

The `certificate` parameter specifies the location (LDAP distinguished name) of the `OrganizationalPerson` entry in LDAP whose digital certificate (attribute `usercertificate`) is to be used for this agent. For example, "`cn=OE, cn=ACME, cn=com`" is a distinguished name for a `OrganizationalPerson` `OE` whose certificate will be used with the specified agent. If the agent does not have a digital certificate, then this parameter is defaulted to null.

See Also:

["AQ Agent Type"](#)

10.11 Removing an Agent from the LDAP Server

This procedure removes the entry for an Oracle Database Advanced Queuing agent from the LDAP server.

```
DBMS_AQ.UNBIND_AGENT(  
  agent      IN SYS.AQ$_AGENT);
```

11

Introduction to Oracle Java Message Service

The following topics describe the Oracle [Java Message Service \(JMS\)](#) interface to Oracle Database Advanced Queuing (AQ).

- [General Features of JMS and Oracle JMS](#)
- [Structured Payload/Message Types in JMS](#)
- [Buffered Messaging in JMS](#)
- [JMS Point-to-Point Model Features](#)
- [JMS Publish/Subscribe Model Features](#)
- [JMS Message Producer Features](#)
- [JMS Message Consumer Features](#)
- [JMS Propagation](#)
- [Message Transformation with JMS AQ](#)
- [JMS Streaming](#)
- [Java EE Compliance](#)

11.1 General Features of JMS and Oracle JMS

This section contains these topics:

- [JMS Connection and Session](#)
- [JMS Destination](#)
- [System-Level Access Control in JMS](#)
- [Destination-Level Access Control in JMS](#)
- [Retention and Message History in JMS](#)
- [Supporting Oracle Real Application Clusters in JMS](#)
- [Supporting Statistics Views in JMS](#)

11.1.1 JMS Connection and Session

This section contains these topics:

- [ConnectionFactory Objects](#)
- [Using AQjmsFactory to Obtain ConnectionFactory Objects](#)
- [Using JNDI to Look Up ConnectionFactory Objects](#)
- [JMS Connection](#)

- [JMS Session](#)

11.1.1.1 ConnectionFactory Objects

A `ConnectionFactory` encapsulates a set of connection configuration parameters that has been defined by an administrator. A client uses it to create a connection with a JMS provider. In this case Oracle JMS, part of Oracle Database, is the JMS provider.

The three types of `ConnectionFactory` objects are:

- `ConnectionFactory`
- `QueueConnectionFactory`
- `TopicConnectionFactory`

11.1.1.2 Using `AQjmsFactory` to Obtain `ConnectionFactory` Objects

You can use the `AQjmsFactory` class to obtain a handle to a `ConnectionFactory`, `QueueConnectionFactory`, or `TopicConnectionFactory` object.

To obtain a `ConnectionFactory`, which supports both point-to-point and publish/subscribe operations, use `AQjmsFactory.getConnectionFactory()`. To obtain a `QueueConnectionFactory`, use `AQjmsFactory.getQueueConnectionFactory()`. To obtain a `TopicConnectionFactory`, use `AQjmsFactory.getTopicConnectionFactory()`.

The `ConnectionFactory`, `QueueConnectionFactory`, or `TopicConnectionFactory` can be created using hostname, port number, and SID driver or by using JDBC URL and properties.

11.1.1.3 Using JNDI to Look Up `ConnectionFactory` Objects

A JMS administrator can register `ConnectionFactory` objects in a [Lightweight Directory Access Protocol \(LDAP\)](#) server. The following setup is required to enable [Java Naming and Directory Interface \(JNDI\)](#) lookup in JMS:

1. Register Database

When the Oracle Database server is installed, the database must be registered with the LDAP server. This can be accomplished using the [Database Configuration Assistant \(DBCA\)](#). [Figure 11-1](#) shows the structure of Oracle Database Advanced Queuing entries in the LDAP server. `ConnectionFactory` information is stored under `<cn=OracleDBConnections>`, while topics and queues are stored under `<cn=OracleDBQueues>`.

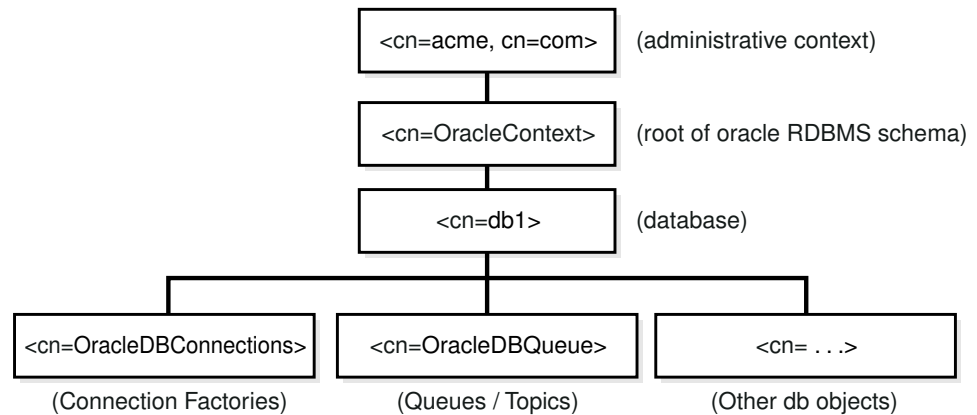
Figure 11-1 Structure of Oracle Database Advanced Queuing Entries in LDAP Server**2. Set Parameter** `GLOBAL_TOPIC_ENABLED`.

The `GLOBAL_TOPIC_ENABLED` system parameter for the database must be set to `TRUE`. This ensures that all queues and topics created in Oracle Database Advanced Queuing are automatically registered with the LDAP server. This parameter can be set by using `ALTER SYSTEM SET GLOBAL_TOPIC_ENABLED = TRUE`.

3. Register `ConnectionFactory` Objects

After the database has been set up to use an LDAP server, the JMS administrator can register `ConnectionFactory`, `QueueConnectionFactory`, and `TopicConnectionFactory` objects in LDAP by using `AQjmsFactory.registerConnectionFactory()`.

The registration can be accomplished in one of the following ways:

- Connect directly to the LDAP server

The user must have the `GLOBAL_AQ_USER_ROLE` to register connection factories in LDAP.

To connect directly to LDAP, the parameters for the `registerConnectionFactory` method include the LDAP context, the name of the `ConnectionFactory`, `QueueConnectionFactory`, or `TopicConnectionFactory`, hostname, database SID, port number, JDBC driver (thin or oci8) and factory type (queue or topic).

- Connect to LDAP through the database server

The user can log on to Oracle Database first and then have the database update the LDAP entry. The user that logs on to the database must have the `AQ_ADMINISTRATOR_ROLE` to perform this operation.

To connect to LDAP through the database server, the parameters for the `registerConnectionFactory` method include a JDBC connection (to a user having `AQ_ADMINISTRATOR_ROLE`), the name of the `ConnectionFactory`, `QueueConnectionFactory`, or `TopicConnectionFactory`, hostname, database SID, port number, JDBC driver (thin or oci8) and factory type (queue or topic).

11.1.1.4 JMS Connection

A JMS `Connection` is an active connection between a client and its JMS provider. A JMS `Connection` performs several critical services:

- Encapsulates either an open connection or a pool of connections with a JMS provider
- Typically represents an open TCP/IP socket (or a set of open sockets) between a client and a provider's service daemon
- Provides a structure for authenticating clients at the time of its creation
- Creates `Sessions`
- Provides connection metadata
- Supports an optional `ExceptionListener`

A JMS `Connection` to the database can be created by invoking `createConnection()`, `createQueueConnection()`, or `createTopicConnection()` and passing the parameters `username` and `password` on the `ConnectionFactory`, `QueueConnectionFactory`, or `TopicConnectionFactory` object respectively.

Some of the methods that are supported on the `Connection` object are

- `start()`
This method starts or restart delivery of incoming messages.
- `stop()`
This method temporarily stops delivery of incoming messages. When a `Connection` object is stopped, delivery to all of its message consumers is inhibited. Also, [synchronous](#) receive's block and messages are not delivered to message listener.
- `close()`
This method closes the [JMS session](#) and releases all associated resources.
- `createSession(true, 0)`
This method creates a JMS `Session` using a JMS `Connection` instance.
- `createQueueSession(true, 0)`
This method creates a `QueueSession`.
- `createTopicSession(true, 0)`
This method creates a `TopicSession`.
- `setExceptionListener(ExceptionListener)`
This method sets an exception listener for the `Connection`. This allows a client to be notified of a problem asynchronously. If a `Connection` only consumes messages, then it has no other way to learn it has failed.
- `getExceptionListener()`
This method gets the `ExceptionListener` for this `Connection`.

A JMS client typically creates a `Connection`, a `Session` and several `MessageProducer` and `MessageConsumer` objects. In the current version only one open `Session` for each `Connection` is allowed, except in the following cases:

- If the JDBC `oci8` driver is used to create the [JMS connection](#)
- If the user provides an `OracleOCIConnectionPool` instance during JMS connection creation

When a `Connection` is created it is in stopped mode. In this state no messages can be delivered to it. It is typical to leave the `Connection` in stopped mode until setup is

complete. At that point the `Connection.start()` method is called and messages begin arriving at the `Connection` consumers. This setup convention minimizes any client confusion that can result from [asynchronous](#) message delivery while the client is still in the process of setup.

It is possible to start a `Connection` and to perform setup subsequently. Clients that do this must be prepared to handle asynchronous message delivery while they are still in the process of setting up. A `MessageProducer` can [send](#) messages while a `Connection` is stopped.

11.1.1.5 JMS Session

A `JMS Session` is a single threaded context for producing and consuming messages. Although it can allocate provider resources outside the [Java Virtual Machine](#) (JVM), it is considered a lightweight JMS object.

A `Session` serves several purposes:

- Constitutes a factory for `MessageProducer` and `MessageConsumer` objects
- Provides a way to get a handle to destination objects (queues/topics)
- Supplies provider-optimized message factories
- Supports a single series of transactions that combines work spanning session `MessageProducer` and `MessageConsumer` objects, organizing these into units
- Defines a serial order for the messages it consumes and the messages it produces
- Serializes execution of `MessageListener` objects registered with it

In Oracle Database 10g, you can create as many `JMS Sessions` as resources allow using a single `JMS Connection`, when using either JDBC thin or JDBC thick (OCI) drivers.

Because a provider can allocate some resources on behalf of a `Session` outside the JVM, clients should close them when they are not needed. Relying on garbage collection to eventually reclaim these resources may not be timely enough. The same is true for `MessageProducer` and `MessageConsumer` objects created by a `Session`.

Methods on the `Session` object include:

- `commit()`
This method commits all messages performed in the transaction and releases locks currently held.
- `rollback()`
This method rolls back any messages accomplished in the transaction and release locks currently held.
- `close()`
This method closes the `Session`.
- `getDBConnection()`
This method gets a handle to the underlying JDBC connection. This handle can be used to perform other SQL [DML](#) operations as part of the same `Session`. The method is specific to Oracle JMS.
- `acknowledge()`

This method acknowledges message receipt in a nontransactional session.

- `recover()`

This method restarts message delivery in a nontransactional session. In effect, the series of delivered messages in the session is reset to the point after the last acknowledged message.

The following are some Oracle JMS extensions:

- `createQueueTable()`

This method creates a [queue table](#).

- `getQueueTable()`

This method gets a handle to an existing queue table.

- `createQueue()`

This method creates a queue.

- `getQueue()`

This method gets a handle to an existing queue.

- `createTopic()`

This method creates a topic.

- `getTopic()`

This method gets a handle to an existing topic.

The `Session` object must be cast to `AQjmsSession` to use any of the extensions.

Note:

The JMS specification expects providers to return null messages when receives are accomplished on a `JMS Connection` instance that has not been started.

After you create a `javax.jms.Connection` instance, you must call the `start()` method on it before you can receive messages. If you add a line like `t_conn.start();` any time after the connection has been created, but before the actual receive, then you can receive your messages.

11.1.2 JMS Destination

A `Destination` is an object a client uses to specify the destination where it sends messages, and the source from which it receives messages. A `Destination` object can be a `Queue` or a `Topic`. In Oracle Database Advanced Queuing, these map to a `schema.queue` at a specific database. `Queue` maps to a single-consumer queue, and `Topic` maps to a multiconsumer queue.

11.1.2.1 Using a JMS Session to Obtain Destination Objects

`Destination` objects are created from a `Session` object using the following domain-specific `Session` methods:

- `AQjmsSession.getQueue(queue_owner, queue_name)`
This method gets a handle to a JMS queue.
- `AQjmsSession.getTopic(topic_owner, topic_name)`
This method gets a handle to a [JMS topic](#).

11.1.2.2 Using JNDI to Look Up Destination Objects

The database can be configured to register [schema](#) objects with an LDAP server. If a database has been configured to use LDAP and the `GLOBAL_TOPIC_ENABLED` parameter has been set to `TRUE`, then all JMS queues and topics are automatically registered with the LDAP server when they are created. The administrator can also create aliases to the queues and topics registered in LDAP. Queues and topics that are registered in LDAP can be looked up through JNDI using the name or alias of the queue or topic.



See Also:

["Adding an Alias to the LDAP Server"](#)

11.1.2.3 JMS Destination Methods

Methods on the `Destination` object include:

- `alter()`
This method alters a `Queue` or a `Topic`.
- `schedulePropagation()`
This method schedules [propagation](#) from a source to a destination.
- `unschedulePropagation()`
This method unschedules a previously scheduled propagation.
- `enablePropagationSchedule()`
This method enables a propagation schedule.
- `disablePropagationSchedule()`
This method disables a propagation schedule.
- `start()`
This method starts a `Queue` or a `Topic`. The queue can be started for `enqueue` or [`dequeue`](#). The topic can be started for `publish` or `subscribe`.
- `stop()`
This method stops a `Queue` or a `Topic`. The queue is stopped for `enqueue` or `dequeue`. The topic is stopped for `publish` or `subscribe`.
- `drop()`
This method drops a `Queue` or a `Topic`.

11.1.3 System-Level Access Control in JMS

Oracle8i or higher supports system-level access control for all queuing operations. This feature allows an application designer or DBA to create users as queue administrators. A queue administrator can invoke administrative and operational JMS interfaces on any queue in the database. This simplifies administrative work, because all administrative scripts for the queues in a database can be managed under one schema.

When messages arrive at the destination queues, sessions based on the source queue schema name are used for enqueueing the newly arrived messages into the destination queues. This means that you must grant enqueue privileges for the destination queues to schemas of the source queues.

To propagate to a remote destination queue, the login user (specified in the database link in the address field of the agent structure) should either be granted the `ENQUEUE_ANY` privilege, or be granted the rights to enqueue to the destination queue. However, you are not required to grant any explicit privileges if the login user in the database link also owns the queue tables at the destination.



See Also:

["Oracle Enterprise Manager Support"](#)

11.1.4 Destination-Level Access Control in JMS

Oracle8i or higher supports access control for enqueue and dequeue operations at the queue or topic level. This feature allows the application designer to protect queues and topics created in one schema from applications running in other schemas. You can grant only minimal access privileges to the applications that run outside the schema of the queue or topic. The supported access privileges on a queue or topic are `ENQUEUE`, `DEQUEUE` and `ALL`.



See Also:

["Oracle Enterprise Manager Support"](#)

11.1.5 Retention and Message History in JMS

Messages are often related to each other. For example, if a message is produced as a result of the consumption of another message, then the two are related. As the application designer, you may want to keep track of such relationships. Oracle Database Advanced Queuing allows users to retain messages in the queue table, which can then be queried in SQL for analysis.

Along with retention and message identifiers, Oracle Database Advanced Queuing lets you automatically create message journals, also called tracking journals or event

journals. Taken together, retention, message identifiers and SQL queries make it possible to build powerful message warehouses.

11.1.6 Supporting Oracle Real Application Clusters in JMS

In Oracle Database 12c Release 1 (12.1), Advanced Queuing introduces high performing and scalable JMS Sharded Queues. A sharded queue is a single logical queue that is divided into multiple, independent, physical queues through system-maintained partitioning. Sharded queues are the preferred JMS queues for queues used across Oracle RAC instances, for queues with high enqueue or dequeue rates, or for queues with many subscribers. See "[Sharded Queues and Oracle Real Application Clusters \(Oracle RAC\)](#)" for more information.

For non-sharded queues, Oracle Real Application Clusters (Oracle RAC) can be used to improve Oracle Database Advanced Queuing performance by allowing different queues to be managed by different instances. You do this by specifying different instance affinities (preferences) for the queue tables that store the queues. This allows queue operations (enqueue/dequeue) or topic operations ([publish/subscribe](#)) on different queues or topics to occur in parallel.

The Oracle Database Advanced Queuing queue monitor process continuously monitors the instance affinities of the queue tables. The queue monitor assigns ownership of a queue table to the specified primary instance if it is available, failing which it assigns it to the specified secondary instance.

If the owner instance of a queue table terminates, then the queue monitor changes ownership to a suitable instance such as the secondary instance.

Oracle Database Advanced Queuing propagation can make use of Oracle Real Application Clusters, although it is transparent to the user. The affinities for jobs submitted on behalf of the propagation schedules are set to the same values as that of the affinities of the respective queue tables. Thus, a `job_queue_process` associated with the owner instance of a queue table is handling the propagation from queues stored in that queue table, thereby minimizing ping-pong.

See Also:

- "[Sharded Queues](#)"
- "[Scheduling a Queue Propagation](#)"
- *Oracle Real Application Clusters Administration and Deployment Guide*

11.1.7 Supporting Statistics Views in JMS

Each instance keeps its own Oracle Database Advanced Queuing statistics information in its own [System Global Area](#) (SGA), and does not have knowledge of the statistics gathered by other instances. Then, when a `GV$AQ` view is queried by an instance, all other instances funnel their statistics information to the instance issuing the query.

The `GV$AQ` view can be queried at any time to see the number of messages in waiting, ready or expired state. The view also displays the average number of seconds messages have been waiting to be processed.

**See Also:**

["\\$V\\$AQ: Number of Messages in Different States in Database"](#)

11.2 Structured Payload/Message Types in JMS

JMS messages are composed of a header, properties, and a body.

The header consists of header fields, which contain values used by both clients and providers to identify and route messages. All messages support the same set of header fields.

Properties are optional header fields. In addition to standard properties defined by JMS, there can be provider-specific and application-specific properties.

The body is the message payload. JMS defines various types of message payloads, and a type that can store JMS messages of any or all JMS-specified message types.

This section contains these topics:

- [JMS Message Headers](#)
- [JMS Message Properties](#)
- [JMS Message Bodies](#)
- [Using Message Properties with Different Message Types](#)
- [Buffered Messaging with Oracle JMS](#)

11.2.1 JMS Message Headers

A JMS message header contains the following fields:

- `JMSDestination`
This field contains the destination to which the message is sent. In Oracle Database Advanced Queuing this corresponds to the destination queue/topic. It is a `Destination` type set by JMS after the `Send` method has completed.
- `JMSDeliveryMode`
This field determines whether the message is logged or not. JMS supports `PERSISTENT` delivery (where messages are logged to stable storage) and `NONPERSISTENT` delivery (messages not logged). It is a `INTEGER` set by JMS after the `Send` method has completed. JMS permits an administrator to configure JMS to override the client-specified value for `JMSDeliveryMode`.
- `JMSMessageID`
This field uniquely identifies a message in a provider. All message IDs must begin with the string `ID:`. It is a `String` type set by JMS after the `Send` method has completed.
- `JMSTimeStamp`
This field contains the time the message was handed over to the provider to be sent. This maps to Oracle Database Advanced Queuing message enqueue time. It is a `Long` type set by JMS after the `Send` method has completed.

- `JMSCorrelationID`

This field can be used by a client to link one message with another. It is a `String` type set by the JMS client.
- `JMSReplyTo`

This field contains a `Destination` type supplied by a client when a message is sent. Clients can use `oracle.jms.AQjmsAgent`; `javax.jms.Queue`; or `javax.jms.Topic`.
- `JMSType`

This field contains a message type identifier supplied by a client at send time. It is a `String` type. For portability Oracle recommends that the `JMSType` be symbolic values.
- `JMSExpiration`

This field is the sum of the enqueue time and the `TimeToLive` in non-Java EE compliance mode. In compliant mode, the `JMSExpiration` header value in a dequeued message is the sum of `JMSTimeStamp` when the message was enqueued (Greenwich Mean Time, in milliseconds) and the `TimeToLive` (in milliseconds). It is a `Long` type set by JMS after the `Send` method has completed. JMS permits an administrator to configure JMS to override the client-specified value for `JMSExpiration`.
- `JMSPriority`

This field contains the priority of the message. It is a `INTEGER` set by JMS after the `Send` method has completed. In Java EE-compliance mode, the permitted values for priority are 0–9, with 9 the highest priority and 4 the default, in conformance with the Sun Microsystems JMS 1.1 standard. Noncompliant mode is the default. JMS permits an administrator to configure JMS to override the client-specified value for `JMSPriority`.
- `JMSRedelivered`

This field is a `Boolean` set by the JMS provider.



See Also:

["Java EE Compliance"](#)

11.2.2 JMS Message Properties

JMS properties are set either explicitly by the client or automatically by the JMS provider (these are generally read-only). Some JMS properties are set using the parameters specified in `Send` and `Receive` operations.

Properties add optional header fields to a message. Properties allow a client, using a `messageSelector`, to have a JMS provider select messages on its behalf using application-specific criteria. Property names are strings and values can be: `Boolean`, `byte`, `short`, `int`, `long`, `float`, `double`, and `string`.

JMS-defined properties, which all begin with `"JMSX"`, include the following:

- `JMSXUserID`

This field is the identity of the user sending the message. It is a `String` type set by JMS after the `Send` method has completed.

- `JMSXAppID`

This field is the identity of the application sending the message. It is a `String` type set by JMS after the `Send` method has completed.

- `JMSXDeliveryCount`

This field is the number of message delivery attempts. It is an `Integer` set by JMS after the `Send` method has completed.

- `JMSXGroupid`

This field is the identity of the message group that this message belongs to. It is a `String` type set by the JMS client.

- `JMSXGroupSeq`

This field is the sequence number of a message within a group. It is an `Integer` set by the JMS client.

- `JMSXRcvTimeStamp`

This field is the time the message was delivered to the consumer (dequeue time). It is a `String` type set by JMS after the `Receive` method has completed.

- `JMSXState`

This field is the message state, set by the provider. The message state can be `WAITING`, `READY`, `EXPIRED`, or `RETAINED`.

Oracle-specific JMS properties, which all begin with `JMS_Oracle`, include the following:

- `JMS_OracleExcpQ`

This field is the queue name to send the message to if it cannot be delivered to the original destination. It is a `String` type set by the JMS client. Only destinations of type `EXCEPTION` can be specified in the `JMS_OracleExcpQ` property.

- `JMS_OracleDelay`

This field is the time in seconds to delay the delivery of the message. It is an `Integer` set by the JMS client. This can affect the order of message delivery.

- `JMS_OracleOriginalMessageId`

This field is set to the message identifier of the message in the source if the message is propagated from one destination to another. It is a `String` type set by the JMS provider. If the message is not propagated, then this property has the same value as `JMSMessageId`.

A client can add additional header fields to a message by defining properties. These properties can then be used in a `messageSelector` to select specific messages.

11.2.3 JMS Message Bodies

JMS provides five forms of message body:

- [StreamMessage](#)
- [BytesMessage](#)
- [MapMessage](#)

- [TextMessage](#)
- [ObjectMessage](#)
- [AdtMessage](#)

11.2.3.1 StreamMessage

A `StreamMessage` object is used to send a stream of Java primitives. It is filled and read sequentially. It inherits from `Message` and adds a `StreamMessage` body. Its methods are based largely on those found in `java.io.DataInputStream` and `java.io.DataOutputStream`.

The primitive types can be read or written explicitly using methods for each type. They can also be read or written generically as objects. To use `StreamMessage` objects, create the queue table with the `SYS.AQ$_JMS_STREAM_MESSAGE` or `AQ$_JMS_MESSAGE` payload types.

`StreamMessage` objects support the conversions shown in [Table 11-1](#). A value written as the row type can be read as the column type.

Table 11-1 StreamMessage Conversion

Input	Boolean	byte	short	char	int	long	float	double	String	byte[]
Boolean	X	-	-	-	-	-	-	-	X	-
byte	-	X	X	-	X	X	-	-	X	-
short	-	-	X	-	X	X	-	-	X	-
char	-	-	-	X	-	-	-	-	X	-
int	-	-	-	-	X	X	-	-	X	-
long	-	-	-	-	-	X	-	-	X	-
float	-	-	-	-	-	-	X	X	X	-
double	-	-	-	-	-	-	-	X	X	-
string	X	X	X	X	X	X	X	X	X	-
byte[]	-	-	-	-	-	-	-	-	-	X

11.2.3.2 BytesMessage

A `BytesMessage` object is used to send a message containing a stream of uninterpreted bytes. It inherits `Message` and adds a `BytesMessage` body. The receiver of the message interprets the bytes. Its methods are based largely on those found in `java.io.DataInputStream` and `java.io.DataOutputStream`.

This message type is for client encoding of existing message formats. If possible, one of the other self-defining message types should be used instead.

The primitive types can be written explicitly using methods for each type. They can also be written generically as objects. To use `BytesMessage` objects, create the queue table with `SYS.AQ$_JMS_BYTES_MESSAGE` or `AQ$_JMS_MESSAGE` payload types.

11.2.3.3 MapMessage

A `MapMessage` object is used to send a set of name-value pairs where the names are `String` types, and the values are Java primitive types. The entries can be accessed

sequentially or randomly by name. The order of the entries is undefined. It inherits from `Message` and adds a `MapMessage` body. The primitive types can be read or written explicitly using methods for each type. They can also be read or written generically as objects.

To use `MapMessage` objects, create the queue table with the `SYS.AQ$_JMS_MAP_MESSAGE` or `AQ$_JMS_MESSAGE` payload types. `MapMessage` objects support the conversions shown in [Table 11-2](#). An "X" in the table means that a value written as the row type can be read as the column type.

Table 11-2 MapMessage Conversion

Input	Boolean	byte	short	char	int	long	float	double	String	byte[]
Boolean	X	-	-	-	-	-	-	-	X	-
byte	-	X	X	-	X	X	-	-	X	-
short	-	-	X	-	X	X	-	-	X	-
char	-	-	-	X	-	-	-	-	X	-
int	-	-	-	-	X	X	-	-	X	-
long	-	-	-	-	-	X	-	-	X	-
float	-	-	-	-	-	-	X	X	X	-
double	-	-	-	-	-	-	-	X	X	-
string	X	X	X	X	X	X	X	X	X	-
byte[]	-	-	-	-	-	-	-	-	-	X

11.2.3.4 TextMessage

A `TextMessage` object is used to send a message containing a `java.lang.StringBuffer`. It inherits from `Message` and adds a `TextMessage` body. The text information can be read or written using methods `getText()` and `setText(...)`. To use `TextMessage` objects, create the queue table with the `SYS.AQ$_JMS_TEXT_MESSAGE` or `AQ$_JMS_MESSAGE` payload types.

11.2.3.5 ObjectMessage

An `ObjectMessage` object is used to send a message that contains a serializable Java object. It inherits from `Message` and adds a body containing a single Java reference. Only serializable Java objects can be used. If a collection of Java objects must be sent, then one of the collection classes provided in JDK 1.4 can be used. The objects can be read or written using the methods `getObject()` and `setObject(...)`. To use `ObjectMessage` objects, create the queue table with the `SYS.AQ$_JMS_OBJECT_MESSAGE` or `AQ$_JMS_MESSAGE` payload types.

11.2.3.6 AdtMessage

An `AdtMessage` object is used to send a message that contains a Java object that maps to an Oracle object type. These objects inherit from `Message` and add a body containing a Java object that implements the `CustomDatum` or `ORADData` interface.

To use `AdtMessage` objects, create the queue table with payload type as the Oracle object type. The `AdtMessage` payload can be read and written using the `getAdtPayload` and `setAdtPayload` methods.

You can also use an `AdtMessage` object to send messages to queues of type `SYS.XMLType`. You must use the `oracle.xdb.XMLType` class to create the message.

For `AdtMessage` objects, the client can get:

- `JMSXDeliveryCount`
- `JMSXRecvTimeStamp`
- `JMSXState`
- `JMS_OracleExcpQ`
- `JMS_OracleDelay`

 **See Also:**

Oracle Database Java Developer's Guide for information about the `CustomDatum` and `ORaData` interfaces

11.2.4 Using Message Properties with Different Message Types

The following message properties can be set by the client using the `setProperty` call. For `StreamMessage`, `BytesMessage`, `ObjectMessage`, `TextMessage`, and `MapMessage` objects, the client can set:

- `JMSXAppID`
- `JMSXGroupID`
- `JMSXGroupSeq`
- `JMS_OracleExcpQ`
- `JMS_OracleDelay`

For `AdtMessage` objects, the client can set:

- `JMS_OracleExcpQ`
- `JMS_OracleDelay`

The following message properties can be obtained by the client using the `getProperty` call. For `StreamMessage`, `BytesMessage`, `ObjectMessage`, `TextMessage`, and `MapMessage` objects, the client can get:

- `JMSXUserID`
- `JMSXAppID`
- `JMSXDeliveryCount`
- `JMSXGroupID`
- `JMSXGroupSeq`
- `JMSXRecvTimeStamp`
- `JMSXState`
- `JMS_OracleExcpQ`
- `JMS_OracleDelay`

- `JMS_OracleOriginalMessageID`

11.2.5 Buffered Messaging with Oracle JMS

Users can send a nonpersistent JMS message by specifying the `deliveryMode` to be `NON_PERSISTENT` when sending a message. JMS nonpersistent messages are not required to be logged to stable storage, so they can be lost after a JMS system failure. JMS nonpersistent messages are similar to the buffered messages available in Oracle Database Advanced Queuing, but there are also important differences between the two.

Note:

Do not confuse Oracle JMS nonpersistent messages with Oracle Database Advanced Queuing nonpersistent queues, which are deprecated in Oracle Database 10g Release 2 (10.2).

See Also:

- ["Buffered Messaging"](#)
- [Nonpersistent Queues](#)

Transaction Commits and Client Acknowledgments

The JMS `deliveryMode` is orthogonal to the transaction attribute of a message. JMS nonpersistent messages can be sent and received by either a transacted session or a nontransacted session. If a JMS nonpersistent message is sent and received by a transacted session, then the effect of the JMS operation is only visible after the transacted session commits. If it is received by a nontransacted session with `CLIENT_ACKNOWLEDGE` acknowledgment mode, then the effect of receiving this message is only visible after the client acknowledges the message. Without the acknowledgment, the message is not removed and will be redelivered if the client calls `Session.recover`.

Oracle Database Advanced Queuing buffered messages, however, do not support these transaction or acknowledgment concepts. Both sending and receiving a buffered message must be in the `IMMEDIATE` visibility mode. The effects of the sending and receiving operations are therefore visible to the user immediately, no matter whether the session is committed or the messages are acknowledged.

Different APIs

Messages sent with the regular JMS send and publish methods are treated by Oracle Database Advanced Queuing as persistent messages. The regular JMS receive methods receive only AQ persistent messages. To send and receive buffered messages, you must use the Oracle extension APIs `bufferSend`, `bufferPublish`, and `bufferReceive`.

 **See Also:**

Oracle Database Advanced Queuing Java API Reference for more information on `bufferSend`, `bufferPublish`, and `bufferReceive`

Payload Limits

The Oracle Database Advanced Queuing implementation of buffered messages does not support `LOB` attributes. This places limits on the payloads for the five types of standard JMS messages:

- JMS `TextMessage` payloads cannot exceed 4000 bytes.
This limit might be even lower with some database character sets, because during the Oracle JMS character set conversion, Oracle JMS sometimes must make a conservative choice of using `CLOB` instead of `VARCHAR` to store the text payload in the database.
- JMS `BytesMessage` payloads cannot exceed 2000 bytes.
- JMS `ObjectMessage`, `StreamMessage`, and `MapMessage` data serialized by JAVA cannot exceed 2000 bytes.
- For all other Oracle JMS ADT messages, the corresponding Oracle database ADT cannot contain `LOB` attributes.

Different Constants

The Oracle Database Advanced Queuing and Oracle JMS APIs use different numerical values to designate buffered and persistent messages, as shown in [Table 11-3](#).

Table 11-3 Oracle Database AQ and Oracle JMS Buffered Messaging Constants

API	Persistent Message	Buffered Message
Oracle Database Advanced Queuing	<code>PERSISTENT := 1</code>	<code>BUFFERED :=2</code>
Oracle JMS	<code>PERSISTENT := 2</code>	<code>NON_PERSISTENT := 1</code>

11.3 Buffered Messaging in JMS

Buffered messaging fully supports JMS messaging standards. Oracle JMS extends those standards in several ways.

 **See Also:**

["Buffered Messaging"](#)

Enqueuing JMS Buffered Messages

Oracle JMS allows applications to send buffered messages by setting `JMSDeliveryMode` for individual messages, so persistent and buffered messages can be enqueued to the same JMS queue/topic.

Oracle JMS buffered messages can be ordered by enqueue time, priority, or both. The ordering does not extend across message types. So a persistent message sent later, for example, can be delivered before an buffered message sent earlier. Expiration is also supported for buffered messages in Oracle JMS.



See Also:

["JMS Message Headers"](#)

Dequeuing JMS Buffered Messages

JMS does not require subscribers to declare interest in just persistent messages or just buffered messages, so JMS subscribers can be interested in both message types.

Oracle JMS supports fast and efficient dequeue of messages by `JMSMessageID`, selectors on message headers, and selectors on message properties. The Oracle JMS dequeue call checks for both persistent and buffered messages.



Note:

Oracle JMS persistent messages have unique message identifiers. Oracle JMS buffered message identifiers are unique only within a queue/topic.

If concurrent dequeue processes are dequeuing from the same queue as the same subscriber, then they will skip messages that are locked by the other process.



See Also:

- ["MessageSelector"](#)
- ["Receiving Messages "](#)

Transactions Support

If buffered messages are enqueued in a transacted session, then JMS requires transaction support for them. Oracle JMS guarantees that transacted sessions involving buffered messages meet the following standards:

- Atomicity
Both persistent and buffered messages within an Oracle JMS transaction are committed or rolled back atomically. Even if buffered messages were written to

disk, as in the case of messages involving LOBs, rollback nevertheless removes them.

- Consistency

If persistent and buffered messaging operations interleave in a transaction, then all Oracle JMS users share a consistent view of the affected queues/topics. All persistent and buffered messages enqueued by a transaction become visible at commit time. If a process ends in the middle of a transaction, then both persistent and buffered messages are undone. Oracle JMS users see either all persistent and buffered messages in a transaction or none of them.

- Isolation

An buffered enqueue operation in a transaction is visible only to the owner transaction before the transaction is committed. It is visible to all consumers after the transaction is committed.

Messages locked by dequeue transaction may be browsed.

Acknowledging Message Receipt

Three values are defined for the `ack_mode` parameter for acknowledging message receipt in nontransacted sessions:

- `DUPS_OK_ACKNOWLEDGE`

In this mode, duplicate messages are allowed.

- `AUTO_ACKNOWLEDGE`

In this mode, the session automatically acknowledges messages.

- `CLIENT_ACKNOWLEDGE`

In this mode, the client explicitly acknowledges messages by calling the message producer `acknowledge` method. Acknowledging a message acknowledges all previously consumed messages.

 **See Also:**
["Creating a Session"](#)

Buffered Messaging Quality of Service

JMS requires providers to support at-most-once delivery of unpropagated buffered messages. If recovery of buffered messages is disabled, then Oracle JMS meets this standard.

Duplicate delivery of messages is possible with the current implementation of message propagation. But this does not violate the JMS standard, because message propagation is an extension offered by Oracle JMS.

 **See Also:**

"[Propagating Buffered Messages](#)" for the causes of duplicate delivery of buffered messages

JMS Types Support for Buffered Messages

Oracle JMS maps the JMS-defined types to Oracle user-defined types and creates queues of these user-defined types for storing JMS messages. Some of these types have LOB attributes, which Oracle JMS writes to disk whether the message is persistent or buffered.

The user-defined type `SYS.AQ$_JMS_TEXT_MESSAGE` for JMS type `JMSTextMessage`, for example, stores text strings smaller than 4k in a `VARCHAR2` column. But it has a `CLOB` attribute for storing text strings larger than 4k.

Because JMS messages are often larger than 4k, Oracle JMS offers a new ADT that allows larger messages to be stored in memory. The disk representation of the ADT remains unchanged, but several `VARCHAR2/RAW` attributes allow for JMS messages of sizes up to 100k to be stored in memory. Messages larger than 100k can still be published as buffered messages, but they are written to disk.

 **See Also:**

"[Enqueuing Buffered Messages](#)"

11.4 JMS Point-to-Point Model Features

In the point-to-point model, clients exchange messages from one point to another. Message producers and consumers send and receive messages using single-consumer queues. An administrator creates the single-consumer queues with the `createQueue` method in `AQjmsSession`. Before they can be used, the queues must be enabled for enqueue/dequeue using the `start` call in `AQjmsDestination`. Clients obtain a handle to a previously created queue using the `getQueue` method on `AQjmsSession`.

In a single-consumer queue, a message can be consumed exactly once by a single consumer. If there are multiple processes or operating system threads concurrently dequeuing from the same queue, then each process dequeues the first unlocked message at the head of the queue. A locked message cannot be dequeued by a process other than the one that has created the lock.

After processing, the message is removed if the retention time of the queue is 0, or it is retained for a specified retention time. As long as the message is retained, it can be either queried using SQL on the queue table view or dequeued by specifying the message identifier of the processed message in a `QueueBrowser`.

QueueSender

A client uses a `QueueSender` to send messages to a queue. It is created by passing a queue to the `createSender` method in a client `Session`. A client also has the option of

creating a `QueueSender` without supplying a queue. In that case a queue must be specified on every send operation.

A client can specify a default delivery mode, priority and `TimeToLive` for all messages sent by the `QueueSender`. Alternatively, the client can define these options for each message.

QueueReceiver

A client uses a `QueueReceiver` to receive messages from a queue. It is created using the `createQueueReceiver` method in a client `Session`. It can be created with or without a `messageSelector`.

QueueBrowser

A client uses a `QueueBrowser` to view messages on a queue without removing them. The browser method returns a `java.util.Enumeration` that is used to scan messages in the queue. The first call to `nextElement` gets a snapshot of the queue. A `QueueBrowser` can be created with or without a `messageSelector`.

A `QueueBrowser` can also optionally lock messages as it is scanning them. This is similar to a "SELECT... for UPDATE" command on the message. This prevents other consumers from removing the message while they are being scanned.

MessageSelector

A `messageSelector` allows the client to restrict messages delivered to the consumer to those that match the `messageSelector` expression. A `messageSelector` for queues containing payloads of type `TextMessage`, `StreamMessage`, `BytesMessage`, `ObjectMessage`, or `MapMessage` can contain any expression that has one or more of the following:

- JMS message identifier prefixed with "ID:"

```
JMSMessageID = 'ID:23452345'
```
- JMS message header fields or properties

```
JMSPriority < 3 AND JMSCorrelationID = 'Fiction'
```

```
JMSCorrelationID LIKE 'RE%'
```
- User-defined message properties

```
color IN ('RED', 'BLUE', 'GREEN') AND price < 30000
```

The `messageSelector` for queues containing payloads of type `AdtMessage` can contain any expression that has one or more of the following:

- Message identifier without the "ID:" prefix

```
msgid = '23434556566767676'
```
- Priority, correlation identifier, or both

```
priority < 3 AND corrid = 'Fiction'
```
- Message payload

```
tab.user_data.color = 'GREEN' AND tab.user_data.price < 30000
```

11.5 JMS Publish/Subscribe Model Features

This section contains these topics:

- [JMS Publish/Subscribe Overview](#)
- [DurableSubscriber](#)
- [RemoteSubscriber](#)
- [TopicPublisher](#)
- [Recipient Lists](#)
- [TopicReceiver](#)
- [TopicBrowser](#)
- [Setting Up JMS Publish/Subscribe Operations](#)

11.5.1 JMS Publish/Subscribe Overview

JMS enables flexible and dynamic communication between applications functioning as publishers and applications playing the role of subscribers. The applications are not coupled together; they interact based on messages and message content.

In distributing messages, publisher applications are not required to handle or manage message recipients explicitly. This allows new subscriber applications to be added dynamically without changing any publisher application logic.

Similarly, subscriber applications receive messages based on message content without regard to which publisher applications are sending messages. This allows new publisher applications to be added dynamically without changing any subscriber application logic.

Subscriber applications specify interest by defining a rule-based subscription on message properties or the message content of a topic. The system automatically routes messages by computing recipients for published messages using the rule-based subscriptions.

In the publish/subscribe model, messages are published to and received from topics. A topic is created using the `CreateTopic()` method in an `AQjmsSession`. A client can obtain a handle to a previously-created topic using the `getTopic()` method in `AQjmsSession`.

11.5.2 DurableSubscriber

A client creates a `DurableSubscriber` with the `createDurableSubscriber()` method in a client `Session`. It can be created with or without a `messageSelector`.

A `messageSelector` allows the client to restrict messages delivered to the subscriber to those that match the selector. The syntax for the selector is described in detail in `createDurableSubscriber` in *Oracle Database Advanced Queuing Java API Reference*.

When subscribers use the same name, durable subscriber action depends on the Java EE compliance mode set for an [Oracle Java Message Service](#) (Oracle JMS) client at runtime.

In noncompliant mode, two durable `TopicSubscriber` objects with the same name can be active against two different topics. In compliant mode, durable subscribers with the same name are not allowed. If two subscribers use the same name and are created against the same topic, but the selector used for each subscriber is different, then the underlying Oracle Database Advanced Queuing subscription is altered using the internal `DBMS_AQJMS.ALTER_SUBSCRIBER()` call.

If two subscribers use the same name and are created against two different topics, and if the client that uses the same subscription name also originally created the subscription name, then the existing subscription is dropped and the new subscription is created.

If two subscribers use the same name and are created against two different topics, and if a different client (a client that did not originate the subscription name) uses an existing subscription name, then the subscription is not dropped and an error is thrown. Because it is not known if the subscription was created by JMS or PL/SQL, the subscription on the other topic should not be dropped.

See Also:

- ["MessageSelector"](#)
- ["Java EE Compliance"](#)

11.5.3 RemoteSubscriber

Remote subscribers are defined using the `createRemoteSubscriber` call. The remote subscriber can be a specific consumer at the remote topic or all subscribers at the remote topic.

A remote subscriber is defined using the `AQjmsAgent` structure. An `AQjmsAgent` consists of a name and address. The name refers to the `consumer_name` at the remote topic. The address refers to the remote topic:

```
schema.topic_name[@dblink]
```

To publish messages to a particular consumer at the remote topic, the `subscription_name` of the [recipient](#) at the remote topic must be specified in the name field of `AQjmsAgent`. The remote topic must be specified in the address field of `AQjmsAgent`.

To publish messages to all subscribers of the remote topic, the name field of `AQjmsAgent` must be set to null. The remote topic must be specified in the address field of `AQjmsAgent`.

11.5.4 TopicPublisher

Messages are published using `TopicPublisher`, which is created by passing a `Topic` to a `createPublisher` method. A client also has the option of creating a `TopicPublisher` without supplying a `Topic`. In this case, a `Topic` must be specified on every publish operation. A client can specify a default delivery mode, priority and `TimeToLive` for all messages sent by the `TopicPublisher`. It can also specify these options for each message.

11.5.5 Recipient Lists

In the JMS publish/subscribe model, clients can specify explicit recipient lists instead of having messages sent to all the subscribers of the topic. These recipients may or may not be existing subscribers of the topic. The recipient list overrides the subscription list on the topic for this message. Recipient lists functionality is an Oracle extension to JMS.

11.5.6 TopicReceiver

If the recipient name is explicitly specified in the recipient list, but that recipient is not a subscriber to the queue, then messages sent to it can be received by creating a `TopicReceiver`. If the subscriber name is not specified, then clients must use durable subscribers at the remote site to receive messages. `TopicReceiver` is an Oracle extension to JMS.

A `TopicReceiver` can be created with a `messageSelector`. This allows the client to restrict messages delivered to the recipient to those that match the selector.



See Also:

["MessageSelector"](#)

11.5.7 TopicBrowser

A client uses a `TopicBrowser` to view messages on a topic without removing them. The browser method returns a `java.util.Enumeration` that is used to scan topic messages. Only durable subscribers are allowed to create a `TopicBrowser`. The first call to `nextElement` gets a snapshot of the topic.

A `TopicBrowser` can optionally lock messages as it is scanning them. This is similar to a `SELECT... for UPDATE` command on the message. This prevents other consumers from removing the message while it is being scanned.

A `TopicBrowser` can be created with a `messageSelector`. This allows the client to restrict messages delivered to the browser to those that match the selector.

`TopicBrowser` supports a purge feature. This allows a client using a `TopicBrowser` to discard all messages that have been seen during the current browse operation on the topic. A purge is equivalent to a destructive receive of all of the seen messages (as if performed using a `TopicSubscriber`).

For a purge, a message is considered seen if it has been returned to the client using a call to the `nextElement()` operation on the `java.lang.Enumeration` for the `TopicBrowser`. Messages that have not yet been seen by the client are not discarded during a purge. A purge operation can be performed multiple times on the same `TopicBrowser`.

The effect of a purge becomes stable when the JMS `Session` used to create the `TopicBrowser` is committed. If the operations on the session are rolled back, then the effects of the purge operation are also undone.

 **See Also:**

- ["Creating a TopicBrowser for Standard JMS Messages"](#)
- ["Creating a TopicBrowser for Standard JMS Messages_ Locking Messages"](#)
- ["MessageSelector"](#)
- ["Browsing Messages Using a TopicBrowser"](#)

11.5.8 Setting Up JMS Publish/Subscribe Operations

Follow these steps to use the publish/subscribe model of communication in JMS:

1. Set up one or more topics to hold messages. These topics represent an area or subject of interest. For example, a topic can represent billed orders.
2. Enable enqueue/dequeue on the topic using the `start` call in `AQjmsDestination`.
3. Create a set of durable subscribers. Each subscriber can specify a `messageSelector` that selects the messages that the subscriber wishes to receive. A null `messageSelector` indicates that the subscriber wishes to receive all messages published on the topic.

Subscribers can be local or remote. Local subscribers are durable subscribers defined on the same topic on which the message is published. Remote subscribers are other topics, or recipients on other topics that are defined as subscribers to a particular queue. In order to use remote subscribers, you must set up propagation between the source and destination topics. Remote subscribers and propagation are Oracle extensions to JMS.

 **See Also:**

["Managing Propagations"](#)

4. Create `TopicPublisher` objects using the `createPublisher()` method in the `publisherSession`. Messages are published using the `publish` call. Messages can be published to all subscribers to the topic or to a specified subset of recipients on the topic.
5. Subscribers receive messages on the topic by using the `receive` method.
6. Subscribers can also receive messages asynchronously by using message listeners.

 **See Also:**

["Listening to One or More Queues"](#)

11.6 JMS Message Producer Features

- [Priority and Ordering of Messages](#)
- [Specifying a Message Delay](#)
- [Specifying a Message Expiration](#)
- [Message Grouping](#)

11.6.1 Priority and Ordering of Messages

Message ordering dictates the order in which messages are received from a queue or topic. The ordering method is specified when the queue table for the queue or topic is created. Currently, Oracle Database Advanced Queuing supports ordering on message priority and enqueue time, producing four possible ways of ordering:

- **First-In, First-Out (FIFO)**
If enqueue time was chosen as the ordering criteria, then messages are received in the order of the enqueue time. The enqueue time is assigned to the message by Oracle Database Advanced Queuing at message publish/send time. This is also the default ordering.
- **Priority Ordering**
If priority ordering was chosen, then each message is assigned a priority. Priority can be specified as a message property at publish/send time by the `MessageProducer`. The messages are received in the order of the priorities assigned.
- **FIFO Priority**
If FIFO priority ordering was chosen, then the topic/queue acts like a priority queue. If two messages are assigned the same priority, then they are received in the order of their enqueue time.
- **Enqueue Time Followed by Priority**
Messages with the same enqueue time are received according to their priorities. If the ordering criteria of two message is the same, then the order they are received is indeterminate. However, Oracle Database Advanced Queuing does ensure that messages produced in one session with a particular ordering criteria are received in the order they were sent.

All ordering schemes available for persistent messages are also available for buffered messages, but only within each message class. Ordering among persistent and buffered messages enqueued/published in the same session is not currently supported.

11.6.2 Specifying a Message Delay

Messages can be sent/published to a queue/topic with delay. The delay represents a time interval after which the message becomes available to the message consumer. A message specified with a delay is in a waiting state until the delay expires. Receiving by message identifier overrides the delay specification.

Delay is an Oracle Database Advanced Queuing extension to JMS message properties. It requires the Oracle Database Advanced Queuing background process queue monitor to be started.

11.6.3 Specifying a Message Expiration

Producers of messages can specify expiration limits, or `TimeToLive` for messages. This defines the period of time the message is available for a Message Consumer.

`TimeToLive` can be specified at send/publish time or using the `set TimeToLive` method of a `MessageProducer`, with the former overriding the latter. The Oracle Database Advanced Queuing background process queue monitor must be running to implement `TimeToLive`.

11.6.4 Message Grouping

Messages belonging to a queue/topic can be grouped to form a set that can be consumed by only one consumer at a time. This requires the queue/topic be created in a queue table that is enabled for [transactional](#) message grouping. All messages belonging to a group must be created in the same transaction, and all messages created in one transaction belong to the same group.

Message grouping is an Oracle Database Advanced Queuing extension to the JMS specification.

You can use this feature to divide a complex message into a linked series of simple messages. For example, an invoice directed to an invoices queue could be divided into a header message, followed by several messages representing details, followed by the trailer message.

Message grouping is also very useful if the message payload contains complex large objects such as images and video that can be segmented into smaller objects.

The priority, delay, and expiration properties for the messages in a group are determined solely by the message properties specified for the first message (head) of the group. Properties specified for subsequent messages in the group are ignored.

Message grouping is preserved during propagation. The destination topic must be enabled for transactional grouping.

See Also:

"[Dequeue Features](#)" for a discussion of restrictions you must keep in mind if message grouping is to be preserved while dequeuing messages from a queue enabled for transactional grouping

11.7 JMS Message Consumer Features

This section contains these topics:

- [Receiving Messages](#)
- [Message Navigation in Receive](#)
- [Browsing Messages](#)
- [Remove No Data](#)

- [Retry with Delay Interval](#)
- [Asynchronously Receiving Messages Using MessageListener](#)
- [Exception Queues](#)

11.7.1 Receiving Messages

A JMS application can receive messages by creating a message consumer. Messages can be received synchronously using the `receive` call or asynchronously using a message listener.

There are three modes of receive:

- Block until a message arrives for a consumer
- Block for a maximum of the specified time
- Nonblocking

11.7.2 Message Navigation in Receive

If a consumer does not specify a navigation mode, then its first `receive` in a session retrieves the first message in the queue or topic, its second `receive` gets the next message, and so on. If a high priority message arrives for the consumer, then the consumer does not receive the message until it has cleared the messages that were already there before it.

To provide the consumer better control in navigating the queue for its messages, Oracle Database Advanced Queuing offers several navigation modes as JMS extensions. These modes can be set at the `TopicSubscriber`, `QueueReceiver` or the `TopicReceiver`.

Two modes are available for ungrouped messages:

- `FIRST_MESSAGE`
This mode resets the position to the beginning of the queue. It is useful for priority ordered queues, because it allows the consumer to remove the message on the top of the queue.
- `NEXT_MESSAGE`
This mode gets whatever message follows the established position of the consumer. For example, a `NEXT_MESSAGE` applied when the position is at the fourth message will get the fifth message in the queue. This is the default action.

Three modes are available for grouped messages:

- `FIRST_MESSAGE`
This mode resets the position to the beginning of the queue.
- `NEXT_MESSAGE`
This mode sets the position to the next message in the same transaction.
- `NEXT_TRANSACTION`
This mode sets the position to the first message in the next transaction.

 **Note:**

Sharded queues does not support the three preceding modes.

The transaction grouping property can be negated if messages are received in the following ways:

- Receive by specifying a correlation identifier in the selector
- Receive by specifying a message identifier in the selector
- Committing before all the messages of a transaction group have been received

If the consumer reaches the end of the queue while using the `NEXT_MESSAGE` or `NEXT_TRANSACTION` option, and you have specified a blocking `receive()`, then the navigating position is automatically changed to the beginning of the queue.

By default, a `QueueReceiver`, `TopicReceiver`, or `TopicSubscriber` uses `FIRST_MESSAGE` for the first receive call, and `NEXT_MESSAGE` for subsequent `receive()` calls.

11.7.3 Browsing Messages

Aside from the usual `receive`, which allows the dequeuing client to delete the message from the queue, JMS provides an interface that allows the JMS client to browse its messages in the queue. A `QueueBrowser` can be created using the `createBrowser` method from `QueueSession`.

If a message is browsed, then it remains available for further processing. That does not necessarily mean that the message will remain available to the JMS session after it is browsed, because a `receive` call from a concurrent session might remove it.

To prevent a viewed message from being removed by a concurrent JMS client, you can view the message in the locked mode. To do this, you must create a `QueueBrowser` with the locked mode using the Oracle Database Advanced Queuing extension to the JMS interface. The lock on the message is released when the session performs a commit or a rollback.

To remove a message viewed by a `QueueBrowser`, the session must create a `QueueReceiver` and use the `JMSmessageID` as the selector.

11.7.4 Remove No Data

The consumer can remove a message from a queue or topic without retrieving it using the `receiveNoData` call. This is useful when the application has already examined the message, perhaps using a `QueueBrowser`. This mode allows the JMS client to avoid the overhead of retrieving a payload from the database, which can be substantial for a large message.

11.7.5 Retry with Delay Interval

If a transaction receiving a message from a queue/topic fails, then it is regarded as an unsuccessful attempt to remove the message. Oracle Database Advanced Queuing records the number of failed attempts to remove the message in the message history.

An application can specify the maximum number of retries supported on messages at the queue/topic level. If the number of failed attempts to remove a message exceeds this maximum, then the message is moved to an exception queue.

Oracle Database Advanced Queuing allows users to specify a `retry_delay` along with `max_retries`. This means that a message that has undergone a failed attempt at retrieving remains visible in the queue for dequeue after `retry_delay` interval. Until then it is in the `WAITING` state. The Oracle Database Advanced Queuing background process time manager enforces the retry delay property.

The maximum retries and retry delay are properties of the queue/topic. They can be set when the queue/topic is created or by using the alter method on the queue/topic. The default value for `MAX_RETRIES` is 5.

 **Note:**

Sharded queues does not support retry delay.

11.7.6 Asynchronously Receiving Messages Using MessageListener

The JMS client can receive messages asynchronously by setting the `MessageListener` using the `setMessageListener` method.

When a message arrives for the consumer, the `onMessage` method of the message listener is invoked with the message. The message listener can commit or terminate the receipt of the message. The message listener does not receive messages if the `JMS Connection` has been stopped. The `receive` call must not be used to receive messages once the message listener has been set for the consumer.

The JMS client can receive messages asynchronously for all consumers in the session by setting the `MessageListener` at the session. No other mode for receiving messages must be used in the session once the message listener has been set.

11.7.7 Exception Queues

An exception queue is a repository for all expired or unserviceable messages. Applications cannot directly enqueue into exception queues. However, an application that intends to handle these expired or unserviceable messages can receive/remove them from the exception queue.

To retrieve messages from exception queues, the JMS client must use the point-to-point interface. The exception queue for messages intended for a topic must be created in a queue table with multiple consumers enabled. Like any other queue, the exception queue must be enabled for receiving messages using the `start` method in the `AQOracleQueue` class. You get an exception if you try to enable it for enqueue.

Sharded queues now supports Exception Queues through the `DBMS_AQADM.CREATE_EXCEPTION_QUEUE` API.

```
PROCEDURE CREATE_EXCEPTION_QUEUE(  
    sharded_queue_name    IN VARCHAR2,  
    exception_queue_name  IN VARCHAR2 DEFAULT NULL,  
    multiple_consumers    IN BOOLEAN  DEFAULT FALSE,  
    storage_clause        IN VARCHAR2 DEFAULT NULL,
```

```
sort_list          IN VARCHAR DEFAULT NULL,  
comment           IN VARCHAR2 DEFAULT NULL  
);
```

The exception queue is an Oracle-specific message property called "JMS_OracleExcpQ" that can be set with the message before sending/publishing it. If an exception queue is not specified, then the default exception queue is used. For non-sharded queues, the default exception queue is automatically created when the queue table is created and is named `AQ$_queue_table_name_E`. By default, no exception queue is created for sharded queues.

Messages are moved to the exception queue under the following conditions:

- The message was not dequeued within the specified `timeToLive`.

For messages intended for more than one subscriber, the message is moved to the exception queue if one or more of the intended recipients is not able to dequeue the message within the specified `timeToLive`.

- The message was received successfully, but the application terminated the transaction that performed the `receive` because of an error while processing the message. The message is returned to the queue/topic and is available for any applications that are waiting to receive messages.

A `receive` is considered rolled back or undone if the application terminates the entire transaction, or if it rolls back to a savepoint that was taken before the `receive`.

Because this was a failed attempt to receive the message, its retry count is updated. If the retry count of the message exceeds the maximum value specified for the queue/topic where it resides, then it is moved to the exception queue.

If a message has multiple subscribers, then the message is moved to the exception queue only when all the recipients of the message have exceeded the retry limit.

 **Note:**

If a dequeue transaction failed because the server process died (including `ALTER SYSTEM KILL SESSION`) or `SHUTDOWN ABORT` on the instance, then `RETRY_COUNT` is not incremented.

11.8 JMS Propagation

This section contains these topics:

- [RemoteSubscriber](#)
- [Scheduling Propagation](#)
- [Enhanced Propagation Scheduling Capabilities](#)
- [Exception Handling During Propagation](#)

 **Note:**

Sharded queues does not support RemoteSubscriber, Scheduling Propagation, Enhanced Propagation Scheduling Capabilities, and Exception Handling During Propagation.

11.8.1 RemoteSubscriber

Oracle Database Advanced Queuing allows a subscriber at another database to subscribe to a topic. If a message published to the topic meets the criterion of the remote subscriber, then it is automatically propagated to the queue/topic at the remote database specified for the remote subscriber. Propagation is performed using database links and Oracle Net Services. This enables applications to communicate with each other without having to be connected to the same database.

There are two ways to implement remote subscribers:

- The `createRemoteSubscriber` method can be used to create a remote subscriber to/on the topic. The remote subscriber is specified as an instance of the class `AQjmsAgent`.
- The `AQjmsAgent` has a name and an address. The address consists of a queue/topic and the database link to the database of the subscriber.

There are two kinds of remote subscribers:

- The remote subscriber is a topic.
This occurs when no name is specified for the remote subscriber in the `AQjmsAgent` object and the address is a topic. The message satisfying the subscriber's subscription is propagated to the remote topic. The propagated message is now available to all the subscriptions of the remote topic that it satisfies.
- A specific remote recipient is specified for the message.
The remote subscription can be for a particular consumer at the remote database. If the name of the remote recipient is specified (in the `AQjmsAgent` object), then the message satisfying the subscription is propagated to the remote database for that recipient only. The recipient at the remote database uses the `TopicReceiver` interface to retrieve its messages. The remote subscription can also be for a point-to-point queue.

11.8.2 Scheduling Propagation

Propagation must be scheduled using the `schedule_propagation` method for every topic from which messages are propagated to target destination databases.

A schedule indicates the time frame during which messages can be propagated from the source topic. This time frame can depend on several factors such as network traffic, the load at the source database, the load at the destination database, and so on. The schedule therefore must be tailored for the specific source and destination. When a schedule is created, a job is automatically submitted to the `job_queue` facility to handle propagation.

The administrative calls for propagation scheduling provide great flexibility for managing the schedules. The duration or propagation window parameter of a

schedule specifies the time frame during which propagation must take place. If the duration is unspecified, then the time frame is an infinite single window. If a window must be repeated periodically, then a finite duration is specified along with a `next_time` function that defines the periodic interval between successive windows.

The propagation schedules defined for a queue can be changed or dropped at any time during the life of the queue. In addition there are calls for temporarily disabling a schedule (instead of dropping the schedule) and enabling a disabled schedule. A schedule is active when messages are being propagated in that schedule. All the administrative calls can be made irrespective of whether the schedule is active or not. If a schedule is active, then it takes a few seconds for the calls to be executed.

Job queue processes must be started for propagation to take place. At least 2 job queue processes must be started. The database links to the destination database must also be valid. The source and destination topics of the propagation must be of the same message type. The remote topic must be enabled for enqueue. The user of the database link must also have enqueue privileges to the remote topic.



See Also:

["Scheduling a Propagation"](#)

11.8.3 Enhanced Propagation Scheduling Capabilities

Catalog views defined for propagation provide the following information about active schedules:

- Name of the background process handling the schedule
- SID (session and serial number) for the session handling the propagation
- Instance handling a schedule (if using Oracle RAC)
- Previous successful execution of a schedule
- Next planned execution of a schedule

The following propagation statistics are maintained for each schedule, providing useful information to queue administrators for tuning:

- The total number of messages propagated in a schedule
- Total number of bytes propagated in a schedule
- Maximum number of messages propagated in a window
- Maximum number of bytes propagated in a window
- Average number of messages propagated in a window
- Average size of propagated messages
- Average time to propagate a message

Propagation has built-in support for handling failures and reporting errors. For example, if the database link specified is invalid, or if the remote database is unavailable, or if the remote topic/queue is not enabled for enqueueing, then the appropriate error message is reported. Propagation uses an exponential backoff scheme for retrying propagation from a schedule that encountered a failure. If a

schedule continuously encounters failures, then the first retry happens after 30 seconds, the second after 60 seconds, the third after 120 seconds and so forth. If the retry time is beyond the expiration time of the current window, then the next retry is attempted at the start time of the next window. A maximum of 16 retry attempts are made after which the schedule is automatically disabled.

 **Note:**

Once a retry attempt slips to the next propagation window, it will always do so; the exponential backoff scheme no longer governs retry scheduling. If the date function specified in the `next_time` parameter of `DBMS_AQADM.SCHEDULE_PROPAGATION()` results in a short interval between windows, then the number of unsuccessful retry attempts can quickly reach 16, disabling the schedule.

When a schedule is disabled automatically due to failures, the relevant information is written into the alert log. It is possible to check at any time if there were failures encountered by a schedule and if so how many successive failures were encountered, the error message indicating the cause for the failure and the time at which the last failure was encountered. By examining this information, an administrator can fix the failure and enable the schedule.

If propagation is successful during a retry, then the number of failures is reset to 0.

Propagation has built-in support for Oracle Real Application Clusters and is transparent to the user and the administrator. The job that handles propagation is submitted to the same instance as the owner of the queue table where the source topic resides. If at any time there is a failure at an instance and the queue table that stores the topic is migrated to a different instance, then the propagation job is also automatically migrated to the new instance. This minimizes the pinging between instances and thus offers better performance. Propagation has been designed to handle any number of concurrent schedules.

The number of `job_queue_processes` is limited to a maximum of 1000 and some of these can be used to handle jobs unrelated to propagation. Hence, propagation has built in support for multitasking and load balancing. The propagation algorithms are designed such that multiple schedules can be handled by a single snapshot (`job_queue`) process. The propagation load on a `job_queue` processes can be skewed based on the arrival rate of messages in the different source topics. If one process is overburdened with several active schedules while another is less loaded with many passive schedules, then propagation automatically redistributes the schedules among the processes such that they are loaded uniformly.

11.8.4 Exception Handling During Propagation

When a system error such as a network failure occurs, Oracle Database Advanced Queuing continues to attempt to propagate messages using an exponential back-off algorithm. In some situations that indicate application errors in queue-to-dblink propagations, Oracle Database Advanced Queuing marks messages as `UNDELIVERABLE` and logs a message in `alert.log`. Examples of such errors are when the remote queue does not exist or when there is a type mismatch between the source queue and the remote queue. The trace files in the `background_dump_dest` directory can provide additional information about the error.

When a new job queue process starts, it clears the mismatched type errors so the types can be reverified. If you have capped the number of job queue processes and propagation remains busy, then you might not want to wait for the job queue process to terminate and restart. Queue types can be reverified at any time using

`DBMS_AQADM.VERIFY_QUEUE_TYPES`.

 **Note:**

When a type mismatch is detected in queue-to-queue propagation, propagation stops and throws an error. In such situations you must query the `DBA_SCHEDULES` view to determine the last error that occurred during propagation to a particular destination. The message is not marked as `UNDELIVERABLE`.

11.9 Message Transformation with JMS AQ

A [transformation](#) can be defined to map messages of one format to another. Transformations are useful when applications that use different formats to represent the same information must be integrated. Transformations can be SQL expressions and PL/SQL functions. Message transformation is an Oracle Database Advanced Queuing extension to the standard JMS interface.

The transformations can be created using the `DBMS_TRANSFORM.create_transformation` procedure. Transformation can be specified for the following operations:

- Sending a message to a queue or topic
- Receiving a message from a queue or topic
- Creating a `TopicSubscriber`
- Creating a `RemoteSubscriber`. This enables propagation of messages between topics of different formats.

 **Note:**

JMS Sharded Queues does not support message transformation.

11.10 JMS Streaming

AQ JMS supports streaming with `enqueue` and `dequeue` for sharded queues through `AQjmsBytesMessage` and `AQjmsStreamMessage` for applications to send and receive large message data or payload.

JMS streaming reduces the memory requirement when dealing with large messages, by dividing the message payload into small chunks rather than sending or receiving a large contiguous array of bytes. As JMS standard does not have any streaming mechanism, AQ JMS will provide proprietary interfaces to expose AQ streaming `enqueue` and `dequeue` features. This allows users to easily use an existing java input output stream to send and receive message data or payload.

In order to allow the existing applications to work without any changes on upgrading database to RDBMS 12.2, the streaming APIs will be disabled by default.

The client application can enable JMS Streaming by using the system property `oracle.jms.useJmsStreaming` set to `true`.

**Note:**

JMS Streaming is supported only for thin drivers.

11.10.1 JMS Streaming with Enqueue

AQ JMS provides the new API `setInputStream(java.io.InputStream)` in `AQjmsBytesMessage` and `AQjmsStreamMessage`, to set an input stream for message data.

```
/**
 * @param inputStream - InputStream to read the message payload
 * @throws JMSEException - if the JMS provided fails to read the payload due to
 *                         some internal error
 */
public void setInputStream(InputStream inputStream) throws JMSEException
```

The following code snippet creates a message of type `AQjmsBytesMessage` and sets a `FileInputStream` for the message data.

```
Session session = connection.createSession(false, Session.CLIENT_ACKNOWLEDGE);
Destination destination = session.createQueue("queueName");
MessageProducer producer = session.createProducer(destination);

AQjmsBytesMessage bytesMessage =
(AQjmsBytesMessage)session.createBytesMessage();
InputStream input = new FileInputStream("somefile.data");
bytesMessage.setInputStream(input);
producer.send(bytesMessage);
```

 **Note:**

- The methods in `BytesMessage` and `StreamMessage` are based on the methods found in `java.io.DataInputStream` and `java.io.DataOutputStream`, and hence, meaningful conversion of various `read*()` and `write*()` methods is not possible with streaming. The following scenarios will result in an exception:
 - `bytesMessage.setInputStream(input);`
`bytesMessage.writeInt(99);`
 - `bytesMessage.writeInt(99);`
`bytesMessage.setInputStream(input);`
- As with normal enqueue operation, the enqueue with streaming is going to be a synchronous one and we will return the control to the client only after the enqueue is complete.
- Streaming will be used with enqueue only when these APIs are explicitly used by the client. AQ JMS will not use streaming with enqueue with the normal enqueue, irrespective of the size of the message data.

11.10.2 JMS Streaming with Dequeue

The dequeue operation with streaming is achieved in two steps. The server decides whether to stream the message body or not based on the size of the message body. The default threshold limit is 10 MB. So when the message body is greater than 10MB and streaming is enabled by the client using the system property `oracle.jms.useJmsStreaming`, server will use streaming with dequeue.

- This is the normal dequeue process where a client calls the `receive()` method.

```
Destination destination = session.createQueue ("queueName");
AQjmsConsumer consumer = (AQjmsConsumer)
session.createConsumer(destination);
Message message = consumer.receive(10000);
```

- When the client receives the message without the payload, client can figure out whether the streaming is used for dequeue by calling `isLargeBody()` on the received message.

```
/**
 * This method can be used by the client applications to check whether the
 * message
 * contains large message body and hence requires streaming with dequeue.
 *
 * @return true when the message body is large and server decides to stream
 *         the payload with dequeue
 */
public boolean isLargeBody()
```

A value of `true` returned by `isLargeBody()` indicates streaming with dequeue. When the dequeue uses streaming, AQ JMS will populate the length of the message body properly for `AQjmsStreamMessage` along with `AQjmsBytesMessage`. So the client

application can call the `getBodyLength()` on the message to determine the size of the payload.

```
public long getBodyLength()
```

Once client has the understanding about the streaming with `dequeue`, the message data can be fetched by using one of the following APIs on the received message.

The client application can use on the following APIs available in `AQjmsBytesMessage` and `AQjmsStreamMessage` to receive the message data.

```
/**
 * Writes the message body to the OutputStream specified.
 *
 * @param outputStream - the OutputStream to which message body can be written
 * @return the OutputStream containing the message body.
 * @throws JMSEException - if the JMS provided fails to receive the message body
 *                          due to some internal error
 */
public OutputStream getBody(OutputStream outputStream) throws JMSEException

/**
 * Writes the message body to the OutputStream specified, with chunkSize bytes
 * written at a time.
 *
 * @param outputStream - the OutputStream to which message body can be written
 * @param chunkSize - the number of bytes to be written at a time, default value
 *                   8192 (ie. 8KB)
 * @return the OutputStream containing the message body.
 * @throws JMSEException - if the JMS provided fails to receive the message body
 *                          due to some internal error
 */
public OutputStream getBody(OutputStream outputStream, int chunkSize) throws
JMSEException

/**
 * Writes the message body to the OutputStream specified. This method waits
until
 * the message body is written completely to the OutputStream or the timeout
expires.
 *
 * A timeout of zero never expires, and a timeout of negative value is ignored.
 *
 * @param outputStream - the OutputStream to which message body can be written
 * @param timeout - the timeout value (in milliseconds)
 * @return the OutputStream containing the message body.
 * @throws JMSEException - if the JMS provided fails to receive the message body
 *                          due to some internal error
 */
public OutputStream getBody(OutputStream outputStream, long timeout) throws
JMSEException

/**
 * Writes the message body to the OutputStream specified, chunkSize bytes at a
time.
 * This method waits until the message body is written completely to the
OutputStream
 * or the timeout expires.
 *
 * A timeout of zero never expires, and a timeout of negative value is ignored.
```

```

*
* @param outputStream - the OutputStream to which message body can be written
* @param chunkSize - the number of bytes to be written at a time,
*                   default value 8192 (ie. 8KB)
* @param timeout - the timeout value (in milliseconds)
* @return the OutputStream containing the message body.
* @throws JMSEException - if the JMS provided fails to receive the message body
*                       due to some internal error
*/
public OutputStream getBody(OutputStream outputStream, int chunkSize, long
timeout) throws JMSEException

```

The following code snippet checks whether streaming is used with dequeue and the payload received will be written to a `FileOutputStream`.

```

    if (message instanceof BytesMessage && (AQjmsBytesMessage)message.isLargeBody())
    {
        // optional : check the size of the payload and take appropriate action
before
        // receiving the payload.
        (AQjmsBytesMessage) message.getBody(new FileOutputStream(new File("...")));
    } else {
        // normal dequeue
    }

```

In general, when both the steps are complete, the message is considered as consumed completely. The AQ server keeps a lock on the message after Step 1 which will be released only after Step 2.

Considering the possible issues with partially consumed messages by the message consumers, we have restricted the Streaming APIs for the session with acknowledgement modes `CLIENT_ACKNOWLEDGE` and `SESSION_TRANSACTED`.

So all the messages including partially consumed messages are considered fully consumed when:

- `message.acknowledge()` is called with `CLIENT_ACKNOWLEDGE` session.
- Session's `commit()` is called in a transacted session.

As in normal case, session `rollback()`, rolls back the messages received in that session.

The JMS Streaming is available with the following restrictions:

- Streaming is disabled by default, and can be enabled by the client application using the system property `oracle.jms.useJmsStreaming`
- Dequeue uses streaming when the size of the message data is more than the threshold value. The default threshold value is 10 MB.
- Streaming support is available with `AQjmsBytesMessage` and `AQjmsStreamMessage`
- Streaming support is available only for sharded queues
- Streaming support is available only with thin drivers
- Streaming support is not available when the message producer uses the message delivery mode as `NON_PERSISTENT`
- Streaming is not supported with message listener. So when a `MessageConsumer` has a message listener set and if the message data crosses threshold limit, internally we will use the normal dequeue.

- Streaming support is available with Sessions using acknowledgement modes `CLIENT_ACKNOWLEDGE` and `SESSION_TRANSACTED`.

11.11 Java EE Compliance

Oracle JMS conforms to the Oracle Sun Microsystems JMS 1.1 standard. You can define the Java EE compliance mode for an [Oracle Java Message Service](#) (Oracle JMS) client at runtime. For compliance, set the Java property `oracle.jms.j2eeCompliant` to `TRUE` as a command line option. For noncompliance, do nothing. `FALSE` is the default value.

Features in Oracle Database Advanced Queuing that support Java EE compliance (and are also available in the noncompliant mode) include:

- Nontransactional sessions
- Durable subscribers
- Temporary queues and topics
- Nonpersistent delivery mode
- Multiple JMS messages types on a single JMS [queue](#) or topic (using Oracle Database Advanced Queuing queues of the `AQ$_JMS_MESSAGE` type)
- The `noLocal` option for durable subscribers
- JMS Sharded Queues have native JMS support and conform to Java EE compliance

See Also:

- *Java Message Service Specification*, version 1.1, March 18, 2002, Sun Microsystems, Inc.
- "[JMS Message Headers](#)" for information on how the Java property `oracle.jms.j2eeCompliant` affects `JMSPriority` and `JMSExpiration`
- "[DurableSubscriber](#)" for information on how the Java property `oracle.jms.j2eeCompliant` affects durable subscribers

12

Oracle Java Message Service Basic Operations

The following topics describe the basic operational [Java Message Service \(JMS\)](#) administrative interface to Oracle Database Advanced Queuing (AQ).

- [EXECUTE Privilege on DBMS_AQIN](#)
- [Registering a ConnectionFactory](#)
- [Unregistering a Queue/Topic ConnectionFactory](#)
- [Getting a QueueConnectionFactory or TopicConnectionFactory](#)
- [Getting a Queue or Topic in LDAP](#)
- [Creating a Non-Shared Queue Table](#)
- [Creating a Queue](#)
- [Getting a Non-Shared Queue Table](#)
- [Granting and Revoking Privileges](#)
- [Managing Destinations](#)
- [Propagation Schedules](#)

12.1 EXECUTE Privilege on DBMS_AQIN

Users should never directly call methods in the `DBMS_AQIN` package, but they do need the `EXECUTE` privilege on `DBMS_AQIN`. Use the following syntax to accomplish this:

```
GRANT EXECUTE ON DBMS_AQIN to user;
```

12.2 Registering a ConnectionFactory

You can register a `ConnectionFactory` four ways:

- [Registering Through the Database Using JDBC Connection Parameters](#)
- [Registering Through the Database Using a JDBC URL](#)
- [Registering Through LDAP Using JDBC Connection Parameters](#)
- [Registering Through LDAP Using a JDBC URL](#)

12.2.1 Registering Through the Database Using JDBC Connection Parameters

```
public static int registerConnectionFactory(java.sql.Connection connection,  
                                         java.lang.String conn_name,  
                                         java.lang.String hostname,  
                                         java.lang.String oracle_sid,
```

```

        int portno,
        java.lang.String driver,
        java.lang.String type)
throws JMSEException

```

This method registers a `QueueConnectionFactory` or `TopicConnectionFactory` through the database to a [Lightweight Directory Access Protocol \(LDAP\)](#) server with JDBC connection parameters. This method is static and has the following parameters:

Parameter	Description
<code>connection</code>	JDBC connection used in registration
<code>conn_name</code>	Name of the connection to be registered
<code>hostname</code>	Name of the host running Oracle Database Advanced Queuing
<code>oracle_sid</code>	Oracle system identifier
<code>portno</code>	Port number
<code>driver</code>	JDBC driver type
<code>type</code>	Connection factory type (<code>QUEUE</code> or <code>TOPIC</code>)

The database connection passed to `registerConnectionFactory` must be granted `AQ_ADMINISTRATOR_ROLE`. After registration, you can look up the connection factory using [Java Naming and Directory Interface \(JNDI\)](#).

Example 12-1 Registering Through the Database Using JDBC Connection Parameters

```

String          url;
java.sql.Connection db_conn;

url = "jdbc:oracle:thin:@sun-123:1521:db1";
db_conn = DriverManager.getConnection(url, "scott", "tiger");
AQjmsFactory.registerConnectionFactory(
    db_conn, "queue_conn1", "sun-123", "db1", 1521, "thin", "queue");

```

12.2.2 Registering Through the Database Using a JDBC URL

```

public static int registerConnectionFactory(java.sql.Connection connection,
        java.lang.String conn_name,
        java.lang.String jdbc_url,
        java.util.Properties info,
        java.lang.String type)
throws JMSEException

```

This method registers a `QueueConnectionFactory` or `TopicConnectionFactory` through the database with a JDBC URL to LDAP. It is static and has the following parameters:

Parameter	Description
<code>connection</code>	JDBC connection used in registration
<code>conn_name</code>	Name of the connection to be registered
<code>jdbc_url</code>	URL to connect to
<code>info</code>	Properties information
<code>portno</code>	Port number

Parameter	Description
type	Connection factory type (QUEUE or TOPIC)

The database connection passed to `registerConnectionFactory` must be granted `AQ_ADMINISTRATOR_ROLE`. After registration, you can look up the connection factory using JNDI.

Example 12-2 Registering Through the Database Using a JDBC URL

```
String          url;
java.sql.Connection db_conn;

url = "jdbc:oracle:thin:@sun-123:1521:db1";
db_conn = DriverManager.getConnection(url, "scott", "tiger");
AQjmsFactory.registerConnectionFactory(
    db_conn, "topic_conn1", url, null, "topic");
```

12.2.3 Registering Through LDAP Using JDBC Connection Parameters

```
public static int registerConnectionFactory(java.util.Hashtable env,
                                           java.lang.String conn_name,
                                           java.lang.String hostname,
                                           java.lang.String oracle_sid,
                                           int portno,
                                           java.lang.String driver,
                                           java.lang.String type)
    throws JMSEException
```

This method registers a `QueueConnectionFactory` or `TopicConnectionFactory` through LDAP with JDBC connection parameters to LDAP. It is static and has the following parameters:

Parameter	Description
env	Environment of LDAP connection
conn_name	Name of the connection to be registered
hostname	Name of the host running Oracle Database Advanced Queuing
oracle_sid	Oracle system identifier
portno	Port number
driver	JDBC driver type
type	Connection factory type (QUEUE or TOPIC)

The hash table passed to `registerConnectionFactory()` must contain all the information to establish a valid connection to the LDAP server. Furthermore, the connection must have write access to the connection factory entries in the LDAP server (which requires the LDAP user to be either the database itself or be granted `GLOBAL_AQ_USER_ROLE`). After registration, look up the connection factory using JNDI.

Example 12-3 Registering Through LDAP Using JDBC Connection Parameters

```
Hashtable          env = new Hashtable(5, 0.75f);
/* the following statements set in hashtable env:
```

```

    * service provider package
    * the URL of the ldap server
    * the distinguished name of the database server
    * the authentication method (simple)
    * the LDAP username
    * the LDAP user password
*/
env.put(Context.INITIAL_CONTEXT_FACTORY, "com.sun.jndi.ldap.LdapCtxFactory");
env.put(Context.PROVIDER_URL, "ldap://sun-456:389");
env.put("searchbase", "cn=db1,cn=Oraclecontext,cn=acme,cn=com");
env.put(Context.SECURITY_AUTHENTICATION, "simple");
env.put(Context.SECURITY_PRINCIPAL, "cn=db1aqadmin,cn=acme,cn=com");
env.put(Context.SECURITY_CREDENTIALS, "welcome");

AQjmsFactory.registerConnectionFactory(env,
                                     "queue_conn1",
                                     "sun-123",
                                     "db1",
                                     1521,
                                     "thin",
                                     "queue");

```

12.2.4 Registering Through LDAP Using a JDBC URL

```

public static int registerConnectionFactory(java.util.Hashtable env,
                                         java.lang.String conn_name,
                                         java.lang.String jdbc_url,
                                         java.util.Properties info,
                                         java.lang.String type)
    throws JMSEException

```

This method registers a `QueueConnectionFactory` or `TopicConnectionFactory` through LDAP with JDBC connection parameters to LDAP. It is static and has the following parameters:

Parameter	Description
<code>env</code>	Environment of LDAP connection
<code>conn_name</code>	Name of the connection to be registered
<code>jdbc_url</code>	URL to connect to
<code>info</code>	Properties information
<code>type</code>	Connection factory type (<code>QUEUE</code> or <code>TOPIC</code>)

The hash table passed to `registerConnectionFactory()` must contain all the information to establish a valid connection to the LDAP server. Furthermore, the connection must have write access to the connection factory entries in the LDAP server (which requires the LDAP user to be either the database itself or be granted `GLOBAL_AQ_USER_ROLE`). After registration, look up the connection factory using JNDI.

Example 12-4 Registering Through LDAP Using a JDBC URL

```

String          url;
Hashtable      env = new Hashtable(5, 0.75f);

/* the following statements set in hashtable env:
   * service provider package
   * the URL of the ldap server

```

```

    * the distinguished name of the database server
    * the authentication method (simple)
    * the LDAP username
    * the LDAP user password
*/
env.put(Context.INITIAL_CONTEXT_FACTORY, "com.sun.jndi.ldap.LdapCtxFactory");
env.put(Context.PROVIDER_URL, "ldap://sun-456:389");
env.put("searchbase", "cn=db1,cn=Oraclecontext,cn=acme,cn=com");
env.put(Context.SECURITY_AUTHENTICATION, "simple");
env.put(Context.SECURITY_PRINCIPAL, "cn=db1aqadmin,cn=acme,cn=com");
env.put(Context.SECURITY_CREDENTIALS, "welcome");
url = "jdbc:oracle:thin:@sun-123:1521:db1";
AQjmsFactory.registerConnectionFactory(env, "topic_conn1", url, null, "topic");

```

12.3 Unregistering a Queue/Topic ConnectionFactory

You can unregister a queue/topic `ConnectionFactory` in LDAP two ways:

- [Unregistering Through the Database](#)
- [Unregistering Through LDAP](#)

12.3.1 Unregistering Through the Database

```

public static int unregisterConnectionFactory(java.sql.Connection connection,
                                             java.lang.String conn_name)
                                             throws JMSEException

```

This method unregisters a `QueueConnectionFactory` or `TopicConnectionFactory` in LDAP. It is static and has the following parameters:

Parameter	Description
connection	JDBC connection used in registration
conn_name	Name of the connection to be registered

The database connection passed to `unregisterConnectionFactory()` must be granted `AQ_ADMINISTRATOR_ROLE`.

Example 12-5 Unregistering Through the Database

```

String          url;
java.sql.Connection db_conn;

url = "jdbc:oracle:thin:@sun-123:1521:db1";
db_conn = DriverManager.getConnection(url, "scott", "tiger");
AQjmsFactory.unregisterConnectionFactory(db_conn, "topic_conn1");

```

12.3.2 Unregistering Through LDAP

```

public static int unregisterConnectionFactory(java.util.Hashtable env,
                                             java.lang.String conn_name)
                                             throws JMSEException

```

This method unregisters a `QueueConnectionFactory` or `TopicConnectionFactory` in LDAP. It is static and has the following parameters:

Parameter	Description
env	Environment of LDAP connection
conn_name	Name of the connection to be registered

The hash table passed to `unregisterConnectionFactory()` must contain all the information to establish a valid connection to the LDAP server. Furthermore, the connection must have write access to the connection factory entries in the LDAP server (which requires the LDAP user to be either the database itself or be granted `GLOBAL_AQ_USER_ROLE`).

Example 12-6 Unregistering Through LDAP

```
Hashtable env = new Hashtable(5, 0.75f);

/* the following statements set in hashtable env:
 * service provider package
 * the distinguished name of the database server
 * the authentication method (simple)
 * the LDAP username
 * the LDAP user password
 */
env.put(Context.INITIAL_CONTEXT_FACTORY, "com.sun.jndi.ldap.LdapCtxFactory");
env.put(Context.PROVIDER_URL, "ldap://sun-456:389");
env.put("searchbase", "cn=db1,cn=Oraclecontext,cn=acme,cn=com");
env.put(Context.SECURITY_AUTHENTICATION, "simple");
env.put(Context.SECURITY_PRINCIPAL, "cn=db1aqadmin,cn=acme,cn=com");
env.put(Context.SECURITY_CREDENTIALS, "welcome");
url = "jdbc:oracle:thin:@sun-123:1521:db1";
AQjmsFactory.unregisterConnectionFactory(env, "queue_conn1");
```

12.4 Getting a QueueConnectionFactory or TopicConnectionFactory

This section contains these topics:

- [Getting a QueueConnectionFactory with JDBC URL](#)
- [Getting a QueueConnectionFactory with JDBC Connection Parameters](#)
- [Getting a TopicConnectionFactory with JDBC URL](#)
- [Getting a TopicConnectionFactory with JDBC Connection Parameters](#)
- [Getting a QueueConnectionFactory or TopicConnectionFactory in LDAP](#)

12.4.1 Getting a QueueConnectionFactory with JDBC URL

```
public static javax.jms.QueueConnectionFactory getQueueConnectionFactory(
    java.lang.String jdbc_url,
    java.util.Properties info)
    throws JMSEException
```

This method gets a `QueueConnectionFactory` with JDBC URL. It is static and has the following parameters:

Parameter	Description
jdbc_url	URL to connect to
info	Properties information

Example 12-7 Getting a QueueConnectionFactory with JDBC URL

```
String url = "jdbc:oracle:oci10:internal/oracle"
Properties info = new Properties();
QueueConnectionFactory qc_fact;

info.put("internal_logon", "sysdba");
qc_fact = AQjmsFactory.getQueueConnectionFactory(url, info);
```

12.4.2 Getting a QueueConnectionFactory with JDBC Connection Parameters

```
public static javax.jms.QueueConnectionFactory getQueueConnectionFactory(
    java.lang.String hostname,
    java.lang.String oracle_sid,
    int portno,
    java.lang.String driver)
    throws JMSEException
```

This method gets a `QueueConnectionFactory` with JDBC connection parameters. It is static and has the following parameters:

Parameter	Description
hostname	Name of the host running Oracle Database Advanced Queuing
oracle_sid	Oracle system identifier
portno	Port number
driver	JDBC driver type

Example 12-8 Getting a QueueConnectionFactory with JDBC Connection Parameters

```
String host = "dlsun";
String ora_sid = "rdbms10i";
String driver = "thin";
int port = 5521;
QueueConnectionFactory qc_fact;

qc_fact = AQjmsFactory.getQueueConnectionFactory(host, ora_sid, port, driver);
```

12.4.3 Getting a TopicConnectionFactory with JDBC URL

```
public static javax.jms.TopicConnectionFactory getQueueConnectionFactory(
    java.lang.String jdbc_url,
    java.util.Properties info)
    throws JMSEException
```

This method gets a `TopicConnectionFactory` with a JDBC URL. It is static and has the following parameters:

Parameter	Description
jdbc_url	URL to connect to
info	Properties information

Example 12-9 Getting a TopicConnectionFactory with JDBC URL

```
String url = "jdbc:oracle:oci10:internal/oracle"
Properties info = new Properties();
TopicConnectionFactory tc_fact;

info.put("internal_logon", "sysdba");
tc_fact = AQjmsFactory.getTopicConnectionFactory(url, info);
```

12.4.4 Getting a TopicConnectionFactory with JDBC Connection Parameters

```
public static javax.jms.TopicConnectionFactory getTopicConnectionFactory(
    java.lang.String hostname,
    java.lang.String oracle_sid,
    int portno,
    java.lang.String driver)
    throws JMSEException
```

This method gets a `TopicConnectionFactory` with JDBC connection parameters. It is static and has the following parameters:

Parameter	Description
hostname	Name of the host running Oracle Database Advanced Queuing
oracle_sid	Oracle system identifier
portno	Port number
driver	JDBC driver type

Example 12-10 Getting a TopicConnectionFactory with JDBC Connection Parameters

```
String host = "dlsun";
String ora_sid = "rdbms10i";
String driver = "thin";
int port = 5521;
TopicConnectionFactory tc_fact;

tc_fact = AQjmsFactory.getTopicConnectionFactory(host, ora_sid, port, driver);
```

12.4.5 Getting a QueueConnectionFactory or TopicConnectionFactory in LDAP

This method gets a `QueueConnectionFactory` or `TopicConnectionFactory` from LDAP.

Example 12-11 Getting a QueueConnectionFactory or TopicConnectionFactory in LDAP

```
Hashtable          env = new Hashtable(5, 0.75f);
DirContext         ctx;
queueConnectionFactory qc_fact;

/* the following statements set in hashtable env:
 * service provider package
 * the URL of the ldap server
 * the distinguished name of the database server
 * the authentication method (simple)
 * the LDAP username
 * the LDAP user password
 */
env.put(Context.INITIAL_CONTEXT_FACTORY, "com.sun.jndi.ldap.LdapCtxFactory");
env.put(Context.PROVIDER_URL, "ldap://sun-456:389");
env.put(Context.SECURITY_AUTHENTICATION, "simple");
env.put(Context.SECURITY_PRINCIPAL, "cn=dblaquser1,cn=acme,cn=com");
env.put(Context.SECURITY_CREDENTIALS, "welcome");

ctx = new InitialDirContext(env);
ctx =
(DirContext)ctx.lookup("cn=OracleDBConnections,cn=db1,cn=Oraclecontext,cn=acme,cn=com");
qc_fact = (queueConnectionFactory)ctx.lookup("cn=queue_conn1");
```

12.5 Getting a Queue or Topic in LDAP

This method gets a queue or topic from LDAP.

Example 12-12 Getting a Queue or Topic in LDAP

```
Hashtable          env = new Hashtable(5, 0.75f);
DirContext         ctx;
topic              topic_1;

/* the following statements set in hashtable env:
 * service provider package
 * the URL of the ldap server
 * the distinguished name of the database server
 * the authentication method (simple)
 * the LDAP username
 * the LDAP user password
 */
env.put(Context.INITIAL_CONTEXT_FACTORY, "com.sun.jndi.ldap.LdapCtxFactory");
env.put(Context.PROVIDER_URL, "ldap://sun-456:389");
env.put(Context.SECURITY_AUTHENTICATION, "simple");
env.put(Context.SECURITY_PRINCIPAL, "cn=dblaquser1,cn=acme,cn=com");
env.put(Context.SECURITY_CREDENTIALS, "welcome");

ctx = new InitialDirContext(env);
ctx =
(DirContext)ctx.lookup("cn=OracleDBQueues,cn=db1,cn=Oraclecontext,cn=acme,cn=com");
topic_1 = (topic)ctx.lookup("cn=topic_1");
```

12.6 Creating a Non-Shared Queue Table

```
public oracle.AQ.AQQueueTable createQueueTable(
    java.lang.String owner,
    java.lang.String name,
    oracle.AQ.AQQueueTableProperty property)
    throws JMSEException
```

This method creates a [queue table](#). It has the following parameters:

Parameter	Description
owner	Queue table owner (schema)
name	Queue table name
property	Queue table properties

If the queue table is used to hold queues, then the queue table must not be multiconsumer enabled (default). If the queue table is used to hold topics, then the queue table must be multiconsumer enabled.

[CLOB](#), [BLOB](#), and [BFILE](#) objects are valid attributes for an Oracle Database Advanced Queuing [object type](#) load. However, only CLOB and BLOB can be propagated using Oracle Database Advanced Queuing [propagation](#) in Oracle8i and after.



Note:

Currently JMS Sharded Queues can be created and dropped only through the DBMS_AQADM PL/SQL APIs.

Example 12-13 Creating a Queue Table

```
QueueSession          q_sess    = null;
AQQueueTable          q_table   = null;
AQQueueTableProperty qt_prop    = null;

qt_prop = new AQQueueTableProperty("SYS.AQ$_JMS_BYTES_MESSAGE");
q_table = ((AQjmsSession)q_sess).createQueueTable(
    "boluser", "bol_ship_queue_table", qt_prop);
```

12.7 Creating a Queue

This section contains these topics:

- [Creating a Point-to-Point Queue](#)
- [Creating a Publish/Subscribe Topic](#)
- [Creating a Sharded Queue for Point-to-Point Queue and Publish/Subscribe Topic](#)

12.7.1 Creating a Point-to-Point Queue

```
public javax.jms.Queue createQueue(
    oracle.AQ.AQQueueTable q_table,
    java.lang.String queue_name,
    oracle.jms.AQjmsDestinationProperty dest_property)
    throws JMSEException
```

This method creates a queue in a specified queue table. It has the following parameters:

Parameter	Description
q_table	Queue table in which the queue is to be created. The queue table must be single-consumer.
queue_name	Name of the queue to be created
dest_property	Queue properties

This method is specific to Oracle JMS. You cannot use standard Java `javax.jms.Session` objects with it. Instead, you must cast the standard type to the Oracle JMS concrete class `oracle.jms.AQjmsSession`.

Example 12-14 Creating a Point-to-Point Queue

```
QueueSession          q_sess;
AQQueueTable          q_table;
AQjmsDestinationProperty dest_prop;
Queue                 queue;

queue = ((AQjmsSession)q_sess).createQueue(q_table, "jms_q1", dest_prop);
```

12.7.2 Creating a Publish/Subscribe Topic

```
public javax.jms.Topic createTopic(
    oracle.AQ.AQQueueTable q_table,
    java.lang.String topic_name,
    oracle.jms.AQjmsDestinationProperty dest_property)
    throws JMSEException
```

This method creates a topic in the [publish/subscribe](#) model. It has the following parameters:

Parameter	Description
q_table	Queue table in which the queue is to be created. The queue table must be multiconsumer.
queue_name	Name of the queue to be created
dest_property	Queue properties

This method is specific to Oracle JMS. You cannot use standard Java `javax.jms.Session` objects with it. Instead, you must cast the standard type to the Oracle JMS concrete class `oracle.jms.AQjmsSession`.

In [Example 12-16](#), if an order cannot be filled because of insufficient inventory, then the transaction processing the order is terminated. The `bookedorders` topic is set up

with `max_retries = 4` and `retry_delay = 12` hours. Thus, if an order is not filled up in two days, then it is moved to an exception queue.

Example 12-15 Creating a Publish/Subscribe Topic

```
TopicSession          t_sess;
AQQueueTable          q_table;
AqjmsDestinationProperty dest_prop;
Topic                 topic;

topic = ((AQjmsSessa)t_sess).createTopic(q_table, "jms_t1", dest_prop);
```

Example 12-16 Specifying Max Retries and Max Delays in Messages

```
public BolOrder process_booked_order(TopicSession jms_session)
{
    Topic          topic;
    TopicSubscriber tsubs;
    ObjectMessage  obj_message;
    BolCustomer    customer;
    BolOrder       booked_order = null;
    String         country;
    int            i = 0;

    try
    {
        /* get a handle to the OE_bookedorders_topic */
        topic = ((AQjmsSession)jms_session).getTopic("WS",
                                                    "WS_bookedorders_topic");

        /* Create local subscriber - to track messages for Western Region */
        tsubs = jms_session.createDurableSubscriber(topic, "SUBS1",
                                                    "Region = 'Western' ",
                                                    false);

        /* wait for a message to show up in the topic */
        obj_message = (ObjectMessage)tsubs.receive(10);

        booked_order = (BolOrder)obj_message.getObject();

        customer = booked_order.getCustomer();
        country   = customer.getCountry();

        if (country == "US")
        {
            jms_session.commit();
        }
        else
        {
            jms_session.rollback();
            booked_order = null;
        }
    } catch (JMSEException ex)
    { System.out.println("Exception " + ex) ;}

    return booked_order;
}
```

12.7.3 Creating a Sharded Queue for Point-to-Point Queue and Publish/Subscribe Topic

AQ JMS has defined a new APIs to create and drop sharded queues. There is no alter queue API in JMS. The signatures are as follows:

```

/**
 * Create a JMS sharded queue. It also internally creates the related queue
 * objects (table, indexes) based on this name.
 *
 * @param queueName name of the queue to be created, format is schema.queueName
 *           (where the schema. is optional)
 * @param isMultipleConsumer flag to indicate whether the queue is a
 *           multi-consumer or single-consumer queue
 * @return javax.jms.Destination
 * @throws JMSEException if the queue could not be created
 */
public synchronized javax.jms.Destination createJMSShardedQueue(String queueName,
    boolean isMultipleConsumer) throws JMSEException {
    return createJMSShardedQueue(queueName, isMultipleConsumer, null, 0, null);
}

/**
 * Create a JMS sharded queue. It also internally creates the related queue
 * objects (table, indexes) based on this name.
 *
 * @param queueName name of the queue to be created, format is schema.queueName
 *           (where the schema. is optional)
 * @param isMultipleConsumer flag to indicate whether the queue is a
 *           multi-consumer or single-consumer queue
 * @param storageClause additional storage clause
 * @param maxRetries retry count before skip the message while dequeue
 * @param comment comment for the queue
 * @return javax.jms.Destination
 * @throws JMSEException if the queue could not be created
 */
public Destination createJMSShardedQueue(java.lang.String queueName,
    boolean isMultipleConsumer,
    java.lang.String storageClause,
    int maxRetries,
    java.lang.String comment)
    throws JMSEException

```

12.8 Getting a Non-Sharded Queue Table

```

public oracle.AQ.AQQueueTable getQueueTable(java.lang.String owner,
    java.lang.String name)
    throws JMSEException

```

This method gets a queue table for a non-sharded queue. It has the following parameters:

Parameter	Description
owner	Queue table owner (schema)

Parameter	Description
name	Queue table name

If the caller that opened the connection is not the owner of the queue table, then the caller must have Oracle Database Advanced Queuing [enqueue/dequeue](#) privileges on queues/topics in the queue table. Otherwise the queue table is not returned.

Example 12-17 Getting a Queue Table

```
QueueSession          q_sess;
AQQueueTable          q_table;

q_table = ((AQjmsSession)q_sess).getQueueTable(
    "boluser", "bol_ship_queue_table");
```

12.9 Granting and Revoking Privileges

This section contains these topics:

- [Granting Oracle Database Advanced Queuing System Privileges](#)
- [Revoking Oracle Database Advanced Queuing System Privileges](#)
- [Granting Publish/Subscribe Topic Privileges](#)
- [Revoking Publish/Subscribe Topic Privileges](#)
- [Granting Point-to-Point Queue Privileges](#)
- [Revoking Point-to-Point Queue Privileges](#)

12.9.1 Granting Oracle Database Advanced Queuing System Privileges

```
public void grantSystemPrivilege(java.lang.String privilege,
                                java.lang.String grantee,
                                boolean admin_option)
    throws JMSEException
```

This method grants Oracle Database Advanced Queuing system privileges to a user or role.

Parameter	Description
privilege	ENQUEUE_ANY, DEQUEUE_ANY or MANAGE_ANY
grantee	Grantee (user, role, or PUBLIC)
admin_option	If this is set to true, then the grantee is allowed to use this procedure to grant the system privilege to other users or roles

Initially only `SYS` and `SYSTEM` can use this procedure successfully. Users granted the `ENQUEUE_ANY` privilege are allowed to enqueue messages to any queues in the database. Users granted the `DEQUEUE_ANY` privilege are allowed to dequeue messages from any queues in the database. Users granted the `MANAGE_ANY` privilege are allowed to run `DBMS_AQADM` calls on any schemas in the database.

Example 12-18 Granting Oracle Database Advanced Queuing System Privileges

```
TopicSession          t_sess;

((AQjmsSession)t_sess).grantSystemPrivilege("ENQUEUE_ANY", "scott", false);
```

12.9.2 Revoking Oracle Database Advanced Queuing System Privileges

```
public void revokeSystemPrivilege(java.lang.String privilege,
                                   java.lang.String grantee)
                                   throws JMSEException
```

This method revokes Oracle Database Advanced Queuing system privileges from a user or role. It has the following parameters:

Parameter	Description
privilege	ENQUEUE_ANY, DEQUEUE_ANY or MANAGE_ANY
grantee	Grantee (user, role, or PUBLIC)

Users granted the `ENQUEUE_ANY` privilege are allowed to enqueue messages to any queues in the database. Users granted the `DEQUEUE_ANY` privilege are allowed to dequeue messages from any queues in the database. Users granted the `MANAGE_ANY` privilege are allowed to run `DBMS_AQADM` calls on any schemas in the database.

Example 12-19 Revoking Oracle Database Advanced Queuing System Privileges

```
TopicSession          t_sess;

((AQjmsSession)t_sess).revokeSystemPrivilege("ENQUEUE_ANY", "scott");
```

12.9.3 Granting Publish/Subscribe Topic Privileges

```
public void grantTopicPrivilege(javax.jms.Session session,
                                 java.lang.String privilege,
                                 java.lang.String grantee,
                                 boolean grant_option)
                                 throws JMSEException
```

This method grants a topic privilege in the publish/subscribe model. Initially only the queue table owner can use this procedure to grant privileges on the topic. It has the following parameters:

Parameter	Description
session	JMS session
privilege	ENQUEUE, DEQUEUE, or ALL (ALL means both.)
grantee	Grantee (user, role, or PUBLIC)
grant_option	If this is set to true, then the grantee is allowed to use this procedure to grant the system privilege to other users or roles

Example 12-20 Granting Publish/Subscribe Topic Privileges

```

TopicSession      t_sess;
Topic              topic;

((AQjmsDestination)topic).grantTopicPrivilege(
    t_sess, "ENQUEUE", "scott", false);

```

12.9.4 Revoking Publish/Subscribe Topic Privileges

```

public void revokeTopicPrivilege(javax.jms.Session session,
                                 java.lang.String privilege,
                                 java.lang.String grantee)
    throws JMSEException

```

This method revokes a topic privilege in the publish/subscribe model. It has the following parameters:

Parameter	Description
session	JMS session
privilege	ENQUEUE, DEQUEUE, or ALL (ALL means both.)
grantee	Revoked grantee (user, role, or PUBLIC)

Example 12-21 Revoking Publish/Subscribe Topic Privileges

```

TopicSession      t_sess;
Topic              topic;

((AQjmsDestination)topic).revokeTopicPrivilege(t_sess, "ENQUEUE", "scott");

```

12.9.5 Granting Point-to-Point Queue Privileges

```

public void grantQueuePrivilege(javax.jms.Session session,
                                 java.lang.String privilege,
                                 java.lang.String grantee,
                                 boolean grant_option)
    throws JMSEException

```

This method grants a queue privilege in the point-to-point model. Initially only the queue table owner can use this procedure to grant privileges on the queue. It has the following parameters:

Parameter	Description
session	JMS session
privilege	ENQUEUE, DEQUEUE, or ALL (ALL means both.)
grantee	Grantee (user, role, or PUBLIC)
grant_option	If this is set to true, then the grantee is allowed to use this procedure to grant the system privilege to other users or roles

Example 12-22 Granting Point-to-Point Queue Privileges

```

QueueSession      q_sess;
Queue              queue;

```

```
((AQjmsDestination)queue).grantQueuePrivilege(
    q_sess, "ENQUEUE", "scott", false);
```

12.9.6 Revoking Point-to-Point Queue Privileges

```
public void revokeQueuePrivilege(javax.jms.Session session,
    java.lang.String privilege,
    java.lang.String grantee)
    throws JMSEException
```

This method revokes queue privileges in the point-to-point model. Initially only the queue table owner can use this procedure to grant privileges on the queue. It has the following parameters:

Parameter	Description
session	JMS session
privilege	ENQUEUE, DEQUEUE, or ALL (ALL means both.)
grantee	Revoked grantee (user, role, or PUBLIC)

To revoke a privilege, the revoker must be the original grantor of the privilege. Privileges propagated through the `GRANT` option are revoked if the grantor privilege is also revoked.

Example 12-23 Revoking Point-to-Point Queue Privileges

```
QueueSession      q_sess;
Queue              queue;

((AQjmsDestination)queue).revokeQueuePrivilege(q_sess, "ENQUEUE", "scott");
```

12.10 Managing Destinations

This section contains these topics:

- [Starting a Destination](#)
- [Stopping a Destination](#)
- [Altering a Destination](#)
- [Dropping a Destination](#)

Note:

Currently JMS Sharded Queues can be managed only through the `DBMS_AQADM` PL/SQL APIs.

12.10.1 Starting a Destination

```
public void start(javax.jms.Session session,
    boolean enqueue,
    boolean dequeue)
    throws JMSEException
```

This method starts a destination. It has the following parameters:

Parameter	Description
session	JMS session
enqueue	If set to <code>TRUE</code> , then enqueue is enabled
dequeue	If set to <code>TRUE</code> , then dequeue is enabled

Example 12-24 Starting a Destination

```
TopicSession t_sess;
QueueSession q_sess;
Topic        topic;
Queue        queue;

(AQjmsDestination)topic.start(t_sess, true, true);
(AQjmsDestination)queue.start(q_sess, true, true);
```

12.10.2 Stopping a Destination

```
public void stop(javax.jms.Session session,
                boolean enqueue,
                boolean dequeue,
                boolean wait)
    throws JMSEException
```

This method stops a destination. It has the following parameters:

Parameter	Description
session	JMS session
enqueue	If set to <code>TRUE</code> , then enqueue is disabled
dequeue	If set to <code>TRUE</code> , then dequeue is disabled
wait	If set to <code>true</code> , then pending transactions on the queue/topic are allowed to complete before the destination is stopped

Example 12-25 Stopping a Destination

```
TopicSession t_sess;
Topic        topic;

((AQjmsDestination)topic).stop(t_sess, true, false);
```

12.10.3 Altering a Destination

```
public void alter(javax.jms.Session session,
                 oracle.jms.AQjmsDestinationProperty dest_property)
    throws JMSEException
```

This method alters a destination. It has the following properties:

Parameter	Description
session	JMS session
dest_property	New properties of the queue or topic

Example 12-26 Altering a Destination

```

QueueSession q_sess;
Queue        queue;
TopicSession t_sess;
Topic        topic;
AQjmsDestionationProperty dest_prop1, dest_prop2;

((AQjmsDestination)queue).alter(dest_prop1);
((AQjmsDestination)topic).alter(dest_prop2);

```

12.10.4 Dropping a Destination

```

public void drop(javax.jms.Session session)
           throws JMSException

```

This method drops a destination. It has the following parameter:

Parameter	Description
session	JMS session

Example 12-27 Dropping a Destination

```

QueueSession q_sess;
Queue        queue;
TopicSession t_sess;
Topic        topic;

((AQjmsDestination)queue).drop(q_sess);
((AQjmsDestination)topic).drop(t_sess);

```

12.11 Propagation Schedules

This section contains these topics:

- [Scheduling a Propagation](#)
- [Enabling a Propagation Schedule](#)
- [Altering a Propagation Schedule](#)
- [Disabling a Propagation Schedule](#)
- [Unschedulering a Propagation](#)

Note:

JMS Sharded Queues are currently managed only through the `DBMS_AQADM` PL/SQL APIs and do not support propagation.

12.11.1 Scheduling a Propagation

```

public void schedulePropagation(javax.jms.Session session,
                               java.lang.String destination,
                               java.util.Date start_time,

```

```

        java.lang.Double duration,
        java.lang.String next_time,
        java.lang.Double latency)
    throws JMSEException

```

This method schedules a propagation. It has the following parameters:

Parameter	Description
session	JMS session
destination	Database link of the remote database for which propagation is being scheduled. A null string means that propagation is scheduled for all subscribers in the database of the topic.
start_time	Time propagation starts
duration	Duration of propagation
next_time	Next time propagation starts
latency	Latency in seconds that can be tolerated. Latency is the difference between the time a message was enqueued and the time it was propagated.

If a [message](#) has multiple recipients at the same destination in either the same or different queues, then it is propagated to all of them at the same time.

Example 12-28 Scheduling a Propagation

```

TopicSession t_sess;
Topic        topic;

((AQjmsDestination)topic).schedulePropagation(
    t_sess, null, null, null, null, new Double(0));

```

12.11.2 Enabling a Propagation Schedule

```

public void enablePropagationSchedule(javax.jms.Session session,
                                     java.lang.String destination)
    throws JMSEException

```

This method enables a propagation schedule. It has the following parameters:

Parameter	Description
session	JMS session
destination	Database link of the destination database. A null string means that propagation is to the local database.

Example 12-29 Enabling a Propagation Schedule

```

TopicSession    t_sess;
Topic            topic;

((AQjmsDestination)topic).enablePropagationSchedule(t_sess, "dbs1");

```

12.11.3 Altering a Propagation Schedule

```
public void alterPropagationSchedule(javax.jms.Session session,
                                   java.lang.String destination,
                                   java.lang.Double duration,
                                   java.lang.String next_time,
                                   java.lang.Double latency)
    throws JMSEException
```

This method alters a propagation schedule. It has the following parameters:

Parameter	Description
session	JMS session
destination	Database link of the remote database for which propagation is being scheduled. A null string means that propagation is scheduled for all subscribers in the database of the topic.
duration	Duration of propagation
next_time	Next time propagation starts
latency	Latency in seconds that can be tolerated. Latency is the difference between the time a message was enqueued and the time it was propagated.

Example 12-30 Altering a Propagation Schedule

```
TopicSession      t_sess;
Topic              topic;

((AQjmsDestination)topic).alterPropagationSchedule(
    t_sess, null, 30, null, new Double(30));
```

12.11.4 Disabling a Propagation Schedule

```
public void disablePropagationSchedule(javax.jms.Session session,
                                      java.lang.String destination)
    throws JMSEException
```

This method disables a propagation schedule. It has the following parameters:

Parameter	Description
session	JMS session
destination	Database link of the destination database. A null string means that propagation is to the local database.

Example 12-31 Disabling a Propagation Schedule

```
TopicSession      t_sess;
Topic              topic;

((AQjmsDestination)topic).disablePropagationSchedule(t_sess, "dbs1");
```

12.11.5 Unsheduling a Propagation

```
public void unschedulePropagation(javax.jms.Session session,  
                                java.lang.String destination)  
    throws JMSException
```

This method unsheds a previously scheduled propagation. It has the following parameters:

Parameter	Description
session	JMS session
destination	Database link of the destination database. A null string means that propagation is to the local database.

Example 12-32 Unsheduling a Propagation

```
TopicSession t_sess;  
Topic topic;  
  
((AQjmsDestination)topic).unschedulePropagation(t_sess, "dbs1");
```

13

Oracle Java Message Service Point-to-Point

The following topics describe the components of the Oracle Database Advanced Queuing (AQ) [Java Message Service \(JMS\)](#) operational interface that are specific to point-to-point operations. Components that are shared by point-to-point and publish/subscribe are described in [Oracle Java Message Service Shared Interfaces](#).

- [Creating a Connection with User Name/Password](#)
- [Creating a Connection with Default ConnectionFactory Parameters](#)
- [Creating a QueueConnection with User Name/Password](#)
- [Creating a QueueConnection with an Open JDBC Connection](#)
- [Creating a QueueConnection with Default ConnectionFactory Parameters](#)
- [Creating a QueueConnection with an Open OracleOCIConnectionPool](#)
- [Creating a Session](#)
- [Creating a QueueSession](#)
- [Creating a QueueSender](#)
- [Sending Messages Using a QueueSender with Default Send Options](#)
- [Sending Messages Using a QueueSender by Specifying Send Options](#)
- [Creating a QueueBrowser for Standard JMS Type Messages](#)
- [Creating a QueueBrowser for Standard JMS Type Messages_ Locking Messages](#)
- [Creating a QueueBrowser for Oracle Object Type Messages](#)
- [Creating a QueueBrowser for Oracle Object Type Messages_ Locking Messages](#)
- [Creating a QueueReceiver for Standard JMS Type Messages](#)
- [Creating a QueueReceiver for Oracle Object Type Messages](#)

13.1 Creating a Connection with User Name/Password

```
public javax.jms.Connection createConnection(  
    java.lang.String username,  
    java.lang.String password)  
    throws JMSException
```

This method creates a connection supporting both point-to-point and publish/subscribe operations with the specified user name and password. This method is new and supports JMS version 1.1 specifications. It has the following parameters:

Parameter	Description
username	Name of the user connecting to the database for queuing

Parameter	Description
password	Password for creating the connection to the server

13.2 Creating a Connection with Default ConnectionFactory Parameters

```
public javax.jms.Connection createConnection()
    throws JMSEException
```

This method creates a connection supporting both point-to-point and publish/subscribe operations with default [ConnectionFactory](#) parameters. This method is new and supports JMS version 1.1 specifications. If the `ConnectionFactory` properties do not contain a default user name and password, then it throws a `JMSEException`.

13.3 Creating a QueueConnection with User Name/Password

```
public javax.jms.QueueConnection createQueueConnection(
    java.lang.String username,
    java.lang.String password)
    throws JMSEException
```

This method creates a [queue](#) connection with the specified user name and password. It has the following parameters:

Parameter	Description
username	Name of the user connecting to the database for queuing
password	Password for creating the connection to the server

Example 13-1 Creating a QueueConnection with User Name/Password

```
QueueConnectionFactory qc_fact = AQjmsFactory.getQueueConnectionFactory(
    "sun123", "oratest", 5521, "thin");
QueueConnection qc_conn = qc_fact.createQueueConnection("jmsuser", "jmsuser");
```

13.4 Creating a QueueConnection with an Open JDBC Connection

```
public static javax.jms.QueueConnection createQueueConnection(
    java.sql.Connection jdbc_connection)
    throws JMSEException
```

This method creates a queue connection with an open JDBC connection. It is static and has the following parameter:

Parameter	Description
jdbc_connection	Valid open connection to the database

The method in [Example 13-2](#) can be used if the user wants to use an existing JDBC connection (say from a connection pool) for JMS operations. In this case JMS does not open a new connection, but instead uses the supplied JDBC connection to create the JMS `QueueConnection` object.

The method in [Example 13-3](#) is the only way to create a JMS `QueueConnection` when using JMS from a Java stored procedures inside the database (JDBC Server driver)

Example 13-2 Creating a QueueConnection with an Open JDBC Connection

```
Connection db_conn;      /* previously opened JDBC connection */
QueueConnection qc_conn = AQjmsQueueConnectionFactory.createQueueConnection(
    db_conn);
```

Example 13-3 Creating a QueueConnection from a Java Procedure Inside Database

```
OracleDriver ora = new OracleDriver();
QueueConnection qc_conn =
AQjmsQueueConnectionFactory.createQueueConnection(ora.defaultConnection());
```

13.5 Creating a QueueConnection with Default ConnectionFactory Parameters

```
public javax.jms.QueueConnection createQueueConnection()
    throws JMSEException
```

This method creates a queue connection with default [ConnectionFactory](#) parameters. If the queue connection factory properties do not contain a default user name and password, then it throws a `JMSEException`.

13.6 Creating a QueueConnection with an Open OracleOCIConnectionPool

```
public static javax.jms.QueueConnection createQueueConnection(
    oracle.jdbc.pool.OracleOCIConnectionPool cpool)
    throws JMSEException
```

This method creates a queue connection with an open `OracleOCIConnectionPool`. It is static and has the following parameter:

Parameter	Description
cpool	Valid open OCI connection pool to the database

The method in [Example 13-4](#) can be used if the user wants to use an existing `OracleOCIConnectionPool` instance for JMS operations. In this case JMS does not open an new `OracleOCIConnectionPool` instance, but instead uses the supplied `OracleOCIConnectionPool` instance to create the JMS `QueueConnection` object.

Example 13-4 Creating a QueueConnection with an Open OracleOCIConnectionPool

```
OracleOCIConnectionPool cpool; /* previously created OracleOCIConnectionPool */
QueueConnection qc_conn = AQjmsQueueConnectionFactory.createQueueConnection(cpool);
```

13.7 Creating a Session

```
public javax.jms.Session createSession(boolean transacted,
                                     int ack_mode)
    throws JMSEException
```

This method creates a `Session`, which supports both point-to-point and publish/subscribe operations. This method is new and supports JMS version 1.1 specifications. Transactional and [nontransactional](#) sessions are supported. It has the following parameters:

Parameter	Description
<code>transacted</code>	If set to true, then the session is transactional
<code>ack_mode</code>	Indicates whether the consumer or the client will acknowledge any messages it receives. It is ignored if the session is transactional. Legal values are <code>Session.AUTO_ACKNOWLEDGE</code> , <code>Session.CLIENT_ACKNOWLEDGE</code> , and <code>Session.DUPS_OK_ACKNOWLEDGE</code> .

13.8 Creating a QueueSession

```
public javax.jms.QueueSession createQueueSession(
    boolean transacted, int ack_mode)
    throws JMSEException
```

This method creates a `QueueSession`. Transactional and nontransactional sessions are supported. It has the following parameters:

Parameter	Description
<code>transacted</code>	If set to true, then the session is transactional
<code>ack_mode</code>	Indicates whether the consumer or the client will acknowledge any messages it receives. It is ignored if the session is transactional. Legal values are <code>Session.AUTO_ACKNOWLEDGE</code> , <code>Session.CLIENT_ACKNOWLEDGE</code> , and <code>Session.DUPS_OK_ACKNOWLEDGE</code> .

Example 13-5 Creating a Transactional QueueSession

```
QueueConnection qc_conn;
QueueSession q_sess = qc_conn.createQueueSession(true, 0);
```

13.9 Creating a QueueSender

```
public javax.jms.QueueSender createSender(javax.jms.Queue queue)
    throws JMSEException
```

This method creates a `QueueSender`. If a sender is created without a default queue, then the destination queue must be specified on every `send` operation. It has the following parameter:

Parameter	Description
queue	Name of destination queue

13.10 Sending Messages Using a QueueSender with Default Send Options

```
public void send(javax.jms.Queue queue,
                javax.jms.Message message)
    throws JMSEException
```

This method sends a `message` using a `QueueSender` with default send options. This operation uses default values for message priority (1) and `timeToLive` (infinite). It has the following parameters:

Parameter	Description
queue	Queue to send this message to
message	Message to send

If the `QueueSender` has been created with a default queue, then the `queue` parameter may not necessarily be supplied in the `send()` call. If a queue is specified in the `send()` operation, then this value overrides the default queue of the `QueueSender`.

If the `QueueSender` has been created without a default queue, then the `queue` parameter must be specified in every `send()` call.

Example 13-6 Creating a Sender to Send Messages to Any Queue

```
/* Create a sender to send messages to any queue */
QueueSession jms_sess;
QueueSender sender1;
TextMessage message;
sender1 = jms_sess.createSender(null);
sender1.send(queue, message);
```

Example 13-7 Creating a Sender to Send Messages to a Specific Queue

```
/* Create a sender to send messages to a specific queue */
QueueSession jms_sess;
QueueSender sender2;
Queue billed_orders_que;
TextMessage message;
sender2 = jms_sess.createSender(billed_orders_que);
sender2.send(queue, message);
```

13.11 Sending Messages Using a QueueSender by Specifying Send Options

```
public void send(javax.jms.Queue queue,
                javax.jms.Message message,
                int deliveryMode,
                int priority,
                long timeToLive)
    throws JMSEException
```

This method sends messages using a `QueueSender` by specifying send options. It has the following parameters:

Parameter	Description
<code>queue</code>	Queue to send this message to
<code>message</code>	Message to send
<code>deliveryMode</code>	Delivery mode to use
<code>priority</code>	Priority for this message
<code>timeToLive</code>	Message lifetime in milliseconds (zero is unlimited)

If the `QueueSender` has been created with a default queue, then the `queue` parameter may not necessarily be supplied in the `send()` call. If a queue is specified in the `send()` operation, then this value overrides the default queue of the `QueueSender`.

If the `QueueSender` has been created without a default queue, then the `queue` parameter must be specified in every `send()` call.

Example 13-8 Sending Messages Using a QueueSender by Specifying Send Options 1

```
/* Create a sender to send messages to any queue */
/* Send a message to new_orders_que with priority 2 and timetoLive 100000
   milliseconds */
QueueSession jms_sess;
QueueSender sender1;
TextMessage msg;
Queue new_orders_que
sender1 = jms_sess.createSender(null);
sender1.send(new_orders_que, msg, DeliveryMode.PERSISTENT, 2, 100000);
```

Example 13-9 Sending Messages Using a QueueSender by Specifying Send Options 2

```
/* Create a sender to send messages to a specific queue */
/* Send a message with priority 1 and timetoLive 400000 milliseconds */
QueueSession jms_sess;
QueueSender sender2;
Queue billed_orders_que;
TextMessage msg;
sender2 = jms_sess.createSender(billed_orders_que);
sender2.send(msg, DeliveryMode.PERSISTENT, 1, 400000);
```

13.12 Creating a QueueBrowser for Standard JMS Type Messages

```
public javax.jms.QueueBrowser createBrowser(javax.jms.Queue queue,
                                           java.lang.String messageSelector)
    throws JMSEException
```

This method creates a `QueueBrowser` for queues with text, stream, objects, bytes or `MapMessage` message bodies. It has the following parameters:

Parameter	Description
<code>queue</code>	Queue to access
<code>messageSelector</code>	Only messages with properties matching the <code>messageSelector</code> expression are delivered

Use methods in `java.util.Enumeration` to go through list of messages.

 **See Also:**
["MessageSelector"](#)

Example 13-10 Creating a QueueBrowser Without a Selector

```
/* Create a browser without a selector */
QueueSession  jms_session;
QueueBrowser  browser;
Queue         queue;
browser = jms_session.createBrowser(queue);
```

Example 13-11 Creating a QueueBrowser With a Specified Selector

```
/* Create a browser for queues with a specified selector */
QueueSession  jms_session;
QueueBrowser  browser;
Queue         queue;
/* create a Browser to look at messages with correlationID = RUSH */
browser = jms_session.createBrowser(queue, "JMSCorrelationID = 'RUSH'");
```

13.13 Creating a QueueBrowser for Standard JMS Type Messages, Locking Messages

```
public javax.jms.QueueBrowser createBrowser(javax.jms.Queue queue,
                                           java.lang.String messageSelector,
                                           boolean locked)
    throws JMSEException
```

This method creates a `QueueBrowser` for queues with `TextMessage`, `StreamMessage`, `ObjectMessage`, `BytesMessage`, or `MapMessage` message bodies, locking messages

while browsing. Locked messages cannot be removed by other consumers until the browsing session ends the transaction. It has the following parameters:

Parameter	Description
queue	Queue to access
messageSelector	Only messages with properties matching the messageSelector expression are delivered
locked	If set to true, then messages are locked as they are browsed (similar to a SELECT for UPDATE)

Example 13-12 Creating a QueueBrowser Without a Selector, Locking Messages

```
/* Create a browser without a selector */
QueueSession jms_session;
QueueBrowser browser;
Queue queue;
browser = jms_session.createBrowser(queue, null, true);
```

Example 13-13 Creating a QueueBrowser With a Specified Selector, Locking Messages

```
/* Create a browser for queues with a specified selector */
QueueSession jms_session;
QueueBrowser browser;
Queue queue;
/* create a Browser to look at messages with
correlationID = RUSH in lock mode */
browser = jms_session.createBrowser(queue, "JMScorrelationID = 'RUSH'", true);
```

13.14 Creating a QueueBrowser for Oracle Object Type Messages

```
public javax.jms.QueueBrowser createBrowser(javax.jms.Queue queue,
                                           java.lang.String messageSelector,
                                           java.lang.Object payload_factory)
    throws JMSEException
```

This method creates a `QueueBrowser` for queues of Oracle [object type](#) messages. It has the following parameters:

Parameter	Description
queue	Queue to access
messageSelector	Only messages with properties matching the messageSelector expression are delivered
payload_factory	<code>CustomDatumFactory</code> or <code>ORADatumFactory</code> for the java class that maps to the Oracle ADT

The `CustomDatumFactory` for a particular java class that maps to the SQL object payload can be obtained using the `getFactory` static method.

 **Note:**

`CustomDatum` support will be deprecated in a future release. Use `ORADDataFactory` payload factories instead.

Assume the queue `test_queue` has payload of type `SCOTT.EMPLOYEE` and the java class that is generated by Jpublisher for this Oracle object type is called `Employee`. The `Employee` class implements the `CustomDatum` interface. The `CustomDatumFactory` for this class can be obtained by using the `Employee.getFactory()` method.

 **Note:**

Sharded queues do not support Object Type messages

 **See Also:**

"MessageSelector"

Example 13-14 Creating a QueueBrowser for ADTMessages

```
/* Create a browser for a Queue with AdtMessage messages of type EMPLOYEE*/
QueueSession jms_session
QueueBrowser browser;
Queue        test_queue;
browser = ((AQjmsSession)jms_session).createBrowser(test_queue,
                                                    "corrid='EXPRESS'",
                                                    Employee.getFactory());
```

13.15 Creating a QueueBrowser for Oracle Object Type Messages, Locking Messages

```
public javax.jms.QueueBrowser createBrowser(javax.jms.Queue queue,
                                           java.lang.String messageSelector,
                                           java.lang.Object payload_factory,
                                           boolean locked)
    throws JMSEException
```

This method creates a `QueueBrowser` for queues of Oracle object type messages, locking messages while browsing. It has the following parameters:

Parameter	Description
<code>queue</code>	Queue to access
<code>messageSelector</code>	Only messages with properties matching the <code>messageSelector</code> expression are delivered

Parameter	Description
payload_factory	CustomDatumFactory or ORADDataFactory for the java class that maps to the Oracle ADT
locked	If set to true, then messages are locked as they are browsed (similar to a SELECT for UPDATE)

 **Note:**

CustomDatum support will be deprecated in a future release. Use ORADDataFactory payload factories instead.

 **Note:**

Sharded queues do not support Object Type messages

Example 13-15 Creating a QueueBrowser for AdtMessages, Locking Messages

```
/* Create a browser for a Queue with AdtMessage messages of type EMPLOYEE* in lock
mode/
QueueSession jms_session
QueueBrowser browser;
Queue        test_queue;
browser = ((AQjmsSession)jms_session).createBrowser(test_queue,
                                                    null,
                                                    Employee.getFactory(),
                                                    true);
```

13.16 Creating a QueueReceiver for Standard JMS Type Messages

```
public javax.jms.QueueReceiver createReceiver(javax.jms.Queue queue,
                                             java.lang.String messageSelector)
    throws JMSEException
```

This method creates a QueueReceiver for queues of standard JMS type messages. It has the following parameters:

Parameter	Description
queue	Queue to access
messageSelector	Only messages with properties matching the messageSelector expression are delivered

**See Also:**["MessageSelector"](#)**Example 13-16 Creating a QueueReceiver Without a Selector**

```

/* Create a receiver without a selector */
QueueSession  jms_session
QueueReceiver receiver;
Queue         queue;
receiver = jms_session.createReceiver(queue);

```

Example 13-17 Creating a QueueReceiver With a Specified Selector

```

/* Create a receiver for queues with a specified selector */
QueueSession  jms_session;
QueueReceiver receiver;
Queue         queue;
/* create Receiver to receive messages with correlationID starting with EXP */
browser = jms_session.createReceiver(queue, "JMSCorrelationID LIKE 'EXP%'");

```

13.17 Creating a QueueReceiver for Oracle Object Type Messages

```

public javax.jms.QueueReceiver createReceiver(javax.jms.Queue queue,
                                             java.lang.String messageSelector,
                                             java.lang.Object payload_factory)
    throws JMSEException

```

This method creates a `QueueReceiver` for queues of Oracle object type messages. It has the following parameters:

Parameter	Description
<code>queue</code>	Queue to access
<code>messageSelector</code>	Only messages with properties matching the <code>messageSelector</code> expression are delivered
<code>payload_factory</code>	<code>CustomDatumFactory</code> or <code>ORADDataFactory</code> for the java class that maps to the Oracle ADT

The `CustomDatumFactory` for a particular java class that maps to the SQL object type payload can be obtained using the `getFactory` static method.

**Note:**

`CustomDatum` support will be deprecated in a future release. Use `ORADDataFactory` payload factories instead.

Assume the queue `test_queue` has payload of type `SCOTT.EMPLOYEE` and the java class that is generated by Jpublisher for this Oracle object type is called `Employee`. The

Employee class implements the `CustomDatum` interface. The `ORADDataFactory` for this class can be obtained by using the `Employee.getFactory()` method.



Note:

Sharded queues do not support Object Type messages



See Also:

["MessageSelector"](#)

Example 13-18 Creating a QueueReceiver for AdtMessage Messages

```
/* Create a receiver for a Queue with AdtMessage messages of type EMPLOYEE*/
QueueSession jms_session
QueueReceiver receiver;
Queue test_queue;
browser = ((AQjmsSession)jms_session).createReceiver(
    test_queue,
    "JMSCorrelationID = 'MANAGER',
    Employee.getFactory());
```

Oracle Java Message Service Publish/Subscribe

The following topics describe the components of the Oracle Database Advanced Queuing (AQ) [Java Message Service \(JMS\)](#) operational interface that are specific to [publish/subscribe](#) operations. Components that are shared by point-to-point and [publish/subscribe](#) are described in [Oracle Java Message Service Shared Interfaces](#).

- [Creating a Connection with User Name/Password](#)
- [Creating a Connection with Default ConnectionFactory Parameters](#)
- [Creating a TopicConnection with User Name/Password](#)
- [Creating a TopicConnection with Open JDBC Connection](#)
- [Creating a TopicConnection with an Open OracleOCIConnectionPool](#)
- [Creating a Session](#)
- [Creating a TopicSession](#)
- [Creating a TopicPublisher](#)
- [Publishing Messages with Minimal Specification](#)
- [Publishing Messages Specifying Topic](#)
- [Publishing Messages Specifying Delivery Mode_ Priority_ and TimeToLive](#)
- [Publishing Messages Specifying a Recipient List](#)
- [Creating a DurableSubscriber for a JMS Topic Without Selector](#)
- [Creating a DurableSubscriber for a JMS Topic with Selector](#)
- [Creating a DurableSubscriber for an Oracle Object Type Topic Without Selector](#)
- [Creating a DurableSubscriber for an Oracle Object Type Topic with Selector](#)
- [Specifying Transformations for Topic Subscribers](#)
- [Creating a Remote Subscriber for JMS Messages](#)
- [Creating a Remote Subscriber for Oracle Object Type Messages](#)
- [Specifying Transformations for Remote Subscribers](#)
- [Unsubscribing a Durable Subscription for a Local Subscriber](#)
- [Unsubscribing a Durable Subscription for a Remote Subscriber](#)
- [Creating a TopicReceiver for a Topic of Standard JMS Type Messages](#)
- [Creating a TopicReceiver for a Topic of Oracle Object Type Messages](#)
- [Creating a TopicBrowser for Standard JMS Messages](#)
- [Creating a TopicBrowser for Standard JMS Messages_ Locking Messages](#)
- [Creating a TopicBrowser for Oracle Object Type Messages](#)

- [Creating a TopicBrowser for Oracle Object Type Messages_ Locking Messages](#)
- [Browsing Messages Using a TopicBrowser](#)

14.1 Creating a Connection with User Name/Password

```
public javax.jms.Connection createConnection(
    java.lang.String username,
    java.lang.String password)
    throws JMSEException
```

This method creates a connection supporting both point-to-point and publish/subscribe operations with the specified user name and password. This method is new and supports JMS version 1.1 specifications. It has the following parameters:

Parameter	Description
username	Name of the user connecting to the database for queuing
password	Password for creating the connection to the server

14.2 Creating a Connection with Default ConnectionFactory Parameters

```
public javax.jms.Connection createConnection()
    throws JMSEException
```

This method creates a connection supporting both point-to-point and publish/subscribe operations with default [ConnectionFactory](#) parameters. This method is new and supports JMS version 1.1 specifications. If the `ConnectionFactory` properties do not contain a default user name and password, then it throws a `JMSEException`.

14.3 Creating a TopicConnection with User Name/Password

```
public javax.jms.TopicConnection createTopicConnection(
    java.lang.String username,
    java.lang.String password)
    throws JMSEException
```

This method creates a `TopicConnection` with the specified user name and password. It has the following parameters:

Parameter	Description
username	Name of the user connecting to the database for queuing
password	Password for creating the connection to the server

Example 14-1 Creating a TopicConnection with User Name/Password

```
TopicConnectionFactory tc_fact = AQjmsFactory.getTopicConnectionFactory("sun123",
"oratest", 5521, "thin");
/* Create a TopicConnection using a username/password */
TopicConnection tc_conn = tc_fact.createTopicConnection("jmsuser", "jmsuser");
```

14.4 Creating a TopicConnection with Open JDBC Connection

```
public static javax.jms.TopicConnection createTopicConnection(
    java.sql.Connection jdbc_connection)
    throws JMSEException
```

This method creates a `TopicConnection` with open JDBC connection. It has the following parameter:

Parameter	Description
<code>jdbc_connection</code>	Valid open connection to database

Example 14-2 Creating a TopicConnection with Open JDBC Connection

```
Connection db_conn; /*previously opened JDBC connection */
TopicConnection tc_conn =
AQjmsTopicConnectionFactory.createTopicConnection(db_conn);
```

Example 14-3 Creating a TopicConnection with New JDBC Connection

```
OracleDriver ora = new OracleDriver();
TopicConnection tc_conn =
AQjmsTopicConnectionFactory.createTopicConnection(ora.defaultConnection());
```

14.5 Creating a TopicConnection with an Open OracleOCIConnectionPool

```
public static javax.jms.TopicConnection createTopicConnection(
    oracle.jdbc.pool.OracleOCIConnectionPool cpool)
    throws JMSEException
```

This method creates a `TopicConnection` with an open `OracleOCIConnectionPool`. It is static and has the following parameter:

Parameter	Description
<code>cpool</code>	Valid open OCI connection pool to the database

Example 14-4 Creating a TopicConnection with Open OracleOCIConnectionPool

```
OracleOCIConnectionPool cpool; /* previously created OracleOCIConnectionPool */
TopicConnection tc_conn =
AQjmsTopicConnectionFactory.createTopicConnection(cpool);
```

14.6 Creating a Session

```
public javax.jms.Session createSession(boolean transacted,
    int ack_mode)
    throws JMSEException
```

This method creates a `Session` supporting both point-to-point and publish/subscribe operations. It is new and supports JMS version 1.1 specifications. It has the following parameters:

Parameter	Description
<code>transacted</code>	If set to true, then the session is transactional
<code>ack_mode</code>	Indicates whether the consumer or the client will acknowledge any messages it receives. It is ignored if the session is transactional. Legal values are <code>Session.AUTO_ACKNOWLEDGE</code> , <code>Session.CLIENT_ACKNOWLEDGE</code> , and <code>Session.DUPS_OK_ACKNOWLEDGE</code> .

14.7 Creating a TopicSession

```
public javax.jms.TopicSession createTopicSession(boolean transacted,
                                                int ack_mode)
    throws JMSEException
```

This method creates a `TopicSession`. It has the following parameters:

Parameter	Description
<code>transacted</code>	If set to true, then the session is transactional
<code>ack_mode</code>	Indicates whether the consumer or the client will acknowledge any messages it receives. It is ignored if the session is transactional. Legal values are <code>Session.AUTO_ACKNOWLEDGE</code> , <code>Session.CLIENT_ACKNOWLEDGE</code> , and <code>Session.DUPS_OK_ACKNOWLEDGE</code> .

Example 14-5 Creating a TopicSession

```
TopicConnection tc_conn;
TopicSession t_sess = tc_conn.createTopicSession(true,0);
```

14.8 Creating a TopicPublisher

```
public javax.jms.TopicPublisher createPublisher(javax.jms.Topic topic)
    throws JMSEException
```

This method creates a `TopicPublisher`. It has the following parameter:

Parameter	Description
<code>topic</code>	Topic to publish to, or null if this is an unidentified producer

14.9 Publishing Messages with Minimal Specification

```
public void publish(javax.jms.Message message)
    throws JMSEException
```

This method publishes a message with minimal specification. It has the following parameter:

Parameter	Description
message	Message to send

The `TopicPublisher` uses the default values for `message` priority (1) and `timeToLive` (infinite).

Example 14-6 Publishing Without Specifying Topic

```

/* Publish without specifying topic */
TopicConnectionFactory tc_fact = null;
TopicConnection t_conn = null;
TopicSession jms_sess;
TopicPublisher publisher1;
Topic shipped_orders;
int myport = 5521;
/* create connection and session */
tc_fact = AQjmsFactory.getTopicConnectionFactory(
    "MYHOSTNAME",
    "MYSID",
    myport,
    "oci8");
t_conn = tc_fact.createTopicConnection("jmstopic", "jmstopic");
/* create TopicSession */
jms_sess = t_conn.createTopicSession(true, Session.CLIENT_ACKNOWLEDGE);
/* get shipped orders topic */
shipped_orders = ((AQjmsSession) jms_sess).getTopic(
    "OE",
    "Shipped_Orders_Topic");
publisher1 = jms_sess.createPublisher(shipped_orders);
/* create TextMessage */
TextMessage jms_sess.createTextMessage();
/* publish without specifying the topic */
publisher1.publish(text_message);

```

Example 14-7 Publishing Specifying Correlation and Delay

```

TopicConnectionFactory tc_fact = null;
TopicConnection t_conn = null;
TopicSession jms_sess;
TopicPublisher publisher1;
Topic shipped_orders;
int myport = 5521;
/* create connection and session */
tc_fact = AQjmsFactory.getTopicConnectionFactory(
    "MYHOSTNAME",
    "MYSID",
    myport,
    "oci8");
t_conn = tc_fact.createTopicConnection("jmstopic", "jmstopic");
jms_sess = t_conn.createTopicSession(true, Session.CLIENT_ACKNOWLEDGE);
shipped_orders = ((AQjmsSession) jms_sess).getTopic(
    "OE",
    "Shipped_Orders_Topic");
publisher1 = jms_sess.createPublisher(shipped_orders);
/* Create TextMessage */
TextMessage jms_sess.createTextMessage();
/* Set correlation and delay */
/* Set correlation */
jms_sess.setJMSCorrelationID("FOO");

```

```

/* Set delay of 30 seconds */
jms_sess.setLongProperty("JMS_OracleDelay", 30);
/* Publish */
publisher1.publish(text_message);

```

14.10 Publishing Messages Specifying Topic

```

public void publish(javax.jms.Topic topic, javax.jms.Message message)
    throws JMSEException

```

This method publishes a message specifying the topic. It has the following parameters:

Parameter	Description
topic	Topic to publish to
message	Message to send

If the `TopicPublisher` has been created with a default topic, then the `topic` parameter may not be specified in the `publish()` call. If a topic is specified, then that value overrides the default in the `TopicPublisher`. If the `TopicPublisher` has been created without a default topic, then the topic must be specified with the `publish()` call.

Example 14-8 Publishing Specifying Topic

```

/* Publish specifying topic */
TopicConnectionFactory tc_fact = null;
TopicConnection t_conn = null;
TopicSession jms_sess;
TopicPublisher publisher1;
Topic shipped_orders;
int myport = 5521;
/* create connection and session */
tc_fact = AQjmsFactory.getTopicConnectionFactory(
    'MYHOSTNAME', 'MYSID', myport, 'oci8');
t_conn = tc_fact.createTopicConnection("jmstopic", "jmstopic");
jms_sess = t_conn.createTopicSession(true, Session.CLIENT_ACKNOWLEDGE);
/* create TopicPublisher */
publisher1 = jms_sess.createPublisher(null);
/* get topic object */
shipped_orders = ((AQjmsSession)jms_sess).getTopic(
    'WS', 'Shipped_Orders_Topic');
/* create text message */
TextMessage jms_sess.createTextMessage();
/* publish specifying the topic */
publisher1.publish(shipped_orders, text_message);

```

14.11 Publishing Messages Specifying Delivery Mode, Priority, and TimeToLive

```

public void publish(javax.jms.Topic topic,
    javax.jms.Message message,
    oracle.jms.AQjmsAgent[] recipient_list,
    int deliveryMode,
    int priority,

```

```

        long timeToLive)
        throws JMSEException

```

This method publishes a message specifying delivery mode, priority and `TimeToLive`. It has the following parameters:

Parameter	Description
<code>topic</code>	Topic to which to publish the message (overrides the default topic of the <code>MessageProducer</code>)
<code>message</code>	Message to publish
<code>recipient_list</code>	List of recipients to which the message is published. Recipients are of type <code>AQjmsAgent</code> .
<code>deliveryMode</code>	<code>PERSISTENT</code> or <code>NON_PERSISTENT</code> (only <code>PERSISTENT</code> is supported in this release)
<code>priority</code>	Priority for this message
<code>timeToLive</code>	Message lifetime in milliseconds (zero is unlimited)

Example 14-9 Publishing Specifying Priority and TimeToLive

```

TopicConnectionFactory    tc_fact    = null;
TopicConnection          t_conn     = null;
TopicSession             jms_sess;
TopicPublisher           publisher1;
Topic                    shipped_orders;
int                       myport    = 5521;
/* create connection and session */
tc_fact = AQjmsFactory.getTopicConnectionFactory(
    "MYHOSTNAME", "MYSID", myport, "oci8");
t_conn = tc_fact.createTopicConnection("jmstopic", "jmstopic");
jms_sess = t_conn.createTopicSession(true, Session.CLIENT_ACKNOWLEDGE);
shipped_orders = ((AQjmsSession )jms_sess).getTopic(
    "OE", "Shipped_Orders_Topic");
publisher1 = jms_sess.createPublisher(shipped_orders);
/* Create TextMessage */
TextMessage    jms_sess.createTextMessage();
/* Publish message with priority 1 and time to live 200 seconds */
publisher1.publish(text_message, DeliveryMode.PERSISTENT, 1, 200000);

```

14.12 Publishing Messages Specifying a Recipient List

```

public void publish(javax.jms.Message message,
                   oracle.jms.AQjmsAgent[] recipient_list)
        throws JMSEException

```

This method publishes a message specifying a [recipient](#) list overriding topic subscribers. It has the following parameters:

Parameter	Description
<code>message</code>	Message to publish
<code>recipient_list</code>	List of recipients to which the message is published. Recipients are of type <code>AQjmsAgent</code> .

Example 14-10 Publishing Specifying a Recipient List Overriding Topic Subscribers

```

/* Publish specifying priority and timeToLive */
TopicConnectionFactory tc_fact = null;
TopicConnection t_conn = null;
TopicSession jms_sess;
TopicPublisher publisher1;
Topic shipped_orders;
int myport = 5521;
AQjmsAgent[] recipList;
/* create connection and session */
tc_fact = AQjmsFactory.getTopicConnectionFactory(
    "MYHOSTNAME", "MYSID", myport, "oci8");
t_conn = tc_fact.createTopicConnection("jmstopic", "jmstopic");
jms_sess = t_conn.createTopicSession(true, Session.CLIENT_ACKNOWLEDGE);
shipped_orders = ((AQjmsSession)jms_sess).getTopic(
    "OE", "Shipped_Orders_Topic");
publisher1 = jms_sess.createPublisher(shipped_orders);
/* create TextMessage */
TextMessage text_message = jms_sess.createTextMessage();
/* create two receivers */
recipList = new AQjmsAgent[2];
recipList[0] = new AQjmsAgent(
    "ES", "ES.shipped_orders_topic", AQAgent.DEFAULT_AGENT_PROTOCOL);
recipList[1] = new AQjmsAgent(
    "WS", "WS.shipped_orders_topic", AQAgent.DEFAULT_AGENT_PROTOCOL);
/* publish message specifying a recipient list */
publisher1.publish(text_message, recipList);

```

14.13 Creating a DurableSubscriber for a JMS Topic Without Selector

```

public javax.jms.TopicSubscriber createDurableSubscriber(
    javax.jms.Topic topic,
    java.lang.String subs_name)
    throws JMSEException

```

This method creates a `DurableSubscriber` for a [JMS topic](#) without selector. It has the following parameters:

Parameter	Description
topic	Non-temporary topic to subscribe to
subs_name	Name used to identify this subscription

Exclusive Access to Topics

`CreateDurableSubscriber()` and `Unsubscribe()` both require exclusive access to their target topics. If there are pending JMS `send()`, `publish()`, or `receive()` operations on the same topic when these calls are applied, then exception `ORA - 4020` is raised. There are two solutions to the problem:

- Limit calls to `createDurableSubscriber()` and `Unsubscribe()` to the setup or cleanup phase when there are no other JMS operations pending on the topic. That makes sure that the required resources are not held by other JMS operational calls.

- Call `TopicSession.commit` before calling `createDurableSubscriber()` or `unsubscribe()`.

Example 14-11 Creating a Durable Subscriber for a JMS Topic Without Selector

```

TopicConnectionFactory tc_fact = null;
TopicConnection t_conn = null;
TopicSession jms_sess;
TopicSubscriber subscriber1;
Topic shipped_orders;
int myport = 5521;
AQjmsAgent[] recipList;
/* create connection and session */
tc_fact = AQjmsFactory.getTopicConnectionFactory(
    "MYHOSTNAME",
    "MYSID",
    myport,
    "oci8");
t_conn = tc_fact.createTopicConnection("jmstopic", "jmstopic");
jms_sess = t_conn.createTopicSession(true, Session.CLIENT_ACKNOWLEDGE);
shipped_orders = ((AQjmsSession) jms_sess).getTopic(
    "OE",
    "Shipped_Orders_Topic");
/* create a durable subscriber on the shipped_orders topic*/
subscriber1 = jms_sess.createDurableSubscriber(
    shipped_orders,
    'WesternShipping');

```

14.14 Creating a DurableSubscriber for a JMS Topic with Selector

```

public javax.jms.TopicSubscriber createDurableSubscriber(
    javax.jms.Topic topic,
    java.lang.String subs_name,
    java.lang.String messageSelector,
    boolean noLocal)
    throws JMSEException

```

This method creates a durable subscriber for a JMS topic with selector. It has the following parameters:

Parameter	Description
<code>topic</code>	Non-temporary topic to subscribe to
<code>subs_name</code>	Name used to identify this subscription
<code>messageSelector</code>	Only messages with properties matching the <code>messageSelector</code> expression are delivered. A value of null or an empty string indicates that there is no <code>messageSelector</code> for the message consumer.
<code>noLocal</code>	If set to true, then it inhibits the delivery of messages published by its own connection

A client can change an existing durable subscription by creating a durable `TopicSubscriber` with the same name and a different `messageSelector`. An `unsubscribe` call is needed to end the subscription to the topic.

**See Also:**

- ["Exclusive Access to Topics"](#)
- ["MessageSelector"](#)

Example 14-12 Creating a Durable Subscriber for a JMS Topic With Selector

```

TopicConnectionFactory    tc_fact    = null;
TopicConnection          t_conn     = null;
TopicSession             jms_sess;
TopicSubscriber          subscriber1;
Topic                    shipped_orders;
int                       myport    = 5521;
AQjmsAgent[]             recipList;
/* create connection and session */
tc_fact = AQjmsFactory.getTopicConnectionFactory(
    "MYHOSTNAME", "MYSID", myport, "oci8");
t_conn = tc_fact.createTopicConnection("jmsTopic", "jmsTopic");
jms_sess = t_conn.createTopicSession(true, Session.CLIENT_ACKNOWLEDGE);
shipped_orders = ((AQjmsSession )jms_sess).getTopic(
    "OE", "Shipped_Orders_Topic");
/* create a subscriber */
/* with condition on JMSPriority and user property 'Region' */
subscriber1 = jms_sess.createDurableSubscriber(
    shipped_orders, 'WesternShipping',
    "JMSPriority > 2 and Region like 'Western%'", false);

```

14.15 Creating a DurableSubscriber for an Oracle Object Type Topic Without Selector

```

public javax.jms.TopicSubscriber createDurableSubscriber(
    javax.jms.Topic topic,
    java.lang.String subs_name,
    java.lang.Object payload_factory)
    throws JMSEException

```

This method creates a durable subscriber for an Oracle [object type](#) topic without selector. It has the following parameters:

Parameter	Description
topic	Non-temporary topic to subscribe to
subs_name	Name used to identify this subscription
payload_factory	CustomDatumFactory or ORADDataFactory for the Java class that maps to the Oracle ADT

 **Note:**

- CustomDatum support will be deprecated in a future release. Use ORADDataFactory payload factories instead.
- Sharded queues do not support object type messages.

 **See Also:**

["Exclusive Access to Topics"](#)

Example 14-13 Creating a Durable Subscriber for an Oracle Object Type Topic Without Selector

```

/* Subscribe to an ADT queue */
TopicConnectionFactory    tc_fact    = null;
TopicConnection          t_conn     = null;
TopicSession             t_sess     = null;
TopicSession             jms_sess;
TopicSubscriber          subscriber1;
Topic                    shipped_orders;
int                       my[port = 5521];
AQjmsAgent[]             recipList;
/* the java mapping of the oracle object type created by J Publisher */
ADTMessage               message;
/* create connection and session */
tc_fact = AQjmsFactory.getTopicConnectionFactory(
    "MYHOSTNAME", "MYSID", myport, "oci8");
t_conn = tc_fact.createTopicConnection("jmstopic", "jmstopic");
jms_sess = t_conn.createTopicSession(true, Session.CLIENT_ACKNOWLEDGE);
shipped_orders = ((AQjmsSession) jms_sess).getTopic(
    "OE", "Shipped_Orders_Topic");
/* create a subscriber, specifying the correct CustomDatumFactory */
subscriber1 = jms_sess.createDurableSubscriber(
    shipped_orders, 'WesternShipping', AQjmsAgent.getFactory());

```

14.16 Creating a DurableSubscriber for an Oracle Object Type Topic with Selector

```

public javax.jms.TopicSubscriber createDurableSubscriber(
    javax.jms.Topic topic,
    java.lang.String subs_name,
    java.lang.String messageSelector,
    boolean noLocal,
    java.lang.Object payload_factory)
    throws JMSEException

```

This method creates a durable subscriber for an Oracle object type topic with selector. It has the following parameters:

Parameter	Description
topic	Non-temporary topic to subscribe to
subs_name	Name used to identify this subscription
messageSelector	Only messages with properties matching the messageSelector expression are delivered. A value of null or an empty string indicates that there is no messageSelector for the message consumer.
noLocal	If set to true, then it inhibits the delivery of messages published by its own connection
payload_factory	CustomDatumFactory or ORADatamFactory for the Java class that maps to the Oracle ADT

 **Note:**

- CustomDatum support will be deprecated in a future release. Use ORADatamFactory payload factories instead.
- Sharded queues do not support object type messages.

 **See Also:**

["Exclusive Access to Topics"](#)

Example 14-14 Creating a Durable Subscriber for an Oracle Object Type Topic With Selector

```

TopicConnectionFactory    tc_fact    = null;
TopicConnection          t_conn     = null;
TopicSession             jms_sess;
TopicSubscriber          subscriber1;
Topic                    shipped_orders;
int                       myport    = 5521;
AQjmsAgent[]             recipList;
/* the java mapping of the oracle object type created by J Publisher */
ADTMessage                message;
/* create connection and session */
tc_fact = AQjmsFactory.getTopicConnectionFactory(
    "MYHOSTNAME", "MYSID", myport, "oci8");
t_conn = tc_fact.createTopicConnection("jmstopic", "jmstopic");
jms_sess = t_conn.createTopicSession(true, Session.CLIENT_ACKNOWLEDGE);
shipped_orders = ((AQjmsSession )jms_sess).getTopic(
    "OE", "Shipped_Orders_Topic");
/* create a subscriber, specifying correct CustomDatumFactory and selector */
subscriber1 = jms_sess.createDurableSubscriber(
    shipped_orders, "WesternShipping",
    "priority > 1 and tab.user_data.region like 'WESTERN %'", false,
    ADTMessage.getFactory());

```

14.17 Specifying Transformations for Topic Subscribers

A transformation can be supplied when sending/publishing a message to a queue/topic. The transformation is applied before putting the message into the queue/topic.

The application can specify a transformation using the `setTransformation` interface in the `AQjmsQueueSender` and `AQjmsTopicPublisher` interfaces.

A transformation can also be specified when creating topic subscribers using the `CreateDurableSubscriber()` call. The transformation is applied to the retrieved message before returning it to the subscriber. If the subscriber specified in the `CreateDurableSubscriber()` call already exists, then its transformation is set to the specified transformation.

Example 14-15 Sending Messages to a Destination Using a Transformation

Suppose that the orders that are processed by the order entry application should be published to `WS_bookedorders_topic`. The transformation `OE2WS` (defined in the previous section) is supplied so that the messages are inserted into the topic in the correct format.

```
public void ship_bookedorders(
    TopicSession jms_session,
    AQjmsADTMessage adt_message)
{
    TopicPublisher publisher;
    Topic topic;

    try
    {
        /* get a handle to the WS_bookedorders_topic */
        topic = ((AQjmsSession)jms_session).getTopic("WS",
"WS_bookedorders_topic");
        publisher = jms_session.createPublisher(topic);

        /* set the transformation in the publisher */
        ((AQjmsTopicPublisher)publisher).setTransformation("OE2WS");
        publisher.publish(topic, adt_message);
    }
    catch (JMSEException ex)
    {
        System.out.println("Exception : " ex);
    }
}
```

Example 14-16 Specifying Transformations for Topic Subscribers

The Western Shipping application subscribes to the `OE_bookedorders_topic` with the transformation `OE2WS`. This transformation is applied to the messages and the returned message is of Oracle object type `WS.WS_orders`.

Suppose that the `WSOrder` java class has been generated by `Jpublisher` to map to the Oracle object `WS.WS_order`:

```
public AQjmsAdtMessage retrieve_bookedorders(TopicSession jms_session)
{
    TopicSubscriber subscriber;
    Topic topic;
    AQjmsAdtMessage msg = null;
```

```

try
{
    /* get a handle to the OE_bookedorders_topic */
    topic = ((AQjmsSession)jms_session).getTopic("OE", "OE_bookedorders_topic");

    /* create a subscriber with the transformation OE2WS */
    subs = ((AQjmsSession)jms_session).createDurableSubscriber(
        topic, 'WShip', null, false, WSOrder.getFactory(), "OE2WS");
    msg = subscriber.receive(10);
}
catch (JMSEException ex)
{
    System.out.println("Exception :" ex);
}
return (AQjmsAdtMessage)msg;
}

```

14.18 Creating a Remote Subscriber for JMS Messages

```

public void createRemoteSubscriber(javax.jms.Topic topic,
                                   oracle.jms.AQjmsAgent remote_subscriber,
                                   java.lang.String messageSelector)
    throws JMSEException

```

This method creates a remote subscriber for topics of JMS messages. It has the following parameters:

Parameter	Description
topic	Topic to subscribe to
remote_subscriber	AQjmsAgent that refers to the remote subscriber
messageSelector	Only messages with properties matching the messageSelector expression are delivered. A value of null or an empty string indicates that there is no messageSelector for the message consumer.

Oracle Database Advanced Queuing allows topics to have remote subscribers, for example, subscribers at other topics in the same or different database. In order to use remote subscribers, you must set up [propagation](#) between the local and remote topic.

Remote subscribers can be a specific consumer at the remote topic or all subscribers at the remote topic. A remote subscriber is defined using the `AQjmsAgent` structure. An `AQjmsAgent` consists of a name and address. The name refers to the `consumer_name` at the remote topic. The address refers to the remote topic. Its syntax is `schema.topic_name[@dblink]`.

To publish messages to a particular consumer at the remote topic, the `subscription_name` of the recipient at the remote topic must be specified in the name field of `AQjmsAgent`, and the remote topic must be specified in the address field. To publish messages to all subscribers of the remote topic, the name field of `AQjmsAgent` must be set to null.

 **Note:**

Sharded queues do not support remote subscribers.

 **See Also:**

["MessageSelector"](#)

Example 14-17 Creating a Remote Subscriber for Topics of JMS Messages

```

TopicConnectionFactory    tc_fact    = null;
TopicConnection          t_conn     = null;
TopicSession             t_sess     = null;
TopicSession             jms_sess;
TopicSubscriber          subscriber1;
Topic                    shipped_orders;
int                       my[port = 5521;
AQjmsAgent                remoteAgent;
/* create connection and session */
tc_fact = AQjmsFactory.getTopicConnectionFactory(
    "MYHOSTNAME", "MYSID", myport, "oci8");
t_conn = tc_fact.createTopicConnection("jmstopic", "jmstopic");
jms_sess = t_conn.createTopicSession(true, Session.CLIENT_ACKNOWLEDGE);
shipped_orders = ((AQjmsSession) jms_sess).getTopic(
    "OE", "Shipped_Orders_Topic");
remoteAgent = new AQjmsAgent("WesternRegion", "WS.shipped_orders_topic", null);
/* create a remote subscriber (selector is null)*/
subscriber1 = ((AQjmsSession)jms_sess).createRemoteSubscriber(
    shipped_orders, remoteAgent, null);
    
```

14.19 Creating a Remote Subscriber for Oracle Object Type Messages

```

public void createRemoteSubscriber(javax.jms.Topic topic,
    oracle.jms.AQjmsAgent remote_subscriber,
    java.lang.String messageSelector,
    java.lang.Object payload_factory)
    throws JMSEException
    
```

This method creates a remote subscriber for topics of Oracle object type messages. It has the following parameters:

Parameter	Description
topic	Topic to subscribe to
remote_subscriber	AQjmsAgent that refers to the remote subscriber
messageSelector	Only messages with properties matching the messageSelector expression are delivered. A value of null or an empty string indicates that there is no messageSelector for the message consumer.

Parameter	Description
<code>payload_factory</code>	CustomDatumFactory or ORADatFactory for the Java class that maps to the Oracle ADT

 **Note:**

- CustomDatum support will be deprecated in a future release. Use ORADatFactory payload factories instead.
- Sharded queues do not support remote subscribers or object type messages.

Oracle Database Advanced Queuing allows topics to have remote subscribers, for example, subscribers at other topics in the same or different database. In order to use remote subscribers, you must set up [propagation](#) between the local and remote topic.

Remote subscribers can be a specific consumer at the remote topic or all subscribers at the remote topic. A remote subscriber is defined using the `AQjmsAgent` structure. An `AQjmsAgent` consists of a name and address. The name refers to the `consumer_name` at the remote topic. The address refers to the remote topic. Its syntax is `schema.topic_name[@dblink]`.

To publish messages to a particular consumer at the remote topic, the `subscription_name` of the recipient at the remote topic must be specified in the name field of `AQjmsAgent`, and the remote topic must be specified in the address field. To publish messages to all subscribers of the remote topic, the name field of `AQjmsAgent` must be set to null.

 **Note:**

AQ does not support the use of multiple dblink to the same destination. As a workaround, use a single database link for each destination.

 **See Also:**

["MessageSelector"](#)

Example 14-18 Creating a Remote Subscriber for Topics of Oracle Object Type Messages

```

TopicConnectionFactory    tc_fact    = null;
TopicConnection          t_conn     = null;
TopicSession             t_sess     = null;
TopicSession             jms_sess;
TopicSubscriber          subscriber1;
Topic                    shipped_orders;
int                       my[port = 5521;

```



```

AQjmsAgent          remoteAgent;
ADTMessage          message;
/* create connection and session */
tc_fact = AQjmsFactory.getTopicConnectionFactory(
    "MYHOSTNAME", "MYSID", myport, "oci8");
t_conn = tc_fact.createTopicConnection("jmstopic", "jmstopic");
/* create TopicSession */
jms_sess = t_conn.createTopicSession(true, Session.CLIENT_ACKNOWLEDGE);
/* get the Shipped order topic */
shipped_orders = ((AQjmsSession)jms_sess).getTopic(
    "OE", "Shipped_Orders_Topic");
/* create a remote agent */
remoteAgent = new AQjmsAgent("WesternRegion", "WS.shipped_orders_topic", null);
/* create a remote subscriber with null selector*/
subscriber1 = ((AQjmsSession)jms_sess).createRemoteSubscriber(
    shipped_orders, remoteAgent, null, message.getFactory());

```

14.20 Specifying Transformations for Remote Subscribers

Oracle Database Advanced Queuing allows a remote subscriber, that is a subscriber at another database, to subscribe to a topic.

Transformations can be specified when creating remote subscribers using the `createRemoteSubscriber()` call. This enables propagation of messages between topics of different formats. When a message published at a topic meets the criterion of a remote subscriber, Oracle Database Advanced Queuing automatically propagates the message to the queue/topic at the remote database specified for the remote subscriber. If a transformation is also specified, then Oracle Database Advanced Queuing applies the transformation to the message before propagating it to the queue/topic at the remote database.

Note:

Sharded queues do not support remote subscribers.

Example 14-19 Specifying Transformations for Remote Subscribers

A remote subscriber is created at the OE.OE_bookedorders_topic so that messages are automatically propagated to the WS.WS_bookedorders_topic. The transformation OE2WS is specified when creating the remote subscriber so that the messages reaching the WS_bookedorders_topic have the correct format.

Suppose that the WSOrder java class has been generated by Jpublisher to map to the Oracle object WS.WS_order

```

public void create_remote_sub(TopicSession jms_session)
{
    AQjmsAgent          subscriber;
    Topic               topic;

    try
    {
        /* get a handle to the OE_bookedorders_topic */
        topic = ((AQjmsSession)jms_session).getTopic("OE", "OE_bookedorders_topic");
        subscriber = new AQjmsAgent("WShip", "WS.WS_bookedorders_topic");
    }
}

```

```

        ((AQjmsSession )jms_session).createRemoteSubscriber(
            topic, subscriber, null, WSOrder.getFactory(),"OE2WS");
    }
    catch (JMSEException ex)
    {
        System.out.println("Exception :" ex);
    }
}

```

14.21 Unsubscribing a Durable Subscription for a Local Subscriber

```

public void unsubscribe(javax.jms.Topic topic,
                       java.lang.String subs_name)
    throws JMSEException

```

This method unsubscribes a durable subscription for a local subscriber. It has the following parameters:

Parameter	Description
topic	Non-temporary topic to unsubscribe
subs_name	Name used to identify this subscription



See Also:

["Exclusive Access to Topics"](#)

Example 14-20 Unsubscribing a Durable Subscription for a Local Subscriber

```

TopicConnectionFactory    tc_fact    = null;
TopicConnection          t_conn     = null;
TopicSession             jms_sess;
TopicSubscriber          subscriber1;
Topic                    shipped_orders;
int                      myport = 5521;
AQjmsAgent[]             recipList;
/* create connection and session */
tc_fact = AQjmsFactory.getTopicConnectionFactory(
    "MYHOSTNAME", "MYSID", myport, "oci8");
t_conn = tc_fact.createTopicConnection("jmstopic", "jmstopic");
jms_sess = t_conn.createTopicSession(true, Session.CLIENT_ACKNOWLEDGE);
shipped_orders = ((AQjmsSession )jms_sess).getTopic(
    "OE", "Shipped_Orders_Topic");
/* unsubscribe "WesternShipping" from shipped_orders */
jms_sess.unsubscribe(shipped_orders, "WesternShipping");

```

14.22 Unsubscribing a Durable Subscription for a Remote Subscriber

```
public void unsubscribe(javax.jms.Topic topic,
                       oracle.jms.AQjmsAgent remote_subscriber)
    throws JMSEException
```

This method unsubscribes a durable subscription for a remote subscriber. It has the following parameters:

Parameter	Description
topic	Non-temporary topic to unsubscribe
remote_subscriber	AQjmsAgent that refers to the remote subscriber. The address field of the AQjmsAgent cannot be null.



Note:

Sharded queues do not support remote subscribers.



See Also:

["Exclusive Access to Topics"](#)

Example 14-21 Unsubscribing a Durable Subscription for a Remote Subscriber

```
TopicConnectionFactory tc_fact = null;
TopicConnection t_conn = null;
TopicSession t_sess = null;
TopicSession jms_sess;
Topic shipped_orders;
int myport = 5521;
AQjmsAgent remoteAgent;
/* create connection and session */
tc_fact = AQjmsFactory.getTopicConnectionFactory(
    "MYHOSTNAME", "MYSID", myport, "oci8");
t_conn = tc_fact.createTopicConnection("jmsTopic", "jmsTopic");
jms_sess = t_conn.createTopicSession(true, Session.CLIENT_ACKNOWLEDGE);
shipped_orders = ((AQjmsSession) jms_sess).getTopic(
    "OE", "Shipped_Orders_Topic");
remoteAgent = new AQjmsAgent("WS", "WS.Shipped_Orders_Topic", null);
/* unsubscribe the remote agent from shipped_orders */
((AQjmsSession) jms_sess).unsubscribe(shipped_orders, remoteAgent);
```

14.23 Creating a TopicReceiver for a Topic of Standard JMS Type Messages

```
public oracle.jms.AQjmsTopicReceiver createTopicReceiver(
    javax.jms.Topic topic,
    java.lang.String receiver_name,
    java.lang.String messageSelector)
    throws JMSEException
```

This method creates a `TopicReceiver` for a topic of standard JMS type messages. It has the following parameters:

Parameter	Description
<code>topic</code>	Topic to access
<code>receiver_name</code>	Name of message receiver
<code>messageSelector</code>	Only messages with properties matching the <code>messageSelector</code> expression are delivered. A value of null or an empty string indicates that there is no <code>messageSelector</code> for the message consumer.

Oracle Database Advanced Queuing allows messages to be sent to specified recipients. These receivers may or may not be subscribers of the topic. If the receiver is not a subscriber to the topic, then it receives only those messages that are explicitly addressed to it. This method must be used order to create a `TopicReceiver` object for consumers that are not durable subscribers.



See Also:

["MessageSelector"](#)

Example 14-22 Creating a TopicReceiver for Standard JMS Type Messages

```
TopicConnectionFactory    tc_fact    = null;
TopicConnection          t_conn     = null;
TopicSession             t_sess     = null;
TopicSession             jms_sess;
Topic                    shipped_orders;
int                       myport    = 5521;
TopicReceiver            receiver;
/* create connection and session */
tc_fact = AQjmsFactory.getTopicConnectionFactory(
    "MYHOSTNAME", "MYSID", myport, "oci8");
t_conn = tc_fact.createTopicConnection("jmsTopic", "jmsTopic");
jms_sess = t_conn.createTopicSession(true, Session.CLIENT_ACKNOWLEDGE);
shipped_orders = ((AQjmsSession)jms_sess).getTopic(
    "WS", "Shipped_Orders_Topic");
receiver = ((AQjmsSession)jms_sess).createTopicReceiver(
    shipped_orders, "WesternRegion", null);
```

14.24 Creating a TopicReceiver for a Topic of Oracle Object Type Messages

```
public oracle.jms.AQjmsTopicReceiver createTopicReceiver(
    javax.jms.Topic topic,
    java.lang.String receiver_name,
    java.lang.String messageSelector,
    java.lang.Object payload_factory)
    throws JMSEException
```

This method creates a `TopicReceiver` for a topic of Oracle object type messages with selector. It has the following parameters:

Parameter	Description
<code>topic</code>	Topic to access
<code>receiver_name</code>	Name of message receiver
<code>messageSelector</code>	Only messages with properties matching the <code>messageSelector</code> expression are delivered. A value of null or an empty string indicates that there is no <code>messageSelector</code> for the message consumer.
<code>payload_factory</code>	<code>CustomDatumFactory</code> or <code>ORADDataFactory</code> for the Java class that maps to the Oracle ADT

Note:

- `CustomDatum` support will be deprecated in a future release. Use `ORADDataFactory` payload factories instead.
- Sharded queues do not support object type messages.

Oracle Database Advanced Queuing allows messages to be sent to all subscribers of a topic or to specified recipients. These receivers may or may not be subscribers of the topic. If the receiver is not a subscriber to the topic, then it receives only those messages that are explicitly addressed to it. This method must be used order to create a `TopicReceiver` object for consumers that are not durable subscribers.

See Also:

"[MessageSelector](#)"

Example 14-23 Creating a TopicReceiver for Oracle Object Type Messages

```
TopicConnectionFactory tc_fact = null;
TopicConnection t_conn = null;
TopicSession t_sess = null;
TopicSession jms_sess;
Topic shipped_orders;
```

```

int                myport = 5521;
TopicReceiver      receiver;
/* create connection and session */
tc_fact = AQjmsFactory.getTopicConnectionFactory(
    "MYHOSTNAME", "MYSID", myport, "oci8");
t_conn = tc_fact.createTopicConnection("jmstopic", "jmstopic");
jms_sess = t_conn.createTopicSession(true, Session.CLIENT_ACKNOWLEDGE);
shipped_orders = ((AQjmsSession )jms_sess).getTopic(
    "WS", "Shipped_Orders_Topic");
receiver = ((AQjmsSession)jms_sess).createTopicReceiver(
    shipped_orders, "WesternRegion", null);

```

14.25 Creating a TopicBrowser for Standard JMS Messages

```

public oracle.jms.TopicBrowser createBrowser(javax.jms.Topic topic,
                                             java.lang.String cons_name,
                                             java.lang.String messageSelector)
    throws JMSEException

```

This method creates a `TopicBrowser` for topics with `TextMessage`, `StreamMessage`, `ObjectMessage`, `BytesMessage`, or `MapMessage` message bodies. It has the following parameters:

Parameter	Description
<code>topic</code>	Topic to access
<code>cons_name</code>	Name of the durable subscriber or consumer
<code>messageSelector</code>	Only messages with properties matching the <code>messageSelector</code> expression are delivered. A value of null or an empty string indicates that there is no <code>messageSelector</code> for the message consumer.
<code>payload_factory</code>	<code>CustomDatumFactory</code> or <code>ORADDataFactory</code> for the Java class that maps to the Oracle ADT



See Also:

["MessageSelector"](#)

Example 14-24 Creating a TopicBrowser Without a Selector

```

/* Create a browser without a selector */
TopicSession      jms_session;
TopicBrowser      browser;
Topic             topic;
browser = ((AQjmsSession) jms_session).createBrowser(topic, "SUBS1");

```

Example 14-25 Creating a TopicBrowser With a Specified Selector

```

/* Create a browser for topics with a specified selector */
TopicSession      jms_session;
TopicBrowser      browser;
Topic             topic;
/* create a Browser to look at messages with correlationID = RUSH */
browser = ((AQjmsSession) jms_session).createBrowser(
    topic, "SUBS1", "JMScorrelationID = 'RUSH'");

```

14.26 Creating a TopicBrowser for Standard JMS Messages, Locking Messages

```
public oracle.jms.TopicBrowser createBrowser(javax.jms.Topic topic,
                                           java.lang.String cons_name,
                                           java.lang.String messageSelector,
                                           boolean locked)
                                           throws JMSEException
```

This method creates a `TopicBrowser` for topics with text, stream, objects, bytes or map messages, locking messages while browsing. It has the following parameters:

Parameter	Description
<code>topic</code>	Topic to access
<code>cons_name</code>	Name of the durable subscriber or consumer
<code>messageSelector</code>	Only messages with properties matching the <code>messageSelector</code> expression are delivered. A value of null or an empty string indicates that there is no <code>messageSelector</code> for the message consumer.
<code>locked</code>	If set to true, then messages are locked as they are browsed (similar to a SELECT for UPDATE)

Example 14-26 Creating a TopicBrowser Without a Selector, Locking Messages While Browsing

```
/* Create a browser without a selector */
TopicSession jms_session;
TopicBrowser browser;
Topic topic;
browser = ((AQjmsSession) jms_session).createBrowser(
    topic, "SUBS1", true);
```

Example 14-27 Creating a TopicBrowser With a Specified Selector, Locking Messages

```
/* Create a browser for topics with a specified selector */
TopicSession jms_session;
TopicBrowser browser;
Topic topic;
/* create a Browser to look at messages with correlationID = RUSH in
lock mode */
browser = ((AQjmsSession) jms_session).createBrowser(
    topic, "SUBS1", "JMScorrelationID = 'RUSH'", true);
```

14.27 Creating a TopicBrowser for Oracle Object Type Messages

```
public oracle.jms.TopicBrowser createBrowser(javax.jms.Topic topic,
                                           java.lang.String cons_name,
                                           java.lang.String messageSelector,
                                           java.lang.Object payload_factory)
                                           throws JMSEException
```

This method creates a `TopicBrowser` for topics of Oracle object type messages. It has the following parameters:

Parameter	Description
<code>topic</code>	Topic to access
<code>cons_name</code>	Name of the durable subscriber or consumer
<code>messageSelector</code>	Only messages with properties matching the <code>messageSelector</code> expression are delivered. A value of null or an empty string indicates that there is no <code>messageSelector</code> for the message consumer.
<code>payload_factory</code>	<code>CustomDatumFactory</code> or <code>ORADatFactory</code> for the Java class that maps to the Oracle ADT

 **Note:**

- `CustomDatum` support will be deprecated in a future release. Use `ORADatFactory` payload factories instead.
- Sharded queues do not support object type messages.

The `CustomDatumFactory` for a particular Java class that maps to the SQL object type payload can be obtained using the `getFactory` static method. Assume the topic `test_topic` has payload of type `SCOTT.EMPLOYEE` and the Java class that is generated by `Jpublisher` for this Oracle object type is called `Employee`. The `Employee` class implements the `CustomDatum` interface. The `CustomDatumFactory` for this class can be obtained by using the `Employee.getFactory()` method.

 **See Also:**

["MessageSelector"](#)

Example 14-28 Creating a TopicBrowser for AdtMessage Messages

```
/* Create a browser for a Topic with AdtMessage messages of type EMPLOYEE*/
TopicSession jms_session
TopicBrowser browser;
Topic        test_topic;
browser = ((AQjmsSession) jms_session).createBrowser(
    test_topic, "SUBS1", Employee.getFactory());
```

14.28 Creating a TopicBrowser for Oracle Object Type Messages, Locking Messages

```
public oracle.jms.TopicBrowser createBrowser(javax.jms.Topic topic,
                                             java.lang.String cons_name,
                                             java.lang.String messageSelector,
                                             java.lang.Object payload_factory,
```

boolean locked)
throws JMSEException

This method creates a `TopicBrowser` for topics of Oracle object type messages, locking messages while browsing. It has the following parameters:

Parameter	Description
<code>topic</code>	Topic to access
<code>cons_name</code>	Name of the durable subscriber or consumer
<code>messageSelector</code>	Only messages with properties matching the <code>messageSelector</code> expression are delivered. A value of null or an empty string indicates that there is no <code>messageSelector</code> for the message consumer.
<code>payload_factory</code>	<code>CustomDatumFactory</code> or <code>ORADDataFactory</code> for the Java class that maps to the Oracle ADT
<code>locked</code>	If set to true, then messages are locked as they are browsed (similar to a SELECT for UPDATE)

Note:

- `CustomDatum` support will be deprecated in a future release. Use `ORADDataFactory` payload factories instead.
- Sharded queues do not support object type messages.

See Also:

["MessageSelector"](#)

Example 14-29 Creating a TopicBrowser for AdtMessage Messages, Locking Messages

```
/* Create a browser for a Topic with AdtMessage messages of type EMPLOYEE* in
lock mode/
TopicSession jms_session
TopicBrowser browser;
Topic        test_topic;
browser = ((AQjmsSession) jms_session).createBrowser(
        test_topic, "SUBS1", Employee.getFactory(), true);
```

14.29 Browsing Messages Using a TopicBrowser

```
public void purgeSeen()
        throws JMSEException
```

This method browses messages using a `TopicBrowser`. Use methods in `java.util.Enumeration` to go through the list of messages. Use the method `purgeSeen` in `TopicBrowser` to purge messages that have been seen during the current browse.

Example 14-30 Creating a TopicBrowser with a Specified Selector

```
/* Create a browser for topics with a specified selector */
public void browse_rush_orders(TopicSession jms_session)
TopicBrowser    browser;
Topic            topic;
ObjectMessage   obj_message;
BolOrder        new_order;
Enumeration      messages;
/* get a handle to the new_orders topic */
topic = ((AQjmsSession) jms_session).getTopic("OE", "OE_bookedorders_topic");
/* create a Browser to look at RUSH orders */
browser = ((AQjmsSession) jms_session).createBrowser(
    topic, "SUBS1", "JMSCorrelationID = 'RUSH'");
/* Browse through the messages */
for (messages = browser.elements() ; message.hasMoreElements() ;)
{obj_message = (ObjectMessage)message.nextElement();}
/* Purge messages seen during this browse */
browser.purgeSeen()
```

15

Oracle Java Message Service Shared Interfaces

The following topics describe the [Java Message Service](#) (JMS) operational interface (shared interfaces) to Oracle Database Advanced Queuing (AQ).

- [Oracle Database Advanced Queuing JMS Operational Interface: Shared Interfaces](#)
- [Specifying JMS Message Properties](#)
- [Setting Default TimeToLive for All Messages Sent by a MessageProducer](#)
- [Setting Default Priority for All Messages Sent by a MessageProducer](#)
- [Creating an AQjms Agent](#)
- [Receiving a Message Synchronously](#)
- [Specifying the Navigation Mode for Receiving Messages](#)
- [Receiving a Message Asynchronously](#)
- [Getting Message ID](#)
- [Getting JMS Message Properties](#)
- [Closing and Shutting Down](#)
- [Troubleshooting](#)

15.1 Oracle Database Advanced Queuing JMS Operational Interface: Shared Interfaces

The following topics discuss Oracle Database Advanced Queuing shared interfaces for JMS operations.

- [Starting a JMS Connection](#)
- [Getting a JMS Connection](#)
- [Committing All Operations in a Session](#)
- [Rolling Back All Operations in a Session](#)
- [Getting the JDBC Connection from a Session](#)
- [Getting the OracleOCIConnectionPool from a JMS Connection](#)
- [Creating a BytesMessage](#)
- [Creating a MapMessage](#)
- [Creating a StreamMessage](#)
- [Creating an ObjectMessage](#)
- [Creating a TextMessage](#)

- [Creating a JMS Message](#)
- [Creating an AdtMessage](#)
- [Setting a JMS Correlation Identifier](#)

15.1.1 Starting a JMS Connection

```
public void start()  
    throws JMSEException
```

`AQjmsConnection.start()` starts a [JMS connection](#) for receiving messages.

15.1.2 Getting a JMS Connection

```
public oracle.jms.AQjmsConnection getJmsConnection()  
    throws JMSEException
```

`AQjmsSession.getJmsConnection()` gets a JMS connection from a session.

15.1.3 Committing All Operations in a Session

```
public void commit()  
    throws JMSEException
```

`AQjmsSession.commit()` commits all JMS and SQL operations performed in a session.

15.1.4 Rolling Back All Operations in a Session

```
public void rollback()  
    throws JMSEException
```

`AQjmsSession.rollback()` terminates all JMS and SQL operations performed in a session.

15.1.5 Getting the JDBC Connection from a Session

```
public java.sql.Connection getDBConnection()  
    throws JMSEException
```

`AQjmsSession.getDBConnection()` gets the underlying JDBC connection from a [JMS session](#). The JDBC connection can be used to perform SQL operations as part of the same transaction in which the JMS operations are accomplished.

Example 15-1 Getting Underlying JDBC Connection from JMS Session

```
java.sql.Connection db_conn;  
QueueSession      jms_sess;  
db_conn = ((AQjmsSession)jms_sess).getDBConnection();
```

15.1.6 Getting the OracleOCIConnectionPool from a JMS Connection

```
public oracle.jdbc.pool.OracleOCIConnectionPool getOCIConnectionPool()
```

`AQjmsConnection.getOCIConnectionPool()` gets the underlying `OracleOCIConnectionPool` from a JMS connection. The settings of the `OracleOCIConnectionPool` instance can be

tuned by the user depending on the connection usage, for example, the number of sessions the user wants to create using the given connection. The user should not, however, close the `OracleOCIConnectionPool` instance being used by the JMS connection.

Example 15-2 Getting Underlying OracleOCIConnectionPool from JMS Connection

```
oracle.jdbc.pool.OracleOCIConnectionPool cpool;
QueueConnection jms_conn;
cpool = ((AQjmsConnection)jms_conn).getOCIConnectionPool();
```

15.1.7 Creating a BytesMessage

```
public javax.jms.BytesMessage createBytesMessage()
    throws JMSEException
```

`AQjmsSession.createBytesMessage()` creates a bytes [message](#). It can be used only if the [queue table](#) that contains the destination [queue/topic](#) was created with the `SYS.AQ$_JMS_BYTES_MESSAGE` or `AQ$_JMS_MESSAGE` payload types.

15.1.8 Creating a MapMessage

```
public javax.jms.MapMessage createMapMessage()
    throws JMSEException
```

`AQjmsSession.createMapMessage()` creates a map message. It can be used only if the [queue table](#) that contains the destination [queue/topic](#) was created with the `SYS.AQ$_JMS_MAP_MESSAGE` or `AQ$_JMS_MESSAGE` payload types.

15.1.9 Creating a StreamMessage

```
public javax.jms.StreamMessage createStreamMessage()
    throws JMSEException
```

`AQjmsSession.createStreamMessage()` creates a stream message. It can be used only if the [queue table](#) that contains the destination [queue/topic](#) was created with the `SYS.AQ$_JMS_STREAM_MESSAGE` or `AQ$_JMS_MESSAGE` payload types.

15.1.10 Creating an ObjectMessage

```
public javax.jms.ObjectMessage createObjectMessage(java.io.Serializable object)
    throws JMSEException
```

`AQjmsSession.createObjectMessage()` creates an object message. It can be used only if the [queue table](#) that contains the destination [queue/topic](#) was created with the `SYS.AQ$_JMS_OBJECT_MESSAGE` or `AQ$_JMS_MESSAGE` payload types.

15.1.11 Creating a TextMessage

```
public javax.jms.TextMessage createTextMessage()
    throws JMSEException
```

`AQjmsSession.createTextMessage()` creates a text message. It can be used only if the queue table that contains the destination queue/topic was created with the `SYS.AQ$_JMS_TEXT_MESSAGE` or `AQ$_JMS_MESSAGE` payload types.

15.1.12 Creating a JMS Message

```
public javax.jms.Message createMessage()  
    throws JMSEException
```

`AQjmsSession.createMessage()` creates a [JMS message](#). You can use the `AQ$_JMS_MESSAGE` construct message to construct messages of different types. The message type must be one of the following:

- `DBMS_AQ.JMS_TEXT_MESSAGE`
- `DBMS_AQ.JMS_OBJECT_MESSAGE`
- `DBMS_AQ.JMS_MAP_MESSAGE`
- `DBMS_AQ.JMS_BYTES_MESSAGE`
- `DBMS_AQ.JMS_STREAM_MESSAGE`

You can also use this ADT to create a header-only JMS message.

15.1.13 Creating an AdtMessage

```
public oracle.jms.AdtMessage createAdtMessage()  
    throws JMSEException
```

`AQjmsSession.createAdtMessage()` creates an `AdtMessage`. It can be used only if the queue table that contains the queue/topic was created with an Oracle ADT payload type. An `AdtMessage` must be populated with an object that implements the `CustomDatum` interface. This object must be the Java mapping of the SQL ADT defined as the payload for the queue/topic. Java classes corresponding to SQL ADT types can be generated using the `Jpublisher` tool.

15.1.14 Setting a JMS Correlation Identifier

```
public void setJMSCorrelationID(java.lang.String correlationID)  
    throws JMSEException
```

`AQjmsMessage.setJMSCorrelationID()` specifies the message correlation identifier.

15.2 Specifying JMS Message Properties

Property names starting with `JMS` are provider-specific. User-defined properties cannot start with `JMS`.

The following provider properties can be set by clients using text, stream, object, bytes or map messages:

- `JMSXAppID` (string)
- `JMSXGroupID` (string)
- `JMSXGroupSeq` (int)
- `JMS_OracleExcpQ` (string)

This message property specifies the [exception queue](#).

- `JMS_OracleDelay` (int)

This message property specifies the message delay in seconds.

The following properties can be set on `AdtMessage`

- `JMS_OracleExcpQ` (String)

This message property specifies the exception queue as "`schema.queue_name`"

- `JMS_OracleDelay` (int)

This message property specifies the message delay in seconds.

This section contains these topics:

- [Setting a Boolean Message Property](#)
- [Setting a String Message Property](#)
- [Setting an Integer Message Property](#)
- [Setting a Double Message Property](#)
- [Setting a Float Message Property](#)
- [Setting a Byte Message Property](#)
- [Setting a Long Message Property](#)
- [Setting a Short Message Property](#)
- [Getting an Object Message Property](#)

15.2.1 Setting a Boolean Message Property

```
public void setBooleanProperty(java.lang.String name,
                              boolean value)
    throws JMSEException
```

`AQjmsMessage.setBooleanProperty()` specifies a message property as Boolean. It has the following parameters:

Parameter	Description
<code>name</code>	Name of the Boolean property
<code>value</code>	Boolean property value to set in the message

15.2.2 Setting a String Message Property

```
public void setStringProperty(java.lang.String name,
                              java.lang.String value)
    throws JMSEException
```

`AQjmsMessage.setStringProperty()` specifies a message property as string. It has the following parameters:

Parameter	Description
<code>name</code>	Name of the string property

Parameter	Description
value	String property value to set in the message

15.2.3 Setting an Integer Message Property

```
public void setIntProperty(java.lang.String name,  
                           int value)  
    throws JMSEException
```

`AQjmsMessage.setIntProperty()` specifies a message property as integer. It has the following parameters:

Parameter	Description
name	Name of the integer property
value	Integer property value to set in the message

15.2.4 Setting a Double Message Property

```
public void setDoubleProperty(java.lang.String name,  
                              double value)  
    throws JMSEException
```

`AQjmsMessage.setDoubleProperty()` specifies a message property as double. It has the following parameters:

Parameter	Description
name	Name of the double property
value	Double property value to set in the message

15.2.5 Setting a Float Message Property

```
public void setFloatProperty(java.lang.String name,  
                             float value)  
    throws JMSEException
```

`AQjmsMessage.setFloatProperty()` specifies a message property as float. It has the following parameters:

Parameter	Description
name	Name of the float property
value	Float property value to set in the message

15.2.6 Setting a Byte Message Property

```
public void setByteProperty(java.lang.String name,  
                            byte value)  
    throws JMSEException
```

`AQjmsMessage.setByteProperty()` specifies a message property as byte. It has the following parameters:

Parameter	Description
name	Name of the byte property
value	Byte property value to set in the message

15.2.7 Setting a Long Message Property

```
public void setLongProperty(java.lang.String name,  
                           long value)  
    throws JMSEException
```

`AQjmsMessage.setLongProperty()` specifies a message property as long. It has the following parameters:

Parameter	Description
name	Name of the long property
value	Long property value to set in the message

15.2.8 Setting a Short Message Property

```
public void setShortProperty(java.lang.String name,  
                             short value)  
    throws JMSEException
```

`AQjmsMessage.setShortProperty()` specifies a message property as short. It has the following parameters:

Parameter	Description
name	Name of the short property
value	Short property value to set in the message

15.2.9 Setting an Object Message Property

```
public void setObjectProperty(java.lang.String name,  
                              java.lang.Object value)  
    throws JMSEException
```

`AQjmsMessage.setObjectProperty()` specifies a message property as object. Only objectified primitive values are supported: Boolean, byte, short, integer, long, float, double and string. It has the following parameters:

Parameter	Description
name	Name of the Java object property
value	Java object property value to set in the message

15.3 Setting Default TimeToLive for All Messages Sent by a MessageProducer

```
public void setTimeToLive(long timeToLive)
    throws JMSEException
```

This method sets the default `TimeToLive` for all messages sent by a `MessageProducer`. It is calculated after message delay has taken effect. This method has the following parameter:

Parameter	Description
<code>timeToLive</code>	Message time to live in milliseconds (zero is unlimited)

Example 15-3 Setting Default TimeToLive for All Messages Sent by a MessageProducer

```
/* Set default timeToLive value to 100000 milliseconds for all messages sent by the
QueueSender*/
QueueSender sender;
sender.setTimeToLive(100000);
```

15.4 Setting Default Priority for All Messages Sent by a MessageProducer

```
public void setPriority(int priority)
    throws JMSEException
```

This method sets the default `Priority` for all messages sent by a `MessageProducer`. It has the following parameter:

Parameter	Description
<code>priority</code>	Message priority for this message producer. The default is 4.

Priority values can be any integer. A smaller number indicates higher priority. If a priority value is explicitly specified during a `send()` operation, then it overrides the default value set by this method.

Example 15-4 Setting Default Priority Value for All Messages Sent by QueueSender

```
/* Set default priority value to 2 for all messages sent by the QueueSender*/
QueueSender sender;
sender.setPriority(2);
```

Example 15-5 Setting Default Priority Value for All Messages Sent by TopicPublisher

```
/* Set default priority value to 2 for all messages sent by the TopicPublisher*/
TopicPublisher publisher;
publisher.setPriority(1);
```

15.5 Creating an AQjms Agent

```
public void createAQAgent(java.lang.String agent_name,
                          boolean enable_http,
                          throws JMSEException
```

This method creates an `AQjmsAgent`. It has the following parameters:

Parameter	Description
<code>agent_name</code>	Name of the AQ agent
<code>enable_http</code>	If set to true, then this agent is allowed to access AQ through HTTP

15.6 Receiving a Message Synchronously

You can receive a message synchronously by specifying `Timeout` or without waiting. You can also receive a message using a transformation:

- [Using a Message Consumer by Specifying Timeout](#)
- [Using a Message Consumer Without Waiting](#)
- [Receiving Messages from a Destination Using a Transformation](#)

15.6.1 Using a Message Consumer by Specifying Timeout

```
public javax.jms.Message receive(long timeout)
    throws JMSEException
```

This method receives a message using a message [consumer](#) by specifying timeout.

Parameter	Description
<code>timeout</code>	Timeout value in milliseconds

Example 15-6 Using a Message Consumer by Specifying Timeout

```
TopicConnectionFactory tc_fact = null;
TopicConnection t_conn = null;
TopicSession t_sess = null;
TopicSession jms_sess;
Topic shipped_orders;
int myport = 5521;

/* create connection and session */
tc_fact = AQjmsFactory.getTopicConnectionFactory(
    "MYHOSTNAME", "MYSID", myport, "oci8");
t_conn = tc_fact.createTopicConnection("jmsTopic", "jmsTopic");
jms_sess = t_conn.createTopicSession(true, Session.CLIENT_ACKNOWLEDGE);
shipped_orders = ((AQjmsSession) jms_sess).getTopic(
    "WS", "Shipped_Orders_Topic");

/* create a subscriber, specifying the correct CustomDatumFactory and
selector */
subscriber1 = jms_sess.createDurableSubscriber(
    shipped_orders, 'WesternShipping',
```

```

    " priority > 1 and tab.user_data.region like 'WESTERN %'",
    false, AQjmsAgent.getFactory());
/* receive, blocking for 30 seconds if there were no messages */
Message = subscriber.receive(30000);

```

Example 15-7 JMS: Blocking Until a Message Arrives

```

public BolOrder get_new_order1(QueueSession jms_session)
{
    Queue          queue;
    QueueReceiver  qrec;
    ObjectMessage  obj_message;
    BolCustomer    customer;
    BolOrder       new_order = null;
    String         state;

    try
    {
        /* get a handle to the new_orders queue */
        queue = ((AQjmsSession) jms_session).getQueue("OE", "OE_neworders_que");
        qrec = jms_session.createReceiver(queue);

        /* wait for a message to show up in the queue */
        obj_message = (ObjectMessage)qrec.receive();
        new_order = (BolOrder)obj_message.getObject();
        customer = new_order.getCustomer();
        state = customer.getState();
        System.out.println("Order:  for customer " + customer.getName());
    }
    catch (JMSEException ex)
    {
        System.out.println("Exception: " + ex);
    }
    return new_order;
}

```

15.6.2 Using a Message Consumer Without Waiting

```

public javax.jms.Message receiveNoWait()
    throws JMSEException

```

This method receives a message using a message consumer without waiting.

Example 15-8 JMS: Nonblocking Messages

```

public BolOrder poll_new_order3(QueueSession jms_session)
{
    Queue          queue;
    QueueReceiver  qrec;
    ObjectMessage  obj_message;
    BolCustomer    customer;
    BolOrder       new_order = null;
    String         state;

    try
    {
        /* get a handle to the new_orders queue */
        queue = ((AQjmsSession) jms_session).getQueue("OE", "OE_neworders_que");
        qrec = jms_session.createReceiver(queue);

        /* check for a message to show in the queue */

```

```

obj_message = (ObjectMessage)qrec.receiveNoWait();
new_order = (BolOrder)obj_message.getObject();
customer = new_order.getCustomer();
state     = customer.getState();

System.out.println("Order:  for customer " + customer.getName());
}
catch (JMSEException ex)
{
    System.out.println("Exception: " + ex);
}
return new_order;
}

```

15.6.3 Receiving Messages from a Destination Using a Transformation

A transformation can be applied when receiving a message from a queue or topic. The transformation is applied to the message before returning it to JMS application.

The transformation can be specified using the `setTransformation()` interface of the `AQjmsQueueReceiver`, `AQjmsTopicSubscriber` or `AQjmsTopicReceiver`.

Example 15-9 JMS: Receiving Messages from a Destination Using a Transformation

Assume that the Western Shipping application retrieves messages from the `OE_bookedorders_topic`. It specifies the transformation `OE2WS` to retrieve the message as the Oracle object type `WS_order`. Assume that the `WSOrder` Java class has been generated by `Jpublisher` to map to the Oracle object `WS.WS_order`:

```

public AQjmsAdtMessage retrieve_bookedorders(TopicSession jms_session)
    AQjmsTopicReceiver receiver;
    Topic                topic;
    Message               msg = null;

    try
    {
        /* get a handle to the OE_bookedorders_topic */
        topic = ((AQjmsSession)jms_session).getTopic("OE", "OE_bookedorders_topic");

        /* Create a receiver for WShip */
        receiver = ((AQjmsSession)jms_session).createTopicReceiver(
            topic, "WShip", null, WSOrder.getFactory());

        /* set the transformation in the publisher */
        receiver.setTransformation("OE2WS");
        msg = receiver.receive(10);
    }
    catch (JMSEException ex)
    {
        System.out.println("Exception :", ex);
    }
    return (AQjmsAdtMessage)msg;
}

```

15.7 Specifying the Navigation Mode for Receiving Messages

```
public void setNavigationMode(int mode)
    throws JMSEException
```

This method specifies the navigation mode for receiving messages. It has the following parameter:

Parameter	Description
mode	New value of the navigation mode

Example 15-10 Specifying Navigation Mode for Receiving Messages

```
TopicConnectionFactory    tc_fact    = null;
TopicConnection          t_conn     = null;
TopicSession             t_sess     = null;
TopicSession             jms_sess;
Topic                    shipped_orders;
int                       myport    = 5521;

/* create connection and session */
tc_fact = AQjmsFactory.getTopicConnectionFactory(
    "MYHOSTNAME", "MYSID", myport, "oci8");
t_conn = tc_fact.createTopicConnection("jmstopic", "jmstopic");
jms_sess = t_conn.createTopicSession(true, Session.CLIENT_ACKNOWLEDGE);
shipped_orders = ((AQjmsSession )jms_sess).getTopic("WS", "Shipped_Orders_Topic");

/* create a subscriber, specifying the correct CustomDatumFactory and selector */
subscriber1 = jms_sess.createDurableSubscriber(
    shipped_orders, 'WesternShipping',
    "priority > 1 and tab.user_data.region like 'WESTERN %'", false,
    AQjmsAgent.getFactory());
subscriber1.setNavigationMode(AQjmsConstants.NAVIGATION_FIRST_MESSAGE);

/* get message for the subscriber, returning immediately if there was nomessage */
Message = subscriber.receive();
```

15.8 Receiving a Message Asynchronously

You can receive a message asynchronously two ways:

- [Specifying a Message Listener at the Message Consumer](#)
- [Specifying a Message Listener at the Session](#)

15.8.1 Specifying a Message Listener at the Message Consumer

```
public void setMessageListener(javax.jms.MessageListener myListener)
    throws JMSEException
```

This method specifies a message listener at the message consumer. It has the following parameter:

Parameter	Description
myListener	Sets the consumer message listener

Example 15-11 Specifying Message Listener at Message Consumer

```

TopicConnectionFactory    tc_fact    = null;
TopicConnection          t_conn     = null;
TopicSession             t_sess     = null;
TopicSession             jms_sess;
Topic                    shipped_orders;
int                       myport    = 5521;
MessageListener           mLis      = null;

/* create connection and session */
tc_fact = AQjmsFactory.getTopicConnectionFactory(
    "MYHOSTNAME", "MYSID", myport, "oci8");
t_conn = tc_fact.createTopicConnection("jmsTopic", "jmsTopic");
jms_sess = t_conn.createTopicSession(true, Session.CLIENT_ACKNOWLEDGE);
shipped_orders = ((AQjmsSession) jms_sess).getTopic(
    "WS", "Shipped_Orders_Topic");

/* create a subscriber, specifying the correct CustomDatumFactory and selector */
subscriber1 = jms_sess.createDurableSubscriber(
    shipped_orders, 'WesternShipping',
    "priority > 1 and tab.user_data.region like 'WESTERN %'",
    false, AQjmsAgent.getFactory());
mLis = new myListener(jms_sess, "foo");

/* get message for the subscriber, returning immediately if there was no message */
subscriber.setMessageListener(mLis);
The definition of the myListener class
import oracle.AQ.*;
import oracle.jms.*;
import javax.jms.*;
import java.lang.*;
import java.util.*;
public class myListener implements MessageListener
{
    TopicSession    mySess;
    String          myName;
    /* constructor */
    myListener(TopicSession t_sess, String t_name)
    {
        mySess = t_sess;
        myName = t_name;
    }
    public onMessage(Message m)
    {
        System.out.println("Retrieved message with correlation: " ||
m.getJMSCorrelationID());
        try{
            /* commit the dequeue */
            mySession.commit();
        } catch (java.sql.SQLException e)
        {System.out.println("SQL Exception on commit"); }
    }
}

```

15.8.2 Specifying a Message Listener at the Session

```
public void setMessageListener(javax.jms.MessageListener listener)
    throws JMSEException
```

This method specifies a message listener at the session.

Parameter	Description
listener	Message listener to associate with this session

15.9 Getting Message ID

This section contains these topics:

- [Getting the Correlation Identifier](#)
- [Getting the Message Identifier](#)

15.9.1 Getting the Correlation Identifier

```
public java.lang.String getJMSCorrelationID()
    throws JMSEException
```

`AQjmsMessage.getJMSCorrelationID()` gets the correlation identifier of a message.

15.9.2 Getting the Message Identifier

```
public byte[] getJMSCorrelationIDAsBytes()
    throws JMSEException
```

`AQjmsMessage.getJMSMessageID()` gets the message identifier of a message as bytes or a string.

15.10 Getting JMS Message Properties

This section contains these topics:

- [Getting a Boolean Message Property](#)
- [Getting a String Message Property](#)
- [Getting an Integer Message Property](#)
- [Getting a Double Message Property](#)
- [Getting a Float Message Property](#)
- [Getting a Byte Message Property](#)
- [Getting a Long Message Property](#)
- [Getting a Short Message Property](#)
- [Getting an Object Message Property](#)

15.10.1 Getting a Boolean Message Property

```
public boolean getBooleanProperty(java.lang.String name)
    throws JMSEException
```

`AQjmsMessage.getBooleanProperty()` gets a message property as Boolean. It has the following parameter:

Parameter	Description
name	Name of the Boolean property

15.10.2 Getting a String Message Property

```
public java.lang.String getStringProperty(java.lang.String name)
    throws JMSEException
```

`AQjmsMessage.getStringProperty()` gets a message property as string. It has the following parameter:

Parameter	Description
name	Name of the string property

15.10.3 Getting an Integer Message Property

```
public int getIntProperty(java.lang.String name)
    throws JMSEException
```

`AQjmsMessage.getIntProperty()` gets a message property as integer. It has the following parameter:

Parameter	Description
name	Name of the integer property

15.10.4 Getting a Double Message Property

```
public double getDoubleProperty(java.lang.String name)
    throws JMSEException
```

`AQjmsMessage.getDoubleProperty()` gets a message property as double. It has the following parameter:

Parameter	Description
name	Name of the double property

15.10.5 Getting a Float Message Property

```
public float getFloatProperty(java.lang.String name)
    throws JMSEException
```

`AQjmsMessage.getFloatProperty()` gets a message property as float. It has the following parameter:

Parameter	Description
name	Name of the float property

15.10.6 Getting a Byte Message Property

```
public byte getByteProperty(java.lang.String name)
    throws JMSEException
```

`AQjmsMessage.getByteProperty()` gets a message property as byte. It has the following parameter:

Parameter	Description
name	Name of the byte property

15.10.7 Getting a Long Message Property

```
public long getLongProperty(java.lang.String name)
    throws JMSEException
```

`AQjmsMessage.getLongProperty()` gets a message property as long. It has the following parameter:

Parameter	Description
name	Name of the long property

15.10.8 Getting a Short Message Property

```
public short getShortProperty(java.lang.String name)
    throws JMSEException
```

`AQjmsMessage.getShortProperty()` gets a message property as short. It has the following parameter:

Parameter	Description
name	Name of the short property

15.10.9 Getting an Object Message Property

```
public java.lang.Object getObjectProperty(java.lang.String name)
    throws JMSEException
```

`AQjmsMessage.getObjectProperty()` gets a message property as object. It has the following parameter:

Parameter	Description
name	Name of the object property

Example 15-12 Getting Message Property as an Object

```
TextMessage message;  
message.getObjectProperty("empid", new Integer(1000));
```

15.11 Closing and Shutting Down

This section contains these topics:

- [Closing a MessageProducer](#)
- [Closing a Message Consumer](#)
- [Stopping a JMS Connection](#)
- [Closing a JMS Session](#)
- [Closing a JMS Connection](#)

15.11.1 Closing a MessageProducer

```
public void close()  
    throws JMSEException
```

`AQjmsProducer.close()` closes a MessageProducer.

15.11.2 Closing a Message Consumer

```
public void close()  
    throws JMSEException
```

`AQjmsConsumer.close()` closes a message consumer.

15.11.3 Stopping a JMS Connection

```
public void stop()  
    throws JMSEException
```

`AQjmsConnection.stop()` stops a JMS connection.

15.11.4 Closing a JMS Session

```
public void close()  
    throws JMSEException
```

`AQjmsSession.close()` closes a JMS session.

15.11.5 Closing a JMS Connection

```
public void close()  
    throws JMSEException
```

`AQjmsConnection.close()` closes a JMS connection and releases all resources allocated on behalf of the connection. Because the JMS provider typically allocates significant resources outside the JVM on behalf of a connection, clients should close them when they are not needed. Relying on garbage collection to eventually reclaim these resources may not be timely enough.

15.12 Troubleshooting

This section contains these topics:

- [Getting a JMS Error Code](#)
- [Getting a JMS Error Number](#)
- [Getting an Exception Linked to a JMS Exception](#)
- [Printing the Stack Trace for a JMS Exception](#)
- [Setting an Exception Listener](#)
- [Getting an Exception Listener](#)

15.12.1 Getting a JMS Error Code

```
public java.lang.String getErrorCode()
```

`AQjmsException.getErrorCode()` gets the error code for a JMS exception.

15.12.2 Getting a JMS Error Number

```
public int getErrorNumber()
```

`AQjmsException.getErrorNumber()` gets the error number for a JMS exception.

**Note:**

This method will be deprecated in a future release. Use `getErrorCode()` instead.

15.12.3 Getting an Exception Linked to a JMS Exception

```
public java.lang.String getLinkString()
```

`AQjmsException.getLinkString()` gets the exception linked to a JMS exception. In general, this contains the SQL exception raised by the database.

15.12.4 Printing the Stack Trace for a JMS Exception

```
public void printStackTrace(java.io.PrintStream s)
```

`AQjmsException.printStackTrace()` prints the stack trace for a JMS exception.

15.12.5 Setting an Exception Listener

```
public void setExceptionListener(javax.jms.ExceptionListener listener)
    throws JMSEException
```

`AQjmsConnection.setExceptionListener()` specifies an exception listener for a connection. It has the following parameter:

Parameter	Description
<code>listener</code>	Exception listener

If an exception listener has been registered, then it is informed of any serious problem detected for a connection. This is accomplished by calling the listener `onException()` method, passing it a JMS exception describing the problem. This allows a JMS client to be notified of a problem asynchronously. Some connections only consume messages, so they have no other way to learn the connection has failed.

Example 15-13 Specifying Exception Listener for Connection

```
//register an exception listener
Connection jms_connection;
jms_connection.setExceptionListener(
    new ExceptionListener() {
        public void onException (JMSEException jmsException) {
            System.out.println("JMS-EXCEPTION: " + jmsException.toString());
        }
    });
```

15.12.6 Getting an Exception Listener

```
public javax.jms.ExceptionListener getExceptionListener()
    throws JMSEException
```

`AQjmsConnection.getExceptionListener()` gets the exception listener for the connection.

[Example 15-14](#) demonstrates how to use `ExceptionListener` with `MessageListener`. Ensure that the following conditions are met:

- The user `jmsuser` with password `jmsuser` is created in the database, with appropriate privileges.
- The queue `demoQueue` is created and started.

This example demonstrates how to make the `MessageListener` asynchronously receive the messages, where the exception listener recreates the JMS objects in case there is a connection restart.

Example 15-14 Using ExceptionListener with MessageListener

```
import java.util.Enumeration;
import java.util.Properties;

import javax.jms.Connection;
import javax.jms.JMSEException;
import javax.jms.Message;
```

```
import javax.jms.MessageConsumer;
import javax.jms.MessageProducer;
import javax.jms.Queue;
import javax.jms.QueueBrowser;
import javax.jms.Session;
import javax.jms.TextMessage;

import oracle.jms.AQjmsConnectionFactory;
import oracle.jms.AQjmsFactory;
import oracle.jms.AQjmsSession;

public class JMSDemo {

    static String queueName = "demoQueue";

    static String queueOwner = "jmsuser";

    static String queueOwnerPassword = "jmsuser";

    static Connection connection = null;

    static int numberOfMessages = 25000;

    static int messageCount = 0;

    static String jdbcURL = "";

    public static void main(String args[]) {
        try {
            jdbcURL = System.getProperty("JDBC_URL");

            if (jdbcURL == null)
                System.out
                    .println("The system property JDBC_URL has not been set, " +
                        "usage:java -DJDBC_URL=xxx filename ");
            else {
                JMSDemo demo = new JMSDemo();
                demo.performJmsOperations();
            }
        } catch (Exception exception) {
            System.out.println("Exception : " + exception);
            exception.printStackTrace();
        } finally {
            try {
                if (connection != null)
                    connection.close();
            } catch (Exception exc) {
                exc.printStackTrace();
            }
        }
        System.out.println("\nEnd of Demo aqjmsdemo11.");
    }

    public void performJmsOperations() {
        try {
            connection = getConnection(jdbcURL);
            Session session = connection.createSession(false,
                Session.AUTO_ACKNOWLEDGE);
            Queue queue = session.createQueue(queueName);

            // remove the messages from the Queue
        }
    }
}
```

```
drainQueue(queueName, queueOwner, jdbcURL, true);

// set the exception listener on the Connection
connection.setExceptionListener(new DemoExceptionListener());

MessageProducer producer = session.createProducer(queue);
TextMessage textMessage = null;

System.out.println("Sending " + numberOfMessages + " messages to queue "
    + queueName);
for (int i = 0; i < numberOfMessages; i++) {
    textMessage = session.createTextMessage();
    textMessage.setText("Sample message text");
    producer.send(textMessage);
}

MessageConsumer consumer = session.createConsumer(queue);
System.out.println("Setting the message listener ...");
consumer.setMessageListener(new DemoMessageListener());
connection.start();

// Introduce a long wait to allow the listener to receive all the messages
while (messageCount < numberOfMessages) {
    try {
        Thread.sleep(5000);
    } catch (InterruptedException interruptedException) {
    }
}
} catch (JMSEException jmsException) {
    jmsException.printStackTrace();
}
}

// Sample message listener
static class DemoMessageListener implements javax.jms.MessageListener {

    public void onMessage(Message message) {
        try {
            System.out.println("Message listener received message with JMSMessageID "
                + message.getJMSMessageID());
            messageCount++;
        } catch (JMSEException jmsException) {
            System.out.println("JMSEException " + jmsException.getMessage());
        }
    }
}

// sample exception listener
static class DemoExceptionListener implements javax.jms.ExceptionListener {

    public void onException(JMSEException jmsException) {
        try {
            // As a first step close the connection
            if (connection != null)
                connection.close();
        } catch (JMSEException exception) {}

        try {
            System.out.println("Re-create the necessary JMS objects ...");
            connection = getConnection(jdbcURL);
            connection.start();
        }
    }
}
```

```
        Session session = connection.createSession(false,
            Session.AUTO_ACKNOWLEDGE);
        Queue queue = session.createQueue(queueName);
        MessageConsumer consumer = session.createConsumer(queue);
        consumer.setMessageListener(new DemoMessageListener());
    } catch (JMSEException newJmsException) {
        newJmsException.printStackTrace();
    }
}
}

// Utility method to get a connection
static Connection getConnection(String jdbcUrl) throws JMSEException {
    Properties prop = new Properties();
    prop.put("user", queueOwner);
    prop.put("password", queueOwnerPassword);

    AQjmsConnectionFactory fact = (AQjmsConnectionFactory) AQjmsFactory
        .getConnectionFactory(jdbcUrl, prop);
    Connection conn = fact.createConnection();
    return conn;
}

// Utility method to remove the messages from the queue
static void drainQueue(String queueName, String queueOwner, String jdbcUrl,
    boolean debugInfo) {
    Connection connection = null;
    Session session = null;
    long timeout = 10000;
    int count = 0;
    Message message = null;
    try {
        connection = getConnection(jdbcUrl);
        connection.start();
        session = connection.createSession(false, Session.AUTO_ACKNOWLEDGE);
        Queue queue = ((AQjmsSession) session).getQueue(queueOwner, queueName);

        MessageConsumer messageConsumer = session.createConsumer(queue);
        QueueBrowser browser = session.createBrowser(queue);
        Enumeration enumeration = browser.getEnumeration();

        if (enumeration.hasMoreElements()) {
            while ((message = messageConsumer.receive(timeout)) != null) {
                if (debugInfo) {
                    count++;
                }
            }
        }
        messageConsumer.close();
        if (debugInfo) {
            System.out.println("Removed " + count + " messages from the queue : "
                + queueName);
        }
    } catch (JMSEException jmsException) {
        jmsException.printStackTrace();
    } finally {
        try {
            if (session != null)
                session.close();

            if (connection != null)
```



```
        connection.close();
    } catch (Exception exception) {
    }
}
}
```

Example 15-15 Getting the Exception Listener for the Connection

```
//Get the exception listener
Connection jms_connection;
ExceptionListener el = jms_connection.getExceptionListener();
```

16

Oracle Java Message Service Types Examples

The following examples illustrate how to use Oracle JMS Types to [dequeue](#) and [enqueue](#) Oracle Database Advanced Queuing (AQ) messages.

- [How to Setup the Oracle Database Advanced Queuing JMS Type Examples](#)
- [JMS BytesMessage Examples](#)
- [JMS StreamMessage Examples](#)
- [JMS MapMessage Examples](#)
- [More Oracle Database Advanced Queuing JMS Examples](#)

16.1 How to Set Up the Oracle Database Advanced Queuing JMS Type Examples

To run [Example 16-3](#) through [Example 16-8](#) follow these steps:

1. Copy and save [Example 16-1](#) as `setup.sql`.
2. Run `setup.sql` as follows:

```
sqlplus /NOLOG @setup.sql
```
3. Log in to SQL*Plus as `jmsuser/jmsuser`.
4. Run the corresponding pair of SQL scripts for each type of [message](#).
For JMS `BytesMessage`, for example, run [Example 16-3](#) and [Example 16-4](#).
5. Ensure that your database parameter `java_pool_size` is large enough. For example, you can use `java_pool_size=20M`.

Example 16-1 Setting Up Environment for Running JMS Types Examples

```
connect sys;
enter password: password

Rem
Rem Create the JMS user: jmsuser
Rem

DROP USER jmsuser CASCADE;
CREATE USER jmsuser IDENTIFIED BY jmsuser;
GRANT EXECUTE ON DBMS_AQADM TO jmsuser;
GRANT EXECUTE ON DBMS_AQ TO jmsuser;
GRANT EXECUTE ON DBMS_LOB TO jmsuser;
GRANT EXECUTE ON DBMS_JMS_PLSQL TO jmsuser;

set echo off set verify off connect sys DROP USER jmsuser CASCADE;ACCEPT password CHAR
PROMPT 'Enter the password for JMSUSER: ' HIDECREATE USER jmsuser IDENTIFIED BY
```

```
&password;GRANT DBA, AQ_ADMINISTRATOR_ROLE, AQ_USER_ROLE to jmsuser;GRANT EXECUTE ON
DBMS_AQADM TO jmsuser;GRANT EXECUTE ON DBMS_AQ TO jmsuser;GRANT EXECUTE ON DBMS_LOB
TO jmsuser;GRANT EXECUTE ON DBMS_JMS_PLSQL TO jmsuser;connect jmsuser/&password
```

```
Rem
Rem Creating five AQ queue tables and five queues for five payloads:
Rem SYS.AQ$_JMS_TEXT_MESSAGE
Rem SYS.AQ$_JMS_BYTES_MESSAGE
Rem SYS.AQ$_JMS_STREAM_MESSAG
Rem SYS.AQ$_JMS_MAP_MESSAGE
Rem SYS.AQ$_JMS_MESSAGE
Rem
EXECUTE DBMS_AQADM.CREATE_QUEUE_TABLE (Queue_table => 'jmsuser.jms_qtt_text',
Queue_payload_type => 'SYS.AQ$_JMS_TEXT_MESSAGE', compatible => '8.1.0');
EXECUTE DBMS_AQADM.CREATE_QUEUE_TABLE (Queue_table => 'jmsuser.jms_qtt_bytes',
Queue_payload_type => 'SYS.AQ$_JMS_BYTES_MESSAGE', compatible => '8.1.0');
EXECUTE DBMS_AQADM.CREATE_QUEUE_TABLE (Queue_table => 'jmsuser.jms_qtt_stream',
Queue_payload_type => 'SYS.AQ$_JMS_STREAM_MESSAGE', compatible => '8.1.0');
EXECUTE DBMS_AQADM.CREATE_QUEUE_TABLE (Queue_table => 'jmsuser.jms_qtt_map',
Queue_payload_type => 'SYS.AQ$_JMS_MAP_MESSAGE', compatible => '8.1.0');
EXECUTE DBMS_AQADM.CREATE_QUEUE_TABLE (Queue_table => 'jmsuser.jms_qtt_general',
Queue_payload_type => 'SYS.AQ$_JMS_MESSAGE', compatible => '8.1.0');
EXECUTE DBMS_AQADM.CREATE_QUEUE (Queue_name => 'jmsuser.jms_text_que',
Queue_table => 'jmsuser.jms_qtt_text');
EXECUTE DBMS_AQADM.CREATE_QUEUE (Queue_name => 'jmsuser.jms_bytes_que',
Queue_table => 'jmsuser.jms_qtt_bytes');
EXECUTE DBMS_AQADM.CREATE_QUEUE (Queue_name => 'jmsuser.jms_stream_que',
Queue_table => 'jmsuser.jms_qtt_stream');
EXECUTE DBMS_AQADM.CREATE_QUEUE (Queue_name => 'jmsuser.jms_map_que',
Queue_table => 'jmsuser.jms_qtt_map');
EXECUTE DBMS_AQADM.CREATE_QUEUE (Queue_name => 'jmsuser.jms_general_que',
Queue_table => 'jmsuser.jms_qtt_general');
```

```
Rem
Rem Starting the queues and enable both enqueue and dequeue
Rem
EXECUTE DBMS_AQADM.START_QUEUE (Queue_name => 'jmsuser.jms_text_que');
EXECUTE DBMS_AQADM.START_QUEUE (Queue_name => 'jmsuser.jms_bytes_que');
EXECUTE DBMS_AQADM.START_QUEUE (Queue_name => 'jmsuser.jms_stream_que');
EXECUTE DBMS_AQADM.START_QUEUE (Queue_name => 'jmsuser.jms_map_que');
EXECUTE DBMS_AQADM.START_QUEUE (Queue_name => 'jmsuser.jms_general_que');
```

```
Rem The supporting utility used in the example to help display results in SQLPLUS
enviroment
```

```
Rem
Rem Display a RAW data in SQLPLUS
Rem
create or replace procedure display_raw(rdata raw)
IS
    pos                pls_integer;
    length             pls_integer;
BEGIN
    pos := 1;
    length := UTL_RAW.LENGTH(rdata);

    WHILE pos <= length LOOP
        IF pos+20 > length+1 THEN
            dbms_output.put_line(UTL_RAW.SUBSTR(rdata, pos, length-pos+1));
        ELSE
```

```

        dbms_output.put_line(UTL_RAW.SUBSTR(rdata, pos, 20));
    END IF;
    pos := pos+20;
END LOOP;

END display_raw;
/

show errors;

Rem
Rem Display a BLOB data in SQLPLUS
Rem
create or replace procedure display_blob(bdata blob)
IS
    pos            pls_integer;
    length         pls_integer;
BEGIN
    length := dbms_lob.getlength(bdata);
    pos := 1;
    WHILE pos <= length LOOP
        display_raw(DBMS_LOB.SUBSTR(bdata, 2000, pos));
        pos := pos+2000;
    END LOOP;
END display_blob;
/

show errors;

Rem
Rem Display a VARCHAR data in SQLPLUS
Rem
create or replace procedure display_varchar(vdata varchar)
IS
    pos            pls_integer;
    text_len      pls_integer;
BEGIN
    text_len := length(vdata);
    pos := 1;

    WHILE pos <= text_len LOOP
        IF pos+20 > text_len+1 THEN
            dbms_output.put_line(SUBSTR(vdata, pos, text_len-pos+1));
        ELSE
            dbms_output.put_line(SUBSTR(vdata, pos, 20));
        END IF;
        pos := pos+20;
    END LOOP;

END display_varchar;
/

show errors;

Rem
Rem Display a CLOB data in SQLPLUS
Rem
create or replace procedure display_clob(cdata clob)
IS
    pos            pls_integer;
    length         pls_integer;

```

```

BEGIN
    length := dbms_lob.getlength(cdata);
    pos := 1;
    WHILE pos <= length LOOP
        display_varchar(DBMS_LOB.SUBSTR(cdata, 2000, pos));
        pos := pos+2000;
    END LOOP;
END display_clob;
/

show errors;

Rem
Rem Display a SYS.AQ$_JMS_EXCEPTION data in SQLPLUS
Rem
Rem When application receives an ORA-24197 error, It means the JAVA stored
Rem procedures has thrown some exceptions that could not be catergorized. The
Rem user can use GET_EXCEPTION procedure of SYS.AQ$_JMS_BYTES_MESSAGE,
Rem SYS.AQ$_JMS_STREAM_MESSAG or SYS.AQ$_JMS_MAP_MESSAGE
Rem to retrieve a SYS.AQ$_JMS_EXCEPTION object which contains more detailed
Rem information on this JAVA exception including the exception name, JAVA error
Rem message and stack trace.
Rem
Rem This utility function is to help display the SYS.AQ$_JMS_EXCEPTION object in
Rem SQLPLUS
Rem
create or replace procedure display_exp(exp SYS.AQ$_JMS_EXCEPTION)
IS
    pos1          pls_integer;
    pos2          pls_integer;
    text_data     varchar(2000);
BEGIN
    dbms_output.put_line('exception:' || exp.exp_name);
    dbms_output.put_line('err_msg:' || exp.err_msg);
    dbms_output.put_line('stack:' || length(exp.stack));
    pos1 := 1;
    LOOP
        pos2 := INSTR(exp.stack, chr(10), pos1);
        IF pos2 = 0 THEN
            pos2 := length(exp.stack)+1;
        END IF;

        dbms_output.put_line(SUBSTR(exp.stack, pos1, pos2-pos1));

        IF pos2 > length(exp.stack) THEN
            EXIT;
        END IF;

        pos1 := pos2+1;
    END LOOP;

END display_exp;
/

show errors;

EXIT;

```

Example 16-2 Setting Up the Examples

[Example 16-1](#) performs the necessary setup for the JMS types examples. Copy and save it as `setup.sql`.

16.2 JMS BytesMessage Examples

This section includes examples that illustrate enqueueing and dequeuing of a JMS BytesMessage.

[Example 16-3](#) shows how to use JMS type member functions with `DBMS_AQ` functions to populate and enqueue a JMS BytesMessage represented as `sys.aq$_jms_bytes_message` type in the database. This message later can be dequeued by a [JAVA Oracle Java Message Service](#) (Oracle JMS) client.

[Example 16-4](#) illustrates how to use JMS type member functions with `DBMS_AQ` functions to dequeue and retrieve data from a JMS BytesMessage represented as `sys.aq$_jms_bytes_message` type in the database. This message might be enqueued by an Oracle JMS client.

Example 16-3 Populating and Enqueuing a BytesMessage

```
set echo offset verify offconnect sysDROP USER jmsuser CASCADE;ACCEPT password CHAR
PROMPT 'Enter the password for JMSUSER: ' HIDECREATE USER jmsuser IDENTIFIED BY
&password;GRANT DBA, AQ_ADMINISTRATOR_ROLE, AQ_USER_ROLE to jmsuser;GRANT EXECUTE ON
DBMS_AQADM TO jmsuser;GRANT EXECUTE ON DBMS_AQ TO jmsuser;GRANT EXECUTE ON DBMS_LOB
TO jmsuser;GRANT EXECUTE ON DBMS_JMS_PLSQL TO jmsuser;connect jmsuser/&password
```

```
SET ECHO ON
set serveroutput on
```

```
DECLARE
```

```
    id                pls_integer;
    agent             sys.aq$_agent := sys.aq$_agent(' ', null, 0);
    message           sys.aq$_jms_bytes_message;
    enqueue_options  dbms_aq.enqueue_options_t;
    message_properties dbms_aq.message_properties_t;
    msgid raw(16);
```

```
    java_exp         exception;
    pragma EXCEPTION_INIT(java_exp, -24197);
```

```
BEGIN
```

```
    -- Construct a empty BytesMessage object
    message := sys.aq$_jms_bytes_message.construct;
```

```
    -- Shows how to set the JMS header
    message.set_replyto(agent);
    message.set_type('tkaqpet1');
    message.set_userid('jmsuser');
    message.set_appid('plsqli_enq');
    message.set_groupid('st');
    message.set_groupseq(1);
```

```
    -- Shows how to set JMS user properties
    message.set_string_property('color', 'RED');
    message.set_int_property('year', 1999);
    message.set_float_property('price', 16999.99);
    message.set_long_property('mileage', 300000);
```

```
message.set_boolean_property('import', True);
message.set_byte_property('password', -127);

-- Shows how to populate the message payload of aq$_jms_bytes_message

-- Passing -1 reserve a new slot within the message store of
sys.aq$_jms_bytes_message.
-- The maximum number of sys.aq$_jms_bytes_message type of messages to be
operated at
-- the same time within a session is 20. Calling clean_body function with
parameter -1
-- might result a ORA-24199 error if the messages currently operated is already
20.
-- The user is responsible to call clean or clean_all function to clean up
message store.
id := message.clear_body(-1);

-- Write data into the BytesMessage payload. These functions are analogy of JMS
JAVA api's.
-- See the document for detail.

-- Write a byte to the BytesMessage payload
message.write_byte(id, 10);

-- Write a RAW data as byte array to the BytesMessage payload
message.write_bytes(id, UTL_RAW.XRANGE(HEXTORAW('00'), HEXTORAW('FF')));

-- Write a portion of the RAW data as byte array to BytesMessage payload
-- Note the offset follows JAVA convention, starting from 0
message.write_bytes(id, UTL_RAW.XRANGE(HEXTORAW('00'), HEXTORAW('FF')), 0, 16);

-- Write a char to the BytesMessage payload
message.write_char(id, 'A');

-- Write a double to the BytesMessage payload
message.write_double(id, 9999.99);

-- Write a float to the BytesMessage payload
message.write_float(id, 99.99);

-- Write a int to the BytesMessage payload
message.write_int(id, 12345);

-- Write a long to the BytesMessage payload
message.write_long(id, 1234567);

-- Write a short to the BytesMessage payload
message.write_short(id, 123);

-- Write a String to the BytesMessage payload,
-- the String is encoded in UTF8 in the message payload
message.write_utf(id, 'Hello World!');

-- Flush the data from JAVA stored procedure (JServ) to PL/SQL side
-- Without doing this, the PL/SQL message is still empty.
message.flush(id);

-- Use either clean_all or clean to clean up the message store when the user
-- do not plan to do payload population on this message anymore
sys.aq$_jms_bytes_message.clean_all();
--message.clean(id);
```

```

-- Enqueue this message into AQ queue using DBMS_AQ package
dbms_aq.enqueue(queue_name => 'jmsuser.jms_bytes_que',
               enqueue_options => enqueue_options,
               message_properties => message_properties,
               payload => message,
               msgid => msgid);

EXCEPTION
WHEN java_exp THEN
    dbms_output.put_line('exception information:');
    display_exp(sys.aq$_jms_stream_message.get_exception());

END;
/

commit;

```

Example 16-4 Dequeuing and Retrieving JMS BytesMessage Data

```

set echo off
set verify off

DROP USER jmsuser CASCADE;

ACCEPT password CHAR PROMPT 'Enter the password for JMSUSER: ' HIDE

CREATE USER jmsuser IDENTIFIED BY &password;
GRANT EXECUTE ON DBMS_AQADM TO jmsuser;
GRANT EXECUTE ON DBMS_AQ TO jmsuser;
GRANT EXECUTE ON DBMS_LOB TO jmsuser;
GRANT EXECUTE ON DBMS_JMS_PLSQL TO jmsuser;
connect jmsuser/&password
set echo on
set serveroutput on size 20000

DECLARE

    id                pls_integer;
    blob_data         blob;
    clob_data         clob;
    blob_len          pls_integer;
    message           sys.aq$_jms_bytes_message;
    agent             sys.aq$_agent;
    dequeue_options   dbms_aq.dequeue_options_t;
    message_properties dbms_aq.message_properties_t;
    msgid raw(16);
    gdata             sys.aq$_jms_value;

    java_exp          exception;
    pragma EXCEPTION_INIT(java_exp, -24197);
BEGIN
    DBMS_OUTPUT.ENABLE (20000);

    -- Dequeue this message from AQ queue using DBMS_AQ package
    dbms_aq.dequeue(queue_name => 'jmsuser.jms_bytes_que',
                   dequeue_options => dequeue_options,
                   message_properties => message_properties,
                   payload => message,
                   msgid => msgid);

```



```
-- Retrieve the header
agent := message.get_replyto;

dbms_output.put_line('Type: ' || message.get_type ||
                    ' UserId: ' || message.get_userid ||
                    ' AppId: ' || message.get_appid ||
                    ' GroupId: ' || message.get_groupid ||
                    ' GroupSeq: ' || message.get_groupseq);

-- Retrieve the user properties
dbms_output.put_line('price: ' || message.get_float_property('price'));
dbms_output.put_line('color: ' || message.get_string_property('color'));
IF message.get_boolean_property('import') = TRUE THEN
    dbms_output.put_line('import: Yes' );
ELSIF message.get_boolean_property('import') = FALSE THEN
    dbms_output.put_line('import: No' );
END IF;
dbms_output.put_line('year: ' || message.get_int_property('year'));
dbms_output.put_line('mileage: ' || message.get_long_property('mileage'));
dbms_output.put_line('password: ' || message.get_byte_property('password'));

-- Shows how to retrieve the message payload of aq$_jms_bytes_message

-- Prepare call, send the content in the PL/SQL aq$_jms_bytes_message object to
-- Java stored procedure(Jserv) in the form of a byte array.
-- Passing -1 reserves a new slot in msg store of sys.aq$_jms_bytes_message.
-- Max number of sys.aq$_jms_bytes_message type of messages to be operated at
-- the same time in a session is 20. Call clean_body fn. with parameter -1
-- might result in ORA-24199 error if messages operated on are already 20.
-- You must call clean or clean_all function to clean up message store.
id := message.prepare(-1);

-- Read data from BytesMessage payload. These fns. are analogy of JMS Java
-- API's. See the JMS Types chapter for detail.
dbms_output.put_line('Payload:');

-- read a byte from the BytesMessage payload
dbms_output.put_line('read_byte:' || message.read_byte(id));

-- read a byte array into a blob object from the BytesMessage payload
dbms_output.put_line('read_bytes:');
blob_len := message.read_bytes(id, blob_data, 272);
display_blob(blob_data);

-- read a char from the BytesMessage payload
dbms_output.put_line('read_char:' || message.read_char(id));

-- read a double from the BytesMessage payload
dbms_output.put_line('read_double:' || message.read_double(id));

-- read a float from the BytesMessage payload
dbms_output.put_line('read_float:' || message.read_float(id));

-- read a int from the BytesMessage payload
dbms_output.put_line('read_int:' || message.read_int(id));

-- read a long from the BytesMessage payload
dbms_output.put_line('read_long:' || message.read_long(id));

-- read a short from the BytesMessage payload
```

```

dbms_output.put_line('read_short:' || message.read_short(id));

-- read a String from the BytesMessage payload.
-- the String is in UTF8 encoding in the message payload
dbms_output.put_line('read_utf:');
message.read_utf(id, clob_data);
display_clob(clob_data);

-- Use either clean_all or clean to clean up the message store when the user
-- do not plan to do payload retrieving on this message anymore
message.clean(id);
-- sys.aq$_jms_bytes_message.clean_all();

EXCEPTION
WHEN java_exp THEN
    dbms_output.put_line('exception information:');
    display_exp(sys.aq$_jms_bytes_message.get_exception());

END;
/

commit;

```

16.3 JMS StreamMessage Examples

This section includes examples that illustrate enqueueing and dequeuing of a JMS `StreamMessage`.

[Example 16-5](#) shows how to use JMS type member functions with `DBMS_AQ` functions to populate and enqueue a JMS `StreamMessage` represented as `sys.aq$_jms_stream_message` type in the database. This message later can be dequeued by an Oracle JMS client.

[Example 16-6](#) shows how to use JMS type member functions with `DBMS_AQ` functions to dequeue and retrieve data from a JMS `StreamMessage` represented as `sys.aq$_jms_stream_message` type in the database. This message might be enqueued by an Oracle JMS client.

Example 16-5 Populating and Enqueuing a JMS StreamMessage

```

set echo off
set verify off

DROP USER jmsuser CASCADE;

ACCEPT password CHAR PROMPT 'Enter the password for JMSUSER: ' HIDE

CREATE USER jmsuser IDENTIFIED BY &password;
GRANT EXECUTE ON DBMS_AQADM TO jmsuser;
GRANT EXECUTE ON DBMS_AQ TO jmsuser;
GRANT EXECUTE ON DBMS_LOB TO jmsuser;
GRANT EXECUTE ON DBMS_JMS_PLSQL TO jmsuser;
connect jmsuser/&password
SET ECHO ON
set serveroutput on

DECLARE

    id                pls_integer;

```

```
agent          sys.aq$_agent := sys.aq$_agent(' ', null, 0);
message        sys.aq$_jms_stream_message;
enqueue_options dbms_aq.enqueue_options_t;
message_properties dbms_aq.message_properties_t;
msgid raw(16);

java_exp       exception;
pragma EXCEPTION_INIT(java_exp, -24197);
BEGIN

-- Construct a empty StreamMessage object
message := sys.aq$_jms_stream_message.construct;

-- Shows how to set the JMS header
message.set_replyto(agent);
message.set_type('tkaqpet1');
message.set_userid('jmsuser');
message.set_appid('plsqa_enq');
message.set_groupid('st');
message.set_groupseq(1);

-- Shows how to set JMS user properties
message.set_string_property('color', 'RED');
message.set_int_property('year', 1999);
message.set_float_property('price', 16999.99);
message.set_long_property('mileage', 300000);
message.set_boolean_property('import', True);
message.set_byte_property('password', -127);

-- Shows how to populate the message payload of aq$_jms_stream_message

-- Passing -1 reserve a new slot within the message store of
sys.aq$_jms_stream_message.
-- The maximum number of sys.aq$_jms_stream_message type of messages to be
operated at
-- the same time within a session is 20. Calling clean_body function with
parameter -1
-- might result a ORA-24199 error if the messages currently operated is already
20.
-- The user is responsible to call clean or clean_all function to clean up
message store.
id := message.clear_body(-1);

-- Write data into the message payload. These functions are analogy of JMS JAVA
api's.
-- See the document for detail.

-- Write a byte to the StreamMessage payload
message.write_byte(id, 10);

-- Write a RAW data as byte array to the StreamMessage payload
message.write_bytes(id, UTL_RAW.XRANGE(HEXTORAW('00'), HEXTORAW('FF')));

-- Write a portion of the RAW data as byte array to the StreamMessage payload
-- Note the offset follows JAVA convention, starting from 0
message.write_bytes(id, UTL_RAW.XRANGE(HEXTORAW('00'), HEXTORAW('FF')), 0, 16);

-- Write a char to the StreamMessage payload
message.write_char(id, 'A');

-- Write a double to the StreamMessage payload
```

```

message.write_double(id, 9999.99);

-- Write a float to the StreamMessage payload
message.write_float(id, 99.99);

-- Write a int to the StreamMessage payload
message.write_int(id, 12345);

-- Write a long to the StreamMessage payload
message.write_long(id, 1234567);

-- Write a short to the StreamMessage payload
message.write_short(id, 123);

-- Write a String to the StreamMessage payload
message.write_string(id, 'Hello World!');

-- Flush the data from JAVA stored procedure (JServ) to PL/SQL side
-- Without doing this, the PL/SQL message is still empty.
message.flush(id);

-- Use either clean_all or clean to clean up the message store when the user
-- do not plan to do payload population on this message anymore
sys.aq$_jms_stream_message.clean_all();
--message.clean(id);

-- Enqueue this message into AQ queue using DBMS_AQ package
dbms_aq.enqueue(queue_name => 'jmsuser.jms_stream_que',
               enqueue_options => enqueue_options,
               message_properties => message_properties,
               payload => message,
               msgid => msgid);

EXCEPTION
WHEN java_exp THEN
    dbms_output.put_line('exception information:');
    display_exp(sys.aq$_jms_stream_message.get_exception());

END;
/

commit;

```

Example 16-6 Dequeuing and Retrieving Data From a JMS StreamMessage

```

set echo off
set verify off

DROP USER jmsuser CASCADE;

ACCEPT password CHAR PROMPT 'Enter the password for JMSUSER: ' HIDE

CREATE USER jmsuser IDENTIFIED BY &password;
GRANT EXECUTE ON DBMS_AQADM TO jmsuser;
GRANT EXECUTE ON DBMS_AQ TO jmsuser;
GRANT EXECUTE ON DBMS_LOB TO jmsuser;
GRANT EXECUTE ON DBMS_JMS_PLSQL TO jmsuser;
connect jmsuser/&password
set echo on

```

```
set serveroutput on

DECLARE

    id                pls_integer;
    blob_data         blob;
    clob_data         clob;
    message           sys.aq$_jms_stream_message;
    agent             sys.aq$_agent;
    dequeue_options   dbms_aq.dequeue_options_t;
    message_properties dbms_aq.message_properties_t;
    msgid raw(16);
    gdata             sys.aq$_jms_value;

    java_exp          exception;
    pragma EXCEPTION_INIT(java_exp, -24197);
BEGIN
    DBMS_OUTPUT.ENABLE (20000);

    -- Dequeue this message from AQ queue using DBMS_AQ package
    dbms_aq.dequeue(queue_name => 'jmsuser.jms_stream_que',
                   dequeue_options => dequeue_options,
                   message_properties => message_properties,
                   payload => message,
                   msgid => msgid);

    -- Retrieve the header
    agent := message.get_replyto;

    dbms_output.put_line('Type: ' || message.get_type ||
                        ' UserId: ' || message.get_userid ||
                        ' AppId: ' || message.get_appid ||
                        ' GroupId: ' || message.get_groupid ||
                        ' GroupSeq: ' || message.get_groupseq);

    -- Retrieve the user properties
    dbms_output.put_line('price: ' || message.get_float_property('price'));
    dbms_output.put_line('color: ' || message.get_string_property('color'));
    IF message.get_boolean_property('import') = TRUE THEN
        dbms_output.put_line('import: Yes' );
    ELSIF message.get_boolean_property('import') = FALSE THEN
        dbms_output.put_line('import: No' );
    END IF;
    dbms_output.put_line('year: ' || message.get_int_property('year'));
    dbms_output.put_line('mileage: ' || message.get_long_property('mileage'));
    dbms_output.put_line('password: ' || message.get_byte_property('password'));

    -- Shows how to retrieve the message payload of aq$_jms_stream_message

    -- The prepare call send the content in the PL/SQL aq$_jms_stream_message object
    to
    -- JAVA stored procedure(Jserv) in the form of byte array.
    -- Passing -1 reserve a new slot within the message store of
    sys.aq$_jms_stream_message.
    -- The maximum number of sys.aq$_jms_stream_message type of messages to be
    operated at
    -- the same time within a session is 20. Calling clean_body function with
    parameter -1
    -- might result a ORA-24199 error if the messages currently operated is already
    20.
    -- The user is responsible to call clean or clean_all function to clean up
```

```
message store.
  id := message.prepare(-1);

  -- Assume the users know the types of data in the StreamMessage payload.
  -- The user can use the specific read function corresponding with the data type.
  -- These functions are analogy of JMS JAVA api's. See the document for detail.
  dbms_output.put_line('Retrieve payload by Type:');

  -- Read a byte from the StreamMessage payload
  dbms_output.put_line('read_byte:' || message.read_byte(id));

  -- Read a byte array into a blob object from the StreamMessage payload
  dbms_output.put_line('read_bytes:');
  message.read_bytes(id, blob_data);
  display_blob(blob_data);

  -- Read another byte array into a blob object from the StreamMessage payload
  dbms_output.put_line('read_bytes:');
  message.read_bytes(id, blob_data);
  display_blob(blob_data);

  -- Read a char from the StreamMessage payload
  dbms_output.put_line('read_char:' || message.read_char(id));

  -- Read a double from the StreamMessage payload
  dbms_output.put_line('read_double:' || message.read_double(id));

  -- Read a float from the StreamMessage payload
  dbms_output.put_line('read_float:' || message.read_float(id));

  -- Read a int from the StreamMessage payload
  dbms_output.put_line('read_int:' || message.read_int(id));

  -- Read a long from the StreamMessage payload
  dbms_output.put_line('read_long:' || message.read_long(id));

  -- Read a short from the StreamMessage payload
  dbms_output.put_line('read_short:' || message.read_short(id));

  -- Read a String into a clob data from the StreamMessage payload
  dbms_output.put_line('read_string:');
  message.read_string(id, clob_data);
  display_clob(clob_data);

  -- Assume the users do not know the types of data in the StreamMessage payload.
  -- The user can use read_object method to read the data into a sys.aq$_jms_value
  object
  -- These functions are analogy of JMS JAVA api's. See the document for detail.

  -- Reset the stream pointer to the begining of the message so that we can read
  throught
  -- the message payload again.
  message.reset(id);

  LOOP
    message.read_object(id, gdata);
    IF gdata IS NULL THEN
      EXIT;
    END IF;
```

```

CASE gdata.type
  WHEN sys.dbms_jms_plsql.DATA_TYPE_BYTE      THEN
    dbms_output.put_line('read_object/byte:' || gdata.num_val);
  WHEN sys.dbms_jms_plsql.DATA_TYPE_SHORT    THEN
    dbms_output.put_line('read_object/short:' || gdata.num_val);
  WHEN sys.dbms_jms_plsql.DATA_TYPE_INTEGER  THEN
    dbms_output.put_line('read_object/int:' || gdata.num_val);
  WHEN sys.dbms_jms_plsql.DATA_TYPE_LONG     THEN
    dbms_output.put_line('read_object/long:' || gdata.num_val);
  WHEN sys.dbms_jms_plsql.DATA_TYPE_FLOAT    THEN
    dbms_output.put_line('read_object/float:' || gdata.num_val);
  WHEN sys.dbms_jms_plsql.DATA_TYPE_DOUBLE   THEN
    dbms_output.put_line('read_object/double:' || gdata.num_val);
  WHEN sys.dbms_jms_plsql.DATA_TYPE_BOOLEAN  THEN
    dbms_output.put_line('read_object/boolean:' || gdata.num_val);
  WHEN sys.dbms_jms_plsql.DATA_TYPE_CHARACTER THEN
    dbms_output.put_line('read_object/char:' || gdata.char_val);
  WHEN sys.dbms_jms_plsql.DATA_TYPE_STRING   THEN
    dbms_output.put_line('read_object/string:');
    display_clob(gdata.text_val);
  WHEN sys.dbms_jms_plsql.DATA_TYPE_BYTES    THEN
    dbms_output.put_line('read_object/bytes:');
    display_blob(gdata.bytes_val);
  ELSE dbms_output.put_line('No such data type');
END CASE;

END LOOP;

-- Use either clean_all or clean to clean up the message store when the user
-- do not plan to do payload retrieving on this message anymore
message.clean(id);
-- sys.aq$_jms_stream_message.clean_all();

EXCEPTION
WHEN java_exp THEN
  dbms_output.put_line('exception information:');
  display_exp(sys.aq$_jms_stream_message.get_exception());

END;
/

commit;

```

16.4 JMS MapMessage Examples

This section includes examples that illustrate enqueueing and dequeuing of a JMS `MapMessage`.

Example 16-7 shows how to use JMS type member functions with `DBMS_AQ` functions to populate and enqueue a JMS `MapMessage` represented as `sys.aq$_jms_map_message` type in the database. This message later can be dequeued by an Oracle JMS client.

Example 16-8 illustrates how to use JMS type member functions with `DBMS_AQ` functions to dequeue and retrieve data from a JMS `MapMessage` represented as `sys.aq$_jms_map_message` type in the database. This message can be enqueued by an Oracle JMS client.

Example 16-7 Populating and Enqueuing a JMS MapMessage

```
set echo off
set verify off

DROP USER jmsuser CASCADE;

ACCEPT password CHAR PROMPT 'Enter the password for JMSUSER: ' HIDE

CREATE USER jmsuser IDENTIFIED BY &password;
GRANT EXECUTE ON DBMS_AQADM TO jmsuser;
GRANT EXECUTE ON DBMS_AQ TO jmsuser;
GRANT EXECUTE ON DBMS_LOB TO jmsuser;
GRANT EXECUTE ON DBMS_JMS_PLSQL TO jmsuser;
connect jmsuser/&password

SET ECHO ON
set serveroutput on

DECLARE

    id                pls_integer;
    agent             sys.aq$_agent := sys.aq$_agent(' ', null, 0);
    message           sys.aq$_jms_map_message;
    enqueue_options  dbms_aq.enqueue_options_t;
    message_properties dbms_aq.message_properties_t;
    msgid raw(16);

    java_exp          exception;
    pragma EXCEPTION_INIT(java_exp, -24197);
BEGIN

    -- Construct a empty map message object
    message := sys.aq$_jms_map_message.construct;

    -- Shows how to set the JMS header
    message.set_replyto(agent);
    message.set_type('tkaqp1');
    message.set_userid('jmsuser');
    message.set_appid('plssql_enq');
    message.set_groupid('st');
    message.set_groupseq(1);

    -- Shows how to set JMS user properties
    message.set_string_property('color', 'RED');
    message.set_int_property('year', 1999);
    message.set_float_property('price', 16999.99);
    message.set_long_property('mileage', 300000);
    message.set_boolean_property('import', True);
    message.set_byte_property('password', -127);

    -- Shows how to populate the message payload of aq$_jms_map_message

    -- Passing -1 reserve a new slot within the message store of
    sys.aq$_jms_map_message.
    -- The maximum number of sys.aq$_jms_map_message type of messages to be operated
    at
    -- the same time within a session is 20. Calling clean_body function with
    parameter -1
    -- might result a ORA-24199 error if the messages currently operated is already
```



```
20.
-- The user is responsible to call clean or clean_all function to clean up
message store.
  id := message.clear_body(-1);

-- Write data into the message payload. These functions are analogy of JMS JAVA
api's.
-- See the document for detail.

-- Set a byte entry in map message payload
message.set_byte(id, 'BYTE', 10);

-- Set a byte array entry using RAW data in map message payload
message.set_bytes(id, 'BYTES', UTL_RAW.XRANGE(HEXTORAW('00'), HEXTORAW('FF')));

-- Set a byte array entry using only a portion of the RAW data in map message
payload
-- Note the offset follows JAVA convention, starting from 0
message.set_bytes(id, 'BYTES_PART', UTL_RAW.XRANGE(HEXTORAW('00'),
HEXTORAW('FF')), 0, 16);

-- Set a char entry in map message payload
message.set_char(id, 'CHAR', 'A');

-- Set a double entry in map message payload
message.set_double(id, 'DOUBLE', 9999.99);

-- Set a float entry in map message payload
message.set_float(id, 'FLOAT', 99.99);

-- Set a int entry in map message payload
message.set_int(id, 'INT', 12345);

-- Set a long entry in map message payload
message.set_long(id, 'LONG', 1234567);

-- Set a short entry in map message payload
message.set_short(id, 'SHORT', 123);

-- Set a String entry in map message payload
message.set_string(id, 'STRING', 'Hello World!');

-- Flush the data from JAVA stored procedure (JServ) to PL/SQL side
-- Without doing this, the PL/SQL message is still empty.
message.flush(id);

-- Use either clean_all or clean to clean up the message store when the user
-- do not plan to do payload population on this message anymore
sys.aq$_jms_map_message.clean_all();
--message.clean(id);

-- Enqueue this message into AQ queue using DBMS_AQ package
dbms_aq.enqueue(queue_name => 'jmsuser.jms_map_que',
  enqueue_options => enqueue_options,
  message_properties => message_properties,
  payload => message,
  msgid => msgid);

END;
/
```

```
commit;
```

Example 16-8 Dequeuing and Retrieving Data From a JMS MapMessage

```
set echo off
set verify off

DROP USER jmsuser CASCADE;

ACCEPT password CHAR PROMPT 'Enter the password for JMSUSER: ' HIDE

CREATE USER jmsuser IDENTIFIED BY &password;
GRANT EXECUTE ON DBMS_AQADM TO jmsuser;
GRANT EXECUTE ON DBMS_AQ TO jmsuser;
GRANT EXECUTE ON DBMS_LOB TO jmsuser;
GRANT EXECUTE ON DBMS_JMS_PLSQL TO jmsuser;
connect jmsuser/&password

set echo on
set serveroutput on

DECLARE

    id                pls_integer;
    blob_data         blob;
    clob_data         clob;
    message           sys.aq$_jms_map_message;
    agent             sys.aq$_agent;
    dequeue_options   dbms_aq.dequeue_options_t;
    message_properties dbms_aq.message_properties_t;
    msgid             raw(16);
    name_arr          sys.aq$_jms_namearray;
    gdata             sys.aq$_jms_value;

    java_exp          exception;
    pragma EXCEPTION_INIT(java_exp, -24197);
BEGIN
    DBMS_OUTPUT.ENABLE (20000);

    -- Dequeue this message from AQ queue using DBMS_AQ package
    dbms_aq.dequeue(queue_name => 'jmsuser.jms_map_que',
                    dequeue_options => dequeue_options,
                    message_properties => message_properties,
                    payload => message,
                    msgid => msgid);

    -- Retrieve the header
    agent := message.get_replyto;

    dbms_output.put_line('Type: ' || message.get_type ||
                        ' UserId: ' || message.get_userid ||
                        ' AppId: ' || message.get_appid ||
                        ' GroupId: ' || message.get_groupid ||
                        ' GroupSeq: ' || message.get_groupseq);

    -- Retrieve the user properties
    dbms_output.put_line('price: ' || message.get_float_property('price'));
    dbms_output.put_line('color: ' || message.get_string_property('color'));
    IF message.get_boolean_property('import') = TRUE THEN
```

```
        dbms_output.put_line('import: Yes' );
ELSIF message.get_boolean_property('import') = FALSE THEN
        dbms_output.put_line('import: No' );
END IF;
dbms_output.put_line('year: ' || message.get_int_property('year'));
dbms_output.put_line('mileage: ' || message.get_long_property('mileage'));
dbms_output.put_line('password: ' || message.get_byte_property('password'));

-- Shows how to retrieve the message payload of aq$_jms_map_message

-- 'Prepare' sends the content in the PL/SQL aq$_jms_map_message object to
-- Java stored procedure(Jserv) in the form of byte array.
-- Passing -1 reserve a new slot within the message store of
-- sys.aq$_jms_map_message. The maximum number of sys.aq$_jms_map_message
-- type of messages to be operated at the same time within a session is 20.
-- Calling clean_body function with parameter -1
-- might result a ORA-24199 error if the messages currently operated is
-- already 20. The user is responsible to call clean or clean_all function
-- to clean up message store.
id := message.prepare(-1);

-- Assume the users know the names and types in the map message payload.
-- The user can use names to get the corresponding values.
-- These functions are analogous to JMS Java API's. See JMS Types chapter
-- for detail.
dbms_output.put_line('Retrieve payload by Name:');

-- Get a byte entry from the map message payload
dbms_output.put_line('get_byte:' || message.get_byte(id, 'BYTE'));

-- Get a byte array entry from the map message payload
dbms_output.put_line('get_bytes:');
message.get_bytes(id, 'BYTES', blob_data);
display_blob(blob_data);

-- Get another byte array entry from the map message payload
dbms_output.put_line('get_bytes:');
message.get_bytes(id, 'BYTES_PART', blob_data);
display_blob(blob_data);

-- Get a char entry from the map message payload
dbms_output.put_line('get_char:' || message.get_char(id, 'CHAR'));

-- get a double entry from the map message payload
dbms_output.put_line('get_double:' || message.get_double(id, 'DOUBLE'));

-- Get a float entry from the map message payload
dbms_output.put_line('get_float:' || message.get_float(id, 'FLOAT'));

-- Get a int entry from the map message payload
dbms_output.put_line('get_int:' || message.get_int(id, 'INT'));

-- Get a long entry from the map message payload
dbms_output.put_line('get_long:' || message.get_long(id, 'LONG'));

-- Get a short entry from the map message payload
dbms_output.put_line('get_short:' || message.get_short(id, 'SHORT'));

-- Get a String entry from the map message payload
dbms_output.put_line('get_string:');
```

```
message.get_string(id, 'STRING', clob_data);
display_clob(clob_data);

-- Assume users do not know names and types in map message payload.
-- User can first retrieve the name array containing all names in the
-- payload and iterate through the name list and get the corresponding
-- value. These functions are analogous to JMS Java API's.
-- See JMS Type chapter for detail.
dbms_output.put_line('Retrieve payload by iteration:');

-- Get the name array from the map message payload
name_arr := message.get_names(id);

-- Iterate through the name array to retrieve the value for each of the name.
FOR i IN name_arr.FIRST..name_arr.LAST LOOP

-- Test if a name exist in the map message payload
-- (It is not necessary in this case, just a demonstration on how to use it)
IF message.item_exists(id, name_arr(i)) THEN
    dbms_output.put_line('item exists:' || name_arr(i));

-- Because we do not know the type of entry, we must use sys.aq$_jms_value
-- type object for the data returned
message.get_object(id, name_arr(i), gdata);
IF gdata IS NOT NULL THEN
    CASE gdata.type
    WHEN sys.dbms_jms_plsql.DATA_TYPE_BYTE
        THEN dbms_output.put_line('get_object/byte:' || gdata.num_val);
    WHEN sys.dbms_jms_plsql.DATA_TYPE_SHORT
        THEN dbms_output.put_line('get_object/short:' || gdata.num_val);
    WHEN sys.dbms_jms_plsql.DATA_TYPE_INTEGER
        THEN dbms_output.put_line('get_object/int:' || gdata.num_val);
    WHEN sys.dbms_jms_plsql.DATA_TYPE_LONG
        THEN dbms_output.put_line('get_object/long:' || gdata.num_val);
    WHEN sys.dbms_jms_plsql.DATA_TYPE_FLOAT
        THEN dbms_output.put_line('get_object/float:' || gdata.num_val);
    WHEN sys.dbms_jms_plsql.DATA_TYPE_DOUBLE
        THEN dbms_output.put_line('get_object/double:' || gdata.num_val);
    WHEN sys.dbms_jms_plsql.DATA_TYPE_BOOLEAN
        THEN dbms_output.put_line('get_object/boolean:' || gdata.num_val);
    WHEN sys.dbms_jms_plsql.DATA_TYPE_CHARACTER
        THEN dbms_output.put_line('get_object/char:' || gdata.char_val);
    WHEN sys.dbms_jms_plsql.DATA_TYPE_STRING
        THEN dbms_output.put_line('get_object/string:');
        display_clob(gdata.text_val);
    WHEN sys.dbms_jms_plsql.DATA_TYPE_BYTES
        THEN
            dbms_output.put_line('get_object/bytes:');
            display_blob(gdata.bytes_val);
        ELSE dbms_output.put_line('No such data type');
    END CASE;
    END IF;
ELSE
    dbms_output.put_line('item not exists:' || name_arr(i));
END IF;

END LOOP;

-- Use either clean_all or clean to clean up the message store when the user
-- do not plan to do paylaod population on this message anymore
```

```

message.clean(id);
-- sys.aq$_jms_map_message.clean_all();

EXCEPTION
WHEN java_exp THEN
    dbms_output.put_line('exception information:');
    display_exp(sys.aq$_jms_stream_message.get_exception());

END;
/

commit;

```

16.5 More Oracle Database Advanced Queuing JMS Examples

The sample program in [Example 16-9](#) enqueues a large `TextMessage` (along with JMS user properties) in an Oracle Database Advanced Queuing queue created through the Oracle JMS administrative interfaces to hold JMS `TEXT` messages. Both the `TextMessage` and `BytesMessage` enqueued in this example can be dequeued using Oracle JMS clients.

The sample program in [Example 16-10](#) enqueues a large `BytesMessage`.

Example 16-9 Enqueuing a Large TextMessage

```

DECLARE

    text          varchar2(32767);
    agent         sys.aq$_agent      := sys.aq$_agent(' ', null, 0);
    message       sys.aq$_jms_text_message;

    enqueue_options dbms_aq.enqueue_options_t;
    message_properties dbms_aq.message_properties_t;
    msgid          raw(16);

BEGIN

    message := sys.aq$_jms_text_message.construct;

    message.set_replyto(agent);
    message.set_type('tkaqp2');
    message.set_userid('jmsuser');
    message.set_appid('plsqli_enq');
    message.set_groupid('st');
    message.set_groupseq(1);

    message.set_boolean_property('import', True);
    message.set_string_property('color', 'RED');
    message.set_short_property('year', 1999);
    message.set_long_property('mileage', 300000);
    message.set_double_property('price', 16999.99);
    message.set_byte_property('password', 127);

    FOR i IN 1..500 LOOP
        text := CONCAT (text, '1234567890');
    END LOOP;

    message.set_text(text);

```

```

dbms_aq.enqueue(queue_name => 'jmsuser.jms_text_t1',
                enqueue_options => enqueue_options,
                message_properties => message_properties,
                payload => message,
                msgid => msgid);

END;

```

Example 16-10 Enqueuing a Large BytesMessage

```

DECLARE

    text          VARCHAR2(32767);
    bytes         RAW(32767);
    agent         sys.aq$_agent := sys.aq$_agent(' ', null, 0);
    message       sys.aq$_jms_bytes_message;
    body          BLOB;
    position      INT;

    enqueue_options dbms_aq.enqueue_options_t;
    message_properties dbms_aq.message_properties_t;
    msgid raw(16);

BEGIN

    message := sys.aq$_jms_bytes_message.construct;

    message.set_replyto(agent);
    message.set_type('tkapper4');
    message.set_userid('jmsuser');
    message.set_appid('plsqli_enq_raw');
    message.set_groupid('st');
    message.set_groupseq(1);

    message.set_boolean_property('import', True);
    message.set_string_property('color', 'RED');
    message.set_short_property('year', 1999);
    message.set_long_property('mileage', 300000);
    message.set_double_property('price', 16999.99);

    -- prepare a huge payload into a blob

    FOR i IN 1..1000 LOOP
        text := CONCAT (text, '0123456789ABCDEF');
    END LOOP;

    bytes := HEXTORAW(text);

    dbms_lob.createtemporary(lob_loc => body, cache => TRUE);
    dbms_lob.open (body, DBMS_LOB.LOB_READWRITE);
    position := 1 ;
    FOR i IN 1..10 LOOP
        dbms_lob.write ( lob_loc => body,
                        amount => FLOOR((LENGTH(bytes)+1)/2),
                        offset => position,
                        buffer => bytes);
        position := position + FLOOR((LENGTH(bytes)+1)/2) ;
    END LOOP;

    -- end of the preparation

```

```
message.set_bytes(body);
dbms_aq.enqueue(queue_name => 'jmsuser.jms_bytes_t1',
               enqueue_options => enqueue_options,
               message_properties => message_properties,
               payload => message,
               msgid => msgid);

dbms_lob.freetemporary(lob_loc => body);
END;
```

Introduction to Oracle Messaging Gateway

The Messaging Gateway administration package `DBMS_MGWADM` provides an interface for creating Messaging Gateway agents, managing agents, creating messaging system links, registering non-Oracle queues, and setting up propagation jobs.

Topics:

- [Oracle Messaging Gateway Overview](#)
- [Oracle Messaging Gateway Features](#)
- [Oracle Messaging Gateway Architecture](#)
- [Propagation Processing Overview](#)
- [Oracle Database AQ Buffered Messages and Messaging Gateway](#)

17.1 Oracle Messaging Gateway Overview

Messaging Gateway enables communication between applications based on non-Oracle messaging systems and Oracle Database Advanced Queuing.

Oracle Database Advanced Queuing provides [propagation](#) between two Oracle Database Advanced Queuing queues to enable e-business (HTTP through [IDAP](#)). Messaging Gateway extends this to applications based on non-Oracle messaging systems.

Because Messaging Gateway is integrated with Oracle Database Advanced Queuing and Oracle Database, it offers reliable [message](#) delivery. Messaging Gateway guarantees that messages are delivered once and only once between Oracle Database Advanced Queuing and non-Oracle messaging systems that support persistence. The PL/SQL interface provides an easy-to-learn administrative [API](#), especially for developers already proficient in using Oracle Database Advanced Queuing.

This release of Messaging Gateway supports the integration of Oracle Database Advanced Queuing with applications based on WebSphere MQ 7.0.1.3 and TIB/Rendezvous 8.2.

17.2 Oracle Messaging Gateway Features

Messaging Gateway provides the following features:

- Extends Oracle Database Advanced Queuing message propagation

Messaging Gateway propagates messages between Oracle Database Advanced Queuing and non-Oracle messaging systems. Messages sent by Oracle Database Advanced Queuing applications can be received by non-Oracle messaging system applications. Conversely, messages published by non-Oracle messaging system

applications can be consumed by Oracle Database Advanced Queuing applications.

- Support for [Java Message Service](#) (JMS) messaging systems
Messaging Gateway propagates messages between Oracle Java Message Service (Oracle JMS) and WebSphere MQ Java Message Service (WebSphere MQ JMS).
- Native message format support
Messaging Gateway supports the native message formats of messaging systems. Oracle Database Advanced Queuing messages can have `RAW` or any Oracle [object type](#) payload. WebSphere MQ messages can be text or byte messages. TIB/Rendezvous messages can be any TIB/Rendezvous wire format datatype except the nested datatype `MSG` and those with unsigned integers.
- Message conversion
Messaging Gateway facilitates message conversion between Oracle Database Advanced Queuing messages and non-Oracle messaging system messages. Messages are converted through either automatic routines provided by Messaging Gateway or customized message [transformation](#) functions that you provide.

 **Note:**

- Messaging Gateway does not support message propagation between JMS and non-JMS messaging systems.
- Oracle Database AQ Sharded Queues are not supported by MGW in 12c Release 2 (12.2)

- Integration with Oracle Database
Messaging Gateway is managed through a PL/SQL interface similar to that of Oracle Database Advanced Queuing. Configuration information is stored in Oracle Database tables. Message propagation is carried out by an external process of the Oracle Database server.
- Guaranteed message delivery
If the messaging systems at the propagation source and propagation destination both support transactions, then Messaging Gateway guarantees that persistent messages are propagated exactly once. If messages are not persistent or transactions are not supported by the messaging systems at the propagation source or propagation destination, then at-most-once propagation is guaranteed.
- Security support
Messaging Gateway supports client authentication of Oracle Database and non-Oracle messaging systems.
Messaging Gateway also allows Secure Socket Layer (SSL) support for IBM WebSphere MQ and WebSphere MQ JMS connections made by the Messaging Gateway agent.
- Multiple agent support
Messaging Gateway supports multiple agents for a given database. Users can partition propagation jobs based on functionality, organizations, or workload and

assign them to different Messaging Gateway agents. This allows Messaging Gateway to scale in an Oracle RAC environment and enables propagation job grouping and isolation.

 **See Also:**

- ["Propagation Processing Overview"](#)
- [Oracle Messaging Gateway Message Conversion](#)
- ["Converting Oracle Messaging Gateway Non-JMS Messages"](#)

17.3 Oracle Messaging Gateway Architecture

Messaging Gateway has two main components:

- Administration Package DBMS_MGWADM
- Messaging Gateway Agent

[Figure 17-1](#) shows how these components work together with Oracle Database and non-Oracle messaging systems.

Figure 17-1 Messaging Gateway Architecture

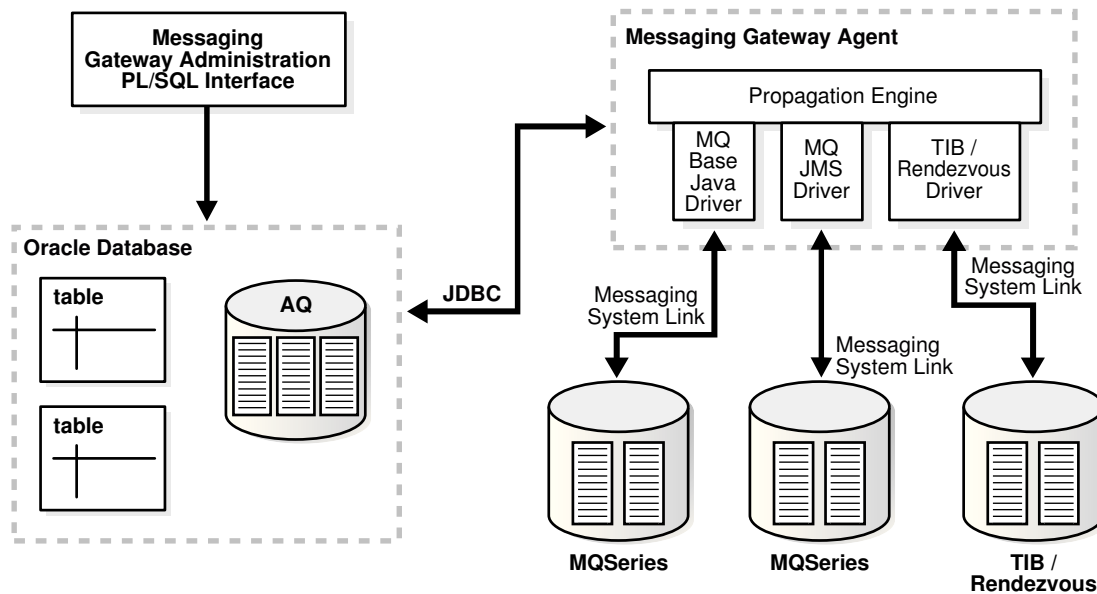

17.3.1 Administration Package DBMS_MGWADM

The Messaging Gateway administration package `DBMS_MGWADM` provides an interface for creating named Messaging Gateway agents, managing agents, creating messaging system links, registering non-Oracle queues, and setting up propagation jobs.

Users call the procedures in the package to make configuration changes regardless of whether the Messaging Gateway agent is running. If the Messaging Gateway agent is running, then the procedures in the package send notifications for configuration changes to the agent. The agent dynamically alters its configuration for most configuration changes, although some changes require that the agent be shut down and restarted before they take effect. All the procedures in the package are serialized to guarantee that the Messaging Gateway agent receives and processes notifications in the same order as they are made.



See Also:

Oracle Database PL/SQL Packages and Types Reference for more information on `DBMS_MGWADM`

17.3.2 Oracle Messaging Gateway Agent

The Messaging Gateway agent runs as an external process of the Oracle Database server and processes propagation jobs. It is started and shut down by calling the `STARTUP` and `SHUTDOWN` procedures in `DBMS_MGWADM` package.

The Messaging Gateway agent contains a multithreaded propagation engine and a set of drivers for messaging systems. The propagation engine fairly schedules propagation jobs and processes propagation jobs concurrently. The polling thread in the agent periodically polls the source queues of enabled propagation jobs and wakes up worker threads to process propagation jobs if messages are available. The drivers for non-Oracle messaging systems run as clients of the messaging systems for all messaging operations.

17.3.3 Oracle Database

As an Oracle Database feature, Messaging Gateway provides a mechanism of message propagation between Oracle Database Advanced Queuing and non-Oracle messaging systems. Oracle Database Advanced Queuing is involved in every propagation job as either propagation source or propagation destination.

Messaging Gateway is managed through the PL/SQL administration package `DBMS_MGWADM`. All configuration information and execution state information of Messaging Gateway are stored in Oracle Database and can be accessed through database views.

The Messaging Gateway agent runs as an external procedure of the Oracle Database server. Therefore, it runs only when its associated database server is running.

17.3.4 Non-Oracle Messaging Systems

The Messaging Gateway agent connects to non-Oracle messaging systems through messaging system links. Messaging system links are communication channels between the Messaging Gateway agent and non-Oracle messaging systems. Users can use the administration package `DBMS_MGWADM` to configure multiple links to the same or different non-Oracle messaging systems.

Queues in non-Oracle messaging systems, such as WebSphere MQ queues, TIB/Rendezvous subjects, and WebSphere MQ JMS destinations (queues and topics) can all serve as propagation sources and destinations for Messaging Gateway. They are referred to as foreign queues. All foreign queues involved in message propagation as source queues, destination queues, or exception queues must be registered through the administration package. The registration of a foreign [queue](#) does not create the physical queue in a non-Oracle messaging system, but merely records information about the queue, such as the messaging system link to access it, its native name, and its domain (queue or topic). The physical queue must be created through the administration interface of the non-Oracle messaging system.

**See Also:**

["Registering a Non-Oracle Queue"](#)

17.4 Propagation Processing Overview

Propagation jobs must be defined in order for messages to be propagated from one messaging system to another. A propagation job defines the source queue, destination queue, and various other attributes that affect the processing of the propagation job.

If the propagation source is a queue (point-to-point), then the Messaging Gateway agent moves all messages in the queue to the destination. If the propagation source is a topic ([publish/subscribe](#)), then the Messaging Gateway agent creates a subscription on the propagation source topic. The agent moves all messages that are published to the topic after the subscription is created.

A propagation job is processed when it is enabled. Disabling a propagation job stops propagation processing but does not stop message subscription.

When the Messaging Gateway agent processes a propagation job, it dequeues messages from the source queue and enqueues the messages to the destination queue. As each message is propagated, it is converted from its native format in the source messaging system to its native format in the destination messaging system. Messaging Gateway provides automatic message conversions between simple and commonly used message formats. You can customize message conversions by providing your own message transformation functions.

When the Messaging Gateway agent fails to convert a message from the source format to the destination format, the agent moves the message from the source queue to an [exception queue](#), if the exception queue exists, and continues to process the propagation job.

If the Messaging Gateway agent runs into failures when processing a propagation job, it retries up to sixteen times in an exponential backoff scheme (from two seconds up to thirty minutes) before it stops retrying.

To guarantee reliable message delivery, Messaging Gateway requires logging queues in messaging systems that support transactions and persistent messages. The Messaging Gateway agent uses the logging queues to store the processing states of propagation jobs so that it can restore propagation processing from failures.



See Also:

["Configuring Oracle Messaging Gateway Propagation Jobs"](#)

17.5 Oracle Database AQ Buffered Messages and Messaging Gateway

Messaging Gateway does not support propagation of buffered messages. In outbound propagation, the Messaging Gateway agent dequeues only persistent messages from AQ queues. In inbound propagation, the Messaging Gateway agent always enqueues persistent messages into AQ queues.

18

Getting Started with Oracle Messaging Gateway

The following topics describe Oracle Messaging Gateway (MGW) prerequisites and how to load, set up, and unload Messaging Gateway. They also describe how to set up and modify the `mgw.ora` initialization file.

- [Oracle Messaging Gateway Prerequisites](#)
- [Loading and Setting Up Oracle Messaging Gateway](#)
- [Setting Up Non-Oracle Messaging Systems](#)
- [Verifying the Oracle Messaging Gateway Setup](#)
- [Unloading Oracle Messaging Gateway](#)
- [Understanding the mgw.ora Initialization File](#)

18.1 Oracle Messaging Gateway Prerequisites

Messaging Gateway uses one Oracle Scheduler job for each Messaging Gateway agent. If the value of the `JOB_QUEUE_PROCESSES` database initialization parameter is zero, then no Oracle Scheduler jobs will run. If the value is non-zero, it effectively becomes the maximum number of Scheduler jobs and job queue jobs that can run concurrently.

Verify that a non-zero value is set, and that it is large enough to accommodate a Scheduler job for each Messaging Gateway agent to be started.

18.2 Loading and Setting Up Oracle Messaging Gateway

Perform the following procedures before running Messaging Gateway:

- [Loading Database Objects into the Database](#)
- [Modifying listener.ora for the External Procedure](#)
- [Modifying tnsnames.ora for the External Procedure](#)
- [Setting Up an mgw.ora Initialization File](#)
- [Creating an Oracle Messaging Gateway Administrator User](#)
- [Creating an Oracle Messaging Gateway Agent User](#)
- [Configuring Oracle Messaging Gateway Connection Information](#)
- [Configuring Oracle Messaging Gateway in an Oracle RAC Environment](#)

 **Note:**

These setup instructions are specific to 32-bit and 64-bit versions of the Windows and 64-bit versions of the Unix-based operating systems. The tasks apply to both Windows and Unix-based operating systems, except where "Windows Operating System Only" or "Linux Operating System Only" is indicated. For other operating systems, see operating-system specific documentation.

18.2.1 Loading Database Objects into the Database

Using SQL*Plus, run `ORACLE_HOME/mgw/admin/catmgw.sql` as user `SYS` as `SYSDBA`. This script loads the database objects necessary for Messaging Gateway, including roles, tables, views, object types, and PL/SQL packages. It creates public synonyms for Messaging Gateway PL/SQL packages. It creates two roles, `MGW_ADMINISTRATOR_ROLE` and `MGW_AGENT_ROLE`, with certain privileges granted. All objects are owned by `SYS`.

 **Note:**

In a CDB environment, run `ORACLE_HOME/mgw/admin/catmgw.sql` as `PDB root`.

18.2.2 Modifying listener.ora for the External Procedure

This procedure is for Unix-based operating systems only. Static service information for the listener is not necessary on the Windows operating system.

You must modify `listener.ora` so that the Messaging Gateway PL/SQL packages can call the external procedure.

1. Verify that the default [Inter-process Communication](#) (IPC) protocol address for the external procedures is set.

```
LISTENER = (ADDRESS_LIST=
  (ADDRESS=(PROTOCOL=IPC)(KEY=EXTPROC))
```

2. Add static service information for the listener in step 1. This involves setting a `SID_DESC` for the listener. Within the `SID_DESC`, the parameters described in [Table 18-1](#) are important to Messaging Gateway and must be specified according to your own situation.

Example 18-1 Adding Static Service Information for a Listener

```
# Add a SID_DESC
SID_LIST_LISTENER= (SID_LIST=
  (SID_DESC =
    (SID_NAME= mgwextproc)
    (ENVS=
      "LD_LIBRARY_PATH=JRE_HOME/lib/amd64:JRE_HOME/lib/amd64/server:ORACLE_HOME/lib")
    (ORACLE_HOME=ORACLE_HOME)
    (PROGRAM = extproc))
```

Table 18-1 SID_DESC Parameters

Parameter	Description
SID_NAME	The SID that is specified in the net service name in <code>tnsnames.ora</code> . In the following example, the SID_NAME is <code>mgwextproc</code> .
ENVS	Set up the <code>LD_LIBRARY_PATH</code> environment needed for the external procedure to run. The <code>LD_LIBRARY_PATH</code> must contain the following paths: <pre>JRE_HOME/lib/PLATFORM_TYPE JRE_HOME/lib/PLATFORM_TYPE/server ORACLE_HOME/lib</pre> <p>It should also contain any additional libraries required by third-party messaging systems. See "Setting Up Non-Oracle Messaging Systems".</p> <p>The <code>ENVS</code> value is <code>LD_LIBRARY_PATH_64</code> for Oracle Solaris on SPARC (64-Bit) and Oracle Solaris on x86-64 (64-Bit), <code>LIBPATH</code> for IBM AIX on POWER Systems, and <code>LD_LIBRARY_PATH</code> for the remaining platforms.</p>
ORACLE_HOME	Your Oracle home directory. Using <code>\$ORACLE_HOME</code> does not work.
PROGRAM	The name of the external procedure agent, which is <code>extproc</code>

 **Note:**

`JRE_HOME` represents the root directory of a JRE installation, just as `ORACLE_HOME` represents the root directory of an Oracle installation. Oracle recommends that you use the JRE installed with Oracle Database.

Example 18-1 adds SID_NAME `mgwextproc` to a `listener.ora` file for Linux x86.

18.2.3 Modifying `tnsnames.ora` for the External Procedure

For the external procedure, configure a net service name `MGW_AGENT` in `tnsnames.ora` whose connect descriptor matches the information configured in `listener.ora`, as shown in [Example 18-2](#). The net service name must be `MGW_AGENT` (this value is fixed). The `KEY` value must match the `KEY` value specified for the IPC protocol in `listener.ora`. The `SID` value must match the value specified for `SID_NAME` of the `SID_DESC` entry in `listener.ora`.

 **Note:**

If the `names.default_domain` parameter for `sqlnet.ora` has been used to set a default domain, then that domain must be appended to the `MGW_AGENT` net service name in `tnsnames.ora`. For example, if `sqlnet.ora` contains the entry `names.default_domain=acme.com`, then the net service name in `tnsnames.ora` must be `MGW_AGENT.acme.com`.

Example 18-2 Configuring MGW_AGENT

```
MGW_AGENT =  
(DESCRIPTION=  
  (ADDRESS_LIST= (ADDRESS= (PROTOCOL=IPC)(KEY=EXTPROC)))  
  (CONNECT_DATA= (SID=mgwextproc)))
```

18.2.4 Setting Up an mgw.ora Initialization File

The Messaging Gateway default initialization file `ORACLE_HOME/mgw/admin/mgw.ora` is a text file. The Messaging Gateway external procedure uses it to get initialization parameters to start the Messaging Gateway agent. Copy `ORACLE_HOME/mgw/admin/sample_mgw.ora` to `mgw.ora` and modify it according to your situation.

The following procedure sets environment variables and other parameters required for all applications of Messaging Gateway:

1. **Windows Operating System Only:** Set the `MGW_PRE_PATH` variable. Its value is the path to the `jvm.dll` library:

```
set MGW_PRE_PATH = JRE_HOME\bin\client
```

This variable is prepended to the path inherited by the Messaging Gateway agent process.

2. Set `CLASSPATH` to include at least the following:

- JRE runtime classes:

```
JRE_HOME/lib/rt.jar
```

- Oracle JDBC classes:

```
ORACLE_HOME/jdbc/lib/ojdbc6.jar
```

- Oracle internationalization classes:

```
ORACLE_HOME/jlib/orai18n.jar
```

- SQLJ runtime:

```
ORACLE_HOME/sqlj/lib/runtime12.jar
```

- [Java Message Service \(JMS\) interface](#)

```
ORACLE_HOME/rdbms/jlib/jmscommon.jar
```

- Oracle JMS implementation classes

```
ORACLE_HOME/rdbms/jlib/aqapi.jar
```

- [Java transaction API](#)

```
ORACLE_HOME/jlib/jta.jar
```

- Any additional classes needed for Messaging Gateway to access non-Oracle messaging systems

 **Note:**

Replace `ORACLE_HOME` with the appropriate, spelled-out value. Using `$ORACLE_HOME`, for example, does not work.

Users of the Windows operating system must set `CLASSPATH` using the Windows operating system path syntax.

 **See Also:**

["Setting Up Non-Oracle Messaging Systems"](#)

18.2.5 Creating an Oracle Messaging Gateway Administrator User

To perform Messaging Gateway administration work, a database user must be created with `MGW_ADMINISTRATOR_ROLE` privileges, as shown in [Example 18-3](#).

Example 18-3 Creating a Messaging Gateway Administrator User

```
CREATE USER admin_user IDENTIFIED BY admin_password;  
GRANT CREATE SESSION to admin_user;  
GRANT MGW_ADMINISTRATOR_ROLE to admin_user;
```

18.2.6 Creating an Oracle Messaging Gateway Agent User

To establish the Messaging Gateway agent connection back to the database, a database user with `MGW_AGENT_ROLE` privileges must be created, as shown in [Example 18-4](#).

Example 18-4 Creating a Messaging Gateway Agent User

```
CREATE USER agent_user IDENTIFIED BY agent_password;  
GRANT CREATE SESSION to agent_user;  
GRANT MGW_AGENT_ROLE to agent_user;
```

18.2.7 Configuring Oracle Messaging Gateway Connection Information

After the Messaging Gateway agent user is created, the administration user uses `DBMS_MGWADM.ALTER_AGENT` to configure Messaging Gateway with the user name, password, and database connect string used by the Messaging Gateway agent to connect back to the database, as shown in [Example 18-5](#). Use the Messaging Gateway user name and password that you created in "[Creating an Oracle Messaging Gateway Agent User](#)". The database connect string parameter can be set to either a net service name in `tnsnames.ora` (with IPC protocol for better performance) or `NULL`. If `NULL`, then the `oracle_sid` parameter must be set in `mgw.ora`.

For this release, always specify a not `NULL` value for the database connect string parameter when calling `DBMS_MGWADM.ALTER_AGENT`.

Example 18-5 Configuring Messaging Gateway Connection Information

```

set echo off
set verify off
connect admin_user

ACCEPT password CHAR PROMPT 'Enter the password for AGENT_USER: ' HIDE

EXEC DBMS_MGWADM.ALTER_AGENT(
    agent_name => 'default_agent',
    username   => 'agent_user',
    password   => '&password',
    database   => 'agent_database');

```

18.2.8 Configuring Oracle Messaging Gateway in an Oracle RAC Environment

This section contains these topics:

- [Configuring Connection Information for the MGW Agent Connections](#)
- [Setting the Oracle RAC Instance for the Messaging Gateway Agent](#)

18.2.8.1 Configuring Connection Information for the MGW Agent Connections

You must make all database connections made by the Messaging Gateway agent to the instance on which the Messaging Gateway agent process is running. This ensures correct failover behavior in an Oracle RAC environment. You can configure connections this way by having the instances use slightly different `tnsnames.ora` files. Each file contains an entry with the same net service name, but the connect data refers to only the instance associated with that `tnsnames.ora` file. The common net service name would then be used for the database parameter when `DBMS_MGWADM.ALTER_AGENT` is used to configure the Messaging Gateway agent database connection information.

For example, in a two-instance Oracle RAC environment with instances `OraDB1` and `OraDB2`, where the net service name `AGENT_DB` is to be used, the `tnsnames.ora` for instance `OraDB1` would look like this:

```

AGENT_DB =
  (DESCRIPTION =
    (ADDRESS = (PROTOCOL = TCP)(HOST = myhost1.mycorp.com)(PORT = 1521))
    (CONNECT_DATA =
      (SERVER = DEDICATED)
      (SERVICE_NAME = OraDB10.mycorp.com)
      (INSTANCE_NAME = OraDB1)
    )
  )

```

The `tnsnames.ora` for `OraDB2` would look like this:

```

AGENT_DB =
  (DESCRIPTION =
    (ADDRESS = (PROTOCOL = TCP)(HOST = myhost2.mycorp.com)(PORT = 1521))
    (CONNECT_DATA =
      (SERVER = DEDICATED)
      (SERVICE_NAME = OraDB10.mycorp.com)
      (INSTANCE_NAME = OraDB2)
    )
  )

```

```
)  
)
```

You would then configure Messaging Gateway agent user connection information by running the following command:

```
EXEC DBMS_MGWADM.ALTER_AGENT(  
  agent_name => 'default_agent',  
  username   => 'agent_user',  
  password   => 'agent_password',  
  database   => 'agent_db');
```

18.2.8.2 Setting the Oracle RAC Instance for the Messaging Gateway Agent

Messaging Gateway provides service affinity for the Messaging Gateway agent external process by leveraging the database service support of the Oracle Scheduler. By default, a Messaging Gateway agent will use the default database service that is mapped to all instances. If you want a Messaging Gateway agent to start on a select group of database instances, you must create a database service for those instances and then assign the database service to the Messaging Gateway agent using the `SERVICE` parameter of the `DBMS_MGWADM.CREATE_AGENT` or `DBMS_MGWADM.ALTER_AGENT` procedures. The `DBMS_MGWADM.STARTUP` procedure submits an Oracle Scheduler job that starts the Messaging Gateway agent external process when the Scheduler job is executed. The Scheduler job will use the database service configured for the Messaging Gateway agent.

The database service specified by the `SERVICE` parameter is only used for the service affinity of the Oracle Scheduler job and thus the service affinity for the Messaging Gateway external process. It is not used for the database connections made by the Messaging Gateway agent user. Those JDBC client connections are based on the values specified for the `DATABASE` and `CONNTYPE` parameters.



See Also:

["Running the Oracle Messaging Gateway Agent on Oracle RAC"](#)

18.3 Setting Up Non-Oracle Messaging Systems

This section contains these topics:

- [Setting Up for TIB/Rendezvous](#)
- [Setting Up for WebSphere MQ Base Java or JMS](#)

18.3.1 Setting Up for TIB/Rendezvous

Running as a TIB/Rendezvous Java client application, the Messaging Gateway agent requires TIB/Rendezvous software to be installed on the computer where the Messaging Gateway agent runs. In this section `TIBRV_HOME` refers to the installed TIB/Rendezvous software location.

Modifying listener.ora

On the Linux operating system, `LD_LIBRARY_PATH` in the entry for Messaging Gateway must include `TIBRV_HOME/lib` for the agent to access TIB/Rendezvous shared library files.



See Also:

["Modifying listener.ora for the External Procedure"](#)

On the Windows operating system, you are not required to modify `listener.ora`. But the system environment variable `PATH` must include `TIBRV_HOME\bin`.

Modifying mgw.ora

`MGW_PRE_PATH` must include the directory that contains the TIB/Rendezvous license ticket file (`tibrv.tkt`), which usually is located in `TIBRV_HOME/bin`.

`CLASSPATH` must include the TIB/Rendezvous jar file `TIBRV_HOME/lib/tibrvj.jar`. If you use your own customized TIB/Rendezvous advisory message callback, then the location of the callback class must also be included.

You can set the following Java properties to change the default setting:

- `oracle.mgw.tibrv.encoding`
- `oracle.mgw.tibrv.intraProcAdvSubjects`
- `oracle.mgw.tibrv.advMsgCallback`



See Also:

["Understanding the mgw.ora Initialization File"](#)

Example 18-6 Setting Java Properties

```
setJavaProp oracle.mgw.tibrv.encoding=ISO8859_1
setJavaProp oracle.mgw.tibrv.intraProcAdvSubjects=_RV.>
setJavaProp oracle.mgw.tibrv.advMsgCallback=MyadvCallback
```

18.3.2 Setting Up for WebSphere MQ Base Java or JMS

The WebSphere MQ client and WebSphere MQ classes for Java and JMS must be installed on the computer where the Messaging Gateway agent runs. In this section `MQ_HOME` refers to the location of the installed client. On the Linux operating system, this location is always `/opt/mqm`. On the Windows operating system, the installed location can vary.

Modifying listener.ora

No extra modification of `listener.ora` is necessary for Messaging Gateway to access WebSphere MQ.

Modifying mgw.ora

When using WebSphere MQ Base Java (non-JMS) interface, set `CLASSPATH` to include at least the following (in addition to those in "[Setting Up an mgw.ora Initialization File](#)"):

- `MQ_HOME/java/lib/com.ibm.mq.jar`
- `MQ_HOME/java/lib/connector.jar`

When using WebSphere MQ JMS interface, set `CLASSPATH` to include at least the following (in addition to those in "[Setting Up an mgw.ora Initialization File](#)"):

- `MQ_HOME/java/lib/com.ibm.mqjms.jar`
- `MQ_HOME/java/lib/com.ibm.mq.jar`
- `MQ_HOME/java/lib/connector.jar`

18.4 Verifying the Oracle Messaging Gateway Setup

The following procedure verifies the setup and includes a simple startup and shutdown of the Messaging Gateway agent:

1. Start the database listeners.

Start the listener for the external procedure and other listeners for the regular database connection.

2. Test the database connect string for the Messaging Gateway agent user.

Run `sqlplus agent_user/agent_password@agent_database`.

If it is successful, then the Messaging Gateway agent can connect to the database.

3. **Linux Operating System Only:** Test the net service entry used to call the external procedure.

Run `sqlplus agent_user/agent_password@MGW_AGENT`.

This should fail with "ORA-28547: connection to server failed, probable Oracle Net admin error". Any other error indicates that the `tnsnames.ora`, `listener.ora`, or both are not correct.

4. Connect as `admin_user` and call `DBMS_MGWADM.STARTUP` to start the Messaging Gateway agent.

5. Using the `MGW_GATEWAY` view, wait for `AGENT_STATUS` to change to `RUNNING` and `AGENT_PING` to change to `REACHABLE`.

6. Connect as `admin_user` and call `DBMS_MGWADM.SHUTDOWN` to shut down the Messaging Gateway agent.

7. Using the `MGW_GATEWAY` view, wait for `AGENT_STATUS` to change to `NOT_STARTED`.

18.5 Unloading Oracle Messaging Gateway

Use this procedure to unload Messaging Gateway:

1. Shut down Messaging Gateway.

2. Remove any user-created queues whose payload is a Messaging Gateway **canonical** type (for example, `SYS.MGW_BASIC_MSG_T`).
3. Using SQL*Plus, run `ORACLE_HOME/mgw/admin/catnomgw.sql` as user `SYS` as `SYSDBA`.
This drops the database objects used by Messaging Gateway, including roles, tables, views, packages, object types, and synonyms.
4. Remove entries for Messaging Gateway created in `listener.ora` and `tnsnames.ora`.

18.6 Understanding the mgw.ora Initialization File

Messaging Gateway reads initialization information from a text file when the Messaging Gateway agent starts. The initialization file contains lines for setting initialization parameters, environment variables, and Java properties. Each entity must be specified on one line. Leading whitespace is trimmed in all cases.

A Messaging Gateway administrator can specify the initialization file to be used for a Messaging Gateway agent via `DBMS_MGWADM.CREATE_AGENT` and `DBMS_MGWADM.ALTER_AGENT`. If an initialization file is not specified then a default initialization file will be used.

The default initialization file for the default agent is `ORACLE_HOME/mgw/admin/mgw.ora`.

The default initialization file for a named agent is `ORACLE_HOME/mgw/admin/mgw_AGENTNAME.ora` where `AGENTNAME` is the name in uppercase of the Messaging Gateway agent. For example, if the agent name is `my_agent` then the name of the agent's default initialization file is `ORACLE_HOME/mgw/admin/mgw_MY_AGENT.ora`. If the default initialization file for a named agent is not found then `ORACLE_HOME/mgw/admin/mgw.ora` will be used.

18.6.1 mgw.ora Initialization Parameters

The initialization parameters are typically specified by lines having a "`name=value<NL>`" format where `name` represents the parameter name, `value` represents its value and `<NL>` represents a new line.

log_directory

Usage:

Specifies the directory where the Messaging Gateway log/trace file is created.

Format:

```
log_directory = value
```

Default:

```
ORACLE_HOME/mgw/log
```

Example:

```
log_directory = /private/mgwlog
```

log_level

Usage:

Specifies the level of logging detail recorded by the Messaging Gateway agent. The logging level can be dynamically changed by calling `DBMS_MGWADM.SET_LOG_LEVEL` while the Messaging Gateway agent is running. Oracle recommends that log level 0 (the default value) be used at all times.

Format:

```
log_level = value
```

Values:

- 0 for basic logging; equivalent to `DBMS_MGWADM.BASIC_LOGGING`
- 1 for light tracing; equivalent to `DBMS_MGWADM.TRACE_LITE_LOGGING`
- 2 for high tracing; equivalent to `DBMS_MGWADM.TRACE_HIGH_LOGGING`
- 3 for debug tracing; equivalent to `DBMS_MGWADM.TRACE_DEBUG_LOGGING`
- 4 for high debug tracing; equivalent to `DBMS_MGWADM.TRACE_DEBUG_HIGH_LOGGING`

Example:

```
log_level = 0
```

18.6.2 mgw.ora Environment Variables

Because the Messaging Gateway process environment is not under the direct control of the user, certain environment variables should be set using the initialization file. The environment variables currently used by the Messaging Gateway agent are `CLASSPATH`, `MGW_PRE_PATH`, and `ORACLE_SID`.

Environment variables such as `CLASSPATH` and `MGW_PRE_PATH` are set so the Messaging Gateway agent can find the required shared objects, Java classes, and so on. Environment variables are specified by lines having a `"set env_var=value<NL>"` or `"setenv env_var=value<NL>"` format where `env_var` represents the name of the environment variable to set, `value` represents the value of the environment variable, and `<NL>` represents a new line.

CLASSPATH

Usage:

Used by the [Java Virtual Machine](#) to find Java classes needed by the Messaging Gateway agent for [propagation](#) between Oracle Database Advanced Queuing and non-Oracle messaging systems.

Format:

```
set CLASSPATH=value
```

Example:

```
set CLASSPATH=ORACLE_HOME/jdbc/lib/ojdbc6.jar:JRE_HOME/lib/rt.jar:  
ORACLE_HOME/sqlj/lib/runtime12.jar:ORACLE_HOME/jlib/orai18n.jar:ORACLE_HOME/rdbms/  
jlib/jmscommon.jar:ORACLE_HOME/rdbms/jlib/aqapi.jar:ORACLE_HOME/jlib/jta.jar:  
/opt/mqm/java/lib/com.ibm.mq.jar:/opt/mqm/java/lib/com.ibm.mqjms.jar:/opt/mqm/java  
/lib/connector.jar
```

MGW_PRE_PATH

Usage:

Appended to the front of the path inherited by the Messaging Gateway process. For the Windows operating system, this variable must be set to indicate where the library `jvm.dll` is found.

Format:

```
set MGW_PRE_PATH=value
```

Example:

```
set MGW_PRE_PATH=JRE_HOME\bin\client
```

ORACLE_SID

Usage:

Can be used when a service name is not specified when configuring Messaging Gateway.

Format:

```
set ORACLE_SID=value
```

Example:

```
set ORACLE_SID=my_sid
```

18.6.3 mgw.ora Java Properties

You must specify Java system properties for the Messaging Gateway JVM when working with TIB/Rendezvous subjects. You can use the `setJavaProp` parameter of the Messaging Gateway initialization file for this. Java properties are specified by lines having a `"setJavaProp prop_name=value<NL>"` format, where `prop_name` represents the name of the Java property to set, `value` represents the value of the Java property, and `<NL>` represents a new line character.

oracle.mgw.batch_size

Usage:

This Java property represents the maximum number of messages propagated in one transaction. It serves as a default value if the Messaging Gateway job option, `MsgBatchSize`, is not specified. If altered from the default, then consideration should be given to the expected [message](#) size and the Messaging Gateway agent memory (see

`max_memory` parameter of `DBMS_MGWADM.ALTER_AGENT`). The minimum value of this Java property is 1, the maximum is 100, and the default is 30.

**See Also:**

"DBMS_MGWADM" in *Oracle Database PL/SQL Packages and Types Reference*

Syntax:

```
setJavaProp oracle.mgw.batch_size=value
```

Example:

```
setJavaProp oracle.mgw.batch_size=10
```

oracle.mgw.polling_interval**Usage:**

This parameter specifies the time (in milliseconds) that must elapse between polls for available messages of a propagation source [queue](#). The default polling interval used by Messaging Gateway is 5000 milliseconds (5 seconds). The minimum value of this Java property is 100 millisecond, and the maximum value is 60 seconds.

Syntax:

```
setJavaProp oracle.mgw.polling_interval=value
```

Example:

```
setJavaProp oracle.mgw.polling_interval=1000
```

oracle.mgw.tibrv.encoding**Usage:**

This parameter specifies the character encoding to be used by the TIB/Rendezvous messaging system links. Only one character set for all configured TIB/Rendezvous links is allowed due to TIB/Rendezvous restrictions. The default is ISO 8859-1 or the character set specified by the Java system property `file.encoding`.

Syntax:

```
setJavaProp oracle.mgw.tibrv.encoding=value
```

Example:

```
setJavaProp oracle.mgw.tibrv.encoding=ISO8859_1
```

oracle.mgw.tibrv.intraProcAdvSubjects**Usage**

Used for all TIB/Rendezvous messaging system links, this parameter specifies the names of system advisory subjects that present on the intraprocess transport.

Syntax

```
setJavaProp oracle.mgw.tibrv.intraProcAdvSubjects=  
advisorySubjectName[:advisorySubjectName]
```

Example:

```
setJavaProp oracle.mgw.tibrv.intraProcAdvSubjects=_RV.>
```

oracle.mgw.tibrv.advMsgCallback

Usage:

Used for all TIB/Rendezvous messaging system links, this parameter specifies the name of the Java class that implements the `TibrvMsgCallback` interface to handle system advisory messages. If it is not specified, then the default system advisory message handler provided by Messaging Gateway is used, which writes system advisory messages into Messaging Gateway log files. If it is specified, then the directory where the class file is stored must be included in the `CLASSPATH` in `mgw.ora`.

Syntax:

```
setJavaProp oracle.mgw.tibrv.advMsgCallback=className
```

Example:

```
setJavaProp oracle.mgw.tibrv.advMsgCallback=MyAdvCallback
```

oracle.net.tns_admin

Usage:

This parameter specifies the directory of the `tnsnames.ora` file. It must be set if the Messaging Gateway agent is configured to use the JDBC Thin driver and the database specifier of the agent connection information is a TNSNames alias. This does not need to be set if the JDBC OCI driver is used or the database specifier is something other than a TNSNames alias.

Syntax:

```
setJavaProp oracle.net.tns_admin=value
```

Example:

```
setJavaProp oracle.net.tns_admin=/myoraclehome/network/admin
```

18.6.4 mgw.ora Comment Lines

Comment lines are designated with a # character as the first character of the line.

19

Working with Oracle Messaging Gateway

After Oracle Messaging Gateway (MGW) is loaded and set up, it is ready to be configured and run. You can use `DBMS_MGWADM.ALTER_AGENT` to set the user name, password, database specifier, and connection type the Messaging Gateway agent will use for creating database connections.

Topics:

- [Configuring the Oracle Messaging Gateway Agent](#)
- [Starting and Shutting Down the Oracle Messaging Gateway Agent](#)
- [Configuring Messaging System Links](#)
- [Configuring Non-Oracle Messaging System Queues](#)
- [Configuring Oracle Messaging Gateway Propagation Jobs](#)
- [Propagation Jobs_ Subscribers_ and Schedules](#)
- [Configuration Properties](#)



Note:

All commands in the examples must be run as a user granted `MGW_ADMINISTRATOR_ROLE`.



See Also:

"`DBMS_MGWADM`" and "`DBMS_MGWMSG`" in *Oracle Database PL/SQL Packages and Types Reference*

19.1 Configuring the Oracle Messaging Gateway Agent

Messages are propagated between Oracle Database Advanced Queuing and non-Oracle messaging systems by the Messaging Gateway agent. The Messaging Gateway agent runs as an external process of the Oracle Database server.

Messaging Gateway supports multiple agents for a given database. A default agent is automatically created that has the name of `DEFAULT_AGENT`. Additional named agents can be created to provide propagation job isolation and grouping, and scaling in an Oracle RAC environment. The default agent is usually sufficient for single instance, non-Oracle RAC, environments.

This section contains these topics:

- [Creating a Messaging Gateway Agent](#)

- [Removing a Messaging Gateway Agent](#)
- [Setting Database Connection](#)
- [Setting the Resource Limits](#)

19.1.1 Creating a Messaging Gateway Agent

You can use `DBMS_MGWADM.CREATE_AGENT` to create additional Messaging Gateway agents. The Messaging Gateway default agent, `DEFAULT_AGENT`, is automatically created when Messaging Gateway is installed and will always exist.

Agents can be configured with an agent user, connection information, database service, and resource limits when the agent is created, or at a later time using `DBMS_MGWADM.ALTER_AGENT`. A Messaging Gateway agent must be configured with a database user that has been granted the role `MGW_AGENT_ROLE` before the agent can be started.

[Example 19-1](#) creates the agent named `myagent` and specifies the database connection information for the agent user. Default values are used for all other parameters.

Example 19-1 Creating a Messaging Gateway Agent

```
SQL> exec DBMS_MGWADM.CREATE_AGENT(  
        agent_name => 'myagent',  
        username   => 'mgwagent',  
        password   => 'mgwagent_password',  
        database   => 'mydatabase');
```

19.1.2 Removing a Messaging Gateway Agent

A Messaging Gateway agent can be removed by calling `DBMS_MGWADM.REMOVE_AGENT`. Before an agent can be removed, all Messaging Gateway links associated with the agent must be removed and the agent shut down. The default agent, `DEFAULT_AGENT`, cannot be removed. [Example 19-2](#) removes the agent named `myagent`.

Example 19-2 Removing a Messaging Gateway Agent

```
SQL> exec DBMS_MGWADM.REMOVE_AGENT(agent_name => 'myagent');
```

19.1.3 Setting Database Connection

The Messaging Gateway agent runs as a process external to the database. To access Oracle Database Advanced Queuing and the Messaging Gateway packages, the Messaging Gateway agent needs to establish connections to the database. You can use `DBMS_MGWADM.ALTER_AGENT` to set the user name, password and the database connect string that the Messaging Gateway agent will use for creating database connections. The user must be granted the role `MGW_AGENT_ROLE` before the Messaging Gateway agent can be started.

[Example 19-3](#) shows the Messaging Gateway default agent being configured for user `mgwagent` with password `mgwagent_password` using net service name `mydatabase`.

Example 19-3 Setting Database Connection Information

```
SQL> exec DBMS_MGWADM.ALTER_AGENT (  
        agent_name => 'default_agent',  
        username   => 'mgwagent',
```

```
password => 'mgwagent_password',  
database => 'mydatabase');
```

19.1.4 Setting the Resource Limits

You can use `DBMS_MGWADM.ALTER_AGENT` to set resource limits for the Messaging Gateway agent. For example, you can set the heap size of the Messaging Gateway agent process and the number of propagation threads used by the agent process. The default values are 64 MB of memory heap and one propagation thread. For named agents, these values can also be specified when the agent is created by `DBMS_MGWADM.CREATE_AGENT`.

[Example 19-4](#) sets the heap size to 96 MB and two propagation threads for the agent `myagent`.

The memory heap size and the number of propagation threads cannot be altered when the Messaging Gateway agent is running.

Example 19-4 Setting the Resource Limits

```
SQL> exec DBMS_MGWADM.ALTER_AGENT(  
          agent_name => 'myagent',  
          max_memory => 96,  
          max_threads => 2);
```

19.2 Starting and Shutting Down the Oracle Messaging Gateway Agent

This section contains these topics:

- [Starting the Oracle Messaging Gateway Agent](#)
- [Shutting Down the Oracle Messaging Gateway Agent](#)
- [Oracle Messaging Gateway Agent Scheduler Job](#)
- [Running the Oracle Messaging Gateway Agent on Oracle RAC](#)

19.2.1 Starting the Oracle Messaging Gateway Agent

After the Messaging Gateway agent is configured, you can start the agent with `DBMS_MGWADM.STARTUP`. [Example 19-5](#) shows how to start the default agent and agent `myagent`.

You can use the `MGW_GATEWAY` view to check the status of the Messaging Gateway agent, as described in [Monitoring Oracle Messaging Gateway](#).

Example 19-5 Starting the Messaging Gateway Agent

```
SQL> exec DBMS_MGWADM.STARTUP;  
SQL> exec DBMS_MGWADM.STARTUP ('myagent');
```

19.2.2 Shutting Down the Oracle Messaging Gateway Agent

You can use `DBMS_MGWADM.SHUTDOWN` to shut down the Messaging Gateway agent. [Example 19-6](#) shows how to shut down the Messaging Gateway default agent and agent `myagent`.

You can use the `MGW_GATEWAY` view to check if the Messaging Gateway agent has shut down successfully, as described in [Monitoring Oracle Messaging Gateway](#).

Example 19-6 Shutting Down the Messaging Gateway Agent

```
SQL> exec DBMS_MGWADM.SHUTDOWN;  
SQL> exec DBMS_MGWADM.SHUTDOWN ('myagent');
```

19.2.3 Oracle Messaging Gateway Agent Scheduler Job

Messaging Gateway uses a Scheduler job to start the Messaging Gateway agent. This job is created when procedure `DBMS_MGWADM.STARTUP` is called. When the job is run, it calls an external procedure that creates the Messaging Gateway agent in an external process. The job is removed after:

- The agent shuts down because `DBMS_MGWADM.SHUTDOWN` was called
- The agent terminates because a non-restartable error occurs

Messaging Gateway uses `DBMS_SCHEDULER` to create a repeatable Scheduler job with a repeat interval of one minute. The job is owned by `SYS`. A repeatable job enables the Messaging Gateway agent to restart automatically when a given job instance ends because of a database shutdown, database malfunction, or a restartable error. Only one instance of a Messaging Gateway agent job runs at a given time.

Each agent uses a Scheduler job class to specify the service affinity for the agent's Scheduler job. The job class will be configured with the database service specified by `DBMS_MGWADM.CREATE_AGENT` or `DBMS_MGWADM.ALTER_AGENT`. A database administrator is responsible for setting up the database service. If no database service is specified, the default database service that maps to every instance is used.

The name of the Scheduler job class used by the Messaging Gateway default agent is `SYS.MGW_JOBCLS_DEFAULT_AGENT`. The Scheduler job used by the default agent is `SYS.MGW_JOB_DEFAULT_AGENT`.

The name of the Scheduler job class used by a Messaging Gateway named agent is `SYS.MGW_JOBCLS_<agent_name>`. The Scheduler job used by a named agent is `SYS.MGW_JOB_<agent_name>`.

If the agent job encounters an error, then the error is classified as either a restartable error or non-restartable error. A restartable error indicates a problem that might go away if the agent job were to be restarted. A non-restartable error indicates a problem that is likely to persist and be encountered again if the agent job restarts. `ORA-01089` (immediate shutdown in progress) and `ORA-28576` (lost RPC connection to external procedure) are examples of restartable errors. `ORA-06520` (error loading external library) is an example of a non-restartable error.

Messaging Gateway uses a database shutdown trigger. If the Messaging Gateway agent is running on the instance being shut down, then the trigger notifies the agent of the shutdown, and upon receipt of the notification, the agent will terminate the current run. The job scheduler will automatically schedule the job to run again at a future time.

If a Messaging Gateway agent job instance ends because of a database malfunction or a restartable error detected by the agent job, then the job will not be removed and the job scheduler will automatically schedule the job to run again at a future time.

The `MGW_GATEWAY` view shows the agent status, database service, and the database instance on which the Messaging Gateway agent is current running. The Oracle

Scheduler views provide information about Scheduler jobs, job classes, and job run details.

 **See Also:**

- "DBMS_SCHEDULER" in *Oracle Database PL/SQL Packages and Types Reference*
- [Monitoring Oracle Messaging Gateway](#)

19.2.4 Running the Oracle Messaging Gateway Agent on Oracle RAC

While the Messaging Gateway job startup and shutdown principles are the same for Oracle Real Application Clusters (Oracle RAC) and non-Oracle RAC environments, there are some things to keep in mind for an Oracle RAC environment.

A single process of each configured Messaging Gateway agent can be running, even in an Oracle RAC environment. For example, if the default agent and two named agents have been configured with an agent user, then one instance of all three agents could be running at the same time. The database service associated with each agent determines the service affinity of the agent's Scheduler job, and thus, the database instance on which the agent process can run.

When a database instance is shut down in an Oracle RAC environment, the Messaging Gateway shutdown trigger will notify the agent to shut down only if the Messaging Gateway agent is running on the instance being shut down. The job scheduler will automatically schedule the job to be run again at a future time, either on another instance, or if the job can only run on the instance being shut down, when that instance is restarted.

Oracle recommends that all database connections made by the Messaging Gateway agent be made to the instance on which the Messaging Gateway agent process is running. This ensures correct failover behavior in an Oracle RAC environment.

If a Messaging Gateway agent has been associated with a database service, the agent's Scheduler job will not run unless that service is current enabled on a running instance. When you shut down a database Oracle stops all services to that database and you may need to manually restart the services when you start the database.

 **See Also:**

- "[Configuring Oracle Messaging Gateway in an Oracle RAC Environment](#)"
- "DBMS_MGWADM" and "DBMS_SCHEDULER" in *Oracle Database PL/SQL Packages and Types Reference*

19.3 Configuring Messaging System Links

Running as a client of non-Oracle messaging systems, the Messaging Gateway agent communicates with non-Oracle messaging systems through messaging system links.

A messaging system link is a set of connections between the Messaging Gateway agent and a non-Oracle messaging system.

To configure a messaging system link of a non-Oracle messaging system, users must provide information for the agent to make connections to the non-Oracle messaging system. Users can specify the maximum number of messaging connections.

An agent name will be associated with each messaging system link. This is done when the link is created and cannot be changed. The agent associated with the link is then responsible for processing all propagation jobs that use a registered queue associated with that link. The Messaging Gateway default agent will be used if an agent name is not specified when the messaging system link is created.

When configuring a messaging system link for a non-Oracle messaging system that supports transactions and persistent messages, the native name of log queues for inbound and outbound propagation must be specified in order to guarantee exactly-once [message](#) delivery. The log queues should be used only by the Messaging Gateway agent. No other programs should [enqueue](#) or [dequeue](#) messages of the log queues. The inbound log queue and outbound log queue can refer to the same physical queue, but better performance can be achieved if they refer to different physical queues.

One and only one Messaging Gateway agent should access a propagation log queue. This insures that a given log queue contains log records for only those propagation jobs processed by that agent and that the agent is free to discard any other log records it might encounter.

When configuring a messaging system link, users can also specify an `options` argument. An `options` argument is a set of {name, value} pairs of type `SYS.MGW_PROPERTY`.

This section contains these topics:

- [Creating a WebSphere MQ Base Java Link](#)
- [Creating a WebSphere MQ JMS Link](#)
- [Creating a WebSphere MQ Link to Use SSL](#)
- [Creating a TIB/Rendezvous Link](#)
- [Altering a Messaging System Link](#)
- [Removing a Messaging System Link](#)
- [Views for Messaging System Links](#)

19.3.1 Creating a WebSphere MQ Base Java Link

A WebSphere MQ Base Java link is created by calling `DBMS_MGWADM.CREATE_MSGSYSTEM_LINK` with the following information provided:

- Interface type: `DBMS_MGWADM.MQSERIES_BASE_JAVA_INTERFACE`
- WebSphere MQ connection information:
 - Host name and port number of the WebSphere MQ server
 - Queue manager name
 - Channel name
 - User name and password

- Maximum number of messaging connections allowed
- Log queue names for inbound and outbound propagation
- Optional information such as:
 - Send, receive, and security exits
 - Character sets

Example 19-7 configures a WebSphere MQ Base Java link `mqlink`. The link is configured to use the WebSphere MQ queue manager `my.queue.manager` on host `myhost.mydomain` and port 1414, using WebSphere MQ channel `mychannel`.

This example also sets the option to register a WebSphere MQ `SendExit` class. The class `mySendExit` must be in the `CLASSPATH` set in `mgw.ora`. The Messaging Gateway default agent (`DEFAULT_AGENT`) is responsible for the link and all propagation jobs using the link.

See Also:

- ["Understanding the mgw.ora Initialization File"](#) for information on setting the `CLASSPATH` of the Messaging Gateway agent
- ["WebSphere MQ System Properties"](#)

Example 19-7 Configuring a WebSphere MQ Base Java Link

```
DECLARE
  v_options sys.mgw_properties;
  v_prop sys.mgw_mqseries_properties;
BEGIN
  v_prop := sys.mgw_mqseries_properties.construct();

  v_prop.interface_type := dbms_mgwadm.MQSERIES_BASE_JAVA_INTERFACE;
  v_prop.max_connections := 1;
  v_prop.username := 'mqm';
  v_prop.password := 'mqm';
  v_prop.hostname := 'myhost.mydomain';
  v_prop.port := 1414;
  v_prop.channel := 'mychannel';
  v_prop.queue_manager := 'my.queue.manager';
  v_prop.outbound_log_queue := 'mylogq';

  -- Specify a WebSphere MQ send exit class 'mySendExit' to be associated with
  -- the queue.
  -- Note that this is used as an example of how to use the options parameter,
  -- but is not an option that is usually set.
  v_options := sys.mgw_properties(sys.mgw_property('MQ_SendExit',
                                                    'mySendExit'));

  dbms_mgwadm.create_msgsystem_link(
    linkname => 'mqlink', agent_name=>'default_agent', properties => v_prop,
    options => v_options );
END;
```

19.3.2 Creating a WebSphere MQ JMS Link

A WebSphere MQ JMS link is created by calling `DBMS_MGWADM.CREATE_MSGSYSTEM_LINK` with the following information provided:

- Interface type

Java Message Service (JMS) distinguishes between queue and topic connections. The Sun Microsystems JMS 1.1 standard supports domain unification that allows both JMS queues and topics to be accessed by a single JMS connection:

 - A WebSphere MQ JMS link created with interface type `DBMS_MGWADM.JMS_CONNECTION` can be used to access both JMS queues and topics. This is the recommended interface for a WebSphere MQ JMS link.
 - A WebSphere MQ JMS link created with interface type `DBMS_MGWADM.JMS_QUEUE_CONNECTION` can be used to access only JMS queues.
 - A WebSphere MQ JMS link created with interface type `DBMS_MGWADM.JMS_TOPIC_CONNECTION` can be used to access only JMS topics.
- WebSphere MQ connection information:
 - Host name and port number of the WebSphere MQ server
 - Queue manager name
 - Channel name
 - User name and password
- Maximum number of messaging connections allowed

A messaging connection is mapped to a **JMS session**.
- Log destination (JMS queue or **JMS topic**) for inbound and outbound propagation

The log destination type must be valid for the link type. JMS unified links and JMS queue links must use JMS queues for log destinations, and JMS topic links must use topics:

 - For a WebSphere MQ JMS unified or queue link, the log queue name must be the name of a physical WebSphere MQ JMS queue created using WebSphere MQ administration tools.
 - For a WebSphere MQ JMS topic link, the log topic name must be the name of a WebSphere MQ JMS topic. The physical WebSphere MQ queue used by that topic must be created using WebSphere MQ administration tools. By default, the physical queue used is `SYSTEM.JMS.D.SUBSCRIBER.QUEUE`. A link option can be used to specify a different physical queue.
- Optional information such as:
 - Send, receive, and security exits
 - Character sets
 - WebSphere MQ **publish/subscribe** configuration used for JMS topics

Example 19-8 configures a Messaging Gateway link to a WebSphere MQ queue manager using a JMS topic interface. The link is named `mqjmslink` and is configured to use the WebSphere MQ queue manager `my.queue.manager` on host `myhost.mydomain` and port 1414, using WebSphere MQ channel `mychannel`.

This example also uses the `options` parameter to specify a nondefault durable subscriber queue to be used with the log topic. The Messaging Gateway agent `myagent` is responsible for the link and all propagation jobs using the link.

See Also:

- ["Registering a WebSphere MQ JMS Queue or Topic"](#) for more information on JMS queues and topics
- ["WebSphere MQ System Properties"](#)

Example 19-8 Configuring a WebSphere MQ JMS Link

```
DECLARE
  v_options sys.mgw_properties;
  v_prop sys.mgw_mqseries_properties;
BEGIN
  v_prop := sys.mgw_mqseries_properties.construct();
  v_prop.max_connections := 1;

  v_prop.interface_type := DBMS_MGWADM.JMS_TOPIC_CONNECTION;
  v_prop.username := 'mqm';
  v_prop.password := 'mqm';
  v_prop.hostname := 'myhost.mydomain';
  v_prop.port := 1414;
  v_prop.channel := 'mychannel';
  v_prop.queue_manager := 'my.queue.manager';

  v_prop.outbound_log_queue := 'mylogtopic'

  -- Specify a WebSphere MQ durable subscriber queue to be used with the
  -- log topic.
  v_options := sys.mgw_properties(
    sys.mgw_property('MQ_JMSDurSubQueue', 'myDSQueue'));

  DBMS_MGWADM.CREATE_MSGSYSTEM_LINK(
    linkname => 'mqjmslink',
    agent_name => 'myagent',
    properties => v_prop,
    options => v_options );
END;
```

19.3.3 Creating a WebSphere MQ Link to Use SSL

Messaging Gateway allows SSL support for IBM WebSphere MQ and WebSphere MQ JMS connections. This section describes how to configure Messaging Gateway to use SSL for a WebSphere MQ Base Java link and the same information applies to a WebSphere MQ JMS link. There are no differences in terms of the Messaging Gateway configuration.

The following are needed in order to use SSL for WebSphere MQ connections:

- A WebSphere MQ channel configured to use SSL.
- A truststore and optionally a keystore file that are in a location accessible to the Messaging Gateway agent process. In an Oracle RAC environment, these files

must be accessible to all instances on which the Messaging Gateway agent process might run, using the same path specification.

- Use `DBMS_MGWADM.CREATE_MSGSYSTEM_LINK` to create a WebSphere MQ link with the desired SSL related link options. At minimum, the `MQ_SSLCIPHERSUITE` property should be set to specify the SSL ciphersuite used by the channel.
- Use `DBMS_MGWADM.SET_OPTION` to set certain JSSE Java properties for the Messaging Gateway agent assigned to the link.

JSEE related properties:

- `java.net.ssl.keyStore`
This property is used to specify the location of the keystore. A keystore is a database of key material used for various purposes, including authentication and data integrity.
- `java.net.ssl.keyStorePassword`
This property is used to specify the password of the keystore. This password is used to check the integrity of the data in the keystore before accessing it.
- `java.net.ssl.trustStore`
This property is used to specify the location of the truststore. A truststore is a keystore that is used when making decisions about which clients and servers are trusted.
- `java.net.ssl.trustStorePassword`
This property is used to specify the password of the truststore. This password is used to check the integrity of the data in the truststore before accessing it.

The `java.net.ssl.keyStore` and `java.net.ssl.keyStorePassword` properties are only needed if the WebSphere MQ channel is configured to use SSL client authentication.

[Example 19-9](#) configures a WebSphere MQ Base Java link `mqssl` to use SSL connections using the `SSL_RSA_WITH_RC4_128_MD5` ciphersuite. It assumes the channel has been configured for SSL client authentication so the Messaging Gateway agent associated with the link, `DEFAULT_AGENT`, is configured with Java properties for both a keystore and a truststore.

This configuration should be done when the Messaging Gateway agent is shut down since the Java properties set by `DBMS_MGWADM.SET_OPTION` are set only when the agent first starts. If the agent is running when the configuration is done it will need to be shutdown and restarted before the SSL connections will be used.



Note:

"WebSphere MQ System Properties"

Example 19-9 Configuring a WebSphere MQ Base Java Link for SSL

```
DECLARE
  v_options sys.mgw_properties;
  v_prop sys.mgw_mqseries_properties;
  v_agent varchar2(30) := 'default_agent';
BEGIN
  v_prop := sys.mgw_mqseries_properties.construct();
```

```

v_prop.interface_type := DBMS_MGWADM.MQSERIES_BASE_JAVA_INTERFACE;
v_prop.max_connections := 1;
v_prop.username := 'mqm';
v_prop.password := 'mqm';
v_prop.hostname := 'myhost.mydomain';
v_prop.port := 1414;
v_prop.channel := 'mysslchannel';
v_prop.queue_manager := 'my.queue.manager';
v_prop.outbound_log_queue := 'mylogq';

-- specify the SSL ciphersuite
v_options := sys.mgw_properties(
    sys.mgw_property('MQ_SSLCIPHERSUITE', 'SSL_RSA_WITH_RC4_128_MD5') );

-- create the MQSeries link
DBMS_MGWADM.CREATE_MSGSYSTEM_LINK(linkname => 'mqssllink',
    agent_name => v_agent,
    properties => v_prop,
    options => v_options);

-- set Java properties for the agent that specify the JSSE security
-- properties for the keystore and truststore; the paths will be
-- saved as cleartext and the passwords encrypted

DBMS_MGWADM.SET_OPTION(target_type => DBMS_MGWADM.AGENT_JAVA_PROP,
    target_name => v_agent,
    option_name => 'javax.net.ssl.keyStore',
    option_value => '/tmp/mq_ssl/key.jks',
    encrypted => false);

DBMS_MGWADM.SET_OPTION(target_type => DBMS_MGWADM.AGENT_JAVA_PROP,
    target_name => v_agent,
    option_name => 'javax.net.ssl.keyStorePassword',
    option_value => 'welcome',
    encrypted => true);

DBMS_MGWADM.SET_OPTION(target_type => DBMS_MGWADM.AGENT_JAVA_PROP,
    target_name => v_agent,
    option_name => 'javax.net.ssl.trustStore',
    option_value => '/tmp/mq_ssl/trust.jks',
    encrypted => false);

DBMS_MGWADM.SET_OPTION(target_type => DBMS_MGWADM.AGENT_JAVA_PROP,
    target_name => v_agent,
    option_name => 'javax.net.ssl.trustStorePassword',
    option_value => 'welcome',
    encrypted => true);

END;
```

19.3.4 Creating a TIB/Rendezvous Link

A TIB/Rendezvous link is created by calling `DBMS_MGWADM.CREATE_MSGSYSTEM_LINK` with three parameters (`service`, `network` and `daemon`) for the agent to create a corresponding transport of `TibrvRvdTransport` type.

A TIB/Rendezvous message system link does not need propagation log queues. Logging information is stored in memory. Therefore, Messaging Gateway can only guarantee at-most-once message delivery.

Example 19-10 configures a TIB/Rendezvous link named `rvlink` that connects to the `rvd` daemon on the local computer. An agent name is not specified for the link so the Messaging Gateway default agent (`DEFAULT_AGENT`) is responsible for the link and all propagation jobs using the link.

**See Also:**

["TIB/Rendezvous System Properties"](#)

Example 19-10 Configuring a TIB/Rendezvous Link

```
DECLARE
  v_options sys.mgw_properties;
  v_prop     sys.mgw_tibrv_properties;
BEGIN
  v_prop := sys.mgw_tibrv_properties.construct();

  DBMS_MGWADM.CREATE_MSGSYSTEM_LINK(linkname => 'rvlink', properties => v_prop);
END;
```

19.3.5 Altering a Messaging System Link

Using `DBMS_MGWADM.ALTER_MSGSYSTEM_LINK`, you can alter some link information after the link is created. You can alter link information with the Messaging Gateway agent running or shut down. **Example 19-11** alters the link `mqlink` to change the `max_connections` property.

**See Also:**

["Configuration Properties"](#) for restrictions on changes when the Messaging Gateway agent is running

Example 19-11 Altering a WebSphere MQ Link

```
DECLARE
  v_options sys.mgw_properties;
  v_prop     sys.mgw_mqseries_properties;
BEGIN
  -- use alter_construct() for initialization
  v_prop := sys.mgw_mqseries_properties.alter_construct();
  v_prop.max_connections := 2;

  DBMS_MGWADM.ALTER_MSGSYSTEM_LINK(
    linkname => 'mqlink', properties => v_prop);
END;
```

19.3.6 Removing a Messaging System Link

You can remove a Messaging Gateway link to a non-Oracle messaging system with `DBMS_MGWADM.REMOVE_MSGSYSTEM_LINK`, but only if all registered queues associated with

this link have already been unregistered. The link can be removed with the Messaging Gateway agent running or shut down. [Example 19-12](#) removes the link `mqlink`.

Example 19-12 Removing a Messaging Gateway Link

```
BEGIN
  dbms_mgwadm.remove_msgsystem_link(linkname =>'mqlink');
END;
```

19.3.7 Views for Messaging System Links

You can use the `MGW_LINKS` view to check links that have been created. It lists the name and link type, as shown in [Example 19-13](#).

You can use the `MGW_MQSERIES_LINKS` and `MGW_TIBRV_LINKS` views to check messaging system type-specific configuration information, as shown in [Example 19-14](#).

Example 19-13 Listing All Messaging Gateway Links

```
SQL> select link_name, link_type from MGW_LINKS;
```

LINK_NAME	LINK_TYPE
MQLINK	MQSERIES
RVLINK	TIBRV

Example 19-14 Checking Messaging System Link Configuration Information

```
SQL> select link_name, queue_manager, channel, hostname from mgw_mqseries_links;
```

LINK_NAME	QUEUE_MANAGER	CHANNEL	HOSTNAME
MQLINK	my.queue.manager	mychannel	myhost.mydomain

```
SQL> select link_name, service, network, daemon from mgw_tibrv_links;
```

LINK_NAME	SERVICE	NETWORK	DAEMON
RVLINK			

19.4 Configuring Non-Oracle Messaging System Queues

All non-Oracle messaging system queues involved in propagation as a source queue, destination queue, or [exception queue](#) must be registered through the Messaging Gateway administration interface. You do not need to register Oracle Database Advanced Queuing queues involved in propagation.

This section contains these topics:

- [Registering a Non-Oracle Queue](#)
- [Unregistering a Non-Oracle Queue](#)
- [View for Registered Non-Oracle Queues](#)

19.4.1 Registering a Non-Oracle Queue

You can register a non-Oracle queue using `DBMS_MGWADM.REGISTER_FOREIGN_QUEUE`. Registering a non-Oracle queue provides information for the Messaging Gateway

agent to access the queue. However, it does not create the physical queue in the non-Oracle messaging system. The physical queue must be created using the non-Oracle messaging system administration interfaces before the Messaging Gateway agent accesses the queue.

The following information is used to register a non-Oracle queue:

- Name of the messaging system link used to access the queue
 - Native name of the queue (its name in the non-Oracle messaging system)
 - Domain of the queue
 - `DBMS_MGWADM.DOMAIN_QUEUE` for a point-to-point queue
 - `DBMS_MGWADM.DOMAIN_TOPIC` for a publish/subscribe queue
 - Options specific to the non-Oracle messaging system
- These options are a set of {name, value} pairs, both of which are strings.



See Also:

"Optional Foreign Queue Configuration Properties"

Example 19-15 shows how to register the WebSphere MQ Base Java queue `my_mq_queue` as a Messaging Gateway queue `destq`.

Example 19-15 Registering a WebSphere MQ Base Java Queue

```
BEGIN
  DBMS_MGWADM.REGISTER_FOREIGN_QUEUE(
    name           => 'destq',
    linkname       => 'mqlink',
    provider_queue => 'my_mq_queue',
    domain         => dbms_mgwadm.DOMAIN_QUEUE);
END;
```

19.4.1.1 Registering a WebSphere MQ Base Java Queue

The domain must be `DBMS_MGWADM.DOMAIN_QUEUE` or `NULL`, because only point-to-point queues are supported for WebSphere MQ.

19.4.1.2 Registering a WebSphere MQ JMS Queue or Topic

When registering a WebSphere MQ JMS queue, the domain must be `DBMS_MGWADM.DOMAIN_QUEUE`, and the `linkname` parameter must refer to a WebSphere MQ JMS unified link or queue link.

When registering a WebSphere MQ JMS topic, the domain must be `DBMS_MGWADM.DOMAIN_TOPIC`, and the `linkname` parameter must refer to a WebSphere MQ JMS unified link or topic link. The `provider_queue` for a WebSphere MQ JMS topic used as a propagation source may include wildcards. See WebSphere MQ documentation for [wildcard](#) syntax.

19.4.1.3 Registering a TIB/Rendezvous Subject

When registering a TIB/Rendezvous subject with Messaging Gateway, the `provider_queue` parameter specifies a TIB/Rendezvous subject name. The domain of a registered TIB/Rendezvous queue must be `DBMS_MGWADM.DOMAIN_TOPIC` or `NULL`.

A registered TIB/Rendezvous queue with `provider_queue` set to a wildcard subject name can be used as a propagation source queue for inbound propagation. It is not recommended to use queues with wildcard subject names as propagation destination queues or exception queues. As documented in TIB/Rendezvous, sending messages to wildcard subjects can trigger unexpected behavior. However, neither Messaging Gateway nor TIB/Rendezvous prevents you from doing so.

19.4.2 Unregistering a Non-Oracle Queue

A non-Oracle queue can be unregistered with `DBMS_MGWADM.UNREGISTER_FOREIGN_QUEUE`, but only if there are no propagation jobs referencing it.

Example 19-16 unregisters the queue `destq` of the link `mqlink`.

Example 19-16 Unregistering a Non-Oracle Queue

```
BEGIN
  DBMS_MGWADM.UNREGISTER_FOREIGN_QUEUE(name =>'destq', linkname=>'mqlink');
END;
```

19.4.3 View for Registered Non-Oracle Queues

You can use the `MGW_FOREIGN_QUEUES` view to check which non-Oracle queues are registered and what link each uses, as shown in [Example 19-17](#).

Example 19-17 Checking Which Queues Are Registered

```
SELECT name, link_name, provider_queue FROM MGW_FOREIGN_QUEUES;
```

NAME	LINK_NAME	PROVIDER_QUEUE
DESTQ	MQLINK	my_mq_queue

19.5 Configuring Oracle Messaging Gateway Propagation Jobs

Propagating messages between an Oracle Database AQ queue and a non-Oracle messaging system queue requires a propagation job. Each propagation job will have a unique propagation type, source, and destination triplet.

You can create a propagation job to propagate messages between JMS destinations. You can also create a propagation job to propagate messages between non-JMS queues. Messaging Gateway does not support message propagation between a JMS destination and a non-JMS queue.

This section contains these topics:

- [Propagation Job Overview](#)

- [Creating an Oracle Messaging Gateway Propagation Job](#)
- [Enabling and Disabling a Propagation Job](#)
- [Resetting a Propagation Job](#)
- [Altering a Propagation Job](#)
- [Removing a Propagation Job](#)

19.5.1 Propagation Job Overview

A propagation job specifies what messages are propagated and how the messages are propagated.

Messaging Gateway allows bidirectional message propagation. An outbound propagation moves messages from Oracle Database Advanced Queuing to non-Oracle messaging systems. An inbound propagation moves messages from non-Oracle messaging systems to Oracle Database Advanced Queuing.

If the propagation source is a queue (point-to-point), then the Messaging Gateway agent moves all messages from the source queue to the destination queue. If the propagation source is a topic (publish/subscribe), then the Messaging Gateway agent creates a subscriber of the propagation source queue in the messaging system. The agent only moves messages that are published to the source queue after the subscriber is created.

When propagating a message, the Messaging Gateway agent converts the message from the format in the source messaging system to the format in the destination messaging system. Users can customize the message conversion by providing a message [transformation](#). If message conversion fails, then the message will be moved to an exception queue, if one has been provided, so that the agent can continue to propagate messages for the subscriber.

A Messaging Gateway exception queue is different from an Oracle Database Advanced Queuing exception queue. Messaging Gateway moves a message to a Messaging Gateway exception queue when message conversion fails. Oracle Database Advanced Queuing moves a message to an Oracle Database Advanced Queuing exception queue after `MAX_RETRIES` dequeue attempts on the message.

Messages moved to an Oracle Database Advanced Queuing exception queue may result in irrecoverable failures on the associated Messaging Gateway propagation job. To avoid the problem, the `MAX_RETRIES` parameter of any Oracle Database Advanced Queuing queue that is used as the propagation source of a Messaging Gateway propagation job should be set to a value much larger than 16.

If the messaging system of the propagation source queue supports message selection, then a message selection rule can be specified for a propagation subscriber. Only messages that satisfy the message selector will be propagated.

Users can also specify propagation job options to control how messages are propagated, such as options for [JMS message](#) delivery mode and TIB/Rendezvous queue policies.

The `MGW_JOBS` view can be used to check the configuration and status of Messaging Gateway propagation jobs.

**See Also:**[Monitoring Oracle Messaging Gateway](#)

19.5.2 Creating an Oracle Messaging Gateway Propagation Job

Messaging Gateway propagation jobs are created by `DBMS_MGWADM.CREATE_JOB`.

If the propagation source for non-JMS propagation is an Oracle Database AQ queue, then the queue can be either a single consumer queue or multiple consumer queue. If it is a multiple consumer queue, Messaging Gateway creates a corresponding Oracle Database AQ subscriber `MGW_job_name` for the propagation job `job_name` when `DBMS_MGWADM.CREATE_JOB` is called.

If the propagation source is a JMS topic, such as an [Oracle Java Message Service \(Oracle JMS\)](#) topic or a WebSphere MQ JMS topic, then a JMS subscriber `MGW_job_name` is created on the topic in the source messaging system by the Messaging Gateway agent. If the agent is not running, then the subscriber will not be created until the agent is restarted.

If the propagation source is a queue, then only one propagation job can be created using that queue as the propagation source. If the propagation source is a topic, then multiple propagation jobs can be set up using that topic as the propagation source with each propagation job having its own corresponding subscriber on the topic in the messaging system.

[Example 19-18](#) creates Messaging Gateway propagation job `job_aq2mq`.

**Note:**

If a WebSphere MQ JMS topic is involved in a propagation job and the interface type of the link is `DBMS_MGWADM.JMS_TOPIC_CONNECTION`, then a durable subscriber `MGL_subscriber_id` is created on the log topic. The durable subscriber is removed when the Messaging Gateway propagation job is successfully removed.

Example 19-18 Creating a Messaging Gateway Propagation Job

```

BEGIN
  DBMS_MGWADM.CREATE_JOB(
    job_name          => 'job_aq2mq',
    propagation_type => DBMS_MGWADM.OUTBOUND_PROPAGATION,
    source            => 'mquser.srcq',
    destination      => 'deqq@mqlink');
END;
```

19.5.3 Enabling and Disabling a Propagation Job

A propagation job can be initially enabled or disabled when it is created by `DBMS_MGWADM.CREATE_JOB`. By default, a job is enabled when it is created. You can use

`DBMS_MGWADM.ENABLE_JOB` to enable a propagation job and `DBMS_MGWADM.DISABLE_JOB` to disable a job. No propagation processing will occur when the job is disabled.

[Example 19-19](#) enables the propagation for propagation job `job_aq2mq`.

[Example 19-20](#) disables the propagation for propagation job `job_aq2mq`.

Example 19-19 Enabling a Messaging Gateway Propagation Job

```
BEGIN
  DBMS_MGWADM.ENABLE_JOB(job_name => 'job_aq2mq');
END;
```

Example 19-20 Disabling a Messaging Gateway Propagation Job

```
BEGIN
  DBMS_MGWADM.DISABLE_JOB(job_name => 'job_aq2mq');
END;
```

19.5.4 Resetting a Propagation Job

When a problem occurs with a propagation job, the Messaging Gateway agent retries the failed operation up to 16 times in an exponential backoff scheme before the propagation job stops. You can use `DBMS_MGWADM.RESET_JOB` to reset the failure count to zero to allow the agent to retry the failed operation immediately.

[Example 19-21](#) resets the failure count for propagation job `job_aq2mq`.

Example 19-21 Resetting a Propagation Job

```
BEGIN
  DBMS_MGWADM.RESET_JOB (job_name => 'job_aq2mq');
END;
```

19.5.5 Altering a Propagation Job

After a propagation job is created you can alter the selection rule, transformation, exception queue, job options, and poll interval of the job using `DBMS_MGWADM.ALTER_JOB`. The job can be altered with the Messaging Gateway running or shut down.

[Example 19-22](#) adds an exception queue for a propagation job.

[Example 19-23](#) changes the polling interval for a propagation job. The polling interval determines how soon the agent can discover the available messages in the propagation source queue. The default polling interval is 5 seconds or the value set for `oracle.mgw.polling_interval` in the Messaging Gateway initialization file.

Example 19-22 Altering Propagation Job by Adding an Exception Queue

```
BEGIN
  DBMS_MGWADM.ALTER_JOB(
    job_name           => 'job_aq2mq',      exception_queue =>
    'mgwuser.my_ex_queue');
END;
```

Example 19-23 Altering Propagation Job by Changing the Polling Interval

```
BEGIN
  DBMS_MGWADM.ALTER_JOB(
```

```
        job_name      => 'job_aq2mq',        poll_interval => 2);  
END;
```

19.5.6 Removing a Propagation Job

You can remove a Messaging Gateway propagation job by calling `DBMS_MGWADM.REMOVE_JOB`.

Before removing the propagation job from the Messaging Gateway configuration, Messaging Gateway does the following cleanup:

- Removes from the messaging system the associated subscriber that may have been created by Messaging Gateway
- Removes propagation log records from log queues for the job being removed

Messaging Gateway may fail to do the cleanup because:

- The Messaging Gateway agent is not running
- Non-Oracle messaging system is not running
- The Messaging Gateway agent cannot interact with the source or destination messaging system

If the Messaging Gateway cleanup fails for any reason, then the propagation job being removed is placed in a `DELETE_PENDING` state. The Messaging Gateway agent tries to clean up propagation jobs in a `DELETE_PENDING` state when:

- `DBMS_MGWADM.REMOVE_JOB` is called and the Messaging Gateway agent is running.
- The Messaging Gateway agent is starting and finds a propagation job in a `DELETE_PENDING` state.

`DBMS_MGWADM.REMOVE_JOB` has a force parameter that allows you to force the propagation job to be removed from the Messaging Gateway configuration without placing it in `DELETE_PENDING` state. This is useful in case of cleanup failures or if you want to remove a propagation job when the Messaging Gateway agent is not running.

Forcing a propagation job to be removed may result in obsolete log records being left in the log queues, and subscriptions in the messaging systems that may cause unnecessary message accumulation. Oracle recommends that the force option not be used for `DBMS_MGWADM.REMOVE_JOB` if possible.

[Example 19-24](#) removes a propagation job in a non-forced manner.

Example 19-24 Removing a Propagation Job

```
BEGIN  
    DBMS_MGWADM.REMOVE_JOB (job_name => 'job_aq2mq');  
END;
```

19.6 Propagation Jobs, Subscribers, and Schedules

Subprograms are provided as part of the `DBMS_MGWADM` package that simplify the creation and management of propagation jobs. Those subprograms allow a user to configure a propagation job rather than a disjoint subscriber and schedule as was done in prior releases. Oracle recommends that you use the propagation job procedures but still supports the subscriber and schedule procedures for backward compatibility.

Table 19-1 lists the Messaging Gateway propagation job procedures and shows which subscriber and/or schedule procedures it replaces. All procedures are from the DBMS_MGWADM package.

Table 19-1 Messaging Gateway Propagation Job Subprograms

Job Procedure	Replaces Subscriber, Schedule Procedure
CREATE_JOB	ADD_SUBSCRIBER, SCHEDULE_PROPAGATION
ALTER_JOB	ALTER_SUBSCRIBER, ALTER_PROPAGATION_SCHEDULE
REMOVE_JOB	REMOVE_SUBSCRIBER, UNSCHEDULE_PROPAGATION
ENABLE_JOB	ENABLE_PROPAGATION_SCHEDULE
DISABLE_JOB	DISABLE_PROPAGATION_SCHEDULE
RESET_JOB	RESET_SUBSCRIBER

This section contains the following topics:

- [Propagation Job_ Subscriber_ Schedule Interface Interoperability](#)
- [Propagation Job_ Subscriber_ Schedule Views](#)
- [Single Consumer Queue as Propagation Source](#)

19.6.1 Propagation Job, Subscriber, Schedule Interface Interoperability

The user can create two types of propagation jobs, a new style job or an old style job. A new style job is created by DBMS_MGWADM.CREATE_JOB. An old style job is created by calling DBMS_MGWADM.ADD_SUBSCRIBER and DBMS_MGWADM.SCHEDULE_PROPAGATION using the same {propagation_type, source, destination} triplet. A subscriber that does not have a matching schedule, or a schedule that does not have a matching subscriber, is not considered to be a propagation job.

For new style job, the job name will serve as both the subscriber ID and the schedule ID. For an old style job, the subscriber ID is used as the job name.

Both the propagation job subprograms and the subscriber/schedule subprograms can be used for old style propagation jobs. Oracle recommends that you use the job subprograms to create and manage propagation jobs. The job subprograms cannot be used for an unmatched subscriber or schedule since those do not constitute a propagation job.

Only the new job subprograms can be used for new style propagation jobs. An error will occur if a user tries to call a subscriber or scheduler procedure on a new style job.

Other than DBMS_MGWADM.REMOVE_JOB, calling the job subprograms for an old style job is straightforward and the results are effectively the same as calling the corresponding subscriber/schedule subprograms. There may be certain restrictions in the future but there are none at this time.

The DBMS_MGWADM.REMOVE_JOB procedure can be used to remove both new style and old style jobs. A forced and non-forced remove is supported. If the Messaging Gateway agent is not running when a non-forced remove is done, the job will be flagged as delete pending and neither the underlying subscriber nor schedule will be removed at that time. The job (subscriber /schedule pair) will be removed once the agent is

restarted and performs its cleanup work or a forced `DBMS_MGWADM.REMOVE_JOB` is performed. In order to insure that the subscriber/schedule pair is removed at the same time, an error will occur if you first call `DBMS_MGWADM.REMOVE_JOB` and subsequently attempt to call `DBMS_MGWADM.REMOVE_SUBSCRIBER` or `DBMS_MGWADM.UNSCHEDULE_PROPAGATION` for an old style job.

Once `DBMS_MGWADM.REMOVE_JOB` has been called for a job and it has been flagged as delete pending, all job procedures, other than `DBMS_MGWADM.REMOVE_JOB`, will fail for both new style and old style jobs. In addition, all subscriber and schedule subprograms will fail if the propagation job happens to be an old style job. `DBMS_MGWADM.REMOVE_SUBSCRIBER` and `DBMS_MGWADM.UNSCHEDULE_PROPAGATION` can be used for an old style job as long as `DBMS_MGWADM.REMOVE_JOB` has not been called for that job. If `DBMS_MGWADM.UNSCHEDULE_PROPAGATION` is called for an old style job, the schedule is immediately removed and it ceases to be a propagation job and `DBMS_MGWADM.REMOVE_SUBSCRIBER` must be used to remove the subscriber. If `DBMS_MGWADM.REMOVE_SUBSCRIBER` is called for an old style job, the user can subsequently call `DBMS_MGWADM.REMOVE_JOB` as long as the subscriber exists.

19.6.2 Propagation Job, Subscriber, Schedule Views

The `MGW_JOBS` view shows information for the current propagation jobs, both new style jobs and old style jobs, and includes all the pertinent information shown by the `MGW_SUBSCRIBERS` and `MGW_SCHEDULES` views. The `MGW_SUBSCRIBERS` and `MGW_SCHEDULES` views are still useful for finding an unmatched subscriber or schedule since they don't constitute a propagation job and will not show up in the `MGW_JOBS` view.

19.6.3 Single Consumer Queue as Propagation Source

Messaging Gateway allows an Oracle Database AQ multiple consumer queue or a single consumer queue to be a propagation source for an outbound new style job created by `DBMS_MGWADM.CREATE_JOB`. A multiple consumer queue must be used for the propagation source for an outbound old style job. An error will occur if an administrator attempts to call `DBMS_MGWADM.ADD_SUBSCRIBER` and the source is a single consumer queue.

An Oracle Database AQ dequeue condition is not supported for native (non-JMS) outbound propagation when the propagation source is a single consumer queue.

19.7 Configuration Properties

This section summarizes basic and optional properties related to Messaging Gateway links, foreign queues, and propagation jobs.

This section contains these topics:

- [WebSphere MQ System Properties](#)
- [TIB/Rendezvous System Properties](#)
- [Optional Link Configuration Properties](#)
- [Optional Foreign Queue Configuration Properties](#)
- [Optional Job Configuration Properties](#)

19.7.1 WebSphere MQ System Properties

Table 19-2 summarizes the basic configuration properties for a WebSphere MQ messaging link. The table indicates which properties of `SYS.MGW_MQSERIES_PROPERTIES` are optional (`NULL` allowed), which can be altered, and if alterable, which values can be dynamically changed.



See Also:

"SYS.MGW_MQSERIES_PROPERTIES Type" in *Oracle Database PL/SQL Packages and Types Reference*

Table 19-2 WebSphere MQ Link Properties

Attribute	NULL Allowed?	Alter Value?	Dynamic?
queue_manager	no	no	no
hostname	yes (1)	no	no
port	yes (1)	no	no
channel	yes (1), (6)	yes	no
interface_type	yes (2)	no	no
max_connections	yes (3)	yes	yes
username	yes	yes	yes
password	yes	yes	yes
inbound_log_queue	yes (4)	yes(4)	yes
outbound_log_queue	yes (5)	yes(5)	yes

Notes on Table 19-2

- If `hostname` is `NULL`, then the `port` and `channel` must be `NULL`. If the `hostname` is not `NULL`, then the `port` must be not `NULL`. If the `hostname` is `NULL`, then a WebSphere MQ bindings connection is used; otherwise a client connection is used.
- If `interface_type` is `NULL`, then a default value of `DBMS_MGWADM.MQSERIES_BASE_JAVA_INTERFACE` is used.
- If `max_connections` is `NULL`, then a default value of 1 is used.
- Attribute `inbound_log_queue` can be `NULL` if the link is not used for inbound propagation. The log queue can be altered only when no inbound propagation job references the link.
- Attribute `outbound_log_queue` can be `NULL` if the link is not used for outbound propagation. The log queue can be altered only when no outbound propagation job references the link.
- The `channel` attribute must be `NULL` if a client channel definition table (CCDT) is used. The `MQ_ccdtURL` link option can be used to specify a CCDT.

Table 19-3 summarizes the optional configuration properties supported when a WebSphere MQ Base Java interface is used to access the WebSphere MQ

messaging system. [Table 19-4](#) summarizes the optional configuration properties supported when a WebSphere MQ JMS interface is used. Each table lists the property name, where that property applies, whether the property can be altered, and if alterable, whether the value can be dynamically changed. Only the properties listed in the tables are supported, and any extra properties are ignored.

Table 19-3 Optional Configuration Properties for WebSphere MQ Base Java

Property Name	Used For	Alter Value?	Dynamic?
MQ_ccdtUrl	link	yes	no
MQ_ccsid	link	yes	no
MQ_ReceiveExit	link	yes	no
MQ_SecurityExit	link	yes	no
MQ_SendExit	link	yes	no
MQ_SSLCipherSuite	link	yes	no
MQ_SSLEipsRequired	link	yes	no
MQ_SSLPeerName	link	yes	no
MQ_SSLResetCount	link	yes	no
MQ_openOptions	foreign queue	no	no
MsgBatchSize	job	yes	yes
PreserveMessageID	job	yes	yes

Table 19-4 Optional Configuration Properties for WebSphere MQ JMS

Property Name	Used For	Alter Value?	Dynamic?
MQ_BrokerControlQueue	link	yes	no
MQ_BrokerPubQueue	link	yes	no
MQ_BrokerQueueManager	link	yes	no
MQ_BrokerVersion	link	yes	no
MQ_ccdtUrl	link	yes	no
MQ_ccsid	link	yes	no
MQ_JmsDurSubQueue	link	no	no
MQ_PubAckInterval	link	yes	no
MQ_ReceiveExit	link	yes	no
MQ_ReceiveExitInit	link	yes	no
MQ_SecurityExit	link	yes	no
MQ_SecurityExitInit	link	yes	no
MQ_SendExit	link	yes	no
MQ_SendExitInit	link	yes	no
MQ_SSLCipherSuite	link	yes	no
MQ_SSLErl	link	yes	no
MQ_SSLEipsRequired	link	yes	no
MQ_SSLPeerName	link	yes	no

Table 19-4 (Cont.) Optional Configuration Properties for WebSphere MQ JMS

Property Name	Used For	Alter Value?	Dynamic?
MQ_SSLResetCount	link	yes	no
MQ_CharacterSet	foreign queue	no	no
MQ_JmsDurSubQueue	foreign queue	no	no
MQ_JmsTargetClient	foreign queue	no	no
JMS_DeliveryMode	job	yes	yes
JMS_NoLocal	job	no	no
MsgBatchSize	job	yes	yes
PreserveMessageID	job	yes	yes

19.7.2 TIB/Rendezvous System Properties

Table 19-5 summarizes the basic configuration properties for a TIB/Rendezvous messaging link. It indicates which properties of `SYS.MGW_TIBRV_PROPERTIES` are optional (NULL allowed), which can be altered, and if alterable, which values can be dynamically changed.



See Also:

"SYS.MGW_TIBRV_PROPERTIES Type" in *Oracle Database PL/SQL Packages and Types Reference*

Table 19-5 TIB/Rendezvous Link Properties

Attribute	NULL allowed?	Alter value?	Dynamic?
service	yes(1)	no	no
daemon	yes(1)	no	no
network	yes(1)	no	no
cm_name	yes(2)	no	no
cm_ledger	yes(2)	no	no

Notes on Table 19-5:

- System default values will be used if `service`, `daemon`, or `network` are NULL.
- The `cm_name` and `cm_ledger` attributes are reserved for future use when TIB/Rendezvous certified messages are supported. At present, a NULL must be specified for these parameters when a TIB/Rendezvous link is configured.

Table 19-6 summarizes the optional configuration properties supported when a TIB/Rendezvous messaging system is used. The table lists the property name, where that property applies, whether the property can be altered, and if alterable, whether the value can be dynamically changed. Only the properties listed in the table are supported, and any extra properties will be ignored.

Table 19-6 Optional Properties for TIB/Rendezvous

Property Name	Used For	Alter Value?	Dynamic?
AQ_MsgProperties	job	yes	yes
MsgBatchSize	job	yes	yes
PreserveMessageID	job	yes	yes
RV_discardAmount	job	yes	no
RV_limitPolicy	job	yes	no
RV_maxEvents	job	yes	no

19.7.3 Optional Link Configuration Properties

This section describes optional link properties you can specify using the `options` parameter of `DBMS_MGWADM.CREATE_MSGSYSTEM_LINK` and `DBMS_MGWADM.ALTER_MSGSYSTEM_LINK`. Each listing also indicates which messaging system might use that property.

MQ_BrokerControlQueue

This property is used by WebSphere MQ JMS. It specifies the name of the broker control queue and corresponds to WebSphere MQ JMS administration tool property `BROKERCONQ`. The WebSphere MQ default is `SYSTEM.BROKER.CONTROL.QUEUE`.

MQ_BrokerPubQueue

This property is used by WebSphere MQ JMS. It specifies the name of the broker publish queue and corresponds to WebSphere MQ JMS administration tool property `BROKERPUBQ`. The WebSphere MQ default is `SYSTEM.BROKER.DEFAULT.STREAM`.

MQ_BrokerQueueManager

This property is used by WebSphere MQ JMS. It specifies the name of the broker queue manager and corresponds to WebSphere MQ administration tool property `BROKERQMGR`. If it is not set, then no default is used.

MQ_BrokerVersion

This property is used by WebSphere MQ JMS. It specifies the broker version number and corresponds to WebSphere MQ JMS administration tool property `BROKERVER`. The WebSphere MQ default is `0`.

MQ_ccdtUrl

This property is used by WebSphere MQ Base Java and WebSphere MQ JMS. It specifies the URL string of a client channel definition table (CCDT) to be used. If not set, a CCDT is not used. If a CCDT is used, then the `SYS.MGW_MQSERIES_PROPERTIES.channel` link property must be `NULL`.

MQ_ccsid

This property is used by WebSphere MQ Base Java and WebSphere MQ JMS. It specifies the character set identifier to be used to translate information in the WebSphere MQ message header. This should be the integer value of the character set (for example, `819`) rather than a descriptive string. If it is not set, then the WebSphere MQ default character set `819` is used.

MQ_JmsDurSubQueue

This property is used by WebSphere MQ JMS. It applies to WebSphere MQ JMS topic links only. The `SYS.MGW_MQSERIES_PROPERITES` attributes, `inbound_log_queue` and `outbound_log_queue`, specify the names of WebSphere MQ JMS topics used for propagation logging. This property specifies the name of the WebSphere MQ queue from which durable subscription messages are retrieved by the log topic subscribers. The WebSphere MQ default queue is `SYSTEM.JMS.D.SUBSCRIBER.QUEUE`.

MQ_PubAckInterval

This property is used by WebSphere MQ JMS. It specifies the interval, in number of messages, between publish requests that require acknowledgment from the broker and corresponds to WebSphere MQ JMS administration tool property `PUBACKINT`. The WebSphere MQ default is 25.

MQ_ReceiveExit

This property is used by WebSphere MQ Base Java and WebSphere MQ JMS. It specifies the fully qualified Java classname of a class implementing the `MQReceiveExit` interface. This class must be in the `CLASSPATH` of the Messaging Gateway agent. There is no default.

MQ_ReceiveExitInit

This initialization string is used by WebSphere MQ JMS. It is passed by WebSphere MQ JMS to the constructor of the class specified by `MQ_ReceiveExit` and corresponds to WebSphere MQ JMS administration tool property `RECEXITINIT`. There is no default.

MQ_SecurityExit

This property is used by WebSphere MQ Base Java and WebSphere MQ JMS. It specifies the fully qualified Java classname of a class implementing the `MQSecurityExit` interface. This class must be in the `CLASSPATH` of the Messaging Gateway agent. There is no default.

MQ_SecurityExitInit

This initialization string is used by WebSphere MQ JMS. It is passed by WebSphere MQ JMS to the constructor of the class specified by `MQ_SecurityExit` and corresponds to WebSphere MQ JMS administration tool property `SECEXITINIT`. There is no default.

MQ_SendExit

This property is used by WebSphere MQ Base Java and WebSphere MQ JMS. It specifies the fully qualified Java classname of a class implementing the `MQSendExit` interface. This class must be in the `CLASSPATH` of the Messaging Gateway agent. There is no default.

MQ_SendExitInit

This initialization string is used by WebSphere MQ JMS. It is passed by WebSphere MQ JMS to the constructor of the class specified by `MQ_SendExit`. It corresponds to WebSphere MQ JMS administration tool property `SENDEXITINIT`. There is no default.

MQ_SSLCipherSuite

This property is used by WebSphere MQ Base Java and WebSphere MQ JMS. It specifies the CipherSuite to be used; for example, `SSL_RSA_WITH_RC4_128_MD5`. This corresponds to the WebSphere MQ `SSLCIPHERSUITE` administration property.

MQ_SSLCrl

This property is used by WebSphere MQ JMS. It specifies a space-delimited list of LDAP servers that can be used for certificate revocation list (CRL) checking. If not set,

no CRL checking is done. This corresponds to the WebSphere MQ `SSLCRL` administration property. This option is not supported for WebSphere MQ Base Java, and instead, a client channel definition table (CCDT) must be used if CRL checking is needed.

MQ_SSLFipsRequired

This property is used by WebSphere MQ Base Java and WebSphere MQ JMS. It indicates whether the CipherSuite being used is supported by the IBM Java JSSE FIPS provider (IBMSJSSEFIPS). The value should be `TRUE` or `FALSE`. The default value is `FALSE`. This corresponds to the WebSphere MQ `SSLFIPSREQUIRED` administration property.

MQ_SSLPeerName

This property is used by WebSphere MQ Base Java and WebSphere MQ JMS. It specifies a distinguished name (DN) pattern that the queue manager certificate must match in order for a connection to be established. If not set, no DN check is performed. This corresponds to the WebSphere MQ `SSLPEERNAME` administration property.

MQ_SSLResetCount

This property is used by WebSphere MQ Base Java and WebSphere MQ JMS. It specifies the total number of bytes sent and received before the secret key is renegotiated. If not set, the key is not renegotiated. This corresponds to the WebSphere MQ `SSLRESETCOUNT` administration property.

19.7.4 Optional Foreign Queue Configuration Properties

This section describes optional foreign queue properties that you can specify using the `options` parameter of `DBMS_MGWADM.REGISTER_FOREIGN_QUEUE`. Each listing also indicates which messaging system might use that property.

MQ_CharacterSet

This property is used by WebSphere MQ JMS. It is used only for outbound propagation to a JMS queue or topic. It specifies the character set to be used to encode text strings sent to the destination. It should be the integer value of the character set (for example, 1208) rather than a descriptive string. The default value used by Messaging Gateway is 1208 (UTF8).

MQ_JmsDurSubQueue

This property is used by WebSphere MQ JMS. It is a string representing the name of the WebSphere MQ queue from which durable subscription messages are retrieved by subscribers on this topic. It applies only to WebSphere MQ JMS topics. The WebSphere MQ default queue is `SYSTEM.JMS.D.SUBSCRIBER.QUEUE`.

MQ_JmsTargetClient

This property is used by WebSphere MQ JMS. It is used only for outbound propagation to a JMS queue or topic. Supported values are `TRUE` and `FALSE`. `TRUE` indicates that WebSphere MQ should store the message as a JMS message. `FALSE` indicates that WebSphere MQ should store the message in non-JMS format so that non-JMS applications can access it. Default is `TRUE`.

MQ_openOptions

This property is used by WebSphere MQ Base Java. It specifies the value used for the `openOptions` argument of the WebSphere MQ Base Java `MQQueueManager.accessQueue` method. No value is required. But if one is given, then the

Messaging Gateway agent adds `MQOO_OUTPUT` to the specified value for an enqueue (`put`) operation. `MQOO_INPUT_SHARED` is added for a dequeue (`get`) operation. The default is `MQOO_OUTPUT` for an enqueue/put operation; `MQOO_INPUT_SHARED` for a dequeue/get operation.

19.7.5 Optional Job Configuration Properties

This section describes optional propagation job properties that you can specify using the `options` parameter of `DBMS_MGWADM.CREATE_JOB` and `DBMS_MGWADM.ALTER_JOB`.

AQ_MsgProperties

This property is used by TIB/Rendezvous. It specifies how Oracle Database AQ message properties will be used during message propagation. Supported values are `TRUE` and `FALSE`. The default value is `FALSE`.

For an outbound propagation job, if the value is `TRUE` (case insensitive), then the Messaging Gateway agent will add a field for most Oracle Database AQ message properties to the message propagated to the TIB/Rendezvous subject.

For an inbound propagation job, if the value is `TRUE` (case insensitive), then the Messaging Gateway agent will search the source message for a field with a reserved name, and if it exists, use its value to set the corresponding Oracle Database AQ message property. A default value will be used if the field does not exist or does not have an expected datatype.

JMS_DeliveryMode

This property is used by WebSphere MQ JMS and Oracle JMS. You can use this property when the propagation destination is a JMS messaging system. It sets the delivery mode of messages enqueued to the propagation destination queue by a JMS `MessageProducer`. The default is `PRESERVE_MSG`. Supported values and their associated delivery modes are:

- `PERSISTENT` (`DeliveryMode.PERSISTENT`)
- `NON_PERSISTENT` (`DeliveryMode.NON_PERSISTENT`)
- `PRESERVE_MSG` (delivery mode of the source JMS message is used)

JMS_NoLocal

This property is used by WebSphere MQ JMS and Oracle JMS. You can use it when the propagation source is a JMS messaging system. It sets the `noLocal` parameter of a JMS `TopicSubscriber`. `TRUE` indicates that messages that have been published to this topic through the same Messaging Gateway link will not be propagated. The default value `FALSE` indicates that such messages will be propagated from the topic.

MsgBatchSize

This property can be used by any supported messaging system. It specifies the maximum number of messages, if available, to be propagated in one transaction. The default is 30.

PreserveMessageID

This property is used by WebSphere MQ Base Java, WebSphere MQ JMS, TIB/Rendezvous, and Oracle JMS. It specifies whether Messaging Gateway should preserve the original message identifier when the message is propagated to the destination messaging system. The exact details depend on the capabilities of the messaging systems involved. Supported values are `TRUE` and `FALSE`. The default value is `FALSE`.

RV_discardAmount

This property is used by TIB/Rendezvous. It specifies the discard amount of a queue. It is meaningful only for an inbound propagation job. The default is 0.

RV_limitPolicy

This property is used by TIB/Rendezvous. It specifies the limit policy for resolving overflow of a queue limit. It is meaningful only for an inbound propagation job. The default is `DISCARD_NONE`. Supported values and their associated limit policies are:

`DISCARD_NONE`, `DISCARD_FIRST`, `DISCARD_LAST` and `DISCARD_NEW`.

- `DISCARD_NONE` (`TibrvQueue.DISCARD_NONE`)
- `DISCARD_FIRST` (`TibrvQueue.DISCARD_FIRST`)
- `DISCARD_LAST` (`TibrvQueue.DISCARD_LAST`)
- `DISCARD_NEW` (`TibrvQueue.DISCARD_NEW`)

RV_maxEvents

This property is used by TIB/Rendezvous. It specifies the maximum event limit of a queue. It is meaningful only for an inbound propagation job. The default is 0.

Oracle Messaging Gateway Message Conversion

The following topics discuss how Oracle Messaging Gateway (MGW) converts [message](#) formats from one messaging system to another. A conversion is generally necessary when moving messages between Oracle Database Advanced Queuing and another system, because different messaging systems have different message formats. [Java Message Service](#) (JMS) messages are a special case. A [JMS message](#) can be propagated only to a JMS destination, making conversion a simple process.

- [Converting Oracle Messaging Gateway Non-JMS Messages](#)
- [Message Conversion for WebSphere MQ](#)
- [Message Conversion for TIB/Rendezvous](#)
- [JMS Messages](#)

20.1 Converting Oracle Messaging Gateway Non-JMS Messages

MGW converts the native message format of the source messaging system to the native message format of the destination messaging system during [propagation](#). MGW uses [canonical](#) types and a model centering on Oracle Database Advanced Queuing for the conversion.

20.1.1 Overview of the Non-JMS Message Conversion Process

When a message is propagated by MGW, the message is converted from the native format of the source [queue](#) to the native format of the destination queue.

A native message usually contains a message header and a message body. The header contains the fixed header fields that all messages in that messaging system have, such as message properties in Oracle Database Advanced Queuing and the fixed header in WebSphere MQ. The body contains message contents, such as the Oracle Database Advanced Queuing payload, the WebSphere MQ message body, or the entire TIB/Rendezvous message. MGW converts both message header and message body components.

[Figure 20-1](#) shows how non-JMS messages are converted in two stages. A message is first converted from the native format of the source queue to the MGW internal message format, and then it is converted from the internal message format to the native format of the destination queue.

Figure 20-1 Non-JMS Message Conversion

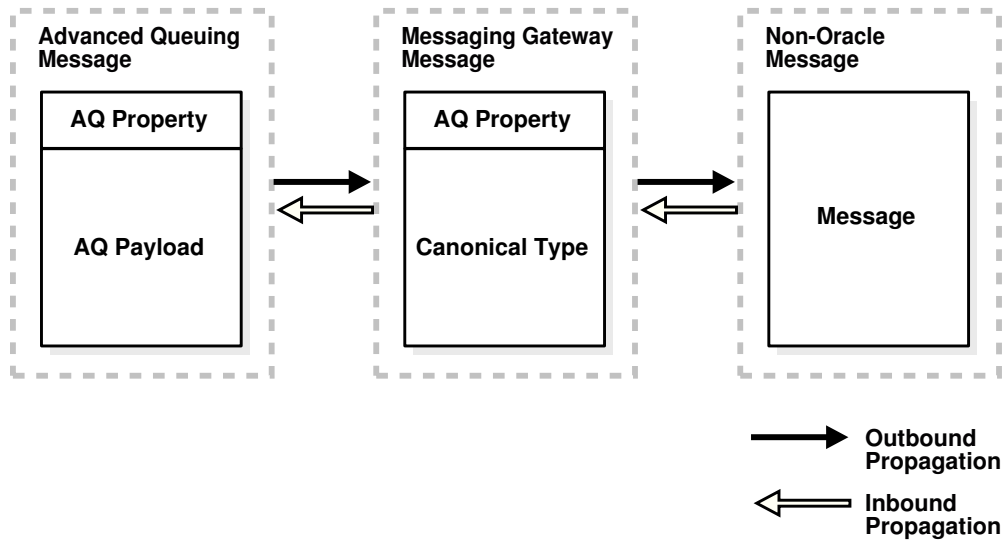

The MGW agent uses an internal message format consisting of a header that is similar to the Oracle Database Advanced Queuing message properties and a body that is a representation of an MGW canonical type.

20.1.2 Oracle Messaging Gateway Canonical Types

MGW defines canonical types to support message conversion between Oracle Database Advanced Queuing and non-Oracle messaging systems. A canonical type is a message type representation in the form of a PL/SQL Oracle type in Oracle Database. The canonical types are `RAW`, `SYS.MGW_BASIC_MSG_T`, and `SYS.MGW_TIBRV_MSG_T`.

WebSphere MQ propagation supports the canonical types `SYS.MGW_BASIC_MSG_T` and `RAW`. TIB/Rendezvous propagation supports the canonical types `SYS.MGW_TIBRV_MSG_T` and `RAW`.

See Also:

"DBMS_MGWMSG" in *Oracle Database PL/SQL Packages and Types Reference* for Syntax and attribute information for `SYS.MGW_BASIC_MSG_T` and `SYS.MGW_TIBRV_MSG_T`

20.1.3 Message Header Conversion

MGW provides default mappings between Oracle Database Advanced Queuing message properties and non-Oracle message header fields that have a counterpart in Oracle Database Advanced Queuing message properties with the same semantics. Where MGW does not provide a mapping, the message header fields are set to a default value, usually the default value defined by the messaging system.

20.1.4 Handling Arbitrary Payload Types Using Message Transformations

When converting to or from Oracle Database Advanced Queuing messages, the MGW agent uses only its canonical types. Arbitrary payload types are supported, however, with the assistance of user-defined Oracle Database Advanced Queuing message transformations to convert between an Oracle Database Advanced Queuing queue payload and an MGW canonical type.

For MGW to propagate messages from an Oracle Database Advanced Queuing queue with an arbitrary ADT payload (outbound propagation), you must provide a mapping to an MGW canonical ADT. The transformation is invoked when the MGW agent dequeues messages from the Oracle Database Advanced Queuing queue. Similarly, for MGW to propagate messages to an Oracle Database Advanced Queuing queue with an arbitrary ADT payload (inbound propagation), you must provide a mapping from an MGW canonical ADT. The transformation is invoked when the MGW agent enqueues messages to the Oracle Database Advanced Queuing queue.

Figure 20-2 Oracle Database Advanced Queuing Message Conversion

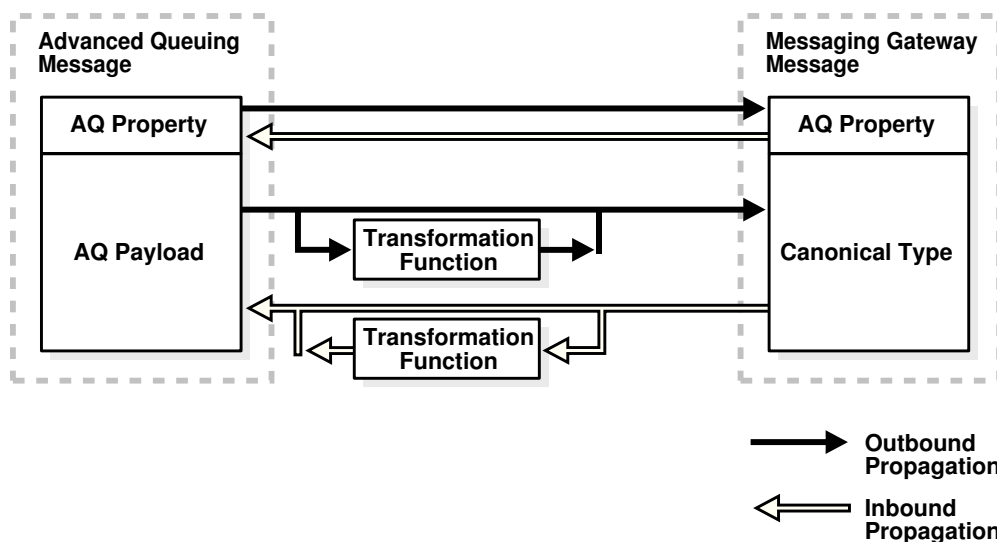

The transformation is always executed in the context of the MGW agent, which means that the MGW agent user (the user specified using `DBMS_MGWADM.CREATE_AGENT` or `DBMS_MGWADM.ALTER_AGENT`) must have `EXECUTE` privileges on the transformation function and the Oracle Database Advanced Queuing payload type. This can be accomplished by granting the `EXECUTE` privilege to `PUBLIC` or by granting the `EXECUTE` privilege directly to the MGW agent user.

To configure a MGW propagation job with a transformation:

1. Create the transformation function.
2. Grant `EXECUTE` to the MGW agent user or to `PUBLIC` on the function and the object types it references.
3. Call `DBMS_TRANSFORM.CREATE_TRANSFORMATION` to register the transformation.

4. Call `DBMS_MGWADM.CREATE_JOB` to create a MGW propagation job using the transformation, or `DBMS_MGWADM.ALTER_JOB` to alter an existing job.

Example 20-1 Transformation Function Signature

```
FUNCTION trans_sampleadt_to_mgw_basic(in_msg IN mgwuser.sampleADT)
RETURN SYS.MGW_BASIC_MSG_T;
```

You can create a transformation using `DBMS_TRANSFORM.CREATE_TRANSFORMATION`, as shown in [Example 20-2](#).

Example 20-2 Creating a Transformation

```
BEGIN
  DBMS_TRANSFORM.CREATE_TRANSFORMATION(
    schema      => 'mgwuser',
    name        => 'sample_adt_to_mgw_basic',
    from_schema => 'mgwuser',
    from_type   => 'sampleadt',
    to_schema   => 'sys',
    to_type     => 'MGW_BASIC_MSG_T',
    transformation => 'mgwuser.trans_sampleadt_to_mgw_basic(user_data)');
END;
```

Example 20-3 Registering a Transformation

```
BEGIN
  DBMS_MGWADM.CREATE_JOB(
    job_name      => 'job_aq2mq',
    propagation_type => DBMS_MGWADM.OUTBOUND_PROPAGATION,
    source        => 'mgwuser.srcq',
    destination   => 'destq.mqlink',
    transformation => 'mgwuser.sample_adt_to_mgw_basic',
    exception_queue => 'mgwuser.excq');
END;
```

The value passed in the transformation parameter for these APIs must be the registered transformation name and not the function name. For example, `trans_sampleadt_to_mgw_basic` is a stored procedure representing a transformation function with the signature shown in [Example 20-1](#).



Note:

All commands in the examples must be run as a user granted `MGW_ADMINISTRATOR_ROLE`, except for the commands to create transformations.

Once created, this transformation can be registered with MGW when creating a propagation job. [Example 20-3](#) creates job `job_aq2mq`, for whom messages are propagated from Oracle Database Advanced Queuing queue `mgwuser.srcq` to non-Oracle messaging system queue `destq@mqlink` using transformation `mgwuser.sample_adt_to_mgw_basic`.

An error that occurs while attempting a user-defined transformation is usually considered a message conversion exception, and the message is moved to the [exception queue](#) if it exists.

 **See Also:**

"DBMS_MGWADM", "DBMS_MGWMSG", and "DBMS_TRANSFORM" in *Oracle Database PL/SQL Packages and Types Reference*

20.1.5 Handling Logical Change Records

MGW provides facilities to propagate Logical Change Records (LCRs). Routines are provided to help in creating transformations to handle the propagation of both row LCRs and DDL LCRs stored in queues with payload type `ANYDATA`. An LCR is propagated as an XML string stored in the appropriate message type.

 **Note:**

For LCR propagation, you must load the XDB package.

Because Oracle Streams uses `ANYDATA` queues to store LCRs, an `ANYDATA` queue is the source for outbound propagation. The transformation must first convert the `ANYDATA` object containing an LCR into an `XMLType` object using the MGW routine `DBMS_MGWMSG.LCR_TO_XML`. If the `ANYDATA` object does not contain an LCR, then this routine raises an error. The XML document string of the LCR is then extracted from the `XMLType` and placed in the appropriate MGW canonical type (`SYS.MGW_BASIC_MSG_T` or `SYS.MGW_TIBRV_MSG_T`).

Example 20-4 illustrates a simplified transformation used for LCR outbound propagation. The transformation converts an `ANYDATA` payload containing an LCR to a `SYS.MGW_TIBRV_MSG_T` object. The string representing the LCR as an XML document is put in a field named `ORACLE_LCR`.

For LCR inbound propagation, an MGW canonical type (`SYS.MGW_BASIC_MSG_T` or `SYS.MGW_TIBRV_MSG_T`) is the transformation source type. A string in the format of an XML document representing an LCR must be contained in the canonical type. The transformation function must extract the string from the message, create an `XMLType` object from it, and convert it to an `ANYDATA` object containing an LCR with the MGW routine `DBMS_MGWMSG.XML_TO_LCR`. If the original XML document does not represent an LCR, then this routine raises an error.

Example 20-5 illustrates a simplified transformation used for LCR inbound propagation. The transformation converts a `SYS.MGW_TIBRV_MSG_T` object with a field containing an XML string representing an LCR to an `ANYDATA` object. The string representing the LCR as an XML document is taken from a field named `ORACLE_LCR`.

 **See Also:**

- "DBMS_MGWMSG" in *Oracle Database PL/SQL Packages and Types Reference*
- `ORACLE_HOME/mgw/samples/lcr` for complete examples of LCR transformations

Example 20-4 Outbound LCR Transformation

```

create or replace function any2tibrv(adata in anydata)
return SYS.MGW_TIBRV_MSG_T is
    v_xml    XMLType;
    v_text   varchar2(2000);
    v_tibrv  sys.mgw_tibrv_msg_t;
BEGIN
    v_xml    := dbms_mgwmsg.lcr_to_xml(adata);
    -- assume the lcr is smaller than 2000 characters long.
    v_text   := v_xml.getStringVal();
    v_tibrv  := SYS.MGW_TIBRV_MSG_T.CONSTRUCT;
    v_tibrv.add_string('ORACLE_LCR', 0, v_text);
    return v_tibrv;
END any2tibrv;

```

Example 20-5 Inbound LCR Transformation

```

create or replace function tibrv2any(tdata in sys.mgw_tibrv_msg_t)
return anydata is
    v_field  sys.mgw_tibrv_field_t;
    v_xml    XMLType;
    v_text   varchar2(2000);
    v_any    anydata;
BEGIN
    v_field := tdata.get_field_by_name('ORACLE_LCR');
    -- type checking
    v_text := v_field.text_value;
    -- assume it is not null
    v_xml := XMLType.createXML(v_text);
    v_any := dbms_mgwmsg.xml_to_lcr(v_xml);
    return v_any;
END tibrv2any;

```

20.2 Message Conversion for WebSphere MQ

MGW converts between the MGW canonical types and the WebSphere MQ native message format. WebSphere MQ native messages consist of a fixed message header and a message body. The message body is treated as either a `TEXT` value or `RAW` (bytes) value. The canonical types supported for WebSphere MQ propagation are `SYS.MGW_BASIC_MSG_T` and `RAW`.

Figure 20-3 Message Conversion for WebSphere MQ Using MGW_BASIC_MSG_T

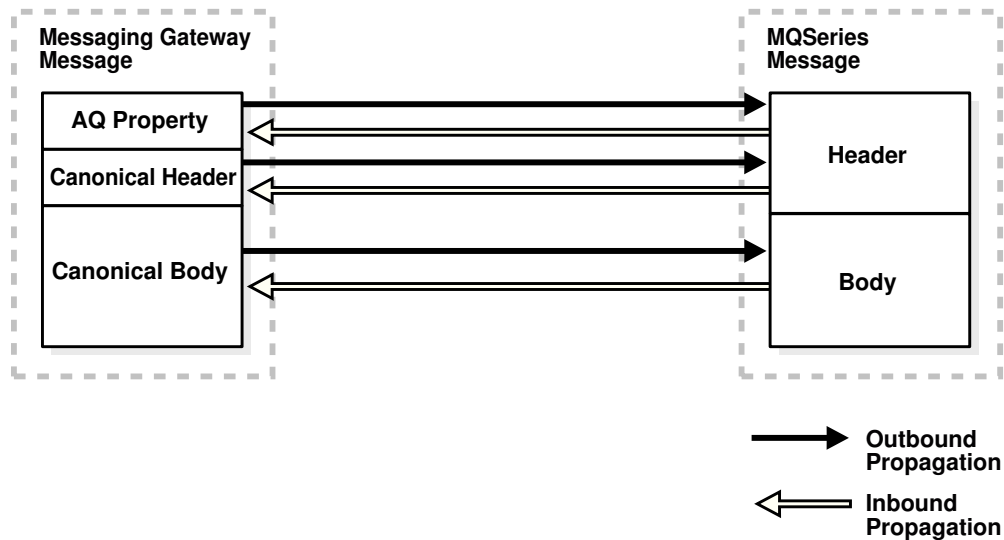

Figure 20-3 illustrates the message conversion performed by the MGW WebSphere MQ driver when using the canonical type `SYS.MGW_BASIC_MSG_T`. For outbound propagation, the driver maps the Oracle Database Advanced Queuing message properties and canonical message to a WebSphere MQ message having a fixed header and a message body. For inbound propagation, the driver maps a native message to a set of Oracle Database Advanced Queuing message properties and a canonical message. When the canonical type is `RAW`, the mappings are the same, except no canonical headers exist.

20.2.1 WebSphere MQ Message Header Mappings

When the MGW canonical type used in an outbound propagation job is `RAW`, no WebSphere MQ header information is set from the `RAW` message body. Similarly, for inbound propagation no WebSphere MQ header information is preserved in the `RAW` message body. MGW canonical type `SYS.MGW_BASIC_MSG_T`, however, has a header that can be used to specify WebSphere MQ header fields for outbound propagation, and preserve WebSphere MQ header fields for inbound propagation.

This section describes the message properties supported for the WebSphere MQ messaging system when using `SYS.MGW_BASIC_MSG_T` as the canonical type. Table 20-1 defines the MGW {name, value} pairs used to describe the WebSphere MQ header properties. The first column refers to valid string values for the `SYS.MGW_NAME_VALUE_T.NAME` field in the `SYS.MGW_BASIC_MSG_T` header. The second column refers to the `SYS.MGW_NAME_VALUE_T.TYPE` value corresponding to the name. (Refer to "Notes on Table 20-1" for explanations of the numbers in parentheses.)

For inbound propagation, the WebSphere MQ driver generates {name,value} pairs based on the source message header and stores them in the header part of the canonical message of the `SYS.MGW_BASIC_MSG_T` type. For outbound propagation, the WebSphere MQ driver sets the message header and enqueue options from {name,value} pairs for these properties stored in the header part of the `SYS.MGW_BASIC_MSG_T` canonical message.

Table 20-1 MGW Names for WebSphere MQ Header Values

MGW Name	MGW Type	WebSphere MQ Property Name	Used For
MGW_MQ_accountingToken	RAW_VALUE (size 32)	accountingToken	Outbound (1), Inbound
MGW_MQ_applicationIdData	TEXT_VALUE (size 32)	applicationIdData	Outbound (1), Inbound
MGW_MQ_applicationOriginData	TEXT_VALUE (size 4)	applicationOriginData	Outbound (1), Inbound
MGW_MQ_backoutCount	INTEGER_VALUE	backoutCount	Inbound
MGW_MQ_characterSet	INTEGER_VALUE	characterSet	Outbound, Inbound
MGW_MQ_correlationId	RAW_VALUE (size 24)	correlationId	Outbound (1), Inbound
MGW_MQ_encoding	INTEGER_VALUE	encoding	Outbound, Inbound
MGW_MQ_expiry	INTEGER_VALUE	expiry	Outbound, Inbound
MGW_MQ_feedback	INTEGER_VALUE	feedback	Outbound, Inbound
MGW_MQ_format	TEXT_VALUE (size 8)	format	Outbound (1), Inbound
MGW_MQ_groupId	RAW_VALUE (size 24)	groupId	Outbound (1), Inbound
MGW_MQ_messageFlags	INTEGER_VALUE	messageFlags	Outbound, Inbound
MGW_MQ_messageId	RAW_VALUE (size 24)	messageId	Outbound, Inbound
MGW_MQ_messageSequenceNumber	INTEGER_VALUE	messageSequenceNumber	Outbound, Inbound
MGW_MQ_messageType	INTEGER_VALUE	messageType	Outbound, Inbound
MGW_MQ_offset	INTEGER_VALUE	offset	Outbound, Inbound
MGW_MQ_originalLength	INTEGER_VALUE	originalLength	Outbound, Inbound
MGW_MQ_persistence	INTEGER_VALUE	persistence	Inbound
MGW_MQ_priority	INTEGER_VALUE	priority	Outbound, Inbound
MGW_MQ_putApplicationName	TEXT_VALUE (size 28)	putApplicationName	Outbound (1), Inbound

Table 20-1 (Cont.) MGW Names for WebSphere MQ Header Values

MGW Name	MGW Type	WebSphere MQ Property Name	Used For
MGW_MQ_putApplicationType	INTEGER_VALUE	putApplicationType	Outbound (1), Inbound
MGW_MQ_putDateTime	DATE_VALUE	putDateTime	Inbound
MGW_MQ_putMessageOptions	INTEGER_VALUE	putMessageOptions	Outbound (1) (2)
MGW_MQ_replyToQueueManagerName	TEXT_VALUE (size 48)	replyToQueueManagerName	Outbound, Inbound
MGW_MQ_replyToQueueName	TEXT_VALUE (size 48)	replyToQueueName	Outbound, Inbound
MGW_MQ_report	INTEGER_VALUE	report	Outbound (1), Inbound
MGW_MQ_userId	TEXT_VALUE (size 12)	userId	Outbound, Inbound

 **See Also:**

"DBMS_MGWMSG" in *Oracle Database PL/SQL Packages and Types Reference*

Notes on Table 20-1

1. This use is subject to WebSphere MQ restrictions. For example, if `MGW_MQ_accountingToken` is set for an outgoing message, then WebSphere MQ overrides its value unless `MGW_MQ_putMessageOptions` is set to the WebSphere MQ constant `MQPMD_SET_ALL_CONTEXT`.

2. `MGW_MQ_putMessageOptions` is used as the `putMessageOptions` argument to the WebSphere MQ Base Java `Queue.put()` method. It is not part of the WebSphere MQ header information and is therefore not an actual message property.

The value for the `openOptions` argument of the WebSphere MQ Base Java `MQQueueManager.accessQueue` method is specified when the WebSphere MQ queue is registered using the `DBMS_MGWADM.REGISTER_FOREIGN_QUEUE` call. Dependencies can exist between the two. For instance, for `MGW_MQ_putMessageOptions` to include `MQPMD_SET_ALL_CONTEXT`, the `MQ_openMessageOptions` queue option must include `MQOO_SET_CONTEXT`.

The MGW agent adds the value `MQPMO_SYNCPOINT` to any value that you can specify.

MGW sets default values for two WebSphere MQ message header fields: `messageType` defaults to `MQMT_DATAGRAM` and `putMessageOptions` defaults to `MQPMO_SYNCPOINT`.

MGW provides two default mappings between Oracle Database Advanced Queuing message properties and WebSphere MQ header fields.

One maps the Oracle Database Advanced Queuing message property `expiration`, representing the time-to-live of the message at the time the message becomes available in the queue, to the WebSphere MQ header field `expiry`, representing the time-to-live of the message. For outbound propagation, the value used for `expiry` is determined by subtracting the time the message was available in the queue from the `expiration`, converted to tenths of a second. Oracle Database Advanced Queuing value `NEVER` is mapped to `MQEI_UNLIMITED`. For inbound propagation, the value of `expiration` is simply `expiry` converted to seconds. WebSphere MQ value `MQEI_UNLIMITED` is mapped to `NEVER`.

The other default maps Oracle Database Advanced Queuing message property `priority` with the WebSphere MQ header field `priority`. It is described in [Table 20-2](#).

Table 20-2 Default Priority Mappings for Propagation

Propagation Type	Message System	Priority Values									
Outbound	Oracle Database Advanced Queuing	0	1	2	3	4	5	6	7	8	9
Outbound	WebSphere MQ	9	8	7	6	5	4	3	2	1	0
Inbound	Oracle Database Advanced Queuing	9	8	7	6	5	4	3	2	1	0
Inbound	WebSphere MQ	0	1	2	3	4	5	6	7	8	9

 **Note:**

For outbound propagation, Oracle Database Advanced Queuing priority values less than 0 are mapped to WebSphere MQ priority 9, and Oracle Database Advanced Queuing priority values greater than 9 are mapped to WebSphere MQ priority 0.

20.2.2 WebSphere MQ Outbound Propagation

If no message transformation is provided for outbound propagation, then the Oracle Database Advanced Queuing source queue payload type must be either `SYS.MGW_BASIC_MSG_T` or `RAW`. If a message transformation is specified, then the target ADT of the transformation must be `SYS.MGW_BASIC_MSG_T`, but the source ADT can be any ADT supported by Oracle Database Advanced Queuing.

If the Oracle Database Advanced Queuing queue payload is `RAW`, then the resulting WebSphere MQ message has the message body set to the value of the `RAW` bytes and, by default, the `format` field set to the value `"MGW_Byte"`.

If the Oracle Database Advanced Queuing queue payload or transformation target ADT is `SYS.MGW_BASIC_MSG_T`, then the message is mapped to a WebSphere MQ native message as follows:

- The WebSphere MQ fixed header fields are based on the internal Oracle Database Advanced Queuing message properties and the `SYS.MGW_BASIC_MSG_T.header` attribute of the canonical message, as described in ["WebSphere MQ Message Header Mappings"](#).

- If the canonical message has a `TEXT` body, then the WebSphere MQ format header field is set to `MQFMT_STRING` unless overridden by the header property `MGW_MQ_format`. The message body is treated as text.
- If the canonical message has a `RAW` body, then the WebSphere MQ format header field is set to `"MGW_Byte"` unless overridden by the header property `MGW_MQ_format`. The message body is treated as raw bytes.
- If the canonical message has both a `TEXT` and `RAW` body, then message conversion fails.
- If the canonical message has neither a `TEXT` nor `RAW` body, then no message body is set, and the WebSphere MQ format header field is `MQFMT_NONE`.
- If the canonical message has a `TEXT` body with both small and large values set (`SYS.MGW_BASIC_MSG_T.TEXT_BODY.small_value` and `SYS.MGW_BASIC_MSG_T.TEXT_BODY.large_value` not empty), then message conversion fails.
- If the canonical message has a `RAW` body with both small and large values set (`SYS.MGW_BASIC_MSG_T.RAW_BODY.small_value` and `SYS.MGW_BASIC_MSG_T.RAW_BODY.large_value` not empty), then message conversion fails.

If the job option `PreserveMessageID` is specified with a value of `TRUE`, then the `correlationId` field of the WebSphere message header will be set to the AQ source message identifier. The `correlationId` value will be a 24-byte value of the form `"AQMSGID:" + AQ_msgid` where `AQ_msgid` represents the 16-byte Database AQ message identifier.

20.2.3 WebSphere MQ Inbound Propagation

If no message transformation is provided for inbound propagation, then the Oracle Database Advanced Queuing destination queue payload type must be either `SYS.MGW_BASIC_MSG_T` or `RAW`. If a message transformation is specified, then the source ADT of the transformation must be `SYS.MGW_BASIC_MSG_T`, but the destination ADT can be any ADT supported by Oracle Database Advanced Queuing.

If the Oracle Database Advanced Queuing queue payload is `RAW` and the incoming WebSphere MQ message has a `format` of `MQFMT_STRING`, then message conversion fails. Otherwise the message body is considered as raw bytes and enqueued directly to the destination queue. If the number of bytes is greater than 32KB, then message conversion fails. The actual limit is 32512 bytes rather than 32767 bytes.

If the Oracle Database Advanced Queuing queue payload or transformation source ADT is `SYS.MGW_BASIC_MSG_T`, then the WebSphere MQ message is mapped to a `SYS.MGW_BASIC_MSG_T` message as follows:

- Specific WebSphere MQ header fields are mapped to Oracle Database Advanced Queuing message properties as previously described.
- The `SYS.MGW_BASIC_MSG_T.header` attribute of the canonical message is set to `{name, value}` pairs based on the WebSphere MQ header fields, as described in [Table 20-1](#). These values preserve the original content of the WebSphere MQ message header.
- If the WebSphere MQ `format` header field is `MQFMT_STRING`, then the WebSphere MQ message body is treated as text, and its value is mapped to

`SYS.MGW_BASIC_MSG_T.text_body`. For any other `format` value, the message body is treated as raw bytes, and its value is mapped to `SYS.MGW_BASIC_MSG_T.raw_body`.

 **See Also:**

"WebSphere MQ Message Header Mappings"

20.3 Message Conversion for TIB/Rendezvous

MGW regards a TIB/Rendezvous message as a set of fields and supplementary information. [Figure 20-4](#) shows how messages are converted between MGW and TIB/Rendezvous.

Figure 20-4 Message Conversion for TIB/Rendezvous

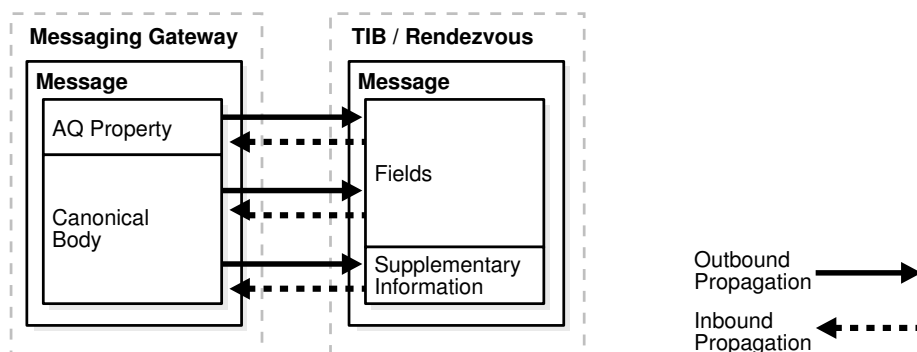

When a message conversion failure occurs, messages are moved to an exception queue (if one has been provided), so that MGW can continue propagation of the remaining messages in the source queue. In inbound propagation from TIB/Rendezvous, an exception queue is a registered subject.

All TIB/Rendezvous wire format datatypes for TIB/Rendezvous fields are supported, except for the datatypes with unsigned integers and the nested message type. User-defined custom datatypes are not supported in this release. If a message contains data of the unsupported datatypes, then a message conversion failure occurs when the message is processed. A message conversion failure results in moving the failed message from the source queue to the exception queue, if an exception queue is provided.

[Table 20-3](#) shows the datatype mapping used when MGW converts between a native TIB/Rendezvous message and the canonical ADT. For each supported TIB/Rendezvous wire format type, it shows the Oracle type used to store the data and the `DBMS_MGWMSG` constant that represents that type.

Table 20-3 TIB/Rendezvous Datatype Mapping

TIB/Rendezvous Wire Format	Oracle Type	ADT Field Type
Bool	NUMBER	TIBRVMSG_BOOL
F32	NUMBER	TIBRVMSG_F32
F64	NUMBER	TIBRVMSG_F64
I8	NUMBER	TIBRVMSG_I8
I16	NUMBER	TIBRVMSG_I16
I32	NUMBER	TIBRVMSG_I32
I64	NUMBER	TIBRVMSG_I64
U8	not supported	not supported
U16	not supported	not supported
U32	not supported	not supported
U64	not supported	not supported
IPADDR32	VARCHAR2	TIBRVMSG_IPADDR32
IPPORT16	NUMBER	TIBRVMSG_IPPORT16
DATETIME	DATE	TIBRVMSG_DATETIME
F32ARRAY	SYS.MGW_NUMBER_ARRAY_T	TIBRVMSG_F32ARRAY
F64ARRAY	SYS.MGW_NUMBER_ARRAY_T	TIBRVMSG_F64ARRAY
I8ARRAY	SYS.MGW_NUMBER_ARRAY_T	TIBRVMSG_I8ARRAY
I16ARRAY	SYS.MGW_NUMBER_ARRAY_T	TIBRVMSG_I16ARRAY
I32ARRAY	SYS.MGW_NUMBER_ARRAY_T	TIBRVMSG_I32ARRAY
I64ARRAY	SYS.MGW_NUMBER_ARRAY_T	TIBRVMSG_I64ARRAY
U8ARRAY	not supported	not supported
U16ARRAY	not supported	not supported
U32ARRAY	not supported	not supported
U64ARRAY	not supported	not supported
MSG	not supported	not supported
OPAQUE	RAW or BLOB	TIBRVMSG_OPAQUE
STRING	VARCHAR2 or CLOB	TIBRVMSG_STRING
XML	RAW or BLOB	TIBRVMSG_XML

For propagation between Oracle Database Advanced Queuing and TIB/Rendezvous, MGW provides direct support for the Oracle Database Advanced Queuing payload types RAW and SYS.MGW_TIBRV_MSG_T. To support any other Oracle Database Advanced Queuing payload type, you must supply a transformation.

20.3.1 AQ Message Property Mapping for TIB/Rendezvous

This section describes the mapping between Oracle Database AQ message properties and TIB/Rendezvous fields. This mapping is used to preserve Database AQ message

properties during outbound propagation, and set Database AQ message properties during inbound propagation.

Table 20-4 describes the Database AQ message properties supported using TIB/Rendezvous fields. The first column indicates the `DBMS_AQ.MESSAGE_PROPERTIES_T` field for the Database AQ message property. The second and third columns indicate the name and datatype used for the TIB/Rendezvous field. The last column indicates if the message property is supported for inbound and outbound propagation.

Table 20-4 TIB/Rendezvous and MGW Names for Oracle Database Advanced Queuing Message Properties

Oracle Database Advanced Queuing Message Property	MGW Name	TIB/Rendezvous Wire Format Datatype	Used For
priority	MGW_AQ_priority	TibrvMsg.I32	Outbound, Inbound
expiration	MGW_AQ_expiration	TibrvMsg.I32	Outbound, Inbound
delay	MGW_AQ_delay	TibrvMsg.I32	Outbound, Inbound
correlation	MGW_AQ_correlation	TibrvMsg.STRING	Outbound, Inbound
exception_queue	MGW_AQ_exception_queue	TibrvMsg.STRING	Outbound, Inbound
enqueue_time	MGW_AQ_enqueue_time	TibrvMsg.DATETIME	Outbound
original_msgid	MGW_AQ_original_msgid	TibrvMsg.OPAQUE	Outbound
msgid (1)	MGW_AQ_messageID	TibrvMsg.OPAQUE	Outbound

Notes on Table 20-4:

1. The `msgid` Database AQ property represents the Database AQ message identifier, rather than a particular field of the `DBMS_AQ.MESSAGE_PROPERTIES_T` record.

20.3.2 TIB/Rendezvous Outbound Propagation

If no propagation transformation is provided for outbound propagation, then the Oracle Database Advanced Queuing source queue payload type must be either `SYS.MGW_TIBRV_MSG_T` or `RAW`. If a propagation transformation is specified, then the target ADT of the transformation must be `SYS.MGW_TIBRV_MSG_T`, but the source ADT can be any ADT supported by Oracle Database Advanced Queuing.

If the Oracle Database Advanced Queuing queue payload or transformation target ADT is `SYS.MGW_TIBRV_MSG_T`, then:

- Every field in the source message is converted to a TIB/Rendezvous message field of the resulting TIB/Rendezvous message.
- If the `reply_subject` attribute is not `NULL`, then the reply subject supplementary information is set.
- The `send_subject` field is ignored.

If the Oracle Database Advanced Queuing queue payload is `RAW`, then:

- The resulting message contains a field named `MGW_RAW_MSG` with value `TibrvMsg.OPAQUE`. The field ID is set to 0.

If the job option `AQ_MsgProperties` is specified with a value of `TRUE`, then the MGW agent generates fields to preserve the Database AQ message properties in the TIB/Rendezvous message according to [Table 20-4](#).

If the `PreserveMessageID` job option is specified with a value of `TRUE`, then the Database AQ message identifier (`msgid`) is preserved in the TIB/Rendezvous message according to [Table 20-4](#).

20.3.3 TIB/Rendezvous Inbound Propagation

If no propagation transformation is provided for inbound propagation, then the Oracle Database Advanced Queuing destination queue payload type must be either `RAW` or `SYS.MGW_TIBRV_MSG_T`. If a propagation transformation is specified, then the target ADT of the transformation can be any ADT supported by Oracle Database Advanced Queuing, but the source ADT of the transformation must be `SYS.MGW_TIBRV_MSG_T`.

If the Oracle Database Advanced Queuing queue payload or transformation source ADT is `SYS.MGW_TIBRV_MSG_T`, then:

- Every field in the source TIB/Rendezvous message is converted to a field of the resulting message of the `SYS.MGW_TIBRV_MSG_T` type.
- The MGW agent extracts the send subject name from the source TIB/Rendezvous message and sets the `send_subject` attribute in `SYS.MGW_TIBRV_MSG_T`. The send subject name is usually the same as the subject name of the registered propagation source queue, but it might be different when wildcards are used.
- The MGW agent extracts the reply subject name from the source TIB/Rendezvous message, if it exists, and sets the `reply_subject` attribute in `SYS.MGW_TIBRV_MSG_T`.
- If the source TIB/Rendezvous message contains more than three large text fields (greater than 4000 bytes of text) or more than three large bytes fields (greater than 2000 bytes), then message conversion fails.

If the Oracle Database Advanced Queuing queue payload is `RAW`, then:

- The Oracle Database Advanced Queuing message payload is the field data if the source TIB/Rendezvous message has a field named `MGW_RAW_MSG` of type `TibrvMsg.OPAQUE` or `TibrvMsg.XML`. The field name and ID are ignored. If no such field exists or has an unexpected type, then a message conversion failure occurs.
- A message conversion failure occurs if the `RAW` data size is greater than 32KB. This is due to a restriction on the data size allowed for a bind variable. Also, the actual limit is 32512 rather than 32767.

If the job option `AQ_MsgProperties` is specified with a value of `TRUE`, then the MGW agent searches for fields in the original TIB/Rendezvous messages with reserved field names. [Table 20-4](#) shows the field name strings and the corresponding values used in the TIB/Rendezvous message.

If such fields exist, then the MGW agent uses the field value to set the corresponding Oracle Database Advanced Queuing message properties, instead of using the default values. If there is more than one such field with the same name, then only the first one is used. Such fields are removed from the resulting payload only if the Oracle Database Advanced Queuing queue payload is `RAW`. If a field with the reserved name does not have the expected datatype, then it causes a message conversion failure.

 **See Also:**

"DBMS_MGWMSG" in *Oracle Database PL/SQL Packages and Types Reference* for the value datatypes

20.4 JMS Messages

MGW propagates only JMS messages between Oracle JMS and non-Oracle JMS systems, without changing the message content. [Figure 20-5](#) shows JMS message propagation.

MGW supports only the standard JMS message types. It does not support:

- JMS provider extensions, because any such extensions would not be recognized by the destination JMS system. An attempt to propagate any such non-JMS message results in an error.
- User transformations for JMS propagation.
- Propagation of Logical Change Records (LCRs).

Figure 20-5 JMS Message Propagation

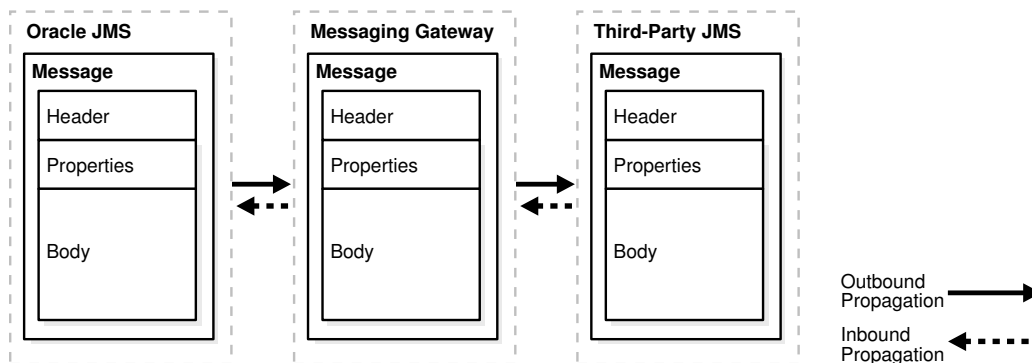

For the purposes of this discussion, a JMS message is a Java object of a class that implements one of the five JMS message interfaces. [Table 20-5](#) shows the JMS message interfaces and the corresponding Oracle JMS ADTs. The table also shows the interface, `javax.jms.Message`, which can be any one of the five specific types, and the corresponding generic Oracle JMS type `SYS.AQ$_JMS_MESSAGE`.

Table 20-5 Oracle JMS Message Conversion

JMS Message	ADT
<code>javax.jms.TextMessage</code>	<code>SYS.AQ\$_JMS_TEXT_MESSAGE</code>
<code>javax.jms.BytesMessage</code>	<code>SYS.AQ\$_JMS_BYTES_MESSAGE</code>
<code>javax.jms.MapMessage</code>	<code>SYS.AQ\$_JMS_MAP_MESSAGE</code>
<code>javax.jms.StreamMessage</code>	<code>SYS.AQ\$_JMS_STREAM_MESSAGE</code>

Table 20-5 (Cont.) Oracle JMS Message Conversion

JMS Message	ADT
<code>javax.jms.ObjectMessage</code>	<code>SYS.AQ\$_JMS_OBJECT_MESSAGE</code>
<code>javax.jms.Message</code>	<code>SYS.AQ\$_JMS_MESSAGE</code>

When a propagation job is activated, the MGW agent checks the Oracle Database Advanced Queuing payload type for the propagation source or destination. If the type is one of those listed in [Table 20-5](#) or `ANYDATA`, then message propagation is attempted. Otherwise an exception is logged and propagation is not attempted.

The MGW agent may add a JMS `String` property named `OracleMGW_OriginalMessageID` to the JMS message sent to the destination queue in order to preserve the original message identifier of the source message. This property is added if the `PreserveMessageID` job option is specified with a value of `TRUE`. It will also be added for any message moved to an exception queue upon a message conversion failure.

20.4.1 JMS Outbound Propagation

When dequeuing a message from an Oracle Database Advanced Queuing queue, Oracle JMS converts instances of the ADTs shown in [Table 20-5](#) into JMS messages. In addition it can convert instances of `ANYDATA` into JMS messages, depending on the content.

A queue with payload type `ANYDATA` can hold messages that do not map to a JMS message. MGW fails to dequeue such a message. An error is logged and propagation of messages from that queue does not continue until the message is removed.

20.4.2 JMS Inbound Propagation

Every message successfully dequeued using WebSphere MQ JMS is a JMS message. No message conversion is necessary prior to enqueueing using Oracle JMS. However, if the payload ADT of the propagation destination does not accept the type of the inbound message, then an exception is logged and an attempt is made to place the message in an exception queue. An example of such type mismatches is a JMS `TextMessage` and a queue payload type `SYS.AQ$_JMS_BYTES_MESSAGE`.

21

Monitoring Oracle Messaging Gateway

The following topics discuss means of monitoring the Oracle Messaging Gateway (MGW) agent, abnormal situations you may experience, several sources of information about Messaging Gateway errors and exceptions, and suggested remedies.

- [Oracle Messaging Gateway Log Files](#)
- [Monitoring the Oracle Messaging Gateway Agent Status](#)
- [Monitoring Oracle Messaging Gateway Propagation](#)
- [Oracle Messaging Gateway Agent Error Messages](#)

21.1 Oracle Messaging Gateway Log Files

Messaging Gateway agent status, history, and errors are recorded in Messaging Gateway log files. A different log file is created each time the Messaging Gateway agent is started. You should monitor the log file because any errors, configuration information read at startup time, or dynamic configuration information is written to the log.

The format of the log file name for the default agent is:

```
oramgw-hostname-timestamp-processid.log
```

The format of the log file name for a named agent is:

```
oramgw-AGENTNAME-hostname-timestamp-processid.log
```

By default the Messaging Gateway log file is in `ORACLE_HOME/mgw/log`. This location can be overridden by the parameter `log_directory` in the Messaging Gateway initialization file used by the agent, usually `mgw.ora`.

This section contains these topics:

- [Sample Oracle Messaging Gateway Log File](#)
- [Interpreting Exception Messages in an Oracle Messaging Gateway Log File](#)

21.1.1 Sample Oracle Messaging Gateway Log File

The following sample log file shows the Messaging Gateway agent starting. The sample log file shows that a messaging link, a registered foreign queue, a propagation job, and a schedule associated with the job have been added. The log file shows that the propagation job has been activated. The last line indicates that the Messaging Gateway is up and running and ready to propagate messages.

Example 21-1 Sample Messaging Gateway Log File

```
>>2007-01-16 15:04:49 MGW C-Bootstrap 0 LOG process-id=11080
Bootstrap program starting
>>2007-01-16 15:04:50 MGW C-Bootstrap 0 LOG process-id=11080
JVM created -- heapsize = 64
```

```

>>2007-01-16 15:04:53 MGW Engine 0 200 main
MGW Agent version: 11.1.0.0
>>2007-01-16 15:04:53 MGW AdminMgr 0 LOG main
Connecting to database using connect string = jdbc:oracle:oci:@INST1
>>2007-01-16 15:05:00 MGW Engine 0 200 main
MGW Component version: 11.1.0.3.0
>>2007-01-16 15:05:01 MGW Engine 0 200 main
MGW agent name: DEFAULT_AGENT, MGW job instance id:
273006EC6ED255F1E040578C6D021A8C, MGW database instance: 1
>>2007-01-16 15:05:09 MGW Engine 0 1 main
Agent is initializing.
>>2007-01-16 15:05:09 MGW Engine 0 23 main
The number of worker threads is set to 1.
>>2007-01-16 15:05:09 MGW Engine 0 22 main
The default polling interval is set to 5000ms.
>>2007-01-16 15:05:09 MGW MQD 0 LOG main
Creating MQSeries messaging link:
link : MQLINK
link type : Base Java interface
queue manager : my.queue.manager
channel : channell
host : my.machine
port : 1414
user :
ccdt url :
ssl cipherSuite :
connections : 1
inbound logQ : logq1
outbound logQ : logq2
>>2007-01-16 15:05:09 MGW Engine 0 4 main
Link MQLINK has been added.
>>2007-01-16 15:05:09 MGW Engine 0 7 main
Queue DESTQ@MQLINK has been registered; provider queue: MGWUSER.MYQUEUE.
>>2007-01-16 15:05:09 MGW Engine 0 9 main
Propagation Schedule JOB_AQ2MQ (MGWUSER.MGW_BASIC_SRC --> DESTQ@MQLINK) has been
added.
>>2007-01-16 15:05:09 MGW AQN 0 LOG main
Creating AQ messaging link:
link : oracleMgwAq
link type : native
database : INST1
user : MGWAGENT
connection type : JDBC OCI
connections : 1
inbound logQ : SYS.MGW_RECV_LOG
outbound logQ : SYS.MGW_SEND_LOG
>>2007-01-16 15:05:10 MGW Engine 0 19 main
MGW propagation job JOB_AQ2MQ has been activated.
>>2007-01-16 15:05:10 MGW Engine 0 14 main
MGW propagation job JOB_AQ2MQ (MGWUSER.MGW_BASIC_SRC --> DESTQ@MQLINK) has been
added.
>>2007-01-16 15:05:11 MGW Engine 0 2 main
Agent is up and running.

```

21.1.2 Interpreting Exception Messages in an Oracle Messaging Gateway Log File

Exception messages logged to the Messaging Gateway log file may include one or more linked exceptions, identified by `[Linked-exception]` in the log file. These are often

the most useful means of determining the cause of a problem. For instance, a linked exception could be a `java.sql.SQLException`, possibly including an Oracle error message, a PL/SQL stack trace, or both.

The following example shows entries from a Messaging Gateway log file when an invalid value (`bad_service_name`) was specified for the `database` parameter of `DBMS_MGWADM.CREATE_AGENT` or `DBMS_MGWADM.ALTER_AGENT`. This resulted in the Messaging Gateway agent being unable to establish database connections.

Example 21-2 Sample Exception Message

```
>>2003-07-22 15:27:26 MGW AdminMgr 0 LOG main
Connecting to database using connect string = jdbc:oracle:oci8:@BAD_SERVICE_NAME
>>2003-07-22 15:27:29 MGW Engine 0 EXCEPTION main
oracle.mgw.admin.MgwAdminException: [241] Failed to connect to database. SQL
error: 12154, connect string: jdbc:oracle:oci8:@BAD_SERVICE_NAME
[ ...Java stack trace here... ]
[Linked-exception]
java.sql.SQLException: ORA-12154: TNS:could not resolve the connect identifier
specified
[ ...Java stack trace here... ]
>>2003-07-22 15:27:29 MGW Engine 0 25 main
Agent is shutting down.
```

21.2 Monitoring the Oracle Messaging Gateway Agent Status

This section contains these topics:

- [MGW_GATEWAY View](#)
- [Oracle Messaging Gateway Irrecoverable Error Messages](#)
- [Other Oracle Messaging Gateway Error Conditions](#)

21.2.1 MGW_GATEWAY View

The `MGW_GATEWAY` view monitors the progress of the Messaging Gateway agent. Among the fields that can be used to monitor the agent are:

- `AGENT_NAME`
- `AGENT_INSTANCE`
- `AGENT_PING`
- `AGENT_STATUS`
- `LAST_ERROR_MSG`
- `SERVICE`

The `AGENT_STATUS` field shows the status of the agent. This column has the following possible values:

NOT_STARTED

Indicates that the agent is neither running nor scheduled to be run.

START_SCHEDULED

Indicates that the agent job is waiting to be run by the job scheduler.

STARTING

Indicates that the agent is in the process of starting.

INITIALIZING

Indicates that the agent has started and is reading configuration data.

RUNNING

Indicates that the agent is ready to propagate any available messages or process dynamic configuration changes.

SHUTTING_DOWN

Indicates that the agent is in the process of shutting down.

BROKEN

Indicates that, while attempting to start an agent process, Messaging Gateway has detected another agent already running. This situation should never occur under normal usage.

Querying the `AGENT_PING` field pings the Messaging Gateway agent. Its value is either `REACHABLE` or `UNREACHABLE`. An agent with status of `RUNNING` should almost always be `REACHABLE`.

The columns `LAST_ERROR_MSG`, `LAST_ERROR_DATE`, and `LAST_ERROR_TIME` give valuable information if an error in starting or running the Messaging Gateway agent occurs. `AGENT_INSTANCE` indicates the Oracle Database instance on which the Messaging Gateway instance was started.



See Also:

"`DBMS_MGWADM`" in *Oracle Database PL/SQL Packages and Types Reference* for more information on the `MGW_GATEWAY` view

21.2.2 Oracle Messaging Gateway Irrecoverable Error Messages

A status of `NOT_STARTED` in the `AGENT_STATUS` field of the `MGW_GATEWAY` view indicates that the Messaging Gateway agent is not running. If the `AGENT_STATUS` is `NOT_STARTED` and the `LAST_ERROR_MSG` field is not `NULL`, then the Messaging Gateway agent has encountered an irrecoverable error while starting or running. Check if a Messaging Gateway log file has been generated and whether it indicates any errors. If a log file is not present, then the Messaging Gateway agent process was probably not started.

This section describes the causes and solutions for some error messages that may appear in the `LAST_ERROR_MSG` field of the `MGW_GATEWAY` view. Unless indicated otherwise, the Messaging Gateway agent will not attempt to restart itself when one of these errors occurs.

ORA-01089: Immediate shutdown in progress - no operations are permitted

The Messaging Gateway agent has shut down because the `SHUTDOWN IMMEDIATE` command was used to shut down a running Oracle Database instance on which the

agent was running. The agent will restart itself on the next available database instance on which it is set up to run.

ORA-06520: PL/SQL: Error loading external library

The Messaging Gateway agent process was unable to start because the shared library was not loaded. This may be because the Java shared library was not in the library path. Verify that the library path in `listener.ora` has been set correctly.

ORA-28575: Unable to open RPC connection to external procedure agent

The Messaging Gateway agent was unable to start. It will attempt to start again automatically.

Possible causes include:

- The listener is not running. If you have modified `listener.ora`, then you must stop and restart the listener before the changes will take effect.
- Values in `tnsnames.ora`, `listener.ora`, or both are not correct.

In particular, `tnsnames.ora` must have a net service name entry of `MGW_AGENT`. This entry is not needed for Messaging Gateway on Windows. The SID value specified for `CONNECT_DATA` of the `MGW_AGENT` net service name in `tnsnames.ora` must match the `SID_NAME` value of the `SID_DESC` entry in `listener.ora`. If the `MGW_AGENT` net service name is set up for an [Inter-process Communication \(IPC\)](#) connection, then the `KEY` values for `ADDRESS` in `tnsnames.ora` and `listener.ora` must match. If the `names.default_domain` parameter for `sqlnet.ora` has been used to set a default domain, then that domain must be appended to the `MGW_AGENT` net service name in `tnsnames.ora`.

ORA-28576: Lost RPC connection to external procedure agent

The Messaging Gateway agent process ended prematurely. This may be because the process was stopped by an outside entity or because an internal error caused a malfunction. The agent will attempt to start again automatically. Check the Messaging Gateway log file to determine if further information is available. If the problem persists, then contact Oracle Support Services for assistance.

ORA-32830: Result code -2 returned by Messaging Gateway agent

An error occurred when the Messaging Gateway agent tried to read its initialization file, usually `mgw.ora`. Verify that the file is readable.

ORA-32830: Result code -3 returned by Messaging Gateway agent

An error occurred creating the Messaging Gateway log file. Verify that the log directory can be written to. The default location is `ORACLE_HOME/mgw/log`.

ORA-32830: Result code -8 returned by Messaging Gateway agent

An error occurred starting the Java Virtual Machine (JVM). Verify that:

- You are using the correct Java version
- Your operating system version and patch level are sufficient for the JDK version
- You are using a reasonable value for the JVM heap size

The heap size is specified by the `max_memory` parameter of `DBMS_MGWADM.ALTER_AGENT`

- On Windows platforms, verify the `MGW_PRE_PATH` set in `mgw.ora` contains the path to the correct JVM library (`jvm.dll`).

ORA-32830: Result code -12 returned by Messaging Gateway agent

An error occurred writing to the Messaging Gateway log file. Check the free disk space or any other issues that might result in file I/O problems.

ORA-32830: Result code -17 returned by Messaging Gateway agent

The JVM was successfully created but an error occurred trying to call the MGW Java agent program. Verify that the `CLASSPATH` set in `mgw.ora` is correct.

ORA-32830: Result code -19 returned by Messaging Gateway agent

The Messaging Gateway agent was configured to use a particular initialization file but that file does not exist. The `INITFILE` field of the `MGW_GATEWAY` view shows the full pathname of the file specified by the administrator. Either create that initialization file, or use `DBMS_MGWADM.ALTER_AGENT` to set `INITFILE` to another file or `NULL` to use the default initialization file.

ORA-32830: Result code -100 returned by Messaging Gateway agent

The Messaging Gateway agent JVM encountered a runtime exception or error on startup before it could write to the log file.

ORA-32830: Result code -101 returned by Messaging Gateway agent

An irrecoverable error caused the Messaging Gateway agent to shut down. Check the Messaging Gateway log file for further information. Verify that the values specified in `mgw.ora` are correct. Incorrect values can cause the Messaging Gateway agent to terminate due to unusual error conditions.

ORA-32830: Result code -102 returned by Messaging Gateway agent

The Messaging Gateway agent shut down because the version of file `ORACLE_HOME/mgw/jlib/mgw.jar` does not match the version of the Messaging Gateway PL/SQL packages. Verify that all Messaging Gateway components are from the same release.

ORA-32830: Result code -103 returned by Messaging Gateway agent

The Messaging Gateway agent shut down because the database instance on which it was running was shutting down. The agent should restart automatically, either on another instance if set up to do so, or when the instance that shut down is restarted.

ORA-32830: Result code -104 returned by Messaging Gateway agent

See previous error.

ORA-32830: Result code -105 returned by Messaging Gateway agent

The Messaging Gateway agent detected that it was running when it should not be. This should not happen. If it does, `AGENT_STATUS` will be `BROKEN` and the agent will shut down automatically. If you encounter this error:

- Terminate any Messaging Gateway agent process that may still be running. The process is usually named `extprocmgwextproc`.
- Run `DBMS_MGWADM.CLEANUP_GATEWAY(DBMS_MGWADM.CLEAN_STARTUP_STATE)`.

- Start the Messaging Gateway agent using `DBMS_MGWADM.STARTUP`.

ORA-32830: Result code -106 returned by Messaging Gateway agent

See previous error.

See Also:

"DBMS_MGWADM" in *Oracle Database PL/SQL Packages and Types Reference*

21.2.3 Other Oracle Messaging Gateway Error Conditions

This section discusses possible causes for `AGENT_STATUS` remaining `START_SCHEDULED` in `MGW_GATEWAY` view for an extended period.

Database Service Not Started

Messaging Gateway uses an Oracle Scheduler job to start the Messaging Gateway agent. Oracle Scheduler allows you to specify a database service under which a job should be run (service affinity). Messaging Gateway allows an administrator to configure the Messaging Gateway agent with a database service that will be used to configure the Scheduler job class associated with that agent.

When you shutdown a database Oracle stops all services to that database. You may need to manually restart the services when you start the database. If a Scheduler job is associated with a service then the job will not run until the service is started. If `AGENT_STATUS` for a Messaging Gateway agent remains `START_SCHEDULED` for an extended period that might indicate that the database service is disabled or no database instances associated with the service are running. Use the `MGW_GATEWAY` view, Oracle Scheduler views, and service views to determine how the agent was configured and the current state of the Scheduler job and database service.

Note:

[Oracle Messaging Gateway Agent Scheduler Job](#) for information about Oracle Scheduler objects used by Messaging Gateway.

Too Few Job Queue Processes

Messaging Gateway uses Oracle Scheduler to start the Messaging Gateway external process. When `AGENT_STATUS` is `START_SCHEDULED`, the Messaging Gateway agent Scheduler job is waiting to be run by the Scheduler. The Messaging Gateway job will not run until there is an available job process. Messaging Gateway holds its Scheduler job process for the lifetime of the Messaging Gateway agent session. If multiple Messaging Gateway agents have been started, each agent uses its own Scheduler job and require its own job process.

If the value of the database initialization parameter `JOB_QUEUE_PROCESSES` is zero, then no Oracle Scheduler jobs will run. If the value is non-zero, it effectively becomes the maximum number of Scheduler jobs and job queue jobs than can concurrently run.

If Messaging Gateway status remains `START_SCHEDULED` for an extended period of time, then it may indicate that the database has been started with a value for `JOB_QUEUE_PROCESSES` that is zero or is too low and that all job slaves are busy. Verify that the value is non-zero and that the database instance has been started with enough job queue processes so that one is available for each Messaging Gateway agent.

Scheduler Job Broken or Disabled

The Messaging Gateway agent status will remain `START_SCHEDULED` if the Oracle Scheduler job associated with a Messaging Gateway agent has become disabled or broken for some reason. To determine if this is the case, use the `DBA_SCHEDULER_JOBS` view to look at `STATE` field for the agent's Scheduler job. Normally the Scheduler job state will be `SCHEDULED` when the Messaging Gateway agent's Scheduler job is waiting to be run, or `RUNNING` when the Messaging Gateway agent is running. The agent's Scheduler job should not exist if the Messaging Gateway agent status is `NOT_STARTED`.

Check other Scheduler views, such as `DBA_SCHEDULER_JOB_RUN_DETAILS`, for additional information about the Messaging Gateway Scheduler jobs. Also check the `MGW_GATEWAY` view and the Messaging Gateway log file for any error messages that may indicate a problem.



Note:

[Oracle Messaging Gateway Agent Scheduler Job](#) for information about Oracle Scheduler objects used by Messaging Gateway

Oracle Real Application Clusters (Oracle RAC) Environment

If Messaging Gateway is being used in an Oracle RAC environment and the agent has been configured with a database service but no database instances are running that have the service enabled, then the Messaging Gateway `AGENT_STATUS` will remain `START_SCHEDULED` until the service is started on a running database instance.

21.3 Monitoring Oracle Messaging Gateway Propagation

Messaging Gateway [propagation](#) can be monitored using the `MGW_JOBS` view and the Messaging Gateway log file. The view provides information on propagated messages and errors that may have occurred during propagation attempts. The log file can be used to determine the cause of the errors.

Besides showing configuration information, the `MGW_JOBS` view also has dynamic information that can be used to monitor [message](#) propagation. Applicable fields include `STATUS`, `ENABLED`, `PROPAGATED_MSGS`, `EXCEPTIONQ_MSGS`, `FAILURES`, `LAST_ERROR_MSG`, `LAST_ERROR_DATE`, and `LAST_ERROR_TIME`.

The `STATUS` field indicates current status of the job. `READY` means that the job is ready for propagation (but only if the `ENABLED` field is `TRUE`). `RETRY` means that a propagation failure occurred but that propagation will be retried. `FAILED` means that the agent has stopped propagation for the job due to an unrecoverable error or the maximum number of consecutive propagation failures has been reached. `DELETE_PENDING` means job removal is pending due to `DBMS_MGWADM.REMOVE_JOB` being called but certain cleanup tasks pertaining to the job are still outstanding. `SUBSCRIBER_DELETE_PENDING` means that

`DBMS_MGWADM.REMOVE_SUBSCRIBER` has been called on an old style propagation job but certain cleanup tasks pertaining to the job are still outstanding.

The `ENABLED` field indicates whether the propagation job is currently enabled. `TRUE` indicates the job is enabled while `FALSE` indicates the job is disabled. No propagation will occur unless the job is enabled.

The `PROPAGATED_MSGS` field of the `MGW_JOBS` view indicates how many messages have been successfully propagated. This field is reset to zero when the Messaging Gateway agent is started.

If a Messaging Gateway propagation job has been configured with an [exception queue](#), then the Messaging Gateway agent will move messages to that exception queue the first time the Messaging Gateway agent encounters a propagation failure caused by a message conversion failure. A message conversion failure is indicated by `oracle.mgw.common.MessageException` in the Messaging Gateway log file. The `EXCEPTIONQ_MSGS` field indicates how many messages have been moved to the exception queue. This field is reset to zero when the Messaging Gateway agent is started.

If an error occurs during message propagation for a propagation job, a count is incremented in the `FAILURES` field. This field indicates the number of failures encountered since the last successful propagation of messages. Each time a failure occurs, an error message and the time it occurred will be shown by `LAST_ERROR_MSG`, `LAST_ERROR_DATE`, and `LAST_ERROR_TIME`. When the number of failures reaches sixteen, Messaging Gateway halts propagation attempts for this propagation job. To resume propagation attempts you must call `DBMS_MGWADM.RESET_JOB` for the propagation job.

If an error occurs, then examine the Messaging Gateway log file for further information.

See Also:

"`DBMS_MGWADM`" in *Oracle Database PL/SQL Packages and Types Reference*

21.4 Oracle Messaging Gateway Agent Error Messages

This section lists some of the most commonly occurring errors that are shown in the `LAST_ERROR_MSG` column of the `MGW_JOBS` view and logged to the Messaging Gateway agent log file. Also shown are some errors that require special action. When you notice that a failure has occurred, look at the linked exceptions in the log file to determine the root cause of the problem.

Two primary types of errors are logged to the Messaging Gateway agent log file:

- `oracle.mgw.common.MessageException`

This error type is logged when a message conversion failure occurs. The Messaging Gateway agent probably cannot propagate the message causing the failure, and the propagation job will eventually be stopped.

- `oracle.mgw.common.GatewayException`

This error type is logged when some failure other than message conversion occurs. Depending on the cause, the problem may fix itself or require user action.

[221] Failed to access < messaging_system > queue: < queue >

An error occurred while trying to access either an Oracle Database Advanced Queuing queue or a non-Oracle queue. Check the linked exception error code and message in the log file.

[241] Failed to connect to database. SQL error: < error >, connect string: < connect_string >

This is probably caused by incorrect MGW agent connection information specified for DBMS_MGWADM.CREATE_AGENT or DBMS_MGWADM.ALTER_AGENT. Either the Messaging Gateway agent user or password is incorrect or the database specifier (database parameter) is incorrect. Verify that the connection information is correct for the connection type used by the agent, JDBC OCI or JDBC Thin.

If the database parameter is NULL, then check the Messaging Gateway log file for the following Oracle linked errors:

```
ORA-01034: ORACLE not available
ORA-27101: shared memory realm does not exist
```

These two errors together indicate that the Messaging Gateway agent is attempting to connect to the database using a local IPC connection, but the ORACLE_SID value is not correct.

A local connection is used when the database parameter is set to NULL. If a local connection is desired, the correct ORACLE_SID value must be set in the Messaging Gateway agent process. This can be done by adding the following line to the MGW initialization file, usually mgw.ora:

```
set ORACLE_SID = sid_value
```

ORACLE_SID need not be set in the MGW initialization file if the database parameter is not NULL.

If setting ORACLE_SID in the MGW initialization file does not work, then the database parameter must be set to a value that is not NULL.

If the JDBC Thin connection is used, then the database parameter must be not NULL. If the JDBC Thin connection is used and the database parameter is a TNSNames alias, make sure that the oracle.net.tns_names Java property is set in the MGW initialization file. The property can be set by adding the following line to the MGW initialization file:

```
setJavaProp oracle.net.tns_admin=<directory containing tnsnames.ora>
```



Note:

"oracle.net.tns_admin" for more information

[415] Missing messages from source queue of job < job_name >

Possible causes include:

- The agent partially processed persistent messages that were dequeued by someone other than the Messaging Gateway agent.
- The propagation source queue was purged or re-created.
- A message was moved to the Oracle Database Advanced Queuing exception queue.

If this error occurs, then call procedure `CLEANUP_GATEWAY` in the `DBMS_MGWADM` package:

```
DBMS_MGWADM.CLEANUP_GATEWAY (  
    action => DBMS_MGWADM.RESET_SUB_MISSING_MESSAGE,  
    sarg => <job_name>);
```

The call takes effect only if the propagation job has encountered the missing message problem and the agent is running. The agent treats the missing messages as **nonpersistent** messages and continues processing the propagation job.



See Also:

"[Propagation Job Overview](#)" for more information on Messaging Gateway exception queues

[416] Missing log records in receiving log queue for job <job_name>

Possible causes include:

- Log records were dequeued from the log queues by someone other than the Messaging Gateway agent.
- The log queues were purged or re-created.

If this error occurs, then call procedure `CLEANUP_GATEWAY` in the `DBMS_MGWADM` package:

```
DBMS_MGWADM.CLEANUP_GATEWAY (  
    action => DBMS_MGWADM.RESET_SUB_MISSING_LOG_REC,  
    sarg => <job_name>);
```

The call takes effect only if the propagation job has encountered the missing log records problem and the agent is running.



Note:

Calling procedure `DBMS_MGWADM.CLEANUP_GATEWAY` may result in duplicated messages if the missing messages have already been propagated to the destination queue. Users should check the source and destination queues for any messages that exist in both places. If such messages exist, then they should be removed from either the source or destination queue before calling this procedure.

[417] Missing log records in sending log queue for job <job_name>

See previous error.

[421] WARNING: Unable to get connections to recover job <job_name>

This message is a warning message indicating that the Messaging Gateway agent failed to get a connection to recover the propagation job, because other propagation jobs are using them all. The agent will keep trying to get a connection until it succeeds.

If this message is repeated many times for a WebSphere MQ link, then increase the maximum number of connections used by the Messaging Gateway link associated with the propagation job.



See Also:

["Altering a Messaging System Link"](#)

[434] Failed to access queue <queue>; provider queue <queue>

This message indicates that a messaging system native queue cannot be accessed. The queue may have been registered by `DBMS_MGWADM.REGISTER_FOREIGN_QUEUE`, or it may be an Oracle Database Advanced Queuing queue. The linked exceptions should give more information.

Possible causes include:

- The foreign queue was registered incorrectly, or the Messaging Gateway link was configured incorrectly.
Verify configuration information. If possible, use the same configuration information to run a sample application of the non-Oracle messaging system.
- The non-Oracle messaging system is not accessible.
Check that the non-Oracle messaging system is running and can be accessed using the information supplied in the Messaging Gateway link.
- The Oracle Database Advanced Queuing queue does not exist. Perhaps the queue was removed after the Messaging Gateway propagation job was created.
Check that the Oracle Database Advanced Queuing queue still exists.

[436] LOW MEMORY WARNING: total memory = < >, free_mem = < >

The Messaging Gateway agent JVM is running low on memory. Java garbage collection will be invoked, but this may represent a JVM heap size that is too small. Use the `max_memory` parameter of `DBMS_MGWADM.ALTER_AGENT` to increase the JVM heap size. If the Messaging Gateway agent is running, then it must be restarted for this change to take effect.

[703] Failed to retrieve information for transformation <transformation_id>

The Messaging Gateway agent could not obtain all the information it needs about the [transformation](#). The transformation parameter of `DBMS_MGWADM.CREATE_JOB` must specify the name of the registered transformation and not the name of the transformation function.

Possible causes include:

- The transformation does not exist. Verify that the transformation has been created. You can see this from the following query performed as user SYS:

```
SELECT TRANSFORMATION_ID, OWNER FROM DBA_TRANSFORMATIONS;
```

- The wrong transformation is registered with Messaging Gateway. Verify that the transformation registered is the one intended.
- The Messaging Gateway agent user does not have `EXECUTE` privilege on the [object type](#) used for the `from_type` or the `to_type` of the transformation indicated in the exception.

It is not sufficient to grant `EXECUTE` to `MGW_AGENT_ROLE` and then grant `MGW_AGENT_ROLE` to the agent user. You must grant `EXECUTE` privilege on the object type directly to the agent user or to `PUBLIC`.

The following example shows such a case for the `from_type`. It also shows the use of linked exceptions for determining the precise cause of the error.

No EXECUTE Privilege on Object Type

```
Errors occurred during processing of job JOB_AQ2MQ_2
oracle.mgw.common.GatewayException: [703] Failed to retrieve information for
transformation mgwuser.SAMPLEADT_TO_MGW_BASIC_MSG
[...Java stack trace here...]
[Linked-exception]
java.sql.SQLException: "from_type" is null
[...Java stack trace here...]
```

[720] AQ payload type <type> not supported; queue: <queue>

The payload type of the Oracle Database Advanced Queuing queue used by a Messaging Gateway propagation job is not directly supported by Messaging Gateway. For non-JMS propagation, Messaging Gateway directly supports the payload types `RAW`, `SYS.MGW_BASIC_MSG_T` and `SYS.MGW_TIBRV_MSG_T`.

Possible actions include:

- Configure the Messaging Gateway propagation job to use a transformation that converts the queue payload type to a supported type.
- Remove the Messaging Gateway propagation job and create a new job that uses an Oracle Database Advanced Queuing queue with a supported payload type.

For [Java Message Service](#) (JMS) propagation, the Messaging Gateway propagation job must be removed and a new job created whose Oracle Database Advanced Queuing payload type is supported by [Oracle Java Message Service](#) (Oracle JMS). Transformations are not supported for JMS propagation.

[721] Transformation type <type> not supported; queue: <queue_name>, transform: <transformation>

A Messaging Gateway propagation job was configured with a transformation that uses an object type that is not one of the Messaging Gateway [canonical](#) types.

For an outbound job, the transformation `from_type` must be the Oracle Database Advanced Queuing payload type, and the `to_type` must be a Messaging Gateway canonical type. For an inbound job, the transformation `from_type` must be a Messaging Gateway canonical type and the `to_type` must be the Oracle Database Advanced Queuing payload type.

[722] Message transformation failed; queue: <queue_name>, transform: <transformation>

An error occurred while attempting execution of the transformation. ORA-25229 is typically thrown by Oracle Database Advanced Queuing when the transformation function raises a PL/SQL exception or some other Oracle error occurs when attempting to use the transformation.

Possible causes include:

- The Messaging Gateway agent user does not have `EXECUTE` privilege on the transformation function. This is illustrated in the following example.

It is not sufficient to grant `EXECUTE` to `MGW_AGENT_ROLE` and then grant `MGW_AGENT_ROLE` to the Messaging Gateway agent user. You must grant `EXECUTE` privilege on the transformation function directly to the Messaging Gateway agent user or to `PUBLIC`.

No EXECUTE Privilege on Transformation Function

```
Errors occurred during processing of job JOB_MQ2AQ_2
oracle.mgw.common.GatewayException: [722] Message transformation failed queue:
MGWUSER.DESTQ_SIMPLEADT, transform: MGWUSER.MGW_BASIC_MSG_TO_SIMPLEADT
[...Java stack trace here...]
[Linked-exception]
oracle.mgw.common.MessageException: [722] Message transformation failed;
queue: MGWUSER.DESTQ_SIMPLEADT, transform:
MGWUSER.MGW_BASIC_MSG_TO_SIMPLEADT
[...Java stack trace here...]
[Linked-exception]
java.sql.SQLException: ORA-25229: error on transformation of message msgid:
9749DB80C85B0BD4E03408002086745E
ORA-00604: error occurred at recursive SQL level 1
ORA-00904: invalid column name
[...Java stack trace here...]
```

- The transformation function does not exist, even though the registered transformation does. If the transformation function does not exist, it must be re-created.
- The Messaging Gateway agent user does not have `EXECUTE` privilege on the payload object type for the queue indicated in the exception.
It is not sufficient to grant `EXECUTE` to `MGW_AGENT_ROLE` and then grant `MGW_AGENT_ROLE` to the Messaging Gateway agent user. You must grant `EXECUTE` privilege on the object type directly to the Messaging Gateway agent user or to `PUBLIC`.
- The transformation function raised the error. Verify that the transformation function can handle all messages it receives.

[724] Message conversion not supported; to AQ payload type: <type>, from type: <type>

A Messaging Gateway propagation job is configured for inbound propagation where the canonical message type generated by the non-Oracle messaging system link is not compatible with the Oracle Database Advanced Queuing queue payload type. For example, propagation from a TIB/Rendezvous messaging system to an Oracle Database Advanced Queuing queue with a `SYS.MGW_BASIC_MSG_T` payload type, or propagation from WebSphere MQ to an Oracle Database Advanced Queuing queue with a `SYS.MGW_TIBRV_MSG_T` payload type.

Possible actions include:

- Configure the Messaging Gateway propagation job with a transformation that maps the canonical message type generated by the non-Oracle messaging link to the Oracle Database Advanced Queuing payload type.
- Remove the Messaging Gateway propagation job and create a new job whose Oracle Database Advanced Queuing queue payload type matches the canonical message type generated by the non-Oracle link.

[725] Text message not supported for RAW payload

A Messaging Gateway propagation job is configured for inbound propagation to an Oracle Database Advanced Queuing destination having a `RAW` payload type. A text message was received from the source (non-Oracle) queue resulting in a message conversion failure.

If support for text data is required, remove the Messaging Gateway propagation job and create a new job to an Oracle Database Advanced Queuing destination whose payload type supports text data.

[726] Message size <size> too large for RAW payload; maximum size is <size>

A Messaging Gateway propagation job is configured for inbound propagation to an Oracle Database Advanced Queuing destination having a `RAW` payload type. A message conversion failure occurred when a message containing a large `RAW` value was received from the source (non-Oracle) queue.

If large data support is required, remove the Messaging Gateway propagation job and create a new job to an Oracle Database Advanced Queuing destination whose payload type supports large data, usually in the form of an object type with a `BLOB` attribute.

[728] Message contains too many large (BLOB) fields

The source message contains too many fields that must be stored in `BLOB` types. `SYS.MGW_TIBRV_MSG_T` is limited to three `BLOB` fields. Reduce the number of large fields in the message, perhaps by breaking them into smaller fields or combining them into fewer large fields.

[729] Message contains too many large (CLOB) fields

The source message contains too many fields that contain a large text value that must be stored in a `CLOB`. `SYS.MGW_TIBRV_MSG_T` is limited to three `CLOB` fields. Reduce the number of large fields in the message, perhaps by breaking them into smaller fields or combining them into fewer large fields.

[805] MQSeries Message error while enqueueing to queue: <queue>

WebSphere MQ returned an error when an attempt was made to put a message in a WebSphere MQ queue. Check the linked exception error code and message in the log file. Consult WebSphere MQ documentation.

22

Using ANYDATA Queues for User Messages

The following topics describe how to use and manage Oracle Database Advanced Queuing when enqueueing and propagating. It describes `ANYDATA` queues and user messages.

Oracle Streams uses queues of type `ANYDATA` to store three types of messages:

- Captured [logical change record \(LCR\)](#)
This message type, produced by an Oracle Streams capture process, is not discussed in this guide.
- User-enqueued LCR
This is a message containing an LCR that was enqueued into a non-sharded queue by a user or application.
- User message
This is a non-LCR message created and enqueued into a sharded or non-sharded queue by a user or application.

All three types of messages can be used for information sharing within a single database or between databases.

Topics:

- [ANYDATA Queues and User Messages](#)
- [Message Propagation and ANYDATA Queues](#)
- [Enqueueing User Messages in ANYDATA Queues](#)
- [Dequeuing User Messages from ANYDATA Queues](#)
- [Propagating User Messages from ANYDATA Queues to Typed Queues](#)
- [Propagating User-Enqueued LCRs from ANYDATA Queues to Typed Queues](#)

See Also:

- *Oracle Database PL/SQL Packages and Types Reference* for more information about the `ANYDATA` type
- "Streams Capture Process" in *Oracle Streams Concepts and Administration*

22.1 ANYDATA Queues and User Messages

This section contains these topics:

- [ANYDATA Wrapper for User Messages Payloads](#)
- [Programmatic Interfaces for Enqueue and Dequeue of User Messages](#)



See Also:

Oracle Streams Concepts and Administration

22.1.1 ANYDATA Wrapper for User Messages Payloads

You can wrap almost any type of payload in an `ANYDATA` payload with the `Convertdata_type` static functions of the `ANYDATA` type, where `data_type` is the type of object to wrap. These functions take the object as input and return an `ANYDATA` object.

The following datatypes cannot be wrapped in an `ANYDATA` wrapper:

- Nested table
- `NCLOB`
- `ROWID` and `UROWID`

The following datatypes can be directly wrapped in an `ANYDATA` wrapper, but they cannot be present in a user-defined type payload wrapped in an `ANYDATA` wrapper:

- `CLOB`
- `BLOB`
- `BFILE`
- `VARRAY`



See Also:

Oracle Database PL/SQL Packages and Types Reference for more information about the `ANYDATA` type

22.1.2 Programmatic Interfaces for Enqueue and Dequeue of User Messages

Your applications can use the following programmatic interfaces to enqueue user messages into an `ANYDATA` queue and dequeue user messages from an `ANYDATA` queue:

- `PL/SQL` (`DBMS_AQ` package)
- [Java Message Service \(JMS\)](#)
- `OCI`

The following sections provide information about using these interfaces to enqueue user messages into and dequeue user messages from an `ANYDATA` queue.

 **See Also:**

[Oracle Database Advanced Queuing: Programmatic Interfaces](#) for more information about these programmatic interfaces

22.1.2.1 Enqueuing User Messages Using PL/SQL

To enqueue a user message containing an LCR into an `ANYDATA` queue using PL/SQL, first create the LCR to be enqueued. You use the constructor for the `SYS.LCR$_ROW_RECORD` type to create a row LCR, and you use the constructor for the `SYS.LCR$_DDL_RECORD` type to create a DDL LCR. Then you use the `ANYDATA.ConvertObject` function to convert the LCR into an `ANYDATA` payload and enqueue it using the `DBMS_AQ.ENQUEUE` procedure.

To enqueue a user message containing a non-LCR object into an `ANYDATA` queue using PL/SQL, you use one of the `ANYDATA.Convert*` functions to convert the object into an `ANYDATA` payload and enqueue it using the `DBMS_AQ.ENQUEUE` procedure.

 **See Also:**

- [Enqueuing Messages](#)
- [Oracle Streams Messaging Examples](#)
- *Oracle Streams Concepts and Administration*

22.1.2.2 Enqueuing User Messages Using OCI or JMS

To enqueue a user message containing an LCR into an `ANYDATA` queue using JMS or OCI, you must represent the LCR in XML format. To construct an LCR, use the `oracle.xdb.XMLType` class. LCRs are defined in the `SYS` schema. The LCR schema must be loaded into the `SYS` schema using the `catxldr.sql` script in `ORACLE_HOME/rdbms/admin`.

To enqueue a message using OCI, perform the same actions that you would to enqueue a message into a typed queue. To enqueue a message using JMS, a user must have `EXECUTE` privilege on the `DBMS_AQ`, `DBMS_AQIN` and `DBMS_AQJMS` packages.

 **Note:**

Enqueue of JMS types and XML types does not work with `ANYDATA` queues unless you call `DBMS_AQADM.ENABLE_JMS_TYPES(queue_table_name)` after `DBMS_STREAMS_ADM.SET_UP_QUEUE(queue_name)`. Enabling a queue for these types may affect import/export of the queue table.

A non-LCR user message can be a message of any user-defined type or a JMS type. The JMS types include the following:

- `javax.jms.TextMessage`

- `javax.jms.MapMessage`
- `javax.jms.StreamMessage`
- `javax.jms.ObjectMessage`
- `javax.jms.BytesMessage`

When using user-defined types, you must generate the Java class for the message using `Jpublisher`, which implements the `ORADData` interface. To enqueue a message into an ANYDATA queue, you can use methods `QueueSender.send` or `TopicPublisher.publish`.

See Also:

- ["Enqueuing and Dequeuing Messages Using JMS"](#)
- *Oracle XML DB Developer's Guide* for more information about representing messages in XML format
- *Oracle Database Advanced Queuing Java API Reference* for more information about the `oracle.jms` Java package
- The `OCI AQenq` function in the *Oracle Call Interface Programmer's Guide* for more information about enqueueing messages using OCI

22.1.2.3 Dequeuing User Messages Using PL/SQL

To dequeue a user message from an ANYDATA queue using PL/SQL, you use the `DBMS_AQ.DEQUEUE` procedure and specify ANYDATA as the payload. The user message can contain an LCR or another type of object.

See Also:

- ["Dequeuing Messages"](#)

22.1.2.4 Dequeuing User Messages Using OCI or JMS

In an ANYDATA queue, user messages containing LCRs in XML format are represented as `oracle.xdb.XMLType`. Non-LCR messages can be any user-defined type or a JMS type.

To dequeue a message from an ANYDATA queue using JMS, you can use methods `QueueReceiver`, `TopicSubscriber`, or `TopicReceiver`. Because the queue can contain different types of objects wrapped in ANYDATA wrappers, you must register a list of SQL types and their corresponding Java classes in the type map of the [JMS session](#). JMS types are already preregistered in the type map.

For example, suppose a queue contains user-enqueued LCR messages represented as `oracle.xdb.XMLType` and non-LCR messages of type `person` and `address`. The classes `JPerson.java` and `JAddress.java` are the `ORADData` mappings for `person` and `address`, respectively. Before dequeuing the message, the type map must be populated as follows:

```

java.util.Map map = ((AQjmsSession)q_sess).getTypeMap();

map.put("SCOTT.PERSON", Class.forName("JPerson"));
map.put("SCOTT.ADDRESS", Class.forName("JAddress"));
map.put("SYS.XMLTYPE", Class.forName("oracle.xdb.XMLType")); // For LCRs

```

When using a `messageSelector` with a `QueueReceiver` or `TopicPublisher`, the selector can contain any SQL expression that has a combination of one or more of the following:

- **JMS message** header fields or properties

These include `JMSPriority`, `JMSCorrelationID`, `JMSType`, `JMSXUserI`, `JMSXAppID`, `JMSXGroupID`, and `JMSXGroupSeq`. An example of a JMS message field `messageSelector` is:

```
JMSPriority < 3 AND JMSCorrelationID = 'Fiction'
```

- **User-defined message** properties

An example of a user-defined message properties `messageSelector` is:

```
color IN ('RED', 'BLUE', 'GREEN') AND price < 30000
```

- **PL/SQL functions**

An example of a PL/SQL function `messageSelector` is:

```
hr.GET_TYPE(tab.user_data) = 'HR.EMPLOYEES'
```

To dequeue a message from an ANYDATA queue using OCI, perform the same actions that you would to dequeue a message from a typed queue.

See Also:

- ["Enqueuing and Dequeuing Messages Using JMS"](#)
- *Oracle XML DB Developer's Guide* for more information about representing messages in XML format
- *Oracle Database Advanced Queuing Java API Reference* for more information about the `oracle.jms` Java package
- The `OCIAQdeq` function in the *Oracle Call Interface Programmer's Guide* for more information about dequeuing messages using OCI

22.2 Message Propagation and ANYDATA Queues

ANYDATA queues can interoperate with typed queues. [Table 22-1](#) shows the types of propagation possible between queues.

Table 22-1 Propagation Between Different Types of Queues

Source Queue	Destination Queue	Transformation
ANYDATA	ANYDATA	None

Table 22-1 (Cont.) Propagation Between Different Types of Queues

Source Queue	Destination Queue	Transformation
Typed	ANYDATA	Implicit Note: Propagation is possible only if the messages in the typed queue meet the restrictions outlined in "Object Type Support".
ANYDATA	Typed	Requires a rule to filter messages and a user-defined transformation . Only messages containing a payload of the same type as the typed queue can be propagated to the typed queue.
Typed	Typed	Follows Oracle Database Advanced Queuing rules

 **Note:**

Propagations cannot propagate user-enqueued ANYDATA messages that encapsulate payloads of object types, varrays, or nested tables between databases with different character sets. Propagations can propagate such messages between databases with the same character set.

Although you cannot use [Simple Object Access Protocol](#) (SOAP) to interact directly with an ANYDATA queue, you can use SOAP by propagating messages between an ANYDATA queue and a typed queue. If you want to enqueue a message into an ANYDATA queue using SOAP, you must first configure propagation from a typed queue to the ANYDATA queue. Then you can use SOAP to enqueue a message into the typed queue. The message is propagated automatically from the typed queue to the ANYDATA queue.

If you want to use SOAP to dequeue a message that is in an ANYDATA queue, then you can configure propagation from the ANYDATA queue to a typed queue. The message is propagated automatically from the ANYDATA queue to the typed queue, where it is available for access using SOAP.

 **See Also:**

Oracle Streams Concepts and Administration

22.3 Enqueuing User Messages in ANYDATA Queues

This section provides examples of enqueueing messages into an ANYDATA queue. The examples assume you are in a SQL*Plus testing environment with access to two databases named db01 and db02. The first few examples prepare the testing environment for the other examples in this chapter.

In [Example 22-1](#), you connect as a user with administrative privileges at databases db01 and db02 to create administrator user `strmadmin` and to grant `EXECUTE` privilege on the `DBMS_AQ` package to sample schema user `oe`.

In [Example 22-2](#), you connect to db01 as strmadmin to create ANYDATA queue oe_queue_any. The oe user is configured automatically as a secure user of the oe_queue_any queue and is given ENQUEUE and DEQUEUE privileges on the queue.

In [Example 22-3](#), you add a subscriber to the oe_queue_any queue. This subscriber performs explicit dequeues of messages. The ADD_SUBSCRIBER procedure will automatically create an AQ_AGENT.

In [Example 22-4](#), you associate the oe user with the local_agent agent.

In [Example 22-5](#), you connect to database db01 as user oe to create an enqueue procedure. It takes an object of ANYDATA type as an input parameter and enqueues a message containing the payload into an existing ANYDATA queue.

In [Example 22-6](#), you use procedure oe.enq_proc to enqueue a message of type VARCHAR2 into an ANYDATA queue.

In [Example 22-7](#), you use procedure oe.enq_proc to enqueue a message of type NUMBER into an ANYDATA queue.

In [Example 22-8](#), you use procedure oe.enq_proc to enqueue a user-defined type message into an ANYDATA queue.



See Also:

"Viewing the Contents of User-Enqueued Events in a Queue" in *Oracle Streams Concepts and Administration*

Example 22-1 Creating ANYDATA Users

```
GRANT EXECUTE ON DBMS_AQ TO oe;
CREATE USER strmadmin IDENTIFIED BY strmadmin DEFAULT TABLESPACE example;
GRANT DBA TO strmadmin;
GRANT EXECUTE ON DBMS_STREAMS_ADM TO strmadmin;
GRANT EXECUTE ON DBMS_TRANSFORM TO strmadmin;
```

Example 22-2 Creating an ANYDATA Queue

```
CONNECT strmadmin;
Enter password: password
BEGIN
  DBMS_STREAMS_ADM.SET_UP_QUEUE(
    queue_table => 'oe_qtab_any',
    queue_name  => 'oe_queue_any',
    queue_user  => 'oe');
END;
/
```

Example 22-3 Adding a Subscriber to the ANYDATA Queue

```
DECLARE
  subscriber SYS.AQ$AGENT;
BEGIN
  subscriber := SYS.AQ$AGENT('LOCAL_AGENT', NULL, NULL);
  SYS.DBMS_AQADM.ADD_SUBSCRIBER(
    queue_name => 'strmadmin.oe_queue_any',
    subscriber => subscriber);
```

```
END;
/
```

Example 22-4 Associating a User with an AQ_AGENT

```
BEGIN
  DBMS_AQADM.ENABLE_DB_ACCESS(
    agent_name => 'local_agent',
    db_username => 'oe');
END;
/
```

Example 22-5 Creating an Enqueue Procedure

```
set echo off
set verify off
ACCEPT password CHAR PROMPT 'Enter the password for OE: ' HIDE
CONNECT oe/&password@db01;

set echo on
CREATE PROCEDURE oe.enq_proc (payload ANYDATA) IS
  enqopt      DBMS_AQ.ENQUEUE_OPTIONS_T;
  mprop       DBMS_AQ.MESSAGE_PROPERTIES_T;
  enq_msgid   RAW(16);
BEGIN
  mprop.SENDER_ID := SYS.AQ$_AGENT('LOCAL_AGENT', NULL, NULL);
  DBMS_AQ.ENQUEUE(
    queue_name      => 'strmadmin.oe_queue_any',
    enqueue_options => enqopt,
    message_properties => mprop,
    payload         => payload,
    msgid          => enq_msgid);
END;
/
```

Example 22-6 Enqueuing a VARCHAR2 Message into an ANYDATA Queue

```
EXEC oe.enq_proc(ANYDATA.ConvertVarchar2('Chemicals - SW'));
COMMIT;
```

Example 22-7 Enqueuing a NUMBER Message into an ANYDATA Queue

```
EXEC oe.enq_proc(ANYDATA.ConvertNumber('16'));
COMMIT;
```

Example 22-8 Enqueuing a User-Defined Type Message into an ANYDATA Queue

```
BEGIN
  oe.enq_proc(ANYDATA.ConvertObject(oe.cust_address_typ(
    '1646 Brazil Blvd', '361168', 'Chennai', 'Tam', 'IN')));
END;
/
COMMIT;
```

22.4 Dequeuing User Messages from ANYDATA Queues

This section provides examples of dequeuing messages from an ANYDATA queue. The examples assume that you have completed the examples in "[Enqueuing User Messages in ANYDATA Queues](#)".

To dequeue messages, you must know the [consumer](#) of the messages. To find the consumer for the messages in a queue, connect as the owner of the queue and query the `AQ$queue_table_name` view, where `queue_table_name` is the name of the [queue table](#) containing the queue.

In [Example 22-9](#), you connect to database `db01` as `strmadmin`, the owner of queue `oe_queue_any`, and perform a query on the `AQ$OE_QTAB_ANY` view. The query returns three rows, with `LOCAL_AGENT` as the `CONSUMER_NAME` in each row.

In [Example 22-10](#), you connect to database `db01` as user `oe` to create a dequeue procedure that takes as an input the consumer of the messages you want to dequeue, dequeues messages of `oe.cust_address_typ`, and prints the contents of the messages.

In [Example 22-11](#), you use procedure `oe.get_cust_address`, created in [Example 22-10](#), specifying `LOCAL_AGENT` as the consumer.

The example returns:

```
****
Message TYPE is: SYS.VARCHAR2
****
Message TYPE is: SYS.NUMBER
****
Message TYPE is: OE.CUST_ADDRESS_TYP
**** CUSTOMER ADDRESS ****
1646 Brazil Blvd
361168
Chennai
Tam
IN
No more messages
```

Example 22-9 Determining the Consumer of Messages in a Queue

```
CONNECT strmadmin;
Enter password: password
SELECT MSG_ID, MSG_STATE, CONSUMER_NAME FROM AQ$OE_QTAB_ANY;
```

Example 22-10 Creating a Dequeue Procedure for an ANYDATA Queue

```
CONNECT oe; -- @db01
Enter password: password

CREATE PROCEDURE oe.get_cust_address (
consumer IN VARCHAR2) AS
  address      OE.CUST_ADDRESS_TYP;
  deq_address  ANYDATA;
  msgid        RAW(16);
  deqopt       DBMS_AQ.DEQUEUE_OPTIONS_T;
  mprop        DBMS_AQ.MESSAGE_PROPERTIES_T;
  new_addresses BOOLEAN := TRUE;
  next_trans   EXCEPTION;
  no_messages  EXCEPTION;
  pragma exception_init (next_trans, -25235);
  pragma exception_init (no_messages, -25228);
  num_var      pls_integer;
BEGIN
  deqopt.consumer_name := consumer;
  deqopt.wait := 1;
  WHILE (new_addresses) LOOP
  BEGIN
```

```

DBMS_AQ.DEQUEUE(
  queue_name          => 'strmadmin.oe_queue_any',
  dequeue_options    => deqopt,
  message_properties => mprop,
  payload            => deq_address,
  msgid              => msgid);
deqopt.navigation := DBMS_AQ.NEXT;
DBMS_OUTPUT.PUT_LINE('****');
IF (deq_address.GetTypeName() = 'OE.CUST_ADDRESS_TYP') THEN
  DBMS_OUTPUT.PUT_LINE('Message TYPE is: ' || deq_address.GetTypeName());
  num_var := deq_address.GetObject(address);
  DBMS_OUTPUT.PUT_LINE(' **** CUSTOMER ADDRESS **** ');
  DBMS_OUTPUT.PUT_LINE(address.street_address);
  DBMS_OUTPUT.PUT_LINE(address.postal_code);
  DBMS_OUTPUT.PUT_LINE(address.city);
  DBMS_OUTPUT.PUT_LINE(address.state_province);
  DBMS_OUTPUT.PUT_LINE(address.country_id);
ELSE
  DBMS_OUTPUT.PUT_LINE('Message TYPE is: ' || deq_address.GetTypeName());
END IF;
COMMIT;
EXCEPTION
  WHEN next_trans THEN
    deqopt.navigation := DBMS_AQ.NEXT_TRANSACTION;
  WHEN no_messages THEN
    new_addresses := FALSE;
    DBMS_OUTPUT.PUT_LINE('No more messages');
END;
END LOOP;
END;
/

```

Example 22-11 Dequeuing Messages from an ANYDATA Queue

```

SET SERVEROUTPUT ON SIZE 100000
EXEC oe.get_cust_address('LOCAL_AGENT');

```

22.5 Propagating User Messages from ANYDATA Queues to Typed Queues

This section provides examples showing how to propagate non-LCR user messages between an ANYDATA queue and a typed queue.

Note:

The examples in this section assume that you have completed the examples in ["Enqueuing User Messages in ANYDATA Queues"](#).

The first few examples set up propagation from the ANYDATA queue `oe_queue_any`, created in [Example 22-2](#), to a typed queue in database `db02`. In [Example 22-12](#), you connect as sample schema user `oe` to grant `EXECUTE` privilege on `oe.cust_address_typ` at databases `db01` and `db02` to administrator user `strmadmin`.

In [Example 22-13](#), you connect to database `db02` as administrator user `strmadmin` and create a destination queue of type `oe.cust_address_typ`.

In [Example 22-14](#), you connect to database db01 as administrator user `strmadmin` to create a database link from db01 to db02.

In [Example 22-15](#), you create function `any_to_cust_address_typ` in the `strmadmin` schema at db01 that takes an ANYDATA payload containing an `oe.cust_address_typ` object and returns an `oe.cust_address_typ` object.

In [Example 22-16](#), you create a transformation at db01 using the `DBMS_TRANSFORM` package.

In [Example 22-17](#), you create a subscriber for the typed queue. The subscriber must contain a rule that ensures that only messages of the appropriate type are propagated to the destination queue.

In [Example 22-18](#), you schedule propagation between the ANYDATA queue at db01 and the typed queue at db02.

In [Example 22-19](#), you connect to database db01 as sample schema user `oe` to enqueue a message of `oe.cust_address_typ` type wrapped in an ANYDATA wrapper. This example uses the enqueue procedure `oe.enq_proc` created in [Example 22-5](#).

After allowing some time for propagation, in [Example 22-20](#) you query queue table `AQ$OE_QTAB_ADDRESS` at db02 to view the propagated message.

The example returns one message for `ADDRESS_AGENT_REMOTE`:

MSG_ID	MSG_STATE	CONSUMER_NAME
EBEF5CACC4665A6FE030578CE70A370D	READY	ADDRESS_AGENT_REMOTE

1 row selected.

See Also:

- ["Message Propagation and ANYDATA Queues"](#) for more information about propagation between ANYDATA and typed queues.
- [Oracle Messaging Gateway Message Conversion](#) for more information about transformations during propagation.

Example 22-12 Granting EXECUTE Privilege on a Type

```
CONNECT oe; -- @db01
Enter password: password

GRANT EXECUTE ON oe.cust_address_typ TO strmadmin;
CONNECT oe; -- @db02
Enter password: password

GRANT EXECUTE ON oe.cust_address_typ TO strmadmin;
```

Example 22-13 Creating a Typed Destination Queue

```
CONNECT strmadmin;
Enter password: password

BEGIN
```

```

DBMS_AQADM.CREATE_QUEUE_TABLE(
  queue_table      => 'strmadmin.oe_qtab_address',
  queue_payload_type => 'oe.cust_address_typ',
  multiple_consumers => true);
DBMS_AQADM.CREATE_QUEUE(
  queue_name       => 'strmadmin.oe_queue_address',
  queue_table      => 'strmadmin.oe_qtab_address');
DBMS_AQADM.START_QUEUE(
  queue_name       => 'strmadmin.oe_queue_address');
END;
/

```

Example 22-14 Creating a Database Link

```

CONNECT strmadmin;
Enter password: password

CREATE DATABASE LINK db02 CONNECT TO strmadmin IDENTIFIED BY password
  USING 'db02';

```

Example 22-15 Creating a Function to Extract a Typed Object from an ANYDATA Object

```

CONNECT strmadmin;
Enter password: password

CREATE FUNCTION strmadmin.any_to_cust_address_typ(in_any IN ANYDATA)
RETURN OE.CUST_ADDRESS_TYP
AS
  address      OE.CUST_ADDRESS_TYP;
  num_var      NUMBER;
  type_name    VARCHAR2(100);
BEGIN
  type_name := in_any.GetTypeName();
  IF (type_name = 'OE.CUST_ADDRESS_TYP') THEN
    num_var := in_any.GetObject(address);
    RETURN address;
  ELSE
    raise_application_error(-20101, 'Conversion failed - ' || type_name);
  END IF;
END;
/

```

Example 22-16 Creating an ANYDATA to Typed Object Transformation

```

BEGIN
  DBMS_TRANSFORM.CREATE_TRANSFORMATION(
    schema      => 'strmadmin',
    name        => 'anytoaddress',
    from_schema => 'SYS',
    from_type   => 'ANYDATA',
    to_schema   => 'oe',
    to_type     => 'cust_address_typ',
    transformation => 'strmadmin.any_to_cust_address_typ(source.user_data)');
END;
/

```

Example 22-17 Creating Subscriber ADDRESS_AGENT_REMOTE

```

DECLARE
  subscriber SYS.AQ$_AGENT;
BEGIN

```

```

subscriber := SYS.AQ$_AGENT ('ADDRESS_AGENT_REMOTE',
                             'STRMADMIN.OE_QUEUE_ADDRESS@DB02',
                             0);
DBMS_AQADM.ADD_SUBSCRIBER(
  queue_name    => 'strmadmin.oe_queue_any',
  subscriber    => subscriber,
  rule          => 'TAB.USER_DATA.GetTypeName()='OE.CUST_ADDRESS_TYP'',
  transformation => 'strmadmin.anytoaddress');
END;
/

```

Example 22-18 Scheduling Propagation from an ANYDATA Queue to a Typed Queue

```

BEGIN
  DBMS_AQADM.SCHEDULE_PROPAGATION(
    queue_name    => 'strmadmin.oe_queue_any',
    destination   => 'db02');
END;
/

```

Example 22-19 Enqueuing a Typed Message in an ANYDATA Wrapper

```

CONNECT oe;
Enter password: password

BEGIN
  oe.enq_proc(ANYDATA.ConvertObject(oe.cust_address_typ(
    '1668 Chong Tao', '111181', 'Beijing', NULL, 'CN')));
END;
/
COMMIT;

```

Example 22-20 Viewing the Propagated Message

```

CONNECT strmadmin;
Enter password: password

SELECT MSG_ID, MSG_STATE, CONSUMER_NAME FROM AQ$_OE_QTAB_ADDRESS;

```

22.6 Propagating User-Enqueued LCRs from ANYDATA Queues to Typed Queues

You can propagate user-enqueued LCRs to an appropriate typed queue, but propagation of captured LCRs to a typed queue is not supported.

To propagate user-enqueued LCRs from an ANYDATA queue to a typed queue, you complete the same steps as you do for non-LCR messages, but Oracle supplies the transformation functions. You can use the following functions in the `DBMS_STREAMS` package to transform LCRs in ANYDATA queues to messages in typed queues:

- `CONVERT_ANYDATA_TO_LCR_ROW` transforms an ANYDATA payload containing a row LCR into a `SYS.LCR$_ROW_RECORD` payload.
- `CONVERT_ANYDATA_TO_LCR_DDL` transforms an ANYDATA payload containing a DDL LCR into a `SYS.LCR$_DDL_RECORD` payload.

The examples in this section set up propagation of row LCRs from an ANYDATA queue named `oe_queue_any` to a typed queue of type `SYS.LCR$_ROW_RECORD` named

oe_queue_lcr. The source queue oe_queue_any is at database db01, and the destination queue oe_queue_lcr is created at database db02 in [Example 22-21](#).

 **Note:**

The examples in this section assume you have already run the examples in the preceding sections of this chapter.

In [Example 22-22](#), you connect to db01 as administrator user strmadmin to create an ANYDATA to LCR\$_ROW_RECORD transformation at db01 using the DBMS_TRANSFORM package.

In [Example 22-23](#), you create a subscriber at the typed queue. The subscriber specifies the anytolcr transformation created in [Example 22-22](#) for the transformation parameter.

In [Example 22-24](#), you connect to database db01 as sample schema user oe to create a procedure to construct and enqueue a row LCR into the strmadmin.oe_queue_any queue.

In [Example 22-25](#), you use the oe.enq_row_lcr_proc procedure first to create a row LCR that inserts a row into the oe.inventories table, and then to enqueue the row LCR into the strmadmin.oe_queue_any queue.

 **Note:**

This example does not insert a new row in the oe.inventories table. The new row is inserted when an Oracle Streams apply process dequeues the row LCR and applies it.

The LCR is propagated to database db02 by the schedule created in [Example 22-18](#). After allowing some time for propagation, in [Example 22-26](#) you query queue table AQ\$OE_QTAB_LCR at db02 to view the propagated message.

The example returns one message for ROW_LCR_AGENT_REMOTE:

MSG_ID	MSG_STATE	CONSUMER_NAME
ECE2B0F912DDFF5EE030578CE70A04BB	READY	ROW_LCR_AGENT_REMOTE

 **See Also:**

- "Streams Capture Process" in *Oracle Streams Concepts and Administration* for more information on capture processes
- "DBMS_STREAMS" in *Oracle Database PL/SQL Packages and Types Reference* for more information about the row LCR and DDL LCR conversion functions

Example 22-21 Creating a Queue of Type LCR\$_ROW_RECORD

```
CONNECT strmadmin;
Enter password: password

BEGIN
  DBMS_AQADM.CREATE_QUEUE_TABLE(
    queue_table      => 'strmadmin.oe_qtab_lcr',
    queue_payload_type => 'SYS.LCR$_ROW_RECORD',
    multiple_consumers => true);
  DBMS_AQADM.CREATE_QUEUE(
    queue_name      => 'strmadmin.oe_queue_lcr',
    queue_table     => 'strmadmin.oe_qtab_lcr');
  DBMS_AQADM.START_QUEUE(
    queue_name      => 'strmadmin.oe_queue_lcr');
END;
/
```

Example 22-22 Creating an ANYDATA to LCR\$_ROW_RECORD Transformation

```
CONNECT strmadmin;
Enter password: password

BEGIN
  DBMS_TRANSFORM.CREATE_TRANSFORMATION(
    schema          => 'strmadmin',
    name            => 'anytolcr',
    from_schema     => 'SYS',
    from_type       => 'ANYDATA',
    to_schema       => 'SYS',
    to_type         => 'LCR$_ROW_RECORD',
    transformation =>
      'SYS.DBMS_STREAMS.CONVERT_ANYDATA_TO_LCR_ROW(source.user_data)');
END;
/
```

Example 22-23 Creating Subscriber ROW_LCR_AGENT_REMOTE

```
DECLARE
  subscriber SYS.AQ$_AGENT;
BEGIN
  subscriber := SYS.AQ$_AGENT(
    'ROW_LCR_AGENT_REMOTE',
    'STRMADMIN.OE_QUEUE_LCR@DB02',
    0);
  DBMS_AQADM.ADD_SUBSCRIBER(
    queue_name      => 'strmadmin.oe_queue_any',
    subscriber      => subscriber,
    rule            => 'TAB.USER_DATA.GetTypeName()='SYS.LCR$_ROW_RECORD'',
    transformation => 'strmadmin.anytolcr');
END;
/
```

Example 22-24 Creating a Procedure to Construct and Enqueue a Row LCR

```
CONNECT oe;
Enter password: password

CREATE PROCEDURE oe.enq_row_lcr_proc(
  source_dbname  VARCHAR2,
  cmd_type       VARCHAR2,
  obj_owner      VARCHAR2,
```

```

obj_name      VARCHAR2,
old_vals      SYS.LCR$_ROW_LIST,
new_vals      SYS.LCR$_ROW_LIST)
AS
  eopt         DBMS_AQ.ENQUEUE_OPTIONS_T;
  mprop        DBMS_AQ.MESSAGE_PROPERTIES_T;
  enq_msgid    RAW(16);
  row_lcr      SYS.LCR$_ROW_RECORD;
BEGIN
  mprop.SENDER_ID := SYS.AQ$_AGENT('LOCAL_AGENT', NULL, NULL);
  row_lcr := SYS.LCR$_ROW_RECORD.CONSTRUCT(
    source_database_name => source_dbname,
    command_type         => cmd_type,
    object_owner         => obj_owner,
    object_name          => obj_name,
    old_values           => old_vals,
    new_values           => new_vals);
  DBMS_AQ.ENQUEUE(
    queue_name           => 'strmadmin.oe_queue_any',
    enqueue_options      => eopt,
    message_properties   => mprop,
    payload               => ANYDATA.ConvertObject(row_lcr),
    msgid                => enq_msgid);
END enq_row_lcr_proc;
/

```

Example 22-25 Creating and Enqueuing a Row LCR

```

DECLARE
  newunit1 SYS.LCR$_ROW_UNIT;
  newunit2 SYS.LCR$_ROW_UNIT;
  newunit3 SYS.LCR$_ROW_UNIT;
  newvals  SYS.LCR$_ROW_LIST;
BEGIN
  newunit1 := SYS.LCR$_ROW_UNIT(
    'PRODUCT_ID',
    ANYDATA.ConvertNumber(3503),
    DBMS_LCR.NOT_A_LOB,
    NULL,
    NULL);
  newunit2 := SYS.LCR$_ROW_UNIT(
    'WAREHOUSE_ID',
    ANYDATA.ConvertNumber(1),
    DBMS_LCR.NOT_A_LOB,
    NULL,
    NULL);
  newunit3 := SYS.LCR$_ROW_UNIT(
    'QUANTITY_ON_HAND',
    ANYDATA.ConvertNumber(157),
    DBMS_LCR.NOT_A_LOB,
    NULL,
    NULL);
  newvals := SYS.LCR$_ROW_LIST(newunit1,newunit2,newunit3);
  oe.enq_row_lcr_proc(
    source_dbname => 'DB01',
    cmd_type      => 'INSERT',
    obj_owner     => 'OE',
    obj_name      => 'INVENTORIES',
    old_vals      => NULL,
    new_vals      => newvals);
END;

```



```
/  
COMMIT;
```

Example 22-26 Viewing the Propagated LCR

```
CONNECT strmadmin;  
Enter password: password  
  
SELECT MSG_ID, MSG_STATE, CONSUMER_NAME FROM AQ$OE_QTAB_LCR;
```

Oracle Streams Messaging Examples

The examples illustrate a messaging environment that can be constructed using Oracle Streams. The examples assume you are in a SQL*Plus testing environment with access to a database named `db01`.

Topics:

- [Overview of Messaging Example](#)
- [Setting Up Users and Creating an ANYDATA Queue](#)
- [Creating Enqueue Procedures](#)
- [Configuring an Apply Process](#)
- [Configuring Explicit Dequeue](#)
- [Enqueuing Messages](#)
- [Dequeuing Messages Explicitly and Querying for Applied Messages](#)
- [Enqueuing and Dequeuing Messages Using JMS](#)



See Also:

Oracle Streams Concepts and Administration for more information about messaging and ANYDATA queues

23.1 Overview of Messaging Example

This example illustrates using a single ANYDATA [queue](#) to create an Oracle Streams messaging environment in which [message](#) payloads of different types are stored in the same queue. Specifically, this example illustrates the following messaging features of Oracle Streams:

- Enqueuing messages containing order payload as ANYDATA payloads
- Enqueuing messages containing customer payload as ANYDATA payloads
- Enqueuing messages containing row LCRs as ANYDATA payloads
- Creating a rule set for applying the events
- Creating an evaluation context used by the rule set
- Creating an Oracle Streams apply process to [dequeue](#) and process the events based on [rules](#)
- Creating a message handler and associating it with the apply process
- Explicitly dequeuing and processing events based on rules without using the apply process

[Figure 23-1](#) provides an overview of this environment.

Figure 23-1 Example Oracle Streams Messaging Environment

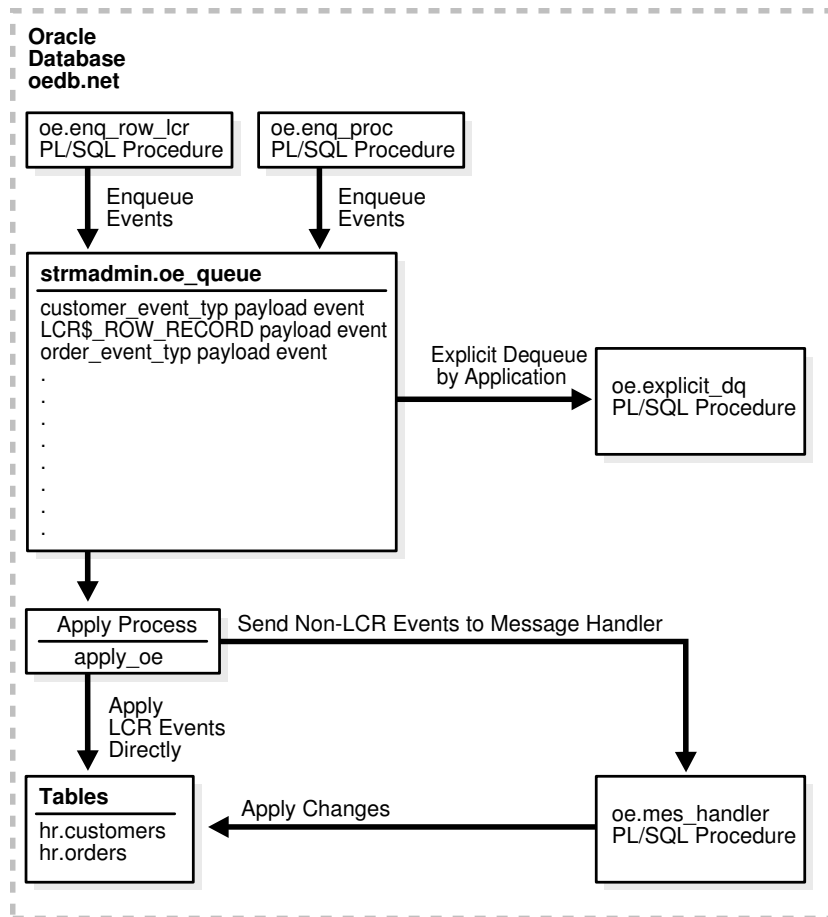

23.2 Setting Up Users and Creating an ANYDATA Queue

Because the examples in this chapter use the `oe` sample schema, the `oe` user must have privileges to run the subprograms in the `DBMS_AQ` package. This is accomplished in [Example 23-1](#).

 **Note:**

The `oe` user is specified as the queue user when the ANYDATA queue is created in [Example 23-2](#). The `SET_UP_QUEUE` procedure grants the `oe` user `enqueue` and `dequeue` privileges on the queue, but the `oe` user also needs `EXECUTE` privilege on the `DBMS_AQ` package to enqueue and dequeue messages.

Most of the configuration and administration actions illustrated in these examples are performed by the Oracle Streams administrator `strmadmin`. [Example 23-1](#) also creates this user and grants the necessary privileges. These privileges enable the user to run subprograms in packages related to Oracle Streams, create rule sets, create rules, and monitor the Oracle Streams environment by querying data dictionary views.

In [Example 23-1](#), you connect to database `db01` as a user with administrative privileges.

 **Note:**

- The `SELECT_CATALOG_ROLE` is not required for the Oracle Streams administrator. It is granted in this example so that the Oracle Streams administrator can monitor the environment easily.
- If you plan to use the Oracle Streams tool in Oracle Enterprise Manager, then grant the Oracle Streams administrator `SELECT ANY DICTIONARY` privilege, in addition to the privileges shown in this step.

In [Example 23-2](#), you connect to database `db01` as administrator user `strmadmin` to create ANYDATA queue `oe_queue`. The `SET_UP_QUEUE` procedure creates a queue table for the queue and then creates and starts the queue.

In [Example 23-3](#), you connect to database `db01` as administrator user `strmadmin` to grant the `oe` user privileges on queue `oe_queue`, create agent `explicit_enq` that will be used to perform explicit enqueue operations on the queue, and associate the `oe` user with the agent.

Queue `oe_queue` is a secure queue because it was created using `SET_UP_QUEUE`. For a user to perform enqueue and dequeue operations on a secure queue, the user must be configured as a secure queue user of the queue. Associating the `oe` user with agent `explicit_enq` enables the `oe` user to perform enqueue operations on this queue.

Example 23-1 Setting Up ANYDATA Users

```
GRANT EXECUTE ON DBMS_AQ TO oe;
CREATE USER strmadmin IDENTIFIED BY strmadmin DEFAULT TABLESPACE example;
GRANT EXECUTE ON DBMS_APPLY_ADM TO strmadmin;
GRANT EXECUTE ON DBMS_AQ TO strmadmin;
GRANT EXECUTE ON DBMS_AQADM TO strmadmin;
GRANT EXECUTE ON DBMS_STREAMS_ADM TO strmadmin;
BEGIN
  DBMS_RULE_ADM.GRANT_SYSTEM_PRIVILEGE(
    privilege => DBMS_RULE_ADM.CREATE_RULE_SET_OBJ,
    grantee   => 'strmadmin',
    grant_option => FALSE);
  DBMS_RULE_ADM.GRANT_SYSTEM_PRIVILEGE(
    privilege => DBMS_RULE_ADM.CREATE_RULE_OBJ,
    grantee   => 'strmadmin',
    grant_option => FALSE);
  DBMS_RULE_ADM.GRANT_SYSTEM_PRIVILEGE(
    privilege => DBMS_RULE_ADM.CREATE_EVALUATION_CONTEXT_OBJ,
    grantee   => 'strmadmin',
    grant_option => FALSE);
END;
/
```

Example 23-2 Creating an ANYDATA Queue

```
SET ECHO OFF
SET VERIFY OFF
ACCEPT password CHAR PROMPT 'Enter the password for STRMADMIN: ' HIDE
CONNECT strmadmin/&password@db01;
```

```
set echo on

BEGIN
  DBMS_STREAMS_ADM.SET_UP_QUEUE(
    queue_table => 'oe_queue_table',
    queue_name  => 'oe_queue');
END;
/
```

Example 23-3 Enabling Enqueue on the ANYDATA Queue

```
SET ECHO OFF
SET VERIFY OFF
ACCEPT password CHAR PROMPT 'Enter the password for STRMADMIN: ' HIDE
CONNECT strmadmin/&password@db01;
set echo on

BEGIN
  SYS.DBMS_AQADM.GRANT_QUEUE_PRIVILEGE(
    privilege => 'ALL',
    queue_name => 'strmadmin.oe_queue',
    grantee    => 'oe');
  SYS.DBMS_AQADM.CREATE_AQ_AGENT(
    agent_name => 'explicit_enq');
  DBMS_AQADM.ENABLE_DB_ACCESS(
    agent_name => 'explicit_enq',
    db_username => 'oe');
END;
/
```

23.3 Creating Enqueue Procedures

The examples in this section create two PL/SQL procedures that enqueue messages into the `ANYDATA` queue `oe_queue`. One procedure enqueues non-LCR messages, and the other procedure enqueues row LCR messages.

In [Example 23-4](#), you connect to database `db01` as sample schema user `oe` to create a type to represent orders based on the columns in the `oe.orders` table. This type is used for messages that are enqueued into the `ANYDATA` queue `oe_queue`. The type attributes include the columns in the `oe.orders` table, along with one extra attribute named `action`. The value of the `action` attribute for instances of this type is used to determine the correct action to perform on the instance (either apply process dequeue or explicit dequeue).

In [Example 23-5](#), you connect to database `db01` as sample schema user `oe` to create a type to represent customers based on the columns in the `oe.customers` table. This type is used for messages that are enqueued into the `ANYDATA` queue `oe_queue`. The type attributes include the columns in the `oe.customers` table, along with one extra attribute named `action`. The value of the `action` attribute for instances of this type is used to determine the correct action to perform on the instance (either apply process dequeue or explicit dequeue).

 **Note:**

This example assumes you have dropped the `cust_geo_location` column from the `oe.customers` table. This column is useful only with Oracle Spatial.

In [Example 23-6](#), you connect to database `db01` as sample schema user `oe` to create a PL/SQL procedure called `enq_proc` to enqueue non-LCR messages into `ANYDATA` queue `oe_queue`.

 **Note:**

A single enqueued message can be dequeued by both an apply process and an explicit dequeue, but the examples in this chapter do not illustrate this capability.

In [Example 23-7](#), you connect to database `db01` as sample schema user `oe` to create a PL/SQL procedure called `enq_row_lcr` that constructs a row LCR and then enqueues the row LCR into `ANYDATA` queue `oe_queue`.

 **See Also:**

Oracle Database PL/SQL Packages and Types Reference for more information about LCR constructors

Example 23-4 Creating an Orders Type

```
SET ECHO OFF
SET VERIFY OFF
ACCEPT password CHAR PROMPT 'Enter the password for OE: ' HIDE
CONNECT oe/&password@db01;
set echo on

CREATE TYPE order_event_typ AS OBJECT(
  order_id      NUMBER(12),
  order_date    TIMESTAMP(6) WITH LOCAL TIME ZONE,
  order_mode    VARCHAR2(8),
  customer_id   NUMBER(6),
  order_status  NUMBER(2),
  order_total   NUMBER(8,2),
  sales_rep_id  NUMBER(6),
  promotion_id  NUMBER(6),
  action        VARCHAR(7));
/
```

Example 23-5 Creating a Customers Type

```
SET ECHO OFFSET VERIFY OFFACCEPT password CHAR PROMPT 'Enter the password for OE: '
HIDECONNECT oe/&password@db01;set echo on

CREATE TYPE customer_event_typ AS OBJECT(
```

```

customer_id      NUMBER(6),
cust_first_name  VARCHAR2(20),
cust_last_name   VARCHAR2(20),
cust_address     CUST_ADDRESS_TYP,
phone_numbers    PHONE_LIST_TYP,
nls_language     VARCHAR2(3),
nls_territory    VARCHAR2(30),
credit_limit     NUMBER(9,2),
cust_email       VARCHAR2(30),
account_mgr_id   NUMBER(6),
date_of_birth    DATE,
marital_status   VARCHAR2(20),
gender           VARCHAR2(1),
income_level     VARCHAR2(20),
action           VARCHAR(7));
/

```

Example 23-6 Creating a Procedure to Enqueue Non-LCR Messages

```

SET ECHO OFFSET VERIFY OFFACCEPT password CHAR PROMPT 'Enter the password for OE: '
HIDECONNECT oe/&password@db01;set echo on

```

```

CREATE PROCEDURE oe.enq_proc (event IN ANYDATA) IS
    enqopt      DBMS_AQ.ENQUEUE_OPTIONS_T;
    mprop       DBMS_AQ.MESSAGE_PROPERTIES_T;
    enq_eventid RAW(16);
BEGIN
    mprop.SENDER_ID := SYS.AQ$_AGENT('explicit_enq', NULL, NULL);
    DBMS_AQ.ENQUEUE(
        queue_name      => 'strmadmin.oe_queue',
        enqueue_options => enqopt,
        message_properties => mprop,
        payload         => event,
        msgid           => enq_eventid);
END;
/

```

Example 23-7 Creating a Procedure to Construct and Enqueue Row LCR Events

```

SET ECHO OFFSET VERIFY OFFACCEPT password CHAR PROMPT 'Enter the password for OE: '
HIDECONNECT oe/&password@db01;set echo on

```

```

CREATE PROCEDURE oe.enq_row_lcr(
    source_dbname  VARCHAR2,
    cmd_type       VARCHAR2,
    obj_owner      VARCHAR2,
    obj_name       VARCHAR2,
    old_vals       SYS.LCR$_ROW_LIST,
    new_vals       SYS.LCR$_ROW_LIST)
AS
    eo     DBMS_AQ.ENQUEUE_OPTIONS_T;
    mprop  DBMS_AQ.MESSAGE_PROPERTIES_T;
    enq_msgid RAW(16);
    row_lcr SYS.LCR$_ROW_RECORD;
BEGIN
    mprop.SENDER_ID := SYS.AQ$_AGENT('explicit_enq', NULL, NULL);
    row_lcr := SYS.LCR$_ROW_RECORD.CONSTRUCT(
        source_database_name => source_dbname,
        command_type         => cmd_type,
        object_owner         => obj_owner,

```

```

object_name      => obj_name,
old_values       => old_vals,
new_values       => new_vals);
DBMS_AQ.ENQUEUE(
  queue_name      => 'strmadmin.oe_queue',
  enqueue_options => eopt,
  message_properties => mprop,
  payload         => ANYDATA.ConvertObject(row_lcr),
  msgid          => enq_msgid);
END enq_row_lcr;
/

```

23.4 Configuring an Apply Process

The examples in this section configure an apply process to apply the user-enqueued messages in the `ANYDATA` queue `oe_queue`.

In [Example 23-8](#), you connect to database `db01` as sample schema user `oe` to create a function called `get_oe_action` and to grant `EXECUTE` privilege on the function to administrator user `strmadmin`.

This function determines the value of the `action` attribute in the messages in queue `oe_queue`. It is used in rules later in this chapter to determine the value of the `action` attribute for an event. Then, the clients of the [rules engine](#) perform the appropriate action for the event (either dequeue by apply process or explicit dequeue). In this example, the clients of the [rules engine](#) are the apply process and the `oe.explicit_dq` PL/SQL procedure.

In [Example 23-9](#), you connect to database `db01` as sample schema user `oe` to create a PL/SQL procedure called `mes_handler` that is used as a message handler by the apply process. You also grant `EXECUTE` privilege on this procedure to administrator user `strmadmin`. This procedure takes the payload in a user-enqueued message of type `oe.order_event_typ` or `oe.customer_event_typ` and inserts it as a row in the `oe.orders` table or `oe.customers` table, respectively.

In [Example 23-10](#), you connect to database `db01` as administrator user `strmadmin` to create an evaluation context for the rule set.

In [Example 23-11](#), you connect to database `db01` as administrator user `strmadmin` to create a rule set for the apply process.

In [Example 23-12](#), you connect to database `db01` as administrator user `strmadmin` to create a rule that evaluates to `TRUE` if the `action` value of a message is `apply`. Notice that `tab.user_data` is passed to the `oe.get_oe_action` function. The `tab.user_data` column holds the event payload in a queue table. The table alias for the queue table was specified as `tab` in [Example 23-10](#).

In [Example 23-13](#), you connect to database `db01` as administrator user `strmadmin` to create a rule that evaluates to `TRUE` if the event in the queue is a row LCR that changes either the `oe.orders` table or the `oe.customers` table. This rule enables the apply process to apply user-enqueued changes to the tables directly.

For convenience, this rule uses the Oracle-supplied evaluation context `SYS.STREAMS$_EVALUATION_CONTEXT` because the rule is used to evaluate LCRs. When this rule is added to the rule set, the Oracle-supplied evaluation context is used for the rule during evaluation instead of evaluation context `oe_eval_context` created in [Example 23-10](#).

In [Example 23-14](#), you connect to database `db01` as administrator user `strmadmin` to add the `apply_action` rule created in [Example 23-12](#) and the `apply_lcrs` rule created in [Example 23-13](#) to the `apply_oe_rs` rule set created in [Example 23-11](#).

In [Example 23-15](#), you connect to database `db01` as administrator user `strmadmin` to create an apply process that is associated with queue `oe_queue`, that uses the `apply_oe_rs` rule set, and that uses the `mes_handler` procedure as a message handler.

Because `oe` was specified as the apply user when the apply process was created in [Example 23-15](#), you must grant this user `EXECUTE` privilege on the `strmadmin.apply_oe_rs` rule set used by the apply process. You connect to database `db01` as administrator user `strmadmin` to accomplish this in [Example 23-16](#).

In [Example 23-17](#), you connect to database `db01` as administrator user `strmadmin` to start the apply process with the `disable_on_error` parameter set to `n` so that the apply process is not disabled if it encounters an error.

Example 23-8 Creating a Function to Determine the Value of the Action Attribute

```
SET ECHO OFFSET VERIFY OFFACCEPT password CHAR PROMPT 'Enter the password for OE: '
HIDECONNECT oe/&password@db01;set echo on
```

```
CREATE FUNCTION oe.get_oe_action (event IN ANYDATA)
RETURN VARCHAR2
IS
    ord          oe.order_event_typ;
    cust         oe.customer_event_typ;
    num          NUMBER;
    type_name    VARCHAR2(61);
BEGIN
    type_name := event.GETTYPENAME;
    IF type_name = 'OE.ORDER_EVENT_TYP' THEN
        num := event.GETOBJECT(ord);
        RETURN ord.action;
    ELSIF type_name = 'OE.CUSTOMER_EVENT_TYP' THEN
        num := event.GETOBJECT(cust);
        RETURN cust.action;
    ELSE
        RETURN NULL;
    END IF;
END;
/
GRANT EXECUTE ON get_oe_action TO strmadmin;
```

Example 23-9 Creating a Message Handler

```
set echo offset verify offACCEPT password CHAR PROMPT 'Enter the password for OE: '
HIDECONNECT oe/&password@db01;set echo on
```

```
CREATE PROCEDURE oe.mes_handler (event IN ANYDATA) IS
    ord          oe.order_event_typ;
    cust         oe.customer_event_typ;
    num          NUMBER;
    type_name    VARCHAR2(61);
BEGIN
    type_name := event.GETTYPENAME;
    IF type_name = 'OE.ORDER_EVENT_TYP' THEN
        num := event.GETOBJECT(ord);
        INSERT INTO oe.orders VALUES (ord.order_id, ord.order_date,
            ord.order_mode, ord.customer_id, ord.order_status, ord.order_total,
```

```

        ord.sales_rep_id, ord.promotion_id);
ELSIF type_name = 'OE.CUSTOMER_EVENT_TYP' THEN
    num := event.GETOBJECT(cust);
    INSERT INTO oe.customers VALUES (cust.customer_id, cust.cust_first_name,
        cust.cust_last_name, cust.cust_address, cust.phone_numbers,
        cust.nls_language, cust.nls_territory, cust.credit_limit, cust.cust_email,
        cust.account_mgr_id, cust.date_of_birth, cust.marital_status,
        cust.gender, cust.income_level);
    END IF;
END;
/
GRANT EXECUTE ON mes_handler TO strmadmin;

```

Example 23-10 Creating an Evaluation Context for the Rule Set

```

SET ECHO OFF
SET VERIFY OFF
ACCEPT password CHAR PROMPT 'Enter the password for STRMADMIN: ' HIDE
CONNECT strmadmin/ &password@db01;
set echo on

DECLARE
    table_alias    SYS.RE$TABLE_ALIAS_LIST;
BEGIN
    table_alias := SYS.RE$TABLE_ALIAS_LIST(
        SYS.RE$TABLE_ALIAS('tab', 'strmadmin.oe_queue_table'));
    DBMS_RULE_ADM.CREATE_EVALUATION_CONTEXT(
        evaluation_context_name => 'oe_eval_context',
        table_aliases           => table_alias);
END;
/

```

Example 23-11 Creating a Rule Set for the Apply Process

```

SET ECHO OFF
SET VERIFY OFF
ACCEPT password CHAR PROMPT 'Enter the password for STRMADMIN: ' HIDE
CONNECT strmadmin/ &password@db01;
set echo on

BEGIN
    DBMS_RULE_ADM.CREATE_RULE_SET(
        rule_set_name      => 'apply_oe_rs',
        evaluation_context => 'strmadmin.oe_eval_context');
END;
/

```

Example 23-12 Creating a Rule that Evaluates to TRUE if Action Is Apply

```

SET ECHO OFF
SET VERIFY OFF
ACCEPT password CHAR PROMPT 'Enter the password for STRMADMIN: ' HIDE
CONNECT strmadmin/ &password@db01;
set echo on

BEGIN
    DBMS_RULE_ADM.CREATE_RULE(
        rule_name      => 'strmadmin.apply_action',
        condition      => 'oe.get_oe_action(tab.user_data) = ''APPLY'' ');
END;
/

```

Example 23-13 Creating a Rule that Evaluates to TRUE for Row LCR Events

```

SET ECHO OFF
SET VERIFY OFF
ACCEPT password CHAR PROMPT 'Enter the password for STRMADMIN: ' HIDE
CONNECT strmadmin/&password@db01;
set echo on

BEGIN
  DBMS_RULE_ADM.CREATE_RULE(
    rule_name      => 'apply_lcrs',
    condition      => ':dml.GET_OBJECT_OWNER() = ''OE'' AND ' ||
                      ' (:dml.GET_OBJECT_NAME() = ''ORDERS'' OR ' ||
                      ':dml.GET_OBJECT_NAME() = ''CUSTOMERS'') ',
    evaluation_context => 'SYS.STREAMS$_EVALUATION_CONTEXT');
END;
/

```

Example 23-14 Adding Rules to the Rule Set

```

SET ECHO OFFSET VERIFY OFFACCEPT password CHAR PROMPT 'Enter the password for
STRMADMIN: ' HIDECONNECT strmadmin/&password@db01;set echo on

BEGIN
  DBMS_RULE_ADM.ADD_RULE(
    rule_name      => 'apply_action',
    rule_set_name  => 'apply_oe_rs');
  DBMS_RULE_ADM.ADD_RULE(
    rule_name      => 'apply_lcrs',
    rule_set_name  => 'apply_oe_rs');
END;
/

```

Example 23-15 Creating an Apply Process

```

SET ECHO OFFSET VERIFY OFFACCEPT password CHAR PROMPT 'Enter the password for
STRMADMIN: ' HIDECONNECT strmadmin/&password@db01;set echo on

BEGIN
  DBMS_APPLY_ADM.CREATE_APPLY(
    queue_name     => 'strmadmin.oe_queue',
    apply_name     => 'apply_oe',
    rule_set_name  => 'strmadmin.apply_oe_rs',
    message_handler => 'oe.mes_handler',
    apply_user     => 'oe',
    apply_captured => false);
END;
/

```

Example 23-16 Granting EXECUTE Privilege on the Rule Set To oe User

```

SET ECHO OFF
SET VERIFY OFF
ACCEPT password CHAR PROMPT 'Enter the password for STRMADMIN: ' HIDECONNECT
strmadmin/&password@db01;set echo on

BEGIN
  DBMS_RULE_ADM.GRANT_OBJECT_PRIVILEGE(
    privilege      => DBMS_RULE_ADM.EXECUTE_ON_RULE_SET,
    object_name    => 'strmadmin.apply_oe_rs',
    grantee        => 'oe',
    grant_option   => FALSE);

```

```
END;
/
```

Example 23-17 Starting the Apply Process

```
SET ECHO OFFSET VERIFY OFFACCEPT password CHAR PROMPT 'Enter the password for
STRMADMIN: ' HIDECONNECT strmadmin/&password@db01;set echo on
```

```
BEGIN
  DBMS_APPLY_ADM.SET_PARAMETER(
    apply_name => 'apply_oe',
    parameter  => 'disable_on_error',
    value      => 'n');
  DBMS_APPLY_ADM.START_APPLY(
    apply_name => 'apply_oe');
END;
/
```

23.5 Configuring Explicit Dequeue

The examples in this section illustrate how to configure explicit dequeue of messages based on message contents.

In [Example 23-18](#), you connect to database `db01` as administrator user `strmadmin` to create agent `explicit_dq`. This agent is used to perform explicit dequeue operations on the `oe_queue` queue.

The `oe_queue` queue is a secure queue because it was created using `SET_UP_QUEUE` in [Example 23-2](#). For a user to perform enqueue and dequeue operations on a secure queue, the user must be configured as a secure queue user of the queue.

In [Example 23-19](#), you connect to database `db01` as administrator user `strmadmin` to associate the `oe` user with agent `explicit_dq`. The `oe` user can perform dequeue operations on the `oe_queue` queue when the agent is used to create a [subscriber](#) to the queue in [Example 23-20](#).

In [Example 23-20](#), you connect to database `db01` as administrator user `strmadmin` to add a subscriber to the `oe_queue` queue. This subscriber will perform explicit dequeues of messages. A subscriber rule is used to dequeue any messages where the `action` value is not `apply`. If the `action` value is `apply` for a message, then the message is ignored by the subscriber. Such messages are dequeued and processed by the apply process.

In [Example 23-21](#), you connect to database `db01` as sample schema user `oe` to create a PL/SQL procedure called `explicit_dq` to dequeue messages explicitly using the subscriber created in [Example 23-20](#).

The procedure commits after the dequeue of the messages. The commit informs the queue that the dequeued messages have been consumed successfully by this subscriber.

The procedure can process multiple transactions and uses two exception handlers. Exception handler `next_trans` moves to the next transaction, and exception handler `no_messages` exits the loop when there are no more messages.

Example 23-18 Creating an Agent for Explicit Dequeue

```
SET ECHO OFFSET VERIFY OFFACCEPT password CHAR PROMPT 'Enter the password for
STRMADMIN: ' HIDECONNECT strmadmin/&password@db01;set echo on
```

```

BEGIN
  SYS.DBMS_AQADM.CREATE_AQ_AGENT(
    agent_name      => 'explicit_dq');
END;
/

```

Example 23-19 Associating User oe with Agent explicit_dq

```

set echo offset verify offACCEPT password CHAR PROMPT 'Enter the password for
STRMADMIN: ' HIDECONNECT strmadmin/&password@db01;set echo on

```

```

BEGIN
  DBMS_AQADM.ENABLE_DB_ACCESS(
    agent_name      => 'explicit_dq',
    db_username     => 'oe');
END;
/

```

Example 23-20 Adding a Subscriber to the oe_queue Queue

```

SET ECHO OFFSET VERIFY OFFACCEPT password CHAR PROMPT 'Enter the password for
STRMADMIN: ' HIDECONNECT strmadmin/&password@db01;set echo on

```

```

DECLARE
  subscriber SYS.AQ$AGENT;
BEGIN
  subscriber := SYS.AQ$AGENT('explicit_dq', NULL, NULL);
  SYS.DBMS_AQADM.ADD_SUBSCRIBER(
    queue_name      => 'strmadmin.oe_queue',
    subscriber      => subscriber,
    rule            => 'oe.get_oe_action(tab.user_data) != ''APPLY''');
END;
/

```

Example 23-21 Creating a Procedure to Dequeue Messages Explicitly

```

SET ECHO OFFSET VERIFY OFF
ACCEPT password CHAR PROMPT 'Enter the password for OE: ' HIDECONNECT oe/
&password@db01;set echo on

```

```

CREATE PROCEDURE oe.explicit_dq (consumer IN VARCHAR2) AS
  deqopt      DBMS_AQ.DEQUEUE_OPTIONS_T;
  mprop       DBMS_AQ.MESSAGE_PROPERTIES_T;
  msgid       RAW(16);
  payload     ANYDATA;
  new_messages BOOLEAN := TRUE;
  ord         oe.order_event_typ;
  cust        oe.customer_event_typ;
  tc          pls_integer;
  next_trans  EXCEPTION;
  no_messages EXCEPTION;
  pragma exception_init (next_trans, -25235);
  pragma exception_init (no_messages, -25228);
BEGIN
  deqopt.consumer_name := consumer;
  deqopt.wait := 1;
  WHILE (new_messages) LOOP
    BEGIN
      DBMS_AQ.DEQUEUE(
        queue_name      => 'strmadmin.oe_queue',
        dequeue_options => deqopt,

```

```

        message_properties => mprop,
        payload            => payload,
        msgid              => msgid);
COMMIT;
deqopt.navigation := DBMS_AQ.NEXT;
DBMS_OUTPUT.PUT_LINE('Message Dequeued');
DBMS_OUTPUT.PUT_LINE('Type Name := ' || payload.GetTypeName);
IF (payload.GetTypeName = 'OE.ORDER_EVENT_TYP') THEN
    tc := payload.GetObject(ord);
    DBMS_OUTPUT.PUT_LINE('order_id      - ' || ord.order_id);
    DBMS_OUTPUT.PUT_LINE('order_date   - ' || ord.order_date);
    DBMS_OUTPUT.PUT_LINE('order_mode   - ' || ord.order_mode);
    DBMS_OUTPUT.PUT_LINE('customer_id  - ' || ord.customer_id);
    DBMS_OUTPUT.PUT_LINE('order_status - ' || ord.order_status);
    DBMS_OUTPUT.PUT_LINE('order_total  - ' || ord.order_total);
    DBMS_OUTPUT.PUT_LINE('sales_rep_id - ' || ord.sales_rep_id);
    DBMS_OUTPUT.PUT_LINE('promotion_id - ' || ord.promotion_id);
END IF;
IF (payload.GetTypeName = 'OE.CUSTOMER_EVENT_TYP') THEN
    tc := payload.GetObject(cust);
    DBMS_OUTPUT.PUT_LINE('customer_id      - ' || cust.customer_id);
    DBMS_OUTPUT.PUT_LINE('cust_first_name  - ' || cust.cust_first_name);
    DBMS_OUTPUT.PUT_LINE('cust_last_name   - ' || cust.cust_last_name);
    DBMS_OUTPUT.PUT_LINE('street_address   - ' ||
        cust.cust_address.street_address);
    DBMS_OUTPUT.PUT_LINE('postal_code      - ' ||
        cust.cust_address.postal_code);
    DBMS_OUTPUT.PUT_LINE('city             - ' || cust.cust_address.city);
    DBMS_OUTPUT.PUT_LINE('state_province   - ' ||
        cust.cust_address.state_province);
    DBMS_OUTPUT.PUT_LINE('country_id       - ' ||
        cust.cust_address.country_id);
    DBMS_OUTPUT.PUT_LINE('phone_number1    - ' || cust.phone_numbers(1));
    DBMS_OUTPUT.PUT_LINE('phone_number2    - ' || cust.phone_numbers(2));
    DBMS_OUTPUT.PUT_LINE('phone_number3    - ' || cust.phone_numbers(3));
    DBMS_OUTPUT.PUT_LINE('nls_language     - ' || cust.nls_language);
    DBMS_OUTPUT.PUT_LINE('nls_territory    - ' || cust.nls_territory);
    DBMS_OUTPUT.PUT_LINE('credit_limit     - ' || cust.credit_limit);
    DBMS_OUTPUT.PUT_LINE('cust_email       - ' || cust.cust_email);
    DBMS_OUTPUT.PUT_LINE('account_mgr_id   - ' || cust.account_mgr_id);
    DBMS_OUTPUT.PUT_LINE('date_of_birth    - ' || cust.date_of_birth);
    DBMS_OUTPUT.PUT_LINE('marital_status   - ' || cust.marital_status);
    DBMS_OUTPUT.PUT_LINE('gender           - ' || cust.gender);
    DBMS_OUTPUT.PUT_LINE('income_level     - ' || cust.income_level);
END IF;
EXCEPTION
    WHEN next_trans THEN
        deqopt.navigation := DBMS_AQ.NEXT_TRANSACTION;
    WHEN no_messages THEN
        new_messages := FALSE;
        DBMS_OUTPUT.PUT_LINE('No more messagess');
END;
END LOOP;
END;
/

```

23.6 Enqueuing Messages

The examples in this section illustrate how to enqueue non-LCR messages and row LCR messages into a queue.

 **Note:**

It is possible to dequeue user-enqueued LCRs explicitly, but these examples do not illustrate this capability.

In [Example 23-22](#), you connect to database `db01` as sample schema user `oe` to enqueue two messages with `apply` for the `action` value. Based on the apply process rules, the apply process dequeues and processes these messages with the `oe.mes_handler` message handler procedure created in [Example 23-9](#). The `COMMIT` after the enqueues makes these two enqueues part of the same transaction. An enqueued message is not visible until the session that enqueued it commits the enqueue.

In [Example 23-23](#), you connect to database `db01` as sample schema user `oe` to enqueue two messages with `dequeue` for the `action` value. The `oe.explicit_dq` procedure created in [Example 23-21](#) dequeues these messages because the `action` is not `apply`. Based on the apply process rules, the apply process ignores these messages. The `COMMIT` after the enqueues makes these two enqueues part of the same transaction.

In [Example 23-24](#), you connect to database `db01` as sample schema user `oe` to create a row LCR that inserts a row into the `oe.orders` table and another LCR that updates that row. The apply process applies these messages directly.

 **Note:**

Enqueued LCRs should commit at transaction boundaries. In this example, a `COMMIT` statement is run after each enqueue, making each enqueue a separate transaction. However, you can perform multiple LCR enqueues before a commit if there is more than one LCR in a transaction.

Example 23-22 Enqueuing Non-LCR Messages to Be Dequeued by an Apply Process

```
SET ECHO OFFSET VERIFY OFFACCEPT password CHAR PROMPT 'Enter the password for OE: '
HIDECONNECT oe/&password@db01;set echo on

BEGIN
  oe.enq_proc(ANYDATA.convertobject(oe.order_event_typ(
    2500, '05-MAY-01', 'online', 117, 3, 44699, 161, NULL, 'APPLY')));
END;
/
BEGIN
  oe.enq_proc(ANYDATA.convertobject(oe.customer_event_typ(
    990, 'Hester', 'Prynn', oe.cust_address_typ('555 Beacon Street',
    '02109', 'Boston', 'MA', 'US'), oe.phone_list_typ('+1 617 123 4104',
    '+1 617 083 4381', '+1 617 742 5813'), 'i', 'AMERICA', 5000,
    'a@scarlet_letter.com', 145, NULL, 'SINGLE', 'F', 'UNDER 50,000', 'APPLY')));
END;
/
COMMIT;
```

Example 23-23 Enqueuing Non-LCR Messages to Be Dequeued Explicitly

```

SET ECHO OFFSET VERIFY OFFACCEPT password CHAR PROMPT 'Enter the password for OE: '
HIDECONNECT oe/&password@db01;set echo on

BEGIN
  oe.enq_proc(ANYDATA.convertobject(oe.order_event_typ(
    2501,'22-JAN-00','direct',117,3,22788,161,NULL,'DEQUEUE'));
END;
/
BEGIN
  oe.enq_proc(ANYDATA.convertobject(oe.customer_event_typ(
    991,'Nick','Carraway',oe.cust_address_typ('10th Street',
    '11101','Long Island','NY','US'),oe.phone_list_typ('+1 718 786 2287',
    '+1 718 511 9114', '+1 718 888 4832'),'i','AMERICA',3000,
    'nick@great_gatsby.com',149,NULL,'MARRIED','M','OVER 150,000','DEQUEUE'));
END;
/
COMMIT;

```

Example 23-24 Enqueuing Row LCRs to Be Dequeued by an Apply Process

```

SET ECHO OFF
SET VERIFY OFF
ACCEPT password CHAR PROMPT 'Enter the password for OE: ' HIDE
CONNECT oe/&password@db01;
set echo on

DECLARE
  newunit1 SYS.LCR$_ROW_UNIT;
  newunit2 SYS.LCR$_ROW_UNIT;
  newunit3 SYS.LCR$_ROW_UNIT;
  newunit4 SYS.LCR$_ROW_UNIT;
  newunit5 SYS.LCR$_ROW_UNIT;
  newunit6 SYS.LCR$_ROW_UNIT;
  newunit7 SYS.LCR$_ROW_UNIT;
  newunit8 SYS.LCR$_ROW_UNIT;
  newvals SYS.LCR$_ROW_LIST;
BEGIN
  newunit1 := SYS.LCR$_ROW_UNIT(
    'ORDER_ID',ANYDATA.ConvertNumber(2502),DBMS_LCR.NOT_A_LOB,NULL,NULL);
  newunit2 := SYS.LCR$_ROW_UNIT(
    'ORDER_DATE',ANYDATA.ConvertTimestampLTZ('04-NOV-00'),DBMS_LCR.NOT_A_LOB,
    NULL,NULL);
  newunit3 := SYS.LCR$_ROW_UNIT(
    'ORDER_MODE',ANYDATA.ConvertVarchar2('online'),DBMS_LCR.NOT_A_LOB,NULL,NULL);
  newunit4 := SYS.LCR$_ROW_UNIT(
    'CUSTOMER_ID',ANYDATA.ConvertNumber(145),DBMS_LCR.NOT_A_LOB,NULL,NULL);
  newunit5 := SYS.LCR$_ROW_UNIT(
    'ORDER_STATUS',ANYDATA.ConvertNumber(3),DBMS_LCR.NOT_A_LOB,NULL,NULL);
  newunit6 := SYS.LCR$_ROW_UNIT(
    'ORDER_TOTAL',ANYDATA.ConvertNumber(35199),DBMS_LCR.NOT_A_LOB,NULL,NULL);
  newunit7 := SYS.LCR$_ROW_UNIT(
    'SALES_REP_ID',ANYDATA.ConvertNumber(160),DBMS_LCR.NOT_A_LOB,NULL,NULL);
  newunit8 := SYS.LCR$_ROW_UNIT(
    'PROMOTION_ID',ANYDATA.ConvertNumber(1),DBMS_LCR.NOT_A_LOB,NULL,NULL);
  newvals := SYS.LCR$_ROW_LIST(
    newunit1,newunit2,newunit3,newunit4,newunit5,newunit6,newunit7,newunit8);
  oe.enq_row_lcr('DB01','INSERT','OE','ORDERS',NULL,newvals);
END;
/

```



```

COMMIT;
DECLARE
  oldunit1 SYS.LCR$_ROW_UNIT;
  oldunit2 SYS.LCR$_ROW_UNIT;
  oldvals  SYS.LCR$_ROW_LIST;
  newunit1 SYS.LCR$_ROW_UNIT;
  newvals  SYS.LCR$_ROW_LIST;
BEGIN
  oldunit1 := SYS.LCR$_ROW_UNIT(
    'ORDER_ID', ANYDATA.ConvertNumber(2502), DBMS_LCR.NOT_A_LOB, NULL, NULL);
  oldunit2 := SYS.LCR$_ROW_UNIT(
    'ORDER_TOTAL', ANYDATA.ConvertNumber(35199), DBMS_LCR.NOT_A_LOB, NULL, NULL);
  oldvals := SYS.LCR$_ROW_LIST(oldunit1, oldunit2);
  newunit1 := SYS.LCR$_ROW_UNIT(
    'ORDER_TOTAL', ANYDATA.ConvertNumber(5235), DBMS_LCR.NOT_A_LOB, NULL, NULL);
  newvals := SYS.LCR$_ROW_LIST(newunit1);
  oe.enq_row_lcr('DB01', 'UPDATE', 'OE', 'ORDERS', oldvals, newvals);
END;
/
COMMIT;

```

23.7 Dequeuing Messages Explicitly and Querying for Applied Messages

The examples in this section illustrate how to dequeue messages explicitly and query messages that were applied by the apply process. The examples use messages that were enqueued in the previous section.

In [Example 23-25](#), you connect to database `db01` as sample schema user `oe` to run procedure `explicit_dq`, created in [Example 23-21](#). You specify subscriber `explicit_dq`, added in [Example 23-20](#), as the **consumer** of the messages you want to dequeue. In these examples, messages that are not dequeued explicitly by this procedure are dequeued by the apply process.

The example returns the payload of the messages enqueued in [Example 23-23](#):

```

Message Dequeued
Type Name := OE.ORDER_EVENT_TYP
order_id      - 2501
order_date    - 22-JAN-00 12.00.00.000000 AM
order_mode    - direct
customer_id   - 117
order_status  - 3
order_total   - 22788
sales_rep_id  - 161
promotion_id  -
Message Dequeued
Type Name := OE.CUSTOMER_EVENT_TYP
customer_id   - 991
cust_first_name - Nick
cust_last_name - Carraway
street_address - 10th Street
postal_code   - 11101
city          - Long Island
state_province - NY
country_id    - US
phone_number1 - +1 718 786 2287
phone_number2 - +1 718 511 9114

```

```

phone_number3      - +1 718 888 4832
nls_language       - i
nls_territory      - AMERICA
credit_limit       - 3000
cust_email         - nick@great_gatsby.com
account_mgr_id     - 149
date_of_birth      -
marital_status     - MARRIED
gender             - M
income_level       - OVER 150,000
No more messages

```

Example 23-26, you connect to database db01 as sample schema user oe to query the oe.orders and oe.customers tables to see the rows corresponding to the messages applied by apply process apply_oe, created in [Example 23-15](#).

The example returns three rows:

```

ORDER_ID ORDER_DATE                CUSTOMER_ID ORDER_TOTAL
-----
2500 05-MAY-01 12.00.00.000000 AM      117      44699

```

1 row selected.

```

CUST_FIRST_NAME    CUST_LAST_NAME    CUST_EMAIL
-----
Hester              Prynne            a@scarlet_letter.com

```

1 row selected.

```

ORDER_ID ORDER_DATE                CUSTOMER_ID ORDER_TOTAL
-----
2502 04-NOV-00 12.00.00.000000 AM      145      5235

```

1 row selected.

Example 23-25 Dequeuing Messages Explicitly

```

SET ECHO OFF
SET VERIFY OFF
ACCEPT password CHAR PROMPT 'Enter the password for OE: ' HIDE
CONNECT oe/&password@db01;
set echo on

```

```

CREATE PROCEDURE oe.enq_proc (payload ANYDATA) IS
SET SERVEROUTPUT ON SIZE 100000;
EXEC oe.explicit_dq('explicit_dq');

```

Example 23-26 Querying for Applied Messages

```

SET ECHO OFF
SET VERIFY OFF
ACCEPT password CHAR PROMPT 'Enter the password for OE: ' HIDE
CONNECT oe/&password@db01;
set echo on

```

```

CREATE PROCEDURE oe.enq_proc (payload ANYDATA) IS
SELECT order_id, order_date, customer_id, order_total
FROM oe.orders WHERE order_id = 2500;
SELECT cust_first_name, cust_last_name, cust_email
FROM oe.customers WHERE customer_id = 990;

```

```
SELECT order_id, order_date, customer_id, order_total
FROM oe.orders WHERE order_id = 2502;
```

23.8 Enqueuing and Dequeuing Messages Using JMS

The examples in this section illustrate how to enqueue non-LCR messages and row LCRs into a queue and then dequeue them using [Java Message Service \(JMS\)](#).

Note that the Oracle Database does not support JDK 1.2, JDK 1.3, JDK 1.4, JDK 5.n, and all classes12*.*** files. You need to use the `ojdbc6.jar` and `ojdbc7.jar` files with JDK 6.n and JDK 7.n, respectively. The following jar and zip files should be in the `CLASSPATH` based on the release of JDK you are using.

For JDK 6.n, the `CLASSPATH` must contain:

```
ORACLE_HOME/jdbc/lib/ojdbc6.jar
```

For JDK 7.n, the `CLASSPATH` must contain:

```
ORACLE_HOME/jdbc/lib/ojdbc7.jar
```

The following files are used for either JDK version:

```
ORACLE_HOME/lib/jta.jar
ORACLE_HOME/xdk/lib/xmlparserv2.jar
ORACLE_HOME/rdbms/jlib/xdm.jar
ORACLE_HOME/rdbms/jlib/raqapi.jar
ORACLE_HOME/rdbms/jlib/jmscommon.jar
```

Also, make sure `LD_LIBRARY_PATH` (Linux and Solaris) or `PATH` (Windows) includes `ORACLE_HOME/lib`.

These examples show sample schema user `oe` enqueueing JMS messages into a queue and agent `explicit_dq` dequeuing them. Agent `explicit_dq` was created in [Example 23-18](#), associated with sample schema user `oe` in [Example 23-19](#), and made a subscriber to queue `oe_queue` in [Example 23-20](#).

Sample schema user `oe` was granted `EXECUTE` on `DBMS_AQ` in [Example 23-1](#). In order for this user to use the Oracle JMS interface, it must have `EXECUTE` privilege on `DBMS_AQIN` as well. In [Example 23-27](#), you connect to database `db01` as a user with administrative privileges to grant the necessary privilege to `oe`.



See Also:

["Accessing Standard and Oracle JMS Applications"](#)

Enqueue of JMS types and XML types does not work with Oracle Streams `ANYDATA` queues unless you call `DBMS_AQADM.ENABLE_JMS_TYPES(queue_table_name)` after `DBMS_STREAMS_ADM.SET_UP_QUEUE()`. In [Example 23-28](#), you connect to database `db01` as administrator user `strmadmin`, created in [Example 23-1](#), to run `ENABLE_JMS_TYPES` on `ANYDATA` queue table `oe_queue_table`, created in [Example 23-2](#).

 **Note:**

Enabling an Oracle Streams queue for these types may affect import/export of the queue table.

In [Example 23-29](#), you connect to database `db01` as sample schema user `oe` to create types `address` and `person`.

In [Example 23-30](#), you use `JPublisher` to generate two Java classes named `JPerson` and `JAddress` for the `person` and `address` types, respectively. The input to `JPublisher` is a file called `input.typ` with the following lines:

```
SQL PERSON AS JPerson
SQL ADDRESS AS JAddress
```

[Example 23-31](#) is the Java code that you use to publish JMS text messages, LCRs, and non-LCR ADT messages into an Oracle Streams topic. It does the following:

- Creates a `TopicConnectionFactory` using the JDBC OCI driver

 **Note:**

The JDBC OCI driver is your only choice for accessing Oracle Streams through JMS.

- Creates a `TopicSession`
- Starts the connection
- Creates method `publishUserMessages()` to publish an ADT message and a JMS text message to an Oracle Streams topic
- Creates method `publishLcrMessages()` to publish an XML LCR message to an Oracle Streams topic
- Publishes three messages, providing feedback as it proceeds

Method `publishUserMessages()` does the following:

- Gets the topic
- Creates a publisher
- Specifies agent `explicit_enq` to access queue `oe_queue`
- Creates a `PERSON` ADT message
- Sets the payload in the message
- Specifies `explicit_dq` as the recipient
- Publishes the `PERSON` ADT message
- Creates a JMS Text message
- Publishes the JMS Text message

Method `publishLcrMessages()` does the following:

- Gets the topic

- Creates a publisher
- Gets the JDBC connection
- Specifies agent `explicit_enq` to access queue `oe_queue`
- Creates an ADT message
- Creates the LCR representation in XML
- Creates the `XMLType` containing the LCR
- Sets the payload in the message
- Specifies `explicit_dq` as the recipient
- Publishes the LCR

The code is compiled in [Example 23-33](#). For now, just save it as `StreamsEnq.java`.

[Example 23-32](#) is the Java code you use to receive messages from an Oracle Streams topic. It does the following:

- Creates a `TopicConnectionFactory` using the JDBC OCI driver



Note:

The JDBC OCI driver is your only choice for accessing Oracle Streams through JMS.

- Creates a `TopicSession`
- Starts the connection
- Creates method `receiveMessages()` to receive messages from an Oracle Streams topic
- Receives three messages, providing feedback as it proceeds

Method `receiveMessages()` does the following:

- Gets the topic
- Creates a `TopicReceiver` to receive messages for consumer `explicit_dq`
- Registers mappings for `ADDRESS` and `PERSON` in the JMS `typemap`
- Registers a mapping for `XMLType` in the `typemap` (required for LCRs)
- Receives the enqueued messages

The code is compiled in [Example 23-33](#). For now, just save it as `StreamsDeq.java`.

In [Example 23-33](#), you compile the scripts.

In [Example 23-34](#), you run the enqueue program, specifying values for `ORACLE_SID`, `HOST`, and `PORT` that are appropriate for your testing environment.

The example returns:

```
Publish message 1 -type PERSON
Publish message 2 -type JMS TextMessage
Publish message 3 - XMLType containing LCR ROW
End of StreamsEnq Demo
```

In [Example 23-35](#), you run the dequeue program, specifying values for `ORACLE_SID`, `HOST`, and `PORT` that are appropriate for your testing environment.

Example 23-27 Granting EXECUTE on DBMS_AQIN to User oe

```
GRANT EXECUTE on DBMS_AQIN to oe;
```

Example 23-28 Enabling JMS Types on an ANYDATA Queue

```
CONNECT strmadmin;
Enter password: password
BEGIN
    DBMS_AQADM.ENABLE_JMS_TYPES('oe_queue_table');
END;
/
```

Example 23-29 Creating Oracle Object Types address and person

```
CONNECT oe;
Enter password: password
CREATE TYPE address AS OBJECT (street VARCHAR (30), num NUMBER)
/
CREATE TYPE person AS OBJECT (name VARCHAR (30), home ADDRESS)
/
```

Example 23-30 Creating Java Classes That Map to Oracle Object Types

```
jspub -input=input.typ -user=OE/OE
```

Example 23-31 Java Code for Enqueuing Messages

```
import oracle.AQ.*;
import oracle.jms.*;
import javax.jms.*;
import java.lang.*;
import oracle.xdb.*;

public class StreamsEnq
{
    public static void main (String args [])
        throws java.sql.SQLException, ClassNotFoundException, JMSEException
    {
        TopicConnectionFactory tc_fact= null;
        TopicConnection      t_conn = null;
        TopicSession         t_sess = null;

        try
        {
            if (args.length < 3 )
                System.out.println("Usage:java filename [SID] [HOST] [PORT]");
            else
            {
                tc_fact = AQjmsFactory.getTopicConnectionFactory(
                    args[1], args[0], Integer.parseInt(args[2]), "oci8");
                t_conn = tc_fact.createTopicConnection( "OE","OE");
                t_sess = t_conn.createTopicSession(true, Session.CLIENT_ACKNOWLEDGE);
                t_conn.start() ;
                publishUserMessages(t_sess);
                publishLcrMessages(t_sess);
                t_sess.close() ;
                t_conn.close() ;
                System.out.println("End of StreamsEnq Demo") ;
            }
        }
    }
}
```

```

    }
}
catch (Exception ex)
{
    System.out.println("Exception-1: " + ex);
    ex.printStackTrace();
}
}

public static void publishUserMessages(TopicSession t_sess) throws Exception
{
    Topic          topic      = null;
    TopicPublisher t_pub      = null;
    JPerson        pers       = null;
    JAddress        addr      = null;
    TextMessage    t_msg      = null;
    AdtMessage      adt_msg    = null;
    AQjmsAgent     agent      = null;
    AQjmsAgent[]   recipList = null;

    try
    {
        topic = ((AQjmsSession)t_sess).getTopic("strmadmin", "oe_queue");
        t_pub = t_sess.createPublisher(topic);
        agent = new AQjmsAgent("explicit_enq", null);
        adt_msg = ((AQjmsSession)t_sess).createAdtMessage();
        pers = new JPerson();
        addr = new JAddress();
        addr.setNum(new java.math.BigDecimal(500));
        addr.setStreet("Oracle Pkwy");
        pers.setName("Mark");
        pers.setHome(addr);
        adt_msg.setAdtPayload(pers);
        ((AQjmsMessage)adt_msg).setSenderID(agent);
        System.out.println("Publish message 1 -type PERSON\n");
        recipList = new AQjmsAgent[1];
        recipList[0] = new AQjmsAgent("explicit_dq", null);
        ((AQjmsTopicPublisher)t_pub).publish(topic, adt_msg, recipList);
        t_sess.commit();

        t_msg = t_sess.createTextMessage();
        t_msg.setText("Test message");
        t_msg.setStringProperty("color", "BLUE");
        t_msg.setIntProperty("year", 1999);
        ((AQjmsMessage)t_msg).setSenderID(agent);
        System.out.println("Publish message 2 -type JMS TextMessage\n");
        ((AQjmsTopicPublisher)t_pub).publish(topic, t_msg, recipList);
        t_sess.commit();
    }
    catch (JMSException jms_ex)
    {
        System.out.println("JMS Exception: " + jms_ex);
        if(jms_ex.getLinkedException() != null)
            System.out.println("Linked Exception: " + jms_ex.getLinkedException());
    }
}

public static void publishLcrMessages(TopicSession t_sess) throws Exception
{
    Topic          topic      = null;

```

```

TopicPublisher      t_pub      = null;
XMLType             xml_lcr    = null;
AdtMessage          adt_msg    = null;
AQjmsAgent          agent     = null;
StringBuffer        lcr_data   = null;
AQjmsAgent[]        recipList = null;
java.sql.Connection db_conn    = null;

try
{
    topic = ((AQjmsSession)t_sess).getTopic("strmadmin", "oe_queue");
    t_pub = t_sess.createPublisher(topic);
    db_conn = ((AQjmsSession)t_sess).getDBConnection();
    agent = new AQjmsAgent("explicit_enq", null);
    adt_msg = ((AQjmsSession)t_sess).createAdtMessage();
    lcr_data = new StringBuffer();

    lcr_data.append("<ROW_LCR ");
    lcr_data.append("xmlns='http://xmlns.oracle.com/streams/schemas/lcr' \n");
    lcr_data.append("xmlns:xsi='http://www.w3.org/2001/XMLSchema-instance' \n");
    lcr_data.append("xsi:schemaLocation='http://xmlns.oracle.com/streams/schemas/lcr ");
    lcr_data.append("http://xmlns.oracle.com/streams/schemas/lcr/streams/lcr.xsd' ");
    lcr_data.append("> \n");
    lcr_data.append("<source_database_name>source_dbname</source_database_name> \n");
    lcr_data.append("<command_type>INSERT</command_type> \n");
    lcr_data.append("<object_owner>Ram</object_owner> \n");
    lcr_data.append("<object_name>Emp</object_name> \n");
    lcr_data.append("<tag>0ABC</tag> \n");
    lcr_data.append("<transaction_id>0.0.0</transaction_id> \n");
    lcr_data.append("<scn>0</scn> \n");
    lcr_data.append("<old_values> \n");
    lcr_data.append("<old_value> \n");
    lcr_data.append("<column_name>C01</column_name> \n");
    lcr_data.append("<data><varchar2>Clob old</varchar2></data> \n");
    lcr_data.append("</old_value> \n");
    lcr_data.append("<old_value> \n");
    lcr_data.append("<column_name>C02</column_name> \n");
    lcr_data.append("<data><varchar2>A123FF</varchar2></data> \n");
    lcr_data.append("</old_value> \n");
    lcr_data.append("<old_value> \n");
    lcr_data.append("<column_name>C03</column_name> \n");
    lcr_data.append("<data> \n");
    lcr_data.append("<date><value>1997-11-24</value><format>SYYYY-MM-DD</format></date> \n");
    lcr_data.append("</data> \n");
    lcr_data.append("</old_value> \n");
    lcr_data.append("<old_value> \n");
    lcr_data.append("<column_name>C04</column_name> \n");
    lcr_data.append("<data> \n");
    lcr_data.append("<timestamp><value>1999-05-31T13:20:00.000</value>");
    lcr_data.append("<format>SYYYY-MM-DD\"T\"HH24:MI:SS.FF</format></timestamp> \n");
    lcr_data.append("</data> \n");
    lcr_data.append("</old_value> \n");
    lcr_data.append("<old_value> \n");
    lcr_data.append("<column_name>C05</column_name> \n");
    lcr_data.append("<data><raw>ABCDE</raw></data> \n");
    lcr_data.append("</old_value> \n");
    lcr_data.append("</old_values> \n");
    lcr_data.append("<new_values> \n");
    lcr_data.append("<new_value> \n");
    lcr_data.append("<column_name>C01</column_name> \n");
    lcr_data.append("<data><varchar2>A123FF</varchar2></data> \n");

```



```

lcr_data.append("</new_value> \n");
lcr_data.append("<new_value> \n");
lcr_data.append("<column_name>C02</column_name> \n");
lcr_data.append("<data><number>35.23</number></data> \n");
lcr_data.append("</new_value> \n");
lcr_data.append("<new_value> \n");
lcr_data.append("<column_name>C03</column_name> \n");
lcr_data.append("<data><number>-100000</number></data> \n");
lcr_data.append("</new_value> \n");
lcr_data.append("<new_value> \n");
lcr_data.append("<column_name>C04</column_name> \n");
lcr_data.append("<data><varchar2>Hello</varchar2></data> \n");
lcr_data.append("</new_value> \n");
lcr_data.append("<new_value> \n");
lcr_data.append("<column_name>C05</column_name> \n");
lcr_data.append("<data><char>world</char></data> \n");
lcr_data.append("</new_value> \n");
lcr_data.append("</new_values> \n");
lcr_data.append("</ROW_LCR>");

xml_lcr = oracle.xdb.XMLType.createXML(db_conn, lcr_data.toString());
adt_msg.setAdtPayload(xml_lcr);
((AQjmsMessage)adt_msg).setSenderID(agent);
System.out.println("Publish message 3 - XMLType containing LCR ROW\n");
recipList = new AQjmsAgent[1];
recipList[0] = new AQjmsAgent("explicit_dq", null);
((AQjmsTopicPublisher)t_pub).publish(topic, adt_msg, recipList);
t_sess.commit();

}
catch (JMSEException jms_ex)
{
    System.out.println("JMS Exception: " + jms_ex);
    if(jms_ex.getLinkedException() != null)
        System.out.println("Linked Exception: " + jms_ex.getLinkedException());
}
}
}
}

```

Example 23-32 Java Code for Dequeuing Messages

```

import oracle.AQ.*;
import oracle.jms.*;
import javax.jms.*;
import java.lang.*;
import oracle.xdb.*;
import java.sql.SQLException;

public class StreamsDeq
{
    public static void main (String args [])
        throws java.sql.SQLException, ClassNotFoundException, JMSEException
    {
        TopicConnectionFactory tc_fact= null;
        TopicConnection      t_conn = null;
        TopicSession         t_sess = null;

        try
        {
            if (args.length < 3 )
                System.out.println("Usage:java filename [SID] [HOST] [PORT]");

```

```

else
{
    tc_fact = AQjmsFactory.getTopicConnectionFactory(
        args[1], args[0], Integer.parseInt(args[2]), "oci8");
    t_conn = tc_fact.createTopicConnection( "OE","OE");

    t_sess = t_conn.createTopicSession(true, Session.CLIENT_ACKNOWLEDGE);
    t_conn.start() ;

    receiveMessages(t_sess);

    t_sess.close() ;
    t_conn.close() ;
    System.out.println("\nEnd of StreamsDeq Demo") ;
}
}
catch (Exception ex)
{
    System.out.println("Exception-1: " + ex);
    ex.printStackTrace();
}
}

public static void receiveMessages(TopicSession t_sess) throws Exception
{
    Topic          topic    = null;
    JPerson        pers     = null;
    JAddress       addr     = null;
    XMLType        xtype    = null;
    TextMessage    t_msg    = null;
    AdtMessage     adt_msg  = null;
    Message        jms_msg  = null;
    TopicReceiver  t_rcv    = null;
    int            i        = 0;
    java.util.Map  map= null;

    try
    {
        topic = ((AQjmsSession)t_sess).getTopic("strmadmin", "oe_queue");
        t_rcv = ((AQjmsSession)t_sess).createTopicReceiver(topic, "explicit_dq", null);
        map = ((AQjmsSession)t_sess).getTypeMap();
        map.put("OE.PERSON", Class.forName("JPerson"));
        map.put("OE.ADDRESS", Class.forName("JAddress"));
        map.put("SYS.XMLTYPE", Class.forName("oracle.xdb.XMLTypeFactory"));
        System.out.println("Receive messages ... \n");
        do
        {
            try
            {
                jms_msg = (t_rcv.receive(10));
                i++;

                ((AQjmsTopicReceiver)t_rcv).setNavigationMode(AQjmsConstants.NAVIGATION_NEXT_MESSAGE);
            }
            catch (JMSEException jms_ex2)
            {
                if((jms_ex2.getLinkedException() != null) &&
                    (jms_ex2.getLinkedException() instanceof SQLException))
                {
                    SQLException sql_ex2 =(SQLException)(jms_ex2.getLinkedException());
                    if(sql_ex2.getErrorCode() == 25235)

```

```

        {
            ((AQjmsTopicReceiver)t_recv).setNavigationMode(
                AQjmsConstants.NAVIGATION_NEXT_TRANSACTION);
            continue;
        }
        else
            throw jms_ex2;
    }
    else
        throw jms_ex2;
}
if(jms_msg == null)
{
    System.out.println("\nNo more messages");
}
else
{
    if(jms_msg instanceof AdtMessage)
    {
        adt_msg = (AdtMessage)jms_msg;

        System.out.println("Retrieved message " + i + ": " +
            adt_msg.getAdtPayload());
        if(adt_msg.getAdtPayload() instanceof JPerson)
        {
            pers =(JPerson)( adt_msg.getAdtPayload());
            System.out.println("PERSON: Name: " + pers.getName());
        }
        else if(adt_msg.getAdtPayload() instanceof JAddress)
        {
            addr =(JAddress)( adt_msg.getAdtPayload());
            System.out.println("ADDRESS: Street" + addr.getStreet());
        }
        else if(adt_msg.getAdtPayload() instanceof oracle.xdb.XMLType)
        {
            xtype = (XMLType)adt_msg.getAdtPayload();
            System.out.println("XMLType: Data: \n" + xtype.getStringVal());
        }
        System.out.println("Msg id: " + adt_msg.getJMSMessageID());
        System.out.println();
    }
    else if(jms_msg instanceof TextMessage)
    {
        t_msg = (TextMessage)jms_msg;

        System.out.println("Retrieved message " + i + ": " +
            t_msg.getText());
        System.out.println("Msg id: " + t_msg.getJMSMessageID());
        System.out.println();
    }
    else
        System.out.println("Invalid message type");
}
} while (jms_msg != null);
t_sess.commit();
}
catch (JMSException jms_ex)
{
    System.out.println("JMS Exception: " + jms_ex);
    if(jms_ex.getLinkedException() != null)
        System.out.println("Linked Exception: " + jms_ex.getLinkedException());
}

```

```
        t_sess.rollback();
    }
    catch (java.sql.SQLException sql_ex)
    {
        System.out.println("SQL Exception: " + sql_ex);
        sql_ex.printStackTrace();
        t_sess.rollback();
    }
}
```

Example 23-33 Compiling StreamsEnq.java and StreamsDeq.java

```
javac StreamsEnq.java StreamsDeq.java JPerson.java JAddress.java
```

Example 23-34 Running StreamsEnq

```
java StreamsEnq ORACLE_SID HOST PORT
```

Example 23-35 Running StreamsDeq

```
java StreamsDeq ORACLE_SID HOST PORT
```

A

Nonpersistent Queues

Oracle Database Advanced Queuing can deliver nonpersistent messages asynchronously to subscribers. These messages can be event-driven and do not persist beyond the failure of the system (or instance). The messages are stored in a system-created queue table. Oracle Database Advanced Queuing supports persistent and nonpersistent messages with a common [API](#).

Nonpersistent queues, which can be either single-consumer or multiconsumer, provide a mechanism for notification to all currently connected users. Subscribers can be added to multiconsumer nonpersistent queues, and nonpersistent queues can be destinations for propagation.

You use the enqueue interface to enqueue messages into a nonpersistent queue in the usual way. You can enqueue RAW and Oracle object type messages into a nonpersistent queue. OCI notifications are used to deliver such messages to users that are currently registered for notification.

The following topics describe nonpersistent queues, which are deprecated in Oracle Database Advanced Queuing 10g Release 2 (10.2). Oracle recommends that you use buffered messaging instead.



See Also:

["Buffered Messaging"](#)

Topics:

- [Creating Nonpersistent Queues](#)
- [Managing Nonpersistent Queues](#)
- [Compatibility of Nonpersistent Queues](#)
- [Nonpersistent Queue Notification](#)
- [Restrictions on Nonpersistent Queues](#)

A.1 Creating Nonpersistent Queues

```
DBMS_AQADM.CREATE_NP_QUEUE (  
  queue_name          IN          VARCHAR2,  
  multiple_consumers IN          BOOLEAN DEFAULT FALSE,  
  comment             IN          VARCHAR2 DEFAULT NULL);
```

This procedure creates a [nonpersistent](#) queue.

Only local recipients are supported for nonpersistent queues. The queue can be either single-consumer or multiconsumer. All queue names must be unique within a schema. The queues are created in an 8.1-compatible system-created queue table (AQ\$_MEM_SC

or `AQ$_MEM_MC`) in the same schema as that specified by the queue name. If the queue name does not specify a schema name, then the queue is created in the login user's schema.



Note:

Names of nonpersistent queues must not be longer than 24 characters. If you attempt to create a nonpersistent queue with a longer name, error ORA-24019 results.

A.2 Managing Nonpersistent Queues

Once a queue is created with `CREATE_NP_QUEUE`, it can be enabled by calling `START_QUEUE`. By default, the queue is created with both enqueue and dequeue disabled.

You can enqueue RAW and Oracle object type messages into a nonpersistent queue. You cannot dequeue from a nonpersistent queue. The only way to retrieve a message from a nonpersistent queue is by using the [Oracle Call Interface \(OCI\)](#) notification mechanism. You cannot invoke the `listen` call on a nonpersistent queue.

A nonpersistent queue can be dropped only by its owner.

A.3 Compatibility of Nonpersistent Queues

For 8.1-style or higher queues, the `compatible` parameter of `init.ora` and the `compatible` parameter of the [queue table](#) should be set to 8.1 or higher to use nonpersistent queues.

A.4 Nonpersistent Queue Notification

For nonpersistent queues, the message is delivered as part of the notification. [Table A-1](#) shows the actions performed for [nonpersistent](#) queues for different notification mechanisms when RAW presentation is specified. [Table A-2](#) shows the actions performed when XML presentation is specified.

Table A-1 Actions Performed for Nonpersistent Queues When RAW Presentation Specified

Queue Payload Type	OCI Callback	E-mail	PL/SQL Callback
RAW	OCI callback receives the RAW data in the payload.	Not supported	PL/SQL callback receives the RAW data in the payload.
Oracle object type	Not supported	Not supported	Not supported

Table A-2 Actions Performed for Nonpersistent Queues When XML Presentation Specified

Queue Payload Type	OCI Callback	E-mail	PL/SQL Callback
RAW	OCI callback receives the XML data in the payload.	XML data is formatted as a SOAP message and e-mailed to the registered e-mail address.	PL/SQL callback receives the XML data in the payload.
Oracle object type	OCI callback receives the XML data in the payload.	XML data is formatted as a SOAP message and e-mailed to the registered e-mail address.	PL/SQL callback receives the XML data in the payload.

A.5 Restrictions on Nonpersistent Queues

You can create nonpersistent queues of `RAW` and Oracle object type. You are limited to sending messages only to subscribers and explicitly specified recipients who are local. Propagation is not supported from nonpersistent queues. When retrieving messages, you cannot use the `dequeue` call, but must instead employ the asynchronous notification mechanism, registering for the notification by mean of `OCISubscriptionRegister`.

The `visibility` attribute of `enqueue_options` must be set to `IMMEDIATE` for nonpersistent messages.



See Also:

["Enqueue Options"](#)

B

Oracle JMS and Oracle AQ XML Servlet Error Messages

A list of error messages is provided to aid you in troubleshooting problems.

- [Oracle JMS Error Messages](#)
- [Oracle AQ XML Servlet Error Messages](#)

B.1 Oracle JMS Error Messages

JMS-101 Invalid delivery mode (string)

Cause: The delivery mode is not supported

Action: The valid delivery mode is `AQjmsConstants.PERSISTENT`

JMS-102 Feature not supported (string)

Cause: This feature is not supported in the current release

Action: Self-explanatory

JMS-104 Message Payload must be specified

Cause: The message payload was null

Action: Specify a non-null payload for the message

JMS-105 Agent must be specified

Cause: `AQjmsAgent` object was null

Action: Specify a valid `AQjmsAgent` representing the remote subscriber

JMS-106 Cannot have more than one open Session on a JMSConnection

Cause: There is already one open JMS session on the connection. Cannot have more than one open session on a connection

Action: Close the open session and then open a new one

JMS-107 Operation not allowed on (string)

Cause: The specified operation is not allowed on this object

Action: Self-explanatory

JMS-108 Messages of type (string) not allowed with Destinations containing payload of type (string)

Cause: There was a mismatch between the message type being used and the payload type specified for the destination

Action: Use the message type that maps to the payload specified for the queue table that contains this destination

JMS-109 Class not found: (string)

Cause: The specified class was not found

Action: Make sure your `CLASSPATH` contains the class

JMS-110 Property (string) not writeable

Cause: An attempt was made to update a read-only message header field or property

Action: Self-explanatory

JMS-111 Connection must be specified

Cause: The connection object was null

Action: Specify a non-null JDBC connection

JMS-112 Connection is invalid

Cause: The JDBC connection is invalid

Action: Specify a non-null oracle JDBC connection

JMS-113 Connection is in stopped state

Cause: An attempt was made to receive messages on a connection that is in stopped state

Action: Start the connection

JMS-114 Connection is closed

Cause: An attempt was made to use a Connection that has been closed

Action: Create a new connection

JMS-115 Consumer is closed

Cause: An attempt was made to use a Consumer that has been closed

Action: Create a new Message Consumer

JMS-116 Subscriber name must be specified

Cause: Subscriber name was null

Action: Specify a non-null subscription name

JMS-117 Conversion failed - invalid property type

Cause: An error occurred while converting the property to the requested type

Action: Use the method corresponding to the property data type to retrieve it

JMS-119 Invalid Property value

Cause: The property value specified is invalid

Action: Use the appropriate type of value for the property being set

JMS-120 Dequeue failed

Cause: An error occurred while receiving the message

Action: See message inside the `JMSException` and linked `SQLException` for more information

JMS-121 DestinationProperty must be specified

Cause: A null AQjmsDestinationProperty was specified while creating a queue/topic

Action: Specify a non-null AQjmsDestinationProperty for the destination

JMS-122 Internal error (string)

Cause: Internal error occurred

Action: Call Support

JMS-123 Interval must be at least (integer) seconds

Cause: An invalid interval was specified

Action: The interval must be greater than 30 seconds

JMS-124 Invalid Dequeue mode

Cause: Invalid dequeue mode was specified

Action: Valid Dequeue modes are AQConstants.DEQUEUE_BROWSE, AQConstants.DEQUEUE_REMOVE, AQConstants.DEQUEUE_LOCKED, AQConstants.DEQUEUE_REMOVE_NODATA

JMS-125 Invalid Queue specified

Cause: An invalid Queue object was specified

Action: Specify a valid Queue handle

JMS-126 Invalid Topic specified

Cause: An invalid Topic object was specified

Action: Specify a valid Topic handle

JMS-127 Invalid Destination

Cause: An invalid destination object was specified

Action: Specify a valid destination (Queue/Topic) object

JMS-128 Invalid Navigation mode

Cause: An invalid navigation mode was specified

Action: The valid navigation modes are AQjmsConstants.NAVIGATION_FIRST_MESSAGE, AQjmsConstants.NAVIGATION_NEXT_MESSAGE, AQjmsConstants.NAVIGATION_NEXT_TRANSACTION

JMS-129 Invalid Payload type

Cause: There was a mismatch between the message type being used and the payload type specified for the destination

Action: Use the message type that maps to the payload specified for the queue table that contains this destination. For ADT messages, use the appropriate CustomDatum factory to create the message consumer

JMS-130 JMS queue cannot be multi-consumer enabled

Cause: An attempt was made to get a AQ multi-consumer queue as a JMS queue

Action: JMS queues cannot be multi-consumer enabled

JMS-131 Session is closed

Cause: An attempt was made to use a session that has been closed

Action: Open a new session

JMS-132 Maximum number of properties (integer) exceeded

Cause: Maximum number of user defined properties for the message has been exceeded

Action: Self-explanatory

JMS-133 Message must be specified

Cause: Message specified was null

Action: Specify a non-null message

JMS-134 Name must be specified

Cause: Queue or Queue table Name specified was null

Action: Specify a non-null name

JMS-135 Driver (string) not supported

Cause: The specified driver is not supported

Action: Valid drivers are oci8 and thin. To use the kprb driver get the kprb connection using getDefaultConnection() and use the static createTopicConnection and createQueueConnection methods

JMS-136 Payload factory can only be specified for destinations with ADT payloads

Cause: A CustomDatumFactory was specified for consumers on destinations not containing ADT payloads

Action: This field must be set to null for destinations containing payloads of type SYS.AQ\$_JMS_TEXT_MESSAGE, SYS.AQ\$_JMS_BYTES_MESSAGE, SYS.AQ\$_JMS_MAP_MESSAGE, SYS.AQ\$_JMS_OBJECT_MESSAGE, SYS.AQ\$_JMS_STREAM_MESSAGE

JMS-137 Payload factory must be specified for destinations with ADT payloads

Cause: CustomDatumFactory was not specified for destinations containing ADT payloads

Action: For destinations containing ADT messages, a CustomDatumFactory for a java class that maps to the SQL ADT type of the destination must be specified

JMS-138 Producer is closed

Cause: An attempt was made to use a producer that has been closed

Action: Create a new Message Producer

JMS-139 Property name must be specified

Cause: Property name was null

Action: Specify a non-null property name

JMS-140 Invalid System property

Cause: Invalid system property name specified.

Action: Specify one of the valid JMS system properties

JMS-142 JMS topic must be created in multi-consumer enabled queue tables

Cause: An attempt was made to create a JMS topic in a single-consumer queue table

Action: JMS topics can only be created in queue tables that are multi-consumer enabled

JMS-143 Queue must be specified

Cause: Null queue was specified

Action: Specify a non-null queue

JMS-144 JMS queue cannot be created in multiconsumer enabled queue tables

Cause: An attempt was made to create a JMS queue in a multi-consumer queue table

Action: JMS queues can only be created in queue tables that are not multi-consumer enabled

JMS-145 Invalid recipient list

Cause: The recipient list specified was empty

Action: Specify a recipient list with at least one recipient

JMS-146 Registration failed

Cause: An error occurred while registering the type in the type map

Action: Self-explanatory

JMS-147 Invalid ReplyTo destination type

Cause: The ReplyTo destination object type is invalid

Action: The ReplyTo destination must be of type AQjmsAgent

JMS-148 Property name size exceeded

Cause: The property name is greater than the maximum size

Action: Specify a property name that is less than 100 characters

JMS-149 Subscriber must be specified

Cause: Subscriber specified was null

Action: Specify a non-null subscriber

JMS-150 Property not supported

Cause: An attempt was made to use a property that is not supported

Action: Self-explanatory

JMS-151 Topics cannot be of type EXCEPTION

Cause: Topics cannot be of type AQjmsConstants.EXCEPTION

Action: Specify topics to be of type AQjmsConstants.NORMAL

JMS-153 Invalid System property type

Cause: The type of the value specified does not match the type defined for the system property being set

Action: Use the correct type for the setting the system property

JMS-154 Invalid value for sequence deviation

Cause: The sequence deviation is invalid

Action: Valid values are `AQEnqueueOption.DEVIATION_BEFORE`, `AQEnqueueOption.DEVIATION_TOP`

JMS-155 AQ Exception (string)

Cause: An error occurred in the AQ java layer

Action: See the message inside the `JMSException` and the linked exception for more information

JMS-156 Invalid Class (string)

Cause: Class specified is invalid

Action: Make sure your `CLASSPATH` has the specified class

JMS-157 IO Exception (string)

Cause: IO exception

Action: See message is `JMSException` for details

JMS-158 SQL Exception (string)

Cause: SQL Exception

Action: See message inside linked `SQLException` for details

JMS-159 Invalid selector (string)

Cause: The selector specified is either invalid or too long

Action: Check the syntax of the selector

JMS-160 EOF Exception (string)

Cause: EOF exception occurred while reading the byte stream

Action: Self-explanatory

JMS-161 MessageFormat Exception: (string)

Cause: An error occurred while converting the stream data to specified type

Action: Check the type of data expected on the stream and use the appropriate read method

JMS-162 Message not Readable

Cause: Message is in write-only mode

Action: Call the reset method to make the message readable

JMS-163 Message not Writeable

Cause: Message is in read-only mode

Action: Use the clearBody method to make the message writeable

JMS-164 No such element

Cause: Element with specified name was not found in the map message

Action: Self-explanatory

JMS-165 Maximum size of property value exceeded

Cause: The property value exceeded the maximum length allowed

Action: Values for JMS defined properties can be a maximum of length of 100, Values for User defined properties can have a maximum length of 2000

JMS-166 Topic must be specified

Cause: Topic specified was null

Action: Specify a non-null topic

JMS-167 Payload factory or Sql_data_class must be specified

Cause: Payload factory or Sql_data_class not specified for queues containing object payloads

Action: Specify a CustomDatumFactory or the SQLData class of the java object that maps to the ADT type defined for the queue.

JMS-168 Cannot specify both payload factory and sql_data_class

Cause: Both CustomDatumFactory and SQLData class were specified during dequeue

Action: Specify either the CustomDatumFactory or the SQLData class of the java object that maps to the ADT type defined for the queue.

JMS-169 Sql_data_class cannot be null

Cause: SQLData class specified is null

Action: Specify the SQLData class that maps to the ADT type defined for the queue

JMS-171 Message is not defined to contain (string)

Cause: Invalid payload type in message

Action: Check if the queue is defined to contain RAW or OBJECT payloads and use the appropriate payload type in the message

JMS-172 More than one queue table matches query (string)

Cause: More than one queue table matches the query

Action: Specify both owner and queue table name

JMS-173 Queue Table (string) not found

Cause: The specified queue table was not found

Action: Specify a valid queue table

JMS-174 Class must be specified for queues with object payloads\n. Use dequeue(deq_option,payload_fact) or dequeue(deq_option, sql_data_cl)

Cause: This dequeue method cannot be used to dequeue from queues with OBJECT payloads

Action: Use the either `dequeue(deq_option, payload_fact)` or `dequeue(deq_option, sql_data_cl)`

JMS-175 DequeueOption must be specified

Cause: `DequeueOption` specified is null

Action: Specify a non-null dequeue option

JMS-176 EnqueueOption must be specified

Cause: `EnqueueOption` specified is null

Action: Specify a non-null enqueue option

JMS-177 Invalid payload type: Use dequeue(deq_option) for raw payload queues

Cause: This method cannot be used to dequeue from queues with RAW payload

Action: Use the `dequeue(deq_option)` method

JMS-178 Invalid Queue name - (string)

Cause: The queue name specified is null or invalid

Action: Specify a queue name that is not null. The queue name must not be qualified with the schema name. The schema name must be specified as the value of the owner parameter

JMS-179 Invalid Queue Table name - (string)

Cause: The queue table name specified is null or invalid

Action: Specify a queue table name that is not null. The queue table name must not be qualified with the schema name. The schema name must be specified as the value of the owner parameter

JMS-180 Invalid Queue Type

Cause: Queue type is invalid

Action: Valid types are `AQConstants.NORMAL` or `AQConstants.EXCEPTION`

JMS-181 Invalid value for wait_time

Cause: Invalid value for wait type

Action: Wait time can be `AQDequeueOption.WAIT_FOREVER`, `AQDequeueOption.WAIT_NONE` or any value greater than 0

JMS-182 More than one queue matches query

Cause: More than one queue matches query

Action: Specify both the owner and name of the queue

JMS-183 No AQ driver registered

Cause: No `AQDriver` registered

Action: Make sure that the AQ java driver is registered. Use `Class.forName("oracle.AQ.AQOracleDriver")`

JMS-184 Queue object is invalid

Cause: The queue object is invalid

Action: The underlying JDBC connection may have been closed. Get the queue handle again

JMS-185 QueueProperty must be specified

Cause: AQQueueProperty specified is null

Action: Specify a non-null AQQueueProperty

JMS-186 QueueTableProperty must be specified

Cause: QueueTableProperty specified is null

Action: Specify a non-null AQQueueTableProperty

JMS-187 Queue Table must be specified

Cause: Queue Table specified is null

Action: Specify a non-null queue table

JMS-188 QueueTable object is invalid

Cause: The queue table object is invalid

Action: The underlying JDBC connection may have been closed. Get the queue table handle again

JMS-189 Byte array too small

Cause: The byte array given is too small to hold the data requested

Action: Specify a byte array that is large enough to hold the data requested or reduce the length requested

JMS-190 Queue (string) not found

Cause: The specified queue was not found

Action: Specify a valid queue

JMS-191 sql_data_cl must be a class that implements SQLData interface

Cause: The class specified does not support the java.sql.SQLData interface

Action: Self-explanatory

JMS-192 Invalid Visibility value

Cause: Visibility value specified is invalid

Action: Valid values are AQConstants.VISIBILITY_ONCOMMIT,
AQConstants.VISIBILITY_IMMEDIATE

JMS-193 JMS queues cannot contain payload of type RAW

Cause: An attempt was made to create a JMS queue with RAW payload

Action: JMS queues/topics cannot contain RAW payload

JMS-194 Session object is invalid

Cause: Session object is invalid

Action: The underlying JDBC connection may have been closed. Create a new session

JMS-195 Invalid object type: object must implement CustomDatum or SQLData interface

Cause: Invalid object type specified

Action: Object must implement CustomDatum or SQLData interface

JMS-196 Cannot have more than one open QueueBrowser for the same destination on a JMS Session

Cause: There is already an open QueueBrowser for this queue on this session

Action: There cannot be more than one queue browser for the same queue in a particular session. Close the existing QueueBrowser and then open a new one

JMS-197 Agent address must be specified for remote subscriber

Cause: Address field is null for remote subscriber

Action: The address field must contain the fully qualified name of the remote topic

JMS-198 Invalid operation: Privileged message listener set for the Session

Cause: The client tried to use a message consumer to receive messages when the session message listener was set.

Action: Use the session's message listener to consume messages. The consumer's methods for receiving messages must not be used.

JMS-199 Registration for notification failed

Cause: Listener Registration failed

Action: See error message in linked Exception for details

JMS-200 Destination must be specified

Cause: Destination is null

Action: Specify a non-null destination

JMS-201 All Recipients in recipient_list must be specified

Cause: One or more elements in the recipient list are null

Action: All AQjmsAgents in the recipient list must be specified

JMS-202 Unregister for asynchronous receipt of messages failed

Cause: An error occurred while removing the registration of the consumer with the database for asynchronous receipt

Action: Check error message in linked exception for details

JMS-203 Payload Factory must be specified

Cause: Null Payload Factory was specified

Action: Specify a non null payload factory

JMS-204 An error occurred in the AQ JNI layer

Cause: JNI Error

Action: Check error message in linked exception for details

JMS-205 Naming Exception

Cause: Naming exception

Action: Check error message in linked exception for details

JMS-207 JMS Exception (string)

Cause: An error occurred in the JMS layer

Action: See the message inside the linked JMSEException for more information

JMS-208 XML SQL Exception

Cause: An error occurred in the XML SQL layer

Action: See the message inside the linked AQxmlException for more information

JMS-209 XML SAX Exception

Cause: An error occurred in the XML SAX layer

Action: See the message inside the linked AQxmlException for more information

JMS-210 XML Parse Exception

Cause: An error occurred in the XML Parser layer

Action: See the message inside the linked AQxmlException for more information

JMS-220 Connection no longer available

Cause: Connection to the database no longer available.

Action: Comment: This may happen if the database/network/machine is not accessible. This may be a transient failure.

JMS-221 Free physical database connection unavailable in connection pool

Cause: A free physical database connection was not available in the OCI connection pool in order to perform the specified operation.

Action: Try performing the operation later

JMS-222: Invalid Payload factory type

Cause: Payload factory should be of CustomDatumFactory or ORADDataFactory type.

Action: Use one of CustomDatumFactory/ORADDataFactory types.

JMS-223: Payload factory must be null for destinations with Sys.AnyData payload - use typemap instead

Cause: A CustomDatumFactory/ORADDataFactory was specified for consumers on destinations containing SYS.ANYDATA payloads

Action: This field must be set to null for destinations containing payloads of type SYS.AnyData. The ORADDataFactory(s) must be registered in the session's typemap

JMS-224: Typemap is invalid - must be populated with SQLType/ OraDataFactory mappings to receive messages from Sys.AnyData destinations

Cause: The typemap of the session is null or empty. For destinations of type Sys.AnyData, the typemap must contain OraDataFactory objects for all possible types that may be stored in the queue/topic

Action: Use the `AQjmsSession.getTypeMap()` method get the `typemap`. Then use the `put()` method to register `SQLType` names and their corresponding `OraDataFactory` objects

JMS-225: Invalid JDBC driver - OCI driver must be used for this operation

Cause: Operations on `Sys.AnyData` queues/topics are not supported using this JDBC driver

Action: Use the JDBC OCI driver to receive messages from `Sys.AnyData` queues/topics

JMS-226: Header-only Message does not have a body

Cause: Header-only message does not have a body; the body cannot be cleared, changed, or queried.

Action: Do not access or modify the body of a read-only message.

JMS-227: Illegal attempt to commit on a non transacted JMS Session

Cause: Illegal attempt to invoke the `commit` method on a non transacted JMS Session

Action: Remove invocation of the `commit` method on the current JMS Session

JMS-228: Illegal attempt to rollback on a non transacted JMS Session

Cause: Illegal attempt to invoke the `rollback` method on a non transacted JMS Session

Action: Remove invocation of the `rollback` method on the current JMS Session

JMS-229: (string) must be specified

Cause: The specified parameter was null

Action: Specify a non-null value for the parameter

JMS-230: Illegal operation on durable subscription with active TopicSubscriber

Cause: Try to unsubscribe, change or create durable subscription while it has an active `TopicSubscriber`.

Action: Close the active `TopicSubscriber` and try again.

JMS-231: Consumers on temporary destination must belong to the same

Cause: The specified parameter was null

Action: Specify a non-null value for the parameter

JMS-232: An invalid user/password was specified for the JMS connection

Cause: Invalid user/password specified for connection

Action: Specify valid user/password for connection

JMS-233: The required subscriber information is not available

Cause: Try to retrieve subscriber information from a subscriber which was obtained with `getDurableSubscriber` method and had no corresponding information in the in-memory map.

Action: Do not retrieve subscriber information from such a subscriber

JMS-234: This operation is not allowed in the current messaging domain

Cause: Perform an operation that is not allowed in the current messaging domain

Action: Do not perform the operation in the current messaging domain

JMS-235: Can not link the durable subscriber name with a topic in unsubscribe method.

Cause: OJMS is unable to link the supplied durable subscriber name with a topic. This causes unsubscribe method to fail.

Action: Use other unsubscribe methods which the user can provide topic name.

JMS-236: OJMS encountered invalid OCI handles.

Cause: OJMS encountered invalid OCI handles when using JDBC OCI driver .

Action: Make sure the underlying JDBC connection is not closed while OJMS is still operating.

JMS-237: Can not start thread for message listener.

Cause: OJMS is unable to start a new thread for message listener.

Action: Check the thread proxy code if the thread was started by a user provided thread proxy.

JMS-238: Illegal attempt to recover on a transacted JMS Session

Cause: Illegal attempt to invoke the recover method on a transacted JMS Session

Action: Use rollback method instead of recover method on transacted JMS session.

JMS-239: Illegal attempt to call (string) method on a XASession.

Cause: Illegal attempt to invoke the commit or rollback method on a XASession

Action: Use JTA to commit or rollback a distributed transaction

JMS-240: Illegal attempt to call setClientID after other actions.

Cause: Illegal attempt to call Connection.setClientID method after other actions has been taken on this Connection

Action: set client ID before any other action on the Connection

JMS-241: Illegal attempt to delete temporary destination when there are consumers using it.

Cause: Illegal attempt to delete temporary destination while there are existing consumers still using it.

Action: close the consumers before deleting the temporary destination

JMS-242: Illegal attempt to enqueue message with both immediate visibility and three phase enqueue process.

Cause: Illegal attempt to enqueue message with both immediate visibility and three phase enqueue process.

Action: turn on the system property oracle.jms.useTemplobsForEnqueue

JMS-243: Topic (string) not found}

Cause: The specified topic was not found

Action: Specify a valid topic

B.2 Oracle AQ XML Servlet Error Messages

JMS-400 Destination name must be specified

Cause: A null Destination name was specified

Action: Specify a non-null destination name

JMS-402 Class not found: {0}

Cause: The specified class was not found

Action: Make sure your `CLASSPATH` contains the class specified in the error message

JMS-403 IO Exception {0}

Cause: IO exception

Action: See the message inside the linked `AQxmlException` for more information

JMS-404 XML Parse Exception

Cause: An error occurred in the XML Parser layer

Action: See the message inside the linked `AQxmlException` for more information

JMS-405 XML SAX Exception

Cause: An error occurred in the XML SAX layer

Action: See the message inside the linked `AQxmlException` for more information

JMS-406 JMS Exception {0}

Cause: An error occurred in the JMS layer

Action: See the message inside the linked `JMSException` for more information

JMS-407 Operation not allowed on {0}

Cause: The specified operation is not allowed on this object

Action: Check that the user performing the operation has the required privileges

JMS-408 Conversion failed - invalid property type

Cause: An error occurred while converting the property to the requested type

Action: Use the method corresponding to the property data type to retrieve it

JMS-409 No such element

Cause: Element with specified name was not found in the map message

Action: Specify a valid element name

JMS-410 XML SQL Exception

Cause: An error occurred in the JDBC SQL layer

Action: See the message inside the linked `SQLException` for more information

JMS-411 Payload body cannot be null

Cause: An invalid body string or document was specified

Action: Specify a non-null body string or document for the payload

JMS-412 Byte conversion failed

Cause: An invalid username/password was specified

Action: Specify a non-null username and password

JMS-413 Autocommit not allowed for operation

Cause: The autocommit flag cannot be set for this operation

Action: Do not set the autocommit flag

JMS-414 Destination owner must be specified

Cause: A null Destination owner was specified

Action: Specify a non-null destination name

JMS-415 Invalid Visibility value

Cause: Visibility value specified is invalid

Action: Valid values are AQxmlConstants.VISIBILITY_ONCOMMIT,
AQxmlConstants.VISIBILITY_IMMEDIATE

JMS-416 Invalid Dequeue mode

Cause: Invalid dequeue mode was specified

Action: Valid Dequeue modes are AQxmlConstants.DEQUEUE_BROWSE,
AQxmlConstants.DEQUEUE_REMOVE, AQxmlConstants.DEQUEUE_LOCKED,
AQxmlConstants.DEQUEUE_REMOVE_NODATA

JMS-417 Invalid Navigation mode

Cause: An invalid navigation mode was specified

Action: The valid navigation modes are:

- AQxmlConstants.NAVIGATION_FIRST_MESSAGE
- AQxmlConstants.NAVIGATION_NEXT_MESSAGE
- AQxmlConstants.NAVIGATION_NEXT_TRANSACTION

JMS-418 Invalid value for wait_time

Cause: Invalid value for wait type

Action: Wait time can be AQDequeueOption.WAIT_FOREVER,
AQDequeueOption.WAIT_NONE, or any value greater than 0

JMS-419 Invalid ConnectionPoolDataSource

Cause: A null or invalid ConnectionPoolDataSource was specified

Action: Specify a valid OracleConnectionPoolDataSource object with the correct URL
and user/password

JMS-420 Invalid value for cache_size

Cause: An invalid cache_size was specified

Action: Cache size must be greater than 0

JMS-421 Invalid value for cache_scheme

Cause: An invalid cache scheme was specified

Action: The valid cache schemes are:

- OracleConnectionCacheImpl.DYNAMIC_SCHEME
- OracleConnectionCacheImpl.FIXED_WAIT_SCHEME

JMS-422 Invalid tag - {0}

Cause: An invalid tag was encountered in the XML document

Action: Verify that the XML document conforms to the AQ schema

JMS-423 Invalid value

Cause: An invalid value was specified

Action: Verify that the value specified in the XML document conforms to those specified in the AQ schema

JMS-424 Invalid message header

Cause: The message header specified is null or invalid

Action: Specify a valid message header

JMS-425 Property name must be specified

Cause: Property name was null

Action: Specify a non-null property name

JMS-426 Property does not exist

Cause: Invalid property name specified. The property does not exist

Action: The property does not exist

JMS-427 Subscriber name must be specified

Cause: Subscriber name was null

Action: Specify a non-null subscription name

JMS-428 Valid message must be specified

Cause: Message was null

Action: Specify a non-null message

JMS-429 Register Option must be specified

Cause: Register option is null

Action: Specify a non-null Register Option

JMS-430 Database Link must be specified

Cause: DB Link is null

Action: Specify a non-null Register Option

JMS-431 Sequence Number must be specified

Cause: Register option is null

Action: Specify a non-null Register Option

JMS-432 Status must be specified

Cause: Status option is null

Action: Specify a non-null Register Option

JMS-433 User not authenticated

Cause: User is not authenticated

Action: Check that the user was authenticated by the webserver before connecting to the Servlet

JMS-434 Invalid data source

Cause: Data source is null or invalid

Action: Specify a valid data source for connecting to the database

JMS-435 Invalid schema location

Cause: Schema location is null or invalid

Action: Specify a valid URL for the schema

JMS-436 AQ Exception

Cause: An error occurred in the AQ java layer

Action: See the message inside the AQxmlException and the linked exception for more information

JMS-437 Invalid Destination

Cause: An invalid destination object was specified

Action: Specify a valid destination (Queue/Topic) object

JMS-438 AQ agent {0} not mapped to a valid database user

Cause: The AQ agent specified does not map to a database user which has privileges to perform the requested operation

Action: Use `dbms_aqadm.enable_db_access` to map the agent to a database user with the required queue privileges

JMS-439 Invalid schema document

Cause: The schema document specified is not valid

Action: Specify a valid URL for the schema document

JMS-440 Invalid operations - agent {0} maps to more than one database user

Cause: The AQ agent mapped to more than one database user in the same session

Action: Map the AQ agent to only one database user. Check the `aq$internet_users` view for database users that map to this agent.

JMS-441: {0} cannot be null

Cause: The specified parameter was null

Action: Specify a non-null value

JMS-442: Name and Address for Agent cannot be null

Cause: Both the name and address parameters were specified as null

Action: Specify a non-null value for the name or address

JMS-443: IMMEDIATE visibility mode not supported for this queue/topic

Cause: IMMEDIATE visibility mode not supported for JMS type queue/topic

Action: Use ON_COMMIT or the default visibility mode for JMS type queue/topic

JMS-444: This feature is not supported yet

Cause: The requested feature is not yet supported

Action: wait for future releases that support the feature.

JMS-445: Destination alias must be specified

Cause: A null Destination alias was specified

Action: Specify a non-null destination alias

JMS-446: Agent alias must be specified

Cause: A null Agent alias was specified

Action: Specify a non-null agent alias

JMS-447: error in accessing LDAP server

Cause: error in accessing the LDAP server

Action: check the LDAP server is up and the environment parameters provided to the servlet are correct

JMS-448: Invalid Content-Type

Cause: Invalid Content-Type

Action: Content-Type must be "text/xml" or "application/x-www-form-urlencoded" with parameter name "aqxmlDoc"

Glossary

ADT

Abstract data type.

API

See [application programming interface](#).

application programming interface

The calling conventions by which an application program accesses operating system and other services.

approximate CSCN

An approximate system change number value, based on the current SCN of the database when a transaction that has enqueued messages into a commit-time queue is committed.

asynchronous

A process in a multitasking system is asynchronous if its execution can proceed independently in the background. Other processes can be started before the asynchronous process has finished. The opposite of [synchronous](#).

BFILE

An external binary file that exists outside the database tablespaces residing in the operating system.

binary large object

A [large object](#) datatype whose content consists of binary data. This data is considered raw, because its structure is not recognized by the database.

BLOB

See [binary large object](#).

broadcast

A [publish/subscribe](#) mode in which the [message producer](#) does not know the identity of any message [consumer](#). This mode is similar to a radio or television station.

buffered queue

Buffered queues support queuing of messages with buffered attributes (buffered messages) and materialize them in memory. If the memory devoted to a buffered message is required for a newer message, or if a buffered message has exceeded a

stipulated duration in memory, then that buffered message is swapped to the underlying queue table. The memory for buffered messages comes from a separate pool called the streams pool. Buffered messages cannot be recovered if the database is bounced. Messages that have no buffered attributes set are queued as persistent messages in the underlying persistent queue.

canonical

The usual or standard state or manner of something.

character large object

The [large object](#) datatype whose value is composed of character data corresponding to the database character set. A character large object can be indexed and searched by the Oracle Text search engine.

CLOB

See [character large object](#).

ConnectionFactory

A ConnectionFactory encapsulates a set of connection configuration parameters that has been defined by an administrator. A client uses it to create a connection with a [Java Message Service](#) provider.

commit-time queue

A queue in which messages are ordered by their approximate CSCN values.

consumer

A user or application that can [dequeue](#) messages.

data manipulation language

Data manipulation language (DML) statements manipulate database data. For example, querying, inserting, updating, and deleting rows of a table are all DML operations; locking a table or view and examining the execution plan of an SQL statement are also DML operations.

Database Configuration Assistant

An Oracle Database tool for creating and deleting databases and for managing database templates.

DBCA

See [Database Configuration Assistant](#).

dequeue

To retrieve a [message](#) from a queue

DML

See [data manipulation language](#).

enqueue

To place a [message](#) in a queue. The JMS equivalent of enqueue is [send](#).

exception queue

Messages are transferred to an exception [queue](#) if they cannot be retrieved and processed for some reason.

IDAP

See [Internet Data Access Presentation](#).

index-organized table

Unlike an ordinary table whose data is stored as an unordered collection, data for an index-organized table is stored in a B-tree index structure sorted on a primary key. Besides storing the primary key column values of an index-organized table row, each index entry in the B-tree stores the nonkey column values as well.

Internet Data Access Presentation

The [Simple Object Access Protocol](#) (SOAP) specification for Oracle Database Advanced Queuing operations. IDAP defines the XML message structure for the body of the SOAP request. An IDAP-structured [message](#) is transmitted over the Internet using HTTP(S).

Inter-process Communication

Exchange of data between one process and another, either within the same computer or over a network. It implies a protocol that guarantees a response to a request.

IOT

See [index-organized table](#).

IPC

See [Inter-process Communication](#).

Java Database Connectivity

An industry-standard Java interface for connecting to a relational database from a Java program, defined by Sun Microsystems.

Java Message Service

A messaging standard defined by Sun Microsystems, Oracle, IBM, and other vendors. JMS is a set of interfaces and associated semantics that define how a JMS client accesses the facilities of an enterprise messaging product.

Java Naming and Directory Interface

A programming interface from Sun for connecting Java programs to naming and directory services.

Java Virtual Machine

The Java interpreter that converts the compiled Java bytecode into the machine language of the platform and runs it. JVMs can run on a client, in a browser, in a

middle tier, on an intranet, on an application server such as Oracle Application Server 10g, or in a database server such as Oracle Database 10g.

JDBC

See [Java Database Connectivity](#).

JDBC driver

The vendor-specific layer of [Java Database Connectivity](#) that provides access to a particular database. Oracle Database provides three JDBC drivers--Thin, [OCI](#), and [KPRB](#).

JMS

See [Java Message Service](#).

JMS connection

An active connection of a client to its JMS provider, typically an open TCP/IP socket (or a set of open sockets) between a client and a provider's service daemon.

JMS message

JMS messages consist of a header, one or more optional properties, and a message payload.

JMS session

A single threaded context for producing and consuming messages.

JMS topic

Equivalent to a multiconsumer queue in the other Oracle Database Advanced Queuing interfaces.

JNDI

See [Java Naming and Directory Interface](#).

Jnnn

Job queue process

JServer

The Java Virtual Machine that runs within the memory space of Oracle Database.

JVM

See [Java Virtual Machine](#)

large object

The class of SQL datatype consisting of [BFILE](#), [BLOB](#), [CLOB](#), and [NCLOB](#) objects.

LDAP

See [Lightweight Directory Access Protocol](#)

Lightweight Directory Access Protocol

A standard, extensible directory access protocol. It is a common language that LDAP clients and servers use to communicate. The framework of design conventions supporting industry-standard directory products, such as the Oracle Internet Directory.

LOB

See [large object](#)

local consumer

A local [consumer](#) dequeues the [message](#) from the same queue into which the [producer](#) enqueued the message.

logical change record

An object with a specific format that describes a database change, captured from the redo log by a capture process or user application. Capture processes enqueue messages containing logical change records (LCRs) only into `ANYDATA` queues. For improved performance, these LCRs are always stored in a [buffered queue](#).

message

The smallest unit of information inserted into and retrieved from a [queue](#). A message consists of control information (metadata) and payload (data).

multicast

A [publish/subscribe](#) mode in which the [message producer](#) knows the identity of each [consumer](#). This mode is also known as point-to-multipoint.

national character large object

The [large object](#) datatype whose value is composed of character data corresponding to the database national character set.

NCLOB

See [national character large object](#).

nonpersistent

Nonpersistent queues store messages in memory. They are generally used to provide an [asynchronous](#) mechanism to send notifications to all users that are currently connected. Nonpersistent queues are deprecated in Oracle Database Advanced Queuing 10g Release 2 (10.2). Oracle recommends that you use buffered messaging instead.

nontransactional

Allowing enqueueing and dequeuing of only one [message](#) at a time.

object type

An object type encapsulates a data structure along with the functions and procedures needed to manipulate the data. When you define an object type using the `CREATE TYPE` statement, you create an abstract template that corresponds to a real-world object.

OCI

See [Oracle Call Interface](#).

Oracle JMS

See [Oracle Java Message Service](#).

OLTP

See [Online Transaction Processing](#).

Online Transaction Processing

Online transaction processing systems are optimized for fast and reliable transaction handling. Compared to data warehouse systems, most OLTP interactions involve a relatively small number of rows, but a larger group of tables.

Oracle Call Interface

An application programming interface that enables data and [schema](#) manipulation in Oracle Database.

Oracle Java Message Service

Oracle Java Message Service (Oracle JMS) provides a Java [API](#) for Oracle Database Advanced Queuing based on the [Java Message Service](#) (JMS) standard. Oracle JMS supports the standard JMS interfaces and has extensions to support the Oracle Database Advanced Queuing administrative operations and other Oracle Database Advanced Queuing features that are not a part of the standard.

producer

A user or application that can [enqueue](#) messages.

propagation

Copying messages from one queue to another (local or remote) queue.

publish/subscribe

A type of messaging in which a [producer](#) enqueues a [message](#) to one or more multiconsumer queues, and then the message is dequeued by several subscribers. The published message can have a wide dissemination mode called [broadcast](#) or a more narrowly aimed mode called [multicast](#).

QMNC

Queue monitor coordinator. It dynamically spawns slaves qXXX depending on the system load. The slaves do various background tasks.

QMn

Queue monitor process.

queue

The abstract storage unit used by a messaging system to store messages.

queue table

A database table where queues are stored. Each queue table contains a default [exception queue](#).

recipient

An agent authorized by the enqueuer or queue administrator to retrieve messages. The enqueuer can explicitly specify the consumers who can retrieve the [message](#) as recipients of the message. A queue administrator can specify a default list of recipients who can retrieve messages from a queue. A recipient specified in the default list is known as a [subscriber](#). If a message is enqueued without specifying the recipients, then the message is sent to all the subscribers. Specific messages in a queue can be directed toward specific recipients, who may or may not be subscribers to the queue, thereby overriding the subscriber list.

If only the name of the recipient is specified, then the recipient must dequeue the message from the queue in which the message was enqueued. If the name and an address of the recipient are specified with a protocol value of 0, then the address should be the name of another queue in the same database or another installation of Oracle Database. If the recipient's name is `NULL`, then the message is propagated to the specified queue in the address and can be dequeued by any subscriber of the queue specified in the address. If the protocol field is nonzero, then the name and address are not interpreted by the system, and the message can be dequeued by a special [consumer](#).

remote consumer

A remote [consumer](#) dequeues from a queue that is different from the queue where the [message](#) was enqueued.

result cache

A Result Cache can be defined as a cache of results of an evaluation for a set of argument values. In case of [rules engine](#) a result cache refers to cache of results pertaining to Rule Set, Rule and Independent Expression evaluations given certain input arguments

rules

Boolean expressions that define [subscriber](#) interest in subscribing to messages. The expressions use syntax similar to the `WHERE` clause of a SQL query and can include conditions on: message properties (currently priority and correlation identifier), user data properties (object payloads only), and functions. If a rule associated with a subscriber evaluates to `TRUE` for a [message](#), then the message is sent to that subscriber even if the message does not have a specified [recipient](#).

rules engine

Oracle Database software that evaluates rules. Rules are database objects that enable a client to perform an action when an event occurs and a condition is satisfied. Rules are similar to conditions in `WHERE` clauses of SQL queries. Both user-created

applications and Oracle Database features, such as Oracle Database Advanced Queuing, can be clients of the rules engine.

schema

A collection of database objects, including logical structures such as tables, views, sequences, stored procedures, synonyms, indexes, clusters, and database links. A schema has the name of the user who controls it.

send

The JMS equivalent of [enqueue](#).

servlet

A Java program that runs as part of a network service and responds to requests from clients. It is typically an HTTP server.

SGA

See [System Global Area](#).

sharded queue

A single logical queue that is divided into multiple, independent, physical queues through system-maintained partitioning.

Simple Object Access Protocol

A minimal set of conventions for invoking code using XML over HTTP defined by World Wide Web Consortium.

SOAP

See [Simple Object Access Protocol](#).

subscriber

An agent authorized by a queue administrator to retrieve messages from a [queue](#).

System Global Area

A group of shared memory structures that contain data and control information for one Oracle Database instance. The SGA and Oracle Database processes constitute an Oracle Database instance. Oracle Database automatically allocates memory for an SGA whenever you start an instance and the operating system reclaims the memory when you shut down the instance. Each instance has one and only one SGA.

synchronous

Two or more processes are synchronous if they depend upon the occurrences of specific events such as common timing signals. The opposite of [asynchronous](#).

transactional

Allowing simultaneous enqueueing or dequeuing of multiple messages as part of a group.

transformation

A mapping from one Oracle data type to another, represented by a SQL function that takes the source data type as input and returns an object of the target data type. A transformation can be specified during [enqueue](#), to transform the [message](#) to the correct type before inserting it into the [queue](#). It can be specified during [dequeue](#) to receive the message in the wanted format. If specified with a [remote consumer](#), then the message is transformed before propagating it to the destination queue.

user queue

A [queue](#) for normal [message](#) processing.

VARRAY

An ordered set of data elements. All elements of a given array are of the same datatype. Each element has an index, which is a number corresponding to the element's position in the array. The number of elements in an array is the size of the array. Oracle Database allows arrays to be of variable size.

wildcard

A special character or character sequence which matches any character in a string comparison.

workflow

The set of relationships between all the activities in a project or business transaction, from start to finish. Activities are related by different types of trigger relations. Activities can be triggered by external events or by other activities.

Index

A

- access
 - object types, [4-3](#)
- access control
 - destination level in JMS, [11-8](#)
 - queue-level, [1-2](#)
 - system level, [1-2](#)
 - in JMS, [11-8](#)
- adding subscribers, [8-27](#)
- administration
 - Messaging Gateway, [17-3](#)
- administrative interfaces to Oracle Database AQ
 - comparison, [3-6](#)
- AdtMessage
 - about, [11-14](#)
 - creating, [15-4](#)
- agent user
 - creating Messaging Gateway agent, [18-5](#)
- agents
 - AQjms agent
 - creating, [15-9](#)
 - Messaging Gateway
 - about, [17-4](#)
 - configuring agent, [19-1](#)
 - monitoring, [21-3](#)
 - running agent on Oracle RAC, [19-5](#)
 - shutting down agent, [19-3](#)
 - starting agent, [19-3](#)
- alias
 - adding to LDAP server, [8-38](#)
 - deleting from LDAP server, [8-38](#)
 - parameters
 - alias, [8-38](#)
 - obj_location, [8-38](#)
- ALL_QUEUE_SUBSCRIBERS, [9-12](#)
- ALL_QUEUE_TABLES
 - Queue Tables Queue Accessible to the Current User, [9-3](#)
- ALL_QUEUES, [9-4](#)
- altering
 - AQ agents, [8-37](#)
 - propagations, [8-34](#)
 - queue tables, [8-9](#)
 - queues, [8-17](#)
- altering (*continued*)
 - subscribers, [8-29](#)
 - transformations, [8-24](#)
- ANYDATA datatype
 - apply process, configuring, [23-7](#)
 - dequeuing
 - examples, [22-8](#), [23-16](#)
 - explicit, configuring, [23-11](#)
 - using JMS, [22-4](#)
 - using OCI, [22-4](#)
 - using PL/SQL, [22-4](#)
 - enqueueing
 - examples, [22-6](#), [23-13](#)
 - procedures, creating, [23-4](#)
 - using JMS, [22-3](#)
 - using OCI, [22-3](#)
 - using PL/SQL, [22-3](#)
 - message propagation, [22-5](#)
 - propagation examples, [22-10](#), [22-13](#)
 - queue table, [8-6](#)
 - queues
 - about, [22-1](#)
 - creating, [23-2](#)
 - wrapper for messages, [22-2](#)
- ANYDATA.ConvertObject, [22-3](#)
- application development
 - about, [1-6](#)
 - client/server communication, [1-7](#)
 - Internet operations, [1-6](#)
 - publish/subscribe, [1-11](#)
 - third-party messaging, [1-6](#)
 - workflows, [1-10](#)
- apply process
 - configuring, [23-7](#)
 - query for applied messages, [23-16](#)
- AQ agents
 - adding to LDAP server, [10-25](#)
 - altering, [8-37](#)
 - creating, [8-36](#)
 - dropping, [8-37](#)
 - parameters
 - agent_name, [8-36](#)
 - certificate_location, [8-36](#)
 - enable_anyp, [8-36](#)
 - enable_http, [8-36](#)

AQ agents (*continued*)
 removing from LDAP server, [10-26](#)

AQ background architecture, [xxxvi](#), [2-9](#)

AQ Message Properties Type, [2-5](#)

AQ servlet
 deploying, [6-5](#)
 responses using HTTP, [6-4](#)

AQ system privilege
 granting, [8-25](#)
 in JMS, [12-14](#)
 revoking, [8-25](#)
 in JMS, [12-15](#)

AQ_ADMINISTRATOR_ROLE
 and LDAP, [11-3](#)
 and registerConnectionFactory, [12-3](#)
 definition, [4-2](#)
 needed for JMS, [3-4](#)

AQ_MsgProperties, [19-28](#)

AQ_TM_PROCESSES parameter, [2-8](#)

AQ_USER_ROLE
 definition, [4-3](#)
 needed for JMS, [3-4](#)

AQ\$AGENT, [2-2](#)

AQ\$AGENT_LIST_T, [2-3](#)

AQ\$POST_INFO_LIST, [2-3](#)

AQ\$QUEUE_TABLE_NAME_D, [8-6](#)

AQ\$QUEUE_TABLE_NAME_E, [8-2](#)

AQ\$QUEUE_TABLE_NAME_H, [8-2](#)

AQ\$QUEUE_TABLE_NAME_I, [8-2](#)

AQ\$QUEUE_TABLE_NAME_P, [8-6](#)

AQ\$QUEUE_TABLE_NAME_S, [8-2](#)

AQ\$QUEUE_TABLE_NAME_T, [8-2](#)

AQ\$RECIPIENT_LIST_T, [2-3](#)

AQ\$REG_INFO_LIST, [2-3](#)

AQ\$SUBSCRIBER_LIST_T, [2-3](#)

AQ\$INTERNET_USERS, [9-15](#)

AQ\$QUEUE_TABLE_NAME, [9-5](#)

AQ\$QUEUE_TABLE_NAME_R, [9-10](#)

AQ\$QUEUE_TABLE_NAME_S, [9-10](#)

AQjms agent
 creating, [15-9](#)

architecture
 application development, [1-6](#)
 Internet operations, [1-39](#), [6-1](#)
 Messaging Gateway, [17-3](#)

arrays
 dequeuing
 about, [1-24](#)
 buffered messages, [10-21](#)
 syntax, [10-21](#)
 enqueueing
 about, [1-22](#)
 syntax, [10-11](#)

asynchronous notifications
 about, [1-18](#)

asynchronous notifications (*continued*)
 buffered messages, [1-18](#)
 designated port, [1-18](#)
 purge following, [1-18](#)
 RAW payload delivery, [1-18](#)
 reliability, [1-18](#)
 timeout, [1-18](#)

asynchronous receive in JMS, [11-30](#)

B

batch dequeuing, [10-21](#)

batch enqueueing, [10-11](#)

BFILE objects
 propagating, [4-11](#)

Boolean message property (JMS)
 getting, [15-15](#)
 setting, [15-5](#)

broadcasting
 definition, [1-12](#)

buffered messages
 about, [1-14](#)
 dequeuing, [1-14](#)
 options, [1-16](#)
 enqueueing, [1-14](#)
 exception handling, [1-14](#)
 flow control, [1-14](#)
 listen_delivery_mode, [10-12](#)
 MSG_STATE parameter, [9-6](#)
 notification, [1-18](#)
 ordering, [1-15](#)
 propagation, [1-14](#)
 queue-to-queue propagation, [1-17](#)
 restrictions, [1-14](#)
 tuning, [5-9](#)
 types supported, [1-15](#)
 views, [1-15](#)
 visibility, [1-15](#)
 with Messaging Gateway, [17-6](#)
 with Oracle JMS, [11-16](#)
 with Oracle Real Application Clusters, [1-14](#)

buffered queues, [8-6](#)

byte message property (JMS)
 getting, [15-16](#)
 setting, [15-6](#)

BytesMessage
 about, [11-13](#)
 creating, [15-3](#)
 example, [16-5](#)

C

catxldr.sql, [22-3](#)

CLASSPATH
 Messaging Gateway, [18-11](#)

- closing
 - JMS Connection, [15-17](#)
 - JMS Session, [15-17](#)
 - message consumer, [15-17](#)
 - MessageProducer, [15-17](#)
 - commit
 - all operations in JMS Session, [15-2](#)
 - transaction, [6-14](#)
 - commit-time ordering
 - about, [1-22](#)
 - example, [8-2](#)
 - requirements, [8-5](#)
 - compatibility
 - about, [4-1](#)
 - and Oracle Real Application Clusters, [1-5](#)
 - migrating queue tables, [8-13](#)
 - nonpersistent queues, [A-2](#)
 - security, [4-3](#)
 - concurrent processes
 - tuning for Oracle Database AQ, [5-7](#)
 - Connection (JMS)
 - creating
 - with default ConnectionFactory parameters, [13-2](#), [14-2](#)
 - with user name/password, [13-1](#), [14-2](#)
 - getting JDBC connection from JMS Session, [15-2](#)
 - ConnectionFactory
 - getting
 - in LDAP, [12-8](#)
 - objects, [11-2](#)
 - registering
 - through database using JDBC connection parameters, [12-1](#)
 - through database using JDBC URL, [12-2](#)
 - through LDAP using JDBC connection parameters, [12-3](#)
 - through LDAP using JDBC URL, [12-4](#)
 - unregistering
 - in LDAP through LDAP, [12-5](#)
 - in LDAP through the database, [12-5](#)
 - through database, [12-5](#)
 - through LDAP, [12-5](#)
 - using JNDI to look up, [11-2](#)
 - conversion
 - JMS messages, about, [20-16](#)
 - message headers, [20-2](#)
 - non-JMS messages, about, [20-1](#)
 - TIB/Rendezvous messages, [20-12](#)
 - WebSphere MQ messages, [20-6](#)
 - correlation identifier
 - about, [1-22](#), [1-24](#)
 - and transaction grouping, [1-27](#)
 - and Virtual Private Database, [4-10](#)
 - as dequeue condition, [10-14](#)
 - correlation identifier (*continued*)
 - as message property, [10-4](#)
 - as MessageSelector, [11-20](#)
 - dequeuing by specifying, [1-24](#)
 - getting in JMS, [15-14](#)
 - setting in JMS, [15-4](#)
 - with queue table indexes, [5-7](#)
 - creating
 - AQ agents, [8-36](#)
 - AQjms agent, [15-9](#)
 - DurableSubscriber, [14-8–14-11](#)
 - JMS AdtMessage, [15-4](#)
 - JMS BytesMessage, [15-3](#)
 - JMS Connection, [13-1](#), [13-2](#), [14-2](#)
 - JMS MapMessage, [15-3](#)
 - JMS Message, [15-4](#)
 - JMS ObjectMessage, [15-3](#)
 - JMS Session, [13-4](#), [14-3](#)
 - JMS StreamMessage, [15-3](#)
 - JMS TextMessage, [15-3](#)
 - Messaging Gateway administration user, [18-5](#)
 - Messaging Gateway agent user, [18-5](#)
 - Messaging Gateway propagation subscriber, [19-17](#)
 - nonpersistent queues, [A-1](#)
 - point-to-point queue in JMS, [12-11](#)
 - point-to-point sharded queue in JMS, [12-13](#)
 - propagations, [8-31](#)
 - publish/subscribe Topic in JMS, [12-11](#)
 - queue tables, [8-2](#)
 - in JMS, [12-10](#)
 - QueueBrowser, [13-7](#), [13-8](#)
 - QueueConnection, [13-2](#), [13-3](#)
 - QueueReceiver, [13-10](#), [13-11](#)
 - queues, [8-14](#)
 - in JMS, [12-10](#)
 - QueueSender, [13-4](#)
 - QueueSession, [13-4](#)
 - subscribers, [8-27](#)
 - TIB/Rendezvous link, [19-11](#)
 - TopicConnection, [14-2](#), [14-3](#)
 - TopicPublisher, [14-4](#)
 - TopicSession, [14-4](#)
 - transformations, [8-23](#)
 - WebSphere MQ base Java link, [19-6](#)
 - WebSphere MQ JMS link, [19-8](#)
- ## D
-
- data pump, [4-7](#)
 - data type
 - LONG VARCHAR, [xxxvi](#)
 - database
 - disabling access, [8-38](#)

- database (*continued*)
 - enabling access, [8-37](#)
- database connection
 - configuring Messaging Gateway connection information, [18-5](#)
 - Messaging Gateway, [19-2](#)
- DBA_ATTRIBUTE_TRANSFORMATIONS, [9-13](#)
- DBA_QUEUE_SCHEDULES, [9-5](#)
- DBA_QUEUE_SUBSCRIBERS, [9-12](#)
- DBA_QUEUE_TABLES
 - All Queue Tables in Database, [9-3](#)
- DBA_QUEUES, [9-4](#)
- DBA_SUBSCR_REGISTRATIONS
 - All Subscription Registrations, [9-14](#)
- DBA_TRANSFORMATIONS, [9-13](#)
- DBMS_AQ procedures
 - BIND_AGENT, [10-25](#)
 - DEQUEUE, [10-13](#)
 - DEQUEUE_ARRAY, [10-21](#)
 - ENQUEUE, [10-2](#)
 - ENQUEUE_ARRAY, [10-11](#)
 - LISTEN, [10-12](#)
 - POST, [10-24](#)
 - REGISTER, [10-23](#)
 - UNBIND_AGENT, [10-26](#)
 - UNREGISTER, [10-24](#)
- DBMS_AQ.BUFFERED, [10-12](#)
- DBMS_AQ.PERSISTENT, [10-12](#)
- DBMS_AQ.PERSISTENT_OR_BUFFERED, [10-12](#)
- DBMS_AQADM procedures
 - ADD_ALIAS_TO_LDAP, [8-38](#)
 - ADD_SUBSCRIBER, [8-27](#)
 - ALTER_AQ_AGENT, [8-37](#)
 - ALTER_PROPAGATION_SCHEDULE, [8-34](#)
 - ALTER_QUEUE, [8-17](#)
 - ALTER_QUEUE_TABLE, [8-9](#)
 - ALTER_SUBSCRIBER, [8-29](#)
 - CREATE_AQ_AGENT, [8-36](#)
 - CREATE_NP_QUEUE, [A-1](#)
 - CREATE_QUEUE, [8-14](#)
 - CREATE_QUEUE_TABLE, [8-2](#)
 - CREATE_TRANSFORMATION, [8-23](#)
 - DEL_ALIAS_FROM_LDAP, [8-38](#)
 - DISABLE_DB_ACCESS, [8-38](#)
 - DISABLE_PROPAGATION_SCHEDULE, [8-35](#)
 - DROP_AQ_AGENT, [8-37](#)
 - DROP_QUEUE, [8-18](#)
 - DROP_QUEUE_TABLE, [8-10](#)
 - DROP_TRANSFORMATION, [8-24](#)
 - ENABLE_DB_ACCESS, [8-37](#)
 - ENABLE_JMS_TYPES, [22-3](#)
 - ENABLE_PROPAGATION_SCHEDULE, [8-35](#)
- DBMS_AQADM procedures (*continued*)
 - GRANT_QUEUE_PRIVILEGE, [8-26](#)
 - GRANT_SYSTEM_PRIVILEGE, [8-25](#)
 - MIGRATE_QUEUE_TABLE, [8-13](#)
 - MODIFY_TRANSFORMATION, [8-24](#)
 - PURGE_QUEUE_TABLE, [8-11](#)
 - REMOVE_SUBSCRIBER, [8-30](#)
 - REVOKE_QUEUE_PRIVILEGE, [8-26](#)
 - REVOKE_SYSTEM_PRIVILEGE, [8-25](#)
 - SCHEDULE_PROPAGATION, [8-31](#)
 - START_QUEUE, [8-17](#)
 - STOP_QUEUE, [8-18](#)
 - UNSCHEDULE_PROPAGATION, [8-35](#)
 - VERIFY_QUEUE_TYPES, [1-36, 8-33](#)
- DBMS_AQIN, [12-1](#)
- DBMS_MGWADM package
 - about, [17-3](#)
 - ADD_SUBSCRIBER, [19-17, 19-28](#)
 - ALTER_AGENT, [19-3](#)
 - ALTER_MSGSYSTEM_LINK, [19-12, 19-25](#)
 - ALTER_SUBSCRIBER, [19-28](#)
 - CREATE_MSGSYSTEM_LINK, [19-6, 19-8, 19-11, 19-25](#)
 - DB_CONNECT_INFO, [18-5, 19-2](#)
 - DISABLE_PROPAGATION_SCHEDULE, [19-17](#)
 - DOMAIN_QUEUE, [19-13](#)
 - DOMAIN_TOPIC, [19-13](#)
 - ENABLE_PROPAGATION_SCHEDULE, [19-17](#)
 - JMS_CONNECTION, [19-8](#)
 - JMS_QUEUE_CONNECTION, [19-8](#)
 - JMS_TOPIC_CONNECTION, [19-8](#)
 - MQSERIES_BASE_JAVA_INTERFACE, [19-6](#)
 - REGISTER_FOREIGN_QUEUE, [19-13, 19-27](#)
 - REMOVE_MSGSYSTEM_LINK, [19-12](#)
 - RESET_SUBSCRIBER, [19-18](#)
 - SHUTDOWN, [19-3](#)
 - STARTUP, [19-3](#)
 - UNREGISTER_FOREIGN_QUEUE, [19-15](#)
- DBMS_MGWMSG.LCR_TO_XML, [20-5](#)
- DBMS_RULE_ADM.GRANT_SYSTEM_PRIVILEGE, [23-2](#)
- DBMS_STREAMS_ADM.SET_UP_QUEUE, [22-3, 23-2](#)
- DBMS_TRANSFORM.CREATE_TRANSFORMATION, [22-11](#)
- delays
 - during dequeuing, [1-24](#)
 - specifying in JMS, [11-26](#)
- dequeue condition
 - and Virtual Private Database, [4-10](#)
 - with queue table indexes, [5-7](#)

dequeuing

- ANYDATA queues
 - examples, [22-8](#), [23-16](#), [23-18](#)
 - using JMS, [22-4](#)
 - using OCI, [22-4](#)
 - using PL/SQL, [22-4](#)
- buffered messages, [1-14](#)
- by multiple consumers, [1-8](#)
- concurrent processes, [1-24](#)
- features, [1-24](#)
- IDAP client request, [6-12](#)
- IDAP server response to request, [6-15](#)
- message arrays, [1-24](#), [10-21](#)
- message states, [1-24](#)
- messages, [10-13](#)
- methods, [1-24](#)
- modes
 - about, [1-24](#)
- navigation of messages, [1-24](#)
- options, [10-13](#)
 - buffered messages, [1-16](#)
- parameters
 - array_size, [10-21](#)
 - dequeue_options, [10-13](#), [10-21](#)
- retries with delays, [1-24](#)
- transaction protection, [1-24](#)
- waiting for messages, [1-24](#)

destination (JMS)

- altering, [12-18](#)
- dropping, [12-19](#)
- starting, [12-17](#)
- stopping, [12-18](#)

disabling

- database access, [8-38](#)
- propagations, [8-35](#)

double message property (JMS)

- getting, [15-15](#)
- setting, [15-6](#)

dropping

- AQ agents, [8-37](#)
- propagations, [8-35](#)
- queue tables, [8-10](#)
- queues, [8-18](#)
- transformations, [8-24](#)

DurableSubscriber

- about, [11-22](#)
- creating
 - for JMS Topic, [14-8](#), [14-9](#)
 - for Oracle object type Topic, [14-10](#), [14-11](#)
- unsubscribing
 - for a local subscriber, [14-18](#)
 - for a remote subscriber, [14-19](#)

E

e-mail notification, [6-16](#)

enabling

- database access, [8-37](#)
- propagations, [8-35](#)

enqueueing

- ANYDATA queues
 - examples, [22-6](#), [23-13](#), [23-18](#)
 - procedures, creating, [23-4](#)
 - using JMS, [22-3](#)
 - using OCI, [22-3](#)
 - using PL/SQL, [22-3](#)
- buffered messages, [1-14](#)
- client request for, [6-9](#)
- correlation identifier, [1-22](#)
- features, [1-22](#)
- IDAP client request, [6-9](#)
- IDAP server response to request, [6-14](#)
- message array, [1-22](#), [10-11](#)
- message expiration, [1-22](#)
- message grouping, [1-22](#)
- message properties, [10-2](#)
- messages, [10-2](#)
- options, [10-2](#)
- parameters
 - array_size, [10-11](#)
 - enqueue_options, [10-2](#)
 - message_properties, [10-2](#)
 - message_properties_array, [10-11](#)
 - payload, [10-2](#)
 - payload_array, [10-11](#)
- priority and ordering of messages, [1-22](#)
- sender identification, [1-22](#)

enumerated constants

- about, [2-7](#)
- delivery_mode, [2-8](#)
- operational interface, [2-7](#)

environment variables

- CLASSPATH, [18-11](#)
- Messaging Gateway, [18-11](#)
- MGW_PRE_PATH, [18-11](#)
- ORACLE_SID, [18-11](#)

error conditions

- Messaging Gateway, [21-7](#)

error handling

- error messages, [7-3](#)
- IDAP, [6-16](#)
- propagations, [1-31](#)

error messages, [7-3](#)

- Messaging Gateway, [21-4](#)
- Messaging Gateway agent, [21-9](#)

errors (JMS)

- getting codes, [15-18](#)
- getting number, [15-18](#)

event journals, [1-39](#)

exception (JMS)

- exception linked to a JMS exception, getting, [15-18](#)
- exception listener
 - getting, [15-19](#)
 - setting, [15-19](#)
- printing stack trace, [15-18](#)

exception handling

- buffered messages, [1-14](#)
- exception queues, [1-24](#), [11-30](#)
- Messaging Gateway, [21-2](#)
- propagations in JMS, [11-34](#)

exception queues

- about, [1-24](#)
- in JMS, [11-30](#)

expiration

- setting during enqueueing, [1-22](#)
- specifying in JMS, [11-27](#)

exporting

- queue tables
 - about, [4-5](#)
 - data pump, [4-7](#)
 - modes, [4-5](#)
 - multiple recipients, [4-5](#)

F

float message property (JMS)

- getting, [15-15](#)
- setting, [15-6](#)

flow control

- about, [1-14](#)

G

getting (JMS)

- ConnectionFactory, [12-6](#)
- correlation identifier, [15-14](#)
- error codes, [15-18](#)
- error numbers, [15-18](#)
- exceptions, [15-18](#)
- JDBC connection, [15-2](#)
- JMS Connection, [15-2](#)
- message identifier, [15-14](#)
- non-sharded queue table, [12-13](#)
- OracleOCIConnectionPool, [15-2](#)
- Queue in LDAP, [12-9](#)
- QueueConnectionFactory, [12-6](#)
 - in LDAP, [12-8](#)
 - with JDBC connection parameters, [12-7](#)
 - with JDBC URL, [12-6](#)
- Topic in LDAP, [12-9](#)
- TopicConnectionFactory, [12-6](#)
 - with JDBC connection parameters, [12-8](#)

getting (JMS) (*continued*)

- TopicConnectionFactory (*continued*)
 - with JDBC URL, [12-7](#)

GLOBAL_AQ_USER_ROLE

- and registerConnectionFactory, [11-3](#), [12-3](#)

granting

- AQ system privilege, [8-25](#)
 - in JMS, [12-14](#)
- queue privilege, [8-26](#)
 - in JMS, [12-16](#)
- Topic privilege in JMS, [12-15](#)

grouping

- messages, [1-22](#)

GV\$AQ, [11-9](#)

H

HTTP

- AQ operations over, [6-1](#)
- AQ servlet responses, [6-4](#)
- client requests, [6-3](#)
- headers, [6-7](#)
- propagation, [6-4](#)
- propagation using, [1-31](#)
- response, [6-9](#)

I

I/O

- configuring for Oracle Database AQ, [5-6](#)

IDAP

- client request
 - commit transaction, [6-14](#)
 - dequeue, [6-12](#)
 - enqueue, [6-9](#)
 - registration, [6-13](#)
 - roll back transaction, [6-14](#)
- error handling, [6-16](#)
- message, [6-9](#)
- notification, [6-16](#)
- request and response documents, [6-9](#)
- server response
 - commit transaction, [6-15](#)
 - dequeue request, [6-15](#)
 - enqueue request, [6-14](#)
 - register request, [6-15](#)
 - roll back transaction, [6-15](#)

importing

- queue tables
 - about, [4-6](#)
 - data pump, [4-7](#)
 - IGNORE parameter, [4-6](#)
 - multiple recipients, [4-6](#)

inboxes, [1-31](#)

indexes

indexes (*continued*)
 tuning for Oracle Database AQ, 5-7

INIT.ORA parameter, 2-8

initialization parameters
 Messaging Gateway, 18-10

integer message property (JMS)
 getting, 15-15
 setting, 15-6

interfaces to Oracle Database AQ
 about, 1-43
 administrative, 3-6
 AQ XML servlet, 3-6
 comparison, 3-1, 3-6
 JMS, 3-4
 OCCI, 3-3
 OCI, 3-3
 OCI security, 4-4
 operational, 3-9
 PL/SQL, 3-2

Internet Data Access Presentation
 about, 6-6

Internet operations
 and application development, 1-6
 AQ servlet responses, 6-4
 architecture, 1-39, 6-1
 client requests, 6-3
 deploying AQ servlet, 6-5
 IDAP client request
 commit transaction, 6-14
 dequeue, 6-12
 enqueue, 6-9
 registration, 6-13
 roll back transaction, 6-14
 IDAP errors, 6-16
 IDAP notification, 6-16
 IDAP request and response documents, 6-9
 IDAP server response
 commit transaction, 6-15
 dequeue request, 6-15
 enqueue request, 6-14
 register request, 6-15
 roll back transaction, 6-15
 Internet Data Access Presentation, 6-6
 JMS types, 6-2
 notification by e-mail, 6-16
 object type queues, 6-2
 payloads, 6-2
 propagation, 6-4
 RAW queues, 6-2
 SOAP
 body, 6-7
 envelope, 6-7
 message structure, 6-7
 method invocation, 6-7
 user authentication, 6-3

J

Java EE compliance, 11-40

Java properties
 Messaging Gateway, 18-12
 oracle.mgw.batch_size, 18-12
 oracle.mgw.polling_interval, 18-12
 oracle.mgw.tibrv.advMsgCallback, 18-12
 oracle.mgw.tibrv.encoding, 18-12
 oracle.mgw.tibrv.intraProcAdvSubjects,
 18-12

JDBC connection
 getting from JMS Session, 15-2
 registering ConnectionFactory using JDBC
 parameters through the database,
 12-1
 using to register ConnectionFactory through
 LDAP, 12-3

JDBC OCI driver
 needed for JMS, 3-4

JDBC thin driver
 needed for JMS, 3-4

JDBC URL
 registering ConnectionFactory using JDBC
 URL through LDAP, 12-4
 registering through the database, 12-2

JMS
 about, 11-1
 and Oracle Real Application Clusters, 11-9
 ANYDATA messages
 dequeuing, 23-18
 enqueueing, 23-18
 asynchronous receive, 11-30
 buffered messages, 11-16
 Connection, 11-1
 exception queues, 11-30
 JDBC OCI driver needed, 3-4
 JDBC thin driver needed, 3-4
 message bodies, 11-12
 message consumer features, 11-27
 message headers, 11-10
 message properties, 11-11
 message types, 11-10
 MessageProducer features, 11-26
 non-sharded queue tables
 creating, 12-10
 point-to-point features, 11-20
 propagation schedules, 12-19
 publish/subscribe features, 11-22
 queue tables
 getting, 12-13
 queues. creating, 12-10
 recipient lists, 11-24
 Session, 11-1
 statistics views support, 11-9

- JMS (*continued*)
 - structured payloads, [11-10](#)
 - troubleshooting, [15-18](#)
- JMS Connection
 - about, [11-3](#)
 - closing, [15-17](#)
 - getting, [15-2](#)
 - getting OracleOCIConnectionPool from, [15-2](#)
 - starting, [15-2](#)
 - stopping, [15-17](#)
- JMS correlation identifier
 - setting, [15-4](#)
- JMS Destination
 - about, [11-6](#)
 - managing, [12-17](#)
 - methods, [11-7](#)
 - using JMS Session to obtain, [11-6](#)
 - using JNDI to look up, [11-7](#)
- JMS examples
 - BytesMessage, [16-5](#)
 - MapMessage, [16-14](#)
 - setting up, [16-1](#)
 - StreamMessage, [16-9](#)
 - TextMessage, [16-20](#)
- JMS message property
 - Boolean, [15-5](#), [15-15](#)
 - byte, [15-6](#), [15-16](#)
 - double, [15-6](#), [15-15](#)
 - float, [15-6](#), [15-15](#)
 - integer, [15-6](#), [15-15](#)
 - long, [15-7](#), [15-16](#)
 - object, [15-7](#), [15-16](#)
 - short, [15-7](#), [15-16](#)
 - string, [15-5](#), [15-15](#)
- JMS messages
 - browsing, [11-29](#)
 - with a TopicBrowser, [14-25](#)
 - correlation identifier, [15-14](#)
 - creating
 - AdtMessage, [15-4](#)
 - BytesMessage, [15-3](#)
 - JMS Message, [15-4](#)
 - MapMessage, [15-3](#)
 - ObjectMessage, [15-3](#)
 - StreamMessage, [15-3](#)
 - TextMessage, [15-3](#)
 - delay, specifying, [11-26](#)
 - expiration, specifying, [11-27](#)
 - grouping, [11-27](#)
 - message consumer, closing, [15-17](#)
 - message identifier, [15-14](#)
 - message listener
 - specifying at JMS Session, [15-14](#)
 - specifying at message consumer, [15-12](#)
 - message property
- JMS messages (*continued*)
 - message property (*continued*)
 - getting, [15-14](#)
 - setting, [15-4](#)
 - MessageProducer, closing, [15-17](#)
 - navigating in receive, [11-28](#)
 - navigation mode for receiving, specifying, [15-12](#)
 - Priority
 - setting default, [15-8](#)
 - priority and ordering, [11-26](#)
 - propagation with Messaging Gateway
 - inbound, [20-17](#)
 - outbound, [20-17](#)
 - publishing
 - specifying a recipient list, [14-7](#)
 - specifying delivery mode, priority, and time to live, [14-6](#)
 - specifying Topic, [14-6](#)
 - with minimal specification, [14-4](#)
 - QueueBrowser for, creating, [13-7](#), [13-8](#)
 - QueueReceiver for, creating, [13-10](#), [13-11](#)
 - receiving
 - about, [11-28](#)
 - asynchronously, [15-12](#), [15-14](#)
 - from a destination using a transformation, [15-11](#)
 - synchronously, [15-9](#)–[15-11](#)
 - with a message consumer, [15-9](#), [15-10](#)
 - remote subscribers for, creating, [14-14](#)
 - remove no data, [11-29](#)
 - retry with delay, [11-29](#)
 - sending using a QueueSender, [13-5](#), [13-6](#)
 - TimeToLive
 - setting default, [15-8](#)
 - TopicBrowser for, creating, [14-22](#), [14-23](#)
 - TopicReceiver for, creating, [14-20](#), [14-21](#)
 - transformation with JMS AQ, [11-35](#)
- JMS propagations
 - about, [11-31](#)
 - altering, [12-21](#)
 - disabling, [12-21](#)
 - enabling, [12-20](#)
 - exception handling, [11-34](#)
 - RemoteSubscriber, [11-32](#)
 - scheduling, [11-32](#), [12-19](#)
 - unscheduling, [12-22](#)
- JMS publish/subscribe
 - setting up, [11-25](#)
- JMS Session
 - about, [11-5](#)
 - closing, [15-17](#)
 - committing all operations, [15-2](#)
 - creating, [13-4](#), [14-3](#)
 - getting JDBC connection from, [15-2](#)

JMS Session (*continued*)
 rolling back all operations, [15-2](#)
 specifying message listener, [15-14](#)
 using to obtain Destination object, [11-6](#)

JMS Sharded Queue, [xxxv](#)

JMS type queues/topics, [6-2](#)

JMS types
 ANYDATA queues, [22-3](#)
 Internet operations, [6-2](#)

JMS_DeliveryMode, [19-28](#)

JMS_NoLocal, [19-28](#)

JNDI
 using to look up ConnectionFactory objects, [11-2](#)
 using to look up Destination object, [11-7](#)

JOB_QUEUE_PROCESSES, [4-11](#)

L

LDAP
 and AQ_ADMINISTRATOR_ROLE, [11-3](#)
 queue/topic connection factory, [12-8](#)
 registering ConnectionFactory, [12-4](#)
 unregistering ConnectionFactory, [12-5](#)

LDAP server
 adding alias, [8-38](#)
 adding AQ agents, [10-25](#)
 deleting alias, [8-38](#)
 removing AQ agents, [10-26](#)

links
 altering, [19-12](#)
 configuring Messaging Gateway links, [19-5](#)
 MGW_LINKS view, [19-13](#)
 MGW_MQSERIES_LINK view, [19-13](#)
 MGW_TIBRV_LINKS view, [19-13](#)
 removing, [19-12](#)
 TIB/Rendezvous, creating, [19-11](#)
 WebSphere MQ base Java, creating, [19-6](#)
 WebSphere MQ JMS, creating, [19-8](#)

listener.ora
 modifying for Messaging Gateway, [18-2](#), [18-3](#)
 modifying for TIB/Rendezvous, [18-7](#)
 modifying for WebSphere MQ, [18-8](#)

listening
 about, [1-24](#)
 application development, [1-13](#)
 parameters
 agent_list, [10-12](#)
 listen_delivery_mode, [10-12](#)
 wait, [10-12](#)
 syntax, [10-12](#)

LOBs
 propagation, [1-31](#)

log file

log file (*continued*)
 Messaging Gateway, [21-1](#)

log_directory, [18-10](#)

log_level, [18-10](#)

logical change records
 Messaging Gateway, [20-5](#)

long message property (JMS)
 getting, [15-16](#)
 setting, [15-7](#)

LONG VARCHAR data type, [xxxvi](#)

M

managing
 nonpersistent queues, [A-2](#)
 propagations, [4-10](#), [8-30](#)
 queue tables, [8-1](#)
 queues, [8-14](#), [8-18](#)
 subscribers, [8-27](#)
 transformations, [8-23](#)

MapMessage
 about, [11-13](#)
 creating, [15-3](#)
 example, [16-14](#)

message headers
 conversion with Messaging Gateway, [20-2](#)
 WebSphere MQ mappings, [20-7](#)

message identifier
 about, [1-25](#)
 and transaction grouping, [1-27](#)
 getting in JMS, [15-14](#)

message properties
 TIB/Rendezvous, [20-13](#)
 using with message types in JMS, [11-15](#)

message types in JMS
 about, [11-10](#)
 AdtMessage, [11-14](#)
 BytesMessage, [11-13](#)
 MapMessage, [11-13](#)
 ObjectMessage, [11-14](#)
 StreamMessage, [11-13](#)
 TextMessage, [11-14](#)

MessageListener, [11-30](#)

MessageProducer
 closing, [15-17](#)
 features, [11-26](#), [11-35](#)
 setting default Priority, [15-8](#)
 setting default TimeToLive, [15-8](#)

messages
 array dequeuing, [1-24](#), [10-21](#)
 array enqueueing, [1-22](#), [10-11](#)
 bodies in JMS, [11-12](#)
 browsing in JMS, [11-29](#), [14-25](#)
 correlation identifier
 about, [1-24](#)

messages (*continued*)

- correlation identifiers, [1-22](#)
 - in JMS, [15-14](#)
- creating in JMS, [15-3, 15-4](#)
- creating remote subscribers in JMS, [14-15](#)
- delay, specifying in JMS, [11-26](#)
- dequeuing
 - features, [1-24](#)
 - methods, [1-24](#)
 - modes, [1-24](#)
 - syntax, [10-13](#)
 - using JMS, [23-18](#)
 - with concurrent processes, [1-24](#)
- enqueueing
 - features, [1-22](#)
 - options, [10-2](#)
 - syntax, [10-2](#)
 - using JMS, [23-18](#)
- exception queues, [1-24](#)
- expiration
 - about, [1-22](#)
 - specifying in JMS, [11-27](#)
- format transformations, [1-38](#)
- grouping, [1-22](#)
 - in JMS, [11-27](#)
- header conversion with Messaging Gateway, [20-2](#)
- headers in JMS, [11-10](#)
- history and retention in JMS, [11-8](#)
- identifier
 - about, [1-25](#)
- JMS message conversion, [20-16](#)
- JMS message property
 - getting, [15-14](#)
- JMS message property, setting, [15-4](#)
- message consumer in JMS, closing, [15-17](#)
- message identifier in JMS, [15-14](#)
- MessageProducer in JMS, closing, [15-17](#)
- navigating in JMS, [11-28](#)
- navigation during dequeuing, [1-24](#)
- navigation in receive, [11-28](#)
- navigation mode, specifying in JMS, [15-12](#)
- non-JMS message conversion, [20-1](#)
- nonrepudiation, [1-39](#)
- object type support, [1-2](#)
- ordering
 - buffered messages, [1-15](#)
- ordering during propagation, [1-31](#)
- payload restrictions, [4-9](#)
- persistence
 - for security, [1-2](#)
 - metadata analysis, [1-2](#)
 - scheduling, [1-2](#)
- priority and ordering, [1-22](#)
 - in JMS, [11-26](#)

messages (*continued*)

- priority during propagation, [1-31](#)
- Priority, setting in JMS, [15-8](#)
- propagation
 - ANYDATA, [22-5](#)
 - errors, [1-31](#)
 - features, [1-31](#)
 - inboxes and outboxes, [1-31](#)
 - LOBs, [1-31](#)
 - remote consumers, [1-31](#)
 - scheduling, [1-31](#)
 - statistics, [1-31](#)
 - using HTTP, [1-31](#)
 - with Oracle RAC, [1-31](#)
- properties, [10-2](#)
 - in JMS, [11-11](#)
- publishing in JMS, [14-4, 14-6, 14-7](#)
- QueueBrowser for, creating, [13-7, 13-8](#)
- QueueReceiver for, creating, [13-10, 13-11](#)
- receiving in JMS, [11-28](#)
- receiving synchronously in JMS, [15-9–15-11](#)
- recipients
 - about, [1-8](#)
- remote subscribers, creating in JMS, [14-14](#)
- remove no data in JMS, [11-29](#)
- retention and history, [1-39](#)
- retries during dequeuing, [1-24](#)
- retry with delay in JMS, [11-29](#)
- sender identification, [1-22](#)
- sending in JMS, [13-5, 13-6](#)
- states during dequeuing, [1-24](#)
- third-party propagation support, [1-31](#)
- TIB/Rendezvous conversion, [20-12](#)
- TimeToLive, setting in JMS, [15-8](#)
- TopicBrowser for, creating, [14-22–14-24](#)
- TopicReceiver for, creating, [14-20, 14-21](#)
- tracking, [1-39](#)
- transaction protection, [1-24](#)
- transformations, [1-38](#)
 - in JMS, [11-35](#)
- using types with properties in JMS, [11-15](#)
- waiting during dequeuing, [1-24](#)
- WebSphere MQ conversion, [20-6](#)
- XML transformations, [1-38](#)

MessageSelector

- about, [11-20](#)

Messaging Gateway

- about, [17-1](#)
- administration, [17-3](#)
- administration user
 - creating, [18-5](#)
- agent
 - about, [17-4](#)
 - configuring, [19-1](#)
 - error messages, [21-9](#)

- Messaging Gateway (*continued*)
- agent (*continued*)
 - shutting down, [19-3](#)
 - starting, [19-3](#)
 - agent user
 - creating, [18-5](#)
 - and JMS, [17-1](#)
 - and non-Oracle messaging systems, [17-4](#)
 - architecture, [17-3](#)
 - buffered messages, [17-6](#)
 - canonical types, [20-2](#)
 - database connection, [19-2](#)
 - database connection information,
 - configuring, [18-5](#)
 - environment variables, [18-11](#)
 - error conditions, [21-7](#)
 - error messages, [21-4](#)
 - exception handling, [21-2](#)
 - features, [17-1](#)
 - in an Oracle RAC environment, [18-6](#)
 - initialization file, [18-4](#)
 - about, [18-10](#)
 - initialization parameters, [18-10](#)
 - integration with Oracle Database, [17-4](#)
 - Java properties, [18-12](#)
 - links
 - altering, [19-12](#)
 - loading, [18-1](#)
 - log file, [21-1](#)
 - logical change records, [20-5](#)
 - message conversion (JMS), [20-16](#)
 - message conversion (non-JMS), [20-1](#)
 - messaging system links
 - configuring, [19-5](#)
 - modifying listener.ora, [18-2](#), [18-3](#)
 - monitoring agent status, [21-3](#)
 - non-Oracle messaging
 - configuration properties, [19-21](#)
 - optional link configuration properties, [19-25](#)
 - non-Oracle messaging queues
 - configuring, [19-13](#)
 - non-Oracle queue
 - unregistering, [19-15](#)
 - optional foreign queue configuration
 - properties, [19-27](#)
 - optional subscriber configuration properties, [19-28](#)
 - propagation, [17-5](#)
 - propagation disabling, [19-17](#)
 - propagation enabling, [19-17](#)
 - propagation resetting, [19-18](#)
 - propagation schedule
 - removing, [19-19](#)
 - propagation subscriber
- Messaging Gateway (*continued*)
- propagation subscriber (*continued*)
 - creating, [19-17](#)
 - removing, [19-19](#)
 - propagation subscribers, [19-16](#)
 - propagations, [19-15](#)
 - monitoring, [21-8](#)
 - registering non-Oracle queue, [19-13](#)
 - removing a link, [19-12](#)
 - resource limits, [19-3](#)
 - running agent on Oracle RAC, [19-5](#)
 - setting up for TIB/Rendezvous, [18-7](#)
 - setting up for WebSphere MQ, [18-8](#)
 - setting up third-party messaging, [18-7](#)
 - setup
 - procedure, [18-1](#)
 - verifying, [18-9](#)
 - unloading, [18-9](#)
 - view for non-Oracle queues, [19-15](#)
 - views, [21-3](#)
 - views for links, [19-13](#)
- Messaging Gateway user
- and MGW_AGENT_ROLE, [18-5](#)
- MGW_ADMINISTRATOR_ROLE
- and Messaging Gateway administration user, [18-5](#)
 - creating, [18-2](#)
- MGW_AGENT_OPTIONS
- Supplemental Options and Properties, [9-28](#)
- MGW_AGENT_ROLE, [19-2](#)
- and Messaging Gateway user, [18-5](#)
 - creating, [18-2](#)
- MGW_BASIC_MSG_T, [20-2](#)
- MGW_FOREIGN_QUEUES, [19-15](#)
- Foreign Queues, [9-30](#)
- MGW_GATEWAY, [19-3](#), [21-3](#)
- Configuration and Status Information, [9-26](#)
- MGW_JOBS
- Messaging Gateway Propagation Jobs, [9-31](#)
- MGW_LINKS, [19-13](#)
- Names and Types of Messaging System Links, [9-28](#)
- MGW_MQSERIES_LINK, [19-13](#)
- MGW_MQSERIES_LINKS
- WebSphere MQ Messaging System Links, [9-29](#)
- MGW_PRE_PATH, [18-11](#)
- MGW_SCHEDULES
- Information about Schedules, [9-33](#)
- MGW_SUBSCRIBERS
- Information for Subscribers, [9-32](#)
- MGW_TIBRV_LINKS, [19-13](#)
- TIB/Rendezvous Messaging System Links, [9-30](#)
- MGW_TIBRV_MSG_T, [20-2](#)

mgw.ora
 about, [18-10](#)
 comment lines, [18-14](#)
 environment variables, [18-11](#)
 Java properties, [18-12](#)
 modifying for TIB/Rendezvous, [18-7](#)
 modifying for WebSphere MQ, [18-8](#)
 parameters, [18-10](#)
 setting up, [18-4](#)

migrating
 queue tables, [8-13](#)

modifying
 listener.ora for Messaging Gateway, [18-2](#),
[18-3](#)
 transformations, [8-24](#)

monitoring
 Messaging Gateway, [21-1](#)
 propagations, [21-8](#)
 Messaging Gateway agent status, [21-3](#)

MQ_BrokerControlQueue, [19-25](#)
 MQ_BrokerPubQueue, [19-25](#)
 MQ_BrokerQueueManager, [19-25](#)
 MQ_BrokerVersion, [19-25](#)
 MQ_ccsid, [19-25](#)
 MQ_CharacterSet, [19-27](#)
 MQ_JmsDurSubQueue, [19-25](#), [19-27](#)
 MQ_JmsTargetClient, [19-27](#)
 MQ_openOptions, [19-27](#)
 MQ_PubAckInterval, [19-25](#)
 MQ_ReceiveExit, [19-25](#)
 MQ_ReceiveExitInIt, [19-25](#)
 MQ_SecurityExit, [19-25](#)
 MQ_SecurityExitInIt, [19-25](#)
 MQ_SendExit, [19-25](#)
 MQ_SendExitInIt, [19-25](#)
 MsgBatchSize, [19-28](#)

multicasting
 definition, [1-12](#)

multiconsumer dequeuing, [1-8](#)

N

names
 queue tables
 length, [8-2](#)
 mixed case, [8-2](#)
 queues
 length, [8-15](#)
 mixed case, [8-15](#)

navigation
 during dequeuing, [1-24](#)
 modes
 FIRST_MESSAGE, [1-24](#)
 NEXT_MESSAGE, [1-24](#)
 NEXT_TRANSACTION, [1-24](#)

navigation (*continued*)
 specifying mode in JMS, [15-12](#)

nonpersistent queues
 compatibility, [A-2](#)
 creating, [A-1](#)
 managing, [A-2](#)
 notifications, [A-2](#)
 restrictions, [A-3](#)

nonrepudiation
 about, [1-39](#)

notifications
 about, [1-18](#)
 buffered messages, [1-18](#)
 designated port, [1-18](#)
 e-mail, [6-16](#)
 IDAP, [6-16](#)
 nonpersistent queues, [A-2](#)
 parameters
 post_count, [10-24](#)
 post_list, [10-24](#)
 reg_count, [10-23](#)
 reg_list, [10-23](#)
 posting, [10-24](#)
 purge following, [1-18](#)
 RAW payload delivery, [1-18](#)
 registering, [10-23](#)
 reliability, [1-18](#)
 timeout, [1-18](#)
 unregistering, [10-24](#)

O

object message property (JMS)
 getting, [15-16](#)
 setting, [15-7](#)

object types
 access, [4-3](#)
 support for, [1-2](#)
 synonyms, [4-10](#)

object_name, [2-1](#)

ObjectMessage
 about, [11-14](#)
 creating, [15-3](#)

OCCI
 interface to Oracle Database AQ, [3-3](#)
 Oracle type translator, [3-3](#)

OCI
 interface to Oracle Database AQ, [3-3](#)
 Oracle type translator, [3-3](#)

operational interfaces to Oracle Database AQ,
[3-9](#)

options
 dequeuing, [10-13](#)
 enqueueing, [10-2](#)

Oracle AQ Views, [9-1](#)

- Oracle Enterprise Manager
 - and Oracle Database AQ, [1-39](#)
 - support for, [4-7](#)
 - Oracle Internet Directory
 - and Oracle Database AQ, [1-39](#)
 - Oracle Database AQ integration, [1-2](#)
 - Oracle JMS
 - about, [11-1](#)
 - Java EE compliance, [11-40](#)
 - Oracle Messaging Gateway Views, [9-1](#)
 - Oracle object (ADT) type queues
 - Internet operations, [6-2](#)
 - Oracle RAC
 - buffered messages, [1-14](#)
 - configuring Messaging Gateway, [18-6](#)
 - performance with Oracle Database AQ, [5-9](#)
 - queue service name, [1-17](#)
 - running Messaging Gateway agent, [19-5](#)
 - Oracle Real Application Clusters
 - and JMS, [11-9](#)
 - message propagation, [1-31](#)
 - support for, [1-2](#)
 - Oracle type translator, [3-3](#)
 - ORACLE_SID
 - Messaging Gateway, [18-11](#)
 - oracle.mgw.batch_size, [18-12](#)
 - oracle.mgw.polling_interval, [18-12](#)
 - oracle.mgw.tibrv.advMsgCallback, [18-12](#)
 - oracle.mgw.tibrv.encoding, [18-12](#)
 - oracle.mgw.tibrv.intraProcAdvSubjects, [18-12](#)
 - OracleOCIConnectionPool
 - getting from JMS Connection, [15-2](#)
 - ordering
 - commit-time, [1-22](#)
 - during propagation, [1-31](#)
 - messages in JMS, [11-26](#)
 - specifying during enqueueing, [1-22](#)
 - outboxes, [1-31](#)
- P**
-
- parameters
 - admin_option, [8-25](#)
 - agent_list, [10-12](#)
 - agent_name, [8-36](#), [8-37](#)
 - alias, [8-38](#)
 - AQ_TM_PROCESSES, [2-8](#)
 - array_size, [10-11](#), [10-21](#)
 - attempts, [10-4](#)
 - attribute_number, [8-24](#)
 - certificate, [10-25](#)
 - certificate_location, [8-36](#)
 - comment, [8-3](#), [8-15](#)
 - compatibility, [4-1](#)
 - compatible, [8-3](#)
 - parameters (*continued*)
 - consumer_name, [10-14](#)
 - correlation, [10-4](#), [10-14](#)
 - db_username, [8-37](#)
 - delay, [10-4](#)
 - delivery_mode, [8-27](#), [10-3](#), [10-4](#), [10-15](#)
 - deq_condition, [10-15](#)
 - dequeue, [8-17](#), [8-18](#)
 - dequeue_mode, [10-14](#)
 - dequeue_options, [10-13](#), [10-21](#)
 - dest_queue_name, [8-33](#)
 - destination, [8-31](#), [8-33](#)
 - destination_queue, [8-31](#)
 - duration, [8-31](#)
 - enable_anyp, [8-36](#)
 - enable_http, [8-36](#)
 - enqueue, [8-17](#), [8-18](#)
 - enqueue_options, [10-2](#)
 - enqueue_time, [10-5](#)
 - exception_queue, [10-4](#)
 - expiration, [10-4](#)
 - from_schema, [8-23](#)
 - from_type, [8-23](#)
 - grant_option, [8-26](#)
 - grantee, [8-25](#)
 - latency, [8-31](#)
 - listen_delivery_mode, [10-12](#)
 - log_directory, [18-10](#)
 - log_level, [18-10](#)
 - max_retries, [8-15](#)
 - message_grouping, [8-3](#)
 - message_properties, [10-2](#)
 - message_properties_array, [10-11](#)
 - MSG_STATE, [9-6](#)
 - msgid, [10-14](#)
 - multiple_consumers, [8-2](#)
 - name, [10-24](#)
 - namespace, [10-25](#)
 - navigation, [10-14](#)
 - next_time, [8-31](#)
 - obj_location, [8-38](#)
 - original_msgid, [10-5](#)
 - OWNER_INSTANCE, [1-14](#)
 - payload, [10-2](#), [10-25](#)
 - payload_array, [10-11](#)
 - post_count, [10-24](#)
 - post_list, [10-24](#)
 - primary_instance, [8-3](#)
 - priority, [10-3](#)
 - purge_condition, [8-11](#)
 - purge_options, [8-11](#)
 - queue_name, [8-15](#)
 - queue_payload_type, [8-2](#)
 - queue_table, [8-2](#), [8-15](#)
 - queue_to_queue, [8-27](#)

- parameters (*continued*)
 - queue_type, [8-15](#)
 - recipient_list, [10-4](#)
 - reg_count, [10-23](#)
 - reg_list, [10-23](#)
 - relative_msgid, [10-3](#)
 - REMOTE_LISTENER, [1-14](#)
 - retention_time, [8-15](#)
 - retry_delay, [8-15](#)
 - rule, [8-27](#)
 - secondary_instance, [8-3](#)
 - secure, [8-4](#)
 - sender_id, [10-5](#)
 - sequence_deviation, [10-3](#)
 - sort_list, [8-2](#)
 - src_queue_name, [8-33](#)
 - start_time, [8-31](#)
 - state, [10-5](#)
 - storage_clause, [8-2](#)
 - streams_pool_size, [1-14](#)
 - to_schema, [8-23](#)
 - to_type, [8-23](#)
 - transaction_group, [10-5](#)
 - transformation, [8-23](#), [8-27](#), [10-15](#)
 - user_property, [10-5](#)
 - visibility, [10-2](#), [10-14](#)
 - wait, [10-12](#), [10-14](#)
- payloads
 - ANYDATA wrappers for, [22-2](#)
 - Internet operations, [6-2](#)
 - restrictions, [4-9](#)
 - structured, [1-2](#)
 - transformations with Messaging Gateway, [20-3](#)
 - XMLType, [1-2](#)
- performance
 - about, [1-2](#)
 - buffered messages, [5-9](#)
 - concurrent processes, [5-7](#)
 - configuring I/O, [5-6](#)
 - Oracle Database AQ and Oracle RAC, [5-9](#)
 - persistent messaging, [5-9](#)
 - propagation tuning, [5-8](#)
 - queue table indexes, [5-7](#)
 - serial processes, [5-7](#)
 - shared servers, [5-10](#)
 - storage parameters, [5-6](#)
- persistent messaging
 - compared to buffered, [1-14](#)
 - performance, [5-9](#)
 - tuning, [5-5](#)
- point-to-point messages
 - about, [11-20](#)
- port
 - designated for notification, [1-18](#)
- posting for notification, [10-24](#)
- PreserveMessageID, [19-28](#)
- priority
 - during propagation, [1-31](#)
 - specifying during enqueueing, [1-22](#)
- Priority (JMS)
 - about, [11-26](#)
 - setting for all messages from a MessageProducer, [15-8](#)
- privileges
 - AQ system privilege
 - granting, [8-25](#)
 - granting in JMS, [12-14](#)
 - revoking, [8-25](#)
 - revoking in JMS, [12-15](#)
 - DBMS_AQIN, [12-1](#)
 - parameters
 - admin_option, [8-25](#)
 - grant_option, [8-26](#)
 - grantee, [8-25](#)
 - queue privilege
 - granting, [8-26](#)
 - granting in JMS, [12-16](#)
 - revoking, [8-26](#)
 - revoking in JMS, [12-17](#)
 - required for propagation, [4-11](#)
 - security, [4-3](#)
 - SELECT_ANY_DICTIONARY, [23-2](#)
 - Topic privileges
 - granting in JMS, [12-15](#)
 - revoking in JMS, [12-16](#)
- programmatic interfaces
 - about, [1-43](#)
 - ANYDATA queues, [22-2](#)
 - AQ XML servlet, [3-6](#)
 - comparison, [3-1](#), [3-6](#)
 - JMS, [3-4](#)
 - OCCI, [3-3](#)
 - OCI, [3-3](#)
 - OCI security, [4-4](#)
 - PL/SQL, [3-2](#)
- propagations
 - about, [1-31](#)
 - in JMS, [11-31](#)
 - altering, [8-34](#)
 - in JMS, [12-21](#)
 - ANYDATA queues
 - about, [22-5](#)
 - examples, [22-10](#), [22-13](#)
 - BFILE objects, [4-11](#)
 - buffered messages, [1-14](#)
 - creating, [8-31](#)
 - debugging, [7-1](#)
 - disabling, [8-35](#)
 - in JMS, [12-21](#)

propagations (*continued*)

- disabling (*continued*)
 - with Messaging Gateway, [19-17](#)
- dropping, [8-35](#)
- enabling, [8-35](#)
 - in JMS, [12-20](#)
 - with Messaging Gateway, [19-17](#)
- error handling, [1-31](#)
 - in JMS, [11-34](#)
- features, [1-31](#)
- inboxes and outboxes, [1-31](#)
- JMS messages with Messaging Gateway
 - inbound, [20-17](#)
 - outbound, [20-17](#)
- managing, [4-10](#), [8-30](#)
- messages with LOBs, [1-31](#)
- Messaging Gateway
 - configuring for, [19-15](#)
 - monitoring, [21-8](#)
 - resetting with, [19-18](#)
 - subscribers, about, [19-16](#)
 - subscribers, creating, [19-17](#)
 - subscribers, removing, [19-19](#)
- optimizing, [4-11](#)
- parameters
 - destination, [8-31](#)
 - destination_queue, [8-31](#)
 - duration, [8-31](#)
 - latency, [8-31](#)
 - next_time, [8-31](#)
 - start_time, [8-31](#)
- priority and ordering of messages, [1-31](#)
- privileges required, [4-11](#)
- queue-to-dblink
 - about, [1-32](#)
 - scheduling, [1-34](#)
 - with Oracle RAC, [1-37](#)
- queue-to-queue
 - about, [1-32](#)
 - buffered messages, [1-17](#)
 - scheduling, [1-34](#)
 - with Oracle RAC, [1-37](#)
- remote consumers
 - about, [1-31](#)
- schedules
 - about, [1-31](#)
 - altering, [1-35](#)
 - creating syntax, [8-31](#)
 - in JMS, [11-32](#), [12-19](#)
 - removing with Messaging Gateway, [19-19](#)
- scheduling
 - in JMS, [12-19](#)
- security, [4-4](#)
- statistics, [1-31](#)

propagations (*continued*)

- third-party support, [1-31](#)
- TIB/Rendezvous, [20-14](#), [20-15](#)
- tuning, [5-8](#)
- unscheduling, [8-35](#)
 - in JMS, [12-22](#)
- using HTTP, [1-31](#), [6-4](#)
- using HTTP and HTTPS, [6-4](#)
- WebSphere MQ, [20-10](#), [20-11](#)
- with Messaging Gateway, [17-5](#)
- with Oracle RAC, [1-31](#)

publish/subscribe, [11-22](#)

- about, [1-11](#)
- setting up, [1-12](#), [11-25](#)

publishing JMS messages

- specifying a recipient list, [14-7](#)
- specifying delivery mode, priority, and time to live, [14-6](#)
- specifying Topic, [14-6](#)
- with minimal specification, [14-4](#)

purge

- following notification, [1-18](#)

purging

- queue tables, [8-11](#)

Q

Queue (JMS)

- getting in LDAP, [12-9](#)

queue monitor coordinator, [1-39](#)

Queue Monitor Coordinator, [2-9](#)

queue privilege

- granting, [8-26](#)
 - in JMS, [12-16](#)
- revoking, [8-26](#)
 - in JMS, [12-17](#)

queue tables

- altering, [8-9](#)
- creating, [8-2](#)
 - in JMS, [12-10](#)
- data pump, [4-7](#)
- dropping, [8-10](#)
- export
 - modes, [4-5](#)
- exporting
 - about, [4-4](#), [4-5](#)
- getting in JMS, [12-13](#)
- importing
 - about, [4-4](#), [4-6](#)
 - IGNORE parameter, [4-6](#)
 - multiple recipients, [4-6](#)
- managing, [8-1](#)
- migrating, [8-13](#)
- multiple recipients
 - exporting, [4-5](#)

- queue tables (*continued*)
 - names
 - length, 8-2
 - mixed case, 4-1, 8-2
 - parameters
 - comment, 8-3
 - compatible, 8-3
 - message_grouping, 8-3
 - multiple_consumers, 8-2
 - primary_instance, 8-3
 - queue_payload type, 8-2
 - queue_table, 8-2
 - secondary_instance, 8-3
 - secure, 8-4
 - sort_list, 8-2
 - storage_clause, 8-2
 - payload types, 8-2
 - purging, 8-11
 - restrictions, 4-10
 - security, 8-4
 - sort key, 8-2
 - storage clause, 8-2
 - tuning indexes for performance, 5-7
- QUEUE_PRIVILEGES, 9-5
- queue/topic connection factory
 - getting in LDAP, 12-8
- QueueBrowser
 - about, 11-20
 - creating for Oracle object type messages, 13-8
 - creating for standard JMS type messages, 13-7
- QueueConnection
 - creating with default ConnectionFactory parameters, 13-3
 - creating with open JDBC connection, 13-2
 - creating with open
 - OracleOCIConnectionPool, 13-3
 - creating with user name/password, 13-2
- QueueConnectionFactory
 - getting
 - in LDAP, 12-8
 - getting with JDBC connection parameters, 12-7
 - getting with JDBC URL, 12-6
 - registering
 - through database using JDBC
 - connection parameters, 12-1
 - through database using JDBC URL, 12-2
 - through LDAP using JDBC connection parameters, 12-3
 - through LDAP using JDBC URL, 12-4
 - unregistering
 - through database, 12-5
 - through LDAP, 12-5
- QueueReceiver
 - about, 11-20
 - creating for Oracle object type messages, 13-11
 - creating for standard JMS type messages, 13-10
- queues
 - altering, 8-17
 - ANYDATA
 - about, 22-1
 - creating, 23-2
 - JMS types supported, 22-3
 - programmatically interfaces, 22-2
 - propagation, 22-5
 - cleaning up, 1-39
 - creating, 8-14
 - in JMS, 12-10
 - dropping, 8-18
 - exception, 1-24
 - in JMS, 11-30
 - listening, 10-12
 - management restrictions, 4-8
 - managing, 8-14, 8-18
 - monitor coordinator, 1-39
 - names
 - length, 8-15
 - mixed case, 4-1, 8-15
 - non-Oracle
 - configuring, 19-13
 - registering, 19-13
 - nonpersistent, A-1
 - compatibility, A-2
 - managing, A-2
 - notifications, A-2
 - restrictions, A-3
 - parameters
 - comment, 8-15
 - dequeue, 8-17, 8-18
 - enqueue, 8-17, 8-18
 - max_retries, 8-15
 - queue_name, 8-15
 - queue_table, 8-15
 - queue_type, 8-15
 - retention_time, 8-15
 - retry_delay, 8-15
 - point-to-point
 - creating in JMS, 12-11, 12-13
 - restrictions, 4-9, 4-10
 - secure, 10-1
 - security, 4-3
 - starting, 8-17
 - stopping, 8-18
 - subscribers
 - about, 1-8
 - type, verifying, 8-33

QueueSender
 about, [11-20](#)
 creating, [13-4](#)
 sending messages and specifying options,
[13-6](#)
 sending messages with default options, [13-5](#)

QueueSession
 creating, [13-4](#)

queuing
 and Oracle Database, [1-2](#)
 definition, [1-1](#)

R

RAW
 payload delivery with notification, [1-18](#)
 using RAW queues for Internet operations,
[6-2](#)

recipients
 about, [1-8](#)
 recipient lists in JMS, [11-24](#)

recovery
 restrictions, [4-10](#)

REF payloads
 restrictions, [4-9](#)

registerConnectionFactory
 and AQ_ADMINISTRATOR_ROLE, [12-3](#)
 and GLOBAL_AQ_USER_ROLE, [12-3](#)
 using JDBC connection parameters through
 LDAP, [12-3](#)
 using JDBC connection parameters through
 the database, [12-1](#)
 using JDBC URL through LDAP, [12-4](#)

registering
 for notification, [10-23](#)
 through the database, JDBC URL, [12-2](#)

registration
 client request for, [6-9](#)
 IDAP client request, [6-13](#)
 IDAP server response to request, [6-15](#)

reliability
 notifications, [1-18](#)

remote consumers
 propagation, [1-31](#)

remote subscribers
 restrictions, [4-9](#)

RemoteSubscriber, [11-23](#), [11-32](#)

resource limits
 Messaging Gateway, [19-3](#)

restrictions
 buffered messages, [1-14](#)
 message payloads, [4-9](#)
 nonpersistent queues, [A-3](#)
 point-in-time recovery, [4-10](#)
 queue management, [4-8](#)

restrictions (*continued*)
 REF payloads, [4-9](#)
 remote subscribers, [4-9](#)
 subscribers, [4-9](#)
 synonyms, [4-10](#)
 virtual private database, [4-10](#)

result cache, [xxxvi](#)

retention
 of messages, [1-39](#)
 in JMS, [11-8](#)

retries
 during dequeuing, [1-24](#)
 multiple sessions dequeuing, [1-28](#)

revoking
 AQ system privilege, [8-25](#)
 in JMS, [12-15](#)
 queue privilege, [8-26](#)
 in JMS, [12-17](#)

roles
 AQ_ADMINISTRATOR_ROLE, [3-4](#), [4-2](#), [12-3](#)
 AQ_USER_ROLE, [3-4](#), [4-3](#)
 GLOBAL_AQ_USER_ROLE, [11-3](#), [12-3](#)
 MGW_ADMINISTRATOR_ROLE, [18-2](#), [18-5](#)
 MGW_AGENT_ROLE, [18-2](#), [18-5](#)
 SELECT_CATALOG_ROLE, [23-2](#)

rollback
 all operations in JMS Session, [15-2](#)

RV_discardAmount, [19-28](#)

RV_limitPolicy, [19-28](#)

RV_maxEvents, [19-28](#)

S

scalability
 about, [1-2](#)

schedules
 enabling and disabling propagation with
 Messaging Gateway, [19-17](#)

scheduling
 about propagation scheduling, [1-31](#)
 propagations using
 SCHEDULE_PROPAGATION, [8-31](#)

secure queues, [10-1](#)

security, [4-2](#)
 at destination level in JMS, [11-8](#)
 at system level in JMS, [11-8](#)
 compatibility parameter, [4-3](#)
 message persistence, [1-2](#)
 OCI applications, [4-4](#)
 propagations, [4-4](#)
 queue privileges, [4-3](#)
 queue tables
 secure parameter, [8-4](#)

sender identification
 during enqueueing, [1-22](#)

- serial processes
 - tuning for Oracle Database AQ, [5-7](#)
- Session (JMS)
 - creating, [13-4](#), [14-3](#)
- sharded queue, [xxxv](#)
- shared servers
 - performance with Oracle Database AQ, [5-10](#)
- short message property (JMS)
 - getting, [15-16](#)
 - setting, [15-7](#)
- SOAP
 - ANYDATA queues, [22-5](#)
 - body, [6-7](#)
 - envelope, [6-7](#)
 - header, [6-7](#)
 - message structure, [6-7](#)
 - method invocation, [6-7](#)
- stack trace
 - printing in JMS, [15-18](#)
- starting
 - JMS Connection, [15-2](#)
 - Messaging Gateway agent, [19-3](#)
 - queues, [8-17](#)
- statistics
 - propagation, [1-31](#)
- stopping
 - JMS Connection, [15-17](#)
 - queues, [8-18](#)
- storage parameters
 - tuning Oracle Database AQ, [5-6](#)
- StreamMessage
 - about, [11-13](#)
 - creating, [15-3](#)
 - example, [16-9](#)
- string message property (JMS)
 - getting, [15-15](#)
 - setting, [15-5](#)
- structured payloads, [1-2](#)
 - about, [1-2](#)
 - in JMS, [11-10](#)
- subscribers
 - about, [1-8](#)
 - adding, [8-27](#)
 - altering, [8-29](#)
 - creating, [8-27](#)
 - creating JMS remote subscriber for Oracle object type messages, [14-15](#)
 - creating remote subscriber for JMS messages, [14-14](#)
 - creating with Messaging Gateway, [19-17](#)
 - in Messaging Gateway propagations, [19-16](#)
 - managing, [8-27](#)
 - names
 - mixed case, [4-1](#)
 - ordering, [1-8](#)

- subscribers (*continued*)
 - parameters
 - delivery_mode, [8-27](#)
 - queue_to_queue, [8-27](#)
 - rule, [8-27](#)
 - transformation, [8-27](#)
 - removing, [8-30](#)
 - restrictions, [4-9](#)
 - specifying transformations for in JMS, [14-13](#), [14-17](#)
 - unsubscribing DurableSubscribers, [14-18](#), [14-19](#)
- synonyms
 - restrictions, [4-10](#)
- SYS.AQ\$_DESCRIPTOR, [2-5](#)
- SYS.AQ\$_POST_INFO, [2-6](#)
- SYS.AQ\$_REG_INFO, [2-3](#)
- SYS.MGW_MQSERIES_PROPERTIES, [19-22](#)
- SYS.MGW_TIBRV_PROPERTIES, [19-24](#)
- system privilege
 - granting, [8-25](#)
 - in JMS, [12-14](#)
 - revoking, [8-25](#)
 - in JMS, [12-15](#)

T

- TextMessage
 - about, [11-14](#)
 - creating, [15-3](#), [15-4](#)
 - example, [16-20](#)
- third-party messaging
 - and application development, [1-6](#)
 - and Messaging Gateway, [17-4](#)
 - configuration properties, [19-21](#)
 - optional foreign queue configuration properties, [19-27](#)
 - optional link configuration properties, [19-25](#)
 - optional subscriber configuration properties, [19-28](#)
 - queues
 - configuring, [19-13](#)
 - registering, [19-13](#)
 - unregistering, [19-15](#)
 - setting up, [18-7](#)
 - view for registered queues, [19-15](#)
- TIB/Rendezvous
 - AQ_MsgProperties, [19-28](#)
 - links
 - creating, [19-11](#)
 - listener.ora, modifying, [18-7](#)
 - message conversion, [20-12](#)
 - message property mapping, [20-13](#)
 - Messaging Gateway. setting up for, [18-7](#)
 - mgw.ora, modifying, [18-7](#)

- TIB/Rendezvous (*continued*)
 - MsgBatchSize, [19-28](#)
 - PreserveMessageID, [19-28](#)
 - propagation
 - inbound, [20-15](#)
 - outbound, [20-14](#)
 - RV_discardAmount, [19-28](#)
 - RV_limitPolicy, [19-28](#)
 - RV_maxEvents, [19-28](#)
 - Subject
 - registering, [19-15](#)
 - unregistering, [19-15](#)
 - system properties, [19-24](#)
- time specification
 - during enqueueing, [1-22](#)
- timeout
 - notifications, [1-18](#)
- TimeToLive
 - setting for all messages from a MessageProducer, [15-8](#)
- Topic
 - creating DurableSubscriber for, [14-8–14-11](#)
 - creating in JMS, [12-11](#)
 - getting in LDAP, [12-9](#)
 - granting Topic privilege in JMS, [12-15](#)
 - revoking Topic privilege in JMS, [12-16](#)
 - specifying transformations for subscribers, [14-13](#)
- TopicBrowser, [11-24](#)
 - browsing messages using, [14-25](#)
 - creating for Topic of Oracle type messages, [14-23, 14-24](#)
 - creating for Topic of standard JMS type messages, [14-22, 14-23](#)
- TopicConnection
 - creating with open JDBC connection, [14-3](#)
 - creating with open OracleOCIConnectionPool, [14-3](#)
 - creating with user name/password, [14-2](#)
- TopicConnectionFactory
 - getting
 - in LDAP, [12-8](#)
 - with JDBC connection parameters, [12-8](#)
 - with JDBC URL, [12-7](#)
 - registering
 - through database using JDBC connection parameters, [12-1](#)
 - through database using JDBC URL, [12-2](#)
 - through LDAP using JDBC connection parameters, [12-3](#)
 - through LDAP using JDBC URL, [12-4](#)
 - unregistering
 - through database, [12-5](#)
 - through LDAP, [12-5](#)
- TopicPublisher
 - about, [11-23](#)
 - creating, [14-4](#)
- TopicReceiver
 - about, [11-24](#)
 - creating for Topic of Oracle object type messages, [14-21](#)
 - creating for Topic of standard JMS type messages, [14-20](#)
- TopicSession
 - creating, [14-4](#)
- transaction
 - IDAP client request
 - commit, [6-14](#)
 - roll back, [6-14](#)
 - protection during dequeuing, [1-24](#)
- transformations
 - about, [1-38](#)
 - altering, [8-24](#)
 - creating, [8-23](#)
 - dropping, [8-24](#)
 - for remote subscribers, specifying in JMS, [14-17](#)
 - for Topic subscribers, specifying in JMS, [14-13](#)
 - managing, [8-23](#)
 - Messaging Gateway, [20-3](#)
 - modifying, [8-24](#)
 - parameters
 - attribute_number, [8-24](#)
 - from_schema, [8-23](#)
 - from_type, [8-23](#)
 - to_schema, [8-23](#)
 - to_type, [8-23](#)
 - transformation, [8-23](#)
 - XML, [1-38](#)
- troubleshooting
 - in JMS, [15-18](#)
- tuning
 - buffered messages, [5-9](#)
 - persistent messaging, [5-5](#)
- type_name, [2-2](#)
- types
 - access, [4-3](#)
 - AQ agent, [2-2](#)
 - AQ agent list, [2-3](#)
 - AQ notification descriptor, [2-5](#)
 - AQ post information, [2-6](#)
 - AQ post information list, [2-3](#)
 - AQ recipient list, [2-3](#)
 - AQ registration information, [2-3](#)
 - AQ registration information list, [2-3](#)
 - AQ subscriber list, [2-3](#)
 - aq\$_purge_options_t, [8-11](#)
 - buffered messaging support, [1-15](#)

types (*continued*)

- Messaging Gateway, [20-2](#)
- MGW_BASIC_MSG_T, [20-2](#)
- MGW_TIBRV_MSG_T, [20-2](#)
- oracle.xdb.XMLType, [22-4](#)
- support for, [1-2](#)
- SYS.LCR\$_DDL_RECORD, [22-3](#)
- SYS.LCR\$_ROW_RECORD, [22-3](#)

U

unregistering

- ConnectionFactory in LDAP, [12-5](#)
- notification, [10-24](#)

unscheduling

- propagations, [8-35](#)
- in JMS, [12-22](#)

user authentication

- Internet operations, [6-3](#)

USER_ATTRIBUTE_TRANSFORMATIONS

- User Transformation Functions, [9-14](#)

USER_QUEUE_SCHEDULES, [9-5](#)USER_QUEUE_SUBSCRIBERS, [9-12](#)USER_QUEUE_TABLES, [9-3](#)USER_QUEUES, [9-4](#)

USER_SUBSCR_REGISTRATIONS

- User Subscription Registrations, [9-14](#)

USER_TRANSFORMATIONS, [9-13](#)

users

- Messaging Gateway agent, [18-5](#)

V

V\$AQ_BACKGROUND_COORDINATOR, [9-23](#)V\$AQ_CROSS_INSTANCE_JOBS, [9-24](#)V\$AQ_JOB_COORDINATOR, [9-24](#)V\$AQ_MESSAGE_CACHE_ADVICE, [9-21](#)V\$AQ_MESSAGE_CACHE_STAT, [9-19](#)V\$AQ_NONDUR_REGISTRATIONS, [9-25](#)V\$AQ_NONDUR_SUBSCRIBER, [9-26](#)V\$AQ_NONDUR_SUBSCRIBER_LWM, [9-26](#)V\$AQ_NOTIFICATION_CLIENTS, [9-25](#)V\$AQ_REMOTE_DEQUEUE_AFFINITY, [9-23](#)V\$AQ_SERVER_POOL, [9-24](#)V\$AQ_SHARDED_SUBSCRIBER_STAT, [9-20](#)V\$AQ_SUBSCRIBER_LOAD, [9-25](#)

V\$BUFFERED_PUBLISHERS

- All Buffered Publishers in the Instance, [9-16](#)

V\$BUFFERED_SUBSCRIBERS

- Subscribers for All Buffered Queues in the Instance, [9-16](#)

V\$METRICGROUP

- Information about the Metric Group, [9-19](#)

V\$PERSISTENT_PUBLISHERS

V\$PERSISTENT_PUBLISHERS (*continued*)

- All Active Publishers of the Persistent Queues in the Database, [9-18](#)

V\$PERSISTENT_QMN_CACHE

- Performance Statistics on Background Tasks for Persistent Queues, [9-17](#)

V\$PERSISTENT_QUEUES

- All Active Persistent Queues in the Database, [9-17](#)

V\$PERSISTENT_SUBSCRIBERS

- All Active Subscribers of the Persistent Queues in the Database, [9-17](#)

V\$PROPAGATION_RECEIVER

- Buffer Queue Propagation Schedules on the Receiving (Destination) Side, [9-18](#)

V\$PROPAGATION_SENDER

- Buffer Queue Propagation Schedules on the Sending (Source) Side, [9-18](#)

V\$SUBSCR_REGISTRATION_STATS

- Diagnosability of Notifications, [9-19](#)

verifying

- Messaging Gateway setup, [18-9](#)
- queue type, [8-33](#)

views

- all propagation schedules, [9-5](#)
 - all queue subscribers in database, [9-12](#)
 - all queues in database, [9-4](#)
 - all transformation functions, [9-13](#)
 - all transformations, [9-13](#)
 - AQ agents registered for Internet access, [9-15](#)
 - dequeue affinity instance list, [9-23](#)
 - memory management for sharded queues, [9-19](#)
 - messages in queue table, [9-5](#)
 - Messaging Gateway, [19-3](#)
 - Messaging Gateway agent, [21-3](#)
 - Messaging Gateway links, [19-13](#)
 - propagation schedules in user schema, [9-5](#)
 - queue subscribers, [9-10](#)
 - queue subscribers and their rules, [9-10](#)
 - queue subscribers for queues where user has queue privileges, [9-12](#)
 - queue subscribers in user schema, [9-12](#)
 - queue tables in user schema, [9-3](#)
 - queues for which user has any privilege, [9-4](#)
 - queues for which user has queue privilege, [9-5](#)
 - queues in user schema, [9-4](#)
 - registered non-Oracle queues, [19-15](#)
 - sharded queue subscriber statistics, [9-20](#)
 - simulated metrics, [9-21](#)
 - user transformations, [9-13](#)
- virtual private database restrictions, [4-10](#)

visibility

- about, [6-10](#), [6-12](#)
- buffered messages, [1-15](#)
- dequeue options, [10-14](#)
- enqueue options, [10-2](#)
- rollback operations, [6-14](#)

W

waiting

- during dequeuing, [1-24](#)

WebSphere MQ

- base Java link, creating, [19-6](#)
- base Java queue
 - registering, [19-14](#)
 - unregistering, [19-15](#)
- JMS link, creating, [19-8](#)
- JMS Queue or Topic
 - registering, [19-14](#)
 - unregistering, [19-15](#)
- JMS_DeliveryMode, [19-28](#)
- JMS_NoLocal, [19-28](#)
- listener .ora, modifying, [18-8](#)
- message conversion, [20-6](#)
- message header mappings, [20-7](#)
- Messaging Gateway, setting up for, [18-8](#)
- mgw.ora, modifying, [18-8](#)
- MQ_BrokerControlQueue, [19-25](#)
- MQ_BrokerPubQueue, [19-25](#)

WebSphere MQ (*continued*)

- MQ_BrokerQueueManager, [19-25](#)
- MQ_BrokerVersion, [19-25](#)
- MQ_ccsid, [19-25](#)
- MQ_CharacterSet, [19-27](#)
- MQ_JmsDurSubQueue, [19-25](#), [19-27](#)
- MQ_JmsTargetClient, [19-27](#)
- MQ_openOptions, [19-27](#)
- MQ_PubAckInterval, [19-25](#)
- MQ_ReceiveExit, [19-25](#)
- MQ_ReceiveExitInit, [19-25](#)
- MQ_SecurityExit, [19-25](#)
- MQ_SecurityExitInit, [19-25](#)
- MQ_SendExit, [19-25](#)
- MQ_SendExitInit, [19-25](#)
- MsgBatchSize, [19-28](#)
- optional link configuration properties, [19-25](#)
- PreserveMessageID, [19-28](#)
- propagation
 - inbound, [20-11](#)
 - outbound, [20-10](#)
- system properties, [19-22](#)

X

XA

- using with Oracle Database AQ, [4-8](#)

XML, [6-1](#)

- deploying AQ servlet, [6-5](#)
- message format transformations, [1-38](#)