

# JD Edwards EnterpriseOne

---

## **Transaction Server Reference Guide for Microsoft Windows using WebLogic Server**

9.2

Copyright © 2011, 2023, Oracle and/or its affiliates.

This software and related documentation are provided under a license agreement containing restrictions on use and disclosure and are protected by intellectual property laws. Except as expressly permitted in your license agreement or allowed by law, you may not use, copy, reproduce, translate, broadcast, modify, license, transmit, distribute, exhibit, perform, publish, or display any part, in any form, or by any means. Reverse engineering, disassembly, or decompilation of this software, unless required by law for interoperability, is prohibited.

The information contained herein is subject to change without notice and is not warranted to be error-free. If you find any errors, please report them to us in writing.

If this is software or related documentation that is delivered to the U.S. Government or anyone licensing it on behalf of the U.S. Government, then the following notice is applicable:

U.S. GOVERNMENT END USERS: Oracle programs (including any operating system, integrated software, any programs embedded, installed or activated on delivered hardware, and modifications of such programs) and Oracle computer documentation or other Oracle data delivered to or accessed by U.S. Government end users are "commercial computer software" or "commercial computer software documentation" pursuant to the applicable Federal Acquisition Regulation and agency-specific supplemental regulations. As such, the use, reproduction, duplication, release, display, disclosure, modification, preparation of derivative works, and/or adaptation of i) Oracle programs (including any operating system, integrated software, any programs embedded, installed or activated on delivered hardware, and modifications of such programs), ii) Oracle computer documentation and/or iii) other Oracle data, is subject to the rights and limitations specified in the license contained in the applicable contract. The terms governing the U.S. Government's use of Oracle cloud services are defined by the applicable contract for such services. No other rights are granted to the U.S. Government.

This software or hardware is developed for general use in a variety of information management applications. It is not developed or intended for use in any inherently dangerous applications, including applications that may create a risk of personal injury. If you use this software or hardware in dangerous applications, then you shall be responsible to take all appropriate fail-safe, backup, redundancy, and other measures to ensure its safe use. Oracle Corporation and its affiliates disclaim any liability for any damages caused by use of this software or hardware in dangerous applications.

Oracle and Java are registered trademarks of Oracle and/or its affiliates. Other names may be trademarks of their respective owners.

Intel and Intel Inside are trademarks or registered trademarks of Intel Corporation. All SPARC trademarks are used under license and are trademarks or registered trademarks of SPARC International, Inc. AMD, Epyc, and the AMD logo are trademarks or registered trademarks of Advanced Micro Devices. UNIX is a registered trademark of The Open Group.

This software or hardware and documentation may provide access to or information about content, products, and services from third parties. Oracle Corporation and its affiliates are not responsible for and expressly disclaim all warranties of any kind with respect to third-party content, products, and services unless otherwise set forth in an applicable agreement between you and Oracle. Oracle Corporation and its affiliates will not be responsible for any loss, costs, or damages incurred due to your access to or use of third-party content, products, or services, except as set forth in an applicable agreement between you and Oracle.

# Contents

<b>Preface</b>	<b>i</b>
<hr/>	
<b>1 Understanding the Transaction Server Components</b>	<b>1</b>
Overview	1
Certifications	1
Obtaining the Transaction Server Managed Software Component	2
Prerequisites	2
Understanding Transaction Server Communications	2
<b>2 Configuring the Transaction Server Components</b>	<b>5</b>
	5
<b>3 Configuring JD Edwards EnterpriseOne</b>	<b>23</b>
	23
<b>4 Adding a Subscriber</b>	<b>31</b>
Setting Processing Options for Event Subscribers Application (P90702A)	31
Using Event Subscribers Application to Add a Subscriber	33
Working with Subscribers in JD Edwards EnterpriseOne	36
<b>5 Troubleshooting Real Time Events Processing</b>	<b>53</b>
	53
<b>6 Upgrading the Transaction Server RTE Software Component Using Server Manager</b>	<b>55</b>
	55
<b>7 Appendix A - Architecture of the Guaranteed Event System</b>	<b>57</b>
	57

---

<b>8</b>	<b>Appendix B - Creating and Configuring Multiple Transaction Servers per Environment or User/Role</b>	<b>59</b>
		59
<b>9</b>	<b>Appendix C - Working with JMS Topic or JMS Queue</b>	<b>63</b>
		63
<b>10</b>	<b>Appendix D - Testing and Validating the JMSQUEUE Configuration</b>	<b>65</b>
		65
<b>11</b>	<b>Appendix E - Creating a JMS Topic in the JD Edwards EnterpriseOne Transaction Server Application</b>	<b>67</b>
		67
<b>12</b>	<b>Appendix F - Creating a Subscriber JMS Queue in WebLogic Server other than Transaction Server</b>	<b>69</b>
		69
<b>13</b>	<b>Appendix G - Creating an Oracle JD Edwards EnterpriseOne Service Request for Transaction Server Support</b>	<b>81</b>
		81
<b>14</b>	<b>Appendix H - Clustering for the JD Edwards Transaction Server on WebLogic Server</b>	<b>83</b>
	Understanding WebLogic Clustering	83
	Creating a Cluster on WebLogic Server	83
	Creating the Servers	85
	Creating Machines	90
	Associate Machines with Servers	93
	Cluster the Servers	99
	Setup the Cluster for Load Balancing	102
	Setup the Cluster for Failover	103
	Installing the Transaction Server RTE Component on WebLogic Server using Server Manager	105
	Using JDBC Persistent Stores	112

---

Create JDBC Datasources	112
Create JDBC Persistent Stores	120
Associate a JMS Server with a Persistent Store	123
Additional Configuration for Using Horizontal Cluster	126

## **15 Appendix I - Setting Up SSL/TLS for Oracle WebLogic** **131**

---

Setting Up SSL/TLS for Oracle WebLogic	131
--	-----



# Preface

Welcome to the JD Edwards EnterpriseOne documentation.

## Documentation Accessibility

For information about Oracle's commitment to accessibility, visit the Oracle Accessibility Program website at <http://www.oracle.com/pls/topic/lookup?ctx=acc&id=docacc>.

## Access to Oracle Support

Oracle customers that have purchased support have access to electronic support through My Oracle Support. For information, visit <http://www.oracle.com/pls/topic/lookup?ctx=acc&id=info> or visit <http://www.oracle.com/pls/topic/lookup?ctx=acc&id=trs> if you are hearing impaired.

## Related Information

For additional information about JD Edwards EnterpriseOne applications, features, content, and training, visit the JD Edwards EnterpriseOne pages on the JD Edwards Resource Library located at:

<http://learnjde.com>

## Conventions

The following text conventions are used in this document:

Convention	Meaning
<b>Bold</b>	Boldface type indicates graphical user interface elements associated with an action or terms defined in text or the glossary.
<i>Italics</i>	Italic type indicates book titles, emphasis, or placeholder variables for which you supply particular values.
<b>Monospace</b>	Monospace type indicates commands within a paragraph, URLs, code examples, text that appears on a screen, or text that you enter.
<b>&gt; Oracle by Example</b>	Indicates a link to an Oracle by Example (OBE). OBEs provide hands-on, step-by-step instructions, including screen captures that guide you through a process using your own environment. Access to OBEs requires a valid Oracle account.





# 1 Understanding the Transaction Server Components

## Overview

The *JD Edwards EnterpriseOne* Transaction Server Components installer performs the installation, upgrade, and configuration of the Transaction Server Components. These components provide the Real Time Events functionality on the Transaction Server.

This document is not a substitute for the administration manuals provided by your Oracle WebLogic 11g Application Server vendor, the network administration manuals provided by your network vendor, or the installation and configuration manuals for third-party products used with *JD Edwards EnterpriseOne*.

The procedures in this guide support the Oracle WebLogic 11g Application Server. This document is designed for management information system (MIS) managers and installers. To successfully install the Transaction Server Components on an Application Server, you must have a working knowledge of these topics:

- Hardware and software requirements
- Oracle WebLogic 11g Application Server setup and administration
- *JD Edwards EnterpriseOne* platforms and operating systems

The recommended method of obtaining this information is to attend the relevant training courses. Information about course offerings, dates, and locations is available on My Oracle Support. At a minimum, read these guides before beginning:

- *JD Edwards EnterpriseOne Tools Foundation Guide*
- *JD Edwards EnterpriseOne Tools Runtime Administration Guide*
- *JD Edwards EnterpriseOne Tools System Administration Guide*
- *JD Edwards EnterpriseOne Tools Package Management Guide*
- *JD Edwards EnterpriseOne Administration Guide*

## Certifications

Customers must conform to the supported platforms for the release as detailed in the JD Edwards EnterpriseOne Certifications (formerly known as Minimum Technical Requirements). In addition, JD Edwards EnterpriseOne may integrate, interface, or work in conjunction with other Oracle products. Refer to the following link for cross-reference material in the Program Documentation for Program prerequisites and version cross-reference documents to assure compatibility of various Oracle products.

<http://www.oracle.com/corporate/contracts/index.html>

Refer to the Certifications tab on My Oracle Support and search for this product:

- **JD Edwards EnterpriseOne Transaction Server.**

For additional information on using Certifications, refer to this document on My Oracle Support ( <https://support.oracle.com> ):

- **Certifications FAQ for JD Edwards EnterpriseOne [Article ID 1525328.1]**

## Obtaining the Transaction Server Managed Software Component

You can obtain the Transaction Server Managed Software Component from:

- Update Center
- Change Assistant

The name of the component to download is called 92xTy, where x is the major tools release (for example, 9.2) and y is the maintenance release. For example, the Managed Software Component for the Transaction Server for 9.2.3.0 is called 92T30.

**Note:** Once obtained, the Transaction Server Managed Software Component is installed using the JD Edwards EnterpriseOne tool called Server Manager. Refer to the [JD Edwards EnterpriseOne Tools Server Manager Guide](#) for additional details.

## Prerequisites

These prerequisites are required prior to installing the Transaction Server Components on an Application Server.

- Verify that your installation meets the prerequisites for installing the Oracle WebLogic Server.
- Oracle WebLogic Application Server must be installed, configured and running. For *JD Edwards EnterpriseOne* - specific installation instructions refer to the [JD Edwards EnterpriseOne HTML Server Reference Guide for Oracle WebLogic Server on Microsoft Windows](#) , which is located on OTN (Oracle Technology Network).

## Understanding Transaction Server Communications

The JD Edwards EnterpriseOne Server Manager communicates with the Transaction Server using JMX (Java Management Extensions). The Embedded Agent in the Transaction Server does not connect to HTTP nor does it connect using Plugins. This is the mechanism by which Server Manager manages the Transaction Server.

The Embedded Agent generally allocates ports in an incremental manner. For example, if a Server Manager Agent installed on the machine is running on port number 14502 (default) then the Embedded Agents running inside managed instances on that machine would allocate ports starting from 14502+1=14503, 14504, and so on depending on the number of managed instances on that machine.

**Tip:** In order to ascertain the Port Number on which the Transaction Server Embedded Agent is running, open the `systemOut.log` file of the J2EE Container and search for the string `*Management Agent*` which should take you to a line containing this string:

```
00000017 Server I Starting the management agent listener on port '14503'
```

The Transaction Server communicates with the JD Edwards EnterpriseOne Enterprise Servers using the EnterpriseOne Proprietary Communication Protocol; that is, JDENET messages.

The Transaction Server connects to the JD Edwards EnterpriseOne database using proprietary database middleware (JDBj). The default ports are dependent on the database type:

- 1521 for Oracle database
- 1433 for SQL Server database
- 50000 for *DB2 for i* or *DB2 for Linux, Windows, and UNIX* database

Although the above are default ports, it is possible to run these databases on different ports. Further, these ports are only defined for the Bootstrap database. The JDBj code retrieves the port numbers for the other databases from the Data Source Master Table based on the port numbers for each of the Data Source records as configured during the Planner and Workbench and the Work with Data Sources Application.



## 2 Configuring the Transaction Server Components

You must use Server Manager Console to install and configure Transaction Server instances. These Server Manager settings for the Transaction Server are found under Configuration section of Transaction Server Instance.

### JDBj Database Configuration

These sections of Server Manager control the JDBj settings:

- *JDBj Bootstrap Datasource*
- *JDBj Bootstrap Session*
- *JDBj Connection Pools*
- *JDBC Drivers*
- *JDBj Logging*
- *Oracle Database Settings*
- *JDBj Runtime Properties*
- *JDBj Spec Datasource*

#### JDBj Bootstrap Datasource

This section defines the data source where OCM and some other system tables reside. JDBj uses this at bootstrap time and later to look up OCM entries on demand. If the information entered here is not valid, you cannot access the JD Edwards EnterpriseOne database.

With a Transaction Server instance selected, the following shows typical values:

**JDBj Bootstrap Datasource**

This section defines the data source where OCM and some other system tables reside. JDBj uses this at bootstrap time and later to look up OCM entries on demand. If it is not valid, then no JD Edwards EnterpriseOne database access is possible.

System Datasource Name

Database Type

Database Name

Database Server Name

Database TCP/IP Port

Physical Database

Object Owner

Supports Large Objects (LOBS)

Unicode Database

[Revert to Defaults](#) [Apply](#)

Below is a list of the settings and typical values:

- *System Datasource Name*  
Enter the name of your System datasource. For example:  
**System - 920**
- *Database Type*  
Use the pulldown to select your database type.
- *Database Name*  
Enter your database name.
- *Database Server Name*  
Enter the name of your database server.
- *Database TCP/IP Port*  
Enter the TCP/IP port for your database.

- *Physical Database*  
Optionally you can choose to specify your physical database.
- *Object Owner*  
Enter the object owner for the System datasource. For example:  
**SY920**

## JDBj Bootstrap Session

This information is used to sign on with access to system tables. For JD Edwards EnterpriseOne HTML servers, only the user and environment need to be supplied. JDBj signs this user on during the bootstrap process. If the sign on information is not valid, then no access is granted to the JD Edwards EnterpriseOne database. To configure as a Portal WSRP Producer, you must supply a valid EnterpriseOne user and environment and the password and role settings are optional.

With a Transaction Server instance selected, the following shows typical values:

JDBj Bootstrap Session [Return To Top](#)

This information is used to sign on to provide access to system tables. For EnterpriseOne HTML servers, only the user and environment need to be supplied. JDBj signs this user on via the security server during the bootstrap process. If the sign on information is not valid, then no access to the JD Edwards EnterpriseOne database is possible. To configure as a Portal WSRP Producer, a valid E1 user and environment need to be supplied and the password and role settings below are optional.

Bootstrap User	<input type="text" value="JDE"/>
Bootstrap User Password	<input type="password" value="*****"/>
Bootstrap Role	<input type="text" value="*ALL"/>
Bootstrap Environment	<input type="text" value="JDV920"/>

Below is a list of the settings and typical values:

- *Bootstrap User*  
Enter the name of your Bootstrap User. For example:  
**JDE**
- *Bootstrap User*  
Enter the password for your Bootstrap User.
- *Bootstrap Role*  
Enter the role of your Bootstrap User. For example:  
**\*ALL**

- *Bootstrap Environment*

Enter the bootstrap environment. For example:

**JDV920**

## JDBj Connection Pools

These settings control the database connection pooling (sharing of connections) within JDBj. Connections are pooled at the physical datasource level, not the EnterpriseOne logical datasource level.

With a Transaction Server instance selected, the following shows typical values:

Setting	Value
Use JDBC Pooling	<input type="checkbox"/>
Minimum Connections	0
Maximum Connections	50
Pool Growth Size	5
Initial Connections	5
Connection Timeout	1800000
Pool Cleaning Interval	300000
Maximum Prepared Statements	50
Cache Purge Size	5

Below is a list of the settings and typical values:

- *Minimum Connections*

Enter a value. For example:

**0**



- *Maximum Connections*

Enter a value. For example:

**50**

- *Pool Growth Size*

Enter a value. For example:

**5**

- *Initial Connections*

Enter a value. For example:

**5**

- *Connection Timeout*

Enter a value in milliseconds. For example:

**1800000**

- *Pool Cleaning Interval*

Enter a value in milliseconds. For example:

**300000**

- *Maximum Prepared Statements*

Enter a value. For example:

**50**

- *Cache Purge Size*

Enter a value. For example:

**5**

## JDBC Drivers

These settings specify which JDBC drivers to use for a particular database type.

With a Transaction Server instance selected, the following shows typical values:

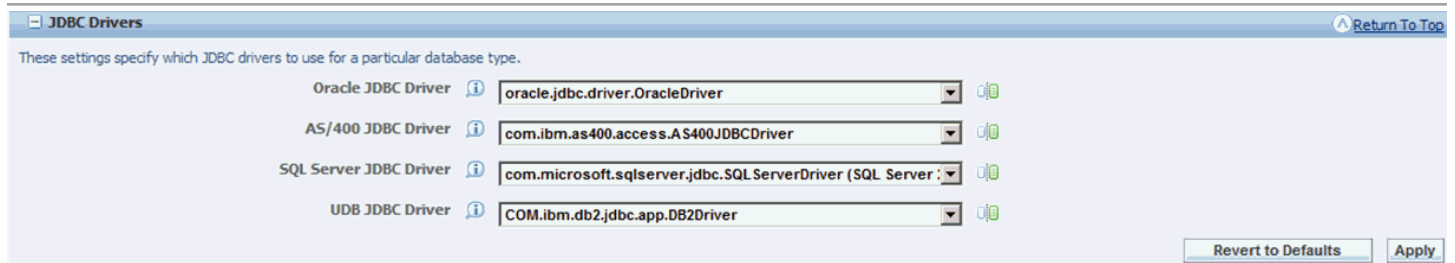

Below is a list of the settings and typical values:

- *Oracle JDBc Driver*

Enter a value. For example:

**oracle.jdbc.driver.OracleDriver**

- *DB2 for i JDBc Driver*

Enter a value. For example:

**com.ibm.as400.access.AS400JDBcDriver**

- *SQL Server JDBc Driver*

Enter a value. For example:

**com.microsoft.sqlserver.jdbc.SQL ServerDriver (SQL Server)**

- *UDB JDBc Driver (for DB2 for Linux, Windows, and UNIX )*

Enter a value. For example:

**COM.ibm.db2.jdbc.app.DB2Driver**

## JDBj Logging

This setting enables JDBc tracing from the JDBc drivers.

With a Transaction Server instance selected, the following shows typical setting:

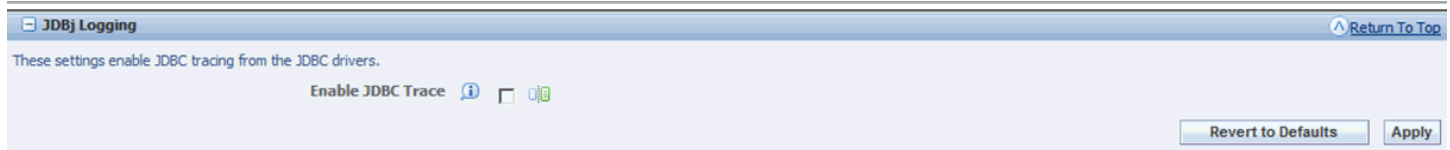

- *Enable JDBC Trace*

Click the checkbox to enable or disable a JDBC trace from the JDBC drivers.

## Oracle Database Settings

This section contains settings that are specific to utilizing Oracle databases. The TNSNAMES.ORA must contain the appropriate connection information for the Oracle database(s) this product will utilize. You may either select an existing location or use the text area to create a new file and update its contents. The TNSNAMES.ORA that is configured for the Management Console (home instance) will be used as a template for additional web products that are installed.

With a Transaction Server instance selected, the following shows typical values:

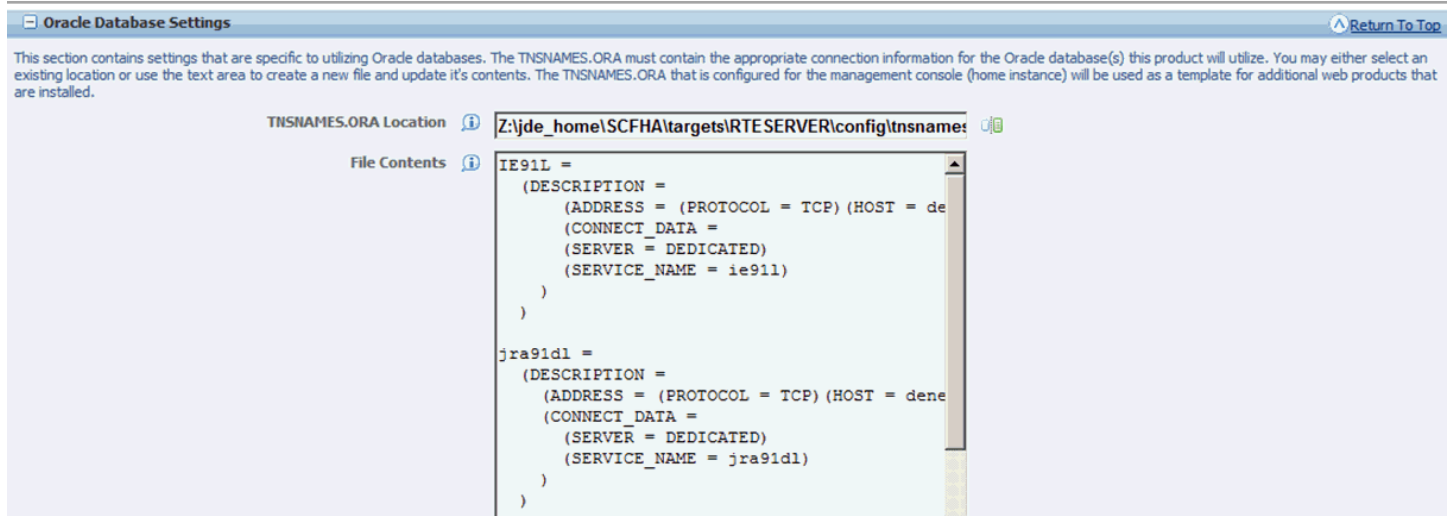

Below is a list of the settings and typical values:

- *TNSNAMES.ORA Location*

Specifies the location of the TNSNAMES.ORA file.

- *File Contents*

Displays the contents of the TNSNAMES.ORA file that will be used by the Server Manager Management Console.

## JDBj Runtime Properties

These settings correspond to system runtime properties applicable to JDBj logical connections.

With a Transaction Server instance selected, the following shows the typical value:

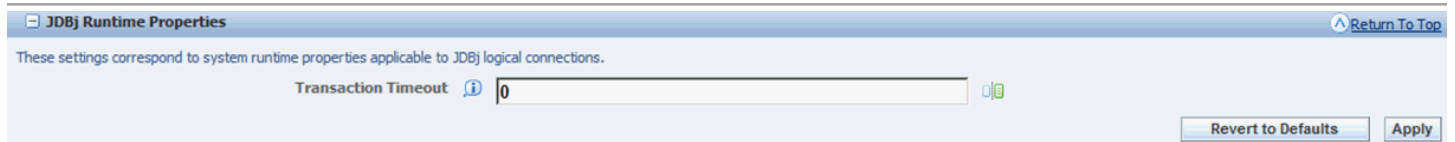

Below is the setting:

- *Transaction Timeout*

Specifies a value for the transaction timeout. The default is **0**.

## JDBj Spec Datasource

This optional section defines the data source where the serialized spec tables reside. JDBj uses these parameters at bootstrap time and after to look up serialized spec objects on demand. If this section is not specified, then JDBj will use the OCM to find the serialized table. If it is not valid, no JD Edwards EnterpriseOne database access is possible.

With a Transaction Server instance selected, the following shows the typical values:

**JDBJ Spec Datasource** [Return To Top](#)

This optional section defines the data source where the serialized spec tables reside. JDBJ uses these parameters at bootstrap time and after to look up serialized spec objects on demand. If this section is not specified, then JDBJ will use the OCM to find the serialized spec table. If it is not valid, no JD Edwards EnterpriseOne database access is possible.

System Datasource Name [?](#)

Database Type [?](#) **Oracle Database** [?](#)

Database Name [?](#)

Database Server Name [?](#)

Database TCP/IP Port [?](#) **0** [?](#)

Physical Database [?](#)

Object Owner [?](#)

Supports Large Objects (LOBS) [?](#)  [?](#)

Unicode Database [?](#)  [?](#)

Database User Name [?](#)

Database Password [?](#)

[Revert to Defaults](#) [Apply](#)

Below are the settings:

- *System Datasource Name*  
Specifies a value for the System datasource name.
- *Database Type*  
For example, a valid database type is **Oracle Database**.
- *Database Name*
- *Database Server Name*
- *Database TCP/IP Port*
- *Physical Database*

- *Object Owner*
- *Supports Large Objects (LOBs)*
- *Unicode Database*
- *Database User Name*
- *Database Password*

## Real Time Events























This section describes these topics:

- *Event Processor Configuration Settings*
- *Trigger Listener Kernel*

### Event Processor Configuration Settings

With a Transaction Server instance selected, the following shows the typical values for Event Processor Configuration Settings:

**Event Processor Configuration settings**

Sequencing Behavior	<input type="text" value="Events can be delivered in any sequence."/>		
Processing Concurrency	<input type="text" value="1"/>		
Trigger Listener Delay	<input type="text" value="10000"/>		
Max Transfer Session Size	<input type="text" value="5000"/>		
Initial Context Factory	<input type="text" value="weblogic.jndi.WLInitialContextFactory"/>		
JNDI Provider URL	<input type="text" value="t3://dnvmiedp12:1014"/>		
Event Transfer Transaction Isolation	<input type="text" value="serializable"/>		
Event Client Session Check Interval	<input type="text" value="60000"/>		
Event Client Session Timeout	<input type="text" value="3600000"/>		
App Server JNDI User	<input type="text" value="*****"/>		
App Server JNDI Password	<input type="text" value="*****"/>		



Below are the settings:

- *Sequencing Behavior*

This setting describes how the event sequencing occurs during Transaction Server processing.

Event sequencing behavior values are:

- *AnySequence*

Events can be delivered in any sequence.

- *ByEventType*

Events are guaranteed to be delivered in sequence by event type.

- *ByUserSession*

Events are guaranteed to be delivered in sequence by originating user session.

- *GlobalFIFO*

Events are guaranteed to be delivered in sequence by their original generation sequence. This option does not permit concurrent processing and may impact performance. When this option is selected the **Processing Concurrency** value is ignored.

- *Processing Concurrency*

This setting describes the number of concurrent event processing threads to run. Maximum of 4 concurrent threads can run enhancing the Transaction Server processing performance.

- *Trigger Listener Delay*

This setting specifies the time, in milliseconds, between timer checks of the database for events waiting to be processed. A negative value will disable the timer.

- *Max Transfer Session Size*

This setting specifies the maximum number of events to transfer in one transfer session (that is, one result set from the database).

- *Initial Context Factory*

The InitialContextFactory for the JNDI service of the event server. This value is set as per the transaction server environment.

- *Provider URL*

The Provider URL for the JNDI service of the event server. This value is automatically set as per the transaction server environment.

- *Event Transfer Transaction Isolation*

The transaction isolation level to be used by the transfer agent when reading committed events from the database.

Suggested values based on database server type hosting the F90710 table are shown in the following table:

Server Type	Isolation Level
AS/400	serializable

Server Type	Isolation Level
Oracle	serializable
SQL Server	serializable
DB2 for Linux, Windows, and UNIX	serializable

- *Event Client Session Check Interval*

This configuration is to check the frequency to check for an expired session.

- *Event Client session Timeout*

This configuration is to check how long a session can be idle before it is timed out.

- *App Server JDNI User*

- *App Server JDNI Password*

## Trigger Listener Kernel

This setting applies to the TriggerListener Kernel thread responsible to receive messages from the Enterprise Server that an event has been triggered. All of the configuration settings found under this section are predefined and should **not** be changed.

Trigger Listener Kernel
[Return To Top](#)

This setting is for the TriggerListener kernel thread. This thread is responsible to receive messages from Enterprise Logic Server that an event has been entered into table. Once this message is received the Listener triggers the processing of the Transaction Server.

Kernel Name	ⓘ	<input type="text" value="TriggerListener Kernel"/>	🔍	
Process Class Name	ⓘ	<input type="text" value="com.peoplesoft.pt.e1.server.enterprise.events.triggerlisten"/>	🔍	
Start Message Range	ⓘ	<input type="text" value="15500"/>	🔍	
End Message Range	ⓘ	<input type="text" value="15750"/>	🔍	
Maximum Threads	ⓘ	<input type="text" value="3"/>	🔍	

## Network Settings

This section describes these topics:

- *JDENET Configuration*
- *Security Server Configuration*

### JDENET Configuration

These settings configure how JDENET, which is the EnterpriseOne messaging protocol, is configured. Any changes to the JDENET configuration will require restarting the server to take effect.

The screenshot shows the 'JDENET Configuration' window. At the top, there is a title bar with a minus sign and the text 'JDENET Configuration'. Below the title bar, a paragraph states: 'These settings configure how JDENET, the EnterpriseOne messaging protocol, is configured. Any changes to the JDENET configuration will require restarting the server to take effect.' The main area contains several configuration items, each with a label, an information icon (i), a text input field, and a help icon (question mark in a square):

- Outgoing JDENET Port: 4012
- Incoming JDENET Port: 4022
- Kernel Ranges: 2
- Timeout Threshold: 90000
- Pool Size: 50
- Back Off Time: 30000
- Enqueue Timeout: 180000

At the bottom right of the window, there are two buttons: 'Revert to Defaults' and 'Apply'.

Below are the settings:

- *Outgoing JDENET Port*
- *Incoming JDENET Port*

- *Kernel Ranges*
- *Timeout Threshold*
- *Pool Size*
- *Back Off Time*
- *Enqueue Timeout*

## Security Server Configuration

These settings configure the EnterpriseOne Enterprise Server to use for security services for this instance. Any changes you make here will not take effect until the server is restarted.

Security Server Configuration

These settings configure the EnterpriseOne enterprise server to use for security services for this instance. Any changes made will not take effect until the instance is restarted.

Security Server Count	1
Primary Security Server	den03fqt
Secondary Security Server	NONE
Third Security Server	NONE
Fourth Security Server	NONE
Fifth Security Server	NONE
Token Re-Authenticate Delay	3600000

Revert to Defaults Apply

Below are the settings:

- *Security Server Count*
- *Primary Security Server*
- *Secondary Security Server*
- *Third Security Server*
- *Fourth Security Server*
- *Fifth Security Server*
- *Token Re-Authenticate Delay*

**Note:** The Token Re-Authenticate Delay setting can be configured to refresh the RTE token used for connection at regular intervals.

## Log File Configuration (jdelog.properties)

This section is used to configure logs. You may add, remove, or configure the log files contained within this section. You must click the **Apply** button on this form to save any changes made to this Log Configuration section.

**Log File Configuration**

Shown below are the log configurations found in the `jde1log.properties` for this instance. You may add, remove, or configure the log files contained within.  
It is necessary to click the **Apply** button below this form to save the changes made to the Log Configuration.

Select [Log Configuration]:

[Select All](#) | [Select None](#)

Log Name <small>(i)</small>	Log File Name <small>(i)</small>	Log Level Threshold <small>(i)</small>	Log Format <small>(i)</small>	Append Log Files <small>(i)</small>	Max. Log Size <small>(i)</small>	Max. Backup Index <small>(i)</small>	Log Components <small>(i)</small>
<input type="checkbox"/> E1LOG	Z:\jde_home\SCFHA\targets\RTESERVER\logs\le1root.log	Warnings and Recoverable Errors	Application Format	TRUE	10MB	20	ALL LB



# 3 Configuring JD Edwards EnterpriseOne

After configuring your Transaction Server, you must set up the Transaction Server Components data for your *JD Edwards EnterpriseOne* environments to properly generate events.

## Verifying User Defined Codes (UDCs)

The Transaction Server Components requires the specific User Defined Codes (UDCs) to be populated as shown in this table.

**Note:** By default, the UDCs are delivered and populated correctly. The information in this section is only provided for verification purposes.

UDC	Purpose
H90/EC	Event Category
H90/TP	Event Transport Parameter Type

## Verifying Tables

The Transaction Server Components requires the use of the tables listed below. The default configuration for RTE is where all of the F907\* tables (event tables) reside in one datasource. Out of the box these tables are included in the System datasource database (that is, SYxxx -- where xxx is the release, for example, SY920). Using this default configuration, only one Transaction Server may be configured to monitor the F907\* tables. Verify that these tables were created in the *JD Edwards EnterpriseOne* environments that will generate Real Time Events (RTE) events. Ensure that the server map OCMs and client map OCMs point to the same set of tables.

Table	Description
F90701	Interoperability Event Definition
F90705	Event Activation
F90706	Event Subscriber
F90707	Event Subscription

Table	Description
F907071	Subscribed Events
F907072	Subscribed Environments
F90708	Event Sequence
F90710	Event Transfer
F90711	Event Transport Parameters
F90712	Event Transfer Failure
F90715	Event Subscriber Queues
F90720	Event Metrics
F90730	Unique Sequence

## Verifying Serialized Objects

Serialized objects for tables, specs, and data structures must exist on the database machine. Verify that the serialized objects have been generated and copied to the database machine. For more information on performing the generation, see the *JD Edwards EnterpriseOne HTML Web Server Reference Guide*, specific for your platform, and the *Generating JD Edwards EnterpriseOne Serialized Objects* chapter.

## Activating Events

Using this procedure, you must use *JD Edwards EnterpriseOne* universal batch engine (UBE) processes to convert the existing event data to be compatible with the new tables.

1. Run the Populate Event Activation Status Table (R90705) to create an activation record for every environment for every event defined in the F90701 table. Through use of the processing options you can process this UBE



for all events and all environments or for a single event and/or environment. You can run this UBE multiple times if necessary.

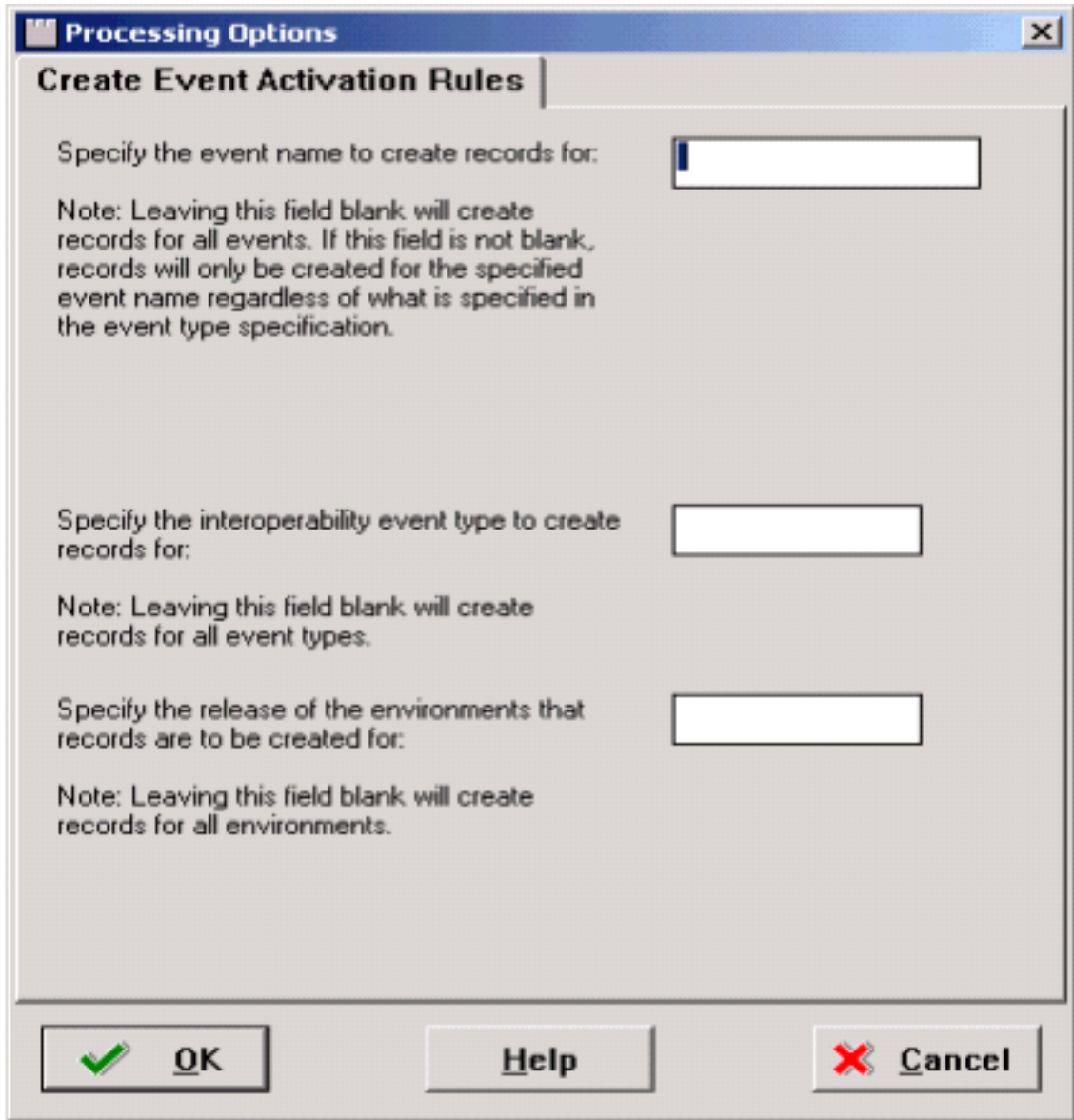

2. On Processing Options, Create Event Activation Rules, complete these fields:

Field	Description
<i>Specify the event name to create records for:</i>	If you leave this field blank, records are created for all events. If you specify a value for this field, records are only created for the specified event name regardless of what is specified in the event type specification.
<i>Specify the interoperability event type to create records for:</i>	If you leave this field blank, records are created for all event types. Valid event types are: <ul style="list-style-type: none"> <li>o RTE</li> </ul>

Field	Description
	<ul style="list-style-type: none"><li>○ WF</li><li>○ XAPI</li><li>○ ZFILE</li></ul>
<i>Specify the release of the environments that records are to be create for:</i>	If you leave this field blank, records are created for all environments. Values are supported releases of <i>JD Edwards EnterpriseOne</i> , specified by internal designations.

**Note:** You may use data selection to select on events that are currently active in the event system to convert.

3. Run the Convert Event Subscriptions (R90706) UBE to populate the Queue Assignment Table (F90715) with the subscriber queues defined in the Transaction Server. You can use processing options to initially create your subscriber queue records and convert your subscribers and subscriptions. Later if you add new subscribers

you can use this UBE to only create the new subscriber queue records. Initially there are 16 subscriber queues delivered with JD Edwards EnterpriseOne.

**Note:** The R90706 program does not create the subscriber queues. Instead, 16 of these subscriber queues were created during the initial installation of the Transaction Server Components on an Application Server. If you have more than 16 subscribers you will need to create the additional queues using Application Server administrator tools prior to running this program.

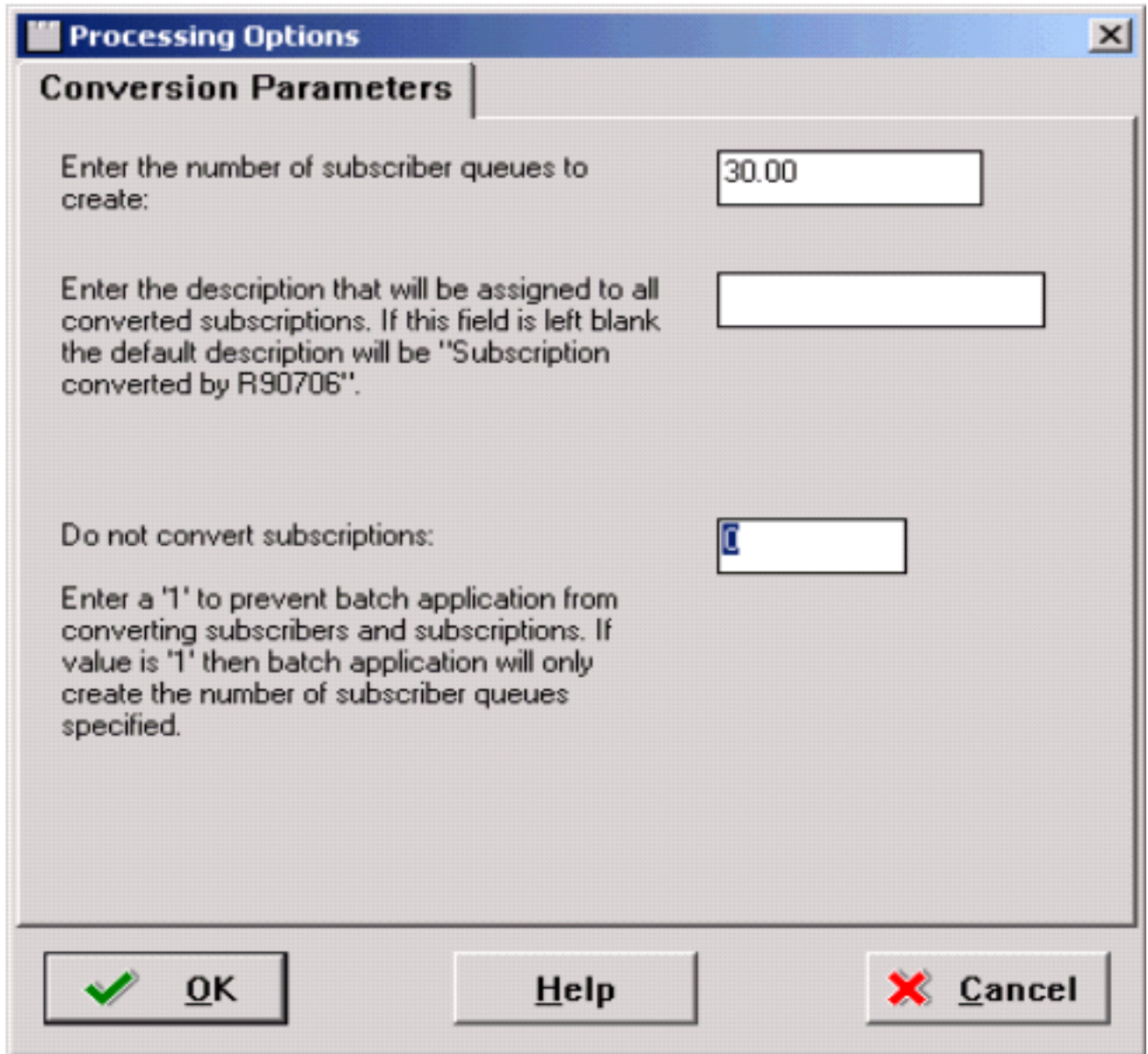

4. On the Conversion Parameters tab, complete these fields:

Field	Description
Enter the number of subscriber queues to create:	Set this value to the number of subscriber queues for your installation. You must create a queue for every subscriber.

Field	Description
<i>Enter the description that will be assigned to all converted subscriptions. If this field is left blank the default description will be "Subscription converted by R90706".</i>	Enter a value to describe all converted description. If you leave this field blank the default description is "Subscription converted by R90706".
<i>Do not convert subscriptions</i>	<p>Values are:</p> <p>0: Convert subscriptions</p> <p>1: Do not convert subscribers and subscriptions. The R90706 program only creates the number of subscriber queues that you specify and does not perform any conversions.</p>

**Note:** You may use data selection to select on events that are currently active in the event system to convert.

- Run the Synch Z Events in F47002 with F90701 (R90701A) UBE to create event records in the F90701 for the z-event records in the F47002 table for records that do not currently exist in the F90701 table. There are no processing options for this UBE.

## Creating Triggers

You must create a trigger on the F90710 table. Prior to running the trigger creation script, ensure that you have adequate database privileges required to create a trigger. This table lists the privileges by database.

**Note:** Additionally, as described in the Prerequisites sections of this guide, you must obtain and install a specific ESU to enable the creation of triggers for Transaction Server Components.

Database	Required Privilege
<i>DB2 for i</i>	No special privileges are required.
<i>DB2 for Linux, Windows, and UNIX</i>	<p>Grant the following privileges to the database proxy user. Replace <code>jde</code> in the following script with the actual database proxy user name.</p> <pre>GRANT CONTROL ON TABLE SY920.F90710 TO USER jde</pre>
Oracle	<p>Grant the following privileges to the JDE_ROLE or the database proxy user.</p> <pre>GRANT CREATE ANY SEQUENCE TO JDE_ROLE; GRANT DROP ANY SEQUENCE TO JDE_ROLE; GRANT CREATE ANY TRIGGER TO JDE_ROLE; GRANT DROP ANY TRIGGER TO JDE_ROLE;</pre>

Database	Required Privilege
SQL Server	<p>The database proxy user must have the privileges to create database triggers. Replace <code>jde</code> with the actual database proxy user name.</p> <pre>Exec sp_addrolemember db_owner, jde</pre>

You must create the (F90710) Event Transfer and the (F90730) Unique Sequence in the same *JD Edwards EnterpriseOne* data source. You should verify this configuration using OCM.

1. Run this script from a *JD Edwards EnterpriseOne* Microsoft Windows-based Web Development Client:

```
x:\JDEdwards\ E900 \system\bin32\dbtemplates.exe -create
```

2. After the scripts complete successfully, you should revoke any special privileges you granted in order to create the triggers. This table lists the revocation commands by database.

Database	Required Privilege
<i>DB2 for i</i>	No special privileges are required.
<i>DB2 for Linux, Windows, and UNIX</i>	<p>Revoke the following privileges to the database proxy user. Replace <code>jde</code> in the following script with the actual database proxy user name.</p> <pre>REVOKE CONTROL ON TABLE SY920.F90710 TO USER jde</pre>
Oracle	<p>Revoke the following privileges to the JDE_ROLE or the database proxy user.</p> <pre>REVOKE CREATE ANY SEQUENCE TO JDE_ROLE; REVOKE DROP ANY SEQUENCE TO JDE_ROLE; REVOKE CREATE ANY TRIGGER TO JDE_ROLE; REVOKE DROP ANY TRIGGER TO JDE_ROLE;</pre>
SQL Server	<p>Replace <code>jde</code> with the actual database proxy user name.</p> <pre>exec sp_droprolemember db_owner, jde</pre>



# 4 Adding a Subscriber

## Setting Processing Options for Event Subscribers Application (P90702A)

This section discusses how to set up the default values for the processing option.

To set Processing Options for P90702A:

1. Type IV in the *Fast Path*.
2. Type P90702A in the *Interactive Application* and click *Find*.

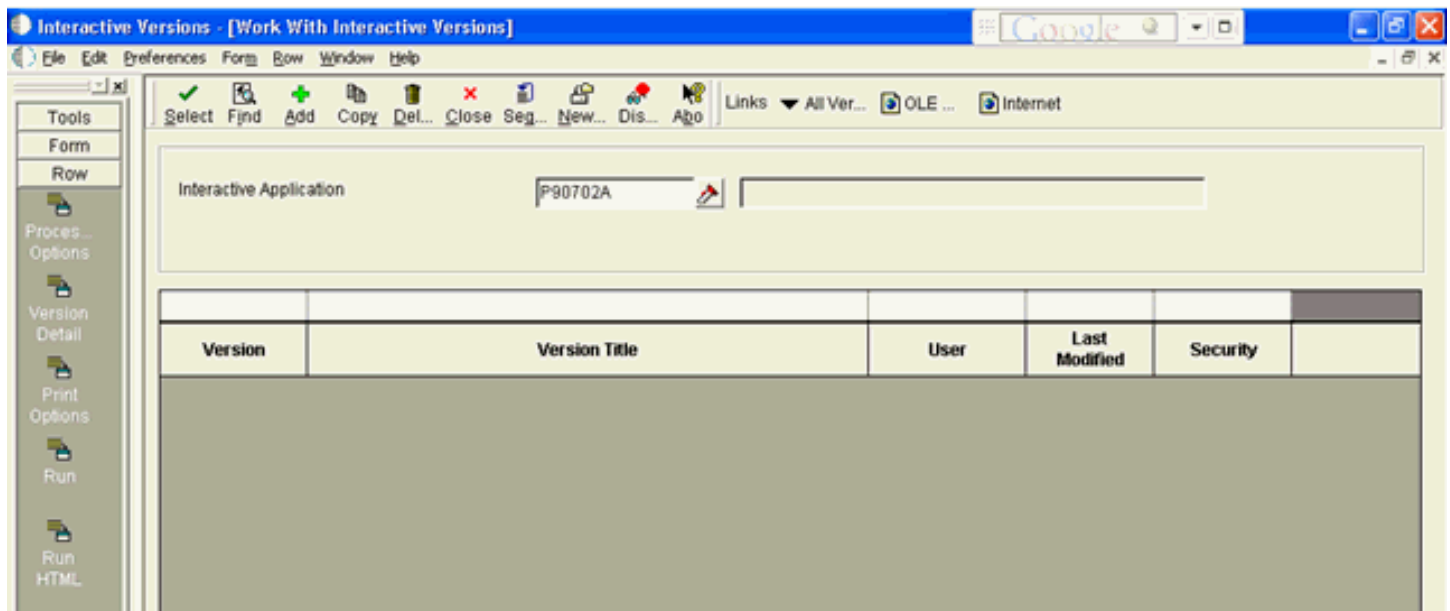

3. Select the row that appears in the grid and then click *Processing Options* from *Row* menu.

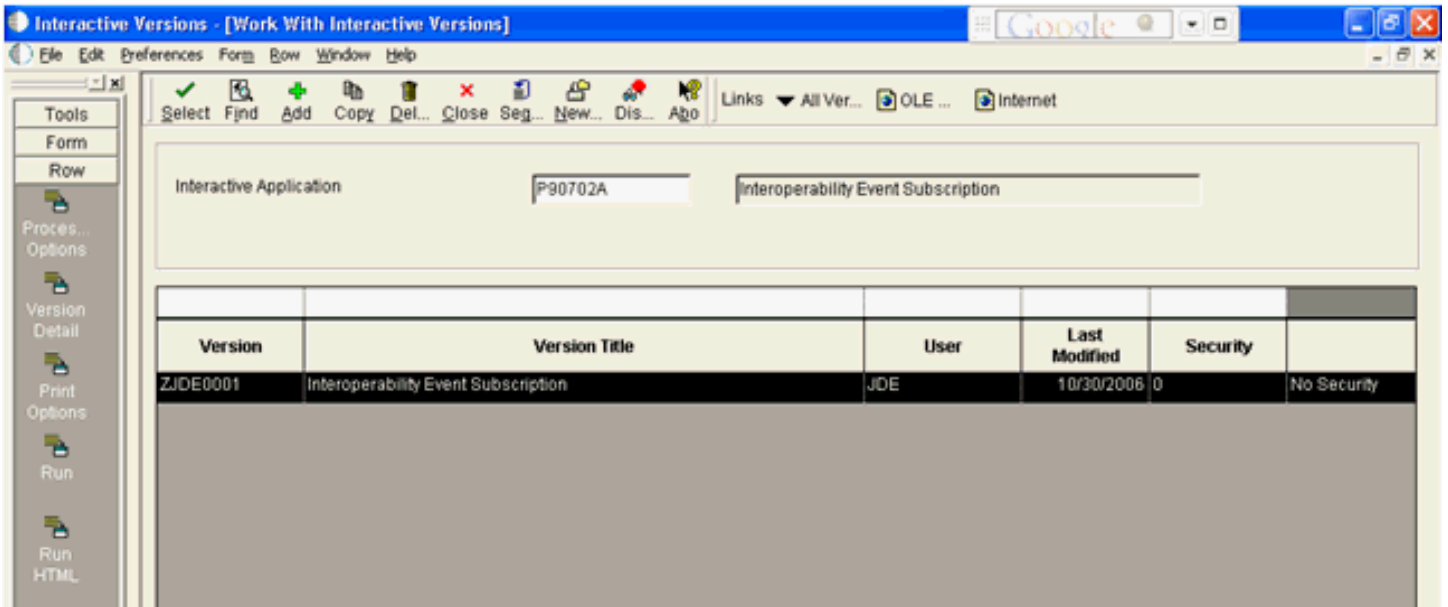



4. On *Processing Options*, edit the default values and click *OK*.

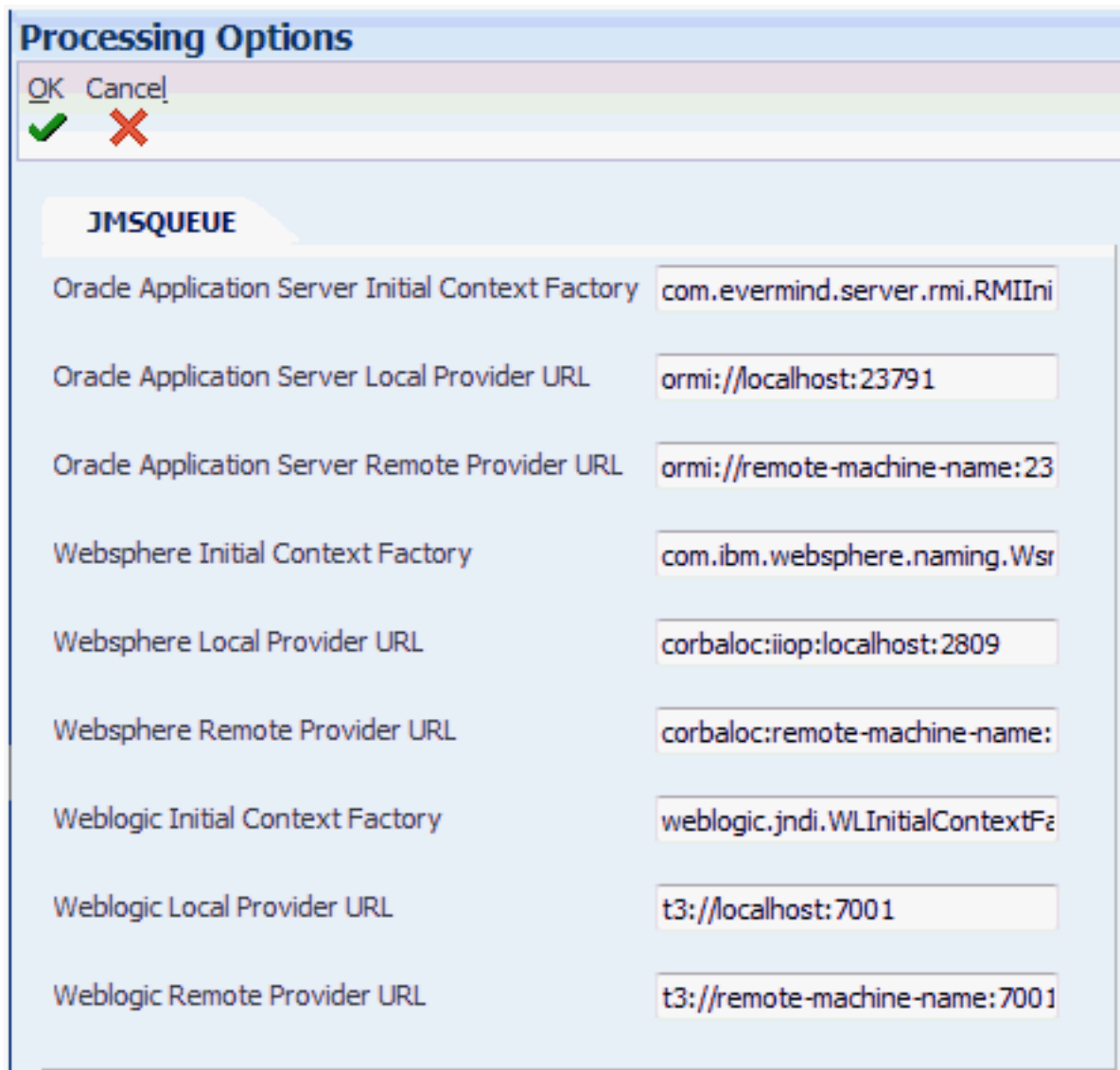

Property Name	Value
Oracle Application Server Initial Context Factory	com.evermind.server.rmi.RMIIni
Oracle Application Server Local Provider URL	ormi://localhost:23791
Oracle Application Server Remote Provider URL	ormi://remote-machine-name:23
Websphere Initial Context Factory	com.ibm.websphere.naming.Wsr
Websphere Local Provider URL	corbaloc:iiop:localhost:2809
Websphere Remote Provider URL	corbaloc:remote-machine-name:
Weblogic Initial Context Factory	weblogic.jndi.WLInitialContextFa
Weblogic Local Provider URL	t3://localhost:7001
Weblogic Remote Provider URL	t3://remote-machine-name:7001

**Note:** The values for these processing options are set by using an EnterpriseOne application as described in the next section of this chapter in the section entitled: *Using Event Subscribers Application to Add a Subscriber*.

## Using Event Subscribers Application to Add a Subscriber

This section discusses how to add a subscriber to EnterpriseOne by executing the application P90702A.

To use P90702A to add a JMSQUEUE or JMSTOPIC subscriber:

1. Run the application P90702A from JAS.

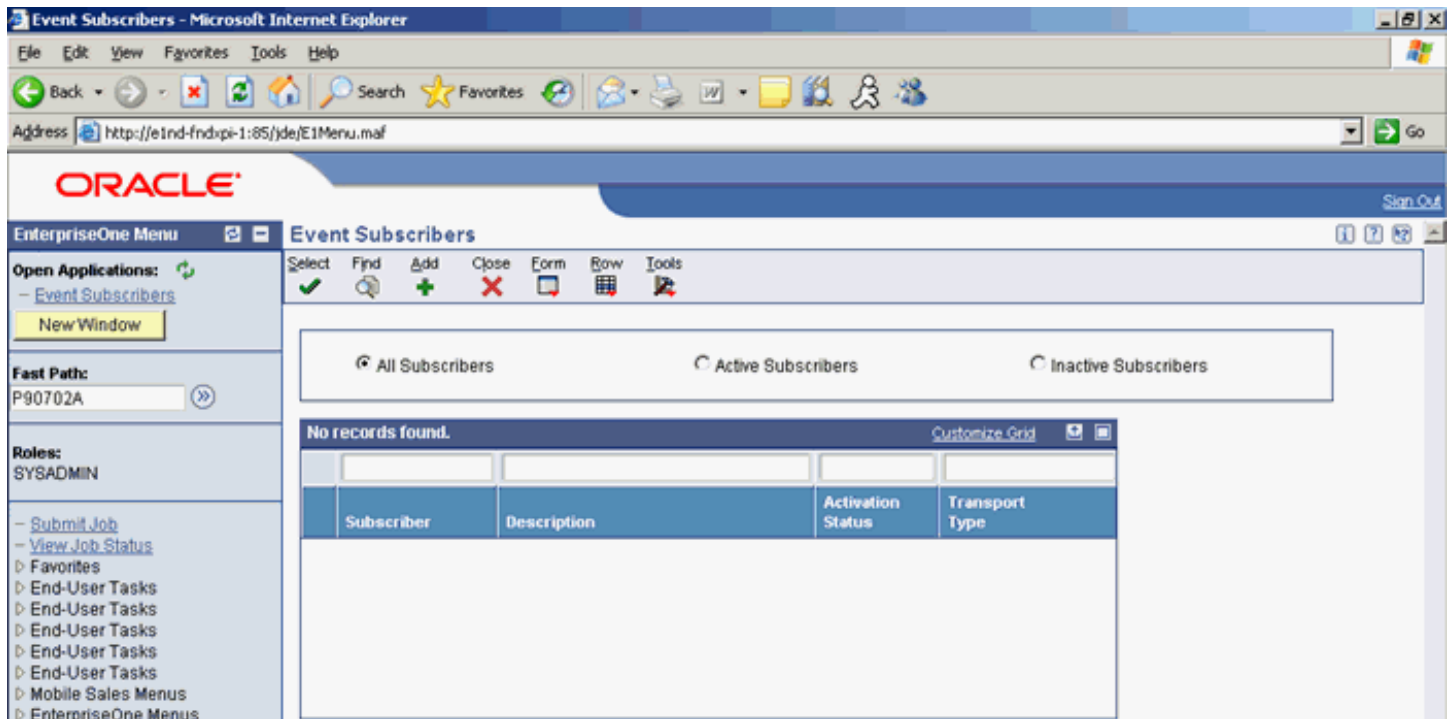

2. Click the *Add* button. Enter the values as per any one of the following options:

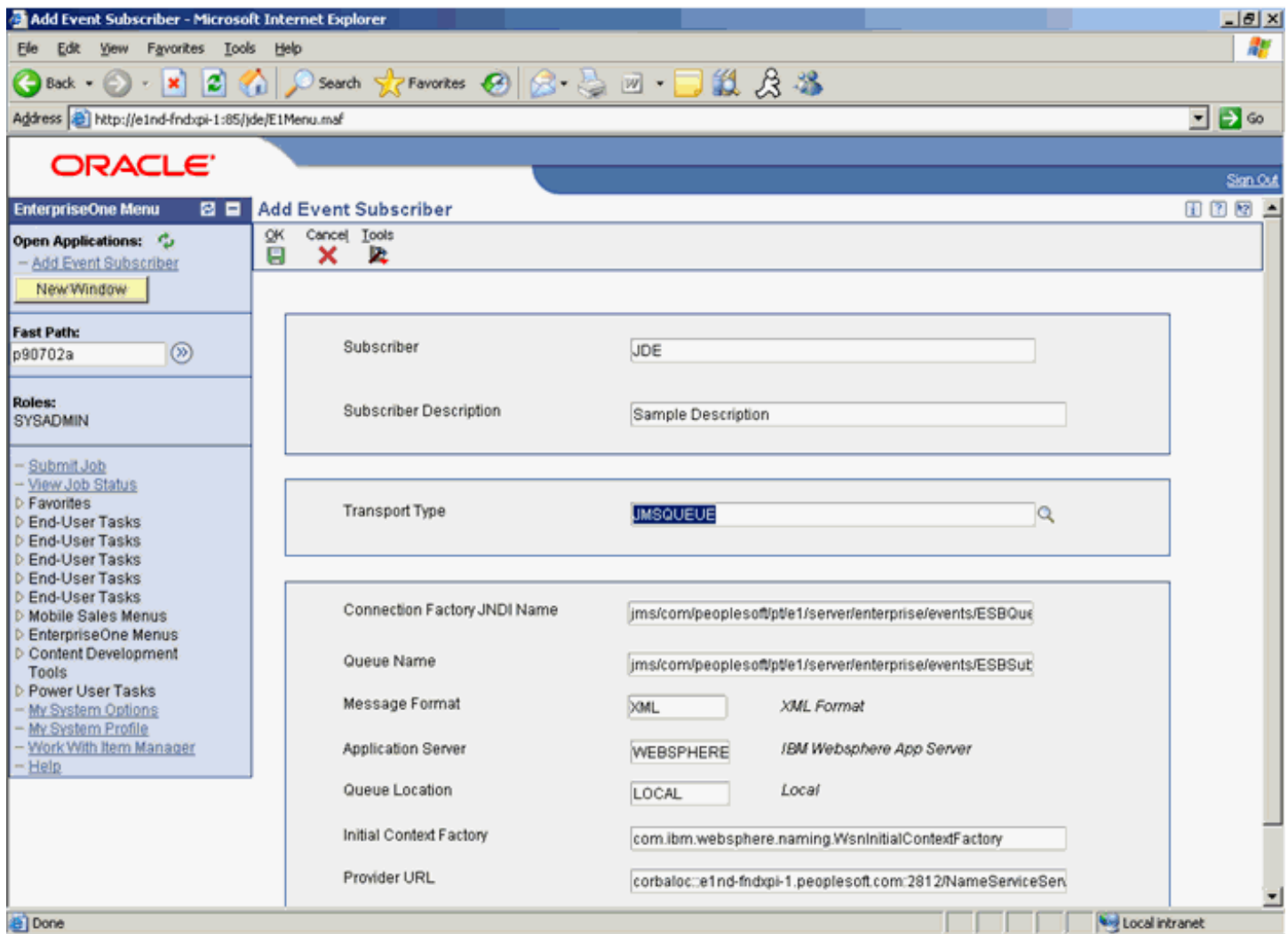

The Initial Context Factory and Provider URL values are populated based on the selections for Application Server and Queue Location. Edit these values according to the environment. A processing option determines the default values.

The values for **Connection Factory JNDI Name** and **Queue Name** are the JNDI name for the subscriber Queue or Topic that is being created.

# Working with Subscribers in JD Edwards EnterpriseOne

This section describes these tasks:

- *Adding a JAVACONN Subscriber*
- *Creating a JMSQUEUE Subscriber*
- *Creating a JMSTOPIC Subscriber*
- *Creating a Subscription*
- *Adding an Event to the Subscription*
- *Adding Environment(s) to a Subscription*

## Adding a JAVACONN Subscriber

Use this procedure to add a JAVACONN subscriber in JD Edwards EnterpriseOne:

1. From a JD Edwards EnterpriseOne client, run P90702A to use the Add Event Subscriber application to add a subscriber.

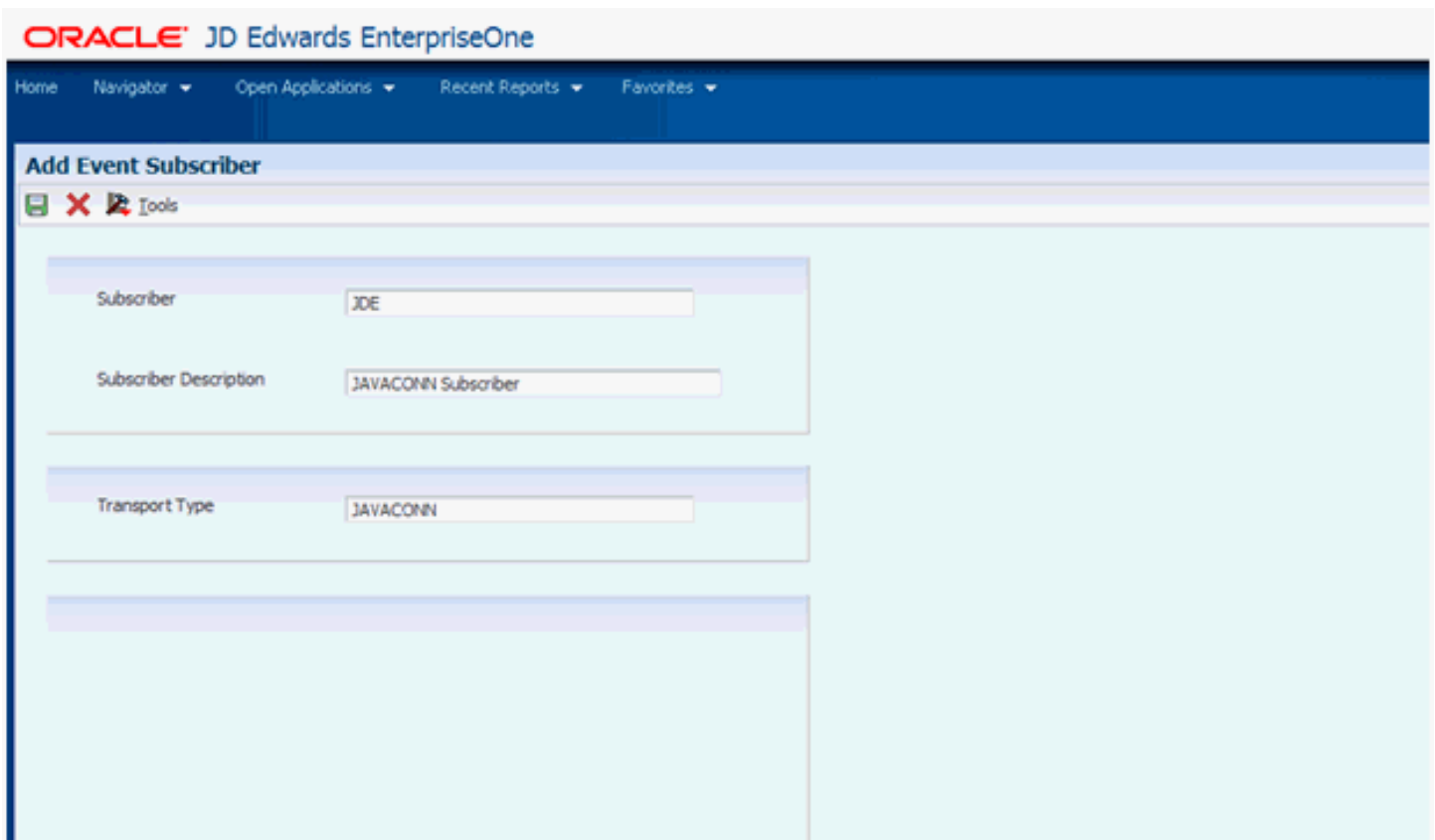

The screenshot displays the 'Add Event Subscriber' application interface. The title bar reads 'ORACLE JD Edwards EnterpriseOne'. Below the title bar is a navigation menu with 'Home', 'Navigator', 'Open Applications', 'Recent Reports', and 'Favorites'. The main content area is titled 'Add Event Subscriber' and contains a form with the following fields:

Subscriber	JDE
Subscriber Description	JAVACONN Subscriber
Transport Type	JAVACONN

Field	Description
<i>Subscriber</i>	The <i>Subscriber</i> field must have a value matching valid user in JD Edwards EnterpriseOne.
<i>Subscriber Description</i>	Enter this value:  <b>JAVACONN Subscriber</b>
<i>Transport Type</i>	Enter this value:.  <b>JAVACONN</b>

2. Click the **OK** button to accept the values.
3. Run the P90702A application and find the JAVACONN Subscriber created in the above step.
4. Activate the JAVACONN Subscriber by taking this Form Exit:  
  
Row > Change Status
5. Change the status to AV (Active).

## Creating a JMSQUEUE Subscriber



To create a JMSQUEUE subscriber:

1. From a JD Edwards EnterpriseOne client, run P90702A to use the Add Event Subscriber application to add a subscriber.

# ORACLE JD Edwards EnterpriseOne

Home Navigator ▾ Open Applications ▾ Recent Reports ▾ Favorites ▾

## Add Event Subscriber

   Tools

Subscriber	<input type="text" value="JDE"/>
Subscriber Description	<input type="text" value="JMSQUEUE Subscriber"/>
Transport Type	<input type="text" value="JMSQUEUE"/>
Connection Factory JNDI Name	<input type="text" value="jms/TestConnectionFactory"/>
Queue Name	<input type="text" value="jms/TestQueue"/>
Message Format	<input type="text" value="XML"/> <i>XML Format</i>
Application Server	<input type="text" value="WEBLOGIC"/> <i>Weblogic App Server</i>
Queue Location	<input type="text" value="LOCAL"/> <i>Local</i>
Initial Context Factory	<input type="text" value="weblogic.jndi.WLInitialContextFactory"/>
Provider URL	<input type="text" value="t3://dndedasvm4.us.oracle.com:7002"/>

Field	Description
<i>Subscriber</i>	The <i>Subscriber</i> field must have a value matching valid user in JD Edwards EnterpriseOne.
<i>Subscriber Description</i>	Enter this value:  <b>JMSQUEUE Subscriber</b>
<i>Transport Type</i>	Enter this value:.  <b>JMSQUEUE</b>
<i>Connection Factory JNDI</i>	You can specify any path and name.  <b>Note:</b> You must use this same value when creating the Connection Factory in WebLogic as described later in this guide. For purposes of this documentation, the value is:  <code>jms/TestConnectionFactory</code>
<i>Queue Location</i>	You can choose either LOCAL or REMOTE.  <b>Note:</b> If the subscriber queue is created on the Transaction Server instance you should specify the value as LOCAL. If the subscriber queue is on remote WebLogic container, specify the value as REMOTE
<i>Initial Context Factory</i>	Enter this value:  <code>weblogic.jndi.WLInitialContextFactory</code>
<i>Provider URL</i>	Enter this value:  <code>t3://&lt;WLS_SERVER_HOST&gt;:&lt;WLS_SERVER_PORT&gt;</code>  <b>Note:</b> < WLS_SERVER_HOST > is the host of the machine where the subscriber queue is created and <WLS_SERVER_PORT> is the port at which the server is hosted.

2. Click the **OK** button to accept the values.
3. Run the P90702A application and find the JMSQUEUE Subscriber created in the above step.
4. Activate the JMSQUEUE Subscriber by taking this Form Exit:

Row > Change Status

5. Change the status to AV (Active).



## Creating a JMSTOPIC Subscriber

To create a JMSTOPIC subscriber:

1. From a JD Edwards EnterpriseOne client, run P90702A to use the Add Event Subscriber application to add a subscriber.

**ORACLE JD Edwards EnterpriseOne**

Home Navigator Open Applications Recent Reports Favorites

### Add Event Subscriber

Tools

Subscriber

Subscriber Description

Transport Type

Connection Factory JNDI Name

JMS Topic

Field	Description
<i>Subscriber</i>	The <i>Subscriber</i> field must have a value matching valid user in JD Edwards EnterpriseOne.

Field	Description
<i>Subscriber Description</i>	Enter this value:  <b>JMSTOPIC Subscriber</b>
<i>Transport Type</i>	Enter this value:.  <b>JMSTOPIC</b>
<i>Connection Factory JNDI</i>	You can specify any path and name.  <b>Note:</b> You must use this same value when creating the Connection Factory in WebLogic as described later in this guide. For purposes of this documentation, the value is:  <code>jms/TestConnectionFactory</code>

2. Click the **OK** button to accept the values.
3. Run the P90702A application and find the JMSTOPIC Subscriber created in the above step.
4. Activate the JMSTOPIC Subscriber by taking this Form Exit:  
  
Row > Change Status
5. Change the status to AV (Active).

## Creating a Subscription

Use this procedure to create a Subscription.

1. From a JD Edwards EnterpriseOne client, run the P90702A application and find the Subscribers you created in the previous steps of this section.

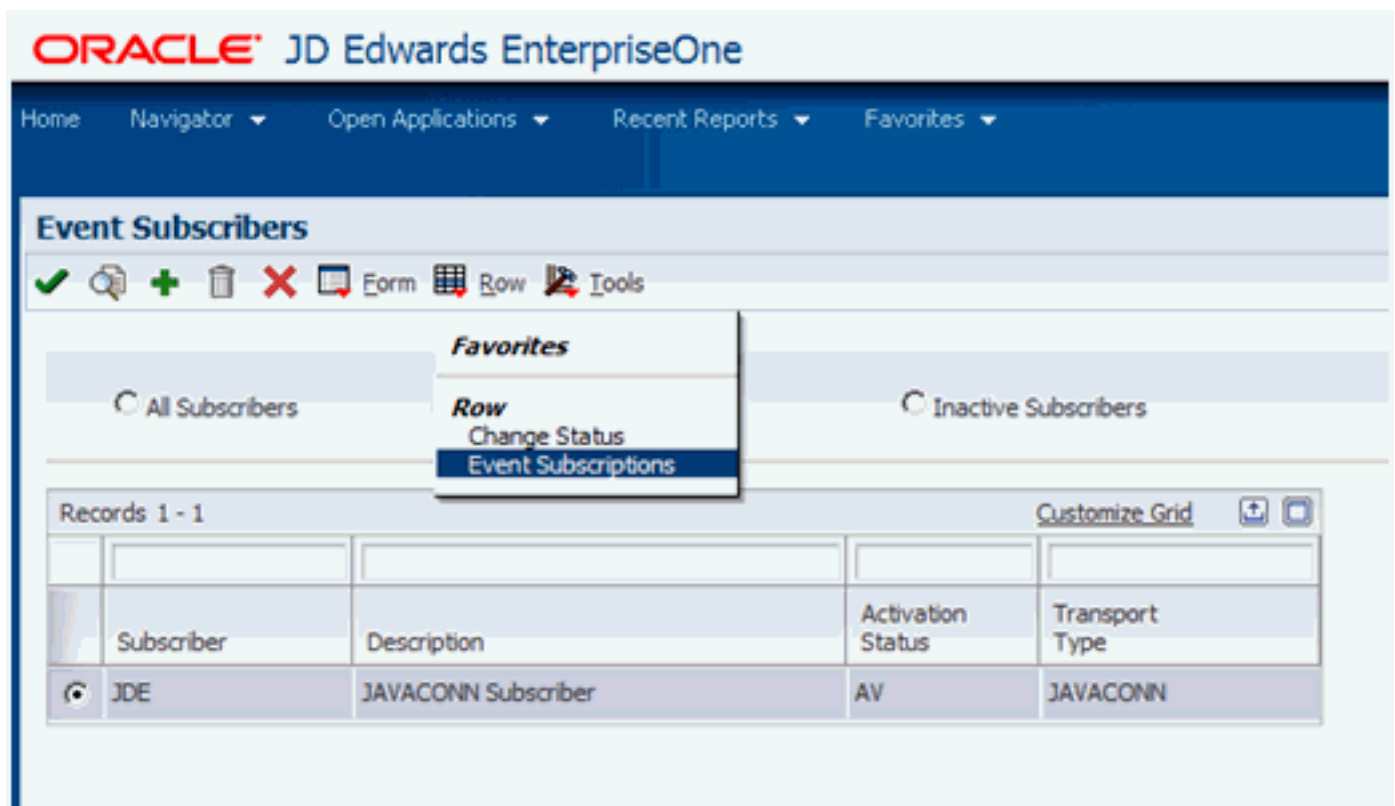

2. On Event Subscribers, take the Row Exit for Event Subscriptions.

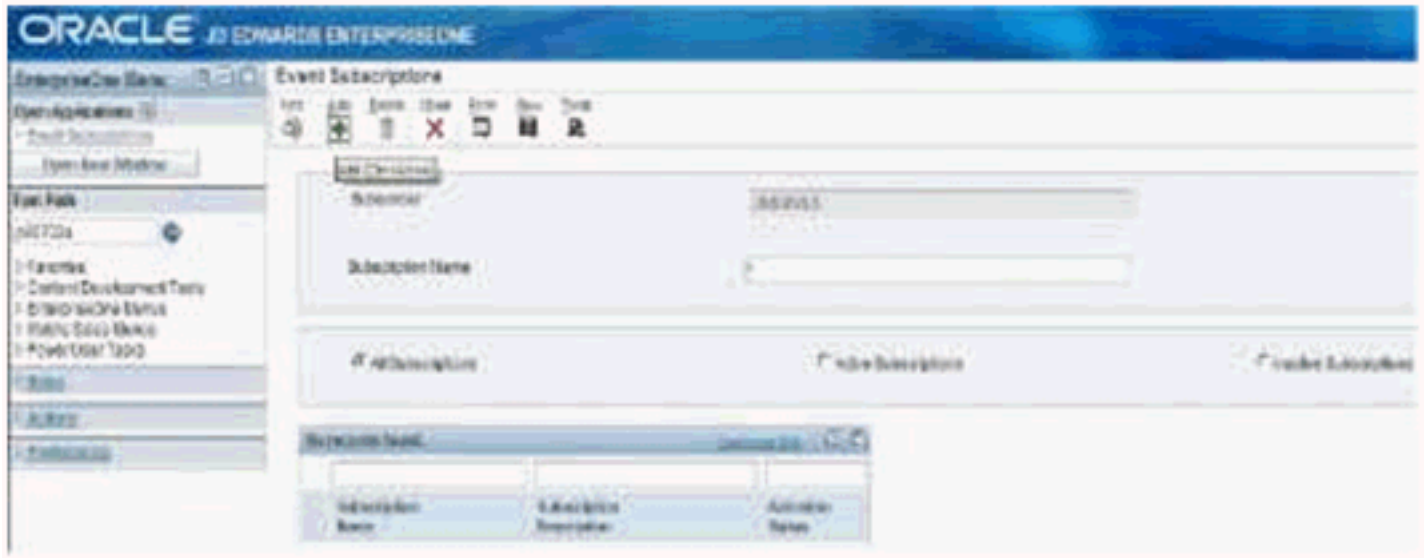

3. On Event Subscriptions, click the **Add** button.

The screenshot shows the 'Add Event Subscription' form. The form is titled 'Add Event Subscription' and has a blue header with navigation links: Home, Navigator, Open Applications, Recent Reports, and Favorites. Below the header is a title bar with icons for save, delete, and refresh, and a 'Tools' menu. The main form area has three input fields: 'Subscriber' with the value 'JDE', 'Subscription Name' with the value 'JDE', and 'Subscription Description' with the value 'JDE Subscriber'.

4. On Add Event Subscription, complete the *Subscriber Name* and *Subscriber Description* fields with any value. In this example, the both values are **JDE**.
5. Click the **OK** button to accept the values.
6. Activate the Subscriber by taking this Form Exit:  
Row > Change Status
7. Change the status to AV (Active).

## Adding an Event to the Subscription

Use this procedure to add an Event to the Subscription.

**Note:** In this example, the added event is named RTABOUT.

1. Run P90702A and find the Subscriber created in the previous step of this section.

**Note:** In this documentation, that subscription was called **JDE**.

ORACLE JD Edwards EnterpriseOne

Home Navigator Open Applications Recent Reports Favorites

### Event Subscriptions

Form Row Tools

Subscriber

Subscription Name

**Favorites**

**Row**

- Subscribed Events
- Subscribed Env
- Change Status

All Subscriptions  Active Subscriptions  Inactive Subscriptions

Records 1 - 1 Customize Grid

Subscription Name	Subscription Description	Activation Status
<input checked="" type="radio"/> JDE	JDE Subscriber	AV

2. On Event Subscriptions, select the *Subscribed Events* Row Exit.

**ORACLE** JD Edwards EnterpriseOne

Home Navigator Open Applications Recent Reports Favorites

### Subscribed Events

Save Search Delete Cancel Refresh Tools

Subscriber: JDE

Subscription Name: JDE

Records 1 - 2 Customize Grid

	Event Type	Event Category
<input checked="" type="radio"/>	RTABOUT	RTE
<input type="radio"/>		



3. On Subscribed Events, add *RTABOUT* as an *Event Type* by clicking the radio button next to the value.

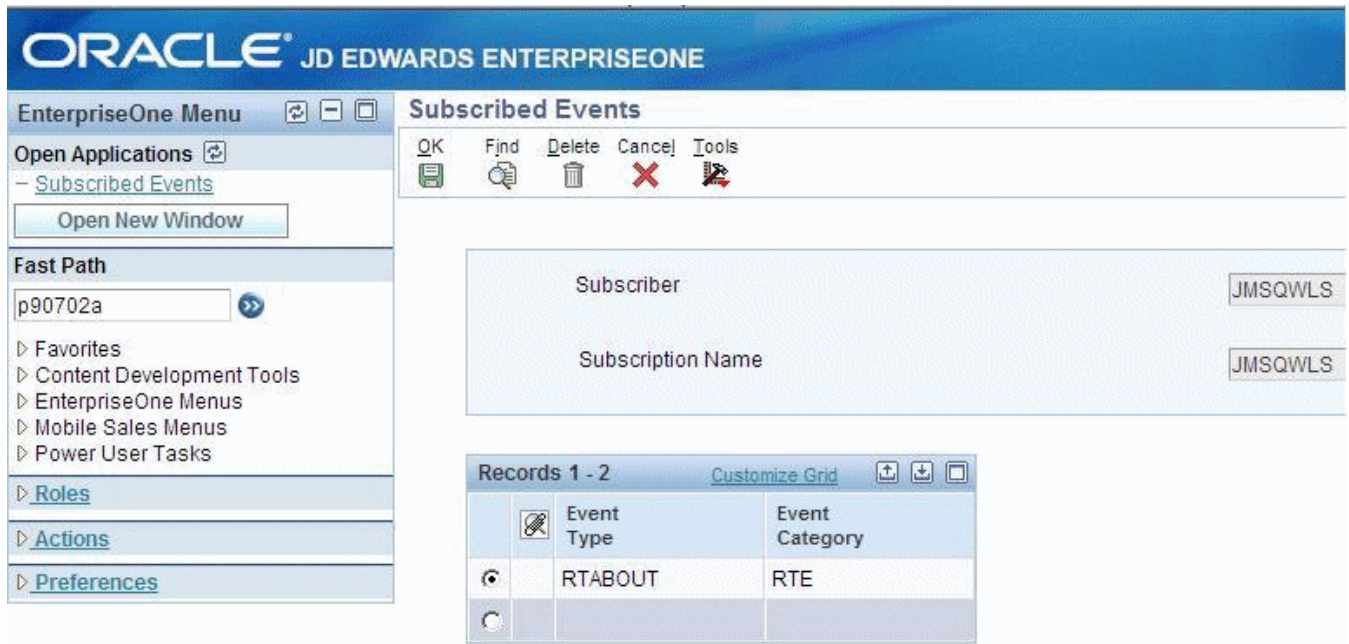

4. Click the *OK* button to add *RTABOUT* as a Subscribed Event to the Subscription.

## Adding Environment(s) to a Subscription

Use this procedure to add an Environment to a Subscription.

1. Run P90702A and find the Subscriber you created earlier in this section of the guide.

**ORACLE** JD Edwards EnterpriseOne

Home Navigator Open Applications Recent Reports Favorites

### Event Subscriptions

Form Row Tools

Subscriber

Subscription Name

**Favorites**

**Row**

- Subscribed Events
- Subscribed Env**
- Change Status

All Subscriptions  Active Subscriptions  Inactive Subscriptions

Records 1 - 1 [Customize Grid](#)

Subscription Name	Subscription Description	Activation Status
<input checked="" type="radio"/> JDE	JDE Subscriber	AV

2. On Event Subscriptions, select the *Subscribed Env* Row Exit.



3. On Subscribed Environments, click the radio buttons to add Environments as required.
4. Click the OK button to add the selected *Environments*. to the Subscription.



# 5 Troubleshooting Real Time Events Processing

This chapter discusses troubleshooting Real Time Events processing.

**Problem:** There are some events in the table F90710 which are not getting picked up by the RTE server.

**Resolution:** Check if the event sequence number stored in the table F90708 is greater than lowest event sequence number available in table F90710. In this case the event sequence number in table F90708 must be reset to 0 manually

**Problem:** Some of the clustered servers are not processing events.

**Resolution:** Probably some servers in the cluster are having some problem. Refer the app server log to identify the problem, rectify the problem and restart the cluster.

**Resolution:** There could be very high number of events processed exceeding the filestore size. It is advisable to consume events while they are being produced and processed. This keeps the filestore clean.

**Problem:** Getting error in the RTE Server on WAS (Failed to send committed event message: CWSIA0053E: An exception was received during the call to the method JmsSessionImpl.getTransaction (#1): javax.resource.spi.IllegalStateException: CWSJR1121E: An internal error has occurred. During the call to the method getManagedConnection the exception javax.resource.spi.ResourceAllocationException: CWSJR1028E: An internal error has occurred. The exception com.ibm.ws.sib.processor.exceptions.SIMPCConnectionUnavailableException)

**Resolution:** One of the messaging engines is down and unable to process event. This should not be a concern since the failover service is active and event will be processed by other available messaging engines, assuming they are available.

**Problem:** Error message "JNDI lookup of Queue failed" seen in RTE server log.

**Resolution:** It is likely that the JNDI resources are not loaded yet. This error most commonly occurs when auto migration is enabled. A retry lookup feature exists which will try to lookup until successful. If the problem persists, then check the application server log

**Problem:** All the messages are being sent to a single queue in a cluster or not evenly distributed.

**Resolution:** A failover may have occurred and the Queue configuration has been changed due to failover. Stop the clustered servers, modify the configuration as stated in this document and start the cluster to process events.



# 6 Upgrading the Transaction Server RTE Software Component Using Server Manager

Use this procedure to upgrade the Transaction Server RTE component that was installed using Server Manager.

1. Obtain the RTE software component to which you wish to upgrade from Oracle eDelivery.
2. Place the new RTE component into this folder:

<AGENT\_LOC>\components

3. Log on to the Server Manager console.
4. Click on the RTE instance.



5. In the Software Component Version section, click the **Change** button.

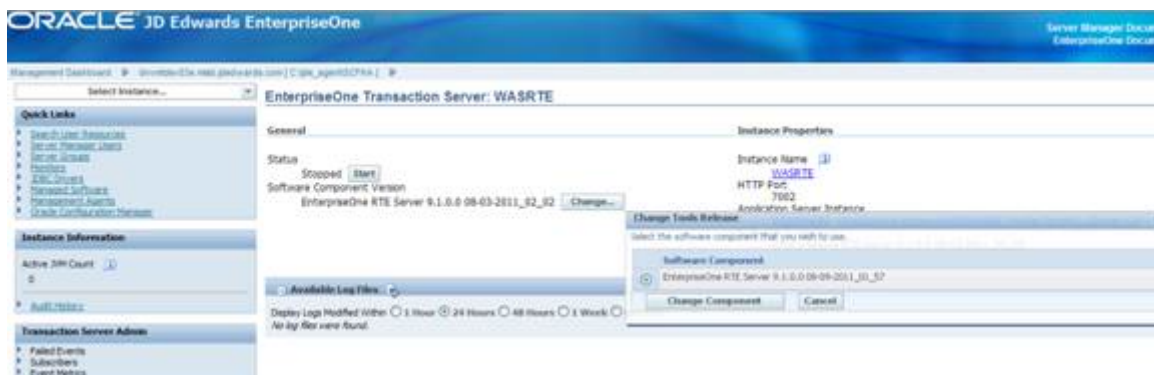

6. On the Change Tools Release layout, select the desired version to install from the component by selecting the radio button.

7. Click the **Change Component** button.

**Note:** An upgrade of RTE server only upgrades the Transaction Server RTE component of JD Edwards, and not the JMS components.

Refer to the *JD Edwards EnterpriseOne Tools Server Manager Guide* to upgrade the Server Manager Agent. You should only update the Server Manager Agent after you have upgraded the Server Manager Console to the latest release, which can be independent of a JD Edwards Tools Release.



# 7 Appendix A - Architecture of the Guaranteed Event System

This appendix presents an architectural diagram of the Guaranteed Event System, which is one of the *JD Edwards EnterpriseOne* Transaction Server Components. The diagram depicts the general sequence that occurs when an event is published. These steps correspond to the numbered sequence of events in the diagram:

1. An HTML client user executes a business function (BSFN) request.

This request is sent to the *JD Edwards EnterpriseOne HTML Server*.

2. The *HTML Server* forwards this request to a CallObject kernel on the Enterprise Server.
3. The CallObject kernel executes the BSFN, which calls the Event API to send the event data to the F90710 Event Transfer table.

If the event is a Z event, the data is sent to F90710 in a final XML format.

4. A database polling application available with the JD Edwards EnterpriseOne Transaction Server polls any available records in F90710.
5. The transaction server retrieves the event data from F90710 and (for Real-Time and XAPI events) converts the data to an XML document in the appropriate format.
6. The transaction server routes the event to the subscriber queue(s) for each subscriber that has established an active subscription for that event.
7. When a subscriber connects to the Transaction Server, the subscriber is sent all the events that exist in its subscription queue at that time.

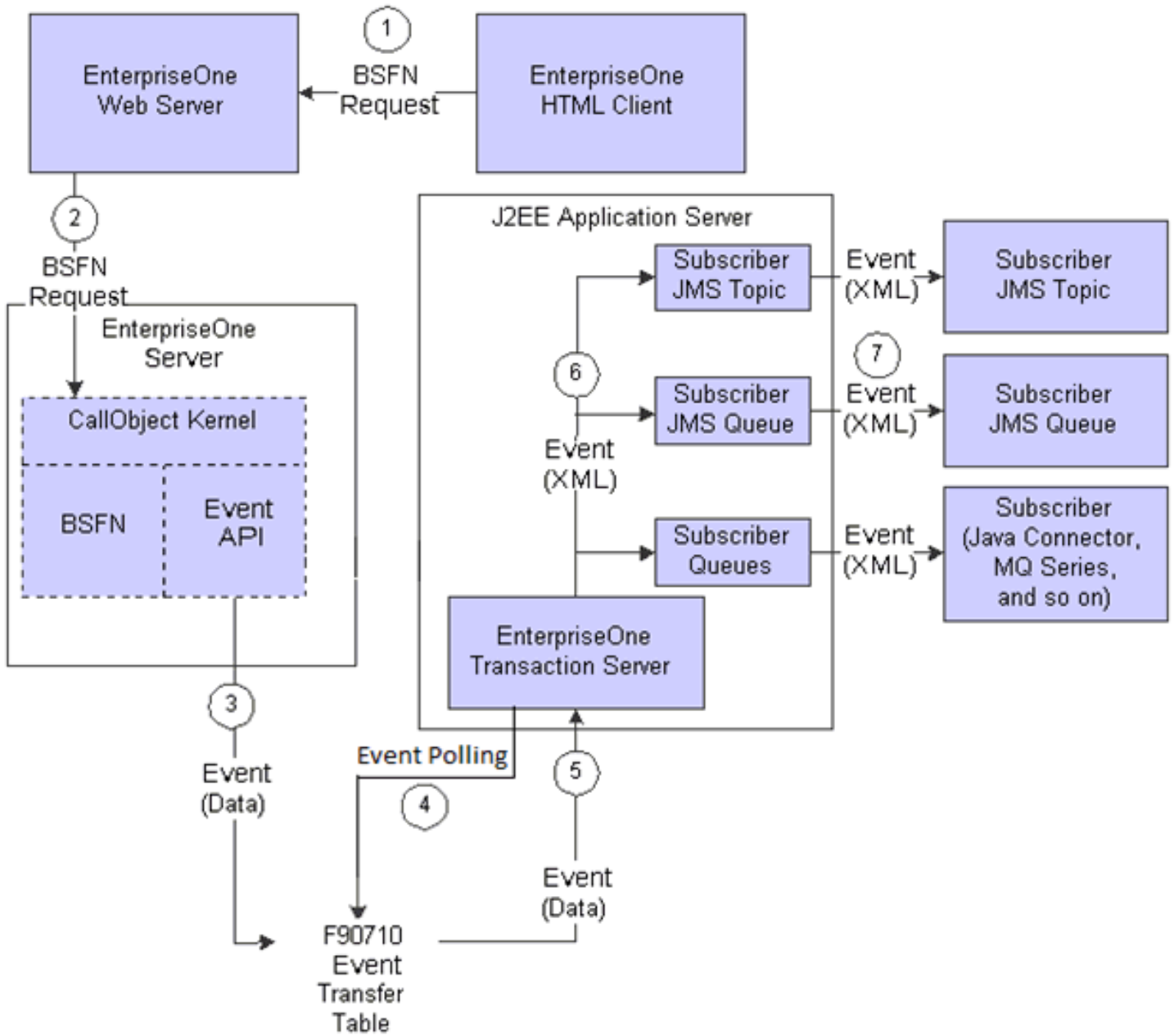

# 8 Appendix B - Creating and Configuring Multiple Transaction Servers per Environment or User/Role

The default configuration for the Transaction Server defines the F907\* tables (event tables) to reside in one datasource. These tables are included in the System datasource database (for example, SY920). Using this default configuration, only a single Transaction Server may be configured to monitor the F907\* tables.

This appendix provides instructions to set up and configure multiple Transaction Servers so that transactions can be separated by one or more of these criteria:

- Environment
- Role/User

This process allows you to:

- Separate transaction events by environment so that two different transaction servers can service the events
- Use OCM mappings to point to the different environments

This appendix describes these tasks:

- *Creating and Configuring Multiple Transaction Servers per Environment*
- *Creating and Configuring Multiple Transaction Servers per Role/User*

## Creating and Configuring Multiple Transaction Servers per Environment

These general guidelines apply:

- *Production Environments*

The F907\* tables should remain in the System database as defined by the standard setup and configuration. Since the transaction server is designed to work with only one set of F907\* tables, the normal procedure is to configure the transaction server with these system tables.

- *Test and Dev Environments*

In order to separate Test and Dev environment transactions from Production, you can copy the F907\* tables into the business data database and change the OCM mappings accordingly. A second transaction server is necessary in order to access these copied tables because, by design, each Transaction Server can only work with only one set of F907\* tables.

- *Multiple Transaction Servers*

In order to support the separation of the F907\* tables per environment, you must install an additional Transaction Server per environment or environment combination. For example, if you want to isolate your

Production environment and then combine your Test and Dev environments, you would need a total of two Transaction Servers. If you further wanted to separate your Test and Dev environments, you would need a total of three Transaction Servers.

Do not start any added Transaction Servers until you complete the procedure in this appendix.

To create and configure the Transaction Server per environment:

1. With the exception of the tables listed in the *Exceptions* below, copy all remaining F907\* tables from the System database to the business data database.

#### *Exceptions*

The following tables are initially cached on JD Edwards EnterpriseOne service startup and contain the necessary information needed for all environments and subscribers. Therefore, these tables and their OCM mappings should remain in the System datasource:

- o F90701
- o F907011
- o F90705

2. Use OCM to remap the F907\* tables copied in Step 1 to the new business data database for both the system and the server map.

For example, the completed mappings might look like these:

```
JPY920 F90701  TBLE  System - 920 *PUBLIC AV
JPY920 F907011 TBLE  System - 920 *PUBLIC AV
JPY920 F907012 TBLE  System - 920 *PUBLIC AV
JPY920 F90703  TBLE  Business Data - CRP *PUBLIC AV
JPY920 F90704  TBLE  Business Data - CRP *PUBLIC AV
JPY920 F90705  TBLE  System - 920 *PUBLIC AV
JPY920 F90706  TBLE  Business Data - CRP *PUBLIC AV
JPY920 F90707  TBLE  Business Data - CRP *PUBLIC AV
JPY920 F907071 TBLE  Business Data - CRP *PUBLIC AV
JPY920 F907072 TBLE  Business Data - CRP *PUBLIC AV
JPY920 F90708  TBLE  Business Data - CRP *PUBLIC AV
JPY920 F90710  TBLE  Business Data - CRP *PUBLIC AV
JPY920 F90711  TBLE  Business Data - CRP *PUBLIC AV
JPY920 F90712  TBLE  Business Data - CRP *PUBLIC AV
JPY920 F90715  TBLE  Business Data - CRP *PUBLIC AV
JPY920 F90720  TBLE  Business Data - CRP *PUBLIC AV
JPY920 F90730  TBLE  Business Data - CRP *PUBLIC AV
```

3. Activate the RT\* event for added environment (for example, JPY920) in P90701 by:
  - o Taking the Form exit to Event Activation
  - o Doing an Add to add the new Event per environment
  - o Using the Row exit to change the status to Active
4. Refresh the JD Edwards EnterpriseOne server cache by restarting the EnterpriseOne services.
5. Add subscriber information for the added environment (for example, JPY920).
6. Refresh the Transaction Server cache by restarting the transaction server.
7. Trigger the event.
8. Verify the event is recorded in the F90710 Business Data Source table.
9. From a JD Edwards EnterpriseOne client machine, use this command to run the Table Trigger script for F90710 in the business data for the added environment (for example, PY Business Data):

```
<home>\system\bin32\dbtemplates.exe -create
```

where <home> is the installation directory of the JD Edwards EnterpriseOne Administration client that is named according to the JD Edwards EnterpriseOne release. For example, E812, E900, E910, or E920.

10. Verify the F986112 table is populated and the new event in F90710 has the status 3 instead of 2.

## Creating and Configuring Multiple Transaction Servers per Role/ User

This section describes a configuration where multiple Real Time Events can be processed by multiple Transaction Server instances within the same JD Edwards EnterpriseOne environment. You can process events by Role/User to enable specific users to have their events processed by a specific Transaction Server. This setup is similar to that in the previous section, *Creating and Configuring Multiple Transaction Servers per Environment*. Instead of separating the events by environment you are separating the Real Time Event messages by Role/User.

### Multiple Transaction Servers

In order to support the separation of the F907\* tables per Role/User, you must install an additional Transaction Server per User or Role combination. For example, you have set up a role for processing Sales Orders and another role for processing all other Real Time Events. In this case, you would need an additional Transaction Server for each role addition.

To configure the system to route Real Time Events to specific Transaction Servers based on the JD Edwards EnterpriseOne Role/User user that is generating the event:

1. From JD Edwards EnterpriseOne, create a new Role which will include a group of users that will initiate the Real Time Event messages.
2. Create these tables in the same environment datasource (Business Data - PROD) or create a custom Data Source (for example, TS2 / PD920):
  - o F90710 - Event table
  - o F90730 - Unique sequence table
3. Copy these tables from the System datasource to the same environment datasource you used in Step 2:
  - o F90706 - Event Subscriber
  - o F90707 - Event Subscription
  - o F907071 - Subscribed Events
  - o F907072 - Subscribed Environments
  - o F90708 - Event Sequence

These tables contain the subscriber information and whether they are active or not. It is important to note that when you copy these tables, whenever you want to make changes to the subscriber information you must ensure you are logged in as the appropriate user. This is required to ensure you are making changes to the correct table. If you do not copy these tables, you will continue to see errors in the Transaction Server log where events cannot be delivered to all the subscribers, although this does not affect the delivery of the events to the correct queue.

4. Create new OCM mappings for all the tables listed in Steps 2 and 3 for the new Role (for example, role associated with the PD920 environment and the copied F90710 table and the role associated with the PD920

environment and the F90730 table) to point to Business Data - PROD. You must make mappings for both SYSTEM and Server Map.

5. On a JD Edwards EnterpriseOne client machine, run the program to create the table trigger on the new F90710 table. From a command prompt, navigate to this directory:

```
e920\system\bin32\
```

6. From the above directory, run this command:

```
dbtemplates.exe -create
```

When prompted ensure you log in as the new user (assigned to your new role) so that the program uses the new OCM mappings to locate the correct table in which to create the new trigger.

Henceforth when logging in as a user defined by this role, a generated Real Time Event sends the message into the appropriate F90710 table and updates the F90730 table.

7. Install a new Transaction server that will be used to process the events for each new Role/User.
8. Configure the newly installed Transaction Server with one of the users in the new Role as the bootstrap user.
9. Process a transaction that triggers an event for the new Role.
10. Start the newly installed Transaction Server and check the queue to make sure the event was delivered to the new Transaction Server.
11. Verify the previous configuration still functions as expected by logging in as any user *not* belonging to the new Role and generate an Event and see that the message goes into the F90710 (System - 920) and is delivered to the original Transaction Server.

# 9 Appendix C - Working with JMS Topic or JMS Queue

Based on your desired subscription model, you must choose to implement either JMS Topic or JMS Queue. You should examine these use case descriptions described in this appendix to determine whether you should use JMSTOPIC or JMSQUEUE subscription in your implementation of the Transaction Server:

- *Use Case for JMS Topic*
- *Use Case for JMS Queue*

## Use Case for JMS Topic

The use case for JMS Topic includes these considerations:

- A distribution mechanism for publishing messages that are delivered to multiple subscribers.
- Multiple consumers require delivery of the message.
- There is a timing dependency between publishers and subscribers. The publisher must create a subscription in order for clients to be able to subscribe. The subscriber must remain continuously active to receive messages, unless it has established a durable subscription. In that case, messages published while the subscriber is not connected will be redistributed whenever it reconnects.

## Use Case for JMS Queue

The use case for JMS Queue includes these considerations:

- A staging area that contains messages that have been sent and are waiting to be read. As the name queue suggests, the messages are delivered in the order sent. A message is removed from the queue once it has been read.
- Point-to-point solution based on Publisher/ Subscriber model.
- Only one consumer will get the message.
- The producer does not have to be running at the time the consumer consumes the message, nor does the consumer need to be running at the time the message is sent,
- Every message successfully processed is acknowledged by the consumer.





# 10 Appendix D - Testing and Validating the JMSQUEUE Configuration

If you have followed the steps to activate RTABOUT, a Real Time Event will be created whenever you Add, Change, or Delete an Address Book record. However, before performing any of those functions you should follow the procedure outlined in the following documents found in My Oracle Support. Access the document according to your Tools Release.

- E1: OUTBND: RTE Server (Transaction Server) Setup and Configuration for WebLogic - JMSQueue Subscriber (Doc ID 1137704.1)



# 11 Appendix E - Creating a JMS Topic in the JD Edwards EnterpriseOne Transaction Server Application

To create a JMS Topic in the Transaction Server Application:

1. Log on to the WebLogic Admin Console.
2. To create a JMS Topic for your JD Edwards EnterpriseOne, navigate to Home Page > Services > Messaging > JMS Modules, select your *JMS Module* and click the *New* button.
3. On Create a New JMS System Module Resource, select the radio button for *Topic*.

The process for creating the Connection Factory for this topic is the same as the JMS Connection Factory created for the queue. Ensure you use the same values as the ones used when setting up your JMSTOPIC Subscriber in P90702A.



# 12 Appendix F - Creating a Subscriber JMS Queue in WebLogic Server other than Transaction Server

Although it is supported it is not recommended that you create the subscriber queue in the Transaction Server container. This section describes the recommendation, which is to create the a subscriber JMS queue on a WebLogic Server other than the Transaction Server.

This appendix describes these tasks:

- *Creating the JMS Server*
- *Creating the JMS Module*
- *Creating the JMS Resource*

## Creating the JMS Server

To create the JMS Server:

1. From the WebLogic Administration Console, select the domain in which you want to create the JMS Server.
2. Click on *YourDomain* > Services > Messaging > JMS Servers

3. In the right panel click the **New** button.

**Create a New JMS Server**

Back | Next | Finish | Cancel

**JMS Server Properties**

The following properties will be used to identify your new JMS Server.

\* Indicates required fields

What would you like to name your new JMS Server?

 \* **Name:**

Specify persistent store for the new JMS Server.

**Persistent Store:**

Back | Next | Finish | Cancel

4. On Create a New JMS Server, enter a value for the name of the JMS server to be created. In this guide, the name is **Test-JMSServer**.
5. Use the pulldown to select the Persistence Store.

**Note:** If Persistence Store does not exist you must create a new Persistence Store by clicking the **Create a New Store** button.

6. Click the **Next** button.

**Create a New JMS Server**

Back | Next | Finish | Cancel

**Select targets**

Select the server instance or migratable target on which you would like to deploy this JMS Server.

Target: AdminServer

Back | Next | Finish | Cancel

7. On Create a New JMS Server, select the Weblogic server node and click the **Finish** button.

As shown below, at this point using the example in this guide a JMS server called **Test-JMSServer** is created. This **Test-JMSServer** is targeted to **AdminServer**. However this can be targeted to any other container available, which may not necessarily be AdminServer

Summary of JMS Servers

JMS servers act as management containers for the queues and topics in JMS modules that are targeted to them.  
This page summarizes the JMS servers that have been created in the current WebLogic Server domain.

[Customize this table](#)

JMS Servers (Filtered - More Columns Exist)

<input type="checkbox"/>	Name ↕	Persistent Store	Target	Current Target	Health
<input type="checkbox"/>	Test-JMSServer	Test-FileStore	AdminServer	AdminServer	OK

New Delete Showing 1 to 1 of 1 Previous | Next

## Creating the JMS Module

To create a subscriber queue on WebLogic Server:

1. In the WebLogic Administration Console, select the domain into which you want to create the JMS Module.
2. Click on *YourDomain* > Services > Messaging > JMS Modules

3. In the right panel click the **New** button.

- 4. On Create JMS System Module, enter a value for the name of the JMS module to be created. In this guide, the name is **Test-SystemModule**.
- 5. Click the **Next** button.

6. On Create JMS System Module, select the target of Weblogic server node.



7. Click the **Finish** button.

As shown below at this point, using the example in this guide, the **Test-SystemModule** is created. This **Test-SystemModule** is targeted to AdminServer. However this can be targeted to any other container .

Summary of JMS Modules

JMS system resources are configured and stored as modules similar to standard J2EE modules. Such resources include queues, topics, connection factories, templates, destination keys, quota, distributed queues, distributed topics, foreign servers, and JMS store-and-forward (SAF) parameters. You can administratively configure and manage JMS system modules as global system resources.

This page summarizes the JMS system modules that have been created for this domain.

[Customize this table](#)

**JMS Modules**

New Delete Showing 1 to 1 of 1 Previous | Next

<input type="checkbox"/>	Name ↕	Type
<input type="checkbox"/>	Test-SystemModule	System

New Delete Showing 1 to 1 of 1 Previous | Next

## Creating the JMS Resource

Use this procedure to create a JMS resource such as connection factory, queue, or topic in the JMS Module you created in the previous section.

To create a JMS Resource:

1. Click the JMS Module where you want to create a resource (in this guide **Test-SystemModule**).

Settings for Test-SystemModule

Configuration Subdeployments Targets Security Notes

This page displays general information about a JMS system module and its resources. It also allows you to configure new resources and access existing resources.

**Name:** Test-SystemModule The name of this JMS system module. [More Info...](#)

**Descriptor File Name:** jms/test-systemmodule-jms.xml The name of the JMS module descriptor file. [More Info...](#)

This page summarizes the JMS resources that have been created for this JMS system module, including queue and topic destinations, connection factories, JMS templates, destination sort keys, destination quota, distributed destinations, foreign servers, and store-and-forward parameters.

[Customize this table](#)

**Summary of Resources**

New Delete Showing 0 to 0 of 0 Previous | Next

<input type="checkbox"/>	Name ↕	Type	JNDI Name	Subdeployment	Targets
There are no items to display					

New Delete Showing 0 to 0 of 0 Previous | Next

2. On Settings for <Module\_Name> , click the **New** Button.

Create a New JMS System Module Resource

[Back](#) [Next](#) [Finish](#) [Cancel](#)

**Choose the type of resource you want to create.**

Use these pages to create resources in a JMS system module, such as queues, topics, templates, and connection factories.

Depending on the type of resource you select, you are prompted to enter basic information for creating the resource. For targetable resources, like stand-alone queues and topics, connection factories, distributed queues and topics, foreign servers, and JMS SAF destinations, you can also proceed to targeting pages for selecting appropriate server targets. You can also associate targetable resources with subdeployments, which is an advanced mechanism for grouping JMS module resources and the members to server resources.

<input checked="" type="radio"/> <b>Connection Factory</b>	Defines a set of connection configuration parameters that are used to create connections for JMS clients. <a href="#">More Info...</a>
<input type="radio"/> <b>Queue</b>	Defines a point-to-point destination type, which are used for asynchronous peer communications. A message delivered to a queue is distributed to only one consumer. <a href="#">More Info...</a>
<input type="radio"/> <b>Topic</b>	Defines a publish/subscribe destination type, which are used for asynchronous peer communications. A message delivered to a topic is distributed to all topic consumers. <a href="#">More Info...</a>
<input type="radio"/> <b>Distributed Queue</b>	Defines a set of queues that are distributed on multiple JMS servers, but which are accessible as a single, logical queue to JMS clients. <a href="#">More Info...</a>
<input type="radio"/> <b>Distributed Topic</b>	Defines a set of topics that are distributed on multiple JMS servers, but which are accessible as a single, logical topic to JMS clients. <a href="#">More Info...</a>

- On Create a New JMS System Module Resource, select the radio button for the resource type to be created. In this example, **Connection Factory** is selected.

**Create a New JMS System Module Resource**

Back
Next
Finish
Cancel

**Connection Factory Properties**

The following properties will be used to identify your new connection factory. The current module is Test-SystemModule.

\* Indicates required fields

What would you like to name your new connection factory?

\* Name:

---

What JNDI Name would you like to use to look up your new connection factory?

JNDI Name:

---

The Connection Factory Subscription Sharing Policy Subscribers can be used to control which subscribers can access new subscriptions. Should subscriptions created using this factory be sharable?

Subscription Sharing Policy:

---

The Client ID Policy indicates whether more than one JMS connection can use the same Client ID. Oracle recommends setting the Client ID policy to Unrestricted if sharing durable subscribers. Subscriptions created with different Client ID policies are always treated as independent subscriptions. What Client ID Policy would you like to use?

Client ID Policy:

---

A connection factory can limit the number of messages that can be queued for an asynchronous session. Should this connection factory impose a limit?

Maximum Messages per Session:

---

Should this connection factory create sessions that are JTA aware, and create XA queues and XA topics?

XA Connection Factory Enabled

Back
Next
Finish
Cancel

- On Create a New JMS System Module Resource, enter Connection Factory name and JNDI name for this Connection Factory.

5. Click the **Next** button.

The screenshot shows a web-based dialog box titled "Create a New JMS System Module Resource". At the top, there are four buttons: "Back", "Next", "Finish", and "Cancel". Below the title bar, a section titled "The following properties will be used to target your new JMS system module resource" contains a paragraph of explanatory text. Underneath, a line of text says "Select the subdeployment you want to use. If you select (none), no targeting will occur." This is followed by a "Subdeployments:" label, a dropdown menu currently set to "(none)", and a "Create a New Subdeployment" button. Below this, another line of text asks "What targets do you want to assign to this subdeployment?". A "Targets:" label is present, but no targets are listed. At the bottom of the dialog, there are four buttons: "Back", "Next", "Finish", and "Cancel".

6. On Create a New JMS System Module Resource, use the pulldown to select the Subdeployment. If no existing Subdeployment can be used click on **Create a New Subdeployment** button.

The screenshot shows a web-based dialog box titled "Create a New Subdeployment". At the top, there are two buttons: "OK" and "Cancel". Below the title bar, a section titled "Subdeployment Properties" contains a paragraph of explanatory text. Underneath, a "Subdeployment Name:" label is followed by a text input field containing the text "Test-Subdeployment". At the bottom of the dialog, there are two buttons: "OK" and "Cancel".

7. On Create a New Subdeployment, enter a name for a new Subdeployment.

8. Click the **OK** button.

**Create a New JMS System Module Resource**

Back Next Finish Cancel

The following properties will be used to target your new JMS system module resource

Use this page to select a subdeployment to assign this system module resource. A subdeployment is a mechanism by which JMS resources are grouped and targeted to a server instance, cluster, or SAF agent. If necessary, you can create a new subdeployment by clicking the **Create a New Subdeployment** button. You can also reconfigure subdeployment targets later by using the parent module's subdeployment management page.

Select the subdeployment you want to use. If you select (none), no targeting will occur.

**Subdeployments:** Test-Subdeployment Create a New Subdeployment

What targets do you want to assign to this subdeployment?

**Targets :**

<b>Servers</b>
<input type="checkbox"/> AdminServer

<b>JMS Servers</b>
<input checked="" type="checkbox"/> Test-JMServer

Back Next Finish Cancel

9. On Create a New JMS System Module Resource, click the checkbox next to the JMS Server for which you just created a resource.
10. Click the **Next** button.

**Create a New JMS System Module Resource**

Back Next Finish Cancel

**Choose the type of resource you want to create.**

Use these pages to create resources in a JMS system module, such as queues, topics, templates, and connection factories.

Depending on the type of resource you select, you are prompted to enter basic information for creating the resource. For targetable resources, like stand-alone queues and topics, connection factories, distributed queues and topics, foreign servers, and JMS SAF destinations, you can also proceed to targeting pages for selecting appropriate server targets. You can also associate targetable resources with subdeployments, which is an advanced mechanism for grouping JMS module resources and the members to server resources.

<input type="radio"/> <b>Connection Factory</b>	Defines a set of connection configuration parameters that are used to create connections for JMS clients. <a href="#">More Info...</a>
<input checked="" type="radio"/> <b>Queue</b>	Defines a point-to-point destination type, which are used for asynchronous peer communications. A message delivered to a queue is distributed to only one consumer. <a href="#">More Info...</a>
<input type="radio"/> <b>Topic</b>	Defines a publish/subscribe destination type, which are used for asynchronous peer communications. A message delivered to a topic is distributed to all topic consumers. <a href="#">More Info...</a>
<input type="radio"/> <b>Distributed Queue</b>	Defines a set of queues that are distributed on multiple JMS servers, but which are accessible as a single, logical queue to JMS clients. <a href="#">More Info...</a>
<input type="radio"/> <b>Distributed Topic</b>	Defines a set of topics that are distributed on multiple JMS servers, but which are accessible as a single, logical topic to JMS clients. <a href="#">More Info...</a>

11. On Create a New JMS System Module Resource, click the radio button for **Queue**.
12. Click the Next button.

Create a New JMS System Module Resource

Back Next Finish Cancel

**JMS Destination Properties**

The following properties will be used to identify your new Queue. The current module is Test-SystemModule.

\* Indicates required fields

\* Name:

JNDI Name:

Template:

Back Next Finish Cancel

13. On Create a New JMS System Module Resource, enter a *Name* and *JNDI Name* for this Queue.

14. Click the **Next** button.

Create a New JMS System Module Resource

Back Next Finish Cancel

**The following properties will be used to target your new JMS system module resource**

Use this page to select a subdeployment to assign this system module resource. A subdeployment is a mechanism by which JMS resources are grouped and targeted to a server instance, cluster, or SAF agent. If necessary, you can create a new subdeployment by clicking the **Create a New Subdeployment** button. You can also reconfigure subdeployment targets later by using the parent module's subdeployment management page.

Select the subdeployment you want to use. If you select (none), no targeting will occur.

Subdeployments:  [Create a New Subdeployment](#)

What targets do you want to assign to this subdeployment?

Targets :

JMS Servers
<input checked="" type="checkbox"/> Test-JMS Server

Back Next Finish Cancel

15. On Create a New JMS System Module Resource, select the Subdeployment.

16. Click the **Finish** button.

17. As shown below, verify that both the xxxx

Settings for Test-SystemModule

Configuration Subdeployments Targets Security Notes

This page displays general information about a JMS system module and its resources. It also allows you to configure new resources and access existing resources.

**Name:** Test-SystemModule The name of this JMS system module. [More Info...](#)

**Descriptor File Name:** jms/test-systemmodule-jms.xml The name of the JMS module descriptor file. [More Info...](#)

This page summarizes the JMS resources that have been created for this JMS system module, including queue and topic destinations, connection factories, JMS templates, destination sort keys, destination quotas, distributed destinations, foreign servers, and store-and-forward parameters.

[Customize this table](#)

**Summary of Resources**

[New](#) [Delete](#) Showing 1 to 2 of 2 [Previous](#) | [Next](#)

<input type="checkbox"/>	Name	Type	JNDI Name	Subdeployment	Targets
<input type="checkbox"/>	TestConnectionFactory	Connection Factory	.jms/TestConnectionFactory	Test-Subdeployment	Test-JMServer
<input type="checkbox"/>	TestQueue	Queue	.jms/TestQueue	Test-Subdeployment	Test-JMServer

[New](#) [Delete](#) Showing 1 to 2 of 2 [Previous](#) | [Next](#)





# 13 Appendix G - Creating an Oracle JD Edwards EnterpriseOne Service Request for Transaction Server Support

To minimize the resolution time for any Service Requests you might have to create with Global Support, it is recommended that you provide this information:

- JD Edwards EnterpriseOne Enterprise Server JDE.INI file
- Exact JD Edwards EnterpriseOne Tools Release on which you are running (for example, 9.2.1.1)
- Indicate that you are running Transaction Server on Oracle WebLogic Server and the exact release and version your application server.
- The content of the `config` folder within the Transaction Server Agent where the Transaction Server instance resides

- Logs from Server Manager generated when starting the Transaction Server

**Tip:** To obtain a more detailed set of logs, you can use Server Manager to enable enhanced logging. For the *Log Name* with a value *RTE*, change the *Log Components* value to *EVENTPROCESSOR* as shown below.

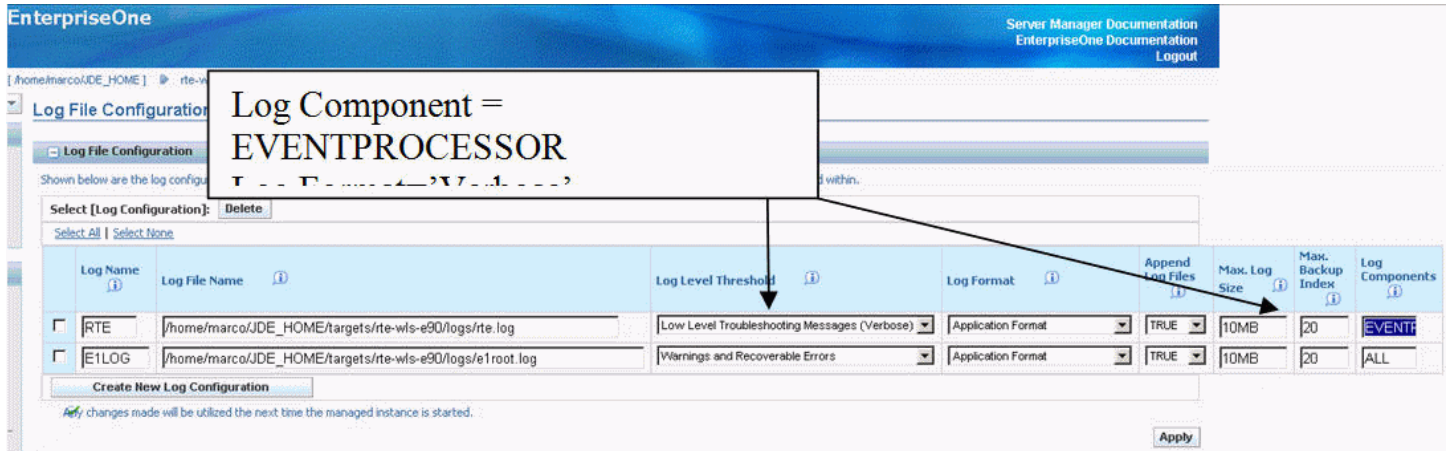

- Once the additional `jdelog.properties` definition is added as described in the preceding step, stop the Transaction Server, clear the RTE logs and produce the logs generated after going through the steps outlined in *Testing and Validating the JMSQUEUE Configuration*.
- Description of the results obtained when running the test described in *Testing and Validating the JMSQUEUE Configuration*

Specifically, you should be able to provide the status of the F90710 record after the RTE is started.

# 14 Appendix H - Clustering for the JD Edwards Transaction Server on WebLogic Server

## Understanding WebLogic Clustering

Clustering permits the deployment of application components and services to several machines with a single face to the client. When a client requests a service, it should make no difference if the service runs on a single server or across a number of servers. The clustering abstraction provides you with a clear route to improving the performance and scalability of the applications with increased administration of hardware and network resources. WebLogic clustering provides these benefits:

- Scalability  
A clustered solution allows you to create additional capacity by introducing more servers to the cluster, thereby reducing the load on existing servers. For the JD Edwards EnterpriseOne Transaction Server with the Real Time (RTE) Application, you can add as many servers and messaging engines as you like to meet the performance requirement. The RTE application on WebLogic achieves scalability with the implementation of a messaging engine policy.
- Load balancing  
The ability to distribute requests across all members of the cluster, according to the workload on each server. WebLogic handles load balancing as defined by the Load Balancing Algorithm that you configure on cluster setup. The Transaction Server with RTE on WebLogic only supports round-robin load balancing policy for the RTE application.
- High availability  
A mix of features that ensure applications and services are available even if a server or machine fails. Clients can continue to work with little or no disruption in a highly available environment. RTE on WebLogic achieves high availability with the implementation of a messaging engine policy.

## Creating a Cluster on WebLogic Server

For advanced configuration of the Oracle WebLogic Server refer to this link:

[http://download.oracle.com/docs/cd/E15523\\_01/web.1111/e13709/setup.htm](http://download.oracle.com/docs/cd/E15523_01/web.1111/e13709/setup.htm)

The section discusses these topics:

- Creating the Servers
- Creating Machines
- Associate Machines with Servers
- Cluster the Servers
- Setup the Cluster for Load Balancing

- Setup the Cluster for Failover

## Creating the Servers

The screenshot shows the Oracle WebLogic Server Administration Console. On the left, the 'Change Center' sidebar has a 'Lock & Edit' button highlighted with a mouse cursor. Below it is the 'Domain Structure' tree showing a hierarchy of nodes like Environment, Servers, Clusters, Virtual Hosts, etc. The main content area is titled 'Summary of Servers' and contains a table with the following data:

Name	Cluster	Machine	Status	Health	Listen Port
AdminServer(admin)			RUNNING	OK	7001

1. On Summary of Servers, click the **Lock and Edit** button at the bottom of the page.

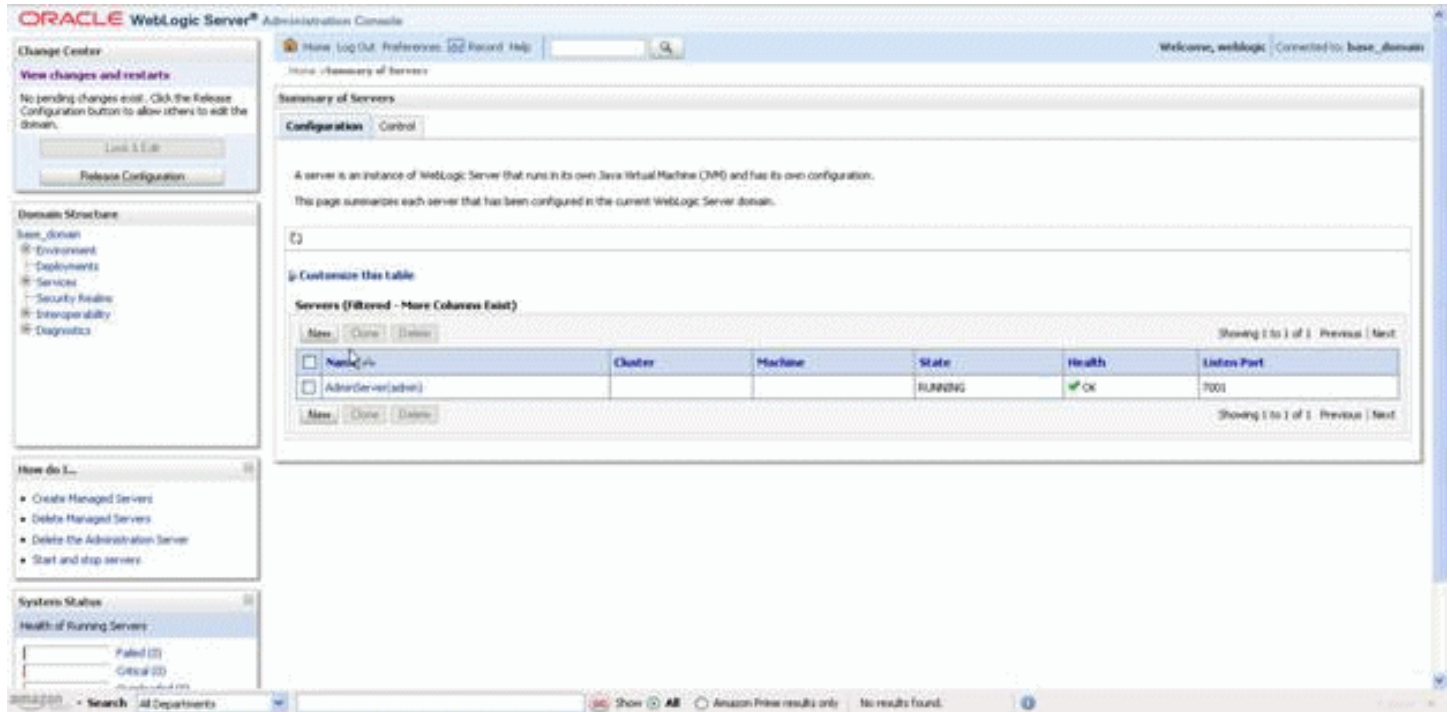

2. On Summary of Servers, click the **New** Button.

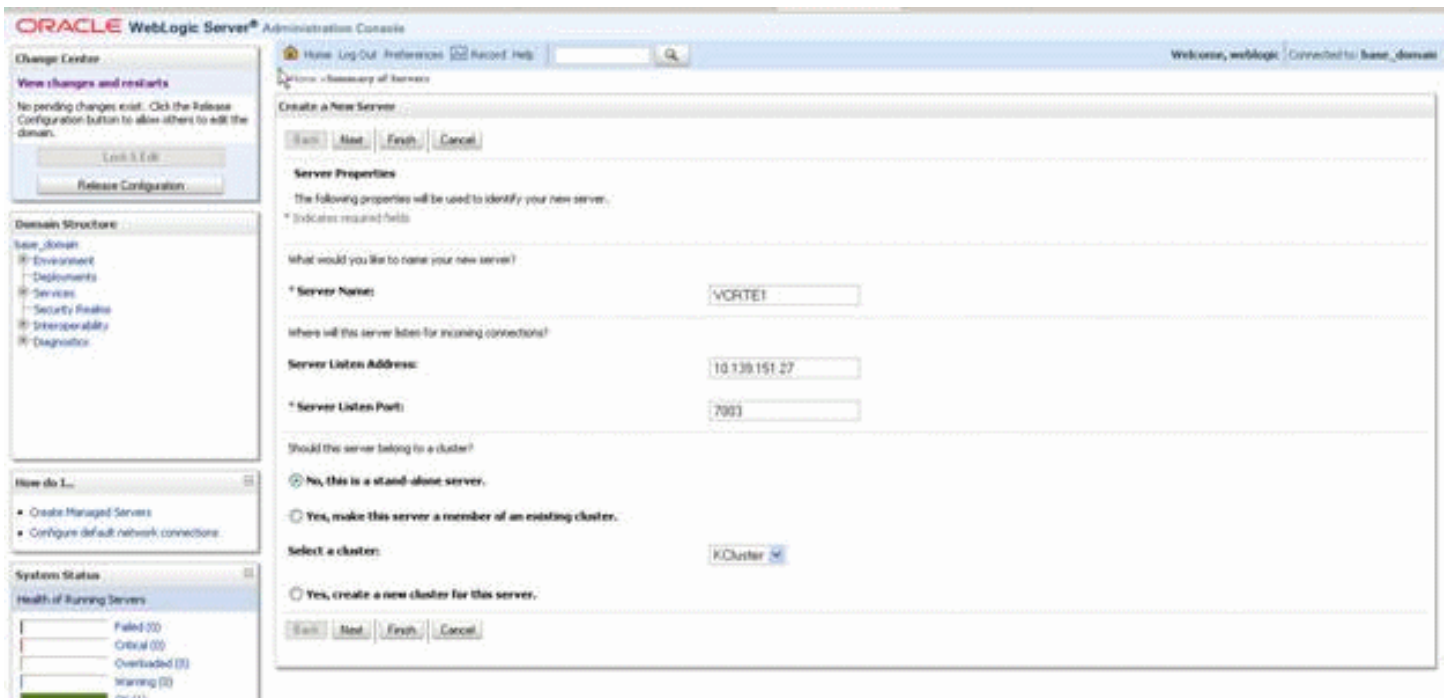

3. On Create a New Server, complete these fields:

- o *Server Name*

Enter the name of the new server.

- o *Server Listen Address*

Enter the IP address of the physical machine on which this instance will run.

**Note:** If you want to setup a horizontal Cluster, you should create a server with the remote Server Listen Address.

- o *Server Listen Port*

Enter a valid unused port on which this server will listen.

**Note:** If you want to setup a horizontal Cluster, you should create a server with a Remote Server Listen Port.

4. On Create a New Server, with the entered values accepted, click the Finish button.

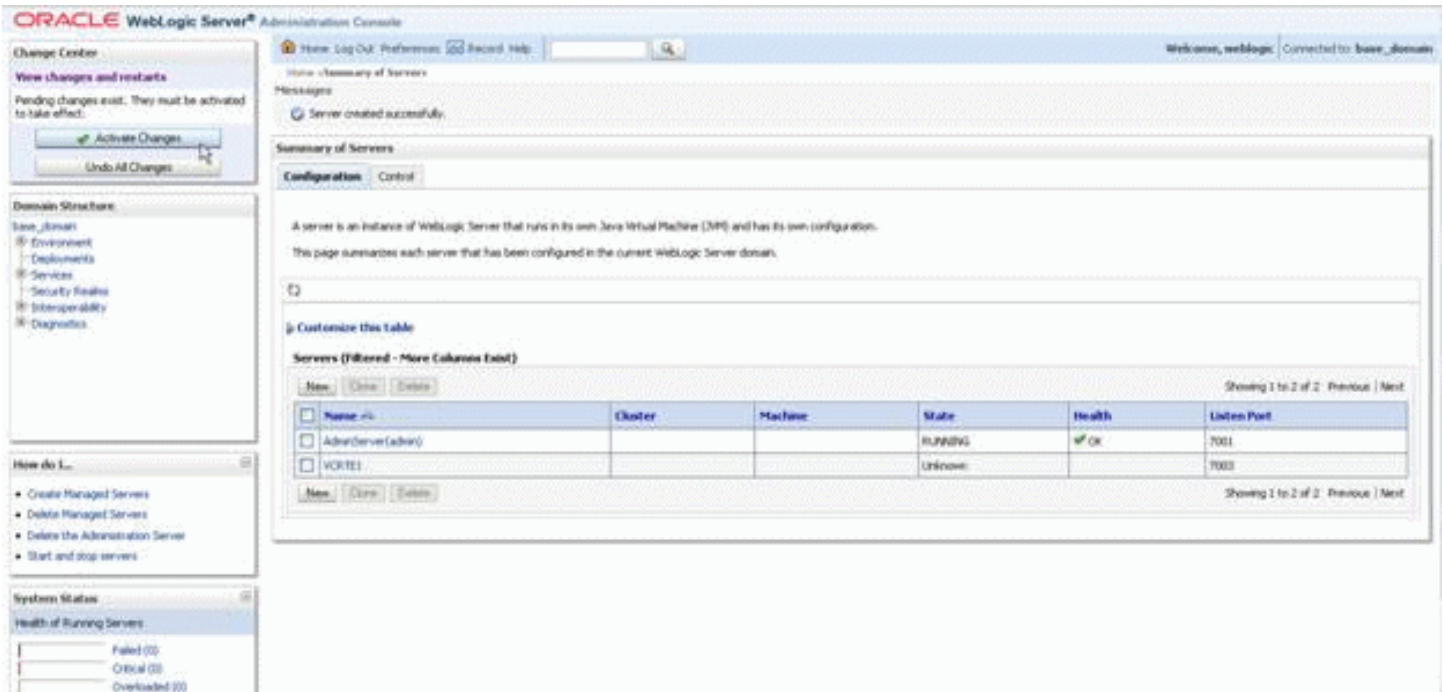

5. On Create a New Server, click the **Activate Changes** button at the bottom of the screen.
6. Repeat the steps this procedure for any additional servers you want to make part of the cluster.



- 7. If you want to setup a horizontal Cluster, you should create a server with the remote Server listen Address and Remote Server Listen Port.

When you complete this procedure, your list of server will be similar to this:

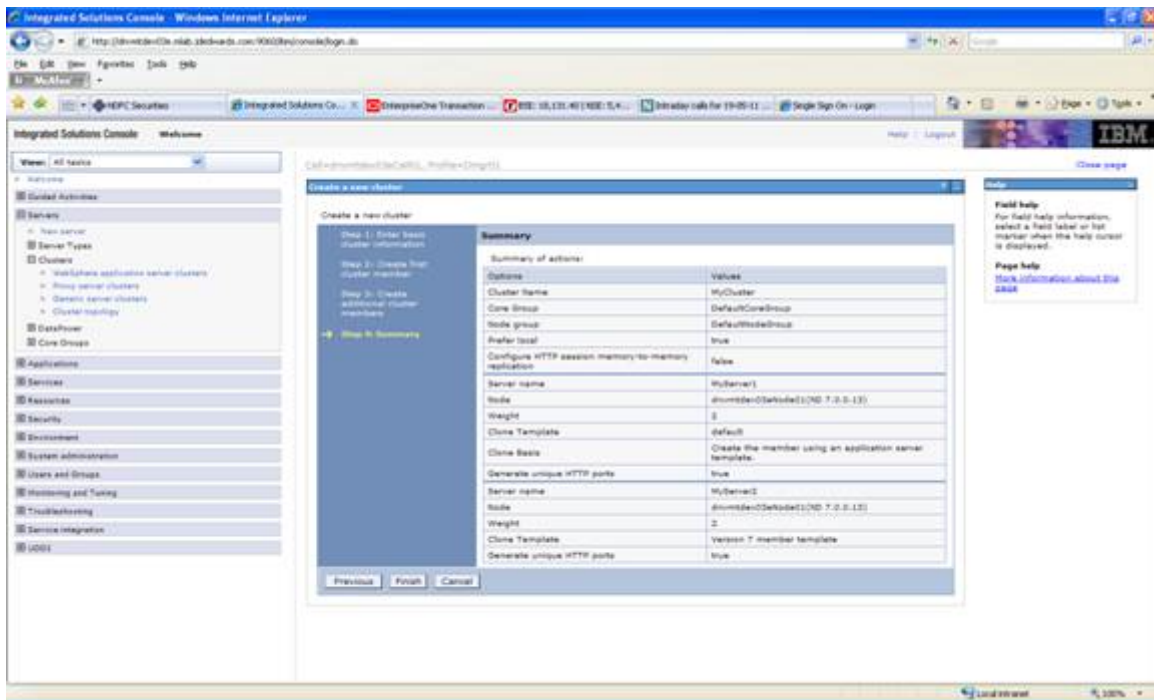

# Creating Machines

Use this procedure to create the machines:

1. Click Environment > Machines > Lock & Edit.

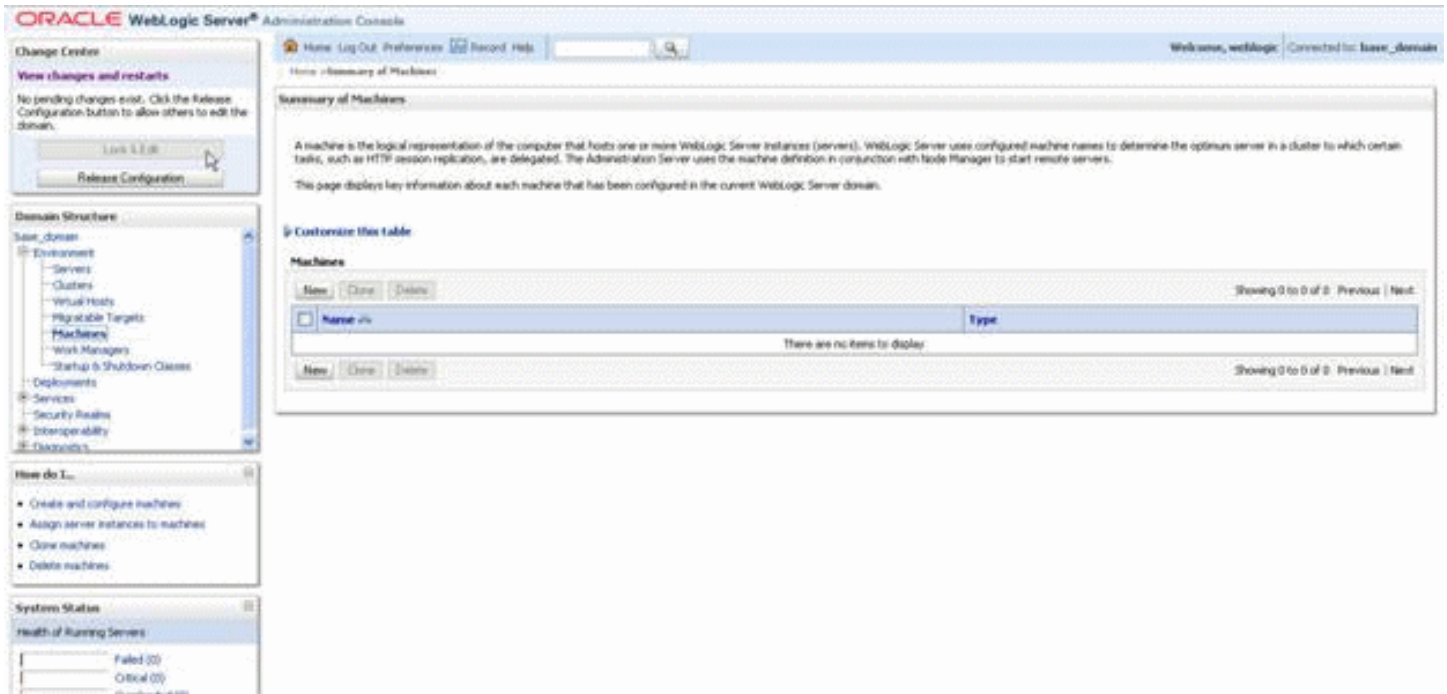

2. On Summary of Machines, click the New button.

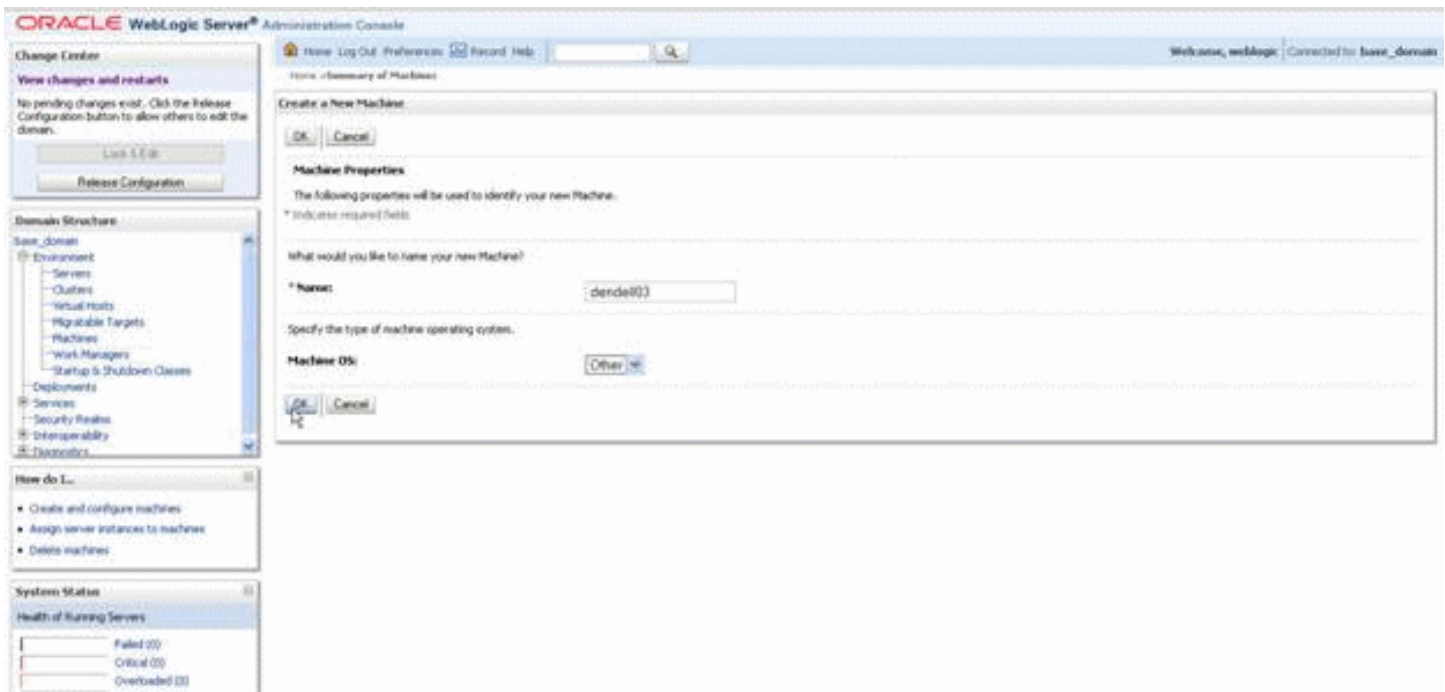

3. On Create a New Machine, complete these fields:

- o Name

Enter the machine name of the host for this clustered server.

- o Machine OS

Use the pulldown to select the operating system. Choose Other for all non-UNIX operating systems.

4. On Create a New Machine, click the OK button.
5. Click Activate Changes.

6. Repeat the steps in this procedure if your cluster spans multiple machines or if multiple server instances will run on individual machines in the cluster.

When you complete this procedure, your list of server will be similar to this:

ORACLE JD Edwards EnterpriseOne

Management Dashboard | JD Edwards EnterpriseOne | C:\jvms\agent\EGT\HA

### Create/Register A Managed Instance

Shown below are all the instance properties that are required to create/register a new instance of the selected type. Complete the required fields and select "Continue" to proceed to the next step. The instance name must be unique within the management domain and may only contain characters [a-zA-Z\_0-9]; spaces or other special characters are not permitted.

Instance Type: Instance Properties (selected) | Confirmation | Finish

Server Group: default

Instance Name: MyRTE

JDE Server (Cluster): WebSphere Instance:WESPHERE\_Profile\_Dogit1\_Cluster\_01

HTTP Port: 7088

Software Component: EnterpriseOne RTE Server \$1.0.0-0849-2011\_02\_02

Cancel Continue

**Note:** For the Horizontal Node ensure that the listen address for the server and the machine are *exactly* the same. This should be the ip of the physical machine, not "localhost" or 127.0.0.1.

# Associate Machines with Servers

Use this procedure to associate machines with Servers:

1. Go to Environment > Machines.

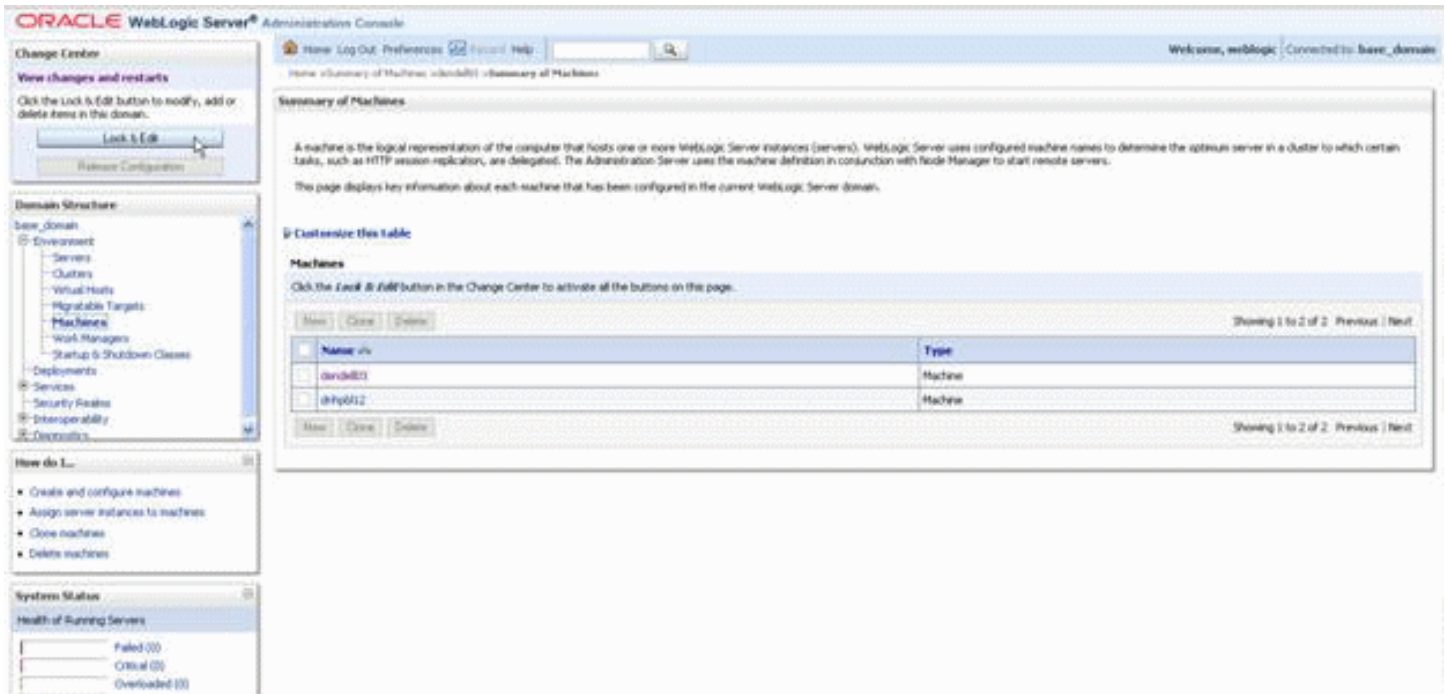

2. On Summary of Machines, click the Lock & Edit button at the bottom of the screen.

The screenshot displays the Oracle WebLogic Server Administration Console. The main content area is titled "Summary of Machines" and contains the following text:

A machine is the logical representation of the computer that hosts one or more WebLogic Server instances (Servers). WebLogic Server uses configured machine names to determine the optimum server in a cluster to which certain tasks, such as HTTP session replication, are delegated. The Administration Server uses the machine definition in conjunction with Node Manager to start remote servers.

This page displays key information about each machine that has been configured in the current WebLogic Server domain.

Below the text is a table titled "Machines" with the following data:

Name	Type
Machine-1	Machine
Machine-2	Machine

The table has "Showing 1 to 2 of 2" and "Previous | Next" links. Below the table are "New", "Clone", and "Delete" buttons. A red circle highlights the "Lock & Edit" button at the bottom of the table.

On the left side of the console, there is a "Domain Structure" pane showing a tree view with "Machines" selected. Below it is a "How do I..." section with the following items:

- Create and configure machines
- Assign server instances to machines
- Clone machines
- Delete machines

At the bottom left, there is a "System Status" section titled "Health of Running Services" with a progress bar showing "Failed (0)" and "Critical (0)".

3. In the Machines list, select the machine for the vertical nodes. If setting up horizontal cluster, select the machine for the horizontal node.

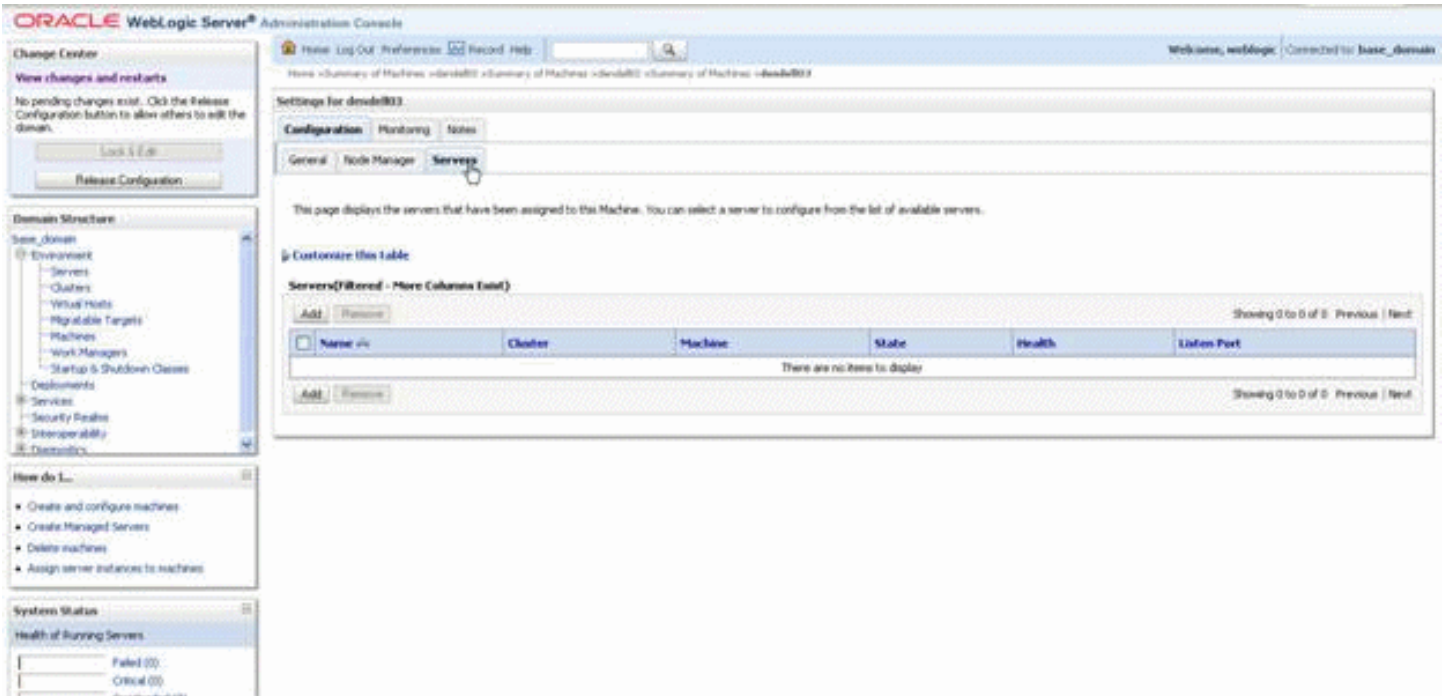

4. In Settings for <machine>, click on the Servers tab.

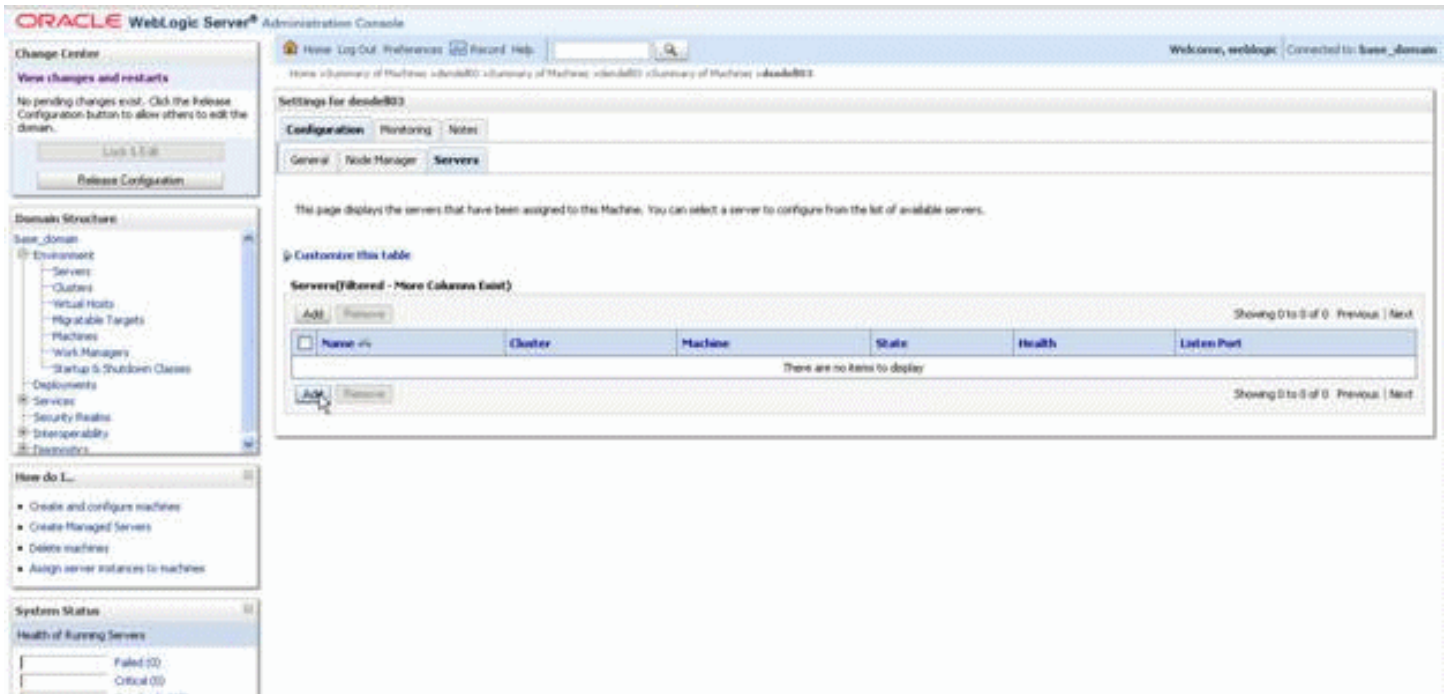



5. In Customize this table, click the Add button.

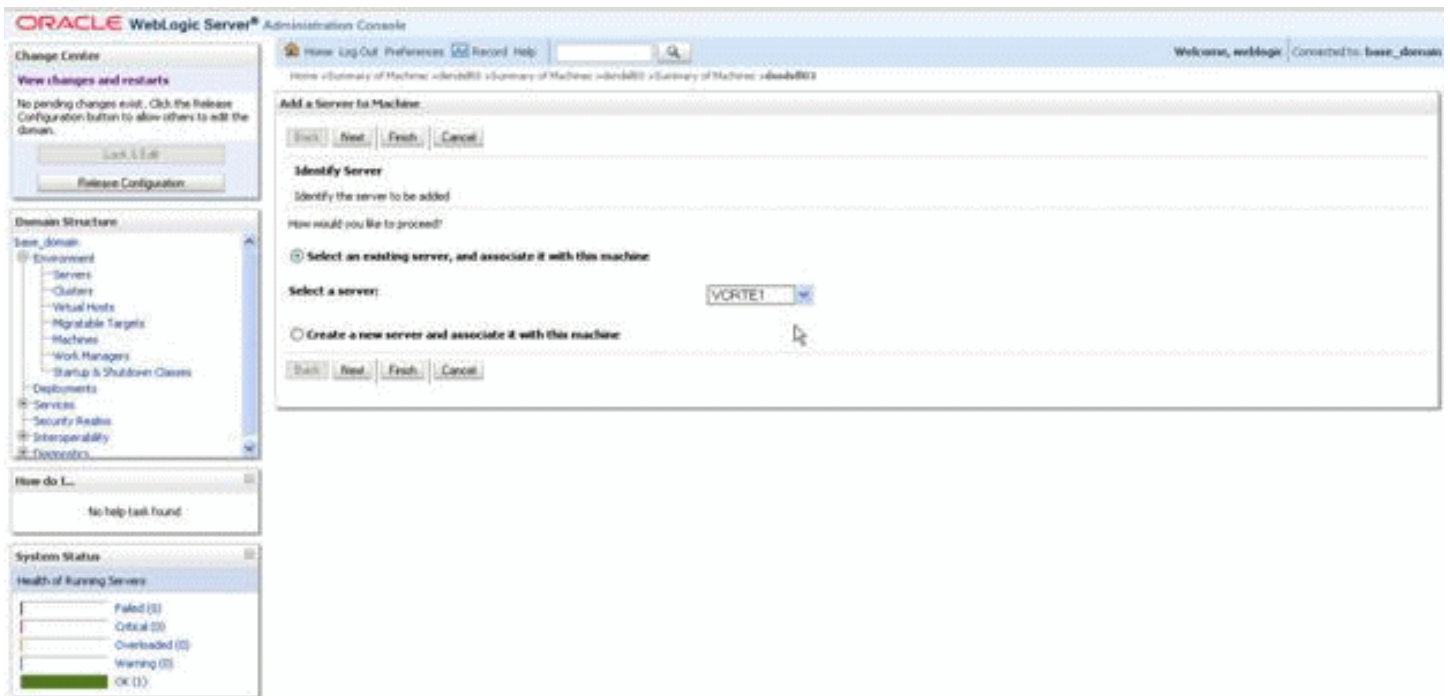

6. On Identify Server, complete these fields:

- Check this radio button:

Select an existing server, and associate it with this machine

- Select a server:

Use the pulldown to select an existing server.

7. Repeat the steps in this procedure if your cluster spans multiple machines or if multiple server instances will run on individual machines in the cluster.

8. Click the Finish button.

9. Click the Activate Changes button.

When you complete this procedure, your list of server will be similar to this:

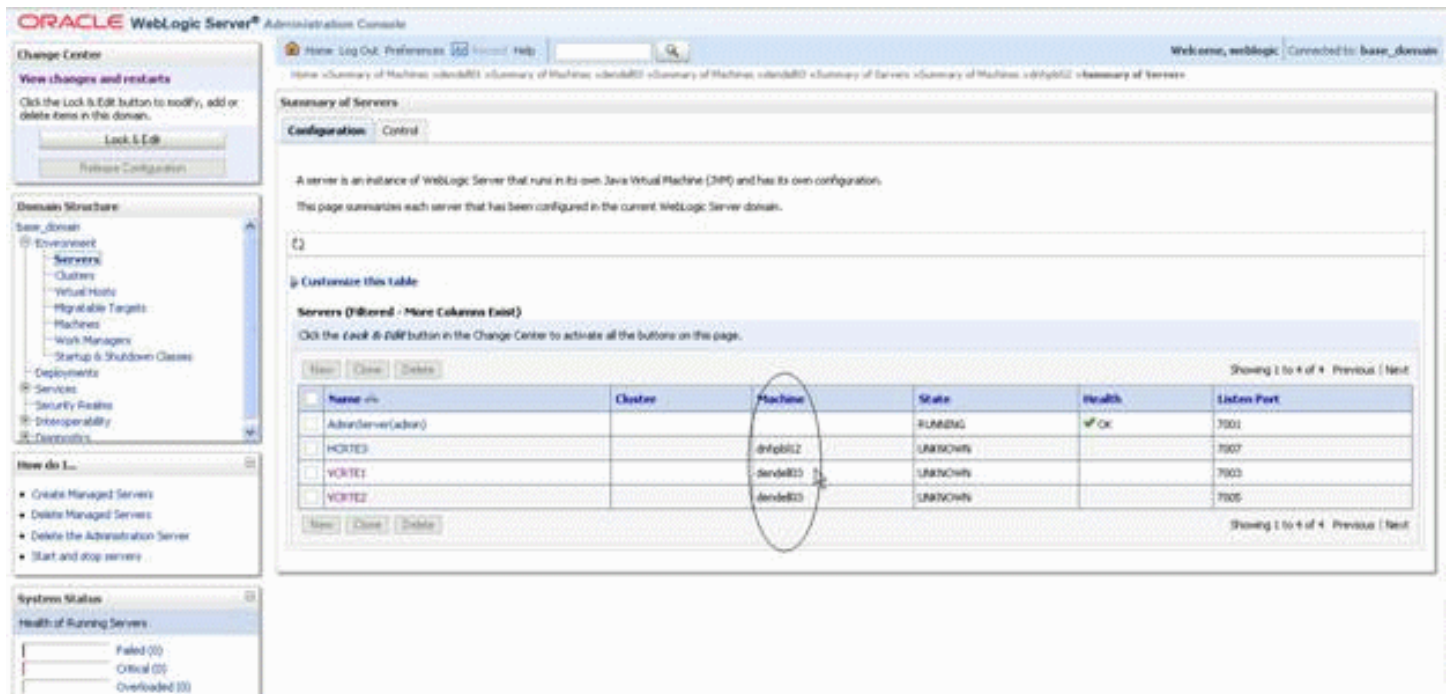

# Cluster the Servers

Use this procedure to cluster the servers.

1. Go to Environment > Clusters.

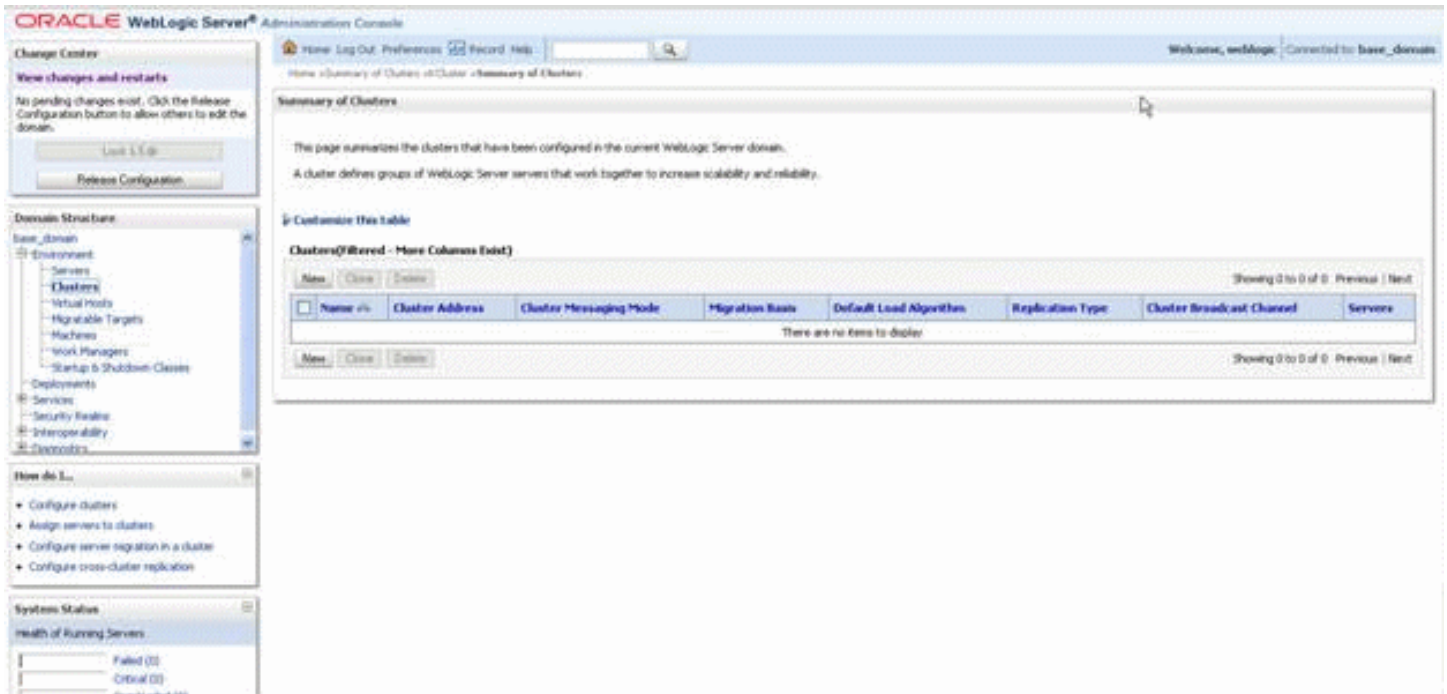

2. On Summary of Clusters, click the Lock & Edit button at the bottom of the screen.

3. Click the New button.

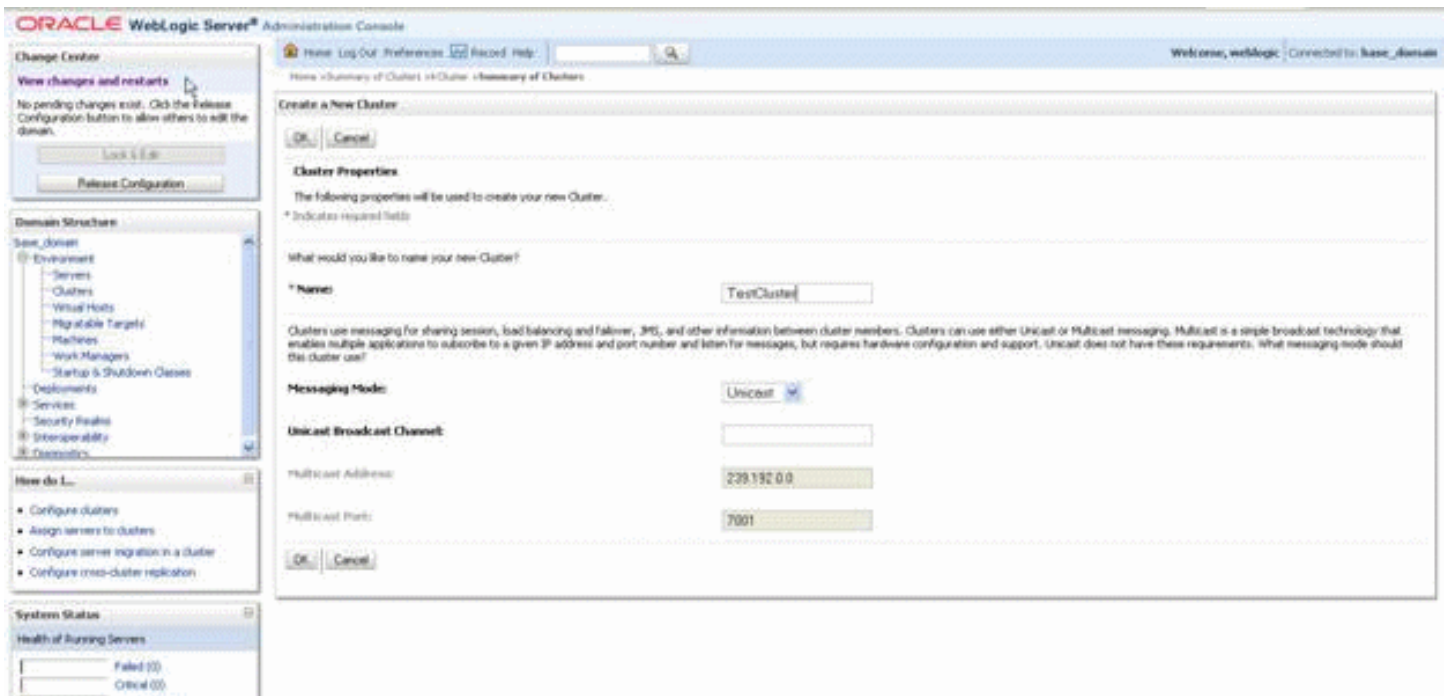

4. On Cluster Properties, complete these fields:

- *Name*  
Enter a name for the cluster.
- *Messaging Mode*  
Use the pulldown to select Unicast.
- *Unicast Broadcast Channel*  
Leave this field blank.
- *Multicast Address*  
Accept the default value.
- *Multicast Port*  
Accept the default value.

5. Click the OK button.

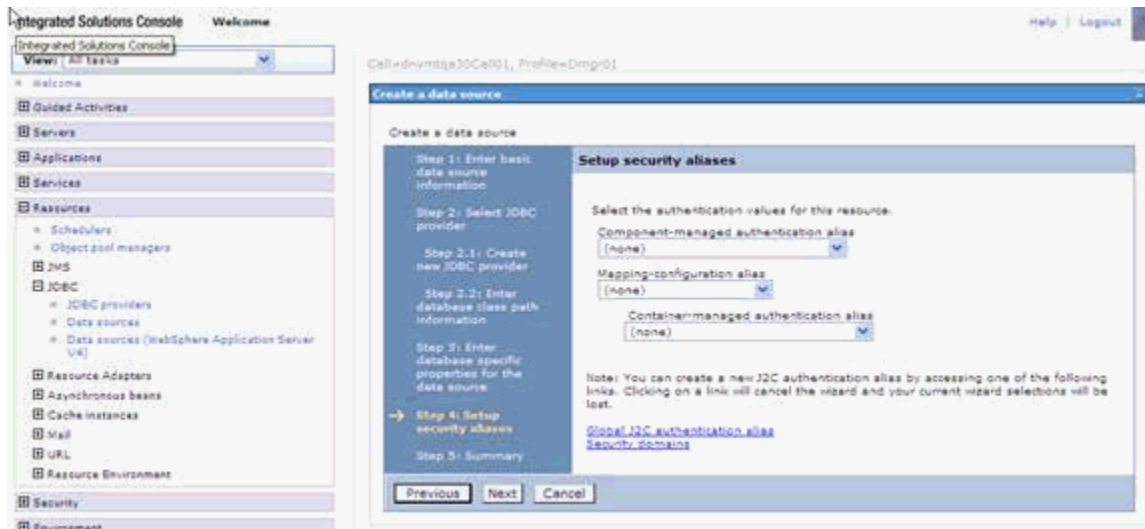

6. On Summary of Clusters, click on the newly-defined cluster name.

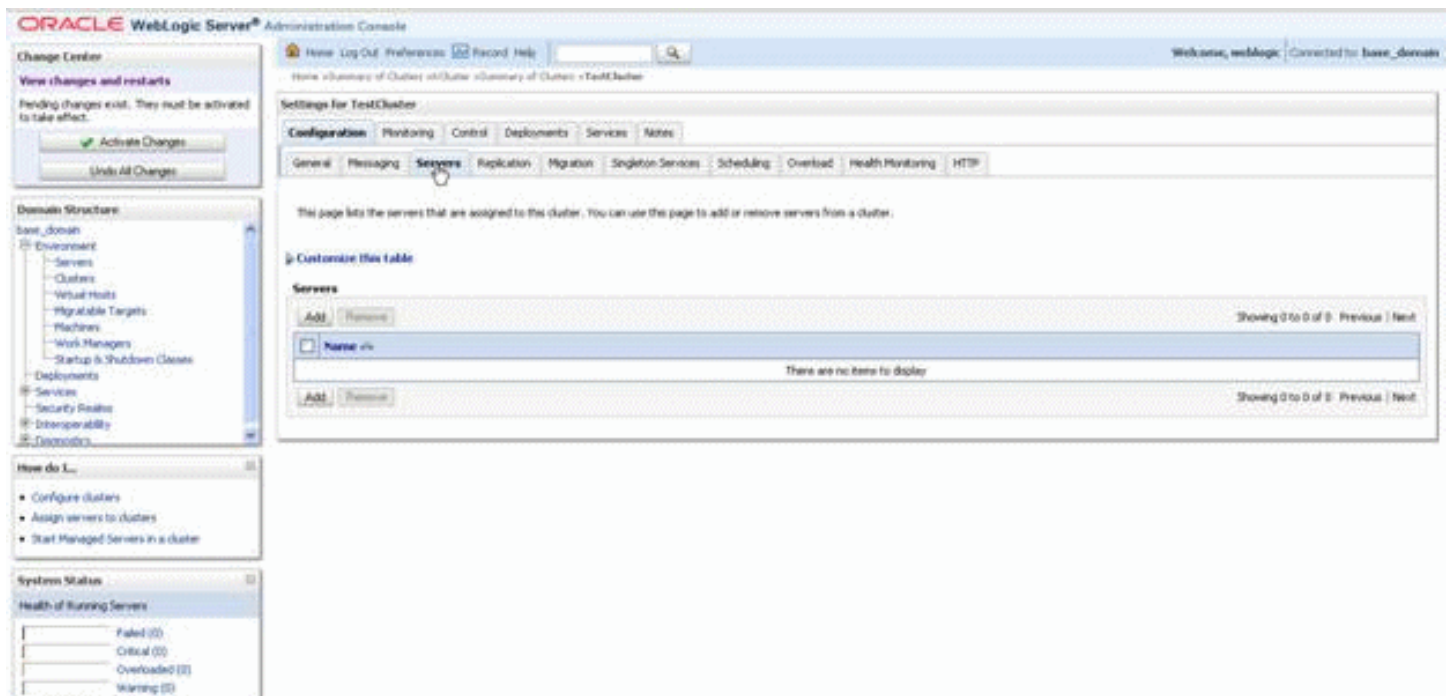

7. On Settings for <cluster>, click the **Servers** tab.
8. Click on the Add button.
9. Select the server.
10. Click next.
11. Repeat the preceding two steps for any additional servers.

- Click the Activate Changes button.

When you complete this procedure, your list of server will be similar to this:

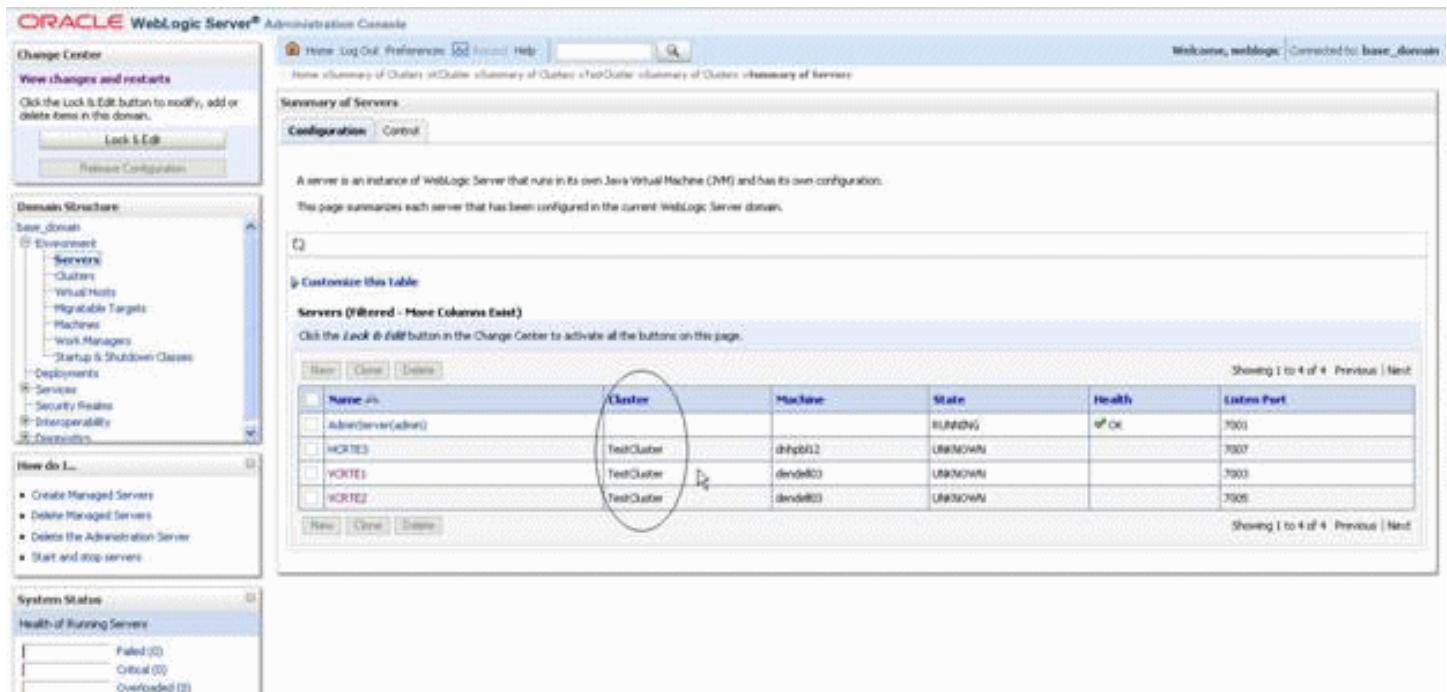

- Restart the admin server and all node managers.

## Setup the Cluster for Load Balancing

A cluster is setup with load balancing feature with round-robin algorithm by default. However the algorithm to be used can be changed based on requirement.

- Go to click Environment > Clusters.
- Click on the cluster name.

3. Go to General tab.

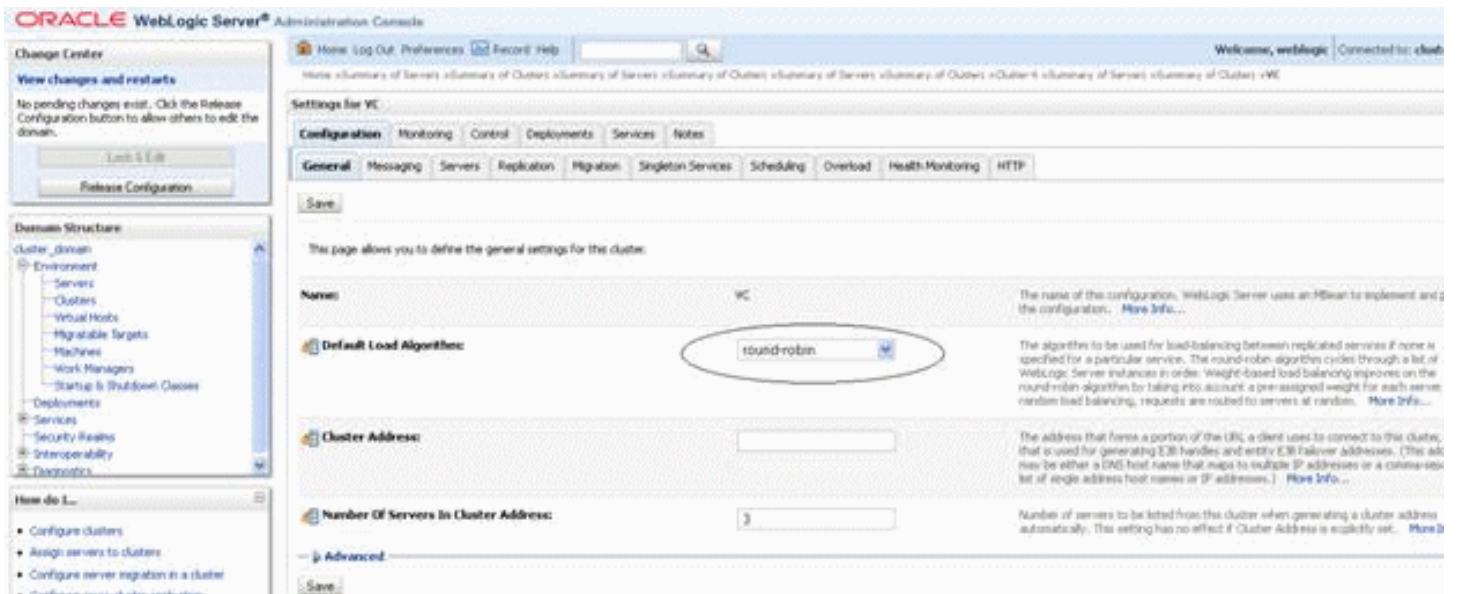

4. Click the Lock & Edit button.
5. Default Load Algorithm field contains several algorithms in the dropdown. Select the one you want to use. Different load balancing algorithms are round-robin, weight-based and random.
6. Click the Save button.
7. Click the Activate Changes button.

## Setup the Cluster for Failover

A cluster is setup with load balancing feature with round-robin algorithm by default. However the algorithm to be used can be changed based on requirement.

1. Go to Environment > Clusters.
2. Click on the cluster name.
3. Go to Migration tab
4. Click the Lock & Edit button.

5. In the Candidate Machines For Migratable Servers field, move the machines Available to Choose.



6. On Settings for VC, with the Configuration tab selected, complete this field:

- o *Migration Basis*

Use the pulldown to select Consensus.

**Note:** You can also select database as Migration Basis with additional setup.

7. Click Environment, Migratable Targets.
8. Click on the migratable target.
9. Go to Migration tab.

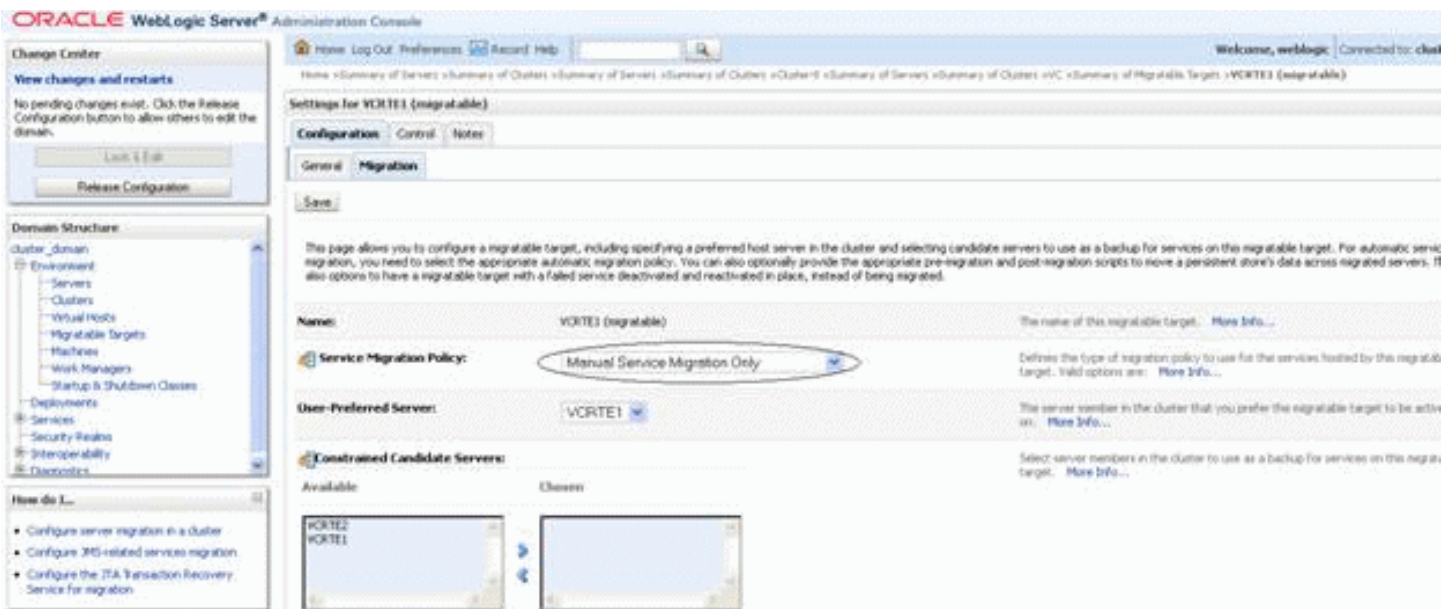



10. On Settings for <machine> (migratable), with the Migration tab selected, complete this field:

- o *Server Migration Policy*

Use the pulldown to select between these available policies:

- Manual Service Migration Only
- Auto-Migrate Exactly-Once Services
- Auto-Migrate Failure-Recovery Services

11. Click the Save button.

12. Click the Activate Changes button.

## Installing the Transaction Server RTE Component on WebLogic Server using Server Manager

Use this procedure to install the RTE application to the cluster via Server Manager.

1. Install the JD Edwards EnterpriseOne product Server Manager on a machine with the Microsoft Windows operating system.
2. Install the Server Manager agent on the machine that is running the Oracle WebLogic Administration Console.
3. Register the WebLogic server through Server Manager.
4. Logon to the Server Manager console.

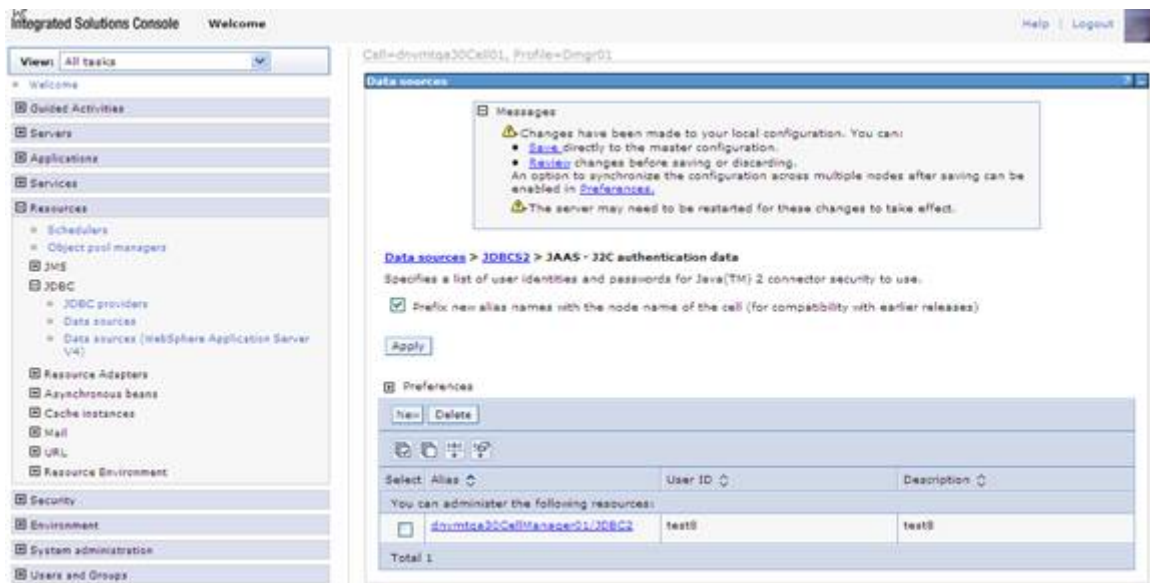

- On Managed Homes and Managed Instances, click on the machine running the registered Oracle WebLogic Server.

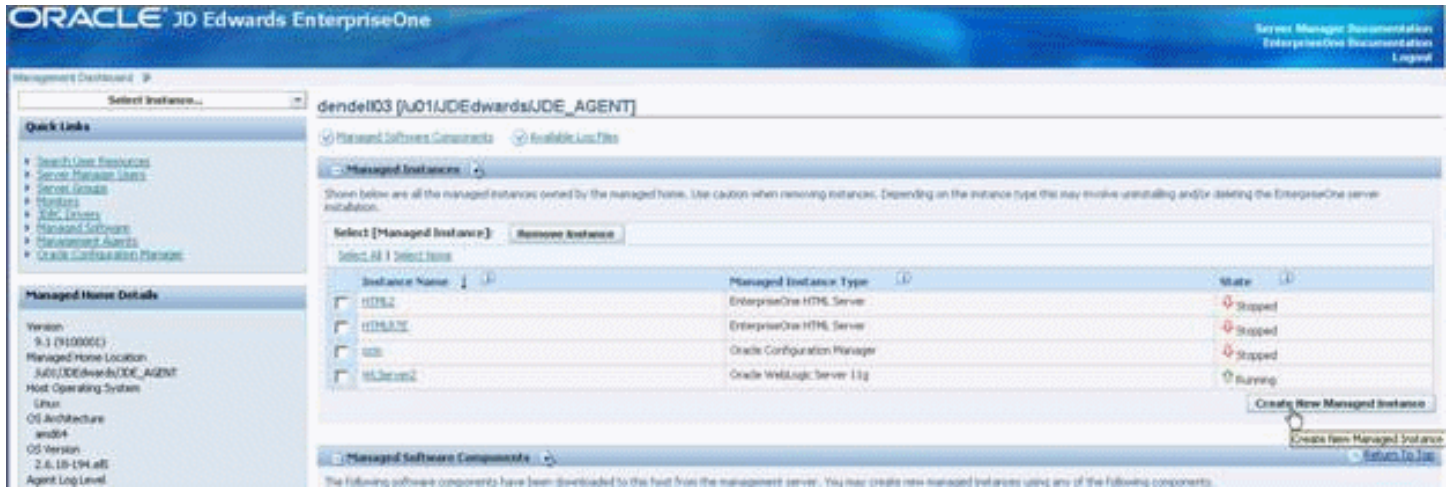

- Click the **Create New Managed Instance** button.

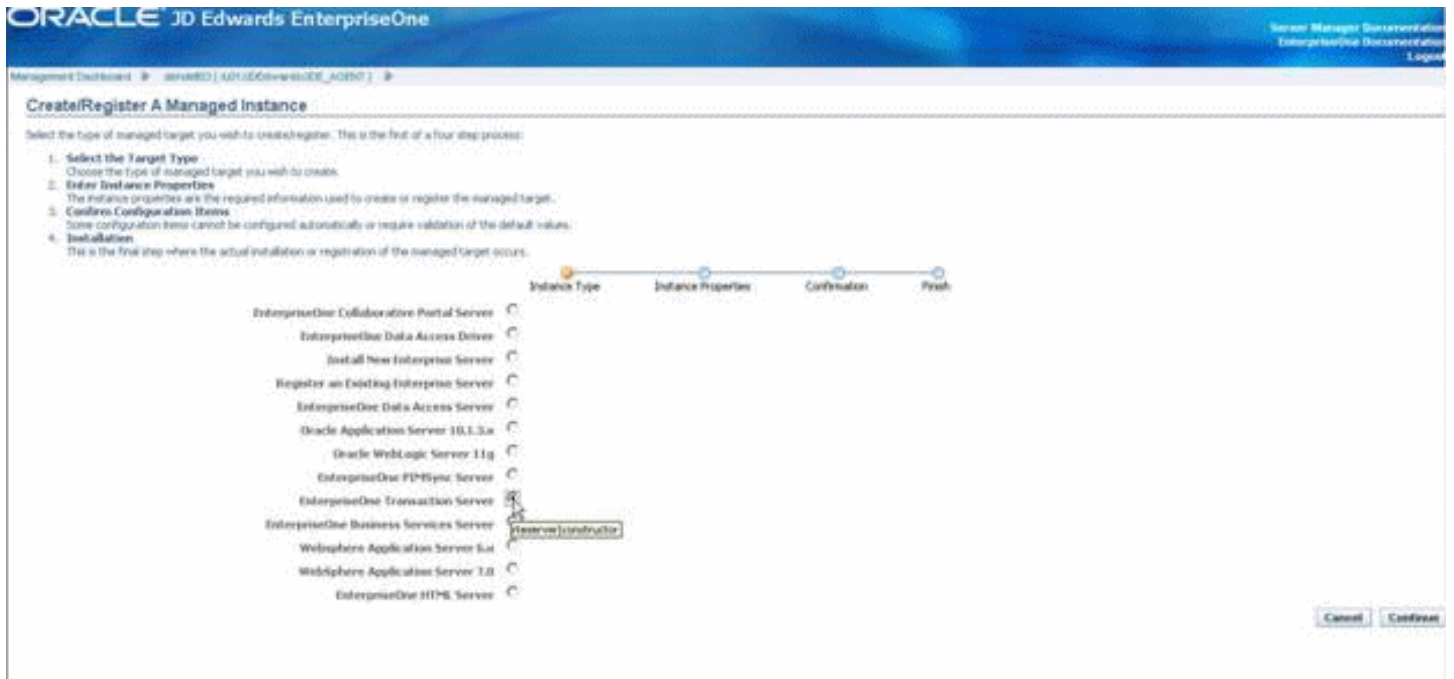

- On Create/Register A Managed Instance Type, Instance Type, click this radio button:  
EnterpriseOne Transaction Server

8. Click the Continue button.



9. On Create/Register A Managed Instance, Instance Properties, complete the fields:

- o *Server Group*

Accept the default value.

- o *Instance Name*

Enter an instance name.

- o *J2EE Server/Cluster*

Use the pulldown to select the Oracle WebLogic cluster.

- o *HTTP Port*

Accept the auto populated value.

**Note:** You should not manually change this value.

- o *Software Component*

Use the pulldown to select a valid JD Edwards RTE application software component for your installation.

10. Click the Continue button.

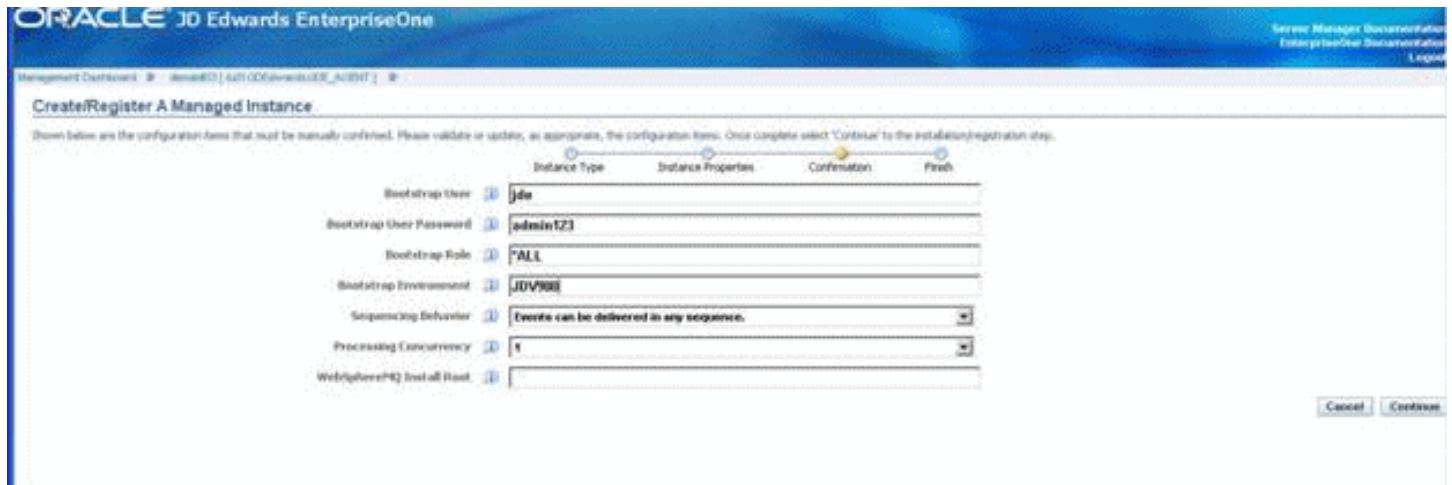

11. On Create/Register A Managed Instance, Confirmation, complete these fields:

- *Bootstrap User*

Enter any value that you will use for this user.

- *Bootstrap User Password*

Enter a password.

- *Bootstrap Role*

Enter the JD Edwards EnterpriseOne role for the bootstrap user. For example, \*ALL is a valid role.

- *Sequencing Behavior*

Use the pulldown to select the desired behavior.

- *Processing Concurrency*

Use the pulldown to select the desired processing concurrency value. This defines the number of concurrent event processing threads to run.

- *WebSphereMQ Initial Root*

Leave this value blank; it is not applicable to WebLogic installations.

12. Click the Continue button.

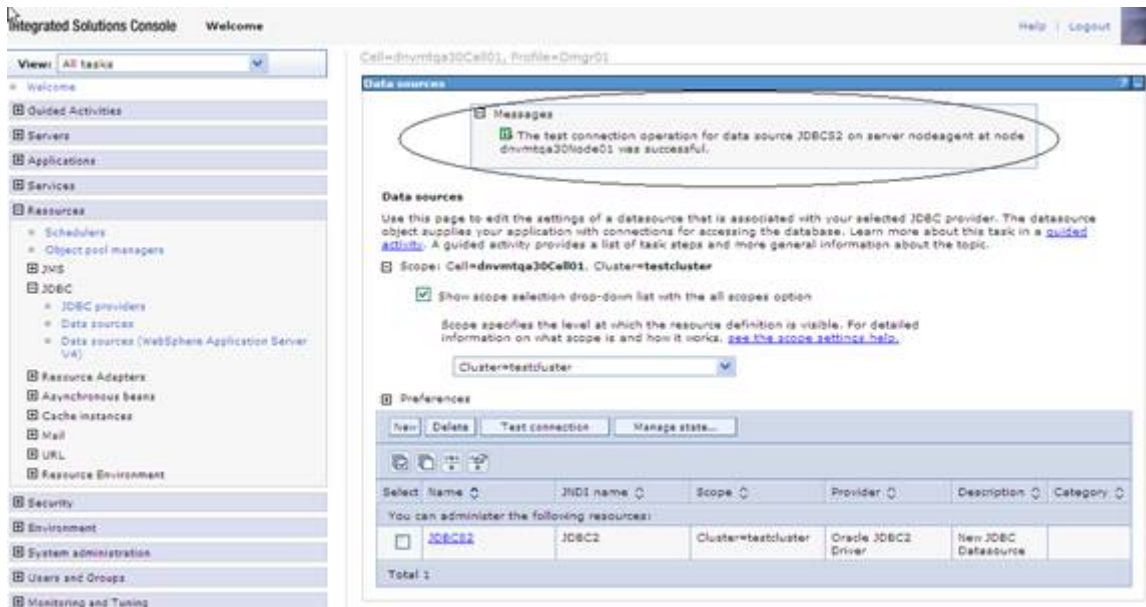

13. On Create/Register A Managed Instance, Finish, click the Create Instance button.

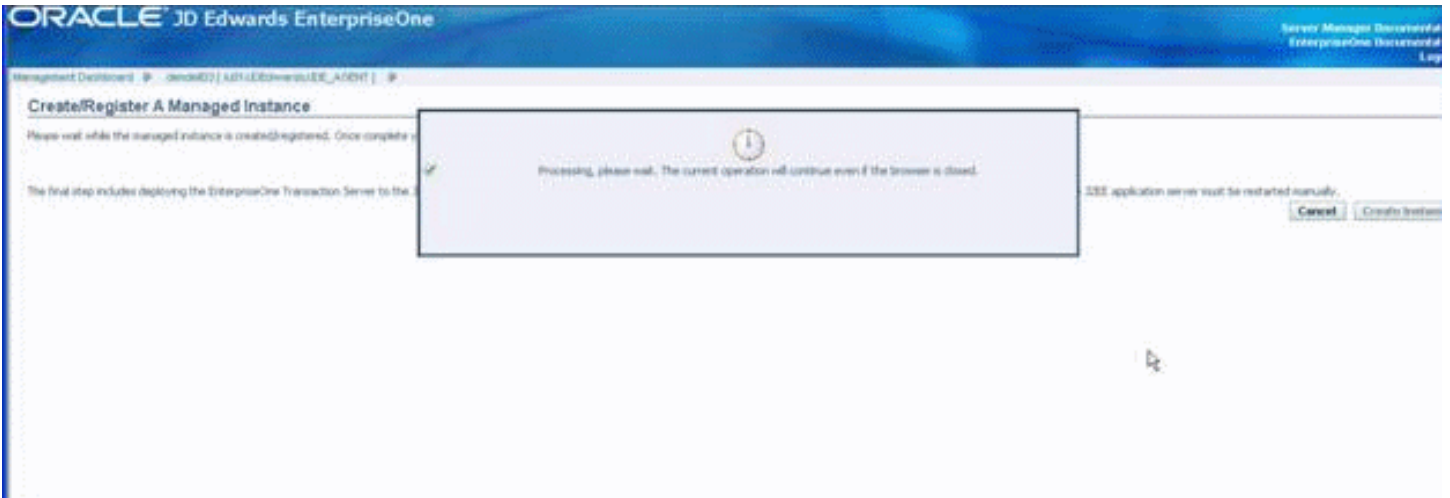

Server Manager displays a processing message.

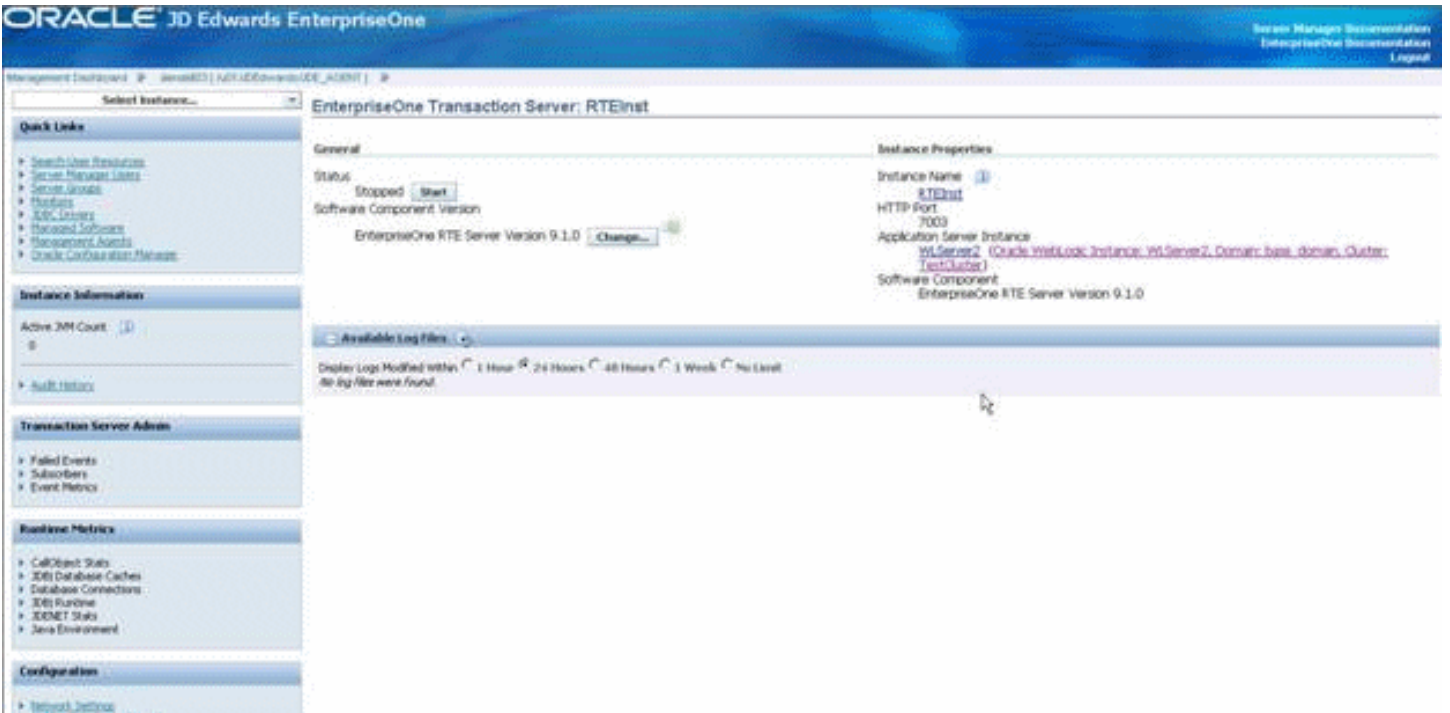

The instance screen for the RTE application displays.

**CAUTION:** Do not attempt to start the instance at this time. You must continue with the setup instructions in this guide until you are explicitly instructed to start the instance.

14. In the Configuration section, click Network Settings and complete the fields as applicable for your environment.

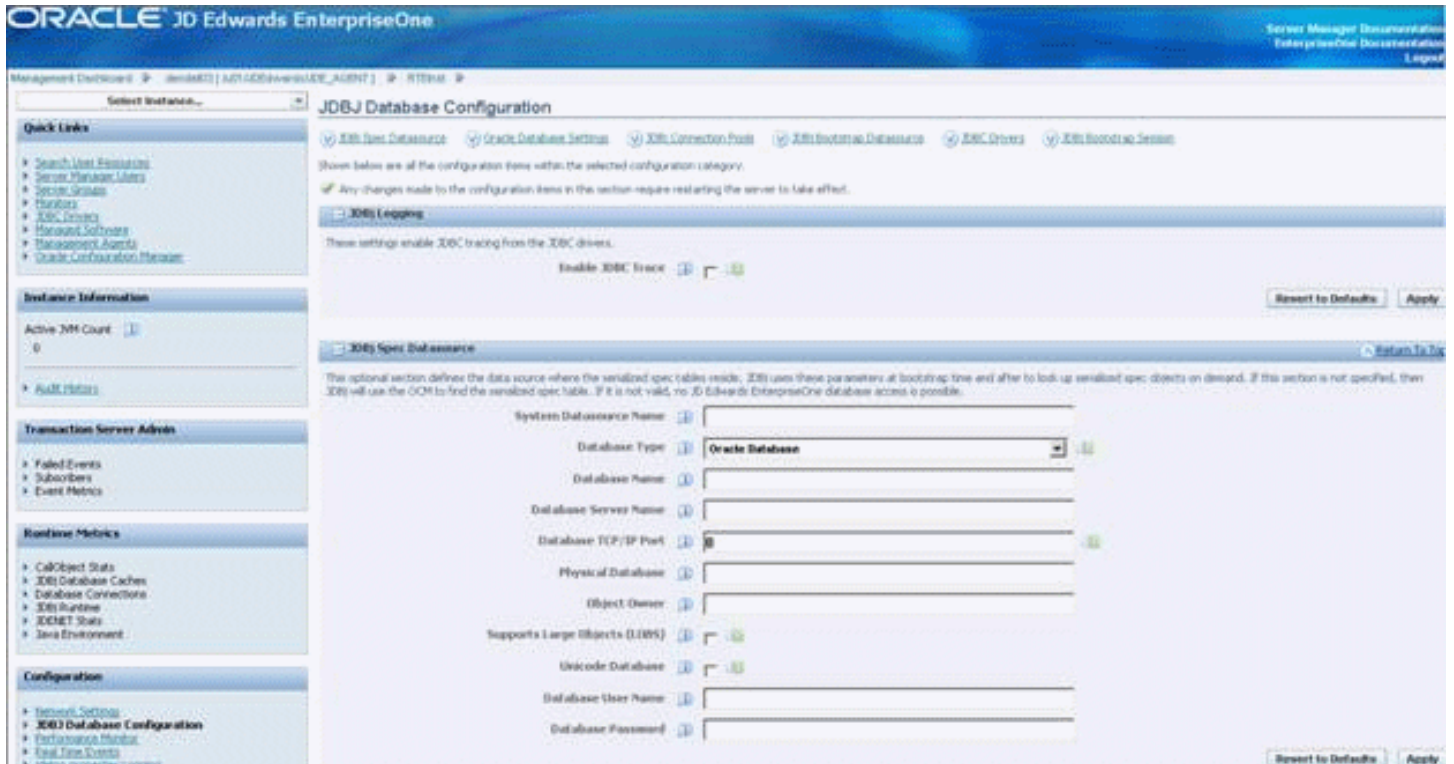

15. In the Configuration section, click JDBJ Database Configuration and complete the fields as applicable for your environment.

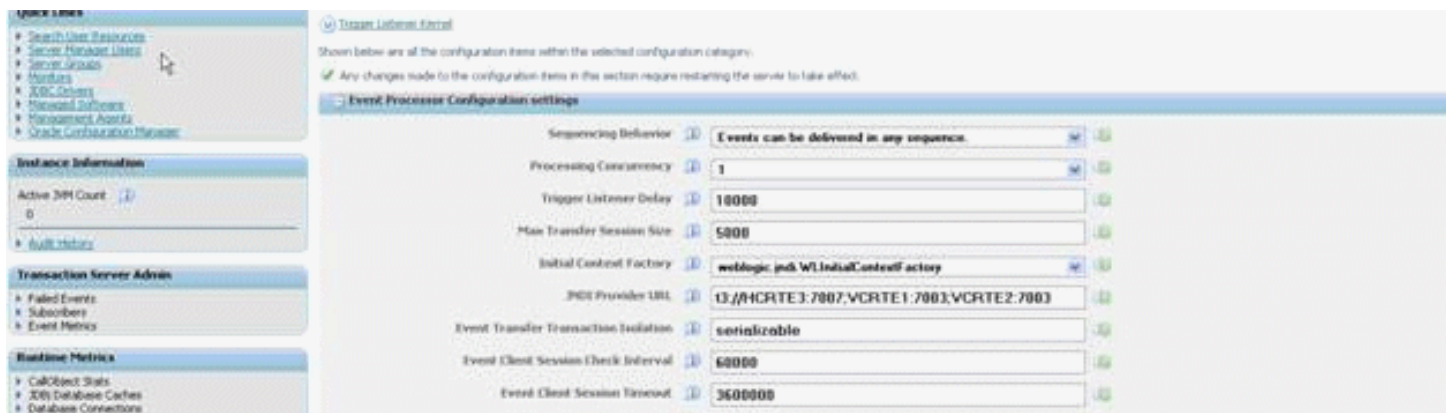

16. In the Configuration section, click Event Processor Configuration settings and confirm the fields are valid for your installation.

**CAUTION:** Do not attempt to start the instance at this time. You must continue with the setup instructions in this guide until you are explicitly instructed to start the instance.

## Using JDBC Persistent Stores

Follow the steps below to modify the installed configuration for using JDBC Persistent Stores instead of FileStore. In order to use horizontal clusters, it is mandatory to use JDBC Persistent Stores for JMS Servers.

**CAUTION:** Do not attempt to start the Transaction Server RTE instance or any other managed servers at this time. You must continue with the setup instructions in this guide until you are explicitly instructed to start an instance or managed server.

These instructions assume that you've already created a database to serve as a persistent store.

This chapter discusses these topics:

- [Create JDBC Datasources](#)
- [Create JDBC Persistent Stores](#)
- [Associate a JMS Server with a Persistent Store](#)

## Create JDBC Datasources

Use this procedure to create JDBC Datasources.

1. Logon to the WebLogic Administration Console.



2. Go to Services > Data Sources.

The screenshot shows the Oracle WebLogic Server Administration Console interface. The browser title bar reads "Summary of JDBC Data Sources - JDE01 - WLS Co...". The page header includes "ORACLE WebLogic Server® Administration Console" and navigation links: Home, Log Out, Preferences, Record, and Help. The breadcrumb trail is "Home > Summary of Services > Summary of JDBC Data Sources".

The main content area is titled "Summary of JDBC Data Sources" and has two tabs: "Configuration" (selected) and "Monitoring". A text block explains: "A JDBC data source is an object bound to the JNDI tree that provides database connectivity through a pool of X then borrow a database connection from a data source." Below this, it states: "This page summarizes the JDBC data source objects that have been created in this domain." There is a link to "Customize this table".

The "Data Sources (Filtered - More Columns Exist)" section contains a message: "Click the *Lock & Edit* button in the Change Center to activate all the buttons on this page." Below this message are "New" and "Delete" buttons. A table with the following structure is shown:

	Name	Type	JNDI Name
There are no items to display			

Below the table, there are "New" and "Delete" buttons. On the left side of the console, the "Change Center" panel shows "View changes and restarts" with "Lock & Edit" and "Release Configuration" buttons. The "Domain Structure" tree on the left shows the following hierarchy: JDE01 > Environment > Deployments > Services > Messaging > Data Sources. Other items in the tree include Persistent Stores, Foreign JNDI Providers, Work Contexts, XML Registries, XML Entity Caches, jCOM, Mail Sessions, and File T3. A "How do I..." link is visible at the bottom left.

3. On Summary of JDBC Data Sources, click the **Lock & Edit** button.

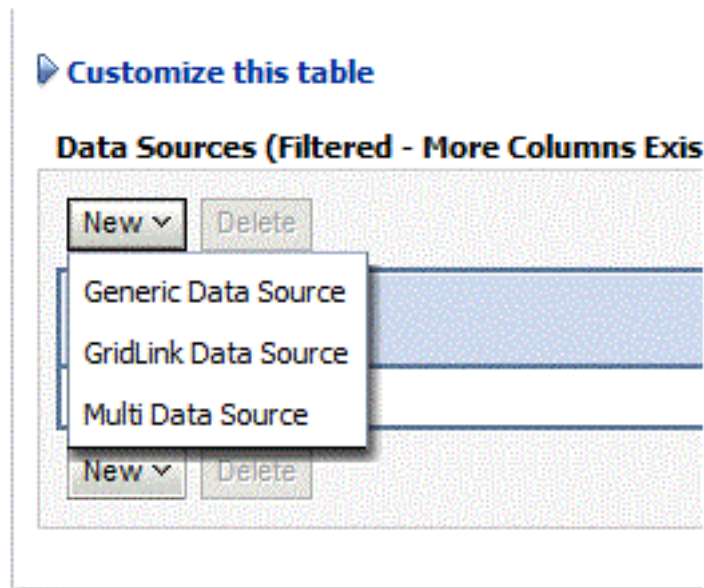

4. On Summary of JDBC Data Sources, in the **Customize this table** section, use the **New** pulldown to select **Generic Data Source**.



5. On Create a New JDBC Data Source, JDBC Data Source Properties, complete these fields:

- o *Name*  
Enter a name for the JDBC data source.
- o *JNDI Name*  
Enter a name for the JNDI.
- o *Database Type*  
Use the pulldown to select your database type.

6. Click the **Next** button.

The screenshot shows the 'Create a New JDBC Data Source' dialog box. At the top, there are buttons for 'Back', 'Next', 'Finish', and 'Cancel'. Below this is the 'JDBC Data Source Properties' section. It contains the text: 'The following properties will be used to identify your new JDBC data source.' Underneath, 'Database Type:' is set to 'MS SQL Server'. A note asks: 'What database driver would you like to use to create database connections? Note: \* indicates that the driver is explicitly supported by Oracle WebLogic Server.' The 'Database Driver:' dropdown menu is open, showing '\*Oracle's MS SQL Server Driver (Type 4) Versions:7.0 and later'. At the bottom, there are buttons for 'Back', 'Next', 'Finish', and 'Cancel'.

7. On Create a New JDBC Data Source, use the pulldown to select the driver appropriate for your database.

**Note:** For Oracle databases, you must select the thin driver. You cannot use an XA driver.

8. Click the **Next** button.

The screenshot shows the 'Create a New JDBC Data Source' dialog box at the 'Transaction Options' step. It has buttons for 'Back', 'Next', 'Finish', and 'Cancel'. The text says: 'You have selected non-XA JDBC driver to create database connection in your new data source.' It then asks: 'Does this data source support global transactions? If yes, please choose the transaction protocol for this data source.' There are three radio button options: 'Supports Global Transactions' (unchecked), 'Logging Last Resource' (selected), and 'Emulate Two-Phase Commit' (selected). Below these are two more radio button options: 'One-Phase Commit' (selected) and 'Emulate Two-Phase Commit' (selected). At the bottom, there are buttons for 'Back', 'Next', 'Finish', and 'Cancel'.

9. On Create a New JDBC Data Source, Transaction Options, *deselect* this checkbox:

### Supports Global Transactions

10. Click the **Next** button.

**Create a New JDBC Data Source**

Back Next Finish Cancel

**Connection Properties**  
Define Connection Properties.

What is the name of the database you would like to connect to?

**Database Name:** RTECLUSTER

What is the name or IP address of the database server?

**Host Name:** TOOLS910E

What is the port on the database server used to connect to the database?

**Port:** 1433

What database account user name do you want to use to create database connections?

**Database User Name:** RTECLUSTER

What is the database account password to use to create database connections?

**Password:** ●●●●●●

**Confirm Password:** ●●●●●●

Back Next Finish Cancel

11. On Create a New JDBC Data Source, Connection Properties, complete these fields:

- *Database Name*  
Enter a name for the database to which you want to connect.
- *Host Name*  
Enter the name or IP address of the database server.
- *Port*

Enter the port on the database server which is used to connect.

- *Database User Name*

Enter the database account you want to use to create the database connections.

- *Password*

Enter the database account password to use to create database connections.

- *Confirm Password*

Confirm the database account password.

12. Click the **Next** button.

The screenshot shows a 'Messages' section at the top with a green checkmark and the text 'Connection test succeeded.' Below this is a header for 'Create a New JDBC Data Source' with a mouse cursor over it. A row of buttons includes 'Test Configuration', 'Back', 'Next', 'Finish', and 'Cancel'. The main section is titled 'Test Database Connection' and contains the following text: 'Test the database availability and the connection properties you provided.' Below this is a question: 'What is the full package name of JDBC driver class used to create database connections in the connection pool?' with a note: '(Note that this driver class must be in the classpath of any server to which it is deployed.)' The 'Driver Class Name:' field contains 'weblogic.jdbc.sqlserver.SC'. Another question asks: 'What is the URL of the database to connect to? The format of the URL varies by JDBC driver.' The 'URL:' field contains 'jdbc:weblogic:sqlserver://'. A third question asks: 'What database account user name do you want to use to create database connections?' The 'Database User Name:' field contains 'RTECLUSTER'. A final question asks: 'What is the database account password to use to create database connections?' with a note: '(Note: for secure password management, enter the password in the Password field instead of the Properties field below)'. The 'Password:' and 'Confirm Password:' fields are shown as masked with dots.

13. On Create a New JDBC Data Source, Test Database Connection, click the **Test Configuration** button.
14. Ensure you receive this message: **connection test succeeded**

- Click the **Next** button.

The screenshot shows the 'Create a New JDBC Data Source' wizard at the 'Select Targets' step. The interface includes a title bar, navigation buttons (Back, Next, Finish, Cancel), and a descriptive paragraph. Below the text are two sections: 'Servers' and 'Clusters'. The 'Servers' section has three items: AdminServer, BSSVTL, and test2, each with an unchecked checkbox. The 'Clusters' section has a checked checkbox for RCV1, followed by radio buttons for 'All servers in the cluster' (selected) and 'Part of the cluster'. Under 'Part of the cluster', there are two unchecked checkboxes for RTEC1 and RTEC2. A mouse cursor is visible over the 'Next' button.

- On Summary of JDBC Data Sources, in the list of Data Sources (Filtered - More Columns Exist), select the checkboxes for all servers in the cluster.

The screenshot shows the 'Summary of JDBC Data Sources' page. It has a title bar and two tabs: 'Configuration' (selected) and 'Monitoring'. Below the tabs is a descriptive paragraph and a link to 'Customize this table'. The main content is a table titled 'Data Sources (Filtered - More Columns Exist)'. The table has columns for Name, Type, JNDI Name, and Targets. There is one row with the name 'JDBC Data Source-RTEC', Type 'Generic', JNDI Name 'RTEC', and Targets 'RCV1'. Navigation buttons (New, Delete) are present above and below the table. The page also shows 'Showing 1 to 1 of 1' and 'Previous | Next' links.

Name	Type	JNDI Name	Targets
JDBC Data Source-RTEC	Generic	RTEC	RCV1

17. Click the **Finish** button at the bottom of the page.
18. Repeat the applicable steps in this procedure to add additional JDBC data sources.
19. Click Activate changes.

## Create JDBC Persistent Stores

Server Manager deploys the RTE solution with file persistent stores already created. This works for vertical clusters, but should be changed to JDBC type persistent stores for horizontal clusters.

Use this procedure to create the necessary JDBC persistent stores.

1. Go to Services > Persistent Stores.

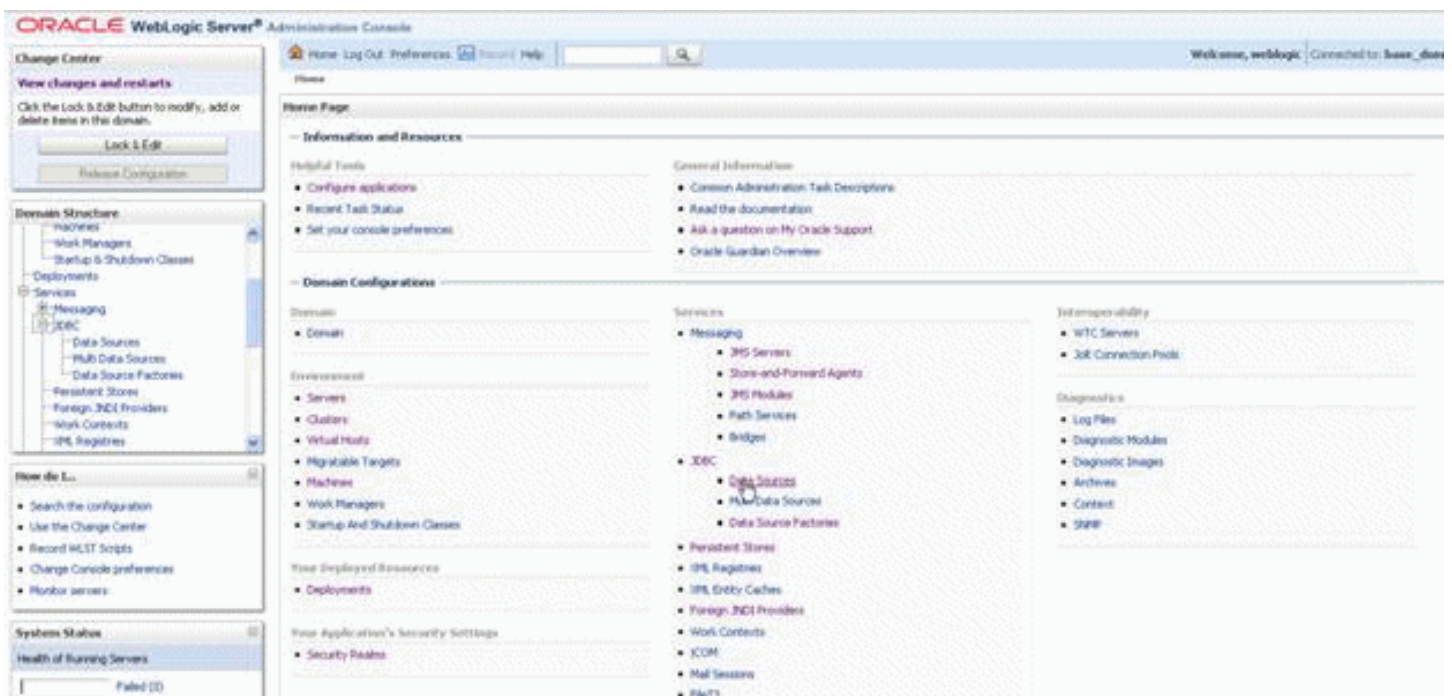



2. On Summary of Persistent Stores, click the **Lock & Edit** Button.

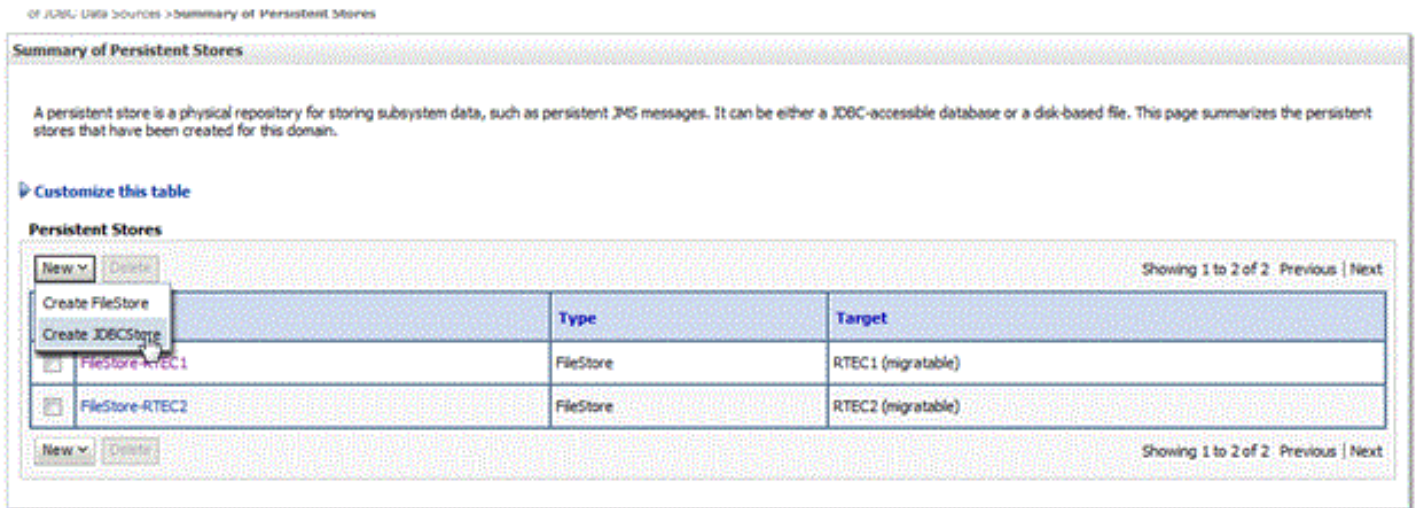

3. On Summary of Persistent Stores, in the **Customize this table** section, click the **New** pulldown and on the flyout choose **Create JDBCStore**.

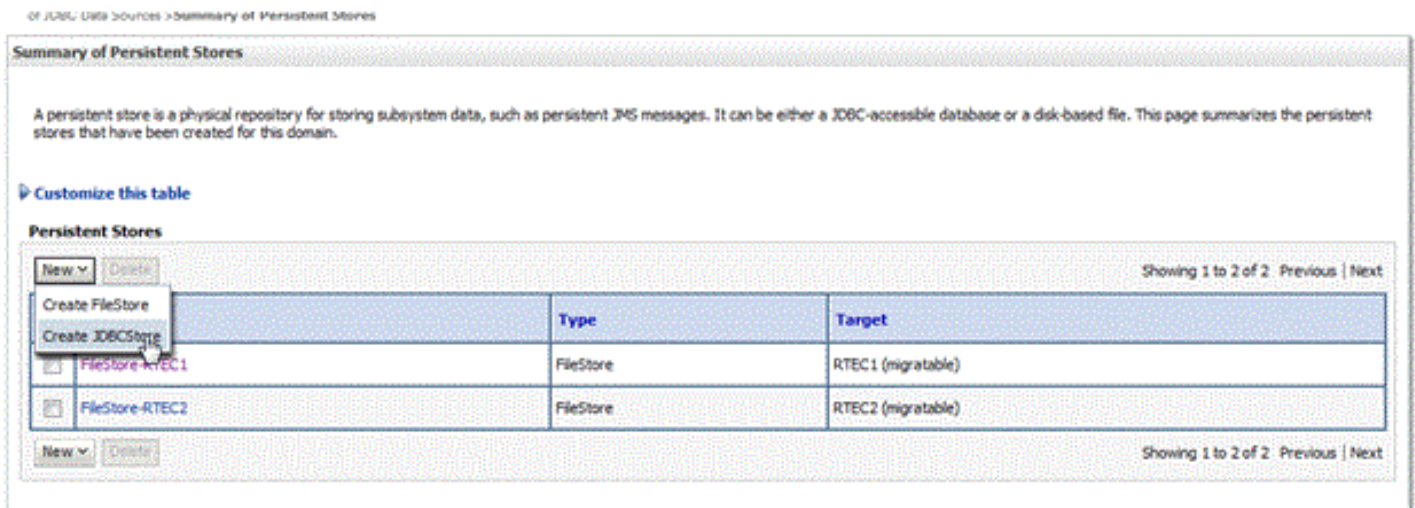

4. On Settings for JDBCStore, complete these fields:

o *Name*

Enter a name for the JDBC store. The name must be unique within the WebLogic Server instance or its cluster.

o *Target*

Use the pulldown to select the migratable server. The list will show of all WebLogic Server instances that have been defined in the current domain and are therefore candidates for hosting this JDBC store.

o *Data Source*

Use the pulldown to select the JDBC data source used by this JDBC store to access its backing table.

**CAUTION:** The list will only show JDBC datasources that:

- Do not use global transactions.
- Do not use a non XA JDBC driver.
- Are not configured to enable Logging Last Resource
- Are not configured to Emulate Two-Phase Commit

o *Prefix Name*

Leave this field blank.

5. Click the Save button.

6. Click the OK button.

7. Repeat the applicable steps to add additional persistent stores for additional JMS servers.

8. Click the Activate Changes button.

When you complete this procedure, your list of server will be similar to this:

JMS Servers (Filtered - More Columns Exist)

Click the *Lock & Edit* button in the Change Center to activate all the buttons on this page.

Showing 1 to 2 of 2 Previous | Next

<input type="checkbox"/>	Name	Persistent Store	Target	Current Server	Health
<input type="checkbox"/>	JMServer-RTEC1	JDBCStore-RTEC1	RTEC1 (migratable)	RTEC1	
<input type="checkbox"/>	JMServer-RTEC2	JDBCStore-RTEC2	RTEC2 (migratable)	RTEC2	

Showing 1 to 2 of 2 Previous | Next

## Associate a JMS Server with a Persistent Store

Server Manager by default associates the JMS Servers with file persistent stores. For using JDBC store or using horizontal cluster, you must associate the JMS Servers with JDBC persistent stores.

Use this procedure to associate a JMS Server with a persistent store:

1. Go to Services > Messaging > JMS Servers.

The screenshot shows the Oracle WebLogic Server Administration Console. The left-hand navigation pane has 'JMS Settings' circled under the 'Services' section. The main content area is titled 'Summary of JMS Servers' and contains a table with the following data:

Name	Persistent Store	Target	Current Server	Health
JMServer-VORTEX	FileStore-VORTEX	VORTEX (migratable)	VORTEX	
JMServer-VORTEX	FileStore-VORTEX	VORTEX (migratable)	VORTEX	
JMServer-VORTEX	FileStore-VORTEX	VORTEX (migratable)	VORTEX	

2. On Summary of JMS Server, click the Lock & Edit button at the bottom of the page.

The screenshot shows the Oracle WebLogic Server Administration Console interface. On the left, there is a 'Change Center' with a 'Lock & Edit' button. Below it is a 'Domain Structure' tree showing the hierarchy from 'base\_domain' to 'Services' and 'JMS Servers'. A 'How do I...' section lists 'Configure JMS servers' and 'Configure JMS system modules'. The 'System Status' section shows 'Health of Running Servers' with a bar chart. The main content area is titled 'Summary of JMS Servers' and contains a table of JMS servers. The table has columns for Name, Persistent Store, Target, Current Server, and Health. Three servers are listed: JMSQueue-VORTE2, JMSQueue-VORTE1, and JMSQueue-VORTE2. The 'Lock & Edit' button is visible at the bottom of the table.

Name	Persistent Store	Target	Current Server	Health
JMSQueue-VORTE2	FileStore-VORTE2	VORTE2 (segregatable)	VORTE2	
JMSQueue-VORTE1	FileStore-VORTE1	VORTE1 (segregatable)	VORTE1	
JMSQueue-VORTE2	FileStore-VORTE2	VORTE2 (segregatable)	VORTE2	

- On Summary of JMS Server, in the JMS Servers (Filtered - More Columns Exist), click on the JMS Server that you want to associate with a persistent store.

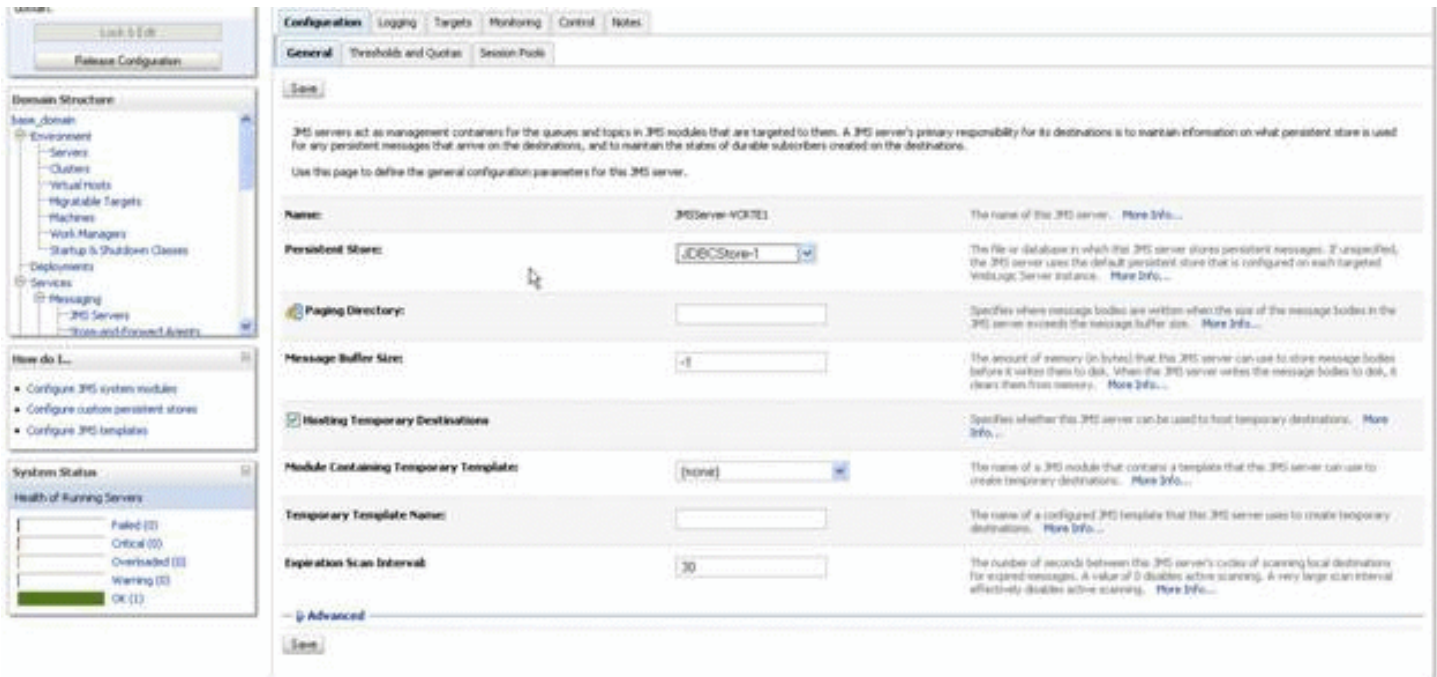

- Click on the General Tab and complete these fields:

- Persistent Store*

Use the pulldown to select the JDBC Store to which you want to associate.

- Paging Directory*

Accept the default value.

- Message Buffer Size*

Accept the default value.

- Hosting Temporary Destinations*

Ensure the checkbox for this option is selected.

- Module Containing Temporary Templates*

Accept the default value.

- Temporary Template Name*

Accept the default value.

- Expiration Scan Interval*

Accept the default value.

- Click the Save button.

- Click the Activate Changes button.

7. Repeat the applicable steps to add JMS Servers and persistent stores.

When you complete this procedure, your list of server will be similar to this:

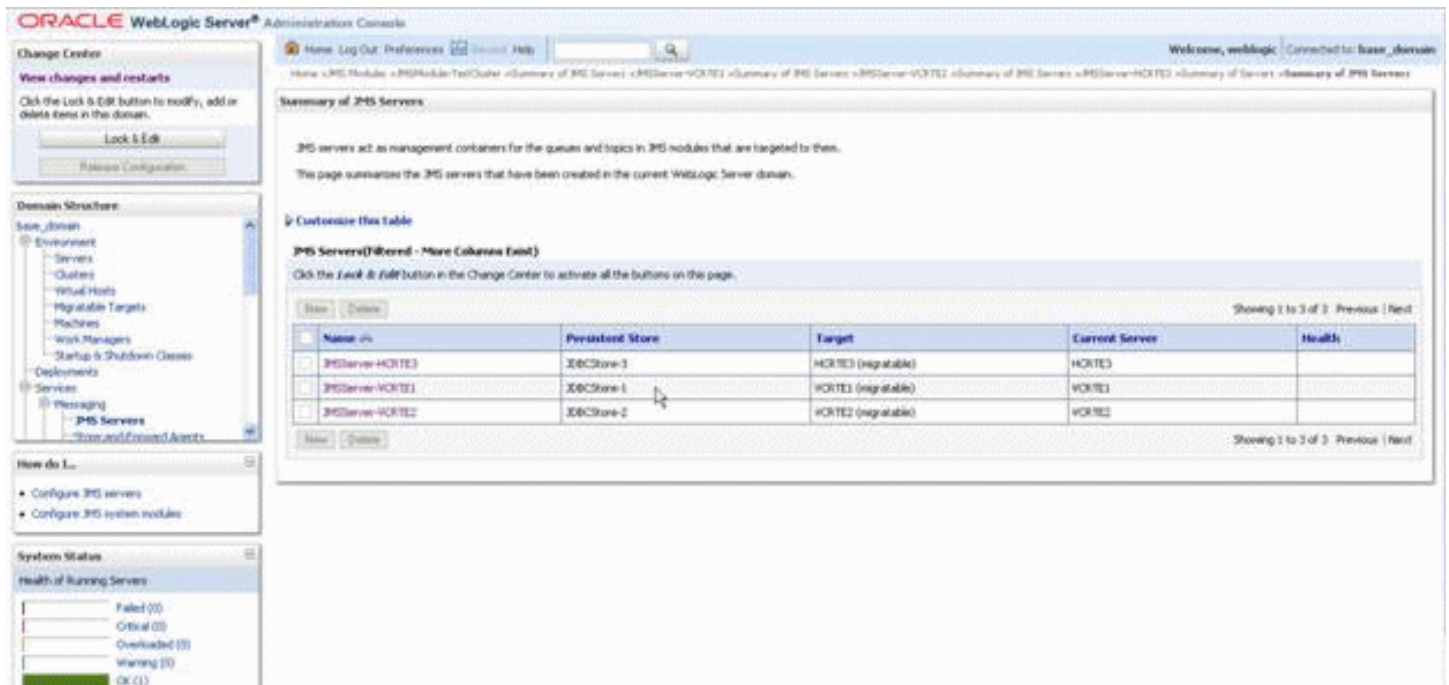

## Additional Configuration for Using Horizontal Cluster

Server Manager creates the necessary file structure on the node that the WebLogic Administration Console resides on. However, for any horizontal cluster nodes, these files should be transferred manually. On Windows Machines, this

should be done through Windows Explorer. For Unix or Linux machines, this should be done through FTP. The steps below use Linux/FTP as an example.

1. Use these steps to determine where the RTE installation is looking for the requisite ini files:
  - a. Go to Servers > *Server\_Name*.
  - b. Click on the Server Start tab.

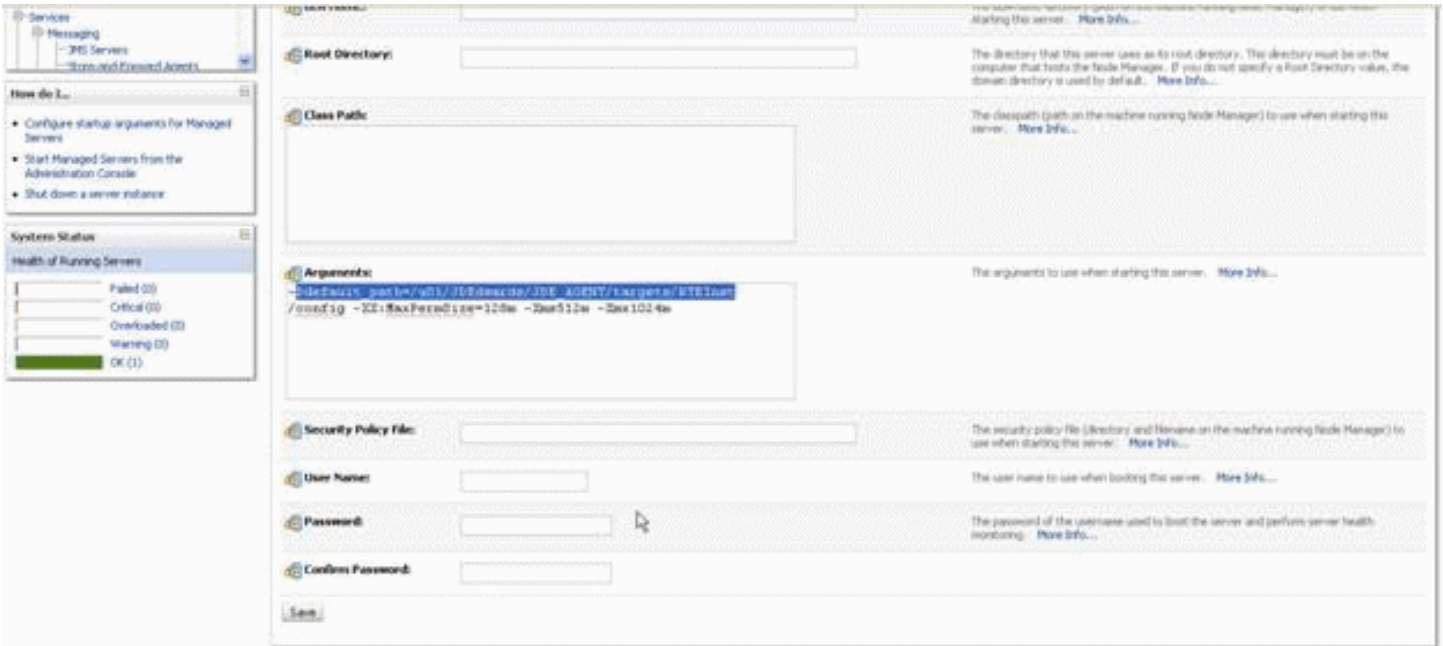

- c. In the Arguments section, note the `-Ddefault_path` structure.

For example, in the above example the structure is:

```
/u01/JDEdwards/JDE_AGENT/targets/RTEInst/config
```

This is the directory that is created on the horizontal node and where the necessary files must be copied.

- d. On the target machine, you must pre-create the necessary directory structure.

For example:

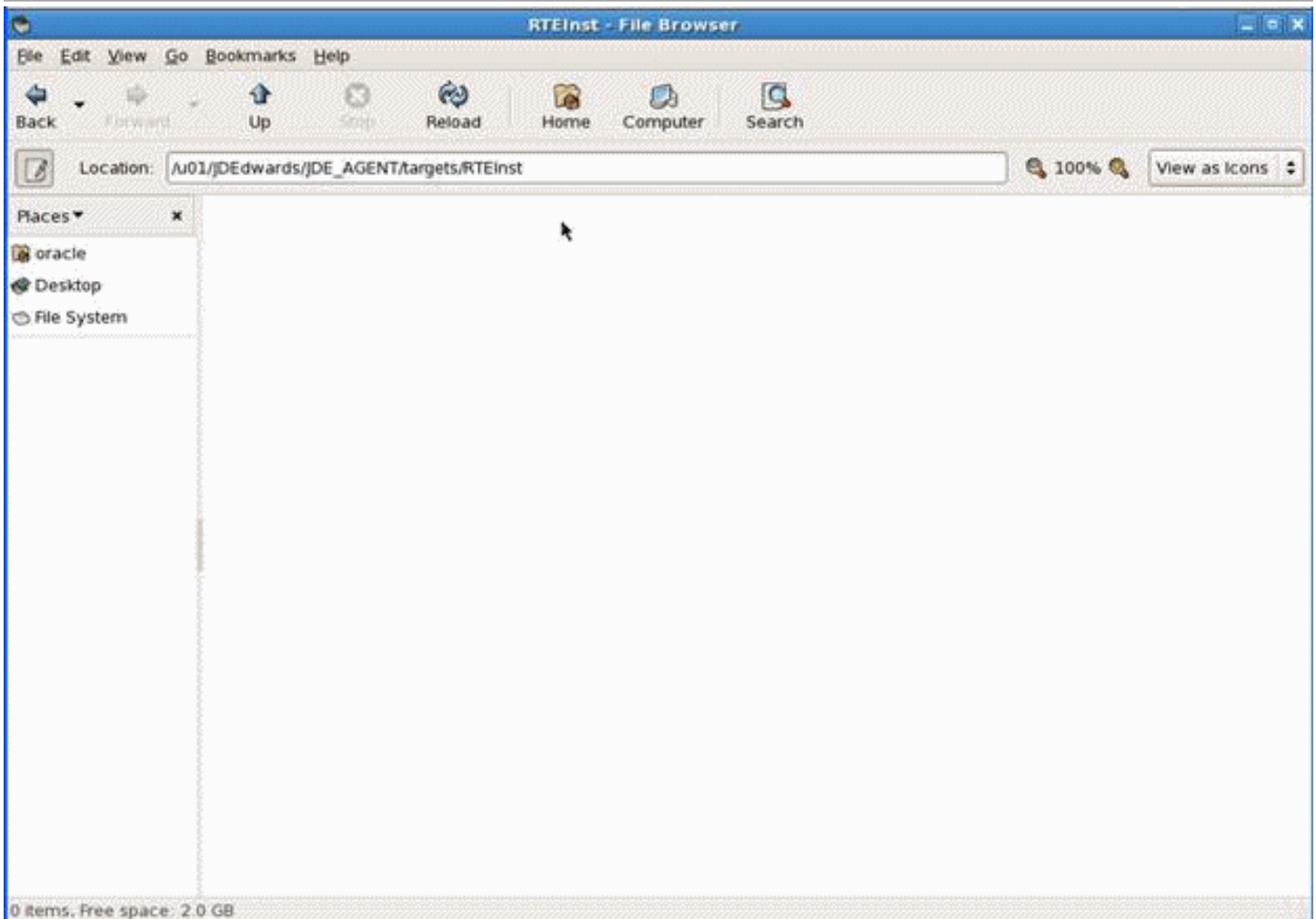

- e. Copy the config files from the vertical node machine to the horizontal node machine.

In the below example, the vertical node machine is dendell03 and the horizontal node machine is dnhpb12.

**Note:** If you are using UNIX or Linux machines, ensure you have the correct permissions for the new directory. For example: `chmod 777 -R JDEdwards`



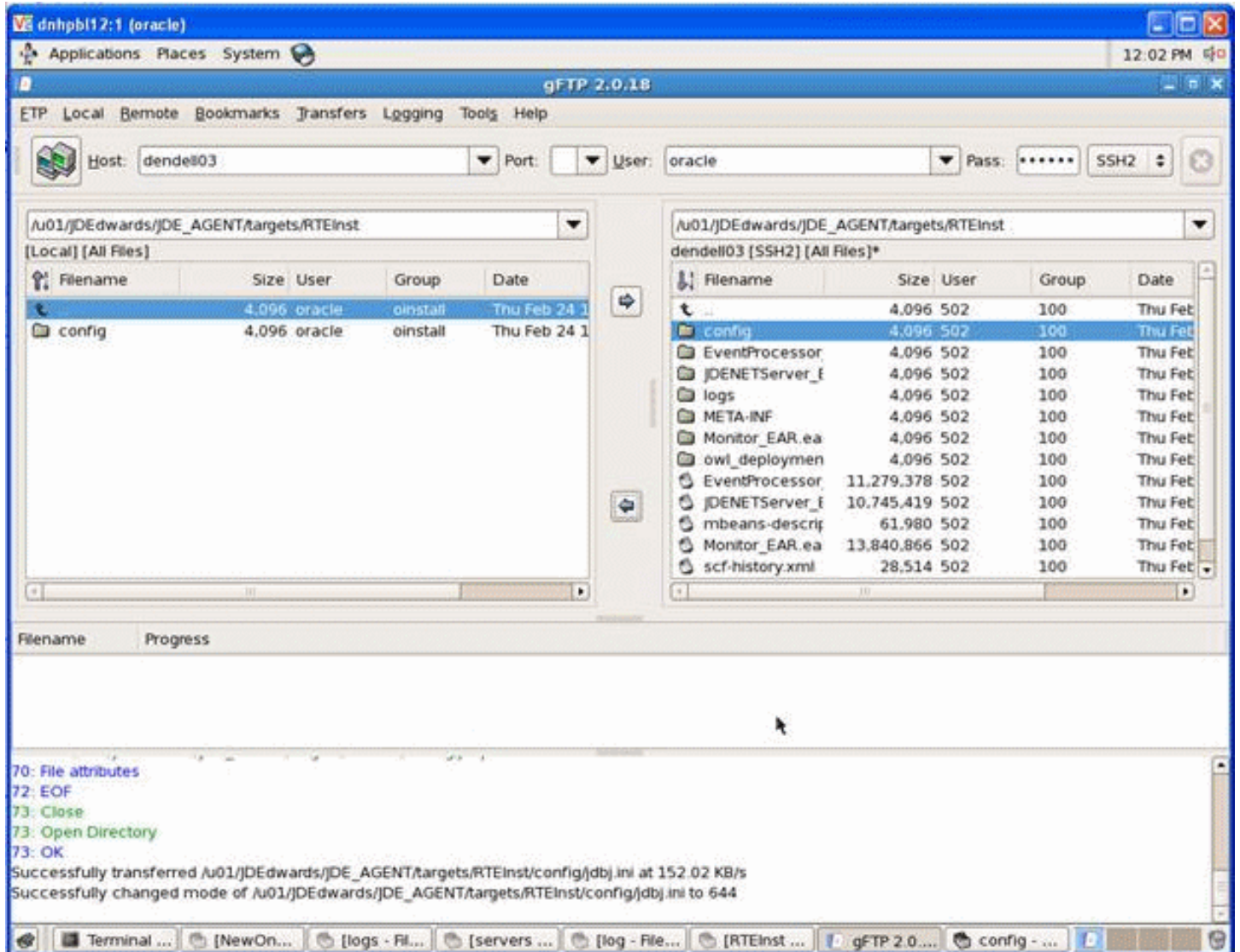



# 15 Appendix I - Setting Up SSL/TLS for Oracle WebLogic

## Setting Up SSL/TLS for Oracle WebLogic

Additional TLS setup includes the following:

In the Listen Port section:

1. Select the checkbox for **SSL Listen Port Enabled**.
2. Enter the value for the **SSL Listen Port**.

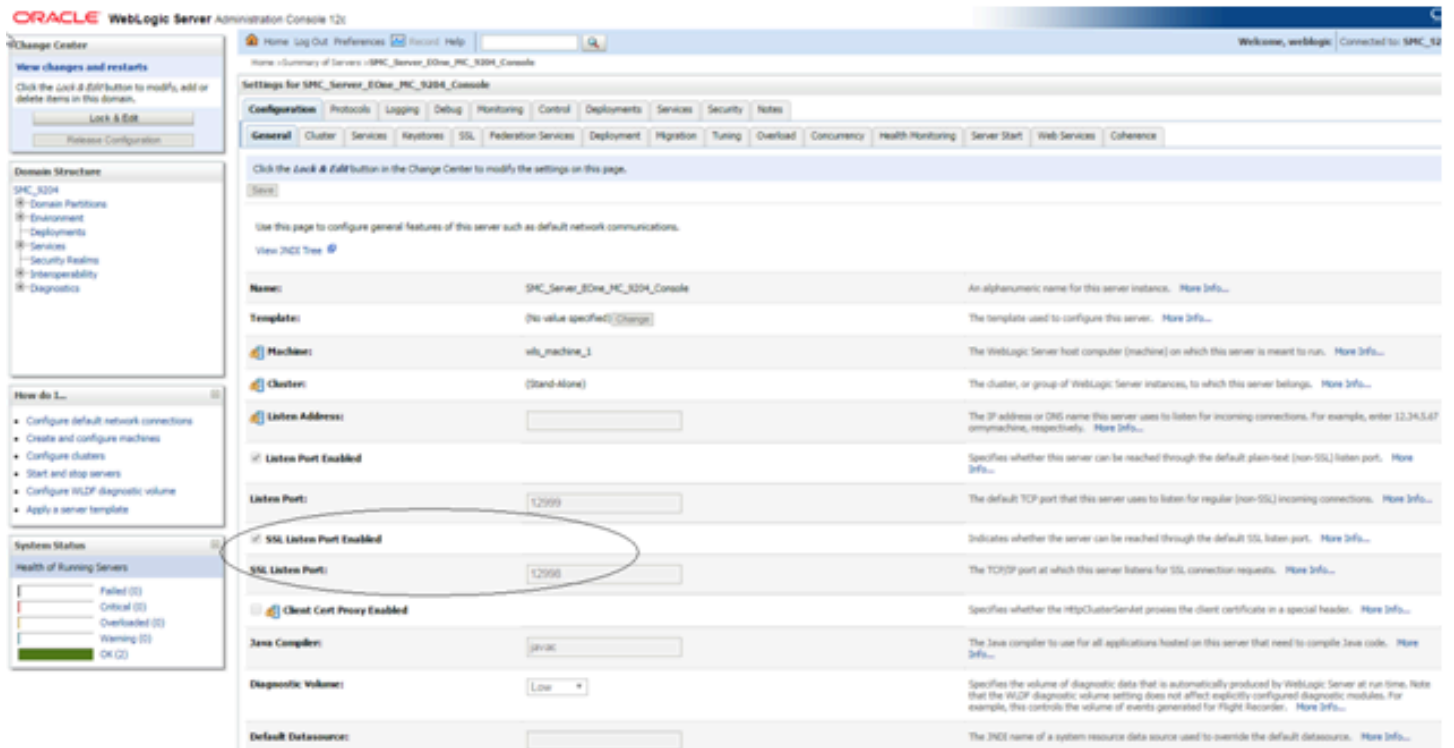

In the Private Key Location section:

1. Enter the value for the **Private Key Alias**.
2. Enter and confirm the value for the **Private Key Password**.

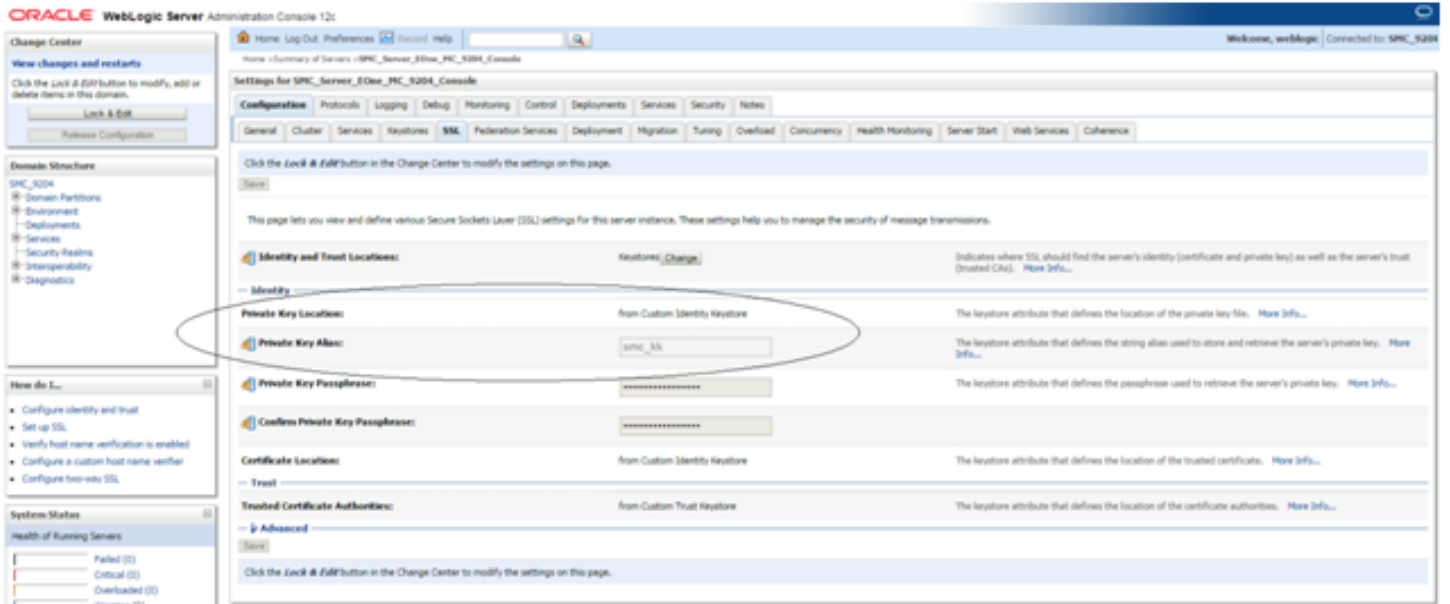

Fill out all Keystore fields for the **Identity** and **Trust** sections

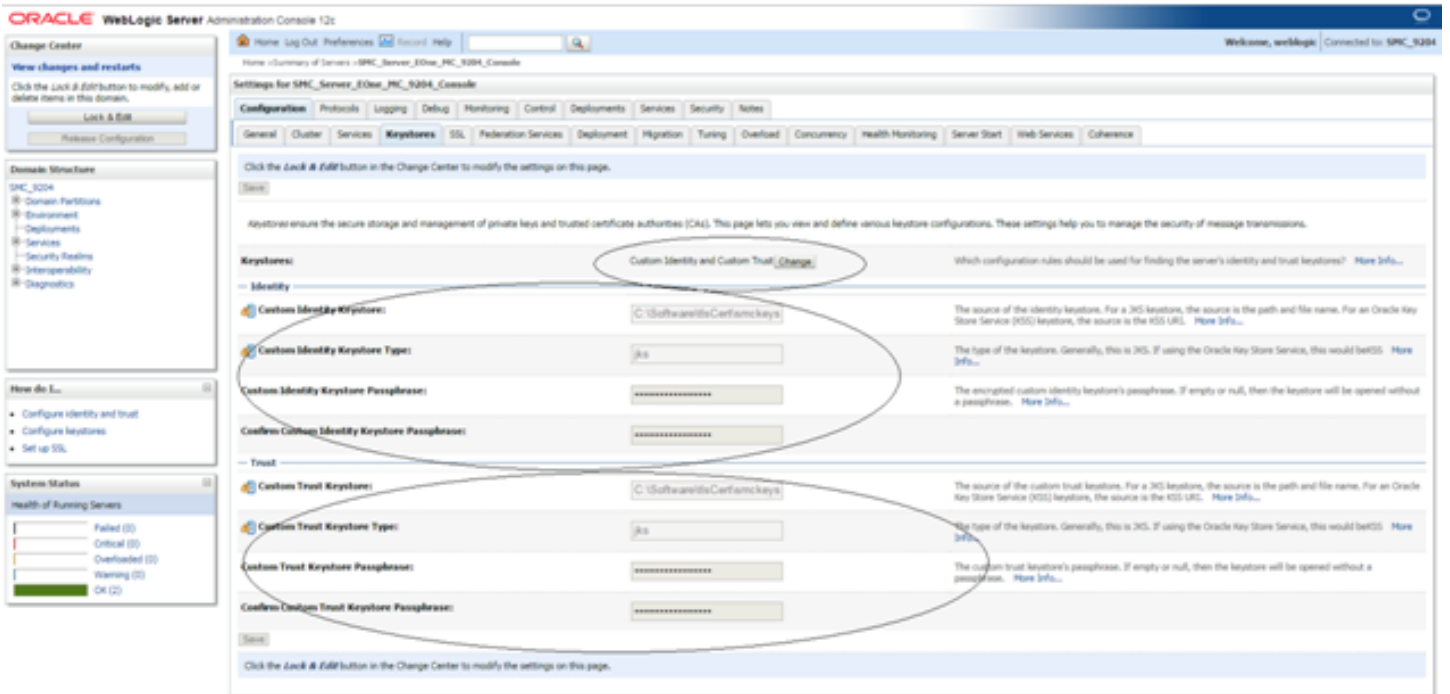

**Server Start Parameter:**

```
TLS flag: --Dweblogic.security.SSL.protocolVersion=TLS1  
-Dweblogic.http.headers.enableHSTS=true
```

For more information, see *Additional JVM Arguments*.

**Note:** If you plan to implement HTTP Strict Transport Security, refer to this Oracle document: *Command Reference for Oracle WebLogic Server 14c* in the section entitled: *HTTP Strict Transport Security*.

