

Oracle® Hyperion Profitability and Cost Management

User's Guide



11.2.16
F12855-06
January 2024

The Oracle logo, consisting of a solid red square with the word "ORACLE" in white, uppercase, sans-serif font centered within it.

ORACLE®

Copyright © 2008, 2024, Oracle and/or its affiliates.

Primary Author: EPM Information Development Team

This software and related documentation are provided under a license agreement containing restrictions on use and disclosure and are protected by intellectual property laws. Except as expressly permitted in your license agreement or allowed by law, you may not use, copy, reproduce, translate, broadcast, modify, license, transmit, distribute, exhibit, perform, publish, or display any part, in any form, or by any means. Reverse engineering, disassembly, or decompilation of this software, unless required by law for interoperability, is prohibited.

The information contained herein is subject to change without notice and is not warranted to be error-free. If you find any errors, please report them to us in writing.

If this is software, software documentation, data (as defined in the Federal Acquisition Regulation), or related documentation that is delivered to the U.S. Government or anyone licensing it on behalf of the U.S. Government, then the following notice is applicable:

U.S. GOVERNMENT END USERS: Oracle programs (including any operating system, integrated software, any programs embedded, installed, or activated on delivered hardware, and modifications of such programs) and Oracle computer documentation or other Oracle data delivered to or accessed by U.S. Government end users are "commercial computer software," "commercial computer software documentation," or "limited rights data" pursuant to the applicable Federal Acquisition Regulation and agency-specific supplemental regulations. As such, the use, reproduction, duplication, release, display, disclosure, modification, preparation of derivative works, and/or adaptation of i) Oracle programs (including any operating system, integrated software, any programs embedded, installed, or activated on delivered hardware, and modifications of such programs), ii) Oracle computer documentation and/or iii) other Oracle data, is subject to the rights and limitations specified in the license contained in the applicable contract. The terms governing the U.S. Government's use of Oracle cloud services are defined by the applicable contract for such services. No other rights are granted to the U.S. Government.

This software or hardware is developed for general use in a variety of information management applications. It is not developed or intended for use in any inherently dangerous applications, including applications that may create a risk of personal injury. If you use this software or hardware in dangerous applications, then you shall be responsible to take all appropriate fail-safe, backup, redundancy, and other measures to ensure its safe use. Oracle Corporation and its affiliates disclaim any liability for any damages caused by use of this software or hardware in dangerous applications.

Oracle®, Java, MySQL and NetSuite are registered trademarks of Oracle and/or its affiliates. Other names may be trademarks of their respective owners.

Intel and Intel Inside are trademarks or registered trademarks of Intel Corporation. All SPARC trademarks are used under license and are trademarks or registered trademarks of SPARC International, Inc. AMD, Epyc, and the AMD logo are trademarks or registered trademarks of Advanced Micro Devices. UNIX is a registered trademark of The Open Group.

This software or hardware and documentation may provide access to or information about content, products, and services from third parties. Oracle Corporation and its affiliates are not responsible for and expressly disclaim all warranties of any kind with respect to third-party content, products, and services unless otherwise set forth in an applicable agreement between you and Oracle. Oracle Corporation and its affiliates will not be responsible for any loss, costs, or damages incurred due to your access to or use of third-party content, products, or services, except as set forth in an applicable agreement between you and Oracle.

Contents

Documentation Accessibility

Documentation Feedback

Part I Getting Started with Profitability and Cost Management

1 About Profitability and Cost Management

Overview	1-1
Architecture	1-1
Essential Concepts	1-2
Modeling Process	1-2

2 Launching Profitability and Cost Management

3 Accessing Sample Models

4 Accessing Output Log Files

5 Profitability and Cost Management Applications

About Profitability and Cost Management Applications	5-1
Creating Profitability and Cost Management Applications	5-2
Management Ledger Profitability and Cost Management Applications	5-2
Detailed Profitability and Cost Management Applications	5-3
Common Tasks in Management Ledger Models	5-4
Using the Common Member Selector	5-4
Sorting Columns	5-5
Using Tree and Grid View Modes	5-6

Using Filters	5-7
Using the Find Feature	5-9
About Dimension Types	5-10

6 Profitability and Cost Management Dimensions

About Profitability and Cost Management Dimensions	6-1
Dimension Types	6-3
About Dimension Types	6-3
Profitability and Cost Management Business Dimensions	6-4
Profitability and Cost Management POV Dimensions	6-5
Profitability and Cost Management Attribute Dimensions	6-5
Profitability and Cost Management Alias Dimensions	6-6

Part II Working with Management Ledger Profitability

7 About Management Ledger Models and Scenarios

Management Ledger Model Elements	7-1
Steps to Design and Create Management Ledger Models	7-2
Management Ledger Workspace	7-2

8 Dimensions in Management Ledger Profitability Applications

About Management Ledger Dimensions	8-1
Management Ledger System Dimensions	8-2
Management Ledger Rule Dimension	8-3
Management Ledger Balance Dimension	8-4

9 Managing Management Ledger Models

About Managing Management Ledger Models	9-1
Working with the Management Ledger Model Summary	9-1
Reviewing Management Ledger Model System Information	9-2
Reviewing and Setting Management Ledger Model Level Preferences	9-3
Working with Management Ledger Points of View	9-5
About Management Ledger POVs	9-5
Management Ledger POV Dimensions	9-5
Managing Management Ledger Profitability POVs	9-6
Viewing the Management Ledger Points of View Manager Screen	9-6
Adding Management Ledger POVs	9-8

Modifying the Management Ledger POV State	9-8
Copying Management Ledger POVs	9-9
Clearing Selected Artifacts from Management Ledger POVs	9-10
Deleting Management Ledger POVs and All Artifacts	9-11
Importing Management Ledger Artifacts	9-11

10 Working with Management Ledger Allocations

About Management Ledger Allocations	10-1
Creating and Managing Management Ledger Allocations	10-2
About the Management Ledger Manage Rules Areas	10-2
Defining Global Contexts for Management Ledger Rules	10-3
Working with Rule Sets for Management Ledger POVs	10-5
Defining Management Ledger Rule Sets	10-5
Managing Management Ledger Rule Sets	10-7
Defining and Managing Management Ledger Rule Set Contexts	10-7
Defining and Managing Calculation Rules in Management Ledger Models	10-10
Creating Management Ledger Allocation Rules	10-10
Creating Management Ledger Custom Calculation Rules	10-20
Managing Management Ledger Rules	10-26
Tracing Management Ledger Profitability Allocations	10-27
About Tracing Management Ledger Allocations	10-27
Performing a Management Ledger Allocation Trace	10-29
Viewing Management Ledger Allocation Trace Results	10-29

11 Validating Management Ledger Models

About Management Ledger Model Validation	11-1
Creating and Managing Management Ledger Model Views	11-1
About Model Views	11-1
Creating Model Views	11-2
Managing Model Views	11-3
Rule Balancing for Management Ledger Profitability Application Validation	11-4
Viewing the Rule Balancing Task Area	11-5
Performing Rule Balancing Tasks	11-6
Performing Model Validation Analysis for Management Ledger Models	11-7

12 Managing and Calculating Management Ledger Models

Managing Management Ledger Databases	12-1
Management Ledger Database Deployment Process	12-1
Loading Data into Essbase	12-3

Calculating Management Ledger Models	12-5
Controlling the Allocation Rounding Precision for Management Ledger Calculations	12-8

13 Monitoring Management Ledger Job Status

About the Management Ledger Job Library	13-1
Management Ledger Job Library Job Types	13-1
Viewing the Management Ledger Job Library	13-2

14 Working with Management Ledger Queries and Reports

About Management Ledger Queries and Reports	14-1
Managing Smart View Queries in Management Ledger Profitability Applications	14-2
Creating Custom Smart View Queries in Management Ledger Profitability Applications	14-2
Running Management Ledger Profitability Queries	14-5
Running Custom Queries in Management Ledger Applications	14-5
Running Queries from the Management Ledger Rule Balancing Screen	14-5
Editing and Deleting Custom Queries in Management Ledger Profitability Applications	14-7
Creating and Using Management Ledger Reports	14-7
Generating Management Ledger System Reports	14-8
Management Ledger Program Documentation Report Example	14-9
Management Ledger Dimension Statistics Report Example	14-9
Management Ledger Rule Data Validation Report Example	14-10
Management Ledger Execution Statistics Report Example	14-11
Reporting Using Smart View with Management Ledger Profitability Applications	14-12

Part III Working with Detailed Profitability

15 About Detailed Profitability and Cost Management Models and Scenarios

Steps to Create Detailed Profitability Models	15-2
Detailed Profitability and Cost Management Workspace	15-3

16 Dimensions in Detailed Profitability and Cost Management Applications

About Detailed Profitability Dimensions	16-1
Detailed Profitability Dimension Types	16-3
Detailed Profitability Business Dimensions	16-3
MeasuresDetailed Dimension	16-3

17 Managing Detailed Profitability Models

About Managing Models	17-1
Working With Calculation Rules	17-2
Adding Calculation Rules	17-3
Modifying Calculation Rules	17-4
Deleting Calculation Rules	17-5
Copying Calculation Rules	17-5
Working with the Detailed Profitability Model Summary	17-6
Detailed Model System Information Tab	17-6
Selecting the Detailed Model Data Schema	17-7
Registering Detailed Profitability Model Data	17-9
Registering Model Data	17-11
Creating a New Model Data Registration	17-12
Modifying an Existing Model Data Registration	17-18
Copying an Existing Model Data Registration	17-19
Deleting an Existing Model Data Registration	17-19
Mapping Columns	17-20
Viewing Column Mappings	17-20
Modifying Column Mappings	17-21
Deleting Column Mappings	17-22
Joining Lookup Tables	17-22
Joining Tables to a Lookup Table	17-22
Editing Lookup Table Joins	17-24
Removing Lookup Table Joins	17-25
Reviewing Model Data Registration Summary	17-25
Managing Detailed Profitability Stages	17-26
Adding Detailed Profitability Model Stages	17-27
Modifying Detailed Profitability Model Stages	17-30
Deleting Detailed Profitability Model Stages	17-32
Working with Detailed Profitability Points of View	17-33
Detailed Profitability POV Dimensions	17-33
Detailed Profitability POV Status	17-34
Detailed Profitability Version Dimension	17-34
Managing Detailed Profitability POVs	17-34
Adding POVs	17-35
Modifying the POV Status	17-36
Copying POVs	17-37
Deleting POVs and All Artifacts	17-39

Deleting Selected Objects from POVs	17-40
Importing Detailed Profitability Staging Tables	17-41

18 Managing Detailed Profitability Allocations

About Detailed Profitability Allocations	18-1
Defining Drivers and Formulas for Detailed Profitability	18-2
Driver Formulas	18-2
Driver Priority Sequence	18-3
Defining Detailed Profitability Drivers	18-3
Working with Ratio-Based Drivers	18-4
Defining Ratio-Based Drivers	18-4
Modifying Ratio-Based Drivers	18-6
Deleting Ratio-Based Drivers	18-7
Working with Rate-Based Drivers	18-7
Defining Rate-Based Drivers	18-8
Modifying Rate-Based Drivers	18-11
Deleting Rate-Based Drivers	18-11
Working with Calculated Measure Drivers	18-12
Defining Calculated Measure Drivers	18-12
Modifying Calculated Measure Drivers	18-13
Deleting Calculated Measure Drivers	18-14
Working with Detailed Profitability Drivers	18-14
Creating Duplicate Drivers	18-15
Selecting Detailed Profitability Drivers	18-16
Creating Detailed Profitability Driver Selections for a Single Intersection	18-17
Deleting Detailed Profitability Driver Selections	18-19
Deleting Detailed Profitability Driver Selections for One Intersection	18-19
Working with the Bulk Editor	18-20
Adding a Single Driver to Multiple Source Stage Rules	18-20
Removing Drivers from Multiple Source Stage Rules	18-23
Adding Assignment Rule to Multiple Source Stage Rules	18-24
Removing Assignment Rules from Multiple Source Stage Rules	18-25
Working with Detailed Profitability Assignment Rules	18-27
Creating Assignment Rules	18-27
Duplicating Detailed Profitability Assignment Rules	18-28
Modifying Assignment Rules	18-29
Deleting Assignment Rules	18-29
Working with Assignments in Detailed Profitability	18-30
Creating Assignments	18-30

19 Calculating Detailed Profitability Models

Managing Detailed Profitability Databases	19-1
Deploying Detailed Profitability Reporting Views	19-1
Deploying Detailed Profitability Source Stage Database	19-3
Deploying Detailed Profitability Contribution Database	19-5
Deploying Detailed Profitability Destination Stage Database	19-7
Managing Detailed Profitability Calculations	19-9
Calculating Detailed Profitability Models	19-9
Driver Operation Types	19-12
Other Process Types	19-12

20 Validating Detailed Profitability Models

About Detailed Profitability Validation	20-1
Detailed Profitability Model Validation Rules	20-2
Validating Detailed Profitability Model Structure	20-2

21 Creating Detailed Profitability Reports

Detailed Profitability Stage Balancing Report	21-1
Idle Capability	21-2
OverDriven Values	21-2
Unassigned Values	21-2
Generating the Detailed Profitability Stage Balancing Report	21-3
Detailed Profitability Level 0 Contribution Report	21-4
Generating the Level 0 Contribution Report	21-5
Running Detailed Profitability System Reports	21-5
Detailed Profitability Dimension Statistics Report Example	21-6
Detailed Profitability Execution Statistics Report Example	21-6

22 Monitoring Detailed Profitability Job Status

Job Library	22-1
Job Library Job Types	22-1
Viewing the Job Library	22-2
Managing Detailed Profitability Task Flows	22-3
Viewing Detailed Profitability Task Flow Information	22-5
Viewing Detailed Profitability Task Flow Status	22-6
Viewing Detailed Profitability Task Details	22-8

A Working with Standard Profitability and Cost Management Applications

Getting Started with Standard Profitability and Cost Management	A-1
Architecture	A-2
Modeling Process	A-2
Launching Profitability and Cost Management	A-3
About Standard Profitability and Cost Management Applications	A-3
Comparison between Standard and Detailed Profitability Applications	A-4
Common Tasks	A-5
Using the Common Member Selector	A-6
Sorting Columns	A-7
Using Tree and Grid View Modes	A-7
Using Filters	A-8
Using the Find Feature	A-10
About Profitability and Cost Management Dimensions	A-11
Copying Standard Profitability POVs	A-13
Alias Dimensions for Standard Profitability and Cost Management	A-15
About Standard Profitability Models and Scenarios	A-15
Overview of Standard Profitability Models	A-15
Steps to Create Standard Profitability Models	A-17
Standard Profitability Workspace	A-18
Dimensions in Standard Profitability Applications	A-20
About Dimensions in Standard Profitability and Cost Management Applications	A-20
Standard Profitability Measures Dimension	A-21
Standard Profitability Driver Measures	A-22
Standard Profitability Reporting Measures	A-23
Standard Profitability Cost Layer Allocation Measures	A-25
Standard Profitability Revenue Layer Allocation Measures	A-27
Standard Profitability AllocationType Dimensions	A-30
Cloned Standard Profitability Dimensions	A-31
Managing Standard Profitability Models	A-32
About Managing Standard Profitability Models	A-32
Working with the Standard Profitability Model Summary	A-33
System Information Tab	A-33
Setting Model Level Preferences	A-34
Setting Standard Profitability Model Stages	A-36
Adding Model Stages	A-37
Modifying Model Stages	A-40
Deleting Model Stages	A-41

Working with Standard Profitability Points of View	A-42
Standard Profitability POV Status	A-42
Managing Standard Profitability POVs	A-42
Adding Standard Profitability POVs	A-43
Modifying the Standard Profitability POV Status	A-44
Copying Standard Profitability POVs	A-45
Deleting Selected Objects from Standard Profitability POVs	A-47
Deleting Standard Profitability POVs and All Artifacts	A-48
Querying Standard Profitability Model Statistics	A-49
Importing Standard Profitability Data and Artifacts	A-51
Managing Standard Profitability Allocations	A-52
About Standard Profitability Allocations	A-53
Standard Profitability Cost and Revenue Layers	A-53
Defining Drivers and Formulas for Standard Profitability Models	A-54
Driver Formulas	A-55
Defining Drivers	A-61
Modifying Driver Definitions	A-65
Creating New Driver Definitions From Existing Driver Definitions	A-66
Deleting Driver Definitions	A-67
Selecting Standard Profitability Drivers	A-67
Creating Driver Selections	A-68
Creating Driver Selections for a Single Intersection	A-69
Modifying Driver Selections	A-71
Modifying Driver Selections for a Single Intersection	A-71
Deleting Driver Selections	A-72
Deleting Driver Selections for a Single Intersection	A-72
Working with Standard Profitability Assignments	A-73
Types of Assignments	A-73
Creating Assignments	A-74
Modifying Assignments	A-78
Deleting Assignments	A-79
Working with Standard Profitability Assignment Rules	A-79
Using the Assignment Rule Wizard	A-80
Using the Assignment Rule Definition Screen	A-92
Deleting Assignment Rule Definitions	A-101
Using the Data Entry Window	A-101
Standard Data Entry Views	A-102
Creating Custom Edit Views	A-103
Editing Data Manually	A-106
Editing Stage Data	A-106
Editing Driver Data	A-106

Deleting Edit Views	A-107
Tracing Allocations	A-107
Tracing Allocation Detail	A-108
Tracing Allocation Flow	A-112
Reciprocal Allocation	A-116
Exporting Trace Allocation Images	A-117
Validating Standard Profitability Models	A-117
About Validation	A-118
Model Structure Validation Rules	A-118
Unassigned Values	A-119
Example 1 — Flow Stops	A-119
Example 2 — Residual Value	A-120
Idle Capability	A-121
OverDriven Costs and Revenue	A-122
Validating Model Structure	A-122
Generating the Stage Balancing Report	A-125
Generating the Driver Data Report	A-127
Calculating Standard Profitability Models	A-130
About Calculating Standard Profitability Models	A-130
Managing Databases	A-131
Deploying the Calculation Database	A-131
Deploying Reporting Databases	A-134
Managing Calculations	A-136
Calculation (Calc) Scripts	A-137
Calculating Direct Allocation Data	A-137
Transferring Data	A-139
Genealogy Data	A-140
Calculating Multistage Contribution Paths in Genealogy	A-141
Monitoring Standard Profitability Job Status	A-143
Job Library	A-143
Job Library Job Types	A-144
Viewing the Job Library	A-145
Managing Task flows	A-146
Viewing Task flow Information	A-148
Viewing Task Flow Status	A-149
Viewing Task Details	A-151
Scheduling Task Flows	A-152
Running Standard Profitability Reports	A-155
About Running Reports for Standard Profitability Models	A-155
Essbase Outlines and Reporting	A-156
Reporting on Stage Data	A-157

Reporting on Direct Allocations	A-158
Reporting on Allocation Genealogy	A-159
Running Standard Profitability System Reports	A-160
Standard Profitability Genealogy Statistics Report Example	A-161
Standard Profitability Dimension Statistics Report Example	A-161
Standard Profitability Execution Statistics Report Example	A-162
Reporting Using Smart View	A-162
Managing Smart View Queries in Standard Profitability	A-163
Creating Custom Queries	A-164
Editing Custom Queries	A-168
Duplicating Smart View Queries	A-172
Deleting Custom Smart View Queries	A-172
Running Queries from the Stage Balancing Screen	A-173

Documentation Accessibility

For information about Oracle's commitment to accessibility, visit the Oracle Accessibility Program website at <http://www.oracle.com/pls/topic/lookup?ctx=acc&id=docacc>.

Access to Oracle Support

Oracle customers that have purchased support have access to electronic support through My Oracle Support. For information, visit <http://www.oracle.com/pls/topic/lookup?ctx=acc&id=info> or visit <http://www.oracle.com/pls/topic/lookup?ctx=acc&id=trs> if you are hearing impaired.

Documentation Feedback

To provide feedback on this documentation, click the feedback button at the bottom of the page in any Oracle Help Center topic. You can also send email to epmdoc_ww@oracle.com.

Part I

Getting Started with Profitability and Cost Management

Related Topics

- [About Profitability and Cost Management](#)
- [Launching Profitability and Cost Management](#)
- [Accessing Sample Models](#)
- [Accessing Output Log Files](#)
- [Profitability and Cost Management Applications](#)
- [Profitability and Cost Management Dimensions](#)

1

About Profitability and Cost Management

Related Topics

- [Overview](#)
To maximize profitability, a business must be able to accurately measure, allocate, and manage costs and revenue.
- [Architecture](#)
Oracle Hyperion Profitability and Cost Management runs on top of Oracle Essbase and uses other related software to handle and calculate a variety of data.
- [Essential Concepts](#)
To use Oracle Hyperion Profitability and Cost Management, you must understand several essential concepts.
- [Modeling Process](#)
Before you can build a model, the dimensions and members must be defined using the Profitability Applications Console to build the database outline, or main objects within each stage of the model.

Overview

To maximize profitability, a business must be able to accurately measure, allocate, and manage costs and revenue.

Oracle Hyperion Profitability and Cost Management is an analytic software tool that manages the cost and revenue allocations that are necessary to compute profitability for a business segment, such as a product, customer, region, or branch. Profitability and Cost Management enables you to use cost decomposition, consumption-based costing and scenario-playing to measure profitability for effective planning and decision support.

Profitability and Cost Management is accessed through Oracle Hyperion Enterprise Performance Management Workspace. As the Web client for Profitability and Cost Management, EPM Workspace enables you to access and interact with other installed software, including the following:

- Oracle Hyperion Planning
- Oracle Hyperion Reporting and Analysis
- Oracle Hyperion Financial Management
- Third-party applications, such as Microsoft Excel

Architecture

Oracle Hyperion Profitability and Cost Management runs on top of Oracle Essbase and uses other related software to handle and calculate a variety of data.

The architecture for Detailed Profitability and Cost Management models include relational database data in addition to Essbase data. In Management Ledger models, calculation and reporting data are contained in a single ASO cube.

Essential Concepts

To use Oracle Hyperion Profitability and Cost Management, you must understand several essential concepts.

- **Dimensions**—Data categories used to organize data for retrieval and preservation of values. Dimensions usually contain hierarchies of related **members** grouped within them. For example, a Year dimension often includes members for each time period, such as quarters and months.
- **Applications**—Related sets of dimensions and dimension members that are used to meet a specific set of analytical or reporting requirements.
- **Models**—Applications with analytical structures created in Profitability and Cost Management that apply allocation logic to dimensions and members. They include cost allocation stages and drivers to reflect existing or proposed business cases.

[Modeling Process](#) describes the relationships among these components.

Modeling Process

Before you can build a model, the dimensions and members must be defined using the Profitability Applications Console to build the database outline, or main objects within each stage of the model.

The financial and other data required for allocation are imported to an Oracle Essbase multidimensional database for Management Ledger, and from a preexisting relational database for Detailed Profitability.

After dimensions are defined, you can build a customized model in Oracle Hyperion Profitability and Cost Management that represents the network of allocations required for the products or services.

Within the model, assigned drivers specify how data is calculated, using standard or customized formulas. Assignments control the flow of calculations, to accurately reflect the allocation of costs and revenues, and to determine profitability. The model is validated for structure and integrity. Using the model, you calculate imported financial data, and produce performance metrics and profitability reports.

After a valid model is created, you can use it to create different versions or scenarios of the original model, enabling you to evaluate the impact of the proposed changes on the bottom line.

Requirements analysis is an important part of designing applications and models. See [Steps to Design and Create Management Ledger Models](#), and [Steps to Create Detailed Profitability Models](#) for more detailed overviews of the modeling process.

Security roles determine what tasks you can perform within Profitability and Cost Management. For example, not all users are able to create applications, although most can create models. For questions about security, check with a systems administrator.

See the following sections for information about getting started with Profitability and Cost Management:

- [Profitability and Cost Management Applications](#)
- [Launching Profitability and Cost Management](#)

- [Accessing Output Log Files](#)

If Profitability and Cost Management has just been installed, an application must be created before models can be built. For more information, see [Creating Profitability and Cost Management Applications](#)..

2

Launching Profitability and Cost Management

Oracle Hyperion Profitability and Cost Management can be accessed only through Oracle Hyperion Enterprise Performance Management Workspace.

To access Profitability and Cost Management:

1. Ensure the following software components have been configured, started and are running:

- EPM Workspace
- Oracle Hyperion Shared Services
- Profitability and Cost Management

Contact the Administrator for assistance if any other required software is not available.

2. In the Web browser, access the EPM Workspace Web page.

By default, the URL is `http://SERVER_NAME:19000/workspace/`.

 **Note:**

If the installation is customized, the port number may change.

3. Enter the EPM Workspace user name and password.

 **Note:**

Both the user name and password are case-sensitive.

4. Click **Log On**.

The main EPM Workspace page is displayed.

5. On the EPM Workspace main menu, select **Navigate**, then **Applications**, then **Profitability**, and then select the model you want to view.

3

Accessing Sample Models

A sample application is available in the product installation which is used for testing and self-led exploration of functional areas. The sample application includes a small data set and a fully built out model that illustrates various uses of drivers, assignments, and assignment rules.

Oracle Hyperion Enterprise Performance Management System Lifecycle Management extracts and data files are provided to support importing the model metadata, allocation artifacts, and cost and driver data. Oracle Essbase .otl files are also included as an alternative to the Lifecycle Management extracts. These files are used to create Essbase dimension master cubes to use with the new Application Manager feature to create the sample applications. See the Oracle Fusion Performance Management Sample Models Readme file for details on how to use these files.

You can find the Performance Management Sample Models Readme.docx file at this location:

```
%EPM_ORACLE_HOME%\products\Profitability\samples
```

You can find the appropriate sample application files in the following locations:

- For Management Ledger Profitability models:

```
%EPM_ORACLE_HOME%\products\Profitability\samples\BksML12
```

 **Note:**

For your convenience in setting up the Management Ledger sample model, flat files are provided for each dimension in the model. To load them and build the model, see Appendix B of the *Oracle Hyperion Profitability and Cost Management Administrator's Guide*.

- For Detailed Profitability models:

```
%EPM_ORACLE_HOME%\products\Profitability\samples\BksDP30
```

 **Note:**

The Detailed Profitability sample model is large, and it may take up to an hour to calculate.

4

Accessing Output Log Files

The following log files are available for information concerning Oracle Hyperion Profitability and Cost Management:

Table 4-1 Profitability and Cost Management Log Files

Log File	Description
hpcm.log	<p>The name of the current log file. The system keeps copies of previous log files (historical log files).</p> <p>Profitability and Cost Management generates an application, server-side log file that collects application-specific messages that are sent from the application or server.</p> <p>By default, the log files are available at C:\oracle\Middleware\user_projects\domains\EPMSys\servers\Profitability0\logs.</p>
SharedServices_Security_Client.log	<p>The name of the current log file. The system keeps copies of previous log files (historical log files).</p> <p>A Oracle Hyperion Shared Services Client-side log file provides details regarding the Profitability and Cost Management handshake with Common Security Services.</p> <p>By default, the log file is available at C:\oracle\Middleware\user_projects\domains\EPMSys\servers\Profitability0\logs.</p>

Contact the system administrator for access to these log files.

For additional log files for related products and applications, see the *Oracle Enterprise Performance Management System Installation and Configuration Guide*.

5

Profitability and Cost Management Applications

Related Topics

- [About Profitability and Cost Management Applications](#)
Oracle Hyperion Profitability and Cost Management offers two different types of applications that are used in different ways.
- [Creating Profitability and Cost Management Applications](#)
Oracle Hyperion Profitability and Cost Management is an integral part of Oracle Hyperion Enterprise Performance Management Workspace, and uses common software to manage data and security.
- [Management Ledger Profitability and Cost Management Applications](#)
Management Ledger applications are designed for use by analysts who have deep domain experience in the computation and reporting methods of management reporting, but who may not have much experience with Oracle Essbase and scripting syntax or programming languages.
- [Detailed Profitability and Cost Management Applications](#)
A Detailed Oracle Hyperion Profitability and Cost Management model employs a user-defined schema to organize relational tables with existing data and associated lookup tables to extend that data.
- [Common Tasks in Management Ledger Models](#)
- [About Dimension Types](#)
The specific characteristics of the dimension type manage the behavior and functions of the dimension.

About Profitability and Cost Management Applications

Oracle Hyperion Profitability and Cost Management offers two different types of applications that are used in different ways.

- [Management Ledger Profitability and Cost Management Applications](#) offers management reporting and modeling with data structured similarly to users' Oracle General Ledger or Oracle Hyperion Financial Management implementations. Allocations and other calculations required for management reporting outputs are performed using a freeform approach.
- [Detailed Profitability and Cost Management Applications](#) provides a single step allocation of pools or rates to profit objects to a single source and destination, for the purpose of analyzing profitability. Detailed Profitability utilizes a relational database for model artifact storage, calculations, and reporting views.

Creating Profitability and Cost Management Applications

Oracle Hyperion Profitability and Cost Management is an integral part of Oracle Hyperion Enterprise Performance Management Workspace, and uses common software to manage data and security.

After installation, an administrator or user with appropriate security provisioning must perform a number of steps to create the first Profitability and Cost Management application. After the application is created, data or data definitions must be imported into Profitability and Cost Management. This first application is created using the Profitability Application Console with Oracle Essbase to create Profitability and Cost Management applications.

For information about creating applications using these tools, see Appendix A, *Creating the First Profitability and Cost Management Application after Installation*, and Appendix B, *Creating Profitability and Cost Management Applications Using the Profitability Applications Feature*, in the *Oracle Hyperion Profitability and Cost Management Administrator's Guide*.

Note:

It can take several seconds to open a Profitability and Cost Management application, especially after restarting the Profitability and Cost Management service. With the Chrome and Edge Chromium browsers, this can result in a pop-up message that the pages are not responding, with an option to wait or to exit the pages. This message can be ignored – the pages will eventually open as expected.

Management Ledger Profitability and Cost Management Applications

Management Ledger applications are designed for use by analysts who have deep domain experience in the computation and reporting methods of management reporting, but who may not have much experience with Oracle Essbase and scripting syntax or programming languages.

The data for Management Ledger applications is housed in both Essbase multidimensional databases and relational databases. You create applications in the Profitability Applications Console, and define the hierarchy of accounts, activities, and operations within the organization using dimensions and dimension members.

After the application is deployed, you build the model to show the flow of funds to specific cost and revenue allocations. Both the source and destination ranges of allocations are defined as calculation rules using the Oracle Hyperion Profitability and Cost Management user interface. As for Management Ledger and Detailed Profitability application types, points of view (POVs) represent a specific instance of the model, and can be used to view or calculate different versions of a model; for example, to view values for different months or quarters, to compare budget versus actual figures, or to play scenarios to measure the impact of various changes on the bottom line.

In Management Ledger models, there is no concept of stages or layers. All structure is controlled through the organization of rule sets and rules under POVs. For each POV, calculation rules are organized into groups that run against the same or similar region of the database and at the same or similar time. These groups are called rule sets. They determine the order in which calculation rules run. Calculation rules can inherit default member selections from the POV or rule set level so users can define a region of the database once and use it many times without having to specify it each time. These defaults are called "contexts".

The model is validated after creation to ensure that all allocations have been accounted for, and calculations are balanced. Following validation, you deploy the database, and then calculate the model, and analyze the results.

For more information, see [Management Ledger Model Elements](#).

Detailed Profitability and Cost Management Applications

A Detailed Oracle Hyperion Profitability and Cost Management model employs a user-defined schema to organize relational tables with existing data and associated lookup tables to extend that data.

Data for the Detailed Profitability and Cost Management model is housed in relational databases only.

You create the model in the Profitability Applications Console, and define the business dimensions, aliases, measures, and so on within the organization. Within Profitability and Cost Management, the data is mapped to the application to enable you to build the Detailed Profitability model. The application can handle extremely large volumes.

The application does not use a hierarchical structure, but processes all allocations in a flow between a single Source and Destination combination. Allocation is handled through a restricted MeasuresDetailed dimension, rather than by creating an AllocationType.

The MeasuresDetailed dimension contains a limited set of members to process all allocations.

After the application is deployed to Detailed Profitability and Cost Management, you build the model, creating the drivers and assignments that generate the flow of funds. The models are constructed using a single Source and Destination table combination for selected Measures, with up to five Source dimensions, and up to 25 Destination dimensions. The allocations are completed based on calculations and formulas that you specify in the drivers and assignments.

Points of View (POVs) represent a specific instance of the model, and can be used to view or calculate different versions of a model; for example, to view values for different months or quarters, to compare budget versus actual figures, or to play scenarios to measure the impact of various changes on the bottom line.

The model is validated after creation to ensure that all allocations are accounted for, and that calculations are balanced for each stage.

The model can be calculated, and the results analyzed.

For more information about creating and working with Detailed Profitability applications, see [Steps to Create Detailed Profitability Models](#).

Common Tasks in Management Ledger Models

Related Topics

- [Using the Common Member Selector](#)
- [Sorting Columns](#)
- [Using Tree and Grid View Modes](#)
- [Using Filters](#)
- [Using the Find Feature](#)

Using the Common Member Selector

The Common Member Selector enables you to quickly select and filter dimension members. The selector dialog box is available from several locations within the application, including Driver Selections.

The name of the selected dimension is listed at the top of the selector dialog box, and all available members for the selected dimension are listed in a tree or grid format.

To select members from the Common Member Selector:

1. From the application, click **Selector**  or **Add** .

The Select Member dialog box opens, showing all available members.

2. Expand the member list, and select the member.

To search for a member, type the member name in the text box at the bottom of the dialog box and click the Search button .

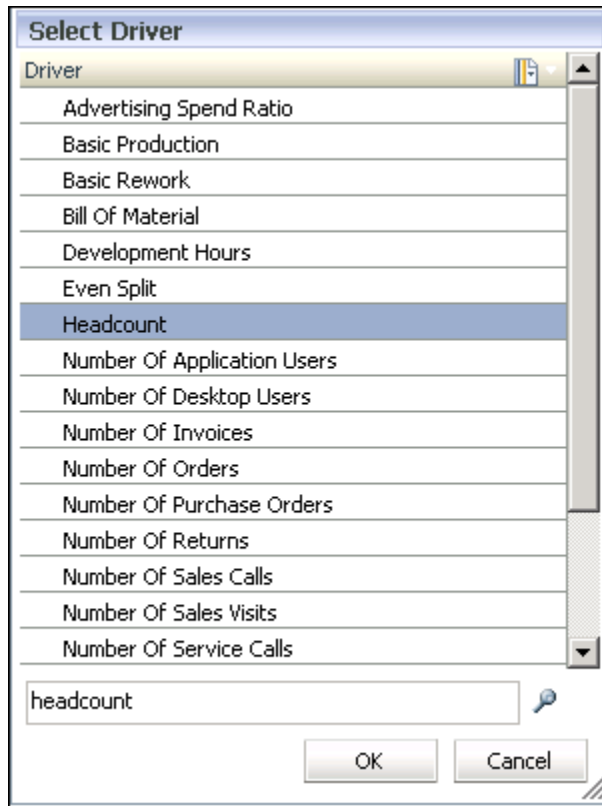

3. **Optional:** To filter or modify the display of members, click **Context Menu** , and select one or more options:
 - **Show Tree** displays members for the selected dimension in an expandable hierarchy.
 - **Show Grid** displays all members for the selected dimension in a flat, sequential list. This view mode must be selected if you want to filter members.
 - **Show Alias** displays the member aliases, or alternate names for members and shared members.
 - **Show Name** displays the member names.
 - **Filter** is used to filter members.
 - **Sort** to select the filter to display the members in ascending, descending or default order.

See [Using Filters](#).

4. Click **OK**.

The selected member is displayed in the required field.

Sorting Columns

Depending on the screen you are viewing, two methods are available for sorting columns:

- Using the Member Selector (on the Driver Definitions, Driver Selections, Assignments, and Data Entry screens)

- Clicking the column header (Assignments Destinations, Driver Exceptions tab, and Manage Task Flows)

To sort using the Member Selector:



1. On the screen, click the Member Selector  at the top of the column that you want to sort.
2. From the drop-down list, select **Show Grid**.

This step removes the hierarchical format to enable sorting.

3. On the screen, click the Member Selector  again, and choose the sort option that you require:
 - Ascending (from lowest to highest)
 - Descending (from highest to lowest)
 - Default (as displayed in the Oracle Essbase database)

The list is redisplayed using the selected sort option.

To sort using the Column Header:

1. On the screen, double-click the column header to display the sort icon:
 - **Ascending sort** 
 - **Descending sort** 
2. Double-click the column header to toggle between sort options.

Using Tree and Grid View Modes

When editing data, you can toggle between two viewing modes to view dimensions and their members:

- Tree View displays dimensions and members in an expandable hierarchy.

A
[-] A1
A11
A12
A13
A14

- Grid View displays the Level 0 members for the selected dimension in a sequential list. The Grid View mode is required to filter dimension members, drivers or measures.

A
A11
A12
A13
A14

To change view modes:

1. At the top of the dimension column on the data entry screen, click **Context Menu**  for the dimension for which you want to change the view mode.
2. Select the required view mode:
 - Select **Show Tree** to display dimensions and their members in an expandable hierarchy.
 - Select **Show Grid** to display the Level 0 members for the selected dimension in a sequential list. The Grid View mode is required to filter dimension members, drivers, or measures.

Using Filters

Filters are available to refine long lists of members to present only those that meet the filter criteria. The Filter is available on screens that require selections from multiple options, such as Driver Selections, Assignments, Data Entry, and so on.

- When entering a search value in a filter, enter the entire string if the filters are Attribute-based or UDA-based.
- If you require a wildcard at the beginning of a filter, only question marks can be used, as in "?ac".
- Trailing wildcard symbols, such as asterisks (*) and question marks (?) are supported in assignment rule name and alias filters. For example, enter "B*" to filter members having names or aliases beginning with the letter "B".

Note:

You cannot use an asterisk at the beginning or within a filter for assignment rules, such as "*B" or "B*a".

Using the Filter dialog box, you build the filter in this format:

```
<Member Name> <Operation> <Value> <Condition>
```

If the filter contains more than one statement, the Condition appends additional statements using an AND or OR condition. Brackets for each statement are automatically inserted, and the filters are resolved from left to right.

To filter dimensions and members:

1. Click **Member Selector** .
2. On the Filter drop-down list, select **Show Grid**.

The list is changed to a grid format, and the Filter option is activated.

3. On the Filter drop-down list, select **Filter** .

The Filter dialog box is displayed.

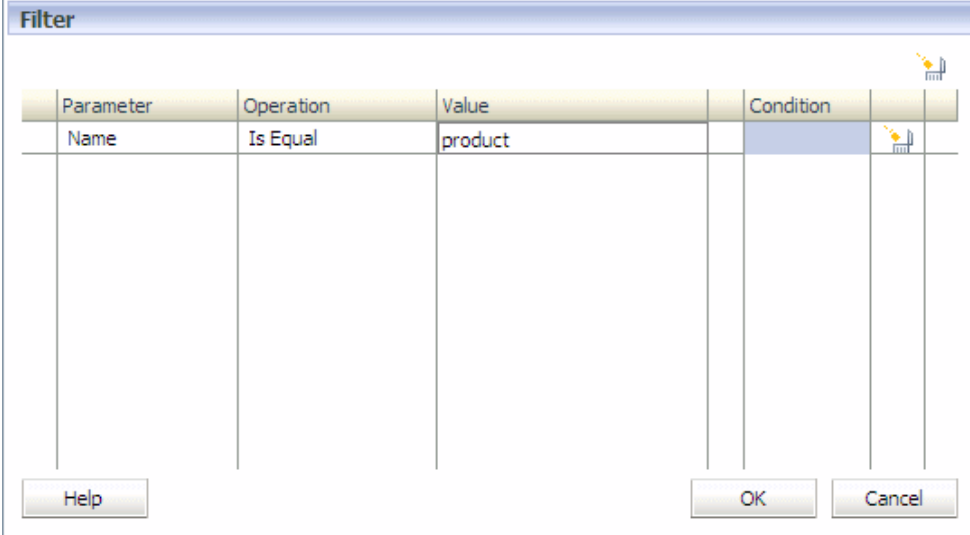

Parameter	Operation	Value	Condition
Name	Is Equal	product	

4. Under **Parameter**, click the cell to display the drop-down list of available parameters, and select the parameter to be filtered:
 - **Name:**
 - Displays Member Name if "Show Name" mode is selected.
 - Displays Alias Name if "Show Alias" mode is selected.

 **Note:**

The Detailed Profitability assignment rule matches only on name or alias depending on the type of filter created. If you create a filter on "Name" it matches members only by their name and if you create a filter on "Alias" it matches members only by their alias.

- **Attribute** (Attribute, if available)
 - **UDA** (User-Defined Attribute, if available)
5. Under **Operation**, select the appropriate filter:
 - **Is Equal**
 - **Not Equal**

 **Note:**

Both the EQUAL and NOT EQUAL operations are currently supported to filter Names, Aliases and Attributes.

Only the Is Equal operation is currently supported for UDAs.

When "Name" is selected as the parameter, matching is performed on both names and aliases.

6. Under **Value**, click the cell and select the filter value:
 - For **Name**, enter the value or text. Matching is performed on both names and aliases.
 - For **Attributes** or **UDA** dimensions, select the member from the drop-down list of values for the selected Attribute or UDA dimension.
7. **Optional:** If more than one filter statement is to be added, under **Condition**, select the condition governing the filter:
 - AND
 - OR
8. **Optional:** Repeat for each additional filter.
9. Click **OK**.

The filter is applied to display only those members that meet the filter criteria.

Using the Find Feature

The Find feature enables you to locate a single member in a list of members.

The Find feature is available on screens that require selections from multiple options, such as Driver Definitions, Driver Selections, Assignments, Data Entry, and so on. Each Find field is attached to the column in which it resides and can be used only in one column at a time.

To find a member:

1. Enter the member name in the Find text box at the bottom of the column.

You can enter a partial name.

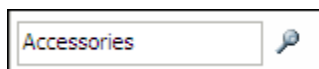

A rectangular text box with a thin border. Inside the box, the word "Accessories" is written in a standard sans-serif font. To the right of the text, there is a small, light blue magnifying glass icon.

2. Click the Search button 

The first match to the selected name is highlighted on the member list.

About Dimension Types

The specific characteristics of the dimension type manage the behavior and functions of the dimension.

Because Oracle Hyperion Profitability and Cost Management and other Oracle Hyperion Enterprise Performance Management Workspace products may share certain dimension types, you can leverage the functionality of dimensions for different products.

See [About Profitability and Cost Management Dimensions](#) for summaries of several dimension types that are common to all Profitability and Cost Management application types and are available in the Oracle Essbase outline.

 **Note:**

When defining dimensional outlines, there are restricted characters that may not be used for naming. Oracle strongly suggests that you review the Essbase naming conventions described in the *Oracle Essbase Database Administrator's Guide* to view the latest restrictions.

For detailed instructions on creating and maintaining the dimensions and members, see [Creating Profitability and Cost Management Applications](#) and the *Oracle Essbase Database Administrator's Guide*.

6

Profitability and Cost Management Dimensions

Related Topics

- [About Profitability and Cost Management Dimensions](#)
Oracle Hyperion Profitability and Cost Management uses dimensions and members created in the Profitability Applications Console to represent many of the structural elements of the business model in an Oracle Essbase application outline.
- [Dimension Types](#)
A dimension type is a dimension property that enables the use of predefined functionality.

About Profitability and Cost Management Dimensions

Oracle Hyperion Profitability and Cost Management uses dimensions and members created in the Profitability Applications Console to represent many of the structural elements of the business model in an Oracle Essbase application outline.

The following are dimensions used by all types of Profitability and Cost Management applications:

- **Business dimensions** that reflect the business-specific elements of the model, such as departments, accounts, activities, customers, or products; they may apply to one or more stages or models.
- **POV dimensions** that identify a specific point of view or version of the model, such as year, scenario, period, and version; version dimensions enable you to maintain multiple versions of a model and can be used to create alternate, or what-if, scenarios of the model, or different perspectives
- **Attribute dimensions** that enable analysis based on the attributes or qualities of dimension members. Attributes describe characteristics of data, such as the size or color of products
- **Alias dimensions** (optional), used to assign alternate names, descriptions, languages, or other items that help to define dimensions

Note:

The Management Ledger Rule and Balance dimensions are system dimensions that are seeded and should not be edited in any way, even if some part of the system allows it (for example, Update Dimensions in the Profitability Applications console). These dimensions are reserved for system use.

The database outline provides the data structure for the model, and includes calculation instructions and formulas. Dimensions in the Essbase outline are hierarchical. Data is stored at dimension intersections. Each stage in a detailed profitability model may include up to three dimensions.

 **Caution:**

Members must not be repeated within the same dimension; however, a member can be repeated across several dimensions.

Although there is no physical limit to the number of dimensions and members that can be created, performance issues can occur with large dimensional structures.

The dimensions are created and maintained in the Profitability Applications Console, and must exist before they can be used in models. Through the Profitability Applications Console, the Profitability and Cost Management Administrator can select existing dimensions and members from other products, or create new dimensions and members specifically for the model. The common data can be shared and updated between multiple products and applications. The dimensions and their members are available in Profitability and Cost Management applications after the applications are deployed.

 **Caution:**

Oracle recommends that you do not add or delete dimensions and dimension hierarchies after the modeling process has begun.

For each dimension, a dimension type and dimension name must be specified:

- The **dimension type** is a dimension property that enables the use of predefined functionality in the application. For Profitability and Cost Management dimension types, see [Dimension Types](#).
- The **dimension name** identifies the contents of the dimension, in relation to the organization or business. For example, a dimension of Account type may be given a dimension name, such as General Ledger or Chart of Accounts. The dimension name does not need to reflect the dimension type, although it may.

 **Note:**

It is advised to not use any of the system dimension member names for member names in any of the other dimensions or hierarchies. For example, DirectAllocation or GenealogyAllocation are system members in the AllocationType dimension and these names should not be used in any other dimensions in the model. This is good practice for all Profitability and Cost Management application types.

Oracle strongly recommends avoiding the use of special characters within dimension member names. The '_' (underscore) and ' ' (space) characters are supported in member names. Other special characters may not work in all cases and their use is discouraged.

To enter or load a data value to an Essbase database, you assign the data value a member from every dimension in the database. This is referred to as the dimension intersection for the data value. A dimension intersection identifies a unique database location or cell.

For naming conventions for dimensions and members, see the *Oracle Hyperion Profitability and Cost Management Administrator's Guide*.

Dimension Types

A dimension type is a dimension property that enables the use of predefined functionality.

Related Topics

- [About Dimension Types](#)
The specific characteristics of the dimension type manage the behavior and functions of the dimension.
- [Profitability and Cost Management Business Dimensions](#)
The business dimensions in the model contain members that store information that is specifically related to the requirements of the business or organization
- [Profitability and Cost Management POV Dimensions](#)
A Point of View (POV) dimension is used to present a specific version or perspective of the model.
- [Profitability and Cost Management Attribute Dimensions](#)
An attribute dimension is a special type of dimension that is associated with a business dimension.
- [Profitability and Cost Management Alias Dimensions](#)
Aliases are alternate names, descriptions, languages, or other items that help to define dimensions.

About Dimension Types

The specific characteristics of the dimension type manage the behavior and functions of the dimension.

Because Oracle Hyperion Profitability and Cost Management and other Oracle Hyperion Enterprise Performance Management Workspace products may share certain dimension types, you can leverage the functionality of dimensions for different products.

See [About Profitability and Cost Management Dimensions](#) for summaries of several dimension types that are common to all Profitability and Cost Management application types and are available in the Oracle Essbase outline.



Note:

When defining dimensional outlines, there are restricted characters that may not be used for naming. Oracle strongly suggests that you review the Essbase naming conventions described in the *Oracle Essbase Database Administrator's Guide* to view the latest restrictions.

For detailed instructions on creating and maintaining the dimensions and members, see [Creating Profitability and Cost Management Applications](#) and the *Oracle Essbase Database Administrator's Guide*.

Profitability and Cost Management Business Dimensions

The business dimensions in the model contain members that store information that is specifically related to the requirements of the business or organization

For example, product types, sales regions, manufacturing processes, general ledger, payroll, and departments.

At least one Business Dimension type must be defined by the user for the application. Business dimensions are created to describe elements within the model, such as business-specific departments, general ledger accounts, activities, locations, customers, and products.

Note:

In Management Ledger business dimensions, do not make shared members that reference non-level-0 base members. Doing so will cause the Copy POV and the calculation operations to fail because sharing with such references creates situations where Oracle Hyperion Profitability and Cost Management needs to write to non-level-0 members, which is not supported in Essbase for ASO cubes.

When the Oracle Essbase outlines are deployed, the business dimensions are created in the Profitability and Cost Management application as basic or generic dimensions, with no type. This feature enables Profitability and Cost Management to re-use the dimension member and hierarchies that were defined for other applications, such as Oracle Hyperion Planning.

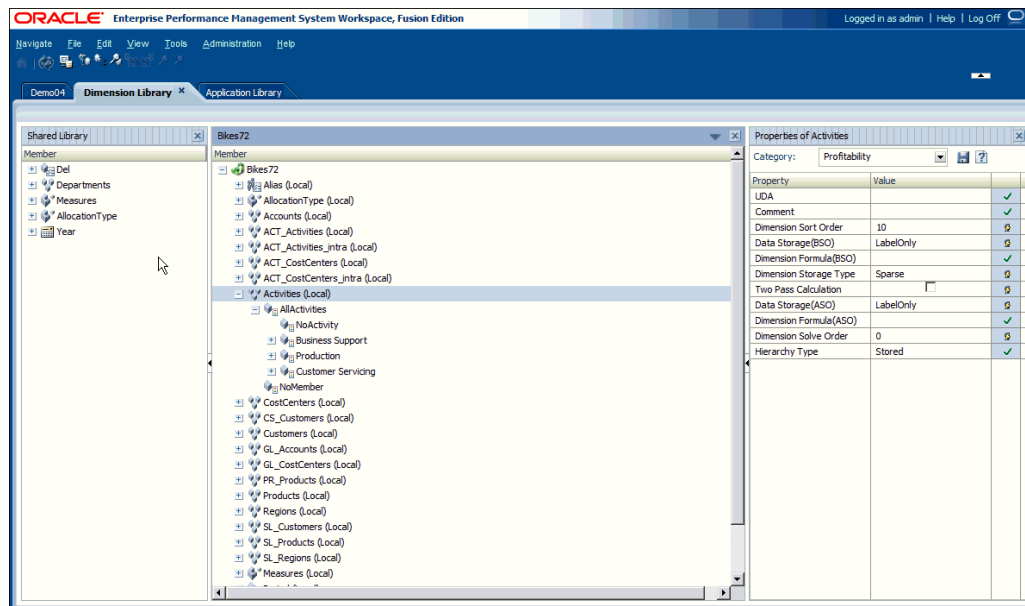

The *Oracle Hyperion Profitability and Cost Management Administrator's Guide* contains a discussion of business dimension metadata, should you require additional information.

Profitability and Cost Management POV Dimensions

A Point of View (POV) dimension is used to present a specific version or perspective of the model.

Each model requires at least one dimension to be designated as a POV dimension. The POV dimensions can be whatever is required for the particular model. The following list represents some common sample POV dimensions: :

- **Period** — Enables you to analyze strategies and changes over time. Because a model can be based on any unit of time (quarters, months, annual, years, and so on), you can analyze strategies over time, and monitor inventory or depreciation. For detailed instructions on creating time dimensions, see the *Oracle Essbase Database Administrator's Guide*.
- **Year** — Identifies the calendar year in which the data has been gathered
- **Scenario** — Identifies a version of the model for a specific time period and set of conditions

Version Dimension

Using a specific POV, you can create a POV version that enables you to maintain separate versions of the same POV to monitor the impact of changes to the model, or track different versions of the same model.

Use the Version dimension for the following tasks:

- Create multiple iterations of a model, with slight versions
- Model possible outcomes based on assumptions, or "what-if" scenarios to determine best or worst case scenarios
- Facilitate target setting

By modifying different elements within the Version dimension, you can examine results of the changes, without modifying the original model.

Profitability and Cost Management Attribute Dimensions

An attribute dimension is a special type of dimension that is associated with a business dimension.

Attributes describe characteristics of data, such as the size and color of products.

You can use the attribute feature to retrieve and analyze data not only from the perspective of dimensions, but also in terms of characteristics, or attributes, of those dimensions. For example, you can analyze product profitability based on size or packaging, and you can make more effective conclusions by incorporating into the analysis market attributes such as the population size of each market region.

User-defined attributes (UDAs) can be associated with members of an outline to describe a characteristic of the members. Users can use UDAs to return lists of members that have the specified UDA associated with them. For more information about UDAs, see the *Oracle Hyperion Profitability and Cost Management Administrator's Guide*.

Profitability and Cost Management Alias Dimensions

Aliases are alternate names, descriptions, languages, or other items that help to define dimensions.

For example, you may refer to a customer number in the system, but you can assign an alias that displays the company name on the screen, to make it easier to identify that client. You can assign one or more aliases to accounts, currencies, entities, scenarios, periods, versions, years, and user-defined dimension members.

For Oracle Hyperion Profitability and Cost Management, the alias must be set in the Profitability Applications Console.

When installation is complete, a "Default" alias table is available. After redeployment, you can view the alias on all screens that use the Common Member Selector, including Driver Selections, Assignments, Data Entry, Driver Exceptions and Trace Allocations. Search and filtering is available when the "Show Alias" option is selected.

If you select Show Alias from the Member Selector, and no alias is assigned, the Display Name is displayed within square brackets in the list of members. For example, the member "Product" would be displayed as [product] in the list of members.

When working with alias dimensions, keep in mind the following points:

- Duplicate member names or aliases are not allowed.
- The Alias View is not available on the Select Driver selector, which is accessed when adding or modifying a driver.
- When importing a dimension file into a Management Ledger application, if you define an alias table in the header, then you must define alias values for all of the members in the dimension. The alias value does not necessarily have to be different from the original member name, but you do need to specify a value for each alias table on each member row in the file.

Part II

Working with Management Ledger Profitability

Related Topics

- [About Management Ledger Models and Scenarios](#)
- [Dimensions in Management Ledger Profitability Applications](#)
- [Managing Management Ledger Models](#)
- [Working with Management Ledger Allocations](#)
- [Validating Management Ledger Models](#)
- [Managing and Calculating Management Ledger Models](#)
- [Monitoring Management Ledger Job Status](#)
- [Working with Management Ledger Queries and Reports](#)

7

About Management Ledger Models and Scenarios

Related Topics

- [Management Ledger Model Elements](#)
A Management Ledger model is a representation of part or all of an organization, and contains costs and revenue categories that are similar to the organization's chart of accounts and general ledger.
- [Steps to Design and Create Management Ledger Models](#)
The creation of a Management Ledger Profitability model requires several steps.
- [Management Ledger Workspace](#)
Accessed from Oracle Hyperion Enterprise Performance Management Workspace, the Management Ledger workspace contains two main areas.

Management Ledger Model Elements

A Management Ledger model is a representation of part or all of an organization, and contains costs and revenue categories that are similar to the organization's chart of accounts and general ledger.

Management Ledger models enable you to accurately trace the processes and activities that contribute to costs and revenue within the organization.

A Management Ledger model is made up of the following elements:

- Dimensions, which are data categories that are used to organize business data for retrieval and preservation of values.
- Drivers that determine how cost or revenue source values are calculated and allocated. Selected drivers are applied to the entire dimension, a portion of the hierarchy, a single member, or even a single intersection.
- Financial cost and revenue data, which is imported to Oracle Essbase directly through a data file, or manually entered through Oracle Hyperion Profitability and Cost Management.

See [Dimensions in Management Ledger Profitability Applications](#) for information on using these dimension types.

Together these elements organize the allocation points in the model into a logical flow. Careful modeling can capture the actual processes and activities, enabling you to realistically allocate costs and revenues.

The business, system, and POV dimensions are created in the Profitability Applications Console and deployed to the Profitability and Cost Management relational database. Rule sets and rules are created in Profitability and Cost Management.

After you create a model that reflects the current status of the organization, you can use the Copy POV feature to create alternate versions of the base model. The scenarios, or what-if

scenarios, provide a risk-free method to predict the potential profitability of new opportunities and strategies, and to evaluate alternatives. or changes in the model.

Steps to Design and Create Management Ledger Models

The creation of a Management Ledger Profitability model requires several steps.

1. Identify the general requirements and required allocation methods before creating the model.

You should establish the business requirements for the model and the reporting expectations. Using pencil and paper, discussion among stakeholders, flowcharting, diagramming software and other tools, draft the conception of what the model needs to contain in order to accomplish the goals. In some instances, it may be useful to identify the results you want to achieve first, and then work backwards to formulate the best strategy to meet these goals.

When designing the dimension outline, carefully define the reporting objectives and requirements. The effort expended in designing the outline is rewarded when generating reports.

2. Define dimensions (such as Rule, Balance, business dimensions, POV dimensions, and so on) using the Profitability Applications Console to build the main objects within the model.
3. Identify drivers to specify how to calculate cost and revenue data. These will be added as you define rules ([Working with Management Ledger Allocations](#)).
4. Create calculation rule sets and rules as described in [Working with Management Ledger Allocations](#).
5. Validate the Management Ledger model structure to ensure that the model structure conforms to validation rules ([Validating Management Ledger Models](#)).
6. Create the underlying Oracle Essbase database and populate it with cost and revenue data, through Oracle Hyperion Profitability and Cost Management or directly into the Essbase database. See the *Oracle Hyperion Profitability and Cost Management Administrator's Guide* for details.
7. Deploy the Management Ledger database. See [Managing Management Ledger Databases](#).
8. Calculate the model ([Managing and Calculating Management Ledger Models](#)).
9. Report on the calculated results, using reporting tools such as Financial Reporting, Smart View, or reports within Profitability and Cost Management. You can use the trace allocation feature to visually follow the flow of funds throughout the entire model, either forward or backward.

Management Ledger Workspace

Accessed from Oracle Hyperion Enterprise Performance Management Workspace, the Management Ledger workspace contains two main areas.

- Use the **Task Area** pane to navigate among the processes required to build, validate, and calculate the model, and to report results,
- Use the **Contents** pane to view task information, enter or modify data, and perform tasks associated with the creation and maintenance of a model and its data.

Figure 7-1 Main Workspace for Management Ledger Applications

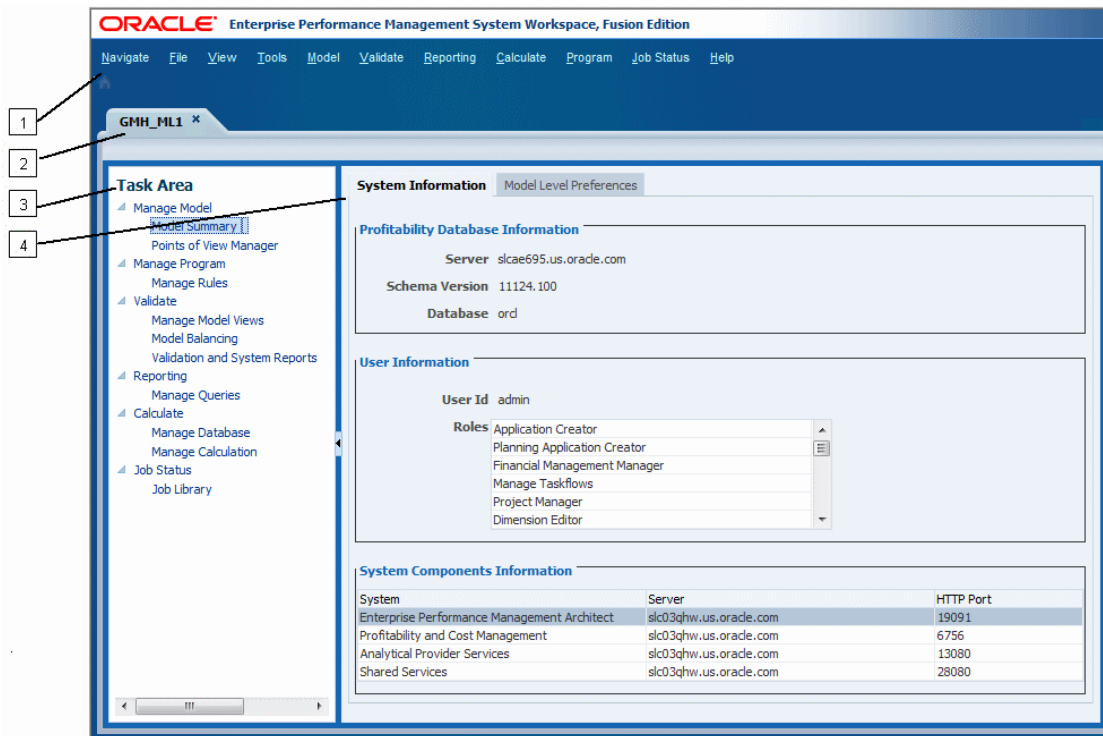

The Management Ledger workspace includes these items:

1. The main menu at the top of the window displays the common EPM Workspace menu options (**Navigate**, **File**, **View**, and **Tools**), and the Oracle Hyperion Profitability and Cost Management main menu options, including **Model**, **Validate**, **Reporting**, **Calculate**, **Program**, **Job Status** and **Help**.
2. **Application Name** tab shows the name of the currently active application.
3. The **Task Area** list is used to select the tasks required to build, modify, validate model structure, and calculate models. You can also generate reports, or follow the allocation chain throughout a model.

 **Note:**

When you change a Task Area, the Point of View selection that exists in the current task is retained. This feature enables you to move from screen to screen without be required to reselect the POV. The POV selection state remains the same until it is changed by the user and the POV "refresh" icon is clicked.

4. The contents pane displays the screen for the currently selected task, such as **Model Summary**.

8

Dimensions in Management Ledger Profitability Applications

Related Topics

- [About Management Ledger Dimensions](#)
Oracle Hyperion Profitability and Cost Management uses dimensions and members created in Oracle Essbase and Profitability Application Manager to represent many of the structural elements of the business model.
- [Management Ledger System Dimensions](#)
Management Ledger applications must contain two system dimensions: Rule and Balance.

About Management Ledger Dimensions

Oracle Hyperion Profitability and Cost Management uses dimensions and members created in Oracle Essbase and Profitability Application Manager to represent many of the structural elements of the business model.

A dimension type is a dimension property that enables the use of predefined functionality. The specific characteristics of the dimension type manage the behavior and functions of the dimension. Because Profitability and Cost Management and other Oracle Hyperion Enterprise Performance Management Workspace products may share certain dimension types, you can leverage the functionality of dimensions for different products.

See these sections for important information about Profitability and Cost Management dimensions that are common to all application types:

- [About Profitability and Cost Management Dimensions](#)
- [Dimension Types](#)
 - [Profitability and Cost Management Business Dimensions](#)
 - [Profitability and Cost Management POV Dimensions](#)
 - [Profitability and Cost Management Attribute Dimensions](#)
 - [Profitability and Cost Management Alias Dimensions](#)

[Management Ledger System Dimensions](#) describes system dimensions that are specific to Management Ledger applications and models:

Management Ledger Dimension Requirements

The database outline provides the data structure for the model, and includes calculation instructions and formulas. Dimensions in the Essbase outline are hierarchical. Data is stored at dimension intersections. The following are Management Ledger Profitability dimension requirements:

- Applications or models must contain at least one POV dimension and can have up to four POV dimensions.

- Applications must contain one and only one system dimension named **Rule**.
Users can edit and add more members to the Rule dimension For example, R1001 through R1500. Optionally, they can also trim that dimension. The Calculation Programs member in the Rule dimension is not editable.
- Applications must contain one and only one system dimension named **Balance**.
System dimension members in the Balance dimension cannot be edited. Users can, however, add alternate hierarchies.
- There should be at least one business dimension with no duplicate members.

Caution:

Members must not be repeated within the same dimension. However, members can be repeated across several dimensions.

Figure 1 shows a sample Essbase outline of a Management Ledger Profitability database, shown on the Essbase console.

Figure 8-1 Essbase Outline of a Management Ledger Profitability Database

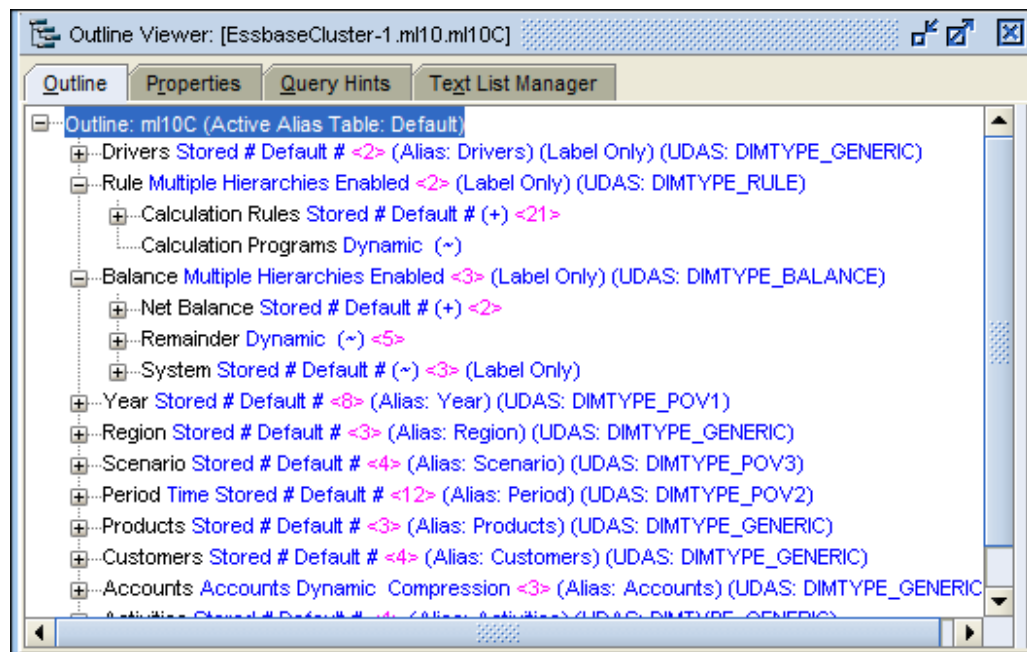

Management Ledger System Dimensions

Management Ledger applications must contain two system dimensions: Rule and Balance.

These system dimensions are populated from the Profitability Applications Console when a new Management Ledger application is deployed or created. For additional information about the Rule and Balance dimensions, see the listed sections.

For detailed instructions on creating and maintaining the dimensions and members, see the *Oracle Essbase Database Administrator's Guide*.

 **Note:**

The Management Ledger Rule and Balance dimensions are system dimensions that are seeded and should not be edited in any way, even if some part of the system allows it (for example, Update Dimensions in the Profitability Applications Console). These dimensions are reserved for system use.

Management Ledger Rule Dimension

The Rule dimension contains definitions of calculation rules for Management Ledger applications. [Figure 1](#) shows the outline of the Rule dimension in the Oracle Essbase console. This is an illustration of the Calculation Rules members.

Figure 8-2 The Management Ledger Rule Dimension Outline

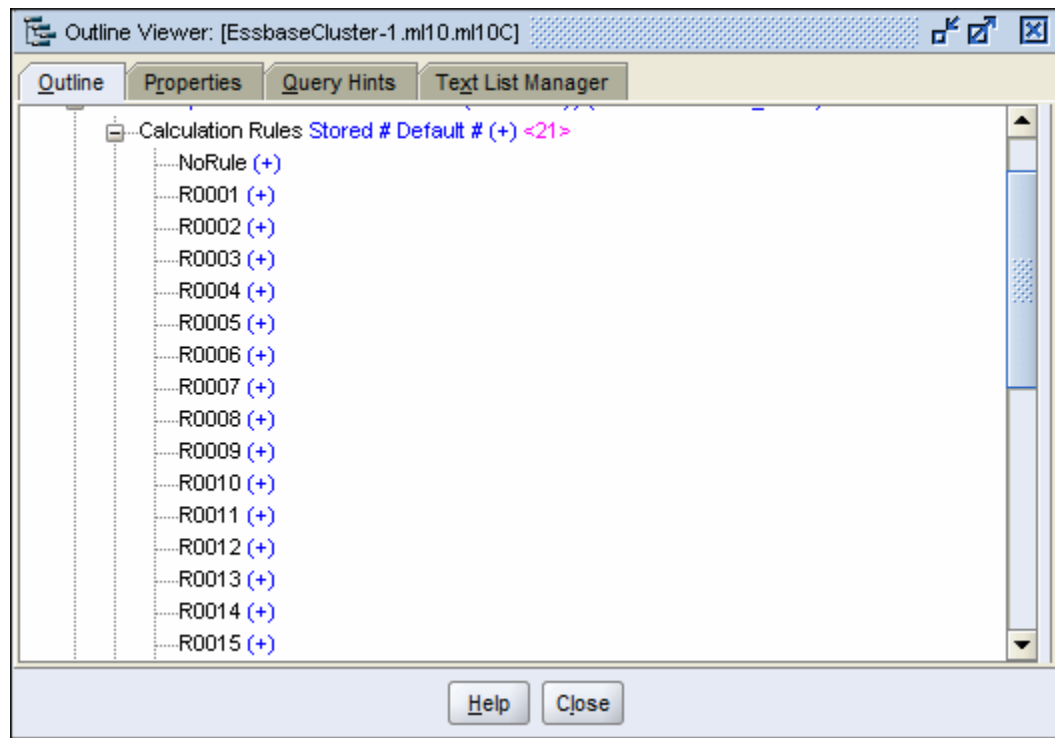

Users can delete and add rules to Calculation Rules, but the only rule they can apply is NoRule. All the others are reserved for system use.

[Figure 1](#) shows an additional member, Calculation Programs. This member is controlled by the system and is not editable by users.

Management Ledger Balance Dimension

Figure 1 shows the outline of the Balance dimension in the Oracle Essbase console.

Figure 8-3 The Management Ledger Balance Dimension Outline

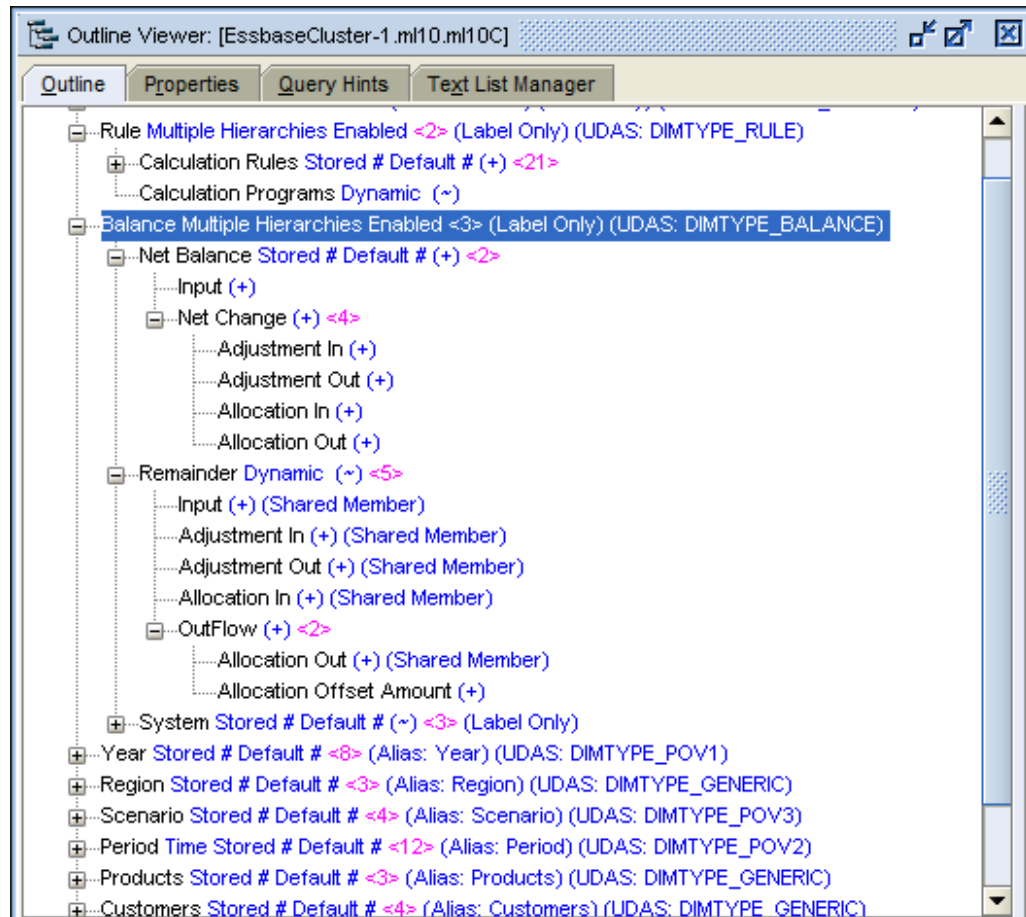

Users can add data to the Input member of Net Balance. The remainder of the members reflect inputs and outputs determined by rule sets and rules. Adjustments are the result of driver calculations, allocations are the result of rule allocations, and offsets result from rule offset definitions. See [Working with Management Ledger Allocations](#), for information about rule sets, rules, and their definitions.

Data held in intersections with these members is visible in the Rule Balancing screen ([Viewing the Rule Balancing Task Area](#)).

9

Managing Management Ledger Models

Related Topics

- [About Managing Management Ledger Models](#)
The Managing Models options are used to build the top-level structure of a model, and to control model preferences and connections.
- [Working with the Management Ledger Model Summary](#)
The Model Summary displays details of the system information for the selected model and enables you to modify model level preferences.
- [Working with Management Ledger Points of View](#)
The Point of View (POV) for a model provides a specific view of model information for a selected time period.
- [Importing Management Ledger Artifacts](#)
You can enter data definitions and model information directly into Oracle Hyperion Profitability and Cost Management.

About Managing Management Ledger Models

The Managing Models options are used to build the top-level structure of a model, and to control model preferences and connections.

From the Model Summary, you can view system information and set model-level preferences.

Points of View (POVs) are used to create various versions of a model; for example, to hold budget versus actual figures, or to play scenarios to measure the impact of various changes on the bottom line.

See these sections to manage the models:

- [Working with the Management Ledger Model Summary](#)
- [Working with Management Ledger Points of View](#)
- [Importing Management Ledger Artifacts](#)

Working with the Management Ledger Model Summary

The Model Summary displays details of the system information for the selected model and enables you to modify model level preferences.

The Model Summary contains these tabs:

- System Information ([Reviewing Management Ledger Model System Information](#))
- Model Level Preferences ([Reviewing and Setting Management Ledger Model Level Preferences](#))

Reviewing Management Ledger Model System Information

The **System Information** tab provides detailed information for the selected model, including the relational database, Oracle Essbase connections, authorized users and associated system components.

Most of the system information is read-only; however, you can enter or modify the names for the application and database.

To access the System Information tab:

1. From Oracle Hyperion Enterprise Performance Management Workspace, select **Navigate**, then **Applications**, then **Profitability**, and then select the model that you want to view.
2. From **Task Areas**, select **Manage Model**, and then **Model Summary**.

The **System Information** tab is displayed (Figure 1) with contents described in Table 1.

Figure 9-1 Management Ledger Model Summary, System Information Tab

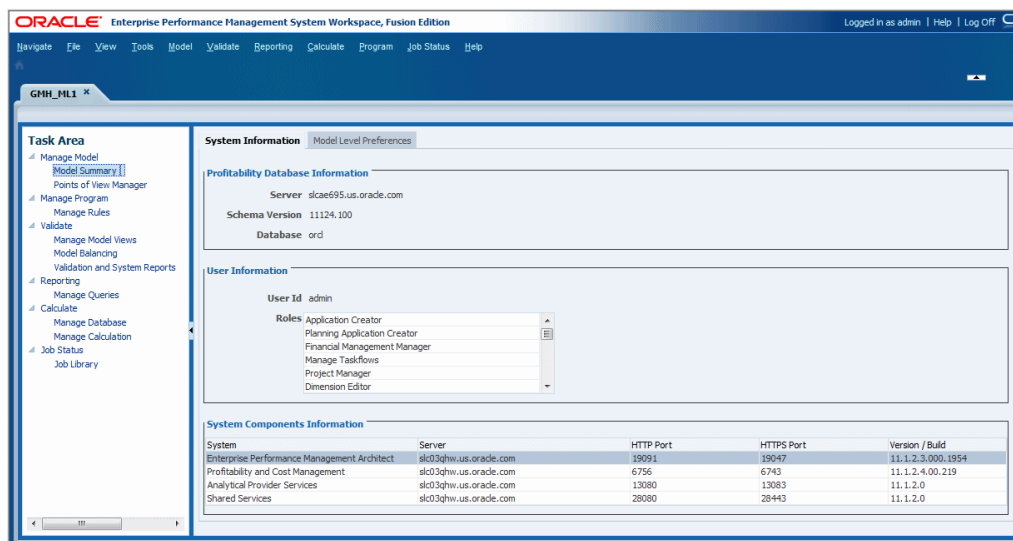

Table 9-1 Management Ledger Model Summary, System Information Tab Contents

Tab Area	Description
Profitability Database Information	Name of the relational database server and the database in which the model data resides. The Schema version being used with the selected application is also displayed.

Table 9-1 (Cont.) Management Ledger Model Summary, System Information Tab Contents

Tab Area	Description
User Information	<p>User ID for the user who is authorized to access the Oracle Hyperion Profitability and Cost Management database, and all associated security roles for that user.</p> <p>Note: Ensure that this user has been granted access to the Essbase databases and the application. See the <i>Oracle Hyperion Profitability and Cost Management Administrator's Guide</i>.</p>
System Components Information	<p>Details for each component in the installation, as follows:</p> <ul style="list-style-type: none"> • System displays the name of the Enterprise Performance Management component. • Server displays the name of the cluster or server hosting that component. • HTTP Port displays the port being used by the component. • HTTPS Port displays the secure port being used by the component, if available. • Version/Build displays the version and build number for the listed component. <p>You can sort the columns by clicking any column header. The System and Server columns are sorted alphabetically, and the Ports and Version/Build columns are sorted numerically.</p>

Reviewing and Setting Management Ledger Model Level Preferences

You can customize a model to use your display preferences. The settings on the Model Level Preferences tab apply to the entire model.

You also specify Oracle Essbase connection information for the selected model.

Caution:

Although you can change preferences at any point in the life cycle of a model, changes made later in the cycle may result in data loss.

To set model level preferences:

1. From Oracle Hyperion Enterprise Performance Management Workspace, select **Navigate**, then **Applications**, then **Profitability**, and then select the model that you want to view.
2. From **Task Areas**, select **Manage Model**, then **Model Summary**, and then select the **Model Level Preferences** tab (Figure 1).

Figure 9-2 Management Ledger Model Summary, Model Level Preferences Tab

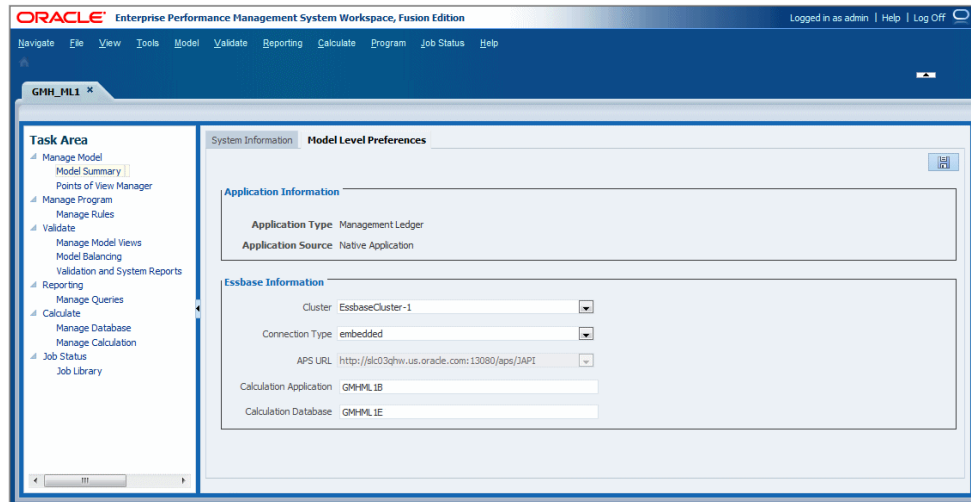

3. Review the **Application Type—Management Ledger**—and **Application Source** (depending on which tool was used to create the original application in Essbase).
The application type is selected when the application is created and cannot be changed.
4. Under **Essbase Information**, enter Essbase connection information for the model. The required information is described in [Table 1](#).

Table 9-2 Management Ledger Model Summary, Model Level Preferences Tab Contents for Essbase Information Group

Setting	Action
Cluster	Select the logical name of the Essbase server that provides the connection to the Essbase database. This name may point to a clustered or non-clustered Essbase server.
Connection Type	Select the type of connection: <ul style="list-style-type: none"> • Embedded • APS See the <i>Oracle Hyperion Provider Services Administration Guide</i> .
APS URL	Activated only if APS is selected as the Connection Type Select the URL for the APS that represents the Logical Web Application (LWA) of the server on which Oracle Hyperion Provider Services is running. The available APS servers are registered in Oracle Hyperion Shared Services registry during configuration. By default, the APS URL is <code>http://localhost:13080/aps/JAPI</code> .
Calculation Application	Enter the desired ASO application name for the model's deployed Essbase database (limited to 7 characters).
Calculation Database	Enter the name for the model's deployed Essbase database (limited to 7 characters).

5. Click **Save**, .

Working with Management Ledger Points of View

The Point of View (POV) for a model provides a specific view of model information for a selected time period.

For example, POV dimensions can include year, period, scenario, and version. Members for POV dimensions are user-defined, and can provide a rich array of POV combinations for modeling and what-if analysis.

Points of View are managed within the Oracle Hyperion Enterprise Performance Management Workspace tab for each model. See the listed sections for detailed information about POVs.

About Management Ledger POVs

You must have at least one POV dimension, and you can have up to four. Users define the POV dimensions and their names. Calculations are performed using the specific data and calculation rules of that POV for different months or situations.

A typical POV includes the Year, Period, and Scenario. The first step for almost every activity in Oracle Hyperion Profitability and Cost Management is the selection of a POV.

Note:

Calculation rules in Management Ledger models are POV-specific. For a calculation rule or rule set or global context definition to exist within a POV, there must be a unique definition of that artifact within the POV.

A model can be edited only if the POV is set to "Draft" status ([Modifying the Management Ledger POV State](#)). You can modify the POV to reflect new drivers, criteria, or members, enabling you to create alternative scenarios. By comparing these scenarios, you can evaluate how changes affect the processes or bottom line.

You can also create separate versions of the same POV to monitor the impact of changes to the model, or track different versions of the same model.

Management Ledger POV Dimensions

A Point of View (POV) dimension is used to present a specific version or perspective of the model. Each model requires at least one dimension to be designated as a POV dimension. The POV dimensions can be whatever is required for the particular model. The following list represents some common sample POV dimensions:

- **Period** — Enables you to analyze strategies and changes over time. Because a model can be based on any unit of time (quarters, months, annual, years, and so on), you can analyze strategies over time, and monitor inventory or depreciation. For detailed instructions on creating time dimensions, see the *Oracle Essbase Database Administrator's Guide*.
- **Year** — Identifies the calendar year in which the data has been gathered

- **Scenario** — Identifies a version of the model for a specific time period and set of conditions

Version Dimension

Using a specific POV, you can create a POV version that enables you to maintain separate versions of the same POV to monitor the impact of changes to the model, or track different versions of the same model.

Use the Version dimension for the following tasks:

- Create multiple iterations of a model, with slight versions
- Model possible outcomes based on assumptions, or "what-if" scenarios to determine best or worst case scenarios
- Facilitate target setting

By modifying different elements within the Version dimension, you can examine results of changes, without modifying a original model.

Managing Management Ledger Profitability POVs

A POV displays a particular version of a model for a selected snapshot, such as year, period, scenario, and version.

When a new POV is added, the status is automatically set to "Draft" so the POV can be edited.

At least one POV dimension is required for a model; however, you can create multiple POV combinations for a single model. A selected POV information can be saved as an Oracle Hyperion Enterprise Performance Management Workspace user preference. You can also copy a POV, to begin a model for a new reporting period or a different scenario. See [Copying Management Ledger POVs](#).

The POV dimension defined for an application determines the potential POVs available for a model, but all POVs are not automatically available for assignment or data input. You cannot assign drivers or load data for a POV until it has been added to the model.

Calculation rules must be specified for each POV combination.

Use the following procedures to work with POVs:

- [Viewing the Management Ledger Points of View Manager Screen](#)
- [Adding Management Ledger POVs](#)
- [Modifying the Management Ledger POV State](#)
- [Copying Management Ledger POVs](#)
- [Clearing Selected Artifacts from Management Ledger POVs](#)
- [Deleting Management Ledger POVs and All Artifacts](#)

Viewing the Management Ledger Points of View Manager Screen

The Points of View Manager screen enables you to create, modify, and delete POVs in Management Ledger applications.





To display the Management Ledger **Points of View Manager** screen:

1. In an open model, from **Task Areas**, select **Manage Model**, and then **Points of View Manager**.

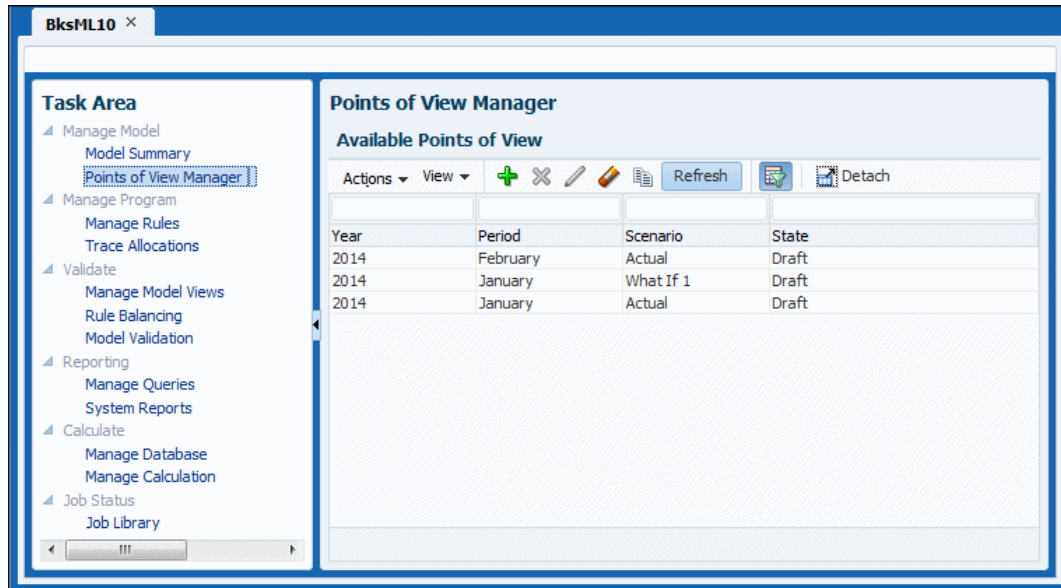
The **Points of View Manager** screen lists all existing POVs.

Figure 9-3 Management Ledger Points of View Manager Screen



2. Use the drop-down menus and buttons to perform the following actions:
 - **Actions** menu—Create, delete, and copy POVs; change POV states; clear POV configuration artifacts
 - **View** menu—Perform the following actions:
 - **Columns**—Show all or selected dimension columns
 - **Detach** and **Attach** the table of POVs, 
 - **Reorder Columns**—Use the arrow controls to move the selected dimension column toward the beginning or end of the POV table
 - **Query By Example**—Select to filter data using Query by Example (QBE), :
 - * Click Query By Example, .
 - * Enter the first few letters of the target value in one or more QBE fields that appear above each data column.
 - * Click  again.
 Only matching members are displayed. To show all members again, follow these steps and clear all fields.

 **Note:**

Point to a button to identify its action.

Adding Management Ledger POVs

You can add a POV to view the information and calculations for a model for a selected snapshot of the model, such as a year, period, scenario and status.

The values of the parameters available for a model are set in the Profitability Applications Console.



Note:

You cannot access a POV from other task windows until the POV has been added in POV Management.

To add POVs:

1. In an open model, from **Task Areas**, select **Manage Model**, and then **Points of View Manager** (Figure 1).
2. Click  or select **Actions** and then **Create Point of View**.
The **Create Point of View** dialog box is displayed.
3. Select the parameters in the model to identify the new POV.
Because this is a new POV, the **Year** and **Period** parameters are offered and **State** is set automatically to **Draft** to enable you to build and edit the model.
4. Click **OK**.
The POV is added to the list.

Modifying the Management Ledger POV State

When a model is created, its status (**State**) is set to **Draft**. This indicates that the model can be viewed and edited. When the model is final, change the POV state to ensure it cannot be modified. The status is not an Oracle Essbase dimension.

The POV state can be set to one of the following: Draft, Published, or Archived.

Only the POV status can be changed. To modify any other parameters, you must create a new POV.

To change the POV state:

1. In an open model, from **Task Areas**, select **Manage Model**, and then **Points of View Manager** (Figure 1).
2. Select a POV to modify.
3. Select **Actions**, and then **Change Point of View State**, .
4. Under **State**, select the new status:
 - **Draft** — Build or edit the model, and generate dynamic reports.
 - **Published** — View the model, and generate dynamic reports
 - **Archived** — View the model and generate dynamic reports.

You can change the state back to **Draft** at any time to edit the model.

 **Note:**

If you modify the POV, only the state is changed. You are no longer be able to calculate the model if the status has been set to "Published" or "Archived".

5. Click **OK**.

Copying Management Ledger POVs

You can copy a POV to provide a starting point for a new model or scenario, or to create what-if scenarios for an existing model.

For example, you can begin a period by copying driver selections and assignments from the previous period, or you can create seed data for a forecast scenario by copying data from an actual scenario.

To copy POVs:

1. In an open model, from **Task Areas**, select **Manage Model**, and then **Points of View Manager** (Figure 1).
2. Select the POV to copy.
3. Select **Actions**, and then **Copy Point of View**, .

Figure 9-4 Management Ledger Copy Point of View Dialog Box



4. In the **Copy Point of View** dialog box, enter POV dimensions for the new POV (**Destination**). Under **Copy Configuration**, select the elements of the POV that are to be copied.

5. Click **OK** to start copying.

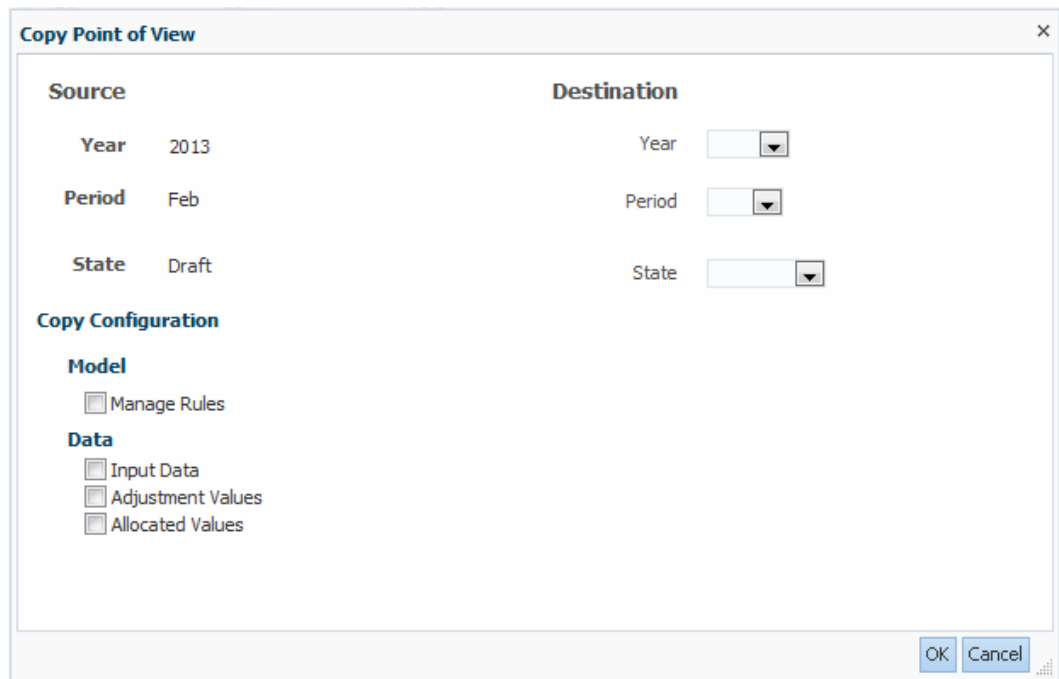
You can check **Job Library** under **Job Status** in the **Task Area** to check the status of the copy.

Caution:

Depending on the size and complexity of the model, this operation may take a significant amount of time.

6. When the copy is complete, review the copied information in the new POV.

Clearing Selected Artifacts from Management Ledger POVs

You can clear or delete selected objects (artifacts) from a POV.

To delete an entire POV, including its associated assignments and driver selections, see [Deleting Management Ledger POVs and All Artifacts](#).

To clear (delete) selected artifacts from a POV:

1. Ensure that no other users require the POV and its contents.
2. In an open model, from **Task Areas**, select **Manage Model**, then **Points of View Manager** (Figure 1).
3. Select the POV that contains the artifacts to clear.
4. Select **Actions**, and then **Clear Point of View**, .

Figure 9-5 Management Ledger Clear Point of View Dialog Box



5. Under **Model** and **Data**, select the configuration artifacts to clear.
6. Click **OK** to clear the selected artifacts.
See `hpcm.log` to view a record of the operation.

Deleting Management Ledger POVs and All Artifacts

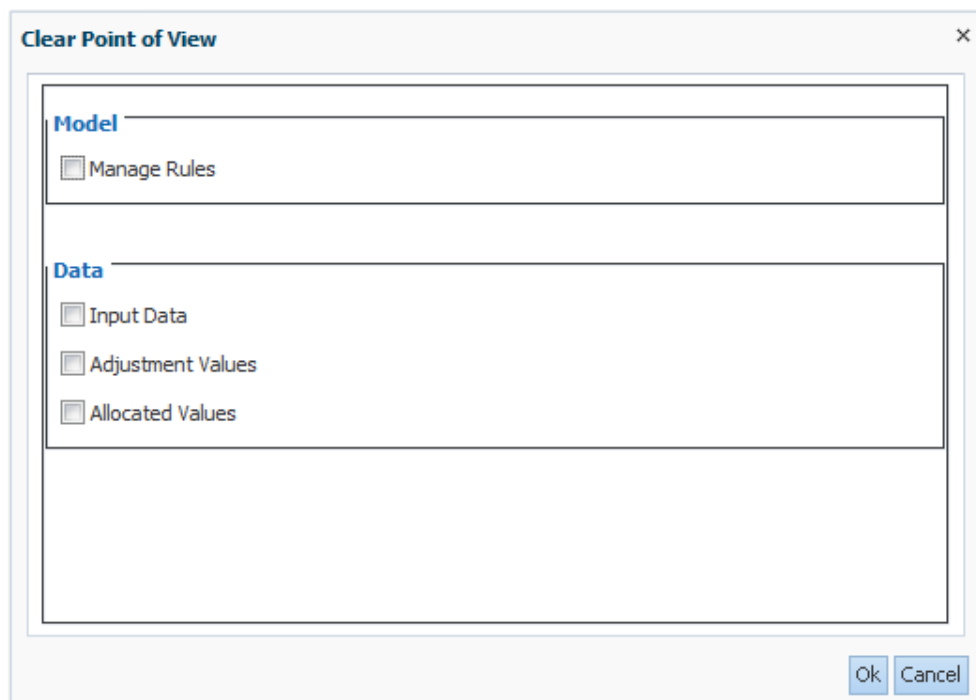
▲ Caution:

When a POV is deleted, all objects within that POV are deleted, including the associated assignments and driver selections. Oracle recommends that, before deleting a POV, you create a backup directory of the databases in Oracle Hyperion Enterprise Performance Management Workspace and Oracle Essbase. Contact the administrator for assistance, if required.

To erase data in Essbase, before deleting the POV, perform the "Clear All" function for the selected POV. See [Clearing Selected Artifacts from Management Ledger POVs](#).

To delete POVs and their associated artifacts (such as rules and rule sets):

1. Ensure that no other users require the POV and its contents.
2. **Optional:** To erase data in Essbase, select **Clear All** data as described in [Clearing Selected Artifacts from Management Ledger POVs](#).
3. In an open model, from `Task Areas`, select **Manage Model**, then **Points of View Manager** (Figure 1).
4. Select the POV to delete.
5. Select **Actions**, and then **Delete Point of View**, .

The **Delete Point of View** dialog box displays POV dimensions for the selected POV.

6. Click **OK** to delete the POV.

The POV is removed from the list and is no longer available for selection.

Importing Management Ledger Artifacts

You can enter data definitions and model information directly into Oracle Hyperion Profitability and Cost Management.

To facilitate the population of the application, you can import model definitions (artifacts) directly into Profitability and Cost Management using Oracle Hyperion Enterprise Performance Management System Lifecycle Management. This can include POVs with associated rule sets and rules. For more information, see the *Oracle Enterprise Performance Management System Lifecycle Management Guide* and the *Oracle Hyperion Profitability and Cost Management Administrator's Guide*.

 **Caution:**

Oracle recommends that, before importing artifacts, you create a backup directory of the databases in Oracle Hyperion Enterprise Performance Management Workspace and Oracle Essbase. Contact the administrator for assistance.

Working with Management Ledger Allocations

Related Topics

- [About Management Ledger Allocations](#)
In Oracle Hyperion Profitability and Cost Management, allocations control how costs and revenues are distributed throughout the model to specified accounts or elements.
- [Creating and Managing Management Ledger Allocations](#)
You can create and manage rule sets and rules in Management Ledger models so that data, such as revenue and expenses, can be pulled from a source location in Oracle Essbase and assigned to an allocation destination according to an applied driver.
- [Tracing Management Ledger Profitability Allocations](#)
The Trace Allocations task area of Management Ledger Profitability enables you to select a model view and POV and then trace forward or back from that point to see allocation inputs and outputs for a selected dimension.

About Management Ledger Allocations

In Oracle Hyperion Profitability and Cost Management, allocations control how costs and revenues are distributed throughout the model to specified accounts or elements.

A driver is used to determine how the funds for each allocation are calculated. The calculated results are assigned from a source to a destination as the funds flow through the model. You use the **Manage Rules** area to create allocations in Management Ledger Profitability models.

You set up allocations for a single POV by creating rule sets and rules:

- **Rule sets** are groups of Management Ledger rules that help to organize calculation logic definitions, to calculate similar rules together, and to simplify the definition of many rules that share common dimension members. Rule sets run in a set order, determined by the rule set sequence number, and may also contain options specific to the execution of rules within that rule set.
- **Rules** define the calculation logic of Management Ledger models and enable them to reflect the cost assignments within the modeled situations. Rules within rule sets are executed in the order of their sequence numbers within that rule set. There are two types of rules, allocation and custom calculation. You can define allocation source, destination, driver basis, and offset for each allocation rule in a rule set ([Creating Management Ledger Allocation Rules](#)). Custom calculation rules contain formulas in MDX format and are primarily used for adjusting data ([Creating Management Ledger Custom Calculation Rules](#)).

You can set up defaults, called *contexts*, for each level of allocations for a POV in Management Ledger Profitability models:

- The **Global context** enables you to define default definitions for dimensions that will be used in all rule definitions for that POV.
- **Rule Set contexts** enable you to define default dimension definitions for all rules in a given rule set.

See [Creating and Managing Management Ledger Allocations](#) for allocation instructions.

Creating and Managing Management Ledger Allocations

You can create and manage rule sets and rules in Management Ledger models so that data, such as revenue and expenses, can be pulled from a source location in Oracle Essbase and assigned to an allocation destination according to an applied driver.

These procedures are performed in the Management Ledger **Manage Rules** task and content areas.

About the Management Ledger Manage Rules Areas

The **Manage Rules** task and content areas enable you to define allocations for Management Ledger Profitability models. You can define global and rule set contexts (dimension defaults), define rule sets, and define rules that access data sources, data destinations, drivers, and offsets.

Each group of rule sets and rules applies to a single POV.



Note:

There are allocation rules and custom calculation rules. The same context and rule set information applies to both rule types.

To define allocations for Management Ledger models:

1. Open a Management Ledger model with data.
2. In the **Task Area**, select **Manage Rules** in the **Manage Program** group.
The **Manage Rules** content area is displayed ([Figure 1](#)).

Figure 10-1 The Manage Rules Content Area for Management Ledger Models

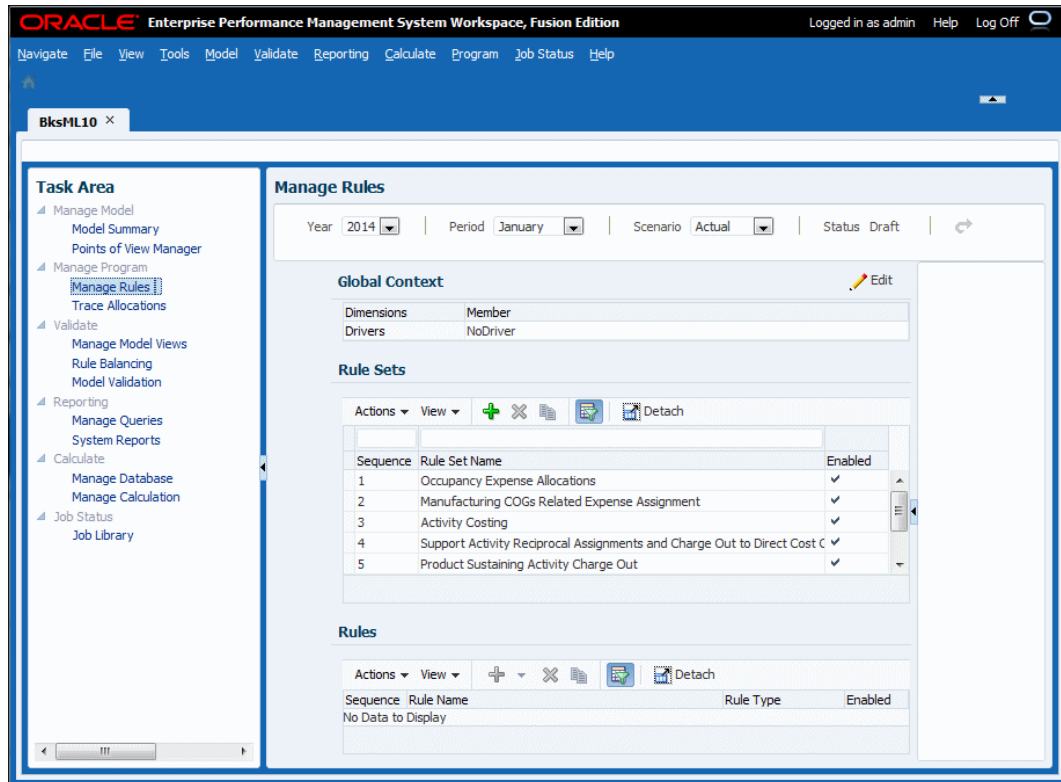

See the following sections for information about defining and managing allocations in Management Ledger Profitability models:

- [Defining Global Contexts for Management Ledger Rules](#)
- [Working with Rule Sets for Management Ledger POVs](#)
- [Defining and Managing Calculation Rules in Management Ledger Models](#)

See [Calculating Management Ledger Models](#) for information about running calculations and performing allocations.

Defining Global Contexts for Management Ledger Rules

Setting a **global context** enables you to define default definitions for dimensions that will be used in all rule definitions for the selected POV.



Note:

Define a global context before defining rule sets for the selected POV.

To define a global context for one POV of a Management Ledger model:

1. In an open Management Ledger model, select **Manage Rules** in the **Manage Program** group ([About the Management Ledger Manage Rules Areas](#)).





2. In the **Manage Rules** content area (Figure 1, enter the year and period for a valid POV, and then click the **Refresh** button, .

Figure 10-2 Defining a Global Context for Management Ledger Models

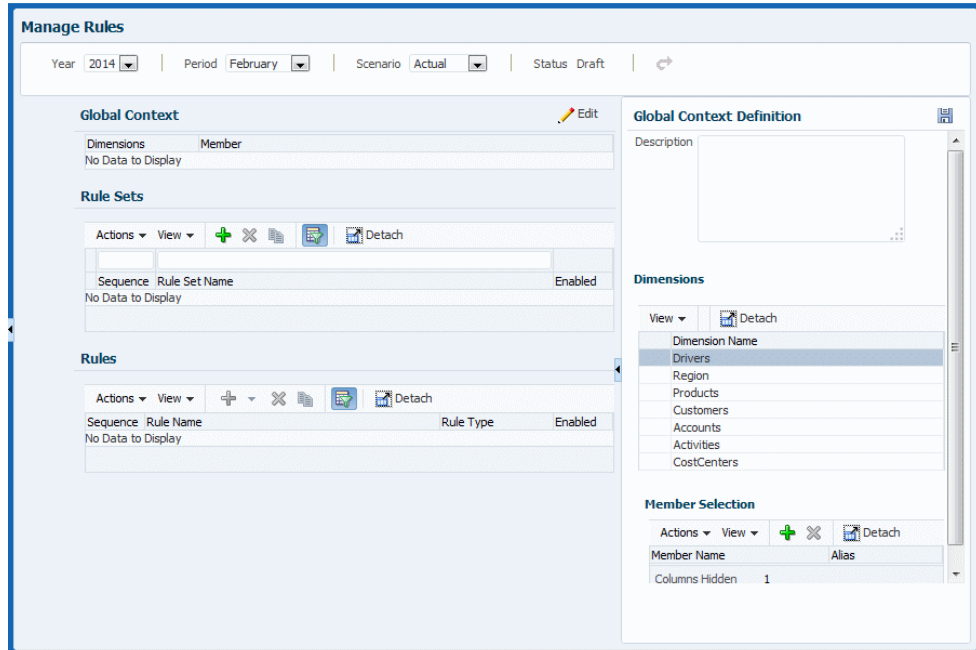

3. Click **Edit**, , in the **Global Context** area.
4. **Optional:** In the **Global Context Definition** box, enter a description of the global context default.
5. The **Dimensions** area displays all dimensions for the selected application that are not required system dimensions. Select one to apply to all rules as a default and then click  or select **Actions**, and then select **Add Member** in the **Member Selection** area.
6. Select one member to include in the global context default for that POV, and then click **OK**.
7. **Optional:** Repeat steps 5 and 6 for other dimensions.
8. When the global context definition is complete, click  (Save).

Now, all selected dimension-member combinations will be applied to new rules created for the selected POV.

Figure 2 shows a global context definition that applies the **NoDriver** member to the **Drivers** dimension for all rules created for that POV. The global context was defined before any rule sets and rules were created.

Figure 10-3 Global Context for the Drivers Dimension

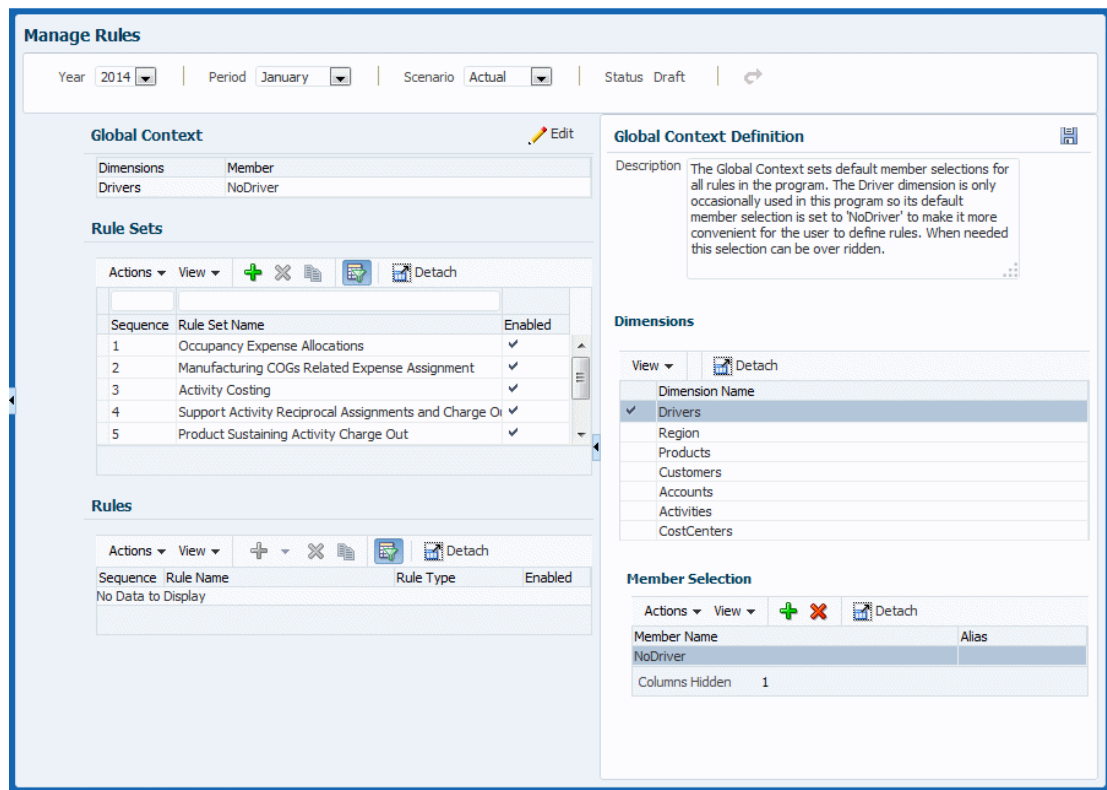

The next step is to define and manage rule sets ([Working with Rule Sets for Management Ledger POVs](#)).

Working with Rule Sets for Management Ledger POVs

Rule sets enable users to group related rules together to better organize the definition of calculation logic, to execute similar rules together, and to simplify the definition of rules that share common dimension members. Rule sets have a set order, determined by the rule set sequence number, and may also contain options specific to the execution of rules within that rule set. Rule sets apply to the specified POV.

Setting a **rule set context** enables you to define default definitions for dimensions that will be used in all rules included in the selected rule set for the selected POV.

Defining Management Ledger Rule Sets

To define a rule set for one POV of a Management Ledger model:



1. In an open Management Ledger model, select **Manage Rules** in the **Manage Program** group ([About the Management Ledger Manage Rules Areas](#)).
2. In the **Manage Rules** content area ([Figure 1](#)), enter the year and period for a valid POV, and then click the **Refresh** button, .
3. In the **Rule Sets** area, click  or select **Actions** and then select **Create Rule Set** ([Figure 1](#)).

Figure 10-4 Management Ledger Rule Set Definition Area

The screenshot shows a web form titled "Rule Set Definition" with two tabs: "Description" (selected) and "Context". The form contains the following fields and options:

- * Rule Set Name: A text input field.
- Description: A large text area for entering a description.
- * Sequence: A text input field with the value "1".
- Enabled: A checkbox that is currently unchecked.
- Rule Set Calculation Options**: A section with three radio button options:
 - Serial Execution: Selected (radio button is filled).
 - Parallel Execution: Unselected (radio button is empty).
 - Iterative Execution: Unselected (radio button is empty).
- Number of Iterations: A text input field with the value "1".
- Use Global Context: A checkbox that is checked.

4. Enter a name for the rule set.
5. **Optional:** In the **Description** box, enter a description of the rule set.
6. Enter a **Sequence** number to determine the order in which the rule set runs.
7. **Optional:** Select **Enabled** to indicate that the rule set is active when the calculation is performed.
8. Select an execution type to indicate how the rule set calculations should run:
 - **Serial Execution**, the default, runs all rules in the rule set sequentially, depending on their sequence number.
 - **Parallel Execution** runs rules with the same sequence number at the same time if computer hardware supports that.
 - **Iterative Execution** runs the rule set multiple times in sequence; **Number of Iterations** indicates the number of iterations to run.
9. If selected, **Use Global Context** indicates that the global context should be applied to the current rule set, if one has been defined.

10. **Optional:** Define a rule set context to apply dimension defaults to all rules in the rule set ([Defining and Managing Management Ledger Rule Set Contexts](#)).

11. When the rule set definition is complete, click  (Save).



To edit and delete rule sets, see [Managing Management Ledger Rule Sets](#).

To define a rule set context and set defaults for all rules in the rule set, see [Defining and Managing Management Ledger Rule Set Contexts](#).



Managing Management Ledger Rule Sets

[Defining Management Ledger Rule Sets](#) describes how to create a rule set. You can also delete and copy rule sets.

To delete a rule set:

1. Display the **Manage Rules** content area ([About the Management Ledger Manage Rules Areas](#)).
2. Enter a POV and select a rule set.
3. Click  or select **Actions** and then **Delete Rule Set**.
4. Confirm that you want to delete the rule set and all its rules.
5. Click .

To copy a rule set:

1. In the **Manage Rules** content area, enter a POV and select a rule set.
2. Click  or select **Actions** and then **Copy Rule Set**.
3. Enter a name for the new rule set. Optionally, select **Copy rules** to add existing rules to the new rule set.
4. Click **OK**, and then click  (Save).

Defining and Managing Management Ledger Rule Set Contexts

You can define a **rule set context** to specify default dimensions and members for use in all rules included in the selected rule set for the selected POV.

To define a rule set for one POV of a Management Ledger model:

1. In an open Management Ledger model, select **Manage Rules** in the **Manage Program** group ([About the Management Ledger Manage Rules Areas](#)).
2. In the **Manage Rules** content area ([Figure 1](#), enter the year and period for a valid POV, and then click  (Refresh).
3. In the **Rule Sets** area, select a rule set and then click the **Context** tab ([Figure 1](#)).

Figure 10-5 Management Ledger Rule Set Context Definition Area



4. On the **Context** tab (Figure 1), select a dimension that applies to all rules in that rule set.

 **Note:**

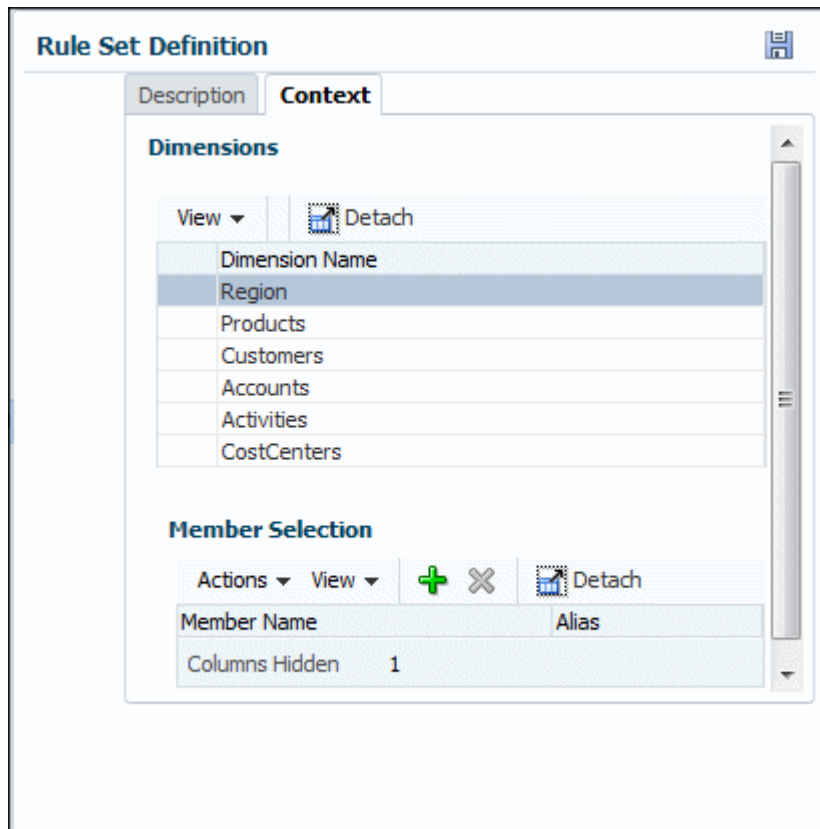
POV dimensions and any dimensions defined in the global context are not available for selection.



5. In the **Member Selection** area, click  or select **Actions**, and then select **Add Member** (Figure 2).

Figure 10-6 Select Dimension Members Dialog Box

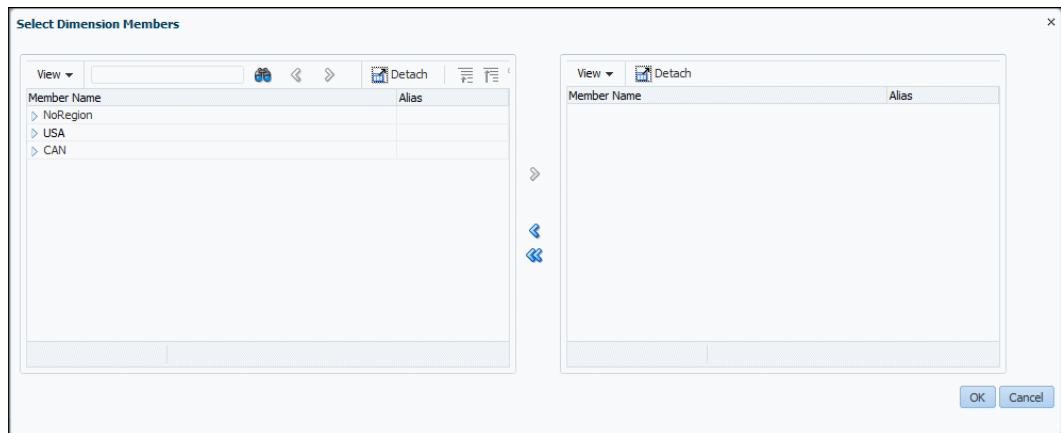

6. In the **Select Dimension Members** dialog box, click the symbol in front of listed members to open them to their lowest level.
7. Select members to apply to all rules and use the shuttle control arrows to move them into the selected list on the right side of the **Select Dimension Members** dialog box.
8. When the rule set context definition is complete, click **OK** and then click  (Save).

Now, all selected dimension-member combinations will be applied to new rules created for the selected POV.

[Figure 3](#) shows that the Customers, Activities, and CostCenters dimensions have been enabled as rule set contexts for the Infrastructure Charges rule set, sequence number 1. The selected member for CostCenters is **CC1001**.

Figure 10-7 An Example Management Ledger Rule Set Context Defined for the Infrastructure Charges Rule Set

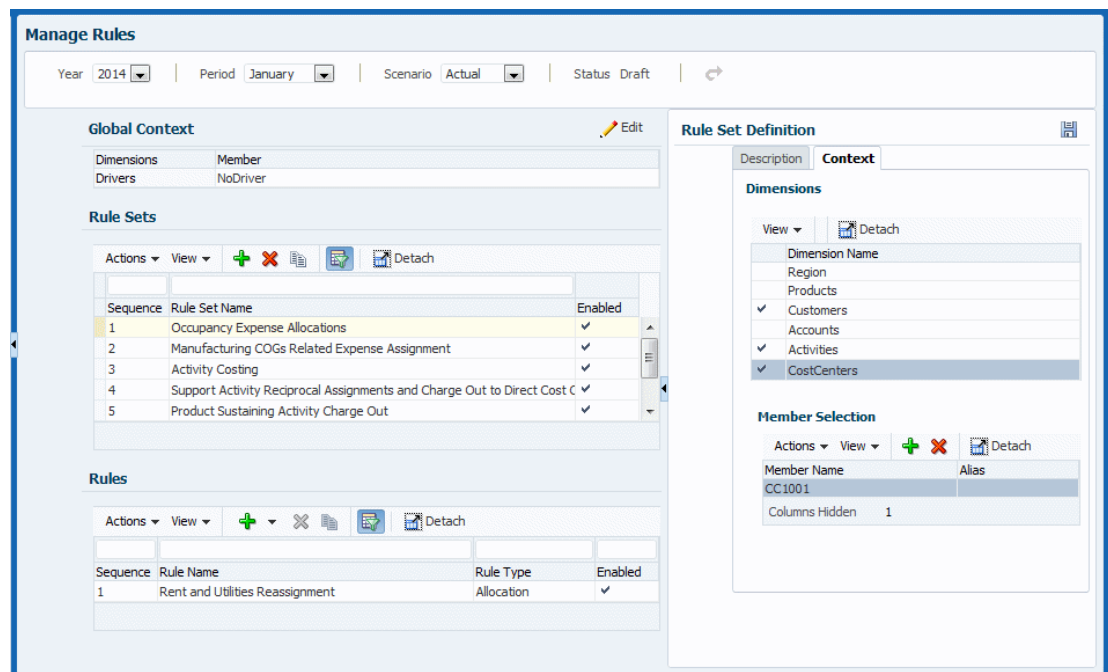

Managing Rule Set Contexts

You can add members to and delete them from dimensions already added to a rule set context.

To add members to a rule set context:

1. Open the **Manage Rules** content area for a selected POV.
2. Select a rule set and display its **Context** tab.
3. Follow steps 4 through 8 in the previous instructions for adding a member.

To delete members from a rule set context:

1. Select a rule set and open its **Context** tab.
2. Select a dimension and member, and then click  or select **Actions** and then select **Delete Member**.

The member is deleted without confirmation.

3. Click  (Save).

Defining and Managing Calculation Rules in Management Ledger Models

In Management Ledger Profitability models, there are two types of calculation rules, allocation rules and custom calculation rules.

Allocation rules determine the source and destination of allocated data, which drivers are applied to that data, and where offsets are placed to balance accounts ([Creating Management Ledger Allocation Rules](#)). Management Ledger allocations differ from those in other types of Oracle Hyperion Profitability and Cost Management models in that there are no stages or revenue and cost layers. All the functionality of the other types is handled through the **Manage Rules** content area, a simple user interface with multiple tabs for different allocation tasks.

Custom calculation rules contain formulas in MDX format and are primarily used for adjusting data ([Creating Management Ledger Custom Calculation Rules](#)).

Both types of calculation rules are organized under rule sets. Rule sets run in their sequence number order, and then the rules within a set run in the order of their sequence numbers. Rules with the same sequence number can run at the same time, provided the computer hardware allows for parallel execution of processes. Rules can be copied within rule sets.

You can use contexts to define dimension and member defaults for both types of rules, either for all rules in a POV ([Defining Global Contexts for Management Ledger Rules](#)) or for all rules in a rule set ([Defining and Managing Management Ledger Rule Set Contexts](#)). For information about management and running calculation rules, see [Calculating Management Ledger Models](#).

Creating Management Ledger Allocation Rules

Allocation rules form the core of Management Ledger models. They determine how allocated data flows and how drivers determine allocation amounts.

To define allocation rules for one POV in a Management Ledger model:



1. In an open Management Ledger model, select **Manage Rules** in the **Manage Program** group ([About the Management Ledger Manage Rules Areas](#)).
2. In the **Manage Rules** content area ([Figure 1](#), enter the year and period for a valid POV, and then click  (Refresh).
3. In the **Rule Sets** area, select a rule set.
4. Do one of the following.
 - In the **Rules** area, click , and then select **Allocation**, or
 - Select **Actions**, then select **Create Rule**, and then select **Create Allocation Rule** ([Figure 1](#))

Figure 10-8 The Description Tab of the Management Ledger Rule Definition Area



Rule Definition

Description | Source | Destination | Driver Basis | Offset | Rule Context

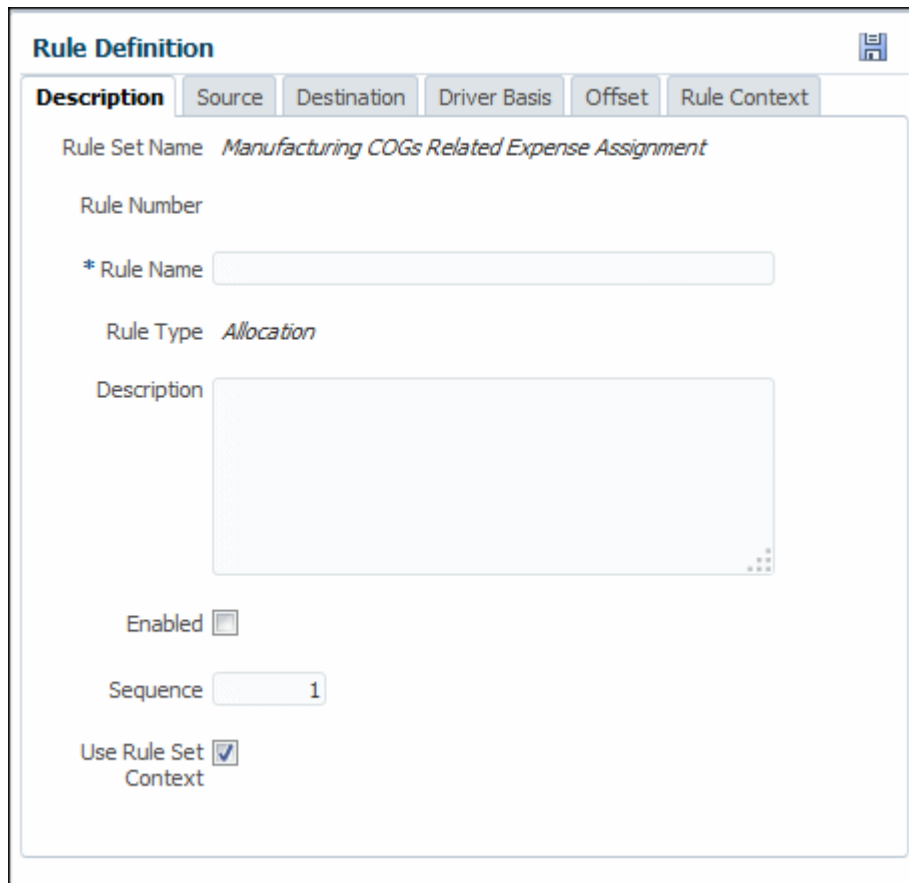
Rule Set Name *Manufacturing COGs Related Expense Assignment*

Rule Number

* Rule Name

Rule Type *Allocation*

Description

Enabled

Sequence

Use Rule Set Context

5. Enter a name for the rule.
6. **Optional:** In the **Description** box, enter a description of the rule set.
7. **Optional:** Select **Enabled** to indicate that the rule is active when the calculation is performed.
8. Enter a **Sequence** number to determine the order in which the rule runs within the rule set.

Rules with the same sequence number will run at the same time if parallel calculation is enabled for the rule set and the computer hardware supports it.

9. If selected, **Use Rule Set Context** indicates that the rule set context is applied to the current rule, if one was defined.

If a global context has been enabled for the rule set, it will also be applied.

10. When the rule set definition is complete, click **Save**, .

To define a source for the allocation rule, see [Defining a Source for Management Ledger Allocation Rules](#).

To edit and delete rules, see [Managing Management Ledger Rules](#).

To create a custom calculation rule, see [Creating Management Ledger Custom Calculation Rules](#).

Defining a Source for Management Ledger Allocation Rules

[Creating Management Ledger Allocation Rules](#) describes how to create and describe a new allocation rule. The next step is to define an allocation source, the dimensions with the expense or other data you are assigning to an allocation destination.

To define the source from which the calculation rule will retrieve data to be allocated:

1. In an open allocation rule, click the **Source** tab ([Figure 1](#)).

Figure 10-9 The Source Tab of the Management Ledger Allocation Rule Definition Area

Rule Definition

Description **Source** Destination Driver Basis Offset Rule Context

Rule Name *Furnishings and Equipment*

Rule Set Name *Occupancy Expense Allocations*

Specify Allocated Amount

Dimensions

View ▾ Detach

Dimension Name
Accounts
CostCenters

Member Selection

Actions ▾ View ▾ + × Detach

Member Name	Alias
Columns Hidden	1

Filter

Actions ▾ View ▾ + ✎ × Detach

Condition	Parameter	Operator	Value
No Data to Display			

2. Select the dimension and member that holds the data to be allocated.
3. **Optional:** Filter the members in the **Member Selection** area. See "Filtering Dimension Members" at the end of this topic.
4. When the rule source information is complete, click (Save).
5. The next step is to enter a **Destination** for the allocated data.

Figure 2 shows that Furnishings and Equipment in the Occupancy Expense Allocations rule set will pull data from the CC2001 and CC5001 members of the CostCenters dimension.

Figure 10-10 Management Ledger Allocation Source Definition Example

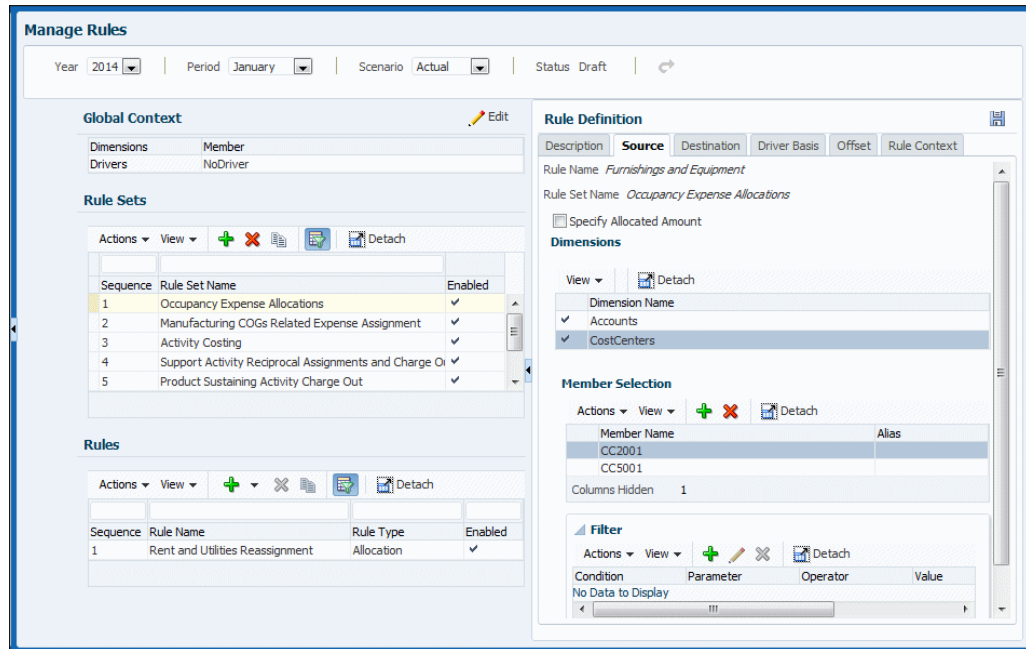

To define a destination for the allocation rule, see [Defining a Destination for Management Ledger Allocation Rules](#).

To edit and delete rules, see [Managing Management Ledger Rules](#).

Filtering Dimension Members

Follow these steps to filter members in the **Member Selection** area of the **Rule Definition** screen:

1. At the bottom of the **Rule Definition** area, click the arrow in front of **Filter** to expand the **Filter** area.
2. To add a filter, click **+** or select **Actions** and then select **Add Filter**.
Select a parameter such as **Name**, an **Operator** such as = or <>, and then enter a **Value** such as the first few letters of a name. Click **OK** to display members that match **Value** and add the filter to the table.
3. To edit a filter, select it and click **✎**. Change the filter as you want and then click **OK**.
4. To delete a filter, select it and click **✖**. The filter is deleted.

Defining a Destination for Management Ledger Allocation Rules

[Defining a Source for Management Ledger Allocation Rules](#) describes how to enter the data source for a Management Ledger allocation. The next step is to define an allocation destination, the dimensions to receive the expense or other data you are pulling from the allocation source.

To define the destination to which the allocation rule will assign data:

1. In an open rule, click the **Destination** tab (Figure 1).

Figure 10-11 The Destination Tab of the Management Ledger Allocation Rule Definition Area

Rule Definition

Description Source **Destination** Driver Basis Offset Rule Context

Rule Name *Furnishings and Equipment*

Rule Set Name *Occupancy Expense Allocations*

Dimensions

View ▾ Detach

Dimension Name	Same As Source
Accounts	<input type="checkbox"/>
CostCenters	<input type="checkbox"/>

Member Selection

Actions ▾ View ▾ + × Detach

Member Name	Alias
Columns Hidden	1

Filter

2. Select the dimension and member that are to receive the allocated data.
3. **Optional:** Select **Same As Source** if the destination dimension is the same as the source.
4. **Optional:** Filter the data as described in [Defining a Source for Management Ledger Allocation Rules](#), step 3.
5. When the rule destination information is complete, click (Save).
6. The next step is to enter a **Driver Basis** for the allocated data.

Figure 2 shows one of the destinations of allocated data for the Furnishings and Equipment rule—the CostCenters dimension and various members named CC followed by a number.

Figure 10-12 Management Ledger Allocation Destination Definition Example

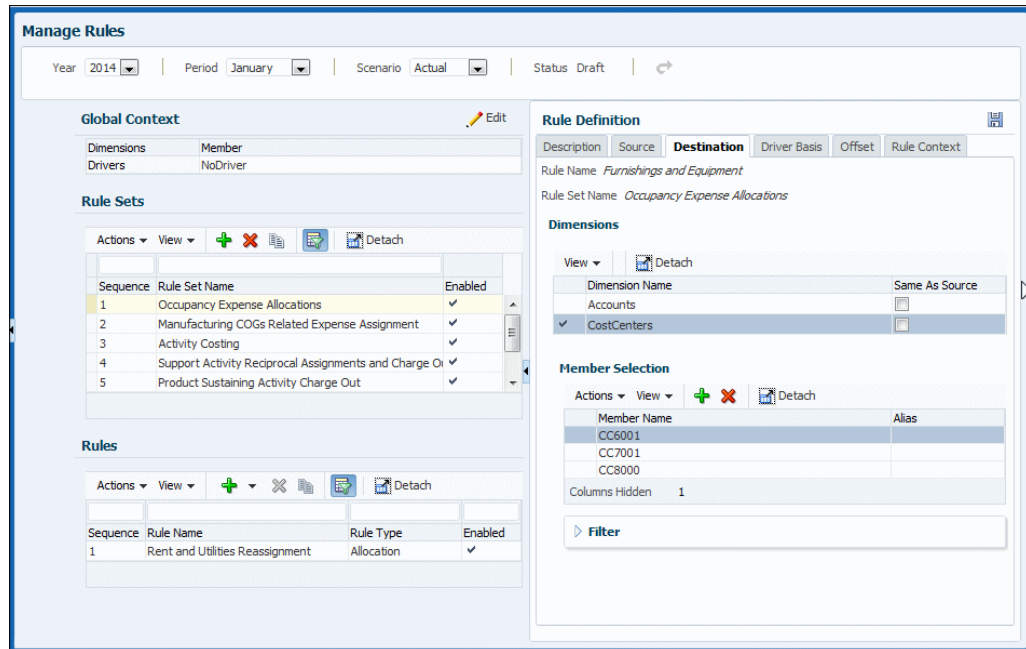

To enter a driver basis for the rule, see [Defining a Driver Basis for Management Ledger Allocation Rules](#).

To edit and delete rules, see [Managing Management Ledger Rules](#).

Defining a Driver Basis for Management Ledger Allocation Rules

[Defining a Destination for Management Ledger Allocation Rules](#) describes how to enter the data destination for a Management Ledger allocation. The next step is to define an allocation driver basis, the member where driver values are found.

For Management Ledger models, Oracle Hyperion Profitability and Cost Management assumes a focus on the destination. The dimension and member selection on the **Driver Basis** tab represents a change to the destination that defines where the driver is located. For example, if the allocation destination is the intersection of the Sales department and Salaries account, the Driver Basis definition is the Headcount account member. By default, data is allocated to the destination proportionally, using the ratio of the driver value for that member divided by the sum of all driver values. You can choose to allocate data evenly, which is the same as if the driver ratio was 1.

Typically, systems are set up so that one member from one dimension, usually the Accounts dimension, contains the statistical members associated with any intersection. Only one member can be selected for each dimension.

To define the driver basis for a Management Ledger allocation rule:

1. In an open rule, click the **Driver Basis** tab ([Figure 1](#)).

Figure 10-13 The Driver Basis Tab of the Management Ledger Allocation Rule Definition Area

Rule Definition

Description | Source | Destination | **Driver Basis** | Offset | Rule Context

Rule Name *Furnishings and Equipment*

Rule Set Name *Occupancy Expense Allocations*

Specify Driver Location
 Allocate Evenly

Dimensions

View ▾ | Detach

Dimension Name
Balance
Rule
Drivers
Year
Region
Scenario
Period
Products
Customers
Accounts
Activities
CostCenters

Member Selection

Actions ▾ | View ▾ | + | × | Detach

Member Name	Alias
Columns Hidden	1

2. Select whether data should be allocated by ratio (**Specify Driver Location**) or allocated evenly (**Allocate Evenly**).
3. If you selected **Specify Driver Location**, select the dimension and member that holds the driver data, for example Headcount.
4. When the rule source information is complete, click  (Save).
5. The next step is to enter an **Offset** for the allocation, an optional task.

Figure 2 shows the location of a driver to be applied when allocating data for the Furnishings and Equipment rule, the Statistics member of the Accounts dimension.

Figure 10-14 Management Ledger Driver Location Selection Example

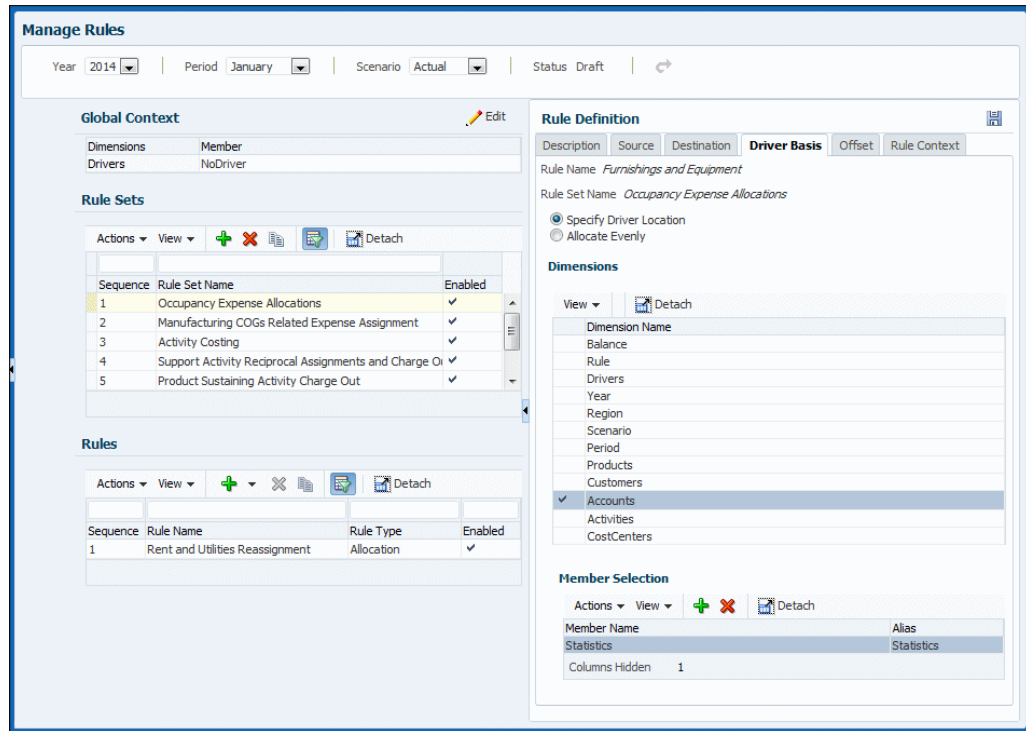

To enter an offset for the rule, see [Defining an Allocation Offset for Management Ledger Allocation Rules](#).

To edit and delete rules, see [Managing Management Ledger Rules](#).

Defining an Allocation Offset for Management Ledger Allocation Rules

[Defining a Driver Basis for Management Ledger Allocation Rules](#) describes how to select drivers that determine allocation amounts for Management Ledger models. The next step is to define an allocation offset location, the member to hold an increase to balance a corresponding decrease in the allocation source. By default, offsets are written to the source but you can specify another location. This step is optional.

The offset location definition assumes a focus on the source with the option to select an alternate location. For example, suppose the allocation source is the Sales department intersecting the Salaries account. The default location for the offset would be the intersection of Salaries and Sales. However, you could specify Outbound Allocations of the Sales department instead. By specifying that single change, you are instructing the system to write the offset entry at the source, except you are changing the target location so the offset is written to the intersection of Outbound Allocations and Sales dimension instead of the source.

To define the offset for a Management Ledger allocation rule:

1. In an open allocation rule, click the **Offset** tab ([Figure 1](#)).

Figure 10-15 The Offset Tab of the Management Ledger Allocation Rule Definition Area

Rule Definition 

Description Source Destination Driver Basis **Offset** Rule Context

Rule Name *Furnishings and Equipment*

Rule Set Name *Occupancy Expense Allocations*

Offset Location

Source



Alternate Offset Location

Dimensions

View ▾  Detach

Dimension Name
Drivers
Region
Products
Customers
Accounts
Activities
CostCenters

Member Selection

Actions ▾ View ▾    Detach

Member Name	Alias
Columns Hidden	1

2. Select whether offset data should be written to the **Source** intersection, or to an **Alternate Offset Location**.
3. If you selected **Alternate Offset Location**, select the dimension and member to hold the driver data.
4. When the rule source information is complete, click  (Save).

To view any context definitions for a rule, see [Viewing Contexts for Management Ledger Rules](#).

To edit and delete rules, see [Managing Management Ledger Rules](#).

Viewing Contexts for Management Ledger Rules

[Defining Global Contexts for Management Ledger Rules](#) and [Defining and Managing Management Ledger Rule Set Contexts](#) describe how to select default dimensions and members to be applied to Management Ledger rules for a given POV.

To view contexts applied to a selected rule:

1. If a rule is not already selected and open, open one.
2. Click the **Rule Context** tab.

The displayed information is not editable.

To perform other rule definition tasks, see [Defining and Managing Calculation Rules in Management Ledger Models](#).

To edit and delete rules, see [Managing Management Ledger Rules](#).

Creating Management Ledger Custom Calculation Rules

Calculation rules form the core of Management Ledger models. [Creating Management Ledger Allocation Rules](#) describes how to create allocation rules. They determine how allocated data flows and how drivers determine allocation amounts. This section describes how to create custom calculation rules.

Unlike allocation rules, custom calculation rules do not have a defined source and destination with options for defining a driver basis and accounting offset. Instead, custom calculation rules enable users to define calculations to be performed in a certain region of the database with results posted to a specific member. Custom calculation rules are used primarily for adjusting existing data to create a scenario or to accommodate reporting requirements.

As with allocation rules, a Rule dimension member is linked to the custom calculation rule. Any data created by the custom calculation rule is written to the corresponding Rule dimension member.

Custom calculation rules have the following components that correspond to the tabs in the Rule Definition area:

- **Description** — Rule name and number, text description, and rule-level options (described later in this topic)
- **Target** — The target range in the database that the rule will affect ([Defining a Target for Management Ledger Custom Calculation Rules](#))
- **Formula** — The member to which results of the calculation are written and the mathematical expression of the calculation ([Defining Formulas for Management Ledger Custom Calculation Rules](#))
- **Rule Context** — Enables you to view any Global or Rule Set contexts defined for the custom calculation rule ([Viewing Contexts for Management Ledger Custom Calculation Rules](#))

Like allocation rules, custom calculation rules belong to rule sets, have sequence numbers, inherit contexts, can be activated or deactivated with the **Enabled** setting, and have the same rule set execution options (serial, parallel, iterative). Custom calculation rules can be copied and deleted in the same way as allocation rules ([Managing Management Ledger Rules](#)).

To define custom calculation rules for one POV in a Management Ledger model:



1. In an open Management Ledger model, select **Manage Rules** in the **Manage Program** group.
2. In the **Manage Rules** content area (Figure 1, enter the year and period for a valid POV, and then click  (Refresh).
3. In the **Rule Sets** area, select a rule set.
4. Do one of the following:
 - In the **Rules** area, click , and then select **Custom Calculation**, or
 - Select **Actions**, then select **Create Rule**, and then select **Create Custom Rule**.
 The **Description** tab of the Rule Definition area is displayed (Figure 1)

Figure 10-16 The Description Tab of the Management Ledger Custom Calculation Rule Definition Area



The screenshot shows the 'Rule Definition' window with the 'Description' tab selected. The form contains the following elements:

- Rule Set Name:** Activity Costing
- Rule Number:** (empty field)
- * Rule Name:** (text input field)
- Rule Type:** Custom Calculation
- Description:** (large text area)
- Enabled:**
- Sequence:**
- Use Rule Set Context:**

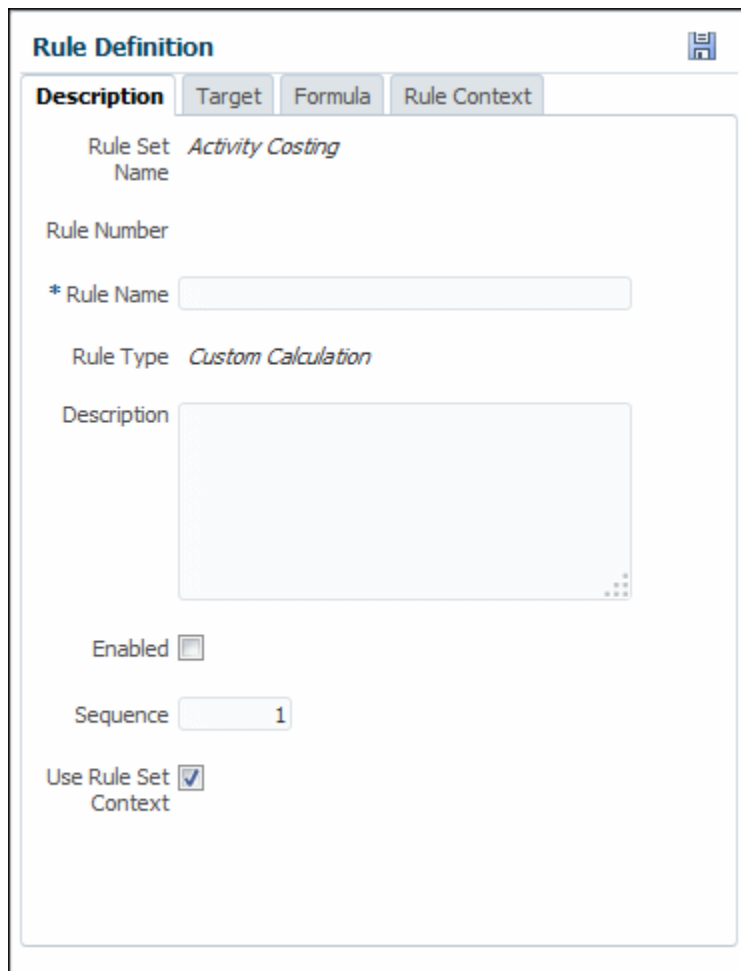
5. Enter a name for the rule.
6. **Optional:** In the **Description** box, enter a description of the rule set.
7. **Optional:** Select **Enabled** to indicate that the rule is active when the calculation is performed.

8. Enter a **Sequence** number to determine the order in which the rule runs within the rule set.

Rules with the same sequence number will run at the same time if parallel calculation is enabled for the rule set and the computer hardware supports it.

9. If selected, **Use Rule Set Context** indicates that the rule set context is applied to the current rule, if one was defined.

If a global context has been enabled for the rule set, it will also be applied.

10. When the rule set definition is complete, click **Save**, .

To perform the next rule definition task, see [Defining a Target for Management Ledger Custom Calculation Rules](#).

To edit and delete rules, see [Managing Management Ledger Rules](#).

Defining a Target for Management Ledger Custom Calculation Rules

[Creating Management Ledger Custom Calculation Rules](#) describes how to complete the **Description** tab for a Management Ledger custom calculation rule. The next step is to define a calculation target, the range of dimensions that are affected by the custom calculation rule.

To define the target which the custom calculation rule will affect:

1. In an open custom calculation rule, click the **Target** tab ([Figure 1](#)).

Figure 10-17 The Target Tab of the Management Ledger Custom Calculation Rule Definition Area

Rule Definition 



Description **Target** Formula Rule Context

Rule Name *CC Rule 1*

Rule Set Name *Activity Costing*





Result Dimension CostCenters 

Dimensions

View   Detach

Dimension Name
Balance
Accounts
Activities

Member Selection

Actions  View     Detach

Member Name	Alias
Columns Hidden	1

 **Filter**

2. Select the dimensions and members that will be affected by the custom calculation formula.
3. **Optional:** Filter the data as described in [Defining a Source for Management Ledger Allocation Rules](#).
4. When the rule target information is complete, click  (Save).
5. The next step is to enter a **Formula** for the custom calculation rule.

To perform the next rule definition task, see [Defining Formulas for Management Ledger Custom Calculation Rules](#).

To edit and delete rules, see [Managing Management Ledger Rules](#).

Defining Formulas for Management Ledger Custom Calculation Rules

[Defining a Target for Management Ledger Custom Calculation Rules](#) describes how to enter a range of dimensions and members that are affected by a Management Ledger custom calculation rule. The next step is to define the calculation formula for the rule.

To define the formula for a Management Ledger custom calculation rule:

1. In an open custom calculation rule, click the **Formula** tab (Figure 1).

Figure 10-18 The Formula Tab of the Management Ledger Custom Calculation Rule Definition Area

The screenshot shows a window titled "Rule Definition" with a save icon in the top right corner. Below the title bar are four tabs: "Description", "Target", "Formula" (which is selected and highlighted), and "Rule Context". A blue question mark icon is in the top right of the main area. The main area contains the following text: "Rule Set: Activity Costing", "Name", "Rule Name: CC Rule 1", and "* Formula" followed by a large, empty text input field. At the bottom right of the input field is a "Validate Formula" button.

2. Enter the formula as a text string (see [Management Ledger Custom Calculation Rule Formula Syntax](#) for format information).
3. Select **Validate Formula** to determine if the formula is valid.
For details, see [Custom Calculation Rule Formula Validation Requirements](#).
4. When the formula is complete, click  (Save).



Note:

Following rule calculation, you can define appropriate model views and use the **Rule Balancing** or **Manage Queries** task areas to view custom calculation rule results.

To view context definitions for the custom calculation rule, see [Viewing Contexts for Management Ledger Custom Calculation Rules](#).

To edit and delete rules, see [Managing Management Ledger Rules](#).

Management Ledger Custom Calculation Rule Formula Syntax

The syntax, or format, for custom calculation rules is summarized as follows:

- The basic formula format is Result = Target.
- The left side of the equation is the Result, the member to which the result is written. It is only a single Level 0 member in the following format:

```
</MemberName/>
```

- The right side of the equation is the Target. It includes the other members, tuples, or constants at any level and the mathematical expression to perform.

The Target is an MDX numeric value expression, where MDX is a joint specification of the XML for Analysis founding members. For more information about allowable MDX syntax, see the *Oracle Essbase Technical Reference*.

- Each member or tuple is surrounded by `</ />` special characters. If the tuple or member does not contain a Rule dimension member, the top of the Rule dimension will be considered a member of Target. All results are written to the Result member intersection with the new Rule member for the custom calculation rule being defined. For formula requirements, see [Custom Calculation Rule Formula Validation Requirements](#)

- Custom calculation rules support the following syntax formats for member names:

- **No qualification:** Only the member name is provided.

Example: `</MemberName/>`

- **Partial qualification:** Dimension name + member name.

Example: `</Dimension.MemberName/>`

- **Full qualification:** The fully qualified name (FQN) for the member.

Example: `</Dimension.[Gen2].[Gen3.]Gen4...]MemberName]/>`

Examples

The following are examples of different kinds of expressions:

- A constant:

```
</Adjustment In/> = 100
```

- A single member:

```
</Adjustment In/> = </Input/> * 0.15
```

- A tuple:

```
</Adjustment In/> = </Input,2013,Budget/> * 1.15
```

- Multiple tuples in a calculation:

```
</Adjustment In/>=</Input,Total Year,Budget/>*(</Input,2013,Jan,Budget/>/</Input,2013,Total Year,Budget/>)
```

Custom Calculation Rule Formula Validation Requirements

When you click **Validate Formula**, Oracle Hyperion Profitability and Cost Management checks for the following:

- The **Target** tab of the custom calculation rule **Rule Definition** task area must have all dimensions selected except the one used for the formula Result.
- The formula Result term must not contain a tuple. For example, the following is not allowed:

$\langle /A11, B11 / \rangle = \langle A11 \rangle * 3$

- Parent members are not allowed in the formula Result term. For example, the following is not allowed assuming that A1 is a parent member:

$\langle /A1 / \rangle = \langle A11 \rangle * 3$

- In the Target, single-member references can only be members from the Result dimension. Tuples must include a member from the Result dimension. For example, the following formulas are invalid and valid as noted:

Invalid formula: $\langle /A11 / \rangle = \langle B11 \rangle * 3$

Valid formulas: $\langle /A11 / \rangle = \langle A11, B11 \rangle * 3$; $\langle /A11 / \rangle = \langle A41, B11 \rangle * 3$; $\langle /A11 / \rangle = \langle A21 \rangle * 3$

- Valid arithmetic operators are the following:

+, -, *, /

Target and Result terms are separated by a valid equal sign (=). Only one = sign is allowed in a formula.

When a model has duplicate members across dimensions, partially or fully qualified names must be used (see [Management Ledger Custom Calculation Rule Formula Syntax](#)).

In the Result term, only a Target term dimension member is allowed.

In the Result term, there must be one Level 0 member of the Result dimension.

The Target formula must contain valid dimension members in a valid format, as outlined here and in the *Oracle Essbase Technical Reference*.

Viewing Contexts for Management Ledger Custom Calculation Rules

[Defining Global Contexts for Management Ledger Rules](#) and [Defining and Managing Management Ledger Rule Set Contexts](#) describe how to select default dimensions and members to be applied to Management Ledger rules for a given POV.

To view contexts applied to a selected custom calculation rule:

1. If a custom calculation rule is not already selected and open, open one.
2. Click the **Rule Context** tab.

The displayed information is not editable.



For general information about custom calculation rules, see [Defining and Managing Calculation Rules in Management Ledger Models](#)

To edit and delete allocation and custom calculation rules, see [Managing Management Ledger Rules](#).



Managing Management Ledger Rules

Previous sections describe how to create rules. You can also delete and copy rules.

To delete a rule:

1. Display the **Manage Rules** content area ([About the Management Ledger Manage Rules Areas](#)).
2. Enter a POV and select a rule set.
3. In the **Rules** area, select a rule.
4. Click  or select **Actions** and then **Delete Rule**.
5. Confirm that you want to delete the rule.
6. Click  (Save).

To copy a rule:

1. In the **Manage Rules** content area, enter a POV and select a rule set.
2. In the **Rules** area, select a rule.
3. Click  or select **Actions** and then **Copy Rule**.
4. Enter a name for the new rule.
5. Click **OK**, and then click  (Save).

Tracing Management Ledger Profitability Allocations

The Trace Allocations task area of Management Ledger Profitability enables you to select a model view and POV and then trace forward or back from that point to see allocation inputs and outputs for a selected dimension.

While rule balancing, described in [Rule Balancing for Management Ledger Profitability Application Validation](#) presents some similar information in a grid format, the Trace Allocations feature shows graphically how allocation amounts are flowing in and out of model elements. You can use this information for evaluation and validation. When you trace, you can select a particular generation level or always roll up data to the top. For details, see the listed topics.

About Tracing Management Ledger Allocations

You begin an allocation trace by selecting a focal node, defined by the POV and model view entered into the **Trace Allocations** task area. You can trace forward or back from the focal node.

When you trace back, you display allocations that contribute to the selected dimension of the focal node. The first level back from the focal node is the rule node, which shows the contribution from each rule. The next level back from the rule node is the dimension node. Dimension nodes show the contribution from each member for the selected dimension at the top level or the selected generation or level ([Figure 1](#)).

Note:

This figure is a "zoomed out" view to display many nodes. You can zoom in to view details and can move the chart around the screen to focus on different parts ([Performing a Management Ledger Allocation Trace](#)).

Figure 10-19 Trace Allocations Area with Nodes, Tracing Back

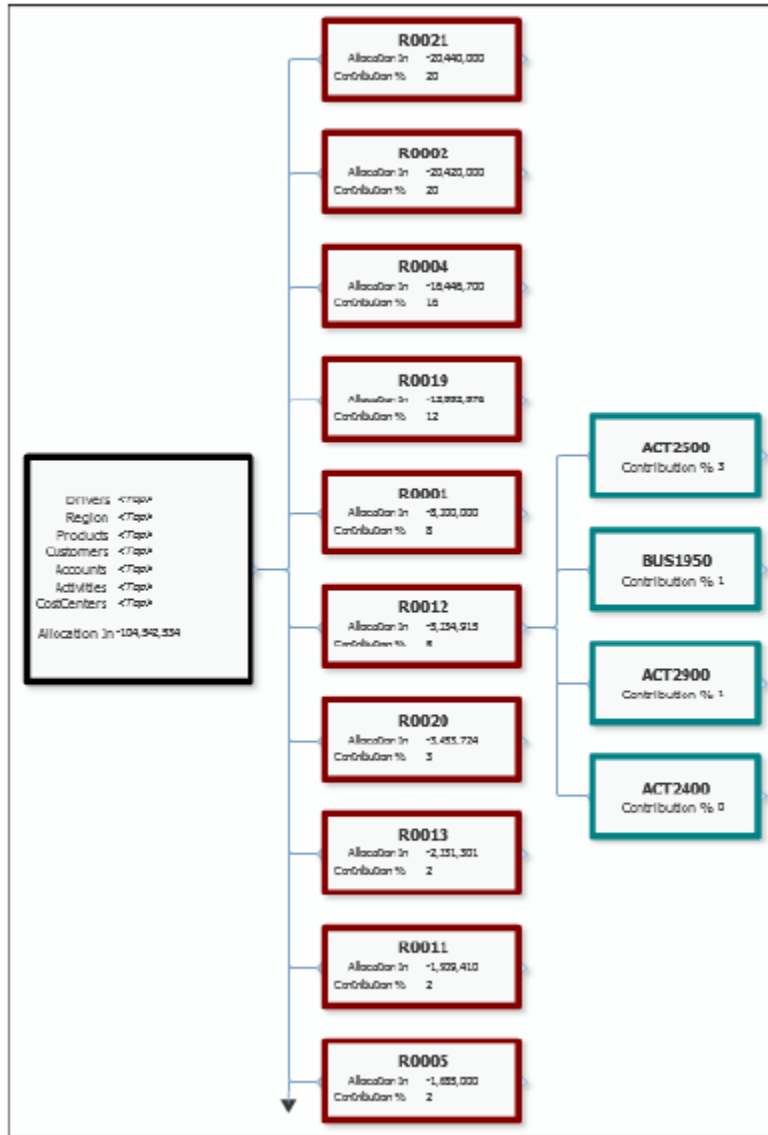

In default layout, the nodes display in columns. The single focal node is followed by a column of rule nodes, and then by a column of dimension nodes for the expanded rule node. The rule nodes and dimension nodes display the percentage of their contribution to the value in the focal node.

When you trace forward from the focal node, the rule nodes and dimension nodes display contributions (Allocations Out) from their predecessors — from the focal node to the rule nodes, and then from the rule nodes to the dimension nodes.

Performing a Management Ledger Allocation Trace

To perform a trace:

1. Open a Management Ledger Profitability model, and then select **Trace Allocations** in the **Manage Program** task area (Figure 1).

Figure 10-20 Management Ledger Trace Allocations Task Area

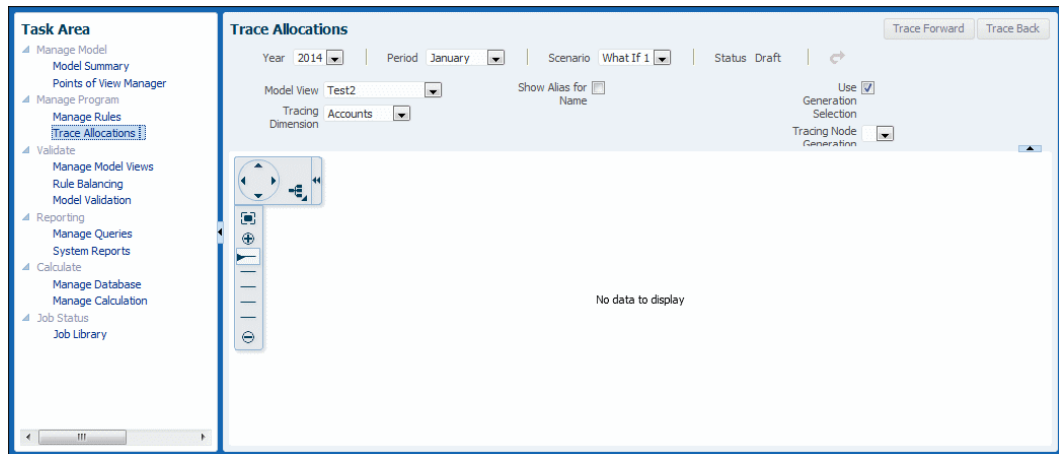

2. In the **Trace Allocations** area, select POV information and a model view for the focal mode, the starting point for the trace ([About Tracing Management Ledger Allocations](#)).
3. Click  to validate your selection.
4. Select a **Tracing Dimension**, the dimension of interest for your trace.
5. Indicate whether you want to use aliases instead of names.
6. Indicate whether you want to select a particular node level or just display the top level (0) for each node.
7. Click **Trace Forward** or **Trace Back**, depending on whether you want to trace allocations coming from the focal node or contributing to it ([About Tracing Management Ledger Allocations](#)).
8. View the trace results ([Viewing Management Ledger Allocation Trace Results](#)). You can zoom or move around the results to show more or less detail or a different part of the chart.

To trace further, you can change the POV, model view, dimension, or generation level. For example, you could make a dimension member the focal node for a new trace.

Viewing Management Ledger Allocation Trace Results

When you first perform a trace, the focal node is displayed (Figure 1).

Figure 10-21 Management Ledger Allocation Trace Focal Node

Drivers	<Top>
Region	<Top>
Products	<Top>
Customers	<Top>
Accounts	<Top>
Activities	<Top>
CostCenters	<Top>
Input	9,746,554
Adjustment In	0
Adjustment Out	0
Allocation In	-104,542,534
Allocation Out	104,542,534
Allocation Offset	0
Balance	9,746,554

At full size (100% "zoom"), the focal node shows the following: model view, dimension members, balance, input, adjustment in, adjustment out, allocation in, allocation out, and allocation offset amount.

If the focal node is only partially visible, you can use the **Zoom and Center** tool to move it:

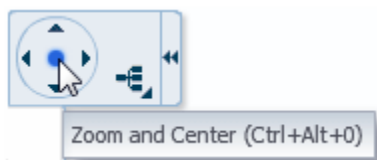

Click the dot in the center to center the chart. Click the arrows to move the chart background. This has the effect of moving the chart in the opposite direction.

When you point to the middle of the right edge of the focal node, a + (plus) sign is displayed:



You can click the + sign to expand the chart and show the rule nodes (Figure 2).

Figure 10-22 Management Ledger Allocation Trace Rule Node

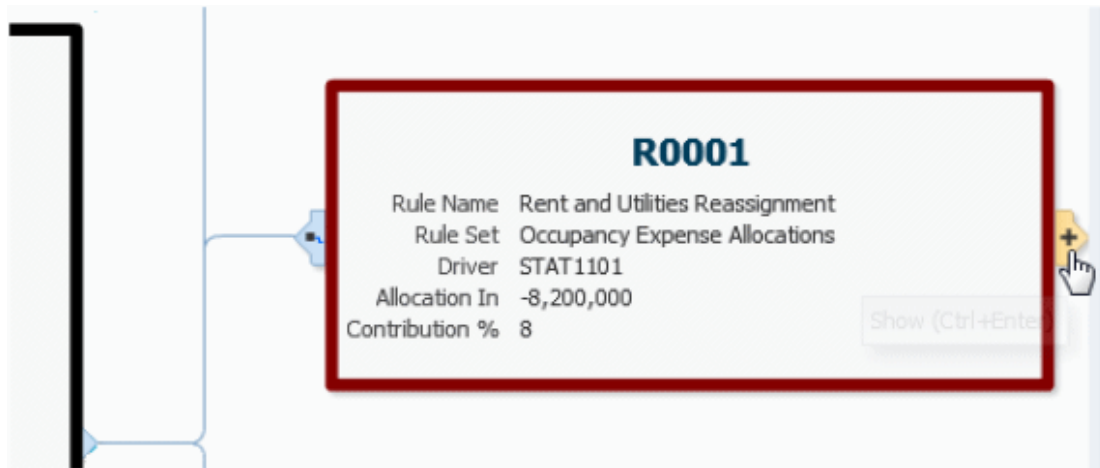

At 100% zoom, a rule node shows the rule number, name, and rule set. It also shows the allocation driver, allocation in (back trace, allocation out (forward trace), and the contribution to the total allocation shown in the focal node.

If you point to the right edge of the rule node, you can click the + sign to show the dimension nodes (Figure 3). If you click the symbol on the left side, the rule node detaches and is displayed without the rest of the chart. Click the arrow symbol to return to the chart view.



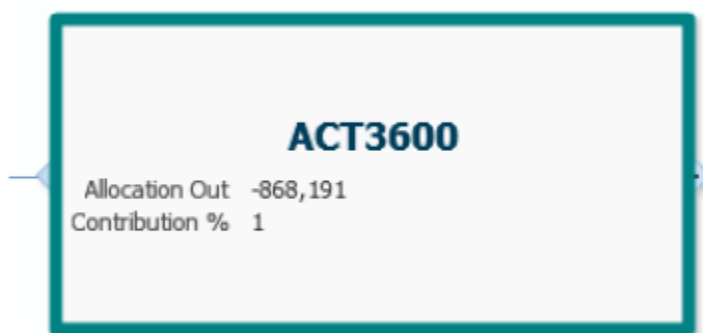

Figure 10-23 Management Ledger Allocation Trace Dimension Node



At 100% zoom, the dimension nodes show the member name, allocation out (back trace), allocation in (forward trace), and percent of contribution to or from the focal node. If you click the symbol on the left edge of the node, it detaches from the rest of the chart. Click the arrow to restore it. A + sign on the right edge shows that there are additional levels to the dimension. However, if you click it, no further expansion occurs; the chart is already expanded to its limit.

Additional Chart Controls

The remaining chart controls perform the following actions:

-  — Changes the configuration of the node tree
-  — Zooms out to display as much of the chart as possible. Up to ten rule and dimension nodes are displayed; arrows following the last node of each type indicate that there are more to display.
-  — When clicked, enlarges the chart by a step (zooms in)
-  — When clicked, shrinks the chart by a step (zooms out)

 **Note:**

As you zoom in and out, an arrow moves between the two Zoom icons to show the relative degree of "zoom".

-  — Hides the control panel; click to show it again

For Zoom levels of 100%, 75%, and 50%, hyperlinks display for Allocation In and Allocation Out amounts on the focal node and rule nodes. You can click these to launch Oracle Smart View for Office as described in [Running Queries from the Management Ledger Rule Balancing Screen](#).

Validating Management Ledger Models

Related Topics

- [About Management Ledger Model Validation](#)
Two Oracle Hyperion Profitability and Cost Management features help you validate Management Ledger models.
- [Creating and Managing Management Ledger Model Views](#)
You can create and manage Management Ledger model views.
- [Rule Balancing for Management Ledger Profitability Application Validation](#)
Rule balancing can help you validate Management Ledger Profitability models in several ways.
- [Performing Model Validation Analysis for Management Ledger Models](#)
After a Management Ledger Profitability model is deployed, it can become invalid if dimensions that are used in model artifacts are deleted or renamed.

About Management Ledger Model Validation

Two Oracle Hyperion Profitability and Cost Management features help you validate Management Ledger models.

- Rule balancing enables you to view dimension/member combinations within your model to confirm that allocations are working the way you expect ([Rule Balancing for Management Ledger Profitability Application Validation](#)).
- Validation and system reports enable you to identify and diagnose logic and system issues ([Performing Model Validation Analysis for Management Ledger Models](#)).

Model views assist with rule balancing and queries ([Creating and Managing Management Ledger Model Views](#)).

Creating and Managing Management Ledger Model Views

You can create and manage Management Ledger model views.

Related Topics

- [About Model Views](#)
- [Creating Model Views](#)
- [Managing Model Views](#)

About Model Views

The Model Views feature of Management Ledger Profitability applications enables users to define a slice of the model that can return data from a particular area of the database. Model views can be saved, copied, and modified. They can then be used in other tasks, such as rule balancing, to identify dimensions and members to retrieve. For more information, see [Creating Model Views](#) and [Managing Model Views](#).

Creating Model Views

To create a model view:

1. In an open model, select **Manage Model Views** in the **Validation** group of the **Task Area**.
2. In the **Manage Model Views** area, click  or select **Create Model View** in the **Actions** menu.
3. In the **Model View** area, enter a **Model View Name** and an optional **Description** (Figure 1).

Figure 11-1 Information Required to Create a Model View



4. For your convenience, use the up and down arrows in the **Dimensions** area to move selected dimensions toward the top or the bottom of the list.

If there are many dimensions, you may find it helpful to move the most used ones toward the top.

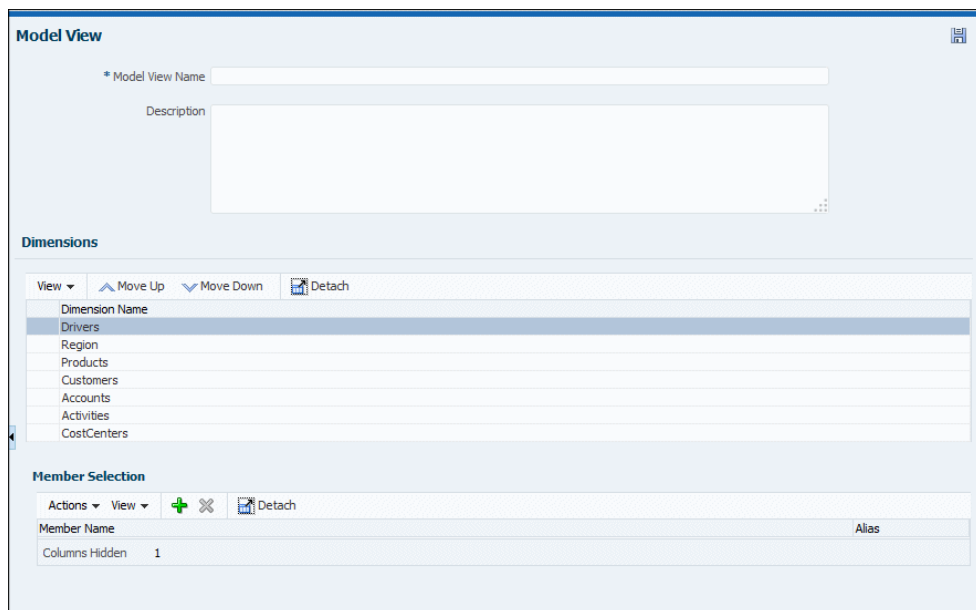
 **Note:**

You can use the **View** menus to hide, show, and change the order of columns.



5. To add dimension members to the view, select a dimension and click  in the **Member Selection** area, or select **Add Member** in the **Actions** menu.
6. In the **Select Dimension Members** dialog box, select members and use the right and left arrows of the shuttle control to move members from the list of available members at the left to the list of selected members at the right (Figure 2).

Figure 11-2 Select Dimension Members Dialog Box for Model Views

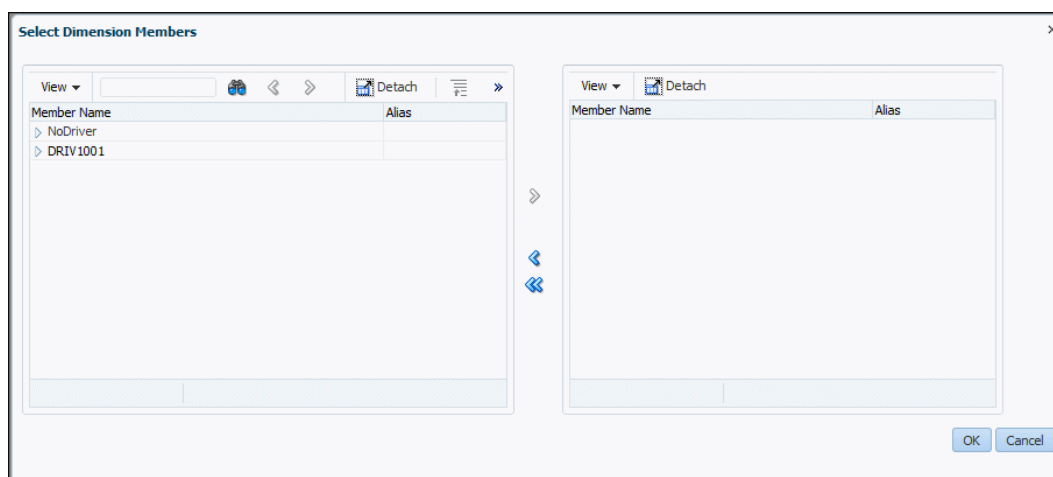

7. When members have been selected, click **OK**.
8. **Optional:** Click  or use the **Action** menu in the **Member Selection** area of the **Model View** panel to remove previously added members.
9. When changes are complete, click .

To delete, copy, or modify a model view, see [Managing Model Views](#).

Managing Model Views

To create a model view, see [Creating Model Views](#).

To delete, copy, or modify a model view:

1. In an open model, select **Manage Model Views** in the **Validation** group of the **Task Area**.
2. Select a model view in the **Manage Model Views** area
3. **Optional:** To delete the selected model view, click  or select **Delete Model View** in the **Actions** menu and confirm the deletion.
4. **Optional:** To copy the selected model view, click  or select **Copy Model View** in the **Actions** menu and enter a name for the new model view.
5. **Optional:** To modify the selected model view, change appropriate information for it in the **Model View** panel at the right side of the screen.
6. When changes are complete, click .

Rule Balancing for Management Ledger Profitability Application Validation

Rule balancing can help you validate Management Ledger Profitability models in several ways.

- Calculation results validation — Following a calculation, you can validate the results by reviewing calculation results for individual rules, reviewing the impacts of those rules, and evaluating the effect of all rules on a particular slice of the database. You can verify that the calculations are producing expected results and also determine if the collection of rules is affecting the database slice as expected.
- Contribution analysis and trace — Using the same screen and isolating a segment of the database, you can evaluate the balances at that segment and how the rules contributed to the final result. Then, you can use this information to relate final results to individual rules to trace the effects of model logic on the final allocation results.

To display rule balancing data, calculate the model and then follow these steps:

1. In the **Task Area**, select **Validate**, and then **Rule Balancing**.
The **Rule Balancing** task area is displayed (Figure 1).

Figure 11-3 Management Ledger Rule Balancing Screen

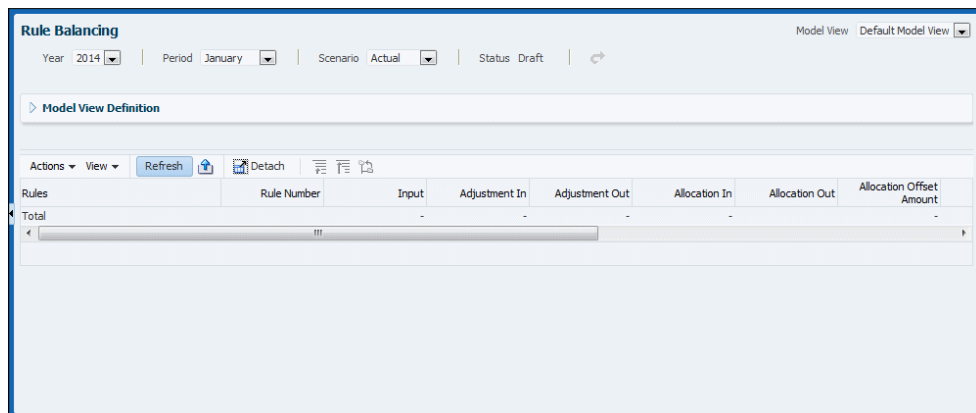

2. Select a **Model View** from the list at the top, and then select a POV (**Year**, **Period**, and **Scenario**, here). Click **Refresh**.
Appropriate values are displayed in the columns (Figure 1).
3. Review the data and manage it as described in [Viewing the Rule Balancing Task Area](#) and [Performing Rule Balancing Tasks](#).

 **Note:**

You can change the POV or Model View to review a different set of data.

For other model validation tasks, see [About Management Ledger Model Validation](#) and [Performing Model Validation Analysis for Management Ledger Models](#).

Viewing the Rule Balancing Task Area

The **Rule Balancing** task area shows how all rules affect the selected slice of the database (Figure 1).

Figure 11-4 Rule Balancing Task Area Screen with Data

The screenshot shows the 'Rule Balancing' task area. At the top, there are controls for 'Year' (2013), 'Period' (Jan), and 'Status' (Draft). Below this is a 'Model View Definition' section with an 'Expand Model View Definition' button. The main area contains a table with columns: Rule Number, Input, Allocation In, Allocation Out, Net Change, Remainder, Running Remainder, Balance, and Running Balance. The table lists rules: NoRule, RS1aaa, and RS2, along with a Total row. The 'Columns Hidden' count is 3.

Rules	Rule Number	Input	Allocation In	Allocation Out	Net Change	Remainder	Running Remainder	Balance	Running Balance
> NoRule		2000.0	-	-	-	2000.0	2000.0	2000.0	2000.0
> RS1aaa		-	4000.0	1846.0	8262.0	8262.0	10262.0	8262.0	10262.0
> RS2		-	102000.0	11846.0	136262.0	136262.0	146524.0	136262.0	146524.0
Total	Rule	2000.00	106000.00	13692.00	-	146524.00		146524.00	

The layout illustrates the sequence of rule sets and rules that ran, the corresponding rule numbers, and the specific impacts of a rule displayed across columns. The columns include input values, additions and subtractions, running total, and final balances. By default, the following data displays: the model POV members selected in the POV bar, the POV's global context, the tops of all other business dimensions, and the balance and rule members corresponding to the rows (rules) and columns (balances) displayed in the table. You can change this view by creating model views that show different slices of data, and then selecting one in the **Model View** list at the top of the task area ([Creating and Managing Management Ledger Model Views](#)).

Table columns are as follows:

- **Rules** — Displays the calculation program as a hierarchy of rule sets and the rules contained within each rule set. You can expand or contract rule sets to see or hide the rules contained within each. The rule sets and rules are displayed in the same order as in the Manage Rules screen when sorted by sequence number. If rule sets or rules have the same sequence number, the secondary sort for this column is the same secondary sort used in the Manage Rules screen.
- **Rule Number** — Displays the rule dimension member corresponding to the rule.
- **Input** — Displays the value of the input member corresponding to the slice indicated by the combination of POV and the rule number of the row. For all rows except the first, Input is typically blank.
- **Adjustment In** — Displays the Adjustment In member corresponding to the slice indicated by the combination of POV and rule number of the row.
- **Adjustment Out** — Displays the Adjustment Out member corresponding to the slice indicated by the combination of the POV and rule number of the row.
- **Allocation In** — Displays the Allocation In member corresponding to the slice indicated by the combination of the POV and the rule number of the row.
- **Allocation Out** — Displays the Allocation Out member corresponding to the slice indicated by the combination of the POV and the rule number of the row.

- **Allocation Offset Amount** — Displays an amount that further reduces an Allocation In member, if one was used in addition to the Allocation Out.
- **Net Change** — Displays the Net Change member corresponding to the slice indicated by the combination of the POV and the rule number of the row.
- **Remainder** — Displays the difference between Allocation In and Allocation Out plus Allocation Offset Amount, if any, for each row.
- **Running Remainder** — Displays the sum of the prior row's running remainder and the current row's net change column. This column serves like a checkbook register to indicate the remainder as of the execution of the rule corresponding to the current row. For rule set summary rows, this column shows the same running remainder as the last rule within that rule set.
- **Balance** — The amount resulting when adjustments, allocations, and offsets are taken into account. It should equal the Input.
- **Running Balance** — Displays the sum of the prior row's running balance and the current row's net change column. This column is similar to a checkbook register to indicate the balance as of the execution of the rule corresponding to the current row. For rule set summary rows, this column shows the same running balance as the last rule within that rule set.

For information about actions you can perform in this task area, see [Performing Rule Balancing Tasks](#).

Performing Rule Balancing Tasks

You can use the Rule Balancing menus and tool bar buttons to perform the following tasks:

- Click **Refresh** or select **Actions**, and then **Refresh** to reload calculation results.
- Click , or select **Actions**, and then **Export To Excel** to export data in the table to a Microsoft Excel file.
- Select **Actions**, and then **Format** to indicate the number of decimal places to display in the table.

If a value in the Rule Balancing table is displayed in blue and underlined when you point to it, this indicates a Oracle Smart View for Office hyperlink. You can click these hyperlinks to launch Smart View and drill down further on input or allocation data.

Note:

For a description of the Rule Balancing task area, see [Viewing the Rule Balancing Task Area](#).

Performing Model Validation Analysis for Management Ledger Models

After a Management Ledger Profitability model is deployed, it can become invalid if dimensions that are used in model artifacts are deleted or renamed.

The following artifacts can be affected by dimension model changes: Program, Rule Sets, Rules, Model Views, and Smart View Queries.

The following processes and task areas reference these artifacts and will display errors if an invalid condition is created: LCM Export, Model Validation, Calculate, Manage Rules, Manage Queries, and Model View.

If a validation error is displayed, you can learn more about it in the Model Validation task area.

To check for and analyze validation errors:

1. In an open Management Ledger model, select **Validate** and then **Model Validation**.
2. In the **Model Validation** area, enter POV information (such as **Year**, **Period**, and **Scenario**), and click **Run**.

Errors, if present, display in a Model Validation table. The default tab is for rule sets and rules (Figure 1).

Figure 11-5 Model Validation Results for the Rule Sets and Rules Area

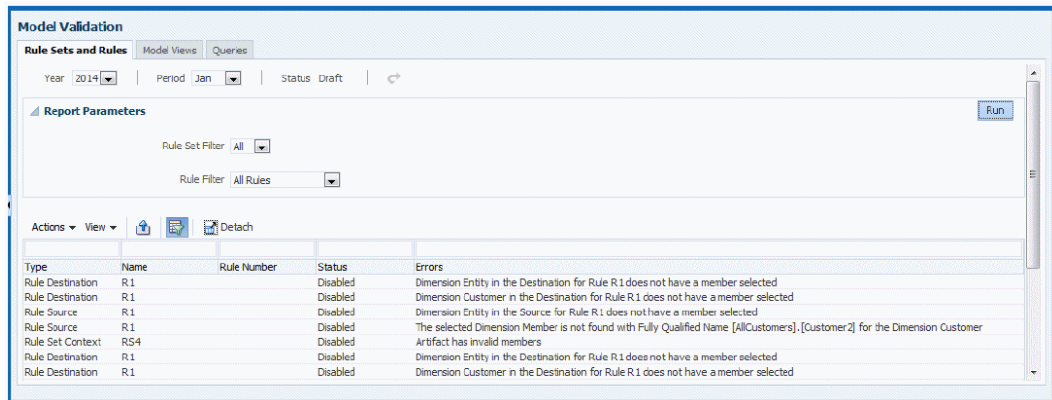

The error table for rule sets and rules contains the following information:

- Error type (location) — Global Context, Rule Set Context, Rule Source, Rule Destination, Rule Driver, or Rule Offset.
 - Name and number of the rule or rule set involved.
 - Status of the rule or rule set, usually Disabled.
 - A description of the error.
3. Review the **Model Views** and **Queries** tabs. Display the tab and click Run.

Note that these tabs apply to all POVs, so you do not need to select a POV.

4. Note errors on any tab. You can click ], or select **Actions**, and then **Export to Excel** to export data in the table to a Microsoft Excel file.
5. Repair the errors and validate again.

 **Note:**

You can fix rule set and rule errors in the **Manage Rules** task area ([Working with Rule Sets for Management Ledger POVs](#)). If a rule has an invalid member, you can remove it by selecting the rule and clicking .

If your security role enables you to log into Oracle Hyperion Enterprise Performance Management Workspace as Administrator, you can also validate deployed applications and perform impact analysis of dimension changes. For details, see *Oracle Hyperion Profitability and Cost Management Administrator's Guide*.

12

Managing and Calculating Management Ledger Models

Related Topics

- [Managing Management Ledger Databases](#)
After validating the structure and data of a Management Ledger model, you must deploy the database to create the metadata outline.
- [Calculating Management Ledger Models](#)
After deploying the database, you can calculate the model.
- [Controlling the Allocation Rounding Precision for Management Ledger Calculations](#)
There is a hidden installation preference you can insert in the database to change the number of decimal places that allocation results are rounded to during Management Ledger calculation (the current default is 7 decimal places).

Managing Management Ledger Databases

After validating the structure and data of a Management Ledger model, you must deploy the database to create the metadata outline.

The topics in this section are used to deploy dimension metadata to the Oracle Essbase calculation cube, and to load data into Essbase without using Oracle Essbase Administration Services console.

Note:

Whenever metadata is changed, you must redeploy the application. Any Profitability Applications Console deployment should be followed by an Essbase deployment to keep metadata synchronized.

Management Ledger Database Deployment Process

For the first deployment of a Management Ledger database, you should select the Replace Database option to create the database in its entirety. After the first deployment, when you need to redeploy the calculation database, you can select deployment options to retain data already in the cube or to discard it upon restructure.

Any errors in the deployment are reported in `hpcm.log`.

 **Note:**

- Reporting cube deployment fails when a generic dimension is associated with a dynamic hierarchy type. An ASO cube cannot have attribute dimensions associated with dynamic generic dimensions.
- Oracle recommends that, before importing data or artifacts, you create a backup of the data in Oracle Hyperion Enterprise Performance Management Workspace and Oracle Essbase. Contact your administrator for assistance.

To deploy Management Ledger databases:

1. In an open model, from **Task Areas**, select **Calculate**, and then **Manage Database**.

The **Manage Database** screen is displayed (Figure 1).

Figure 12-1 Management Ledger Essbase Deploy Screen

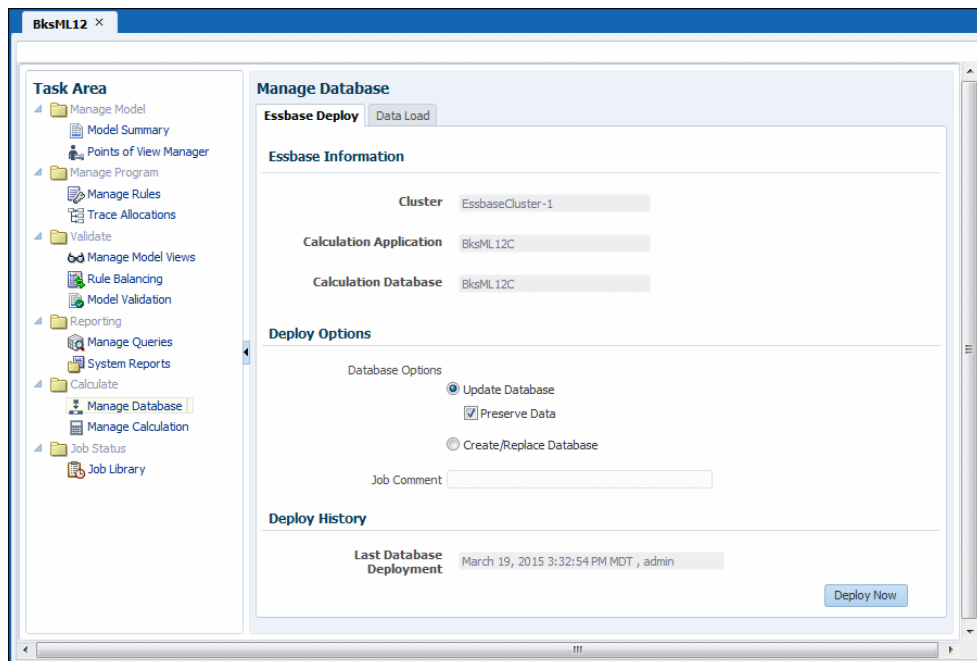

2. Confirm that the **Essbase Deploy** tab is selected.
3. Under **Essbase Information**, review the following information:
 - **Cluster** displays the name of the Essbase database server that contains the model.
 - **Calculation Application** displays the name of the application being deployed.
 - **Calculation Database** displays the name of the Essbase database to which the application is being deployed.
4. Under **Deploy Options**, select appropriate **Database Options** for deploying the Management Ledger database:

- For the first deployment of a database, all selections are grayed out. This option creates the entire database for the first time.
- To redeploy an existing database, select **Update Database** to retain existing artifacts and property settings in the new database, and change the outline to reflect current metadata.

Optional: Select **Preserve Data** to build and restructure the Essbase cube while preserving data. This option can be time-consuming, based on the size of the outline and the amount of data present.

Note: After deleting dimension members, the **Archive Data and Reload After Deploy** option for redeploying the cube to Essbase and preserving the data is not guaranteed to always work, depending on how Essbase is able to deal with those deleted members. As a workaround, you may have to export all data and remove the data for the deleted members and then reload the data in a separate step after deploying the cube without the **Archive Data and Reload After Deploy** option selected.

- Alternatively, select **Create/Replace Database** to remove the database and applications completely, and recreate them.

Caution:

If you plan to select this option, you must first back up your data and then reload it yourself once the database is recreated.

5. **Optional:** Enter a comment in the **Job Comment** box. The comment will display in the **Job Library**.
6. **Optional:** Under **Last Database Deployment**, review the date and time of the previous deployment.
7. Click **Deploy Now** to deploy the database.

A confirmation message is displayed, indicating that the job has been submitted.

Caution:

Depending on the size and complexity of a model, this operation may take a significant amount of time.

8. Monitor the progress of the deployment on the **Job Status** page using the taskflow ID.
9. Calculate the model ([Calculating Management Ledger Models](#)).

Loading Data into Essbase

Administrators and other users with appropriate provisioning can now load data into Oracle Essbase without using Oracle Essbase Administration Services. Files to load typically contain input data such as amounts to be allocated and driver information. You can also load rule files that tell Essbase how to handle data-source values that are loaded into Essbase databases.

The formats of files to load are the same as for Administration Services console:

- Text File data object(.txt) — `IEssOlapFileObject.TYPE_TEXT`

- Excel worksheet File data object(.xls) — IEssOlapFileObject.TYPE_EXCEL
- Rules File object(.rul) — IEssOlapFileObject.TYPE_RULES

For information about creating these files, see *Oracle Essbase Administration Services Online Help*, currently available at <https://docs.oracle.com/en/> (on the Applications - EPM tab, select documentation for the latest version, and then select the Essbase tab).

To load data into Essbase using Oracle Hyperion Profitability and Cost Management:

1. In an open Management Ledger model, from **Task Areas**, select **Calculate**, and then **Manage Database**. Click the **Data Load** tab.

The **Data Load** screen is displayed (Figure 1).

Figure 12-2 Management Ledger Data Load Screen

2. Indicate how to handle the data load:
 - **Optional:** Select **Clear Database Before Load** to clear all data in the active cube of the application. To retain existing data, do not select this setting.
 - Select whether to **Add to Existing Values** or **Overwrite Existing Values**.
3. **Optional:** If there is a **Global Rule File**, browse to select it.
4. In the **Load Files** area, select files to load. Use the **Actions** menu or the buttons to perform the following tasks:
 - **Add Row** or **+** button — Displays **Browse** buttons so you can select a data file or rule file to load
 - **Delete Row** or **X** button — Removes the selected row from the table of files to load

Note:

You can use the **View** menu to show, hide, and reorder columns in the table and detach the table to float it in a separate window.

5. When files are selected, click **Load** to copy the files to the OLAP server and load data from the files into Essbase.

You can select **Job Library** in the **Job Status** area to track the progress of the load.

Example 12-1 Notes

At least the first error for each file in the load is logged to hpcm.log and displayed in the Job Library. Where possible, multiple errors per file are logged. The error describes which column is wrong and in which record. An error is logged if the outline is empty or the loaded file is empty, locked, exceeds size limits (2 GB for data files, 64 KB for rule files), or if the data file contains an error. Files must be either text files or Microsoft Excel files. File names must not exceed eight characters and should not contain spaces or certain characters (including ,=,+; []).

To load Microsoft Excel files properly with a rule file, a single quote must appear before the name of a numeric dimension member (such as '2013). Microsoft Excel data source files must not contain formatting; set color to "Automatic" and "No Fill" and remove font settings such as bold and italic.

Calculating Management Ledger Models

After deploying the database, you can calculate the model.

Caution:

Before calculating a model, ensure that cost and revenue data have been loaded into Oracle Essbase. Otherwise, the calculation uses an empty data set.

The global context, rule sets, and calculation rules in Management Ledger applications are specific to a single point of view (POV). This means that a rule set or rule of the same name may exist in multiple POVs but each of the instances of that rule set or rule is a unique artifact and may have a unique definition. Running a calculation rule for a specific POV executes the definition of that rule set or calculation rule as it exists in that POV.

The **Manage Calculation** screen ([Figure 1](#)) is used to run calculations for all or part of the entire set of calculation rules for a single POV.

To clear or calculate Management Ledger data:

1. In an open model, from **Task Areas**, select **Calculate**, and then **Manage Calculation**.

Figure 12-3 The Management Ledger Manage Calculation Screen

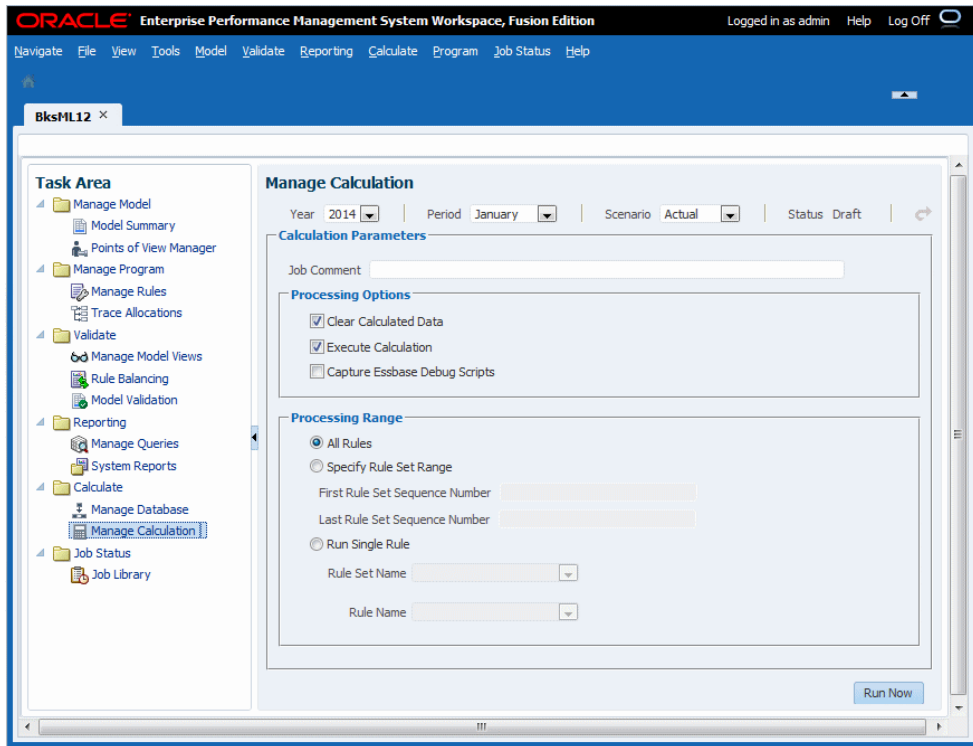

2. In the **Manage Calculation** screen, enter the POV information to calculate, such as **Year**, **Period**, and **Scenario**.
3. **Optional:** Enter a **Job Comment** to display on the **Job Library** screen.
4. **Optional:** In the **Processing Options** group, select one or more actions to perform:
 - **Clear Calculated Data** to clear all cells that could be updated by the rules in the **Processing Range** options (selected by default)
 - **Execute Calculation** to run the calculation rules specified in the **Processing Range** options (selected by default)
 - **Capture Essbase Debug Scripts** to store engine-generated scripts for each allocation or custom calculation rule included in a calculation (see "About Calculation (Calc) Scripts," later in this topic.

 **Note:**

Capture Essbase Debug Scripts is intended for troubleshooting purposes and can increase processing overhead. Avoid selecting this setting without an appropriate reason to do so.

If **Capture Essbase Debug Scripts** is selected, the Job Details list indicates that on the Job Library screen.

While calculating parallel rule sets (with a Calculation Threads preference value greater than 1) and with **Capture Essbase Debug Scripts** option selected, some of the rule executions can get skipped without any errors or warnings reported. To avoid this problem, if you need to capture Essbase debug scripts, you can temporarily change the Calculation Threads application preference to 1.

5. In the **Processing Range** group, indicate which rules to run:
 - **All Rules**—Runs all enabled rules defined for the selected POV.
 - **Specify Rule Set Range**—Runs all enabled rules in the rule set range defined by the **First Rule Set Sequence Number** text box and the **Last Rule Set Sequence Number** text box, inclusive.
 - **Run Single Rule**—Runs a single rule as selected in the **Rule Set Name** and **Rule Name** lists.
6. Click **Run Now** to run the calculations or clear data immediately. A confirmation message indicates that the job has started, and identifies the assigned taskflow ID.

 **Caution:**

Depending on the size and complexity of a model, this operation may take a significant amount of time.

7. Monitor the progress of the deployment using the taskflow ID in the Job Library screen.

Example 12-2 About Debug Scripts

Engine-generated scripts detail all the calculations required for each rule, one .txt file for each rule.

Scripts are generated in the `$ARBORPATH/app/<application name>/<database name>` directory, on the computer where the configured Essbase server is running, for example:

```
C:\Oracle\Middleware\user_projects\epmsystem1\EssbaseServer\
essbaseserver1\app\BksML12C\BksML12C
```

If required, administrators can view scripts on the Essbase console.

The file name format for scripts is `P+XX+RuleMemberName.txt`, where:

- P = POV
- XX = last two digits of the selected POV member group ID

- RuleMemberName = Unique rule member name assigned to the particular rule
For example, a generated script may be named P99R0001.txt.

Each script file has a header with the following information:

- Application name
- POV
- Rule set name
- Rule name
- Rule sequence
- Number of iterations

Controlling the Allocation Rounding Precision for Management Ledger Calculations

There is a hidden installation preference you can insert in the database to change the number of decimal places that allocation results are rounded to during Management Ledger calculation (the current default is 7 decimal places).

In the following SQL statements, replace <value> with an integer from -6 to 7 (keep the single quotes).

A value of -6 rounds to the nearest million; a value of 0 rounds to the nearest whole number; a value of 7 rounds to 7 decimal places.

During the allocation, the remainders from the rounding operations are added to the destination intersection with the largest allocated value.

For Oracle databases, execute this SQL statement in SQL Developer while connected as the Profitability product schema owner and then commit the change

```
INSERT INTO HPM_INSTALLATION_PREFERENCE
(ID,NAME,VALUE,HPM_INSTALLATION_ID,CREATED_TIMESTAMP,CREATED_USERID,MODIFIED_TIMESTAMP,MODIFIED_USERID,DISPLAY_ORDER)
VALUES (40,'MLCalculationPrecision',<value>,<value>,<value>,<value>,<value>,<value>,<value>,<value>);
```

For Microsoft SQL Server databases, execute this SQL block in SQL Server Management Studio while connected to the Profitability product database:

```
BEGIN
    SET IDENTITY_INSERT HPM_INSTALLATION_PREFERENCE ON
    INSERT INTO HPM_INSTALLATION_PREFERENCE
    (ID,NAME,VALUE,HPM_INSTALLATION_ID,CREATED_TIMESTAMP,
    CREATED_USERID,MODIFIED_TIMESTAMP,MODIFIED_USERID,DISPLAY_ORDER) VALUES
    (40,'MLCalculationPrecision', '<value>', 1, getDate(), 'INIT', getDate(), 'INIT', 40)
    SET IDENTITY_INSERT HPM_INSTALLATION_PREFERENCE OFF
```

```
END  
go
```

Monitoring Management Ledger Job Status

Related Topics

- [About the Management Ledger Job Library](#)
The Management Ledger Job Library lists all currently submitted or scheduled jobs for all models and all users for Management Ledger Profitability applications
- [Management Ledger Job Library Job Types](#)
There are five job types that can be processed for Management Ledger applications.
- [Viewing the Management Ledger Job Library](#)
You can view the Management Ledger job library.

About the Management Ledger Job Library

The Management Ledger Job Library lists all currently submitted or scheduled jobs for all models and all users for Management Ledger Profitability applications

Click any column heading in the Job Library to sort the jobs by that label. Click again to reverse the sort.



Note:

As the number of jobs in the list increases, screen refresh speed can slow down. To reduce the list and restore reasonable performance, you can use the **Export to Excel** button to archive the job list and then delete the old jobs.

Management Ledger Job Library Job Types

There are five job types that can be processed for Management Ledger applications.

The Job Details information on the Job Library changes, depending on the Job Type:

- **Copy POV (POV_COPY)**
 - Taskflow Id
 - Job Details: Configuration and other details relevant to that job type
- **Clear POV (POV_CLEAR)**
 - Taskflow Id
 - Job Details: Configuration and other details relevant to that job type

See [Clearing Selected Artifacts from Management Ledger POVs](#).
- **Delete POV (POV_DELETE)**
 - Taskflow Id

- Job Details: Configuration and other details relevant to that job type
See [Deleting Management Ledger POVs and All Artifacts](#).
- **Cube Deployment (CUBE_DEPLOYMENT)**
 - Taskflow Id
 - Job Details: Name of the Oracle Essbase application, database options, and data options
See [Managing Management Ledger Databases](#).
- **Allocation Calc-Ledger (LEDGER_CALC)**
 - Taskflow Id
 - Job Details: Processing options, data POVs that were selected when the calculation was set, rules executed, and other calculation data
See [Calculating Management Ledger Models](#).

Viewing the Management Ledger Job Library

You can view the Management Ledger job library.

1. From Oracle Hyperion Enterprise Performance Management Workspace, select **Navigate**, then **Applications**, then **Profitability**, and then select a Management Ledger application for which jobs have been submitted.
2. In an open model, from **Task Area**, select **Job Status**, and then **Job Library** ([Figure 1](#)).

Figure 13-1 Management Ledger Job Library

The screenshot shows the 'Job Library' window with a table of jobs. The table has columns for Job Id, User, Application Name, Start Date, Start Time, End Date, End Time, Elapsed Time, Job Type, Status, and Comment. Below the table, there is a 'Job Details' section with a 'Click for Errors' link and a list of job parameters.



Job Id	User	Application Name	Start Date	Start Time	End Date	End Time	Elapsed Time	Job Type	Status	Comment
1573925	admin	BksML20	5/26/15	06:00:42 PM	5/26/15	06:01:23 PM	00:00:40	Deploy Cube	Success	
1100001	admin	TT	5/4/15	03:25:14 PM	5/4/15	03:25:43 PM	00:00:28	Deploy Cube	Success	
1099205	test	TT	4/23/15	12:26:41 PM	4/23/15	12:26:41 PM		Deploy Cube	Failure	
1099204	admin	TT	4/23/15	12:25:23 PM	4/23/15	12:25:50 PM	00:00:26	Deploy Cube	Success	
1099201	test	TT	4/23/15	12:18:33 PM	4/23/15	12:18:35 PM	00:00:01	Deploy Cube	Failure	
129438	admin	BksML12	3/19/15	03:46:15 PM	3/19/15	03:46:34 PM	00:00:19	Ledger Calculation	Success	
129432	admin	BksML12	3/19/15	03:40:56 PM	3/19/15	03:40:57 PM		Essbase Data Load	Success	
129431	admin	BksML12	3/19/15	03:32:53 PM	3/19/15	03:33:22 PM	00:00:28	Deploy Cube	Success	

Job Details
[Click for Errors](#)

Taskflow Id : TT_DeployCube_D20150423T122640_5c9
 Replace Cube : No
 Reload Archive : No
 Delete Archive : No
 Keep Data : Yes
 Application Type Name : Management Ledger
 Essbase Application : TTC

The **Job Library** screen contains the following controls:

- **Actions** menu — Export the job table to Microsoft Excel or cancel the selected job

- **View** menu — Hide, show, and rearrange the order of columns; detach and reattach the Job Library table; display and hide the Query by Example boxes at the top of each column
 - **Export to Excel** button — Saves the Job Library table to a Microsoft Excel file
 - **Filter** button — Displays and hides Query by Example boxes at the top of each column
Enter text to match into a Query by Example box to select specific entries in the Job Library table.
 - **Detach** button — Floats the Job Library table in its own window; click to attach it again
 - **Stop** button — , cancels the selected job
 - **Delete** button — , removes the selected job from the Job Library table
 - **Refresh** button — Updates the Job Library table with the most recent job information
3. View the information for each job:
- **Job Id** — The system-assigned identification number for the job
 - **User** — The User ID of the individual who submitted the task for processing
 - **Application Name** — The name of the application for which the task is being run
 - **Start Date/Time** — The date and time on which the job was submitted or was scheduled to run
 - **End Date/Time** — The date and time on which the job completed, failed, or was stopped
 - **Elapsed Time** — The difference between the Start Date/Time and the End Date/Time
 - **Job Type** — The type of task that is running ([Management Ledger Job Library Job Types](#))
 - **Status** — The current state of the taskflow, such as Running, Success, or Failure
 - **Comment** — A user-entered note or details about that specific job. The Comment is entered when the task is submitted.
4. **Optional:** Under **Job Details**, review the additional summary level detail about the selected job. The Job Details include a taskflow ID and may include a hyperlink that enables you to click to view more detail such as error or impact analysis information. If a hyperlink is offered, you can save the displayed information to a file.

For additional information, see [Job Library Job Types](#).

 **Note:**

Taskflow Id is the system-generated task ID for the specific task, displayed in the format `<application name>.<task name><generated taskflow number>`.

For example, the generated taskflow number may be displayed as **Demo04_RunCalcs_D20111103T183447_fbe**, where **Demo04** is the application name, **RunCalcs** is the task, and **D20111103T183447_fbe** is the generated taskflow instance ID.

5. **Optional:** If you used a **View** option or the **Filter** button to show the Query By Example boxes, use the text box at the top of each column to locate a job by entering text to match in the box.
6. **Optional:** If required, click  or select **Actions**, and then **Stop** to end the selected task in Running state.

 **Note:**

This command is available only for Ledger Calculation jobs that do not give control to other systems, such as Oracle Essbase. While the task flow stops quickly after the button is pressed, activities that affect results may require additional time to ensure that the state of the data is consistent.

For detailed instructions on using EPM Workspace taskflows, see the *Oracle Hyperion Enterprise Performance Management Workspace User's Guide*.

Working with Management Ledger Queries and Reports

Related Topics

- [About Management Ledger Queries and Reports](#)
There are several ways to view and print data in Management Ledger Profitability models.
- [Managing Smart View Queries in Management Ledger Profitability Applications](#)
Use the Manage Queries task area screen to create and organize Smart View queries against an application database.
- [Creating and Using Management Ledger Reports](#)
You can generate system reports from within Management Ledger Profitability models.

About Management Ledger Queries and Reports

There are several ways to view and print data in Management Ledger Profitability models.

- You can view internal data tables for validating the model; for example the **Rule Balancing** and **Model Validation** task area screens. To create reports from these tables, click a button and export them to a Microsoft Excel file ([Validating Management Ledger Models](#)).
- You can use the **Manage Queries** task area to build and manage Oracle Smart View for Office queries to run against Oracle Essbase data cubes containing Oracle Hyperion Profitability and Cost Management data. Then, you can click a button to launch Smart View with the query results ([Managing Smart View Queries in Management Ledger Profitability Applications](#)).
- You can generate preformatted system reports to see lists and descriptions of Management Ledger rule sets and rules or calculation statistics ([Creating and Using Management Ledger Reports](#)).

You can also use other Oracle reporting tools or third-party reporting tools to report against Essbase cubes to view calculation results:

- Oracle Hyperion Web Analysis
- Oracle Hyperion Financial Reporting
- Microsoft Excel, using Smart View

Using these reporting tools, you can generate reports to view exactly the information you require. The procedures in this section suggest steps you need to take to build the reports, but you must use the supporting documentation for the selected reporting tool for detailed instructions on creating and running reports. For details, see the other topics in the section.

Managing Smart View Queries in Management Ledger Profitability Applications

Use the Manage Queries task area screen to create and organize Smart View queries against an application database.

You can use these queries for management reporting, segmented profitability analysis, rule analysis, input data verification, and more. You can find data of interest without having to research the rule definitions or understand the system dimensions that control how calculated and input data is stored.

Queries can be saved and reused. They also can be exported and imported using Oracle Hyperion Enterprise Performance Management System Lifecycle Management.

You can launch some predefined Oracle Smart View for Office integrations from the **Rule Balancing** screen. The launch data points are represented as blue hyperlinks in the Rule Balancing table. You can drill down further on input or allocation data. For example, you could drill down into certain costs after a calculation runs, or to examine input data that was used in the same run.

If any dimensions or dimension members are renamed or deleted, the Smart View queries that reference those dimensions become invalid. The query validation screen validates all queries, and displays an error message for any invalid queries ().

Smart View queries in Management Ledger applications fail with validation errors when they reference dimension members containing '&' characters in the member name.

Only users provisioned as Interactive Users, Power Users, or Administrators can create, edit, or delete queries. In addition to those users, View Users can also run queries from the application.

Creating Custom Smart View Queries in Management Ledger Profitability Applications

Before creating a query, ensure a full Oracle Hyperion Profitability and Cost Management environment is installed, configured, and running, including the following products:

- Oracle Hyperion Provider Services
- Oracle Hyperion Shared Services
- Oracle Essbase

You also need Microsoft Excel installed with Oracle Smart View for Office on your computer.

To create a query:

1. From the Task Area, select **Reporting**, and then **Manage Queries**.

The **Queries** screen is displayed, showing all existing queries for all applications for which the user is provisioned as a View User, Interactive User, Power User, or Administrator ([Figure 1](#)).

Figure 14-1 Manage Queries Task Area, Queries Screen

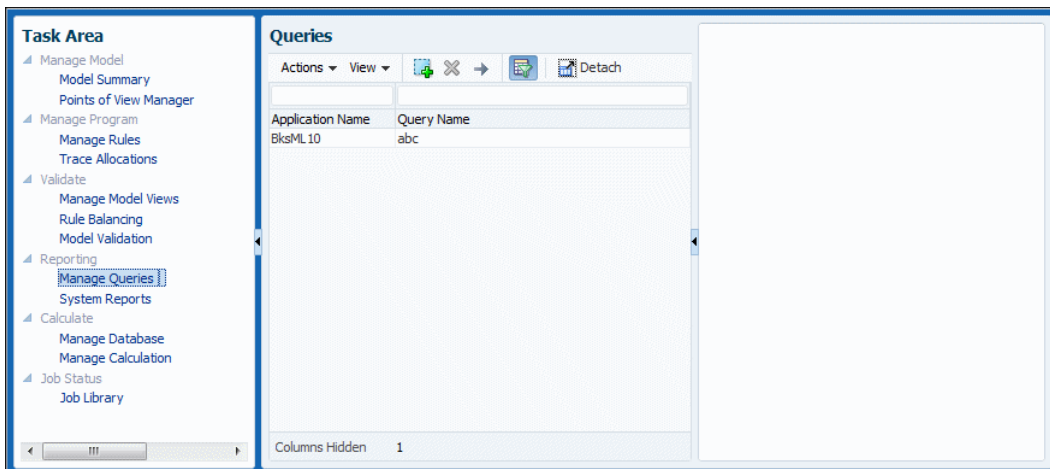

2. Click  or select **Actions**, and then **Create Query**.
This action is not available to View Users.
The three-step query wizard opens.
3. In **Step 1 of 3: Description**, enter the following information for the new query and select **Next**:
 - Select the **Application** to be used for the query from the drop-down list.
 - Enter a **Name** for the query.
4. In **Step 2 of 3: Program Context**, select whether to use a program context (global context, rule set context, or a rule) to define dimensions. For more information about contexts, see [Working with Management Ledger Allocations](#).
 - If you selected **Use Program Context?**, enter POV information and then click **Next**.
 - If you did not select **Use Program Context?**, click **Finish**, and then skip to step 6, later in this procedure.
5. If you select **Use Program Context?** and click **Next**, **Step 3 of 3: Dimensions** is displayed. Select which program context to use, and then select from any lists that are presented. When selections are complete, click **Finish**.

Context choices are the following:

- **Use Global Context** — Applies the default dimensions selected for all rule sets and rule in the model
- **Use Rule Set Context** — Applies default dimensions selected for the specified rule set (requires a rule set name)
- **Use Rule** — Applies rule-specific dimension information; requires a rule set name, a rule name, and a rule component (**Source**, **Destination**, **Driver**, or **Offset**)

After you click **Finish**, the **Queries** screen is displayed. The new query is listed.

6. Select a query and complete the custom query definition as described in the following steps.
7. **Optional:** On the **Description** tab, do the following if appropriate:
 - Enter a **Description** for the query.

- Select **Use Alias** to display any assigned aliases for all dimensions in the query.
- Select **Suppress Missing** to set the data suppression option for the first query in Smart View, if required.

If you select **Suppress Missing**, the Smart View option is set only for the first query run, not all queries. To set the option for subsequent drills into the data, set the option manually in Smart View.

Selecting **Suppress #Missing** in a Query definition returns the error "Cannot perform cube view operation.null" when you run the query. If you deselect this option, the query runs, and you will see data along with missing data rows.

8. Click **Dimensions** to review and edit dimension selections (Figure 2).

By default, all dimensions in the application outline are displayed.

Figure 14-2 Dimensions Tab of the Queries Definition Screen

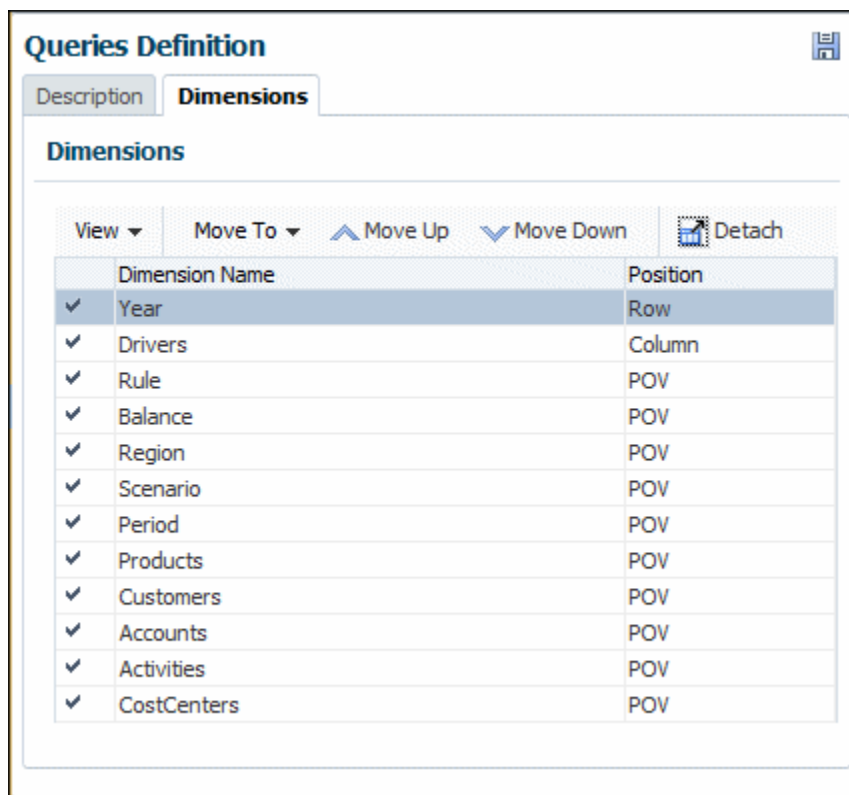

9. A default **Position** is assigned to each dimension. To change the position, select a dimension, open the **Move To** drop-down list, and then select the new position::
 - **Row**
 - **Column**
 - **Smart View POV**
10. **Optional:** Use **Move Up** and **Move Down** to change the position of a highlighted dimension in the query within its **Position**.
11. **Optional:** Select a dimension and use the **Member Selection** area to add or delete members and change the column display.

The list displays all dimension members, including alternate hierarchies and the NoMember member. Because there are no restrictions on level, alternate hierarchy, shared or base member, any member may be selected.

12. When the query definition is complete, click  to save it for further use.

To run, edit, or delete queries, see the following:

- [Running Management Ledger Profitability Queries](#)
- [Editing and Deleting Custom Queries in Management Ledger Profitability Applications](#)

Running Management Ledger Profitability Queries

The topics in this section describe several ways to run queries and generate results in Management Ledger Profitability applications.

Running Custom Queries in Management Ledger Applications



Note:

[Creating Custom Smart View Queries in Management Ledger Profitability Applications](#) describes how to create a query.

Before running a query, the database must be deployed. Although the database does not need to be calculated before running the query, results will be missing if it is not.

You can run Management Ledger queries and display the results in Oracle Smart View for Office for further analysis, validation, and editing.

To run a query and launch it in Smart View:

1. In the **Task Area**, select **Reporting**, and then **Manage Queries**.
 The **Queries** screen is displayed, showing all existing queries for all applications for which the user is provisioned as a View User, Interactive User, Power User, or Administrator.
2. Select the query to run.
3. Click  or select **Actions**, and then select **Execute Query**.
4. Smart View opens with query results.

Running Queries from the Management Ledger Rule Balancing Screen

You can launch some predefined query integrations from the Management Ledger Rule Balancing screen. The launch points are represented as hyperlinks defined on data in the screen. The hyperlinks in the columns represent values that have been contributed through rule calculations.

Click the hyperlinks to immediately access an analysis capability to analyze the calculations and determine whether areas may need to be repaired, and to explore details of any discrepancies or missing information.

To access queries through the Rule Balancing screen:

1. From Oracle Hyperion Enterprise Performance Management Workspace, select **Navigate**, then **Applications**, then **Profitability**, and then select a Management Ledger Profitability application (model).
2. For most complete results, calculate the model before running the query.
3. With the model open, in **Task Area**, select **Validate**, and then **Rule Balancing**.
4. In the **Rule Balancing** screen, enter POV data and then select a **Model View**.
5. In the Rule Balancing table, click a blue hyperlink, for example for Allocation In.

When you click the hyperlink, results display in Oracle Smart View for Office for further analysis and reporting ().

Figure 14-3 Query Results in Smart View for Activities Allocations In

	A	B	C
2		Allocations In	
3	Activities	190947.394	
4			
5			
6			
7			
8			
9			
10			
11			
12			
13			
14			
15			
16			
17			
18			

POV Linked ' ▾ ×

Rule ▾

Balance ▾

Region ▾

Scenario ▾

Period ▾

Products ▾

Customers ▾

Accounts ▾

CostCenters ▾

Refresh ⓘ

6. **Optional:** To modify the current POV, on the **POV_Linked_View** pane, click the down arrow beside any dimension listed for the current POV, and then click the ellipsis (...) to open a Member Selector. Select any members that you want to change, and then click **Refresh** to activate the POV change.
7. Review the results of the query.
8. **Optional:** To view a specific intersection, use the Zoom commands on the Oracle Essbase tab to drill down or back up to a specific intersection.

 **Note:**

When invoking Smart View from Manage Queries, you may encounter errors such as: "connection refused" and "Web launch operation cancelled". Oracle recommends the Full SSL Deployment of Oracle Enterprise Performance Management System as described by the *Oracle Enterprise Performance Management System Security Configuration Guide* to support invoking Managed Queries from Management Ledger with SSL. If you terminate SSL at the OHS server, then additional configuration may be required within the OHS configuration files.

Editing and Deleting Custom Queries in Management Ledger Profitability Applications

To edit queries:

1. In the **Task Area**, select **Reporting**, and then **Manage Queries**.
The **Manage Queries** screen is displayed, showing all existing queries for all applications for which the user is provisioned as an Interactive User, Power User, or Administrator.
2. Select a query and then use the **Description** and **Dimension** tabs of the **Query Definition** area to refine the query ([Creating Custom Smart View Queries in Management Ledger Profitability Applications](#)).
3. When the query edits are complete, click  to save the query for future use.

To delete queries from within Management Ledger applications:

1. Ensure no other users require the query.
2. In the **Task Area**, select **Reporting**, and then **Manage Queries**.
The Queries screen is displayed, showing all existing queries for all applications for which you are provisioned.
3. Select the query to delete, and then click  or select **Actions**, and then select **Remove Query**.

 **Note:**

This action is available only to Interactive Users, Power Users, and Administrators.

4. Respond **Yes** to the confirmation message.
The selected query is removed from the **Queries** screen.

Creating and Using Management Ledger Reports

You can generate system reports from within Management Ledger Profitability models.

You can also create Oracle Essbase reports from within Oracle Smart View for Office and use other Oracle tools to prepare reports directly from an Essbase outline. See the listed topics for more information.

Generating Management Ledger System Reports

Management Ledger system reports show one of the following for a selected model:

- **Program Documentation** — Calculation rule sets and rules plus rule definitions
- **Dimension Statistics** — Number of dimension members, number of level 0 members, and number of hierarchy levels for each dimension in the current application
- **Rule Data Validation** — Source and driver data targeted for each selected rule

 **Note:**

If the intersection count is greater than 1000, only the first 100 intersections are displayed. If either **Source Data** or **Driver Data** is not selected, that portion of the report is blank.

- **Execution Statistics** — Runtime statistics collected for the selected Ledger Calculation job following the end of the job

To generate a Management Ledger system report:

1. In an open Management Ledger model, in the **Reporting** task area, select **System Reports**.
2. In the **System Reports** screen, select one of the following for each setting:
 - **Report Name** — **Program Documentation**, **Dimension Statistics**, **Rule Data Validation**, or **Execution Statistics**
 - **Output Type** — **PDF** (Adobe PostScript), Microsoft **EXCEL**, Microsoft **WORD**, **XML**, or **HTML**
3. For **Program Documentation** and **Execution Statistics** reports, enter the following in the **Report Parameters** area:
 - **Program Documentation** — POV information
 - **Execution Statistics** — **Job Id** for a successfully completed job from the **Job Library** task area

For **Rule Data Validation Reports**, enter the following:

- POV information
- Rule Set
- Rule
- Whether to generate a report of summary values only, or summary values and data
- Whether to include source data, driver data, or both for the selected rule



Note:

Dimension Statistics reports do not require **Report Parameters** information.

4. Click **Run** to generate and display the report.

See the following sections for more information about report contents and to review report examples:

- [Management Ledger Program Documentation Report Example](#)
- [Management Ledger Dimension Statistics Report Example](#)
- [Management Ledger Rule Data Validation Report Example](#)
- [Management Ledger Execution Statistics Report Example](#)

Management Ledger Program Documentation Report Example

Program Documentation reports explain what every rule and rule set does. The resulting summary of calculation logic in these reports is useful for project documentation or as a tool for auditors.

Figure 14-4 Example of a Management Ledger Profitability Program Documentation Report

Program Documentation Report									
ORACLE Hyperion									
Application : BksML10 Application Type : Management Ledger Application Point of View : Year:Period:Scenario 2014:January:Actual Global Context : Yes									
Rule Set Name	Rule Name	Rule Type	Rule Number	Enabled	Use Context	Sequence	Execution Mode	Iterations	Description
Occupancy Expense Allocations				Yes	Yes	1	Serial Execution		Occupancy expenses are reassigned from cost centers where the expenses are paid to the cost centers that use the facilities. A rule Set Context is defined for Activity, Product, Customer, and Region dimensions t select the 'No-dimname' members. These dimensions are not meaningful in managing these rules.
Occupancy Expense Allocations	Facilities Expense Adjustment	Custom Calculation	R0019	Yes	Yes	1			Adjust Facilities Expense up 15%
Occupancy Expense Allocations	Rent and Utilities Reassignment	Allocation	R0001	Yes	Yes	2			Rent and Utility expenses are reassigned from the Corporate cost center to the business function cost centers. A driver based on the square feet of each building used by each cost center is used to apportion the expenses.

Management Ledger Dimension Statistics Report Example

Dimension Statistics reports show the number of dimension members, number of level 0 members, and number of hierarchy levels for each dimension in the current application. Potential values are possible mathematical combinations that might not all be used.

Figure 14-5 Example of a Management Ledger Profitability Dimension Statistics Report

Dimension Statistics Report		ORACLE Hyperion				
Application Name : BksML10 Application Type : Management Ledger Application						
Dimension Name	Dimension Type	Associated Attribute Dimensions	Total Number of Members	Number of Level 0 Members	Hierarchy Depth	Last Update
Drivers	Business		2	2	2	10/23/2014 08:37:22
Rule	Rule		1003	1002	3	10/23/2014 08:37:22
Balance	Balance		19	14	4	10/23/2014 08:37:22
Year	POV		8	8	2	10/23/2014 08:37:22
Region	Business		16	11	4	10/23/2014 08:37:22
Scenario	POV		4	4	2	10/23/2014 08:37:22
Period	POV		12	12	2	10/23/2014 08:37:22
Products	Business		10	8	3	10/23/2014 08:37:22
Customers	Business		10	8	3	10/23/2014 08:37:22
Accounts	Business		69	52	7	10/23/2014 16:28:12
Activities	Business		31	28	3	10/23/2014 08:37:22
CostCenters	Business		19	16	3	10/23/2014 08:37:22

Management Ledger Rule Data Validation Report Example

Rule Data Validation reports help you verify that all required source and driver data is included for rules in a Management Ledger application. The report shows all of the intersections for the selected rule's source and driver that have data as well as the rule and driver data totals and number of total records. Alternatively, you can select simply the total summary data.

If the intersection count is greater than 1000, only the first 100 intersections are displayed. If either **Source Data** or **Driver Data** is not selected, that portion of the report is blank.

[Figure 1](#) shows total summary data for the selected rule's source and data intersections as well as data for each intersection. Cost Center accounts supply source data. Source data is missing in this case. [Figure 2](#) shows the format of driver data for the Rule Data Validation report.

Figure 14-6 Example of a Management Ledger Rule Data Validation Report with Summary and Source Data

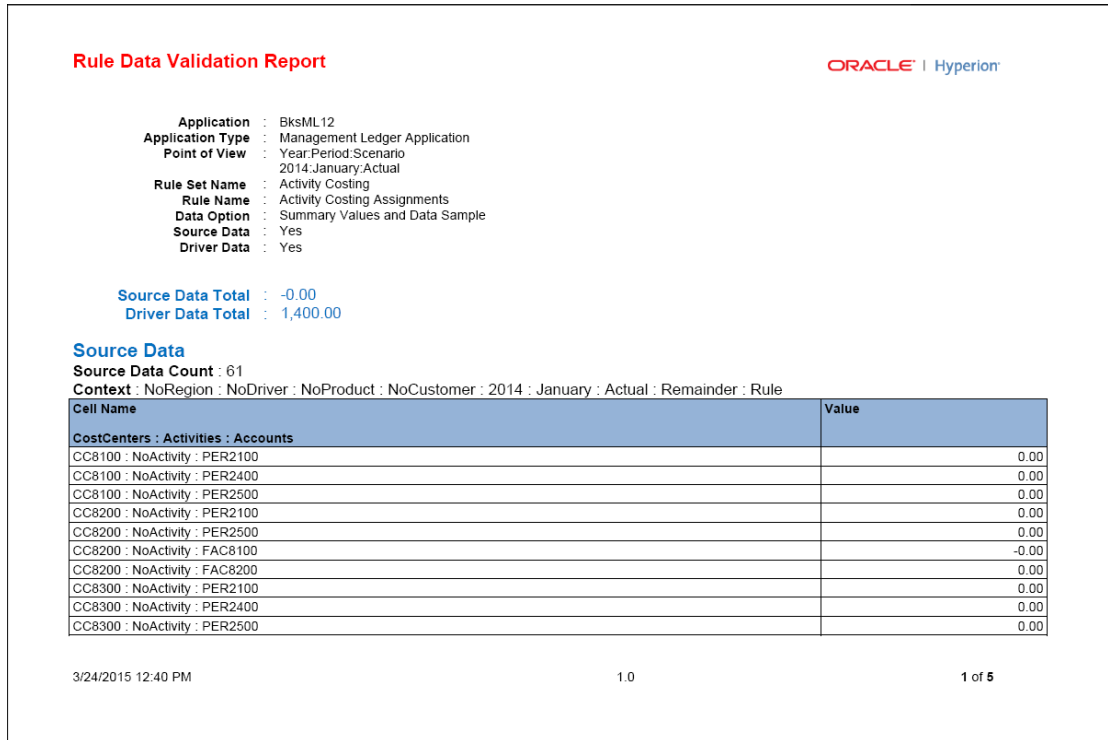
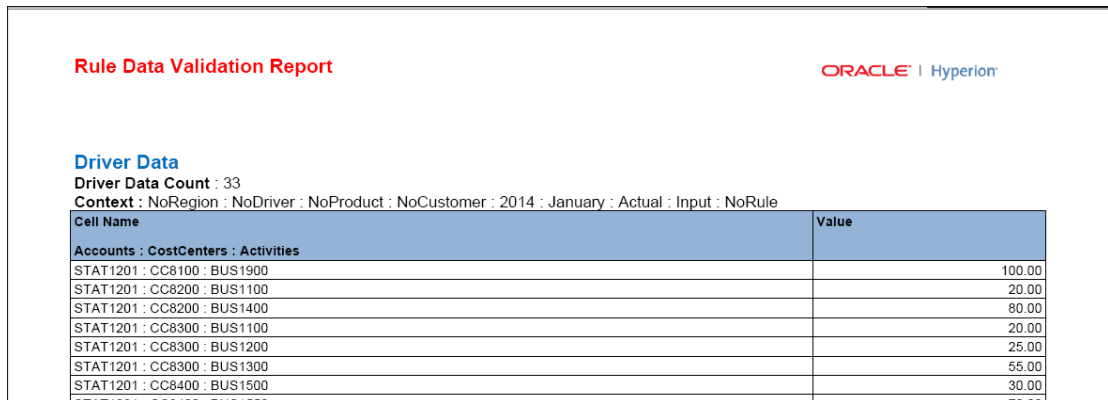

Figure 14-7 Part of a Management Ledger Rule Data Validation Report Showing Driver Data



Management Ledger Execution Statistics Report Example

Execution Statistics reports show runtime statistics collected for the selected Ledger Calculation job type following the end of the job.

Figure 14-8 Example of a Management Ledger Profitability Execution Statistics Report

Execution Statistics Report											
ORACLE Hyperion											
Application : BksML10 Application Type : Management Ledger Application Point of View : Year Period Scenario : 2014:January:Actual Job Id : 26087301 Job Type : Ledger Calculation Job Status : Success Number of Threads : 1 Start Time : 10/23/2014 18:14:38 End Time : 10/23/2014 18:24:05 User Id : admin											
Rule Set Name	Rule Name	Iteration Number	Start Time (hh:mm:ss)	End Time (hh:mm:ss)	Elapsed Time (hh:mm:ss)	Number of Threads	Thread Number	Potential Sources	Potential Destinations	Potential Allocations	
Occupancy Expense Allocations			18:14:51	18:14:58	00:00:06	1	306				
Occupancy Expense Allocations	Facilities Expense Adjustment	1	18:14:51	18:14:55	00:00:03	1	306		2		
Occupancy Expense Allocations	Rent and Utilities Reassignment	1	18:14:55	18:14:58	00:00:03	1	306		2	28	56
Manufacturing COGs Related Expense Assignment			18:14:58	18:15:01	00:00:03	1	306				
Manufacturing COGs Related Expense Assignment	Product Material Allocation	1	18:14:58	18:15:01	00:00:03	1	306		6	42	252
Activity Costing			18:15:01	18:15:05	00:00:03	1	306				
Activity Costing	Activity Costing Assignments	1	18:15:02	18:15:05	00:00:03	1	306	126	3402		428652

Reporting Using Smart View with Management Ledger Profitability Applications

Oracle Smart View for Office provides a Microsoft Office interface for Oracle Essbase and other data sources. From Microsoft Excel, Word, or PowerPoint, you connect to Essbase and access Smart View functionality through the Smart View ribbon that is displayed on the Microsoft Office product toolbars when Smart View is installed. You can generate reports that can be displayed as a grid, chart, or scrollable table.

The **Manage Queries** screen ([Running Custom Queries in Management Ledger Applications](#)) helps users define and launch queries that result in a view of the data in Smart View. The **Rule Balancing** screen ([Running Queries from the Management Ledger Rule Balancing Screen](#)) also has links that take users directly into Smart View.

This topic is designed to provide an overview of how to create reports with Smart View, but you must refer to the *Oracle Smart View for Office User's Guide* for detailed instructions on setting up reports and using Smart View to view the results.

To report using Smart View:

1. Generate and calculate the Essbase cube for the model, as outlined in [Managing and Calculating Management Ledger Models](#).
2. Open Microsoft Excel.
3. In Smart View, select **Panel**, and then **Shared Connections**, and connect to the Essbase database. See the *Oracle Smart View for Office User's Guide*.
4. Create the report as outlined in the *Oracle Smart View for Office User's Guide*.

Note:

If you are skilled at working with Essbase outlines, you can also generate reports directly in Essbase. See the Essbase documentation for instructions.

Part III

Working with Detailed Profitability

Related Topics

- [About Detailed Profitability and Cost Management Models and Scenarios](#)
- [Dimensions in Detailed Profitability and Cost Management Applications](#)
- [Managing Detailed Profitability Models](#)
- [Managing Detailed Profitability Allocations](#)
- [Calculating Detailed Profitability Models](#)
- [Validating Detailed Profitability Models](#)
- [Creating Detailed Profitability Reports](#)
- [Monitoring Detailed Profitability Job Status](#)

About Detailed Profitability and Cost Management Models and Scenarios

A model is a representation of part or all of an organization. Oracle Hyperion Profitability and Cost Management models enable you to accurately trace the processes and activities that contribute to costs and revenue within the organization.

A model is comprised of the following elements:

- Stages, which organize the Source and Destination allocations for revenue or expenses in the organization
- Dimensions, which are data categories that are used to organize business data for retrieval and preservation of values. Within Detailed Profitability and Cost Management, the following types of dimensions are used:
 - System dimensions, such as the MeasuresDetailed allocation dimension.
 - Measures dimensions contain the members required to build, validate, and calculate a model, such as measures for revenue, and driver definitions.
 - Business dimensions, which describe the objects within each stage in the model, such as products, customers, regions, and so on. The dimensions and members are the foundation of the model.
 - POV dimensions identify a specific point of view or version of the model, such as year, scenario, period, and version. Version dimensions enable you to maintain multiple versions of a model. These versions can be used to create alternate, or what-if, scenarios of the model, or different perspectives.
 - Alias dimension is used to assign alternate names, descriptions, languages, or other items that help to define dimensions.
 - Attribute dimensions enable analysis based on the attributes or qualities of dimension members. Attributes describe characteristics of data, such as the size or color of products.
- Drivers that determine how revenue or expense source values are calculated and allocated. Selected drivers are applied to the entire dimension, a portion of the hierarchy, a single member, or even a single intersection.
- Assignment rules that define source or destination member selections
- Assignments that map source data to the destination
- Multi-source Calculation Rules that define allocations from multiple sources to multiple destinations.
- Single-source Calculation Rules to execute individual assignments that act as exceptions to the Multi-source rules.
- Calculation Rules are a super set of calculation artifacts, encapsulating sources, destinations, and drivers, that allow to use sources, destinations and drivers to create broad allocations, reserving individual assignments to create exceptions to these calculation rules.

- Financial data, which is imported from user-defined relational databases.

The MeasuresDetailed, Business, Measure, and POV dimensions are created in the Profitability Applications Console, and deployed to the Profitability and Cost Management relational database. Stages, drivers, driver selections, assignments, and calculation rules are created in Profitability and Cost Management.

Steps to Create Detailed Profitability Models

The creation of a Detailed Oracle Hyperion Profitability and Cost Management model requires the following steps:

1. Have the Database Administrator create a model schema to hold the relational tables (Physical tables and views) and Lookup tables that hold supporting details before creating the model in Detailed Profitability and Cost Management.
2. Create the Detailed Profitability application in the Profitability Applications Console.
3. Select the Model Data Schema that you are using for the Detailed Profitability application. See [Selecting the Detailed Model Data Schema](#).
4. Using Model Data Registration, select the Source and Destination Measures dimensions and register the tables. Map the columns from the existing database tables to the application. You also join to associated lookup tables that provide additional supporting detail for the main tables. See [Registering Detailed Profitability Model Data](#).
5. Create the source and destination model stages for the model. Select the registered table and assign the dimensions that apply to the stage. See [Managing Detailed Profitability Stages](#).
6. Run model data registration model validations. See [Validating Detailed Profitability Models](#).
7. Create the Points of View (POVs) for the model via selecting members for each POV dimension, such as Year, Period, and Scenario. See [Working with Detailed Profitability Points of View](#).
8. Create driver definitions to specify how to calculate data. See [Defining Detailed Profitability Drivers](#).
9. The model is centered around Calculation Rules, a top-down approach. See [Working With Calculation Rules](#).
10. Create multi source assignment calculation rules and the corresponding source and destination assignment rules. See [Adding Calculation Rules](#).
11. **Optional:** To create assignment rule selections as exceptions to the multi source calculation rules:
 - Assign drivers to selected driver dimension members or intersections. See [Selecting Detailed Profitability Drivers](#).
 - Create assignment rules and assignments to specify where you want the calculated values to be allocated.
See these sections:
 - [Creating Assignment Rules](#)
 - [Working with Assignments in Detailed Profitability](#)

– Working with Detailed Profitability Assignment Rules

12. Oracle recommends that you use the multi source calculation rules to create multiple assignments and driver selections. See [Adding Calculation Rules](#).
Optionally, you can use the Bulk Editor. See [Working with the Bulk Editor](#).
13. **Optional:** Create single source assignment calculation rules to capture sets of assignment rule selections created as exceptions for execution, and to control when they execute. See [Working With Calculation Rules](#).
14. Validate the model to ensure the model structure conforms to validation rules, such as completed assignments and no unused drivers. See [Validating Detailed Profitability Models](#).
15. Run calculations for the model to generate results. See [Calculating Detailed Profitability Models](#).
16. Monitor the status of submitted and scheduled jobs. See [Monitoring Detailed Profitability Job Status](#)
17. Run the Stage Balancing reports. Make any edits or corrections to the model or data, and then rerun the calculations, as required. See [Detailed Profitability Stage Balancing Report](#).
18. Create the custom reports, using the Reporting Views. See [Deploying Detailed Profitability Reporting Views](#).

Detailed Profitability and Cost Management Workspace

Accessed from Oracle Hyperion Enterprise Performance Management Workspace, the Oracle Hyperion Profitability and Cost Management workspace contains two main areas:

- Use the Task Areas pane to navigate among the processes required to build, validate, and calculate the model and to report results.
- Use the Contents pane to view task information, enter or modify data, and perform tasks associated with the creation and maintenance of a model and its data.

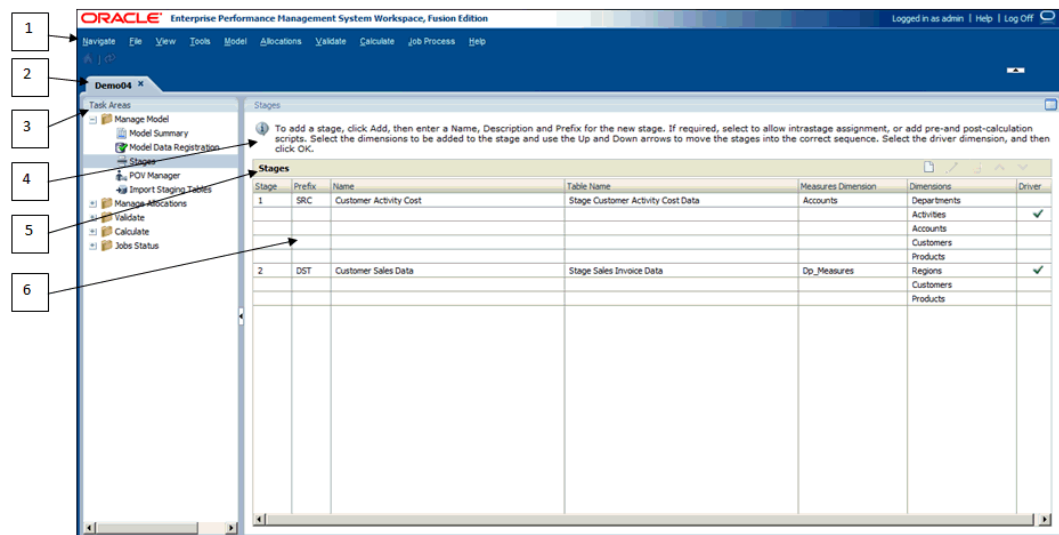

The Profitability and Cost Management workspace includes these items:

1. The main menu at the top of the window displays the common EPM Workspace menu options (Navigate, File, View, and Tools), and the Profitability and Cost Management main menu options, including Model, Allocations, Validate, Calculate, Job Status, and Help.
2. Application Name tab shows the name of the currently active application.
3. The Task Areas are used to select the tasks required to build, modify, validate model structure, and calculate models. You can also generate reports.

 **Note:**

When you change a Task Area, the Point of View selection that exists in the current task is retained. This feature enables you to move from screen to screen without be required to reselect the POV. The POV selection state remains the same until it is changed by the user and the POV "refresh" icon is clicked.

4. The Information Bar offers shortcut instructions for the currently selected task.
5. The title bar displays the name of the window currently displayed in the contents pane.
6. The contents pane displays the screen for the currently selected task, such as Stages or Driver Definitions.

Dimensions in Detailed Profitability and Cost Management Applications

Related Topics

- [About Detailed Profitability Dimensions](#)
Detailed Profitability enables you to use an existing relational database as the starting point for Detailed Profitability applications.
- [Detailed Profitability Dimension Types](#)
A dimension type is a dimension property that enables the use of predefined functionality in the application.

About Detailed Profitability Dimensions

Detailed Profitability enables you to use an existing relational database as the starting point for Detailed Profitability applications.

You create a Detailed Oracle Hyperion Profitability and Cost Management application in the Profitability Applications Console, and then deploy the application for use in Detailed Profitability models.

Caution:

Oracle recommends that the Detailed Profitability and Cost Management environment be created and maintained by experienced Database Administrators or System Administrators who have a good working knowledge of Detailed Profitability and Cost Management and the client's data model.

The dimensions are created and maintained in the Profitability Applications Console, and must exist before they can be used in Detailed Profitability models. Through the Profitability Applications Console, the Profitability and Cost Management Administrator can also select existing dimensions and members from other products, or create new dimensions and members specifically for the model. The common data can be shared and updated between multiple products and applications, such as Oracle Hyperion Planning. The dimensions and their members are available in the Detailed Profitability and Cost Management application after deployment.

The dimensions and members created in the Profitability Applications Console represent the structural elements of the business model. For general information about dimensions in Profitability and Cost Management, see [Profitability and Cost Management Dimensions](#).

▲ Caution:

Oracle recommends that you do not add or delete dimensions after the modeling process has begun; however, if new dimensions or members are added or deleted, you must redeploy the application. Take special care when deleting dimensions or members in a Detailed Profitability application as the action may have altered the Model Data Registration and invalidated the model.

The following types of dimensions can be used to create Detailed Profitability applications:

- At least one Business dimension (required) ([Detailed Profitability Business Dimensions](#))
- At least one managed POV dimension (required) ([Profitability and Cost Management POV Dimensions](#))
- Attribute dimensions (optional) ([Profitability and Cost Management Attribute Dimensions](#))
- Alias dimension (optional) ([Profitability and Cost Management Alias Dimensions](#))
- MeasuresDetailed dimension (required) ([MeasuresDetailed Dimension](#))
- Unmanaged dimensions ([Detailed Profitability Unmanaged Dimensions](#))

Within Detailed Profitability, you must register the user-defined measures dimensions for each stage table. These user-defined measure dimensions are business dimensions. Only two measures dimensions are registered for each application:

- One Source measure for the registered Source stage table and its joined lookup tables
- One Destination measure for the registered Destination stage table and its joined lookup tables

You may use the same measure for both stages, or select two different measures. See [Registering Detailed Profitability Model Data](#).

▲ Caution:

If the dimension members are not registered in Model Data Registration, the model validation fails.

For naming conventions for dimensions and members, see the *Oracle Hyperion Profitability and Cost Management Administrator's Guide*.

See [Detailed Profitability Dimension Types](#) for further information about specific dimension types.

Detailed Profitability Dimension Types

A dimension type is a dimension property that enables the use of predefined functionality in the application.

The specific characteristics of the dimension type manage the behavior and functions of the dimension. Because Oracle Hyperion Profitability and Cost Management and other Oracle Hyperion Enterprise Performance Management Workspace products may share certain dimension types, you can leverage the functionality of dimensions for different products, such as Oracle Hyperion Planning.

Note:

When defining dimensional outlines, there are restricted characters that may not be used for naming. Oracle strongly suggests that you review the Oracle Essbase naming conventions described in the *Oracle Essbase Database Administrator's Guide* to view the latest restrictions.

[Dimension Types](#) describes dimension types used by all types of Profitability and Cost Management applications.

See the following sections for information about specific Detailed Profitability dimension types:

- [Detailed Profitability Business Dimensions](#)
- [MeasuresDetailed Dimension](#)
- [Detailed Profitability Unmanaged Dimensions](#)

Detailed Profitability Business Dimensions

The Business dimensions in the model contain members that store information that is specifically related to the requirements of the business or organization, such as product types, sales regions, manufacturing processes, general ledger accounts, payroll, departments, activities, locations, customers, and products and so on. They may apply to one or more stages or models.

At least one Business dimension type must be defined when creating the Detailed Profitability application by the user.

One or two of the Business dimensions are used as Measures dimensions when defining the Source and Destination stages for the application. These dimensions are identified as the Source or Destination Measures dimensions during Model Data Registration. For Business dimension metadata requirements, see [Profitability and Cost Management Business Dimensions](#).

MeasuresDetailed Dimension

The MeasuresDetailed dimension is a reserved dimension that contains the Allocation members required to support stage balancing and other verification activities, such as

contributions and reconciliation. The MeasuresDetailed dimension does not contain Driver measures.

The MeasuresDetailed dimension is selected during the creation of the Detailed Profitability application in Profitability Applications Console. It is a single selection, but contains the following measures:

Dimension Member	Formula or Calculated Result
Unassigned	The result of Input + Received - Assigned - Idle + OverDriven
Assigned:	
AssignedPostStage	The sum of all amounts assigned to the Destination stage
AssignedIntraStage	Not used for Detailed Profitability
OverDriven	Sum of all calculated OverDriven values
IdleCost	Input that is not assigned to the destination is the IdleCost value. Calculated results for IdleCost are assigned depending on the driver type: <ul style="list-style-type: none"> For ratio-based drivers, if Allow Idle is selected, IdleCost is generated using the formula $\text{IdleDriverValue} / \text{OverrideTotalDriverValue}$. For rate-based drivers, IdleCost is generated if the sum of allocates values is less than the source object's input value.
Received:	
ReceivedPriorStage	Calculated value received from the Source stage
ReceivedIntraStage	Not used for Detailed Profitability
Input	External data that has been loaded to Input. Do not modify this amount.

Caution:

Do not edit members in this dimension, because modifications may result in the loss of data or the corruption of the model.

Detailed Profitability Unmanaged Dimensions

Unmanaged dimensions are constantly changing objects, such as IDs, dates, and audit information that are required for allocations. These unmanaged dimensions exist in the selected Model Data Schema. These dimensions must also be mapped as an "Unmanaged Dimension" during Model Data Registration so they are identified by the system.

You can access these columns within data filters in destination assignment rules.

Managing Detailed Profitability Models

Related Topics

- [About Managing Models](#)
The Managing Models options are used to build the top-level structure of a model, and to control model preferences and connections.
- [Working With Calculation Rules](#)
Calculation Rules are a super set of calculation artifacts, encapsulating sources, destinations, and drivers.
- [Working with the Detailed Profitability Model Summary](#)
The Detailed Profitability Model Summary displays details of the system information for the selected application, and enables you to modify model level preferences.
- [Registering Detailed Profitability Model Data](#)
Detailed Oracle Hyperion Profitability and Cost Management enables you to use the existing database tables as data sources in the application, rather than having to enter data to create a brand new application.
- [Managing Detailed Profitability Stages](#)
In Detailed Oracle Hyperion Profitability and Cost Management, there are only two stages in the model.
- [Working with Detailed Profitability Points of View](#)
The Point of View (POV) for a model provides a specific view of the model information for a selected time period, such as a year, period, and scenario.
- [Importing Detailed Profitability Staging Tables](#)
You can enter data and model information directly into Oracle Hyperion Profitability and Cost Management; however, the data entry may be very time-consuming.

About Managing Models

The Managing Models options are used to build the top-level structure of a model, and to control model preferences and connections.

- From the Model Summary, you can view system information and set model-level preferences.
- Under Model Data Registration, you map the existing tables to the application.
- From Stages, you assign the Business dimensions that apply to the Source and Destination stages of the model.
- Points of View (POVs) are used to create various versions of a model; for example, to hold budget versus actual figures, or to play scenarios to measure the impact of various changes on the bottom line.
- Import Staging Tables enable you to run import configurations to load model information, such as driver definitions, driver selections, assignments, and so on, to Detailed Oracle Hyperion Profitability and Cost Management.

See these sections to manage the models:

- [Working With Calculation Rules](#)
- [Working with the Detailed Profitability Model Summary](#)
- [Registering Detailed Profitability Model Data](#)
- [Managing Detailed Profitability Stages](#)
- [Working with Detailed Profitability Points of View](#)
- [Importing Detailed Profitability Staging Tables](#)

Working With Calculation Rules

Calculation Rules are a super set of calculation artifacts, encapsulating sources, destinations, and drivers.

Calculation Rules allows you to use sources, destinations and drivers to create broad allocations, reserving individual assignments to create exceptions to these calculation rules.

The Calculation Rules information panel displays the basic information about the rules and is the control point for viewing information about the rule in the Calculation Rule Definition pane. It is also the control point for the definition and execution order of Calculation Rules.

The Calculation Rules screen consists of 3 areas:

- **POV Bar**—Displays the currently selected POV. Calculation Rules are unique to each POV. For more information on POVs, see [Working with Detailed Profitability Points of View](#).
- **Calculation Rules Section**—Displays basic information about Calculation Rules. Its default sort (and primary usage) is by Calculation Rule Sequence number. You review the order of Calculation Rules in this pane but you can also sort and filter on the other columns to isolate rules for review purposes.
- **Rule Definition Section**—Displays the definition of the calculation rule highlighted on the Calculation Rules Pane.

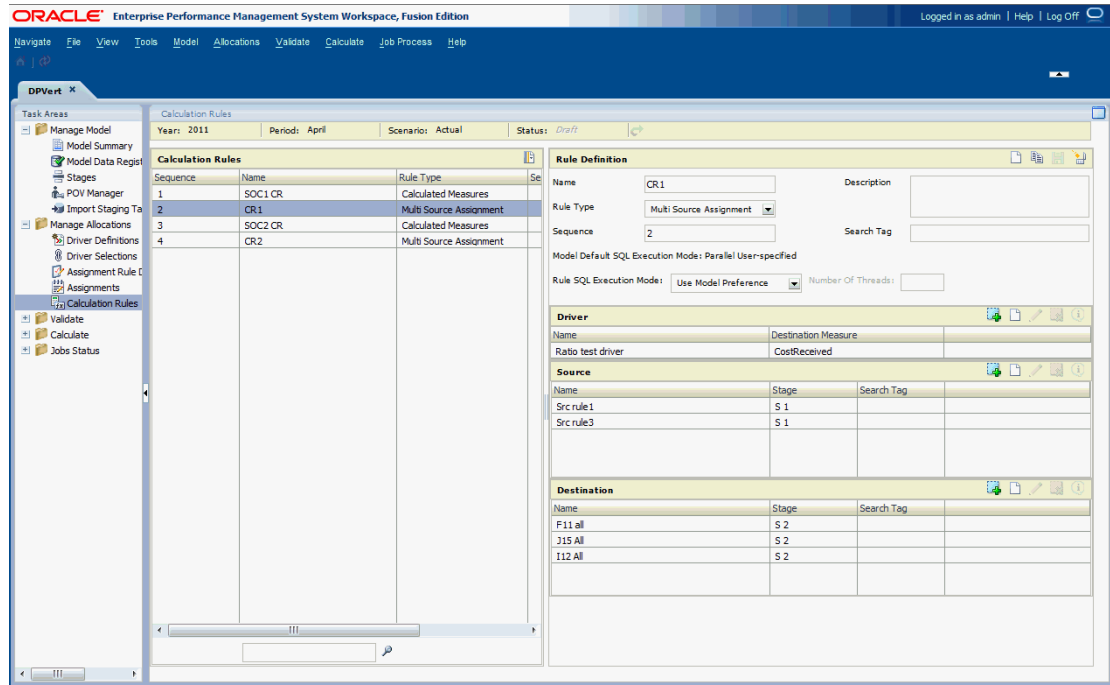

Adding Calculation Rules

The Calculation Rule Definition Pane displays all the components that define the rule.

To add a rule:

1. From Oracle Hyperion Enterprise Performance Management Workspace, select **Navigate**, then **Applications**, then **Profitability**, and then select the application that you want to view.
2. In an open model, from **Task Areas**, select **Manage Allocations**, and then **Calculation Rules**.
3. In the Rule Definition section, click the New Calculation Rule and then enter the following fields:
 - In **Name**, enter a calculation rule name.
 - In **Rule Type**, select one of the following values:
 - **Multi Source Assignment**—Defines allocations from multiple sources to multiple destinations; must have 1-5 source assignment rules, 1-5 destination assignment rules and 1 driver.
 - **Calculated Measures**—Defines basic mathematical calculations to modify the destination measure values; must have up to 1-5 destination assignment rules and 1-5 drivers.
 - **Single Source Assignment**—Executes individual assignments that act as exceptions to the Multi-source rule; must have a First and Last Driver Sequence Priority or select all drivers checked.
 - In **Sequence**, enter a numeric value from 0-9999.
 - In **Optional: Rule SQL Execution Mode**,

- **Optional:** In **Description**, enter a brief description of the rule.
 - **Optional:** Enter a **Search Tag** to facilitate later searches for the rule.
4. The **Model Default SQL Execution Mode** is displayed. Use the default or override it in **Rule SQL Execution Mode**.
 5. Enter one of the following in the **Driver** section:
 - For **Multi Source Assignment** and **Calculated Measures** calculation rules:
Click **Add driver** and select the existent driver or click **New driver** to create new driver.
 - For **Single Source Assignment** calculation rule:
 - In **First Driver Sequence Priority** and **Last Driver Sequence Priority** enter an integer driver sequence priority value to provide a range of drivers
 - Check **Select all drivers** in order to cover all drivers
 6. For **Multi Source Assignment**, in the **Source** section:
 - For existent source assignment rule(s): Click **Add source assignment rule** and move existent source assignment rule(s) from the **Available List** to the **Selected List**.
 - For new source assignment rule(s): Click **New source assignment rule** and then select it.
 7. For **Multi Source Assignment** and **Calculated Measures** calculation rules, in the **Destination** section:
 - For existent destination assignment rule(s): Click **Add destination assignment rule** and move existent destination assignment rule(s) from the **Available List** to the **Selected List**
 - For new destination assignment rule(s): Click **New destination assignment rule** and then select it.

 **Note:**

For Calculated Measures calculation rules destination assignment rules with Same as Source options should be filtered from the Available destination assignment rules.

8. Click **Save**. The rule definition displays in the **Calculation Rules** section.

Modifying Calculation Rules

To modify a calculation rule:

1. In **Calculation Rules**, select a rule.
2. In **Rule Definition**, modify the following fields:
 - Name
 - Rule Type
 - Sequence

- Description
 - Search Tag
3. In **Driver**:
 - For **Multi Source Assignment** and **Calculated Measures** calculation rules:
 - Change the selected/add driver: Click **Add driver** to select an existent driver or click **New driver** to create a new driver and then select it
 - Modify selected driver: Click **Edit driver**
 - Remove a selected driver: Click **Remove selected driver**
 - For **Single Source Assignment** calculation rule:
 - Modify **First Driver Sequence Priority** and **Last Driver Sequence Priority** driver sequence priority values
 - Change Select all drivers option state
 4. In **Source** for **Multi Source** Assignment calculation rule:
 - Change the selected/add source assignment rule: Click **Add source assignment rule** to select an existing source assignment rule or click **New source assignment rule** to create new source assignment rule and then select it
 - Modify selected source assignment rule: Click **Edit source assignment rule**
 - Remove selected source assignment rule: Click **Remove selected source assignment rule**
 5. In **Destination** for **Multi Source Assignment** and **Calculated Measures** calculation rules:
 - Change the selected/add destination assignment rule: Click **Add destination assignment rule** to select an existing destination assignment rule or click **New destination assignment rule** to create a new destination assignment rule and then select it
 - Modify selected destination assignment rule: Click **Edit destination assignment rule**
 - Remove selected destination assignment rule: Click **Remove selected destination assignment rule**
 6. Click **Save calculation rule**.

Deleting Calculation Rules

To delete a calculation rule:

1. In **Calculation Rules** section, select a rule.
2. In the **Rule Definition** section, click **Delete calculation rule** .
3. Click **Yes** to affirm the deletion.

Copying Calculation Rules

To copy a calculation rule:

1. In **Calculation Rules** section, select a rule.

Table 17-1 System Information Tab

Tab Area	Description
Profitability RDB Information	Name of the relational database (RDB) server and the database in which the model data resides. The Schema version being used with the selected application is also displayed.
Essbase Information	Essbase Application and Database names for the three optional reporting cubes: Source Stage, Contribution, and Destination Stage. See Managing Detailed Profitability Databases . Enter or modify the names of the Essbase applications and databases for the optional reporting cubes.
User Information	User ID for the user who is authorized to access the Oracle Hyperion Profitability and Cost Management database, and all associated security roles for that user. Note: Ensure that this user has been granted access to the databases and the application. See the <i>Oracle Hyperion Profitability and Cost Management Administrator's Guide</i> .
System Components Information	Details for each component in the installation, as follows: <ul style="list-style-type: none"> • System displays the name of the Enterprise Performance Management component. • Cluster displays the name of the server or cluster that is hosting that component. • HTTP Port displays the port being used by the component. • HTTPS Port displays the secure port being used by the component, if available. • Version/Build displays the version and build number for the listed component.

You can sort the list by clicking the column header. The System and Host are sorted alphabetically, and the ports and version/build are sorted numerically.

Selecting the Detailed Model Data Schema

Use the Model Level Preferences tab to select the Model Data Schema that is to be associated with the application. You can customize the application to use the display preferences. The settings on the Model Level Preference tab apply to the entire model.

The tab also displays the type of Oracle Hyperion Profitability and Cost Management application as Detailed.

To set model level preferences:

1. From Oracle Hyperion Enterprise Performance Management Workspace, select **Navigate**, then **Applications**, then **Profitability**, and then select the application that you want to view.
2. From **Task Areas**, select **Manage Model**, then **Model Summary**, and then select the **Model Level Preference** tab.

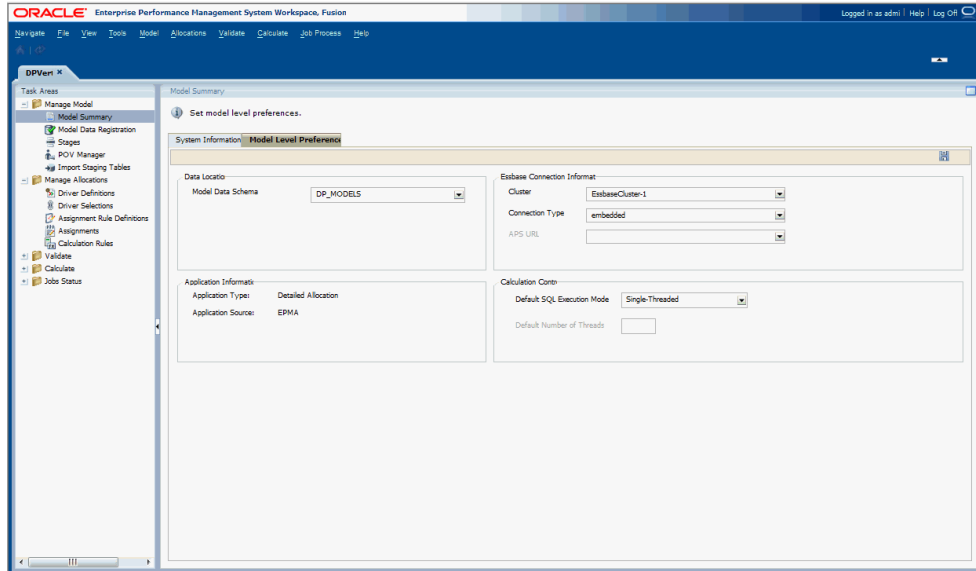

3. Under **Model Preferences** on the **Model Level Preference** tab, select the **Model Data Schema** to be used for this Detailed Profitability and Cost Management application.
4. Under **Essbase Connection Information**, enter Oracle Essbase connection information for the model. The required information is described in [Table 1](#).

Table 17-2 Essbase Connection Information

Setting	Action
Cluster	Select the logical name of the Essbase server that provides the connection to the Essbase databases. This name may point to a clustered or non-clustered Essbase server.
Connection Type	Select the type of connection: <ul style="list-style-type: none"> • Embedded • APS See the <i>Oracle Hyperion Provider Services Administration Guide</i> .
APS URL	Activated only if APS is selected as the Connection Type Select the URL for the APS that represents the Logical Web Application (LWA) of the server on which Oracle Hyperion Provider Services is running. The available APS servers are registered in Oracle Hyperion Shared Services registry during configuration. By default, the APS URL is <code>http://localhost:13080/aps/JAPI</code> .

5. Under **Application Information**, **Application Type** and **Application Source** are displayed.

Application Type is Detailed Allocation and **Application Source** is either Managed or Native.

The application type and application source are selected when you create the application in the Profitability Applications Console and cannot be changed.

6. **For Oracle RDBMS, only:** Under Calculation Control, select the **Default SQL Execution Mode** and enter the **Default Number of Threads**. The required

information to set the calculation controls is described in [Table 2](#). You can override these fields when you define the calculation rule definition.

Table 17-3 Calculation Control Information

Default SQL Execution Mode	Description	Default Number of Threads
Parallel Auto	Enables parallel SQL DML operations; Oracle determines the degree of parallelism.	This field is disabled in the User Interface.
	<div style="border: 1px solid #ccc; padding: 10px; background-color: #fff9c4;"> <p>▲ Caution:</p> <p>Oracle recommends that you use this setting only under the direction of a qualified Oracle database administrator.</p> </div>	
Parallel User-specified	Enables parallel SQL DML operations; the degree of parallelism is specified in the Default Number of Threads field.	The field, enabled in the User Interface, specifies the maximum degree of parallelism that Oracle uses for parallel DML operations. The optimal number of threads depends on the resources (processors, memory, storage, and IO throughput) available to the Oracle RDBMS.
	<div style="border: 1px solid #ccc; padding: 10px; background-color: #fff9c4;"> <p>▲ Caution:</p> <p>Oracle recommends that you discuss this option prior to its use with a qualified Oracle database administrator.</p> </div>	
Single-Threaded (default)	Parallel SQL DML operations are not enabled; Oracle executes SQL DML statements in single-threaded mode.	This field is disabled in the User Interface.

7. Click **Save** .

Registering Detailed Profitability Model Data

Detailed Oracle Hyperion Profitability and Cost Management enables you to use the existing database tables as data sources in the application, rather than having to enter data to create a brand new application.

To effectively use the existing tables, you must map them to the Detailed Profitability and Cost Management application through the Model Data Registration process. You can register a database table or view for use within the application, or edit or delete an existing registration.

▲ Caution:

Oracle recommends that Model Data Registration be completed by an experienced Database Administrator or System Administrator who is familiar with database concepts, and who has a working knowledge of the client's model data.

A Detailed Profitability model contains only two stages. The first step required in registering tables is to select a measure dimension for the Source and Destination stages. Only regular or generic Business dimensions can be used as the Source Measures Dimension or the Destination Measures Dimension for the application. You may use the same measures dimension for both the source and destination stages, or you may use a different measures dimension for each stage, depending on the structure of the business data.

- All registered source stage tables and their joined lookup tables use the Source measures dimension.
- All registered destination stage tables and their joined lookup tables use the Destination measures dimension.

You can also register views that have been created in the model data schema:

- Source Stage Tables and Lookup Tables for any view can be registered
- Destination Stage Tables can only register simple updatable views with no joins.

▲ Caution:

Although the tables referenced by the view may reside in any schema, you must issue the necessary database grants from each table that you want to register to the Profitability and Cost Management product schema. See the *Oracle Hyperion Profitability and Cost Management Administrator's Guide*.

Using Model Data Registration, you identify the tables that will be assigned to the source and destination stages, and you map columns on those tables to the measures and dimensions that you defined for the application in the Profitability Applications Console. As you register each column, you assign it to one of these types:

- Managed POV Dimensions - Managed through the Profitability Applications Console
- Managed Dimensions - Managed through the Profitability Applications Console. These are the business dimensions..
- Unmanaged Dimension – Dimensions that are not managed in the Profitability Applications Console, but that exist in the selected Model Data Schema.
- Measures - Members of the selected Source and Destination Measures Dimensions
- Audit Columns:
 - Audit: Last Modified By

- Audit: Last Modified Date

Managed dimensions and managed POV dimensions can be mapped directly. The unmanaged dimensions are dimensions such as IDs, dates, audit information, and very large dimensions that are required for allocations, but are not managed by the Profitability Applications Console. They must also be mapped so they are identified by the system. You can access these columns within data filters in destination assignment rules.

Lookup tables can be joined to the source or destination stage tables to make a logical "stage business object" that is expanded to include measure and dimension columns or values that are not available directly on the main stage table. The Profitability and Cost Management Administrator should set up these join definitions in Model Data Registration.

See the following sections:

- [Registering Model Data](#)
- [Mapping Columns](#)
- [Joining Lookup Tables](#)
- [Reviewing Model Data Registration Summary](#)

Registering Model Data

The first step required in registering tables is to select measure dimensions for the Source and Destination stages. You may select the same measure for each stage, or select different measures for each stage.

Caution:

After measures have been selected for both the Source and Destination, they cannot be changed as long as Model Data Registrations or Drivers exist. To select new values for the Source Stage Measure or the Destination Stage Measure, you must delete all registrations and drivers for the selected application.

If Measures contain different types of data (for example, numerical headcount versus monetary values), the Stage Balancing report may provide incorrect results because the different value types cannot be properly distinguished.

To obtain correct results and ensure the accuracy of the results on the Stage Balance view, locate the statistical measures as follows:

- For Vertical and Horizontal Source Tables, put all statistical measures on a joined lookup table.
- To locate Statistical measures directly on the source table (either Vertical or Horizontal), create a new dimension called "Source Measure Types", and assign the "input" member to all non-statistical measure members.

See the following sections to create and manage :

- [Creating a New Model Data Registration](#)
- [Modifying an Existing Model Data Registration](#)
- [Copying an Existing Model Data Registration](#)

- [Deleting an Existing Model Data Registration](#)

Creating a New Model Data Registration

You must specify the external table that you want to use as the data source for the Detailed Profitability application, apply a new table name, and select the table type that you want to use.

External tables may be horizontally or vertically oriented. For Source Stage tables, you can specify the type or orientation you want for the table that you are registering. Destination and Lookup tables cannot be changed, and are presented horizontally only.

To create a new Model Data Registration table:

1. From Oracle Hyperion Enterprise Performance Management Workspace, select **Navigate**, then **Applications**, then **Profitability**, and then select the application that you want to view.
2. From **Task Areas**, select **Manage Model**, and then **Model Data Registration**.

The Model Data Registration screen is displayed.

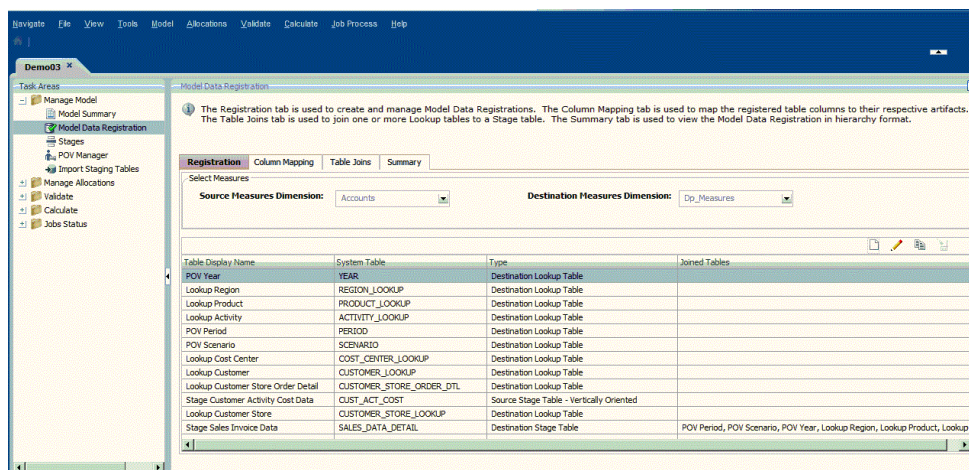

3. On the **Registration** tab, under **Select Measures**, select a measures dimension from the drop-down list for the **Source Measures Dimension** and the **Destination Measures Dimension**.

You may select the same measures dimension for each stage, or select different measures dimensions for each stage.

- All registered source stage tables and their joined lookup tables use the Source measures dimension.
- All registered destination stage tables and their joined lookup tables use the Destination measures dimension.

Only Business dimensions can be used as the Source or Destination Measures dimension. You cannot use an Alias, Attribute or unmanaged dimension.

Caution:

After measures have been selected for both the Source and Destination stages, the measures cannot be changed as long as the Model Data Registrations or drivers exist.

4. On the **Registration** tab, click **Add new table.** 

Step 1: Select Table wizard is displayed.

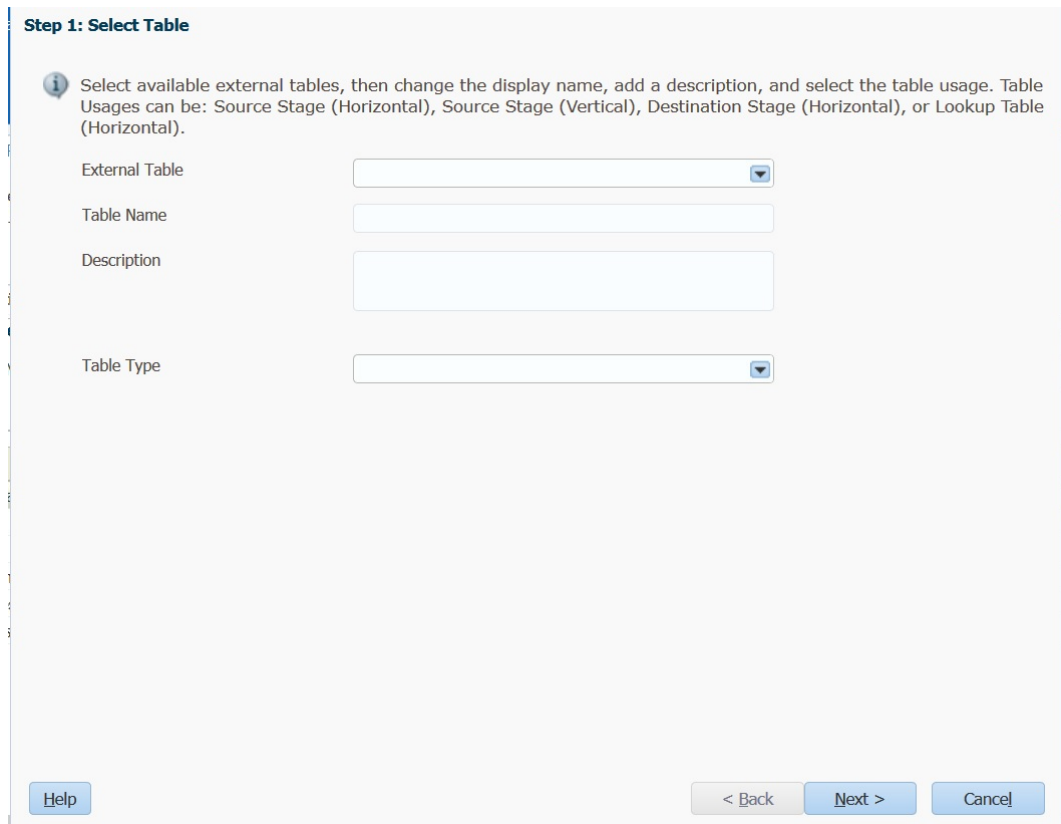

5. From **External Table**, select the name of the existing table or view that you want to use as the data source. This list displays all external tables to which the user has Read or Write access.

Register tables and columns that only use uppercase characters, numbers, and "_" or "\$" in their names. Any tables or columns having invalid names will not appear for selection.

6. In **Table Name**, enter a user-friendly name for the registered table.
7. **Optional:** Enter a brief description of the purpose or contents of the table.
8. From **Table Type**, select the table type and orientation for the table to be registered:
 - Source Stage Table - Horizontally Oriented: Measures are stored in separate columns on the table, with one column for each distinct measure.

- Source Stage Table - Vertically Oriented: Measures values are stored in separate rows in the table, with the measure value in one column, and the measure identification in the measures dimension column.
- Destination Stage Table
- Source Lookup Table
- Destination Lookup Table

 **Note:**

The available Lookup table types depend on the Measures selected on the **Registration** tab. If two separate measure dimensions are registered, then two Table Type choices are available (Source Lookup Table and Destination Lookup Table).

If the same measures dimensions are selected, then only one Table Type choice is available (Lookup Table).

9. Click **Next**.

Step 2: Select Columns screen is displayed.

Step 2: Select Columns

 Select the columns you wish to use by moving them from the Available Columns to the Selected Columns. Only columns that adhere to our naming conventions, ones that contain no spaces and have letters that are either all upper case or all lower case (no mixed case) will appear in the Available Columns shuttle.

Table Details

Table Name: Accounts	Table Type: Source Stage Table - Horizontally Oriented
External Table: MM1_DESTINATION	Measures Dimension: FinElement

Available Columns

- COST_RECEIVED
- F_MEM_ID
- G_MEM_ID
- H_MEM_ID
- I_MEM_ID
- J_MEM_ID
- MODIFIED_BY
- MODIFIED_DATE
- PERIOD
- PROD_VOLUME
- QUANTITY
- SCENARIO
- SOC1_RESULTS
- SOC2_RESULTS

➤

➤

⏪

Selected Columns

Help
< Back
Next >
Cancel

10. Under **Available Columns**, select the columns from the table that you are registering to use in the final table, and then click the Add arrows  to move the selections to **Selected Columns**.

You can select multiple columns at one time from the list:

- To select a range of columns, press **Shift** and select the first and last columns in the range.
- To select multiple random columns, press **Ctrl** and select individual columns from the list.

 **Note:**

Register tables and columns that only use uppercase characters, numbers, and "_" or "\$" in their names. Any tables or columns having invalid names will not appear for selection.

11. Click Next.

Step 3: Map Columns screen is displayed, listing details of the selected table.

Step 3: Map Columns

 Map your selected columns to one of the available column types.

Table Details

Table Name: Accounts	Table Type: Source Stage Table - Horizontally Oriented
External Table: MM1_DESTINATION	Measures Dimension: FinElement

Select Column Types

Selected Columns	Column Type
COST_RECEIVED	POV Dimension <input type="text" value="v"/>
PROD_VOLUME	Dimension <input type="text" value="v"/>
QUANTITY	Dimension <input type="text" value="v"/>

12. Under **Select Column Types, map the **Selected Columns** to the available column types:**

- POV Dimension
- Dimension
- Unmanaged Dimension
- Measure
- Audit: Last Modified By
- Audit: Last Modified Date

13. Click **Next**.

Step 4: Rename Special Columns screen is displayed, showing any unmanaged and Audit dimensions, such as IDs, dates, audit, and so on. If you do not have any unmanaged or Audit dimensions, the list is blank.

Step 4: Rename Special columns

i Assign Display Names for any audit columns and unmanaged dimension columns.

Table Details

Table Name: Accounts	Table Type: Source Stage Table - Horizontally Oriented
External Table: MM1_DESTINATION	Measures Dimension: FinElement

Rename Special Columns

Selected Columns	Column Type	Column Name

Help < Back Next > Cancel

14. **Optional:** Enter the new user-friendly name to be associated with the previously selected unmanaged and Audit dimensions under **Column Name**. These names make the dimensions easier to use.

15. Click **Next**.

Step 5: Map and Rename Dimensions Columns screen is displayed.

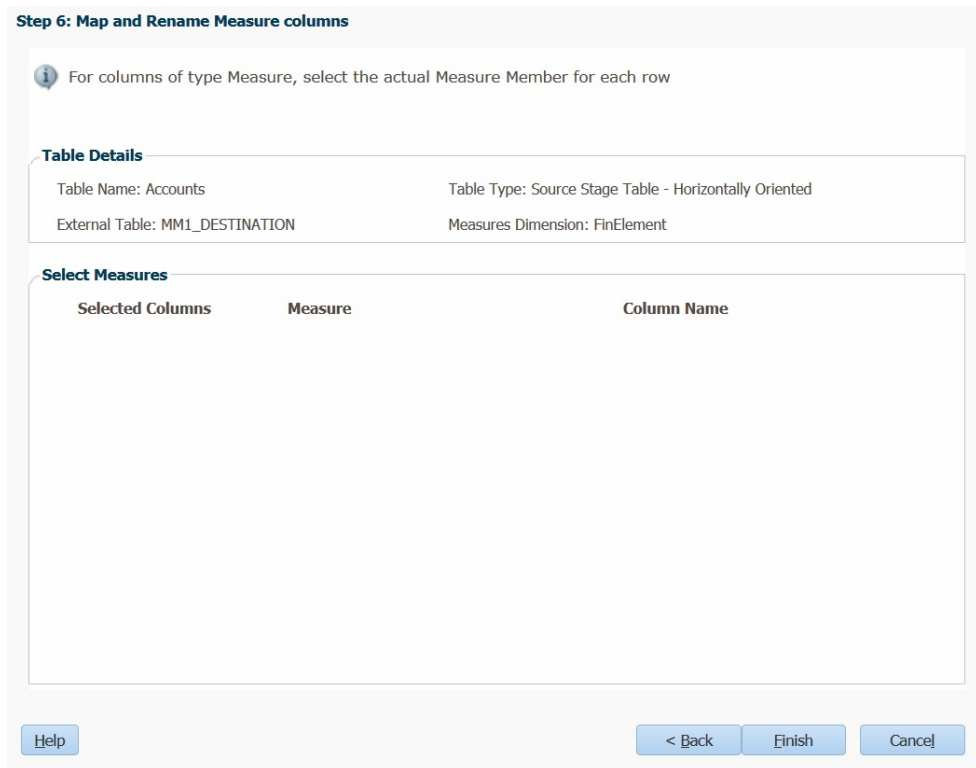

18. Under **Measure**, for Measure type columns, select the actual Measure member for each row. The selected Measure is automatically displayed under **Column Name**. You can change this value, if required.
19. Click **Finish**.
 The table is registered, and displayed on the list of registered tables on the **Registration** tab.

Modifying an Existing Model Data Registration

To modify an existing Model Data Registration table:

1. From Oracle Hyperion Enterprise Performance Management Workspace, select **Navigate**, then **Applications**, then **Profitability**, and then select the application that you want to view.
2. From **Task Areas**, select **Manage Model**, and then **Model Data Registration**.
3. On the **Registration** tab, select the table to modify, and then click **Edit Table** .
4. **Optional:** On the **Select Table** screen, modify information about the table, including the Table Name and Description, and then click **Next**.

The External Table selection and Table Type cannot be modified.

5. **Optional:** On the **Select Columns** screen, modify the column selection, using the Add arrows and Remove arrows to move the selections to **Selected Columns**.

You can select multiple columns at one time from the list:

- To select a range of columns, press **Shift** and select the first and last columns in the range.

- To select multiple random columns, press **Ctrl** and select individual columns from the list.
6. Click **Next**.
 7. **Optional:** On the **Map Columns** screen, modify the mapping of the newly selected columns to the available column types, and then click **Next**.
 8. **Optional:** On the Rename Special Columns screen, modify any newly selected unmanaged columns, and then click **Next**.
 9. **Optional:** On the **Map and Rename Dimension Columns** screen, modify any Dimensions or POVs under **Dimension/POV** or the **Column Name**, and then click **Next**.
 10. **Optional:** On the **Map and Rename Measure Columns** screen, under **Measure**, for Measure type columns, modify the actual Measure member for any row, and then click **Finish**.
 Modifications to the table are registered.
 11. Click **Finish**.

Copying an Existing Model Data Registration

To copy an existing Model Data Registration table to create a new model data registration :

1. From Oracle Hyperion Enterprise Performance Management Workspace, select **Navigate**, then **Applications**, then **Profitability**, and then select the application that you want to view.
2. From Task Areas, select **Manage Model**, and then **Model Data Registration**.
3. On the **Registration** tab, select the table that you want to copy, and then click **Duplicate Table** .





4. On the Create a Duplicate Table dialog box, enter a name for the new table, and then click **OK**.

Deleting an Existing Model Data Registration

To delete an existing Model Data Registration table:

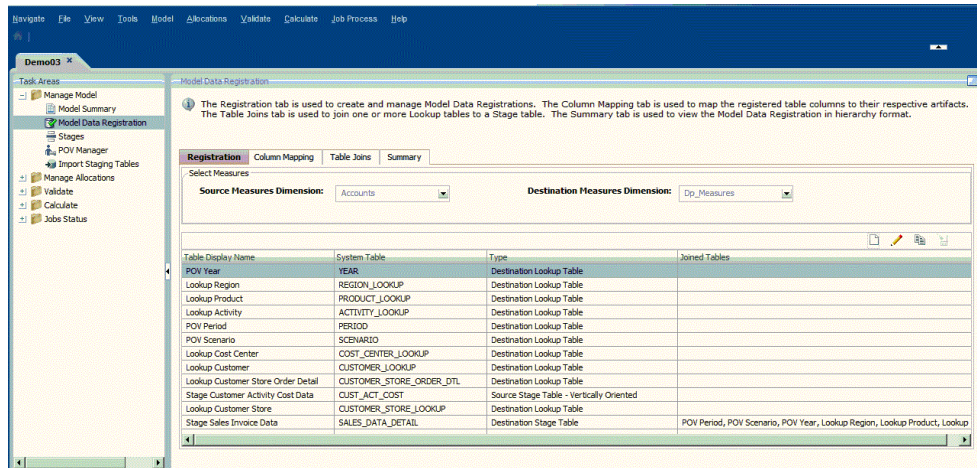
1. From Oracle Hyperion Enterprise Performance Management Workspace, select **Navigate**, then **Applications**, then **Profitability**, and then select the application that you want to view.
2. From Task Areas, select **Manage Model**, and then **Model Data Registration**.



3. On the **Registration** tab, select the table that you want to delete, and then click **Delete Table** .
4. After the confirmation dialog "You are about to delete selected Table. Do you want to proceed?" is displayed, confirm the deletion.
 The Model Data Registration information for the selected table is deleted.

Mapping Columns

The Column Mapping tab is used to map the registered table columns to their respective dimensions in the selected table.

See the following sections:

- [Viewing Column Mappings](#)
- [Modifying Column Mappings](#)
- [Deleting Column Mappings](#)

Viewing Column Mappings

To view column mappings:

1. From Oracle Hyperion Enterprise Performance Management Workspace, select **Navigate**, then **Applications**, then **Profitability**, and then select the application that you want to view.
2. From **Task Areas**, select **Manage Model**, and then **Model Data Registration**.
3. Select the **Column Mapping** tab.
4. For **Select Table**, select the stage table for which you want to view the column mapping.

The associated System Table and Table Type are displayed.

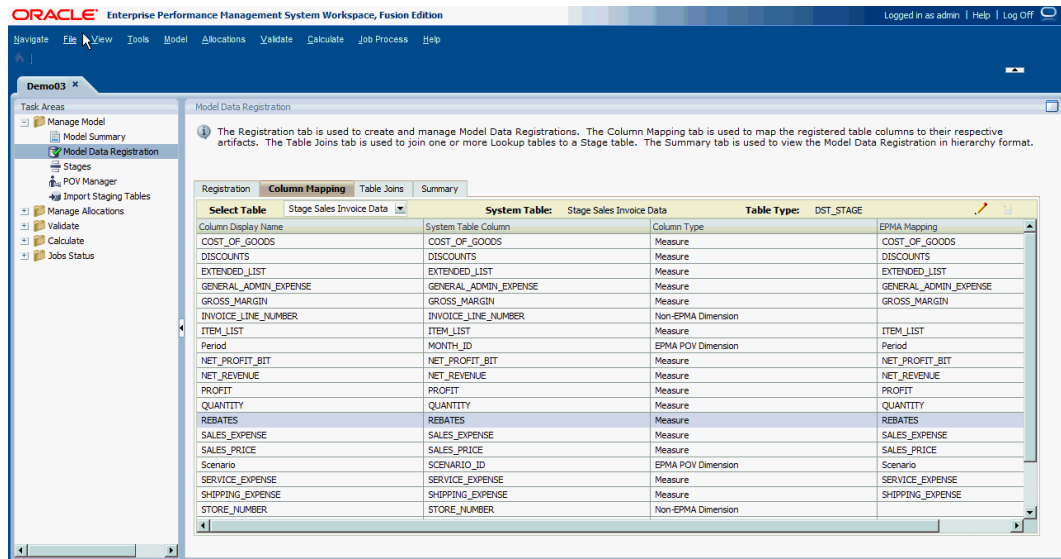

5. Review the column mappings:
 - **Column Display Name** displays the assigned display name for the column
 - **System Table Column** displays the name of the column for the selected System Table
 - **Column Type** displays the type to which the column has been mapped:
 - POV Dimension
 - Dimension
 - Unmanaged Dimension
 - Measure
 - Audit: Last Modified By
 - Audit: Last Modified Date
 - **Dimension Mapping** displays the dimensions or dimension members to which the column is mapped.

Modifying Column Mappings

To modify column mappings:

1. From Oracle Hyperion Enterprise Performance Management Workspace, select **Navigate**, then **Applications**, then **Profitability**, and then select an application.
2. From **Task Areas**, select **Manage Model**, and then **Model Data Registration**.
3. Select the **Column Mapping** tab.
4. In **Select Table**, select the stage table for which you want to modify the column mapping.
5. Select a column, and then click **Edit Column Mapping** .
6. In the **Rename Special Columns** dialog box, under **Column Name**, modify the column names for each dimension to be changed, and then click **Next**. If the application does not contain unmanaged dimensions, this screen will be blank.

7. In the **Map and Rename Dimension Columns** dialog box, under **Column Name**, modify each column name that you want to change, and then click **Next**.
Under Dimension/POV you can modify the selected dimension, if required.
8. In the **Map and Rename Measure Columns** dialog box, under **Measure**, select the actual member to be used for each column, and then click **Finish**.
All column modifications are applied.

Deleting Column Mappings

To delete column mappings:

1. From Oracle Hyperion Enterprise Performance Management Workspace, select **Navigate**, then **Applications**, then **Profitability**, and then select the application that you want to view.
2. From Task Areas, select **Manage Model**, and then **Model Data Registration**.
3. Select the **Column Mapping** tab.
4. Under **Select Table**, select the stage table for which you want to delete the column mapping.
The associated System Table and Table Type are displayed.
5. Under **Column Display Name**, select the name of the column that contains the mapping that you want to delete, and then click **Delete Column Mapping** .
The mapping for the selected column is deleted.

Joining Lookup Tables

There may be instances when a Stage Table designated as a Source table does not provide enough supporting detail within the table. Lookup tables are existing client tables that can be joined to a Source or Destination table to extend the contents of that stage table, providing additional information or data.

A table can be joined to a stage table if it uses the same list of measures, same measure dimension, as the stage table. For example, a table can be a Source Lookup Table if one or more columns are mapped to a member value from the Source Measure Dimension.

Each lookup table adds to the calculation and processing times for the selected stage table. The more lookup tables that are involved in the calculation, the greater the processing time. Not all lookup tables need to be involved in a calculation. For example, you may have 10 tables joined to the stage table, but if a driver is using only three of these tables, the processing impact involves those three tables only.

Joining Tables to a Lookup Table

To join tables to a lookup table:

1. From Oracle Hyperion Enterprise Performance Management Workspace, select **Navigate**, then **Applications**, then **Profitability**, and then select the application that you want to view.
2. From Task Areas, select **Manage Model**, and then **Model Data Registration**.

3. Select the **Table Joins** tab.
4. From **Stage Table**, select the stage table to which you want to join the lookup table.
 A list of tables that are currently joined to the stage table are displayed.

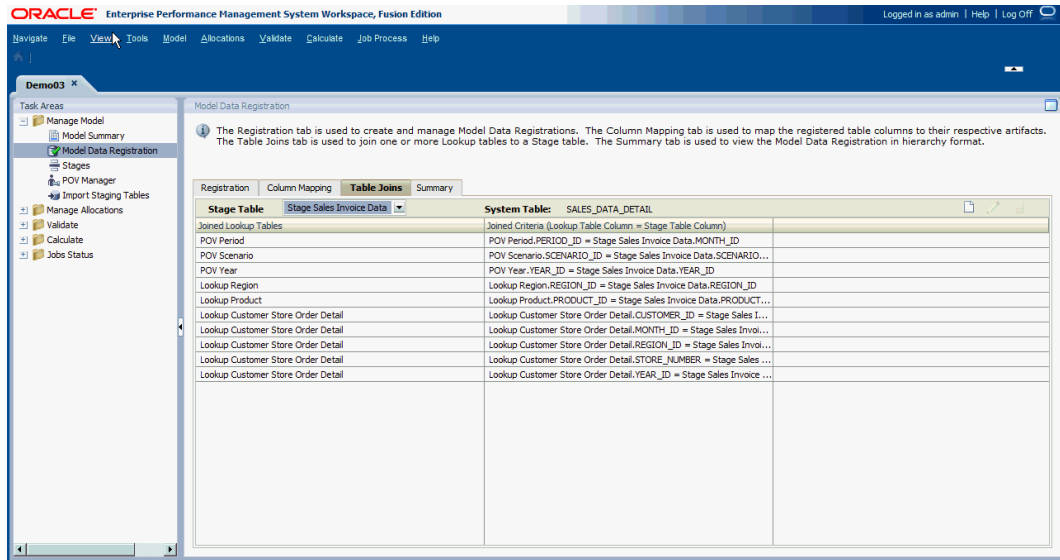

5. Click **Create a Table Join** .

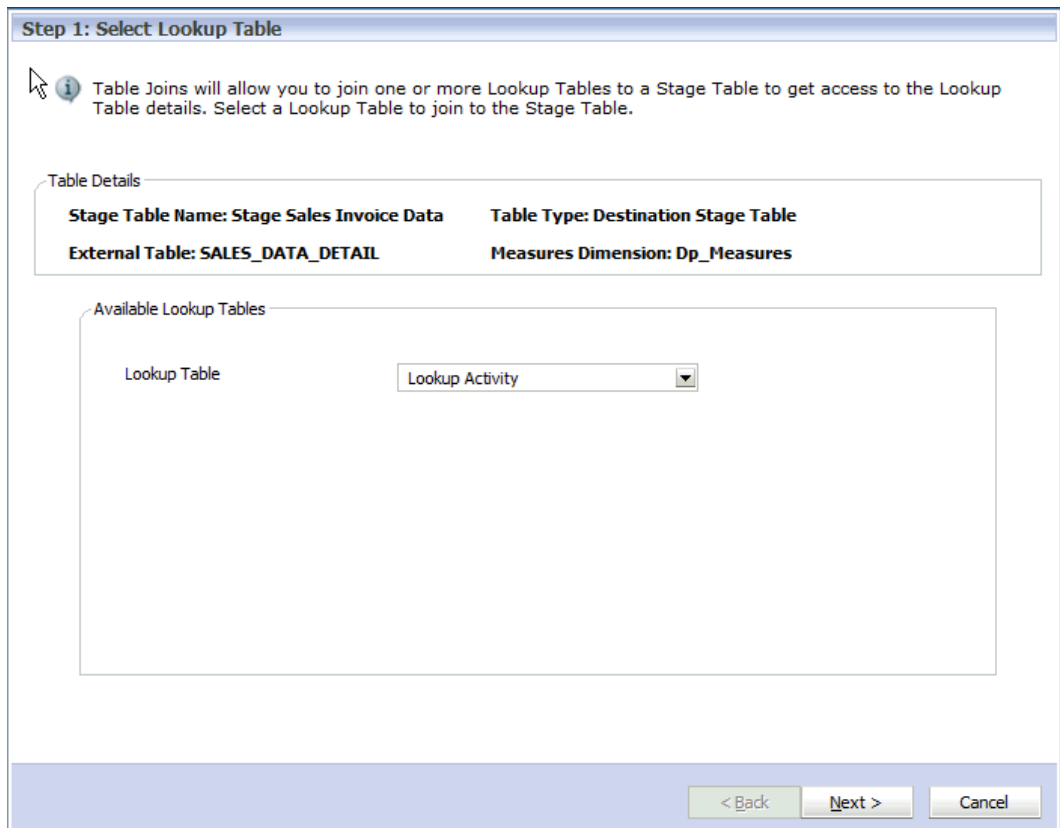

- On the **Select Lookup Table** wizard, under **Available Lookup Tables**, from the **Lookup Table** drop-down list, select the lookup table that you want to join to the selected stage table, and then click **Next**.

Step 2: Join Lookup Table to Stage Table



 Join the Stage Table to the Lookup Table by selecting the corresponding Join columns for each table selected in the prior steps. Use the optional Create/Delete buttons to add another join condition for the selected Stage/Lookup tables.



Table Details

Stage Table Name: Stage Sales Invoice Data	Table Type: Destination Stage Table
External Table: SALES_DATA_DETAIL	Measures Dimension: Dp_Measures
Lookup Table Name: Lookup Activity	Table Type: Destination Lookup Table
External Table: ACTIVITY_LOOKUP	

Join Details

Stage Table and Columns	Lookup Table and Columns
<input type="checkbox"/> Stage Sales Invoice <input type="text"/>	= Lookup Activity <input type="text"/>

- On the **Join Lookup Table to Stage Table** wizard, under **Join Details**, click **Add a new condition**  to add another table join to the stage table.
- From the **Stage Table and Columns**, select a stage table column, and then select a lookup table column under **Lookup Table and Columns**.
- Optional:** Under **Join Details**, select some join condition and click **Remove the condition**  to remove the selected condition.
- Click **Finish**.

Editing Lookup Table Joins

To edit table joins:

- From Oracle Hyperion Enterprise Performance Management Workspace, select **Navigate**, then **Applications**, then **Profitability**, and then select the application that you want to view.
- From Task Areas, select **Manage Model**, and then **Model Data Registration**.
- Select the **Table Joins** tab.
- From **Stage Table**, select the stage table to which you want to join the lookup table.

A list of tables that are currently joined to the stage table are displayed.

5. Click **Edit a Table Join** .
6. On the **Select Lookup Table** wizard, review the selected lookup table, and then click **Next**.
7. **Optional:** On the **Join Lookup Table to Stage Table** wizard, under **Join Details**, modify the selections for the Stage Table and Columns or the associated **Lookup Table and Columns**, as required.
8. Click **Finish**.

Removing Lookup Table Joins

To remove joined tables:

1. From Oracle Hyperion Enterprise Performance Management Workspace, select **Navigate**, then **Applications**, then **Profitability**, and then select the application that you want to view.
2. From Task Areas, select **Manage Model**, and then **Model Data Registration**.
3. Select the **Table Joins** tab.
4. From **Stage Table**, select the stage table from which you want to remove the lookup table association.

A list of tables that are currently joined to the stage table are displayed.

5. Under **Joined Lookup Tables**, select the joined criteria that you want to remove from the stage table.
6. Click **Delete a Table Join**  to delete the selected joined criteria from the stage table.
The joined criteria is removed from the list.

Reviewing Model Data Registration Summary

Use the Summary Tab of the Model Data Registration screen to view the details for a complete Source or Destination Stage Table, including the associated lookup tables and mapping.

To view Stage Table Summary:

1. From Oracle Hyperion Enterprise Performance Management Workspace, select **Navigate**, then **Applications**, then **Profitability**, and then select the application that you want to view.
2. From **Task Areas**, select **Manage Model**, and then **Model Data Registration**.
3. Select the **Summary** tab.

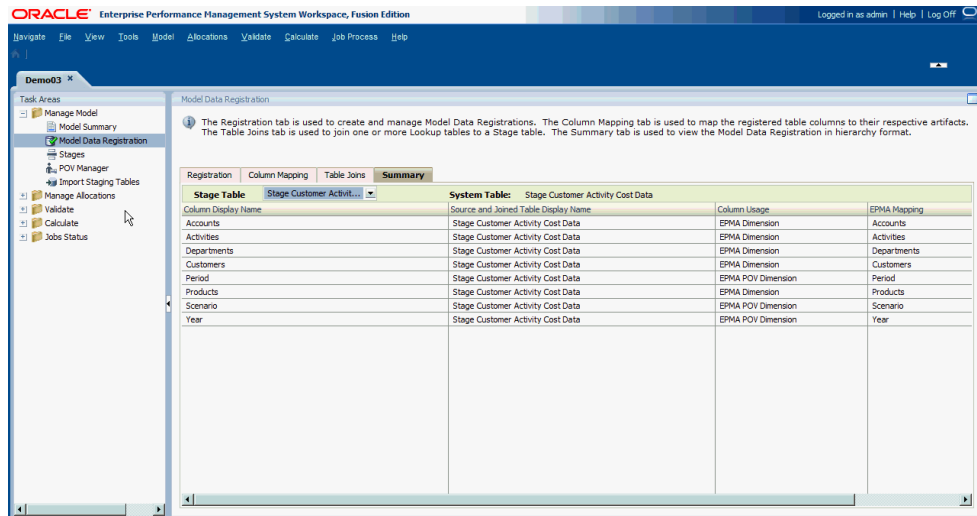

4. For **Stage Table**, select the Stage table for which you want to view details from the list of registered Stage tables.

The screen is populated with details for the selected table.

5. Review details for the selected table on the Summary tab:
 - **Column Display Name** displays the assigned name for the column
 - **Source and Joined Table Display Name** displays the name of the table assigned to the source and its associated joined tables
 - **Column Usage** displays the type to which the column has been mapped:
 - POV Dimension
 - Dimension
 - Unmanaged Dimension
 - Measure
 - Audit: Last Modified By
 - Audit: Last Modified Date
 - **Dimension Mapping** displays the dimensions or dimension members to which the column is mapped.

Managing Detailed Profitability Stages

In Detailed Oracle Hyperion Profitability and Cost Management, there are only two stages in the model.

- The Source Stage must be managed dimensions, may contain up to five managed dimensions, and may be sourced from a vertically or horizontally-oriented Source Stage Table from the Model Data Registration. One of the five source stage dimensions must be the Source Measures Dimension that you identified at the beginning of Table Registration.
- The Destination Stage may contain up to 25 Profitability and Cost Management-managed and regular business dimensions, but must be a horizontally-oriented Destination Stage Table from Model Data Registration.

 **Note:**

Unmanaged dimensions cannot be defined as stage dimensions. They can be used by the destination stage, but only in destination stage assignment rule data filters.

When you create a new application in the Profitability Applications Console and deploy it to Profitability and Cost Management, you use the Stages screen to create the Source stage (Stage 1) and the Destination stage (Stage 2). In Detailed Profitability applications, the source and destination stages have different characteristics, requirements and validations. However, these stages cannot serve as both source and destinations. Note that these stages cannot serve as both source and destinations.

After the two stages are set up, you cannot add a new stage after model data registration, unless one stage is deleted. See [Deleting Detailed Profitability Model Stages](#).

See the following procedures:

- [Adding Detailed Profitability Model Stages](#)
- [Modifying Detailed Profitability Model Stages](#)
- [Deleting Detailed Profitability Model Stages](#)

Adding Detailed Profitability Model Stages

Only two stages may exist in a Detailed Profitability model.

This option is not available if both stages already exist.

To add model stages:

1. From Oracle Hyperion Enterprise Performance Management Workspace, select **Navigate**, then **Applications**, then **Profitability**, and then select the application that you want to view.
2. From **Task Areas**, select **Manage Model**, and then **Stages**.

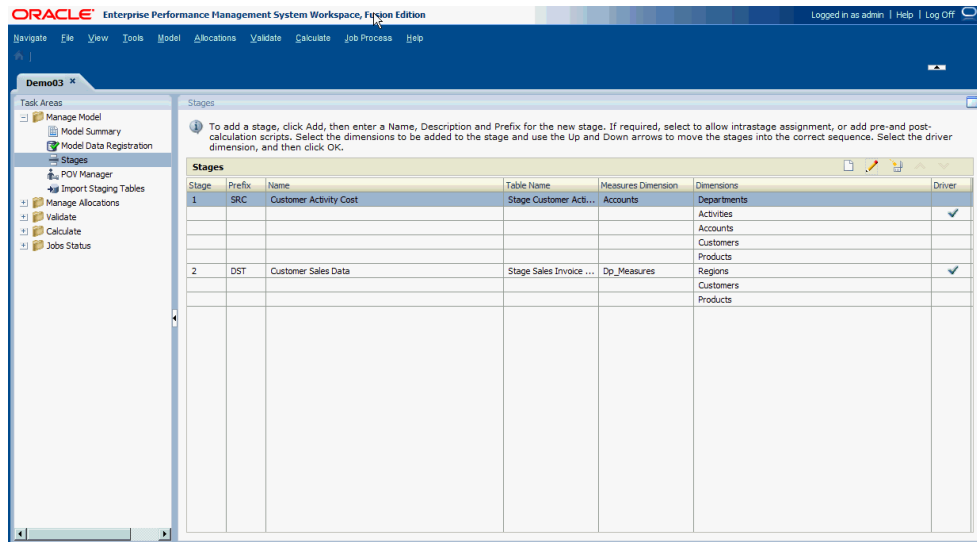

The Stages window provides the following information about the selected stage:

- **Stage** displays the stage order. The stage order determines whether the stage is the source or the destination.
- **Prefix** is the stage prefix that was entered during stage creation. It could indicate whether the stage is the Source (SRC) or Destination (DST) by its value.

 **Note:**

The prefixes do not impact the identification or source or destination stages. Stage 1 is always the source stage, and Stage 2 is always the destination stage.

- **Name** shows the assigned name of the stage, and usually identifies the business function or process of the stage, such as Customer Activity Cost or Customer Sales Data.
 - **Table Name** is the assigned display name for the registered table.
 - **Measures Dimension** displays the Measures dimension selected for the Stage during Model Data Registration.
 - **Dimensions** shows the dimensions included in the stage.
 - **Driver** dimension selected for the stage is indicated by a check mark.
3. If two stages do not already exist, click **Add Stage** . The Stage dialog box is displayed.

Stage

Name:

Description:

Prefix:

Table Name:

Measures Dimension: Accounts

Stage Dimensions



Order	Dimension	Driver
1	Departments	<input type="radio"/>
2	Activities	<input checked="" type="radio"/>
3	Accounts	<input type="radio"/>
4	Customers	<input type="radio"/>
5	Products	<input type="radio"/>

Buttons: Help, OK, Cancel

4. Enter the following details for the stage:
 - Enter the assigned **Name** for the stage. The name usually identifies the business function or process of the stage, such as Customer Activity Cost or Customer Sales Data.
 - Select the **Prefix** to help to indicate, for example, whether the stage is the Source (SRC) or Destination (DST).
 - **Optional:** Enter a brief description of the purpose or contents of the stage.
 - Select the **Table Name** that was assigned during Model Data Registration.
 - Under **Measures Dimension**, verify the Measures dimension associated with the selected stage during Model Data Registration.
5. Under **Stage Dimensions**, click **Add**  to add a dimension for the stage.

 **Note:**

When adding dimensions for the selected stage, you must also add the Source Measures Dimension that you defined in Model Data Registration as one of the dimensions for the Source Stage. Do not include the Destination Measures Dimension in the definition of the Destination stage.

6. Repeat step 5 to add each dimension for the selected stage. You can add up to 5 dimensions for a Source Stage and up to 25 dimensions for a Destination Stage.
7. **Optional:** Under **Order**, select a dimension to enable the Up  and Down  arrows to move the dimension up or down into the correct sequence. Move all dimensions using the arrows.
8. Under **Driver**, select the dimension which is the driver for the selected stage. The designated driver is indicated with a check mark.
9. Click **OK**.

Modifying Detailed Profitability Model Stages

Model stages can be easily modified.

To modify model stages:

1. From Oracle Hyperion Enterprise Performance Management Workspace, select **Navigate**, then **Applications**, then **Profitability**, and then select the application that you want to view.
2. From Task Areas, select **Manage Model**, and then **Stages**.

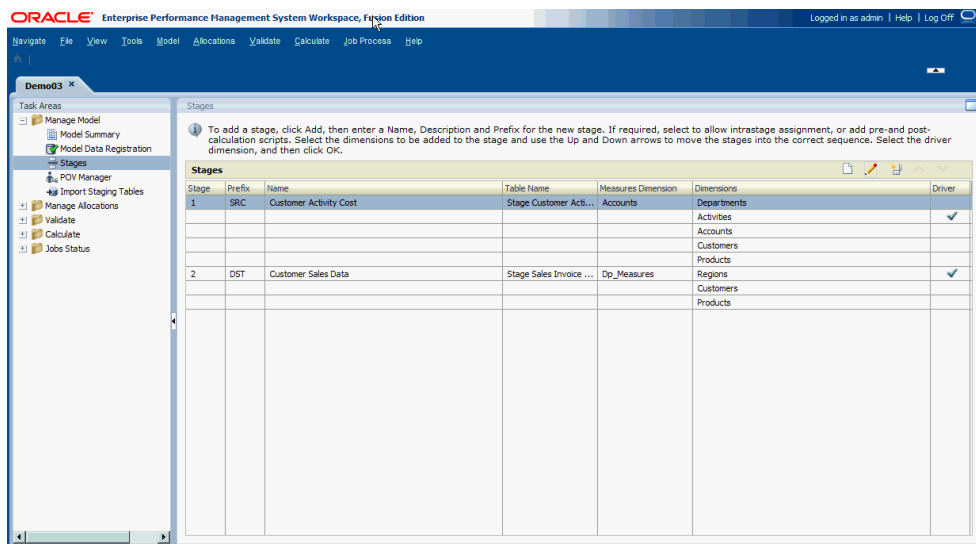

The Stages window provides the following information about the selected stage:

- **Stage** displays the order of the two stages.
- **Prefix** indicates whether the stage is the Source (SRC) or Destination (DST).

- **Name** shows the name of the stage and usually identifies the business function or process of the stage, such as General Ledger or Operating Activities.
 - **Table Name** is the assigned display name for the MDR table.
 - **Measures Dimension** displays the Measures dimension selected for the Stage during Model Data Registration.
 - **Dimensions** shows the dimensions included in the stage.
 - **Driver** dimension for the stage is indicated by a checkmark.
3. Select the stage to be modified, and click **Edit Stage**  .
- The Stage dialog box is displayed.

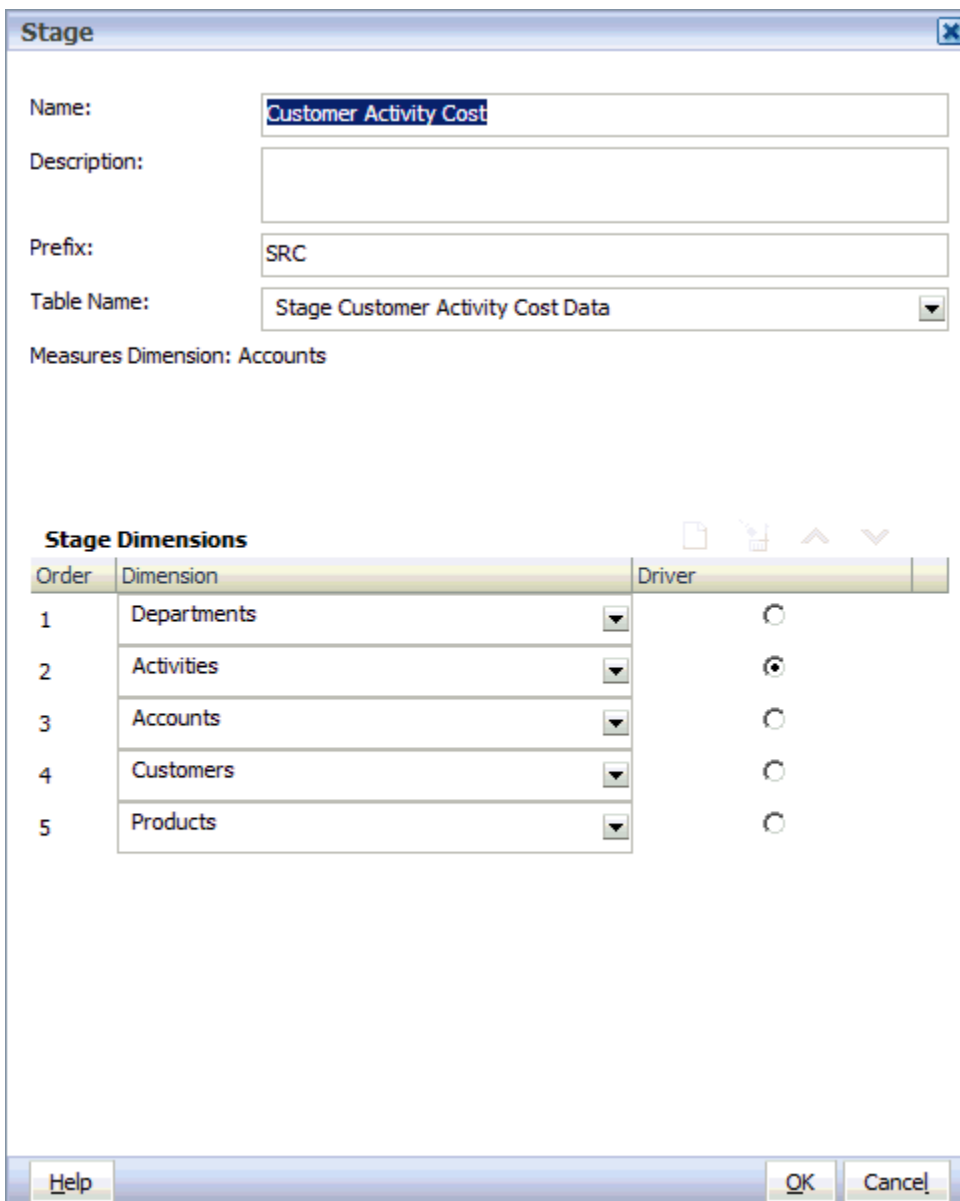

Stage

Name:

Description:

Prefix:

Table Name:

Measures Dimension: Accounts

Stage Dimensions

Order	Dimension	Driver
1	Departments	<input type="radio"/>
2	Activities	<input checked="" type="radio"/>
3	Accounts	<input type="radio"/>
4	Customers	<input type="radio"/>
5	Products	<input type="radio"/>



Buttons: Help, OK, Cancel

4. Modify any or all of these items:

- Name
 - Description
 - Prefix
 - Table Name
5. **Optional:** To add dimensions, under **Stage Dimensions**, click **Add**  to add a new row, and select the dimension to be added to the stage. Repeat to add additional dimensions.

 **Note:**

When adding dimensions for the selected stage, you must also add the defined Source Measures Dimension as one of the dimensions for the Source Stage. Do not include the Destination Measures Dimension in the definition of the Destination stage.

6. **Optional:** Under **Stage Dimensions**, select a Dimension, and click **Delete**  to remove that dimension from the stage. Repeat to remove additional dimensions.
7. **Optional:** Under **Order**, select a dimension to enable the Up  and Down  arrows to move the dimension up or down into the correct sequence. Move all dimensions using the arrows.
8. Under **Driver**, select the dimension which is the driver for the selected stage. The designated driver is indicated with a check mark.
9. Click **OK**.

Deleting Detailed Profitability Model Stages

In Detailed Profitability, the source stage and the destination stage contain different characteristics, requirements and validations, such as the number of dimensions allowed, so they cannot be used interchangeably.



If both stages exist, you cannot delete Stage 1 first because Stage 2 would then become Stage 1, changing it from a destination stage to a source stage which could potentially violate restrictions imposed on source stages.

 **Caution:**

Any driver selections, driver selection exceptions, calculation rules, and assignment rule selections pertaining to the selected stages are also deleted.

After deleting the required stages, you can add new stages as outlined in [Adding Detailed Profitability Model Stages](#).

To delete model stages:

1. From Oracle Hyperion Enterprise Performance Management Workspace, select **Navigate**, then **Applications**, then **Profitability**, and then select the application that you want to view.
2. In an open model, from **Task Areas**, select **Manage Model**, then **Stages**.
3. On the **Stages** screen, select Stage 2 (Destination Stage) to be deleted.
4. Click **Delete stage** .
A message requests that you confirm the deletion.
5. **Optional:** On the **Stages** screen, select Stage 1 (Source Stage) to be deleted.
6. Click **Delete stage** .
A message requests that you confirm the deletion.

Working with Detailed Profitability Points of View

The Point of View (POV) for a model provides a specific view of the model information for a selected time period, such as a year, period, and scenario.

The names and structure of POV dimensions for the organization can be completely customized. The first step for almost every activity in Oracle Hyperion Profitability and Cost Management is the selection of a POV.

At least one POV dimension is required for a model. The user defines the POV dimensions, and the names of those dimensions. Calculations are performed using the specific data, driver selections and assignments of that POV for different months or situations.

A typical POV includes the Year, Period, and Scenario. You must have at least one POV dimension, and you can have up to four. Members for POV dimensions are user-defined, and can provide a rich array of POV combinations for modeling and what-if analysis.

A model can only be edited if the POV is set to "Draft" status. You can modify the POV to reflect new drivers, criteria, or members, enabling you to create alternative scenarios. By comparing these scenarios, you can evaluate how changes affect the processes or bottom line.

You can also create POV versions that enable you to maintain separate versions of the same POV to monitor the impact of changes to the model, or track different versions of the same model.

See these sections for detailed information about POVs:

- [Detailed Profitability POV Dimensions](#)
- [Detailed Profitability POV Status](#)
- [Detailed Profitability Version Dimension](#)
- [Managing Detailed Profitability POVs](#)

Detailed Profitability POV Dimensions

A Point of View (POV) dimension is used to present a specific version or perspective of the model. Each model requires at least one dimension to be designated as a POV dimension. The POV dimensions can be whatever is required for the particular model. The following list represents some common sample POV dimensions:

- Period — Because a model can be based on any unit of time (quarters, months, annual, years, and so on), you can analyze strategies and changes over time, and monitor inventory or depreciation.
- Year — Identifies the calendar year in which the data has been gathered
- Scenario — Identifies a version of the model for a specific time period and set of conditions

Detailed Profitability POV Status

A status must be set for the POV to show the current availability of the model for editing or viewing.

The POV status must be set to one of the following states:

- Draft — Build or edit the model, and generate dynamic reports.
- Published — View the model, and generate dynamic reports. You cannot edit the model.
- Archived — View the model and generate dynamic reports. You cannot edit the model.

Detailed Profitability Version Dimension

Using a specific POV, you can create a POV version that enables you to maintain separate versions of the same POV to monitor the impact of changes to the model, or track different versions of the same model.

Use the Version dimension for the following tasks:

- Create multiple iterations of a model, with slightly different versions
- Model possible outcomes based on assumptions, or "what-if" scenarios to determine best or worst case scenarios
- Facilitate target setting

By modifying different elements within the Version dimension, you can examine results of the changes, without modifying the original model.

Managing Detailed Profitability POVs

A POV displays a particular version of a model for a selected snapshot, such as year, period, scenario, and status.

When a new POV is added, the status is automatically set to "Draft" so the POV can be edited.

At least one POV dimension is required for a model; however, you can create multiple POV combinations for a single model. A selected POV can be saved as an Oracle Hyperion Enterprise Performance Management Workspace user preference. You can also copy a POV, to begin a model for a new reporting period, or a different scenario. See [Copying POVs](#).

The POV dimension defined for the application determines the potential POVs available for a model, but all POVs are not automatically available for assignment or data input. You cannot assign drivers or load data for a POV until it has been added to the model.

The following model elements must be specified for each POV combination:

- Driver selections
- Assignments and Calculation Rules

Use the following procedures to work with POVs:

- [Adding POVs](#)
- [Modifying the POV Status](#)
- [Copying POVs](#)
- [Deleting POVs and All Artifacts](#)
- [Deleting Selected Objects from POVs](#)

Adding POVs

You add a POV to view the information and calculations for a model for a selected snapshot of the model, such as a year, period, scenario and status.

The values of the parameters available for a model are set in the Profitability Applications Console.



Note:

You cannot access a POV from other task windows until the POV has been added in POV Management.

To add POVs:

1. From Oracle Hyperion Enterprise Performance Management Workspace, select **Navigate**, then **Applications**, then **Profitability**, and then select the application that you want to view.
2. In an open model, from `Task Areas`, select **Manage Model**, then **POV Manager**.

The Status tab of the POV Manager screen is displayed. All existing POVs are listed.

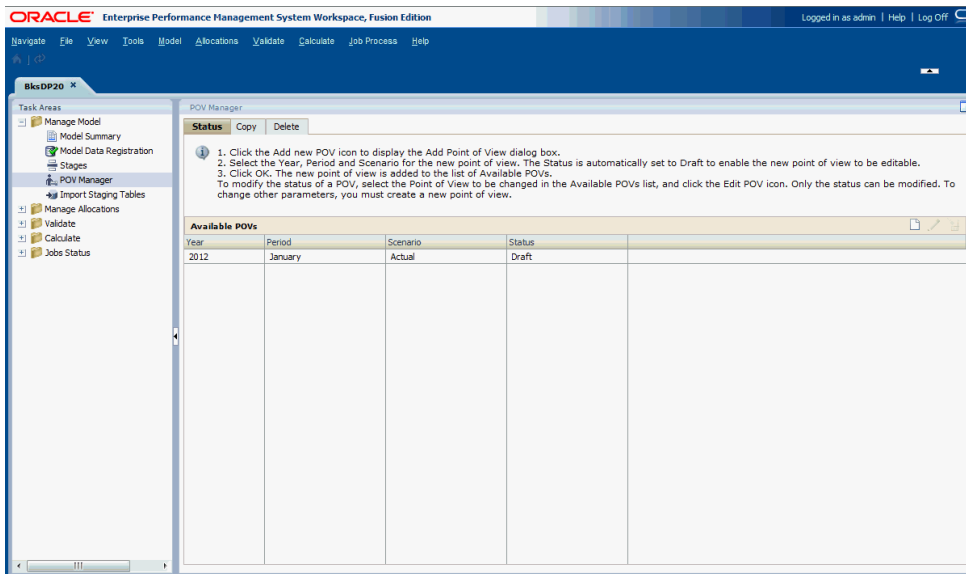

3. Click **Add New POV** .

The Add Point of View dialog box is displayed.

4. Select the parameters in the model to identify the new POV (such as Year, Period or Scenario).

Because this is a new POV, the Status is read-only, and set automatically to Draft to enable you to build and edit the model.

5. Click **OK**.

The POV is added to the list.

Modifying the POV Status

The POV Status displays the availability of the model for editing or viewing. A model is available for editing only when the POV Status is set to Draft. When the model is finalized, change the POV status to ensure it cannot be modified.



Note:

Only the POV status can be changed. To modify any other parameters, you must create a new POV.

The POV status can be set to one of these values:

- Draft — build or edit the model, and generate dynamic reports.
- Published — view the model or generate dynamic reports.
- Archived — view the model or generate dynamic reports.

You can change the status back to Draft at any time, in order to edit the model.



Note:

If you modify the POV, only the status is changed; however you are no longer able to calculate the model if the status has been set to "Published" or "Archived".

To change the POV status:

1. From Oracle Hyperion Enterprise Performance Management Workspace, select **Navigate**, then **Applications**, then **Profitability**, and then select the application that you want to view.
2. In an open model, from **Task Areas**, select **Manage Model**, then **POV Manager**.
The Status tab of the POV Manager screen is displayed. All existing POVs are listed.
3. Select the POV that is to be modified, then click **Edit POV** .
4. Under **Status**, select the new status:
 - Draft
 - Published
 - ArchivedOnly the POV status can be changed. To modify any other parameters, you must create a new POV.
5. Click **OK**.

Copying POVs

You can copy a POV to provide a starting point for a new model or scenario, or to play what-if scenarios with an existing model.

For example, you can begin a period by copying driver selections and assignments from the previous period, or you can create seed data for a forecast scenario by copying data from an actual scenario.

To copy the POV, you must have a Source POV, which contains the information to be copied, and a Target POV, which is destination to which the data will be copied. You can copy

information only to POVs with the status of "Draft" that are listed on the Status tab of the Manage POVs screen.

To copy POVs:

1. **Optional:** If required, create a POV on the Status tab of POV Management to provide the target POV for the copy operation. See [Adding POVs](#).
2. In an open model, from **Task Areas**, select **Manage Model**, then **POV Manager**.
The Status tab of the POV Manager window is displayed. All existing POVs are listed.
3. From POV Manager, select the **Copy** tab.

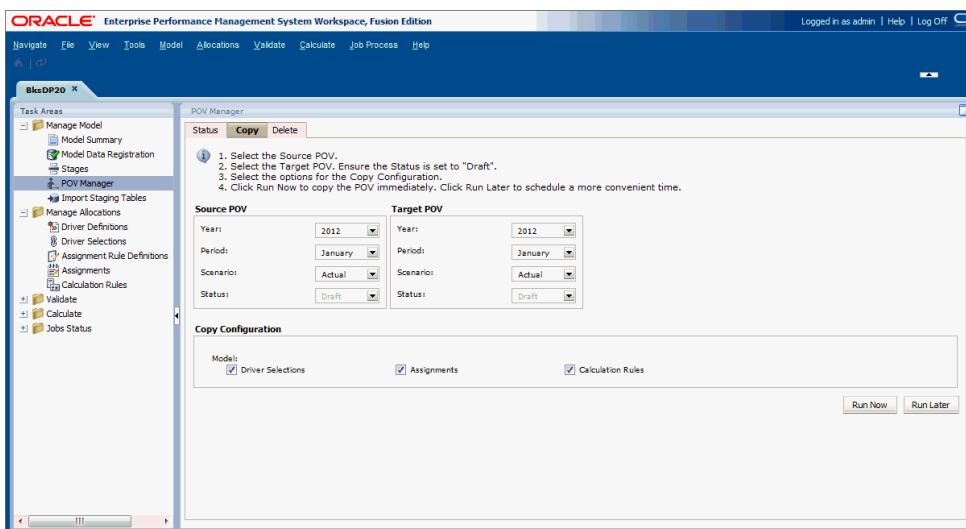

4. Under **Source POV**, select the POV that is to be copied.

Note:

The Status for the Source is automatically set to the status assigned to this POV, and cannot be modified on this screen.

5. Under **Target POV**, select the POV that is to be the destination for the copied POV.

Caution:

The Target POV must exist as a valid POV with the Status of "Draft" on the Status tab of the POV Manager screen, or the copy operation will not start.

6. Under **Copy Configuration**, select the elements of the POV that are to be copied:

Under **Model**, select **Driver Selections**, **Assignments**, **Calculation Rules**, or all. These options enable you to control the information that is required for the new POV.

7. Perform one of the following tasks:
 - Click **Run Later** to schedule a date and time to copy the POV.

 **Note:**

If this option is not selected when the task is created, you will not be able to schedule the task.

- Click **Run Now** to copy the POV immediately.
A confirmation message indicates that the job has started and identifies the assigned taskflow ID. Select **Jobs Status**, and then **Search Task** to monitor the status. See [Job Library](#).

 **Caution:**

Depending on the size and complexity of the model, this operation may take a significant amount of time.

8. When the copy is complete, review the copied information under the target POV.

Deleting POVs and All Artifacts

You can delete an entire POV from the Status tab on the POV Manager screen. When a POV is deleted, all objects within that POV are deleted, including the associated assignments and driver selections.

If you only want to delete selected objects from a POV, without deleting the entire POV, see [Deleting Selected Objects from POVs](#).

 **Caution:**

Oracle recommends that, before deleting a POV, you create a backup directory of the databases in Oracle Hyperion Enterprise Performance Management Workspace. Contact the administrator for assistance, if required.

To delete POVs and their associated assignments and driver selections:

1. Ensure that no other users require the POV and its contents.
2. From EPM Workspace, select **Navigate**, then **Applications**, then **Profitability**, and then select the application that you want to view.
3. In an open model, from **Task Areas**, select **Manage Model**, then **POV Manager**.
The POV Manager screen is displayed.
4. Select the **Status** tab.

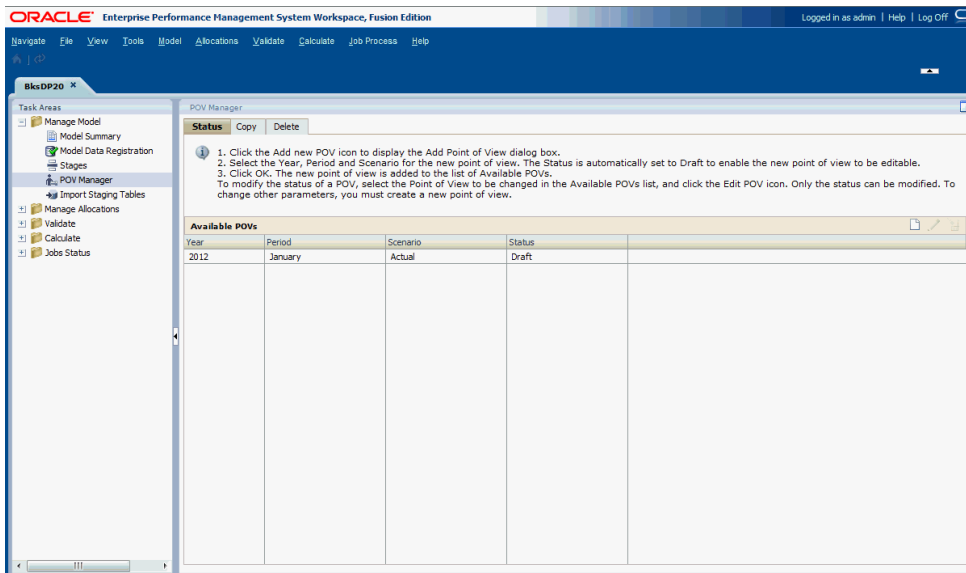

5. Under **Available POVs**, select the POV you want to delete.

6. Click **Delete POV** 

A confirmation message is displayed.

Caution:

When a POV is deleted, all objects within that POV are deleted.

7. Click **Yes** to confirm the deletion.

The POV is removed from the list and is no longer available for selection.

Deleting Selected Objects from POVs

Using the Delete tab of the POV Manager screen, you can delete selected objects from a POV, without deleting the entire POV.

To delete an entire POV, including its associated assignments and driver selections, see [Deleting POVs and All Artifacts](#).

Caution:

Oracle recommends that, before deleting a POV, you create a backup directory of the databases in Oracle Hyperion Enterprise Performance Management Workspace. Contact the administrator for assistance, if required.

To delete selected objects from a POV:

1. Ensure that no other users require the POV and its contents.
2. From EPM Workspace, select **Navigate**, then **Applications**, then **Profitability**, and then select the application that you want to view.
3. In an open model, from **Task Areas**, select **Manage Model**, then **POV Manager**.
The POV Manager screen is displayed.
4. Select the **Delete** tab.

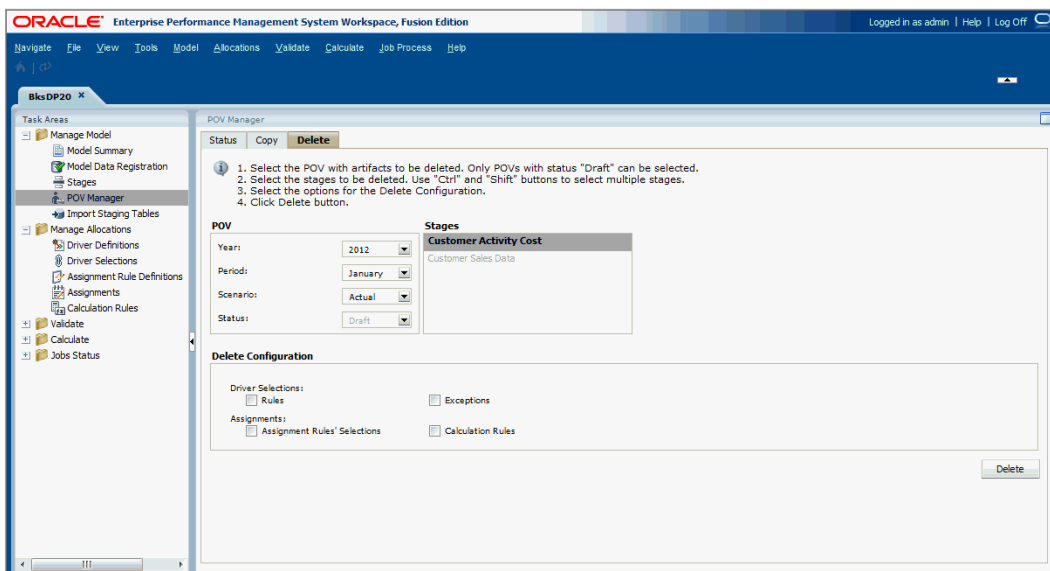

5. Under **POV**, select the POV that contains the artifacts that you want to delete.
6. Under **Stages**, select the stage that contains the artifacts to be deleted.
7. Under **Delete Configuration**, select the elements of the configuration that are to be deleted:
 - **Driver Selections** (Rules or Exceptions or both)
 - **Assignments** (Assignment Rules Selections or Calculation Rules or both).
8. Click **Delete**.
A confirmation message is displayed.
9. Click **OK** to confirm the deletion.

The selected records are removed. See `hpcm.log` to view a record of the operation, including the selections and the number of records expunged.

Importing Detailed Profitability Staging Tables

You can enter data and model information directly into Oracle Hyperion Profitability and Cost Management; however, the data entry may be very time-consuming.

To facilitate the population of the application, you can import model definitions, such as POVs, drivers, driver selections, assignment rule selections, and calculation rules, directly into Profitability and Cost Management using a set of import staging tables and import configurations.

 **Note:**

Dimensions, costs and driver data cannot be imported from staging tables.

Model data is imported from several sources:

- Model structure and metadata (measures and dimensions) are imported from the Profitability Applications Console through Oracle Hyperion Enterprise Performance Management Workspace.
- Model definition data is imported from staging tables.
- Model data and applications can be imported using Oracle Hyperion Enterprise Performance Management System Lifecycle Management. See the *Oracle Hyperion Enterprise Performance Management System Lifecycle Management Guide*.
- Model data is imported using Oracle Enterprise Performance Management System

 **Caution:**

Oracle recommends that, before importing data or artifacts, you create a backup directory of the databases in EPM Workspace. Contact the administrator for assistance.

In order to import staging tables, you must create an import configuration to specify which tables are to be imported. The configuration, which can be saved, can be used multiple times to import the same set of data. When importing the complete model, there are table dependencies that apply; however, these dependencies are not applicable if you are only importing sections of the model

For detailed instructions on creating staging tables and import configurations, see the *Oracle Hyperion Profitability and Cost Management Administrator's Guide*.

Managing Detailed Profitability Allocations

Related Topics

- [About Detailed Profitability Allocations](#)
In Detailed Oracle Hyperion Profitability and Cost Management, allocations control how values are distributed throughout the model to specified accounts or elements.
- [Defining Drivers and Formulas for Detailed Profitability](#)
Drivers are used to control allocations between objects in a Detailed Oracle Hyperion Profitability and Cost Management model.
- [Working with Detailed Profitability Drivers](#)
After a driver is created, it must be associated with the dimension members to which it applies.
- [Working with the Bulk Editor](#)
Use the Bulk Editor on the Driver Selections, Exceptions or Assignment screen to create multiple driver selections and assignments quickly and efficiently, without having to create each driver selection and assignment individually.
- [Working with Detailed Profitability Assignment Rules](#)
Assignment rules define the sources and their destinations for the allocations or calculations that are posted.
- [Working with Assignments in Detailed Profitability](#)
Assignments define the flow of data from the source to the destination.

About Detailed Profitability Allocations

In Detailed Oracle Hyperion Profitability and Cost Management, allocations control how values are distributed throughout the model to specified accounts or elements.

A driver is used to determine how the funds for each allocation are calculated. The calculated results are assigned from the source to the destination, as the funds flow through the model.

See these sections for information about managing allocations:

- [Defining Drivers and Formulas for Detailed Profitability](#)
- [Defining Detailed Profitability Drivers](#)
- [Working with Detailed Profitability Drivers](#)
- [Working with the Bulk Editor](#)
- [Working with Detailed Profitability Assignment Rules](#)
- [Working with Assignments in Detailed Profitability](#)
- [Working With Calculation Rules](#)

Defining Drivers and Formulas for Detailed Profitability

Drivers are used to control allocations between objects in a Detailed Oracle Hyperion Profitability and Cost Management model.

Drivers work with Assignments, source data, and driver data to build a complete set of instructions and data to control system calculations.

While assignments direct the data from a source to a destination, the drivers that are associated with these assignments are used to calculate the value of the allocations. The drivers provide the formulas for allocating source values to destinations. Driver measures and formulas promote model flexibility by enabling you to use variables to represent model elements, and mathematical operands to calculate driver values. Drivers are not directly associated with stages.



Note:

If a driver used in the allocation is modified or deleted, you must recalculate the model.

For each driver required in the model, perform these tasks:

- Determine which types of drivers you require for the application. Driver Operation Type defines the type of the driver as rate-base, ratio-based, or as calculated measure. See [Defining Detailed Profitability Drivers](#).
- Generate driver formulas based on SQL-syntax. See [Driver Formulas](#).
- If you want to run drivers in a specific sequence, see [Driver Priority Sequence](#).
- Define the new driver and the associated formula. See [Defining Detailed Profitability Drivers](#).
- Associate the driver with the selected measure. See [Working with Detailed Profitability Drivers](#).

Driver Formulas

A driver formula can include any combination of variables, functions, and numeric values that are used to calculate the results that will be posted to the Destination. Formulas must be mathematically and syntactically correct according to SQL syntax; furthermore, the measures used must have been registered properly in Model Data Registration as they are validated based on those criteria.

Each driver type contains a driver formula that is created on the Driver Definition dialog box, using the keyboard and the Insert button. The formula created to calculate the driver value may be simple, or it may be a complex formula that includes conditional statements.

On the Define Driver dialog box, use the keyboard and Insert button to build the SQL formula to calculate the values.

The insert button supports adding either source measures or destination measures to the driver formula. The driver formula may be as simple as `=destination.headcount`,

or it may be a complex combination of source and destination measures, mathematical, and other functions supported by SQL.

You can use functions (operands) between elements to control the formula calculation, including simple operands such as the following examples:

- Add (+)
- Subtract (-)
- Multiply (*)
- Divide (/)

As an example, the Calculation formula for a Calculated Measure operation type may be written as follows:

```
(Destination."MATERIALS_EXPENSE"+Destination."SALES_EXPENSE"+Destination."SERVICE_EXPENSE"  
+Destination."GENERAL_ADMIN_EXPENSE"+Destination."SHIPPING_EXPENSE")
```

Refer to MS SQL documentation for specific commands and instructions.

Driver Priority Sequence

In some business models, a driver may use one or more calculated measures in the formula. Dependencies may require the allocations to be calculated in a controlled sequence. Priority sequence drivers enable you to define which allocations should be calculated first.

For example, by setting the driver priority, you ensure that Source A using Driver A is calculated before Source A using Driver B.

When defining the driver, enter the Sequence Priority on the Define Drivers dialog box. The source associated with drivers that have a lower priority are resolved before a source associated with a driver that has a higher priority. The default value is set to 100, but this value can be changed. The highest priority is 1. The sequence priority must be entered as a positive integer. Sources associated with drivers that have the same sequence priority are processed in no defined order.

If you change the sequence priority for a driver, you are potentially changing the calculation order, so you should recalculate the model.

Defining Detailed Profitability Drivers

For detailed instructions on working with drivers, see these procedures:

- [Working with Ratio-Based Drivers](#)
- [Working with Rate-Based Drivers](#)
- [Working with Calculated Measure Drivers](#)

Working with Ratio-Based Drivers

The ratio-based drivers enable you to perform allocations from the source to the destination stage using the following formula:

$$\text{Driver Value} / \text{Sum of Driver Values ratio}$$

The result of the driver formula is calculated for each source/destination combination, and allocated the source value to the destination as a ratio.

See the following procedures:

- [Defining Ratio-Based Drivers](#)
- [Modifying Ratio-Based Drivers](#)
- [Deleting Ratio-Based Drivers](#)

Defining Ratio-Based Drivers

To define ratio-based drivers:

1. From Oracle Hyperion Enterprise Performance Management Workspace, select **Navigate**, then **Applications**, then **Profitability**, and then select the application for which you want to create the driver.
2. From **Task Areas**, select **Manage Allocations**, and then **Driver Definitions**.

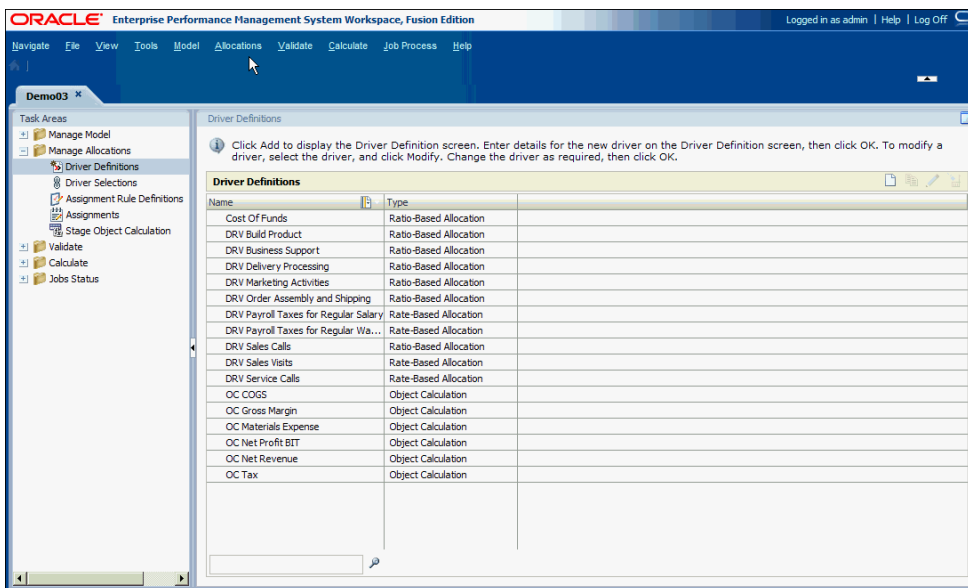

3. In **Driver Definitions**, click **Add New Driver** .

4. Under **Operation Type**, select **Ratio-Based Allocation**.
5. In **Name**, enter a unique name for the new driver.

Caution:

Do not use special or restricted characters in the driver name, such as /, +, or @ signs, because doing so may cause import operations to fail. See the *Oracle Essbase Database Administrator's Guide* to view the latest restrictions.

6. **Optional:** In **Description**, enter a brief description of the purpose of the driver.
7. In **Sequence Priority**, enter the calculation priority as a positive integer. By default, 100 is displayed. The highest priority is 1. For more information, see [Driver Priority Sequence](#).
8. Under **Assign to Destination Measure**, click the Browse button  to select the Destination measure to which the driver will write the allocated values, and then click **OK**.
9. Under **Define Driver Value**, enter the driver formula equation to determine the value of the Driver Value when the driver is executed.

You can build the formula using both the keyboard and the Insert button. The formula requires a source and destination combination. The driver formula may be as simple as =destination.headcount, or may be a complex combination of source and destination measures, mathematical and other functions supported by SQL.

To use the Insert Selector:

- a. Click **Insert** to display the Insert selector for the available measures for the driver.
- b. From the drop-down list, select the stage within the model to which the measures apply: **Source** or **Destination**.

The list of Available Measures changes to reflect the choice. For example, if you selected Source, only source measures are displayed.

- c. From the dimension members list, select the measure for the formula.

Use the Context Menu  to filter or modify the display of members.

 **Note:**

Filter and sort are available only when Grid View is selected.

- d. Click **OK**.
10. After entering the formula, click **Validate**.
The SQL driver formula is validated, and a success message is displayed.
Address any errors before proceeding.
11. **Optional:** Under **Options**, select **Allow Idle** to enable this driver to accept idle values.
If this option is selected, and the system detects an Override on the source, that value is used as the ratio denominator.
12. **Optional:** If **Allow Idle** is selected, under **Override Total Driver Value Measure**, click **Browse**  to select the measure that will be used as the ratio denominator if an Override is detected on the source.
13. Click **OK** to save the new driver.
14. Associate the driver with one or more dimension members. See [Working with Detailed Profitability Drivers](#).

Modifying Ratio-Based Drivers

To modify ratio-based drivers:

1. From Oracle Hyperion Enterprise Performance Management Workspace, select **Navigate**, then **Applications**, then **Profitability**, and then select the application for which you want to modify the driver.
2. From **Task Areas**, select **Manage Allocations**, and then **Driver Definitions**.
3. Click **Edit Driver** .
4. In **Define Driver**, modify any of the following parameters for the selected driver:
 - Name
 - Description
 - Operation Type
 - Sequence Priority
 - Assign to Destination Measure

▲ Caution:

Do not use special or restricted characters in the driver name, such as /, +, or @ signs, because doing so may cause import operations to fail. See the *Oracle Essbase Database Administrator's Guide* to view the latest restrictions.

5. **Optional:** Under **Define Driver Value**, modify the driver formula equation, and then click **Validate**.

The SQL driver formula is validated, and a success message is displayed. Address any errors before proceeding.

6. **Optional:** Under **Options**, modify the **Allow Idle** selection, and the **Override Total Driver Value Measure**.

7. Click **OK** to save the modified driver.

If you want the modified driver to be applied to the calculated results, you must recalculate the model.

Deleting Ratio-Based Drivers

▲ Caution:

If a driver is deleted, all driver selections and multi source assignment calculation rules that used the deleted driver are also removed.

To delete ratio-based drivers:

1. From Oracle Hyperion Enterprise Performance Management Workspace, select **Navigate**, then **Applications**, then **Profitability**, and then select the application that contains the driver to be deleted.
2. From **Task Areas**, select **Manage Allocations**, and then **Driver Definitions**.
3. Select the driver that you want to delete.
4. Click **Delete driver** .
5. In the confirmation message, click **Yes** to delete the driver.

Working with Rate-Based Drivers

The rate-based driver type calculates both a unit rate and a volume driver from the source to the destination, and allocates the results to the destination in the measure designated in the driver definition, using the following formula:

$$\text{Driver Unit Rate (Currency)} * \text{Volume Parameter}$$

The results are used for balancing and determining unassigned values. If the sum of the allocated values is greater than the input value of the source, the difference is captured in a measure for the overdriven amount.

See the following procedures:

- Defining Rate-Based Drivers
- Modifying Rate-Based Drivers
- Deleting Rate-Based Drivers

Defining Rate-Based Drivers

To define rate-based drivers:

1. From Oracle Hyperion Enterprise Performance Management Workspace, select **Navigate**, then **Applications**, then **Profitability**, and then select the application for which you want to create the driver.
2. From **Task Areas**, select **Manage Allocations**, and then **Driver Definitions**.

The Driver Definitions window is displayed.

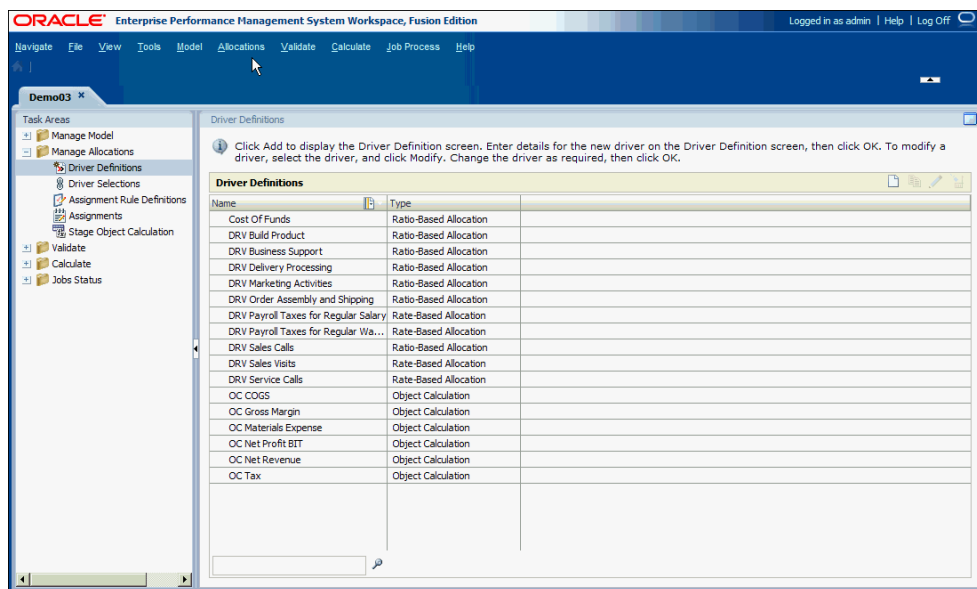

3. In **Driver Definitions**, click **Add New Driver** .

The Define Driver dialog box is displayed.

4. For **Operation Type**, select **Rate-Based Allocation**.
5. For **Name**, enter a unique name for the new driver.

Caution:

Do not use special or restricted characters in the driver name, such as /, +, or @ signs, because doing so may cause import operations to fail. See the *Oracle Essbase Database Administrator's Guide* to view the latest restrictions.

6. **Optional:** In **Description**, enter a brief description of the purpose of the driver.
7. In **Sequence Priority**, enter the calculation priority as a positive integer. By default, 100 is displayed. The highest priority is 1. For more information, see [Driver Priority Sequence](#).
8. Under **Assign to Destination Member**, click the Browse button  to select the Destination measure to which the driver will write the allocated values, and then click **OK**.

Note:

If Lookup measures is selected for Assign to Destination Measure, then appropriate validation error will appear on Drivers tab in Model Validation.

9. Under **Define Rate**, enter the rate to be applied in the formula ($\text{Rate} * \text{Volume}$).

You can enter the actual rate, or you can create a formula using both the keyboard and the Insert button.

To use the Insert Selector:

- a. Click **Insert** to display the Insert selector for the available measures for the driver.

- b. From the drop-down list, select the stage within the model to which the measures apply: **Source** or **Destination**.

The list of Available Measures changes to reflect the choice made from the location list. For example, if Source is selected, only source measures are displayed.

- c. From the dimension members list, select the measure for the formula.

Use the Context Menu  to filter or modify the display of members.

 **Note:**

Filter and sort are available only when Grid View is selected.

- d. Click **OK**.

- 10. Enter the formula, and then click **Validate**.

The SQL driver formula is validated, and a success message is displayed. Address errors before proceeding.

- 11. Under **Define Volume**, enter the volume to be applied in the formula (Rate * Volume).

You may enter a specific volume, or you can create a formula using both the keyboard and the Insert button.

To use the Insert Selector:

- a. Click **Insert** to display the Insert selector for the available measures for the driver.
- b. From the list, select the stage within the model to which the measures apply: **Source** or **Destination**.

The list of Available Measures changes to reflect the choice made from the location drop-down list. For example, if Source is selected, only source measures are displayed.

- c. From the dimension members list, select the measure for the formula.

Use the Context Menu  to filter or modify the display of members.

 **Note:**

Filter and sort are available only when Grid View is selected.

- d. Click **OK**.

- 12. Enter the formula, and then click **Validate**.

The SQL driver formula is validated, and a success message is displayed. Address any errors before proceeding.

- 13. Click **OK** to save the new driver.

- 14. Associate the driver with one or more dimension members. See [Working with Detailed Profitability Drivers](#).

Modifying Rate-Based Drivers

To modify rate-based drivers:

1. From Oracle Hyperion Enterprise Performance Management Workspace, select **Navigate**, then **Applications**, then **Profitability**, and then select the application for which you want to modify the driver.
2. From **Task Areas**, select **Manage Allocations**, and then **Driver Definitions**.
3. Click **Edit Driver** .
4. Modify any of the following parameters for the selected driver:
 - Name
 - Description
 - Operation Type
 - Sequence Priority
 - Assign to Destination Member

Caution:

Do not use special or restricted characters in the driver name, such as /,+, or @ signs, because doing so may cause import operations to fail. See the *Oracle Essbase Database Administrator's Guide* to view the latest restrictions.

5. **Optional:** Under **Define Rate**, modify the rate for the formula, and then click **Validate**.
The SQL driver formula is validated, and a success message is displayed. Address any errors before proceeding.
6. **Optional:** Under **Define Volume**, modify the volume for the formula, and then click **Validate**.
The SQL driver formula is validated, and a successful message is displayed. Any errors must be addressed before proceeding.
7. Click **OK** to save the modified driver.
If you want the modified driver to be applied to the calculated results, you must recalculate the model.

Deleting Rate-Based Drivers

Caution:

If a driver is deleted, all driver selections that used the deleted driver are also removed.

To delete rate-based drivers:

1. From Oracle Hyperion Enterprise Performance Management Workspace, select **Navigate**, then **Applications**, then **Profitability**, and then select the application that contains the driver to be deleted.
2. From **Task Areas**, select **Manage Allocations**, and then **Driver Definitions**.
3. In **Driver Definitions**, select the driver that you want to delete.
4. Click **Delete** .
5. In the confirmation message, click **Yes** to delete the driver.

Working with Calculated Measure Drivers

The calculated measure drivers are custom mathematical calculations that can be applied to calculate values that do not require a source/destination context. The calculated results can be used as a driver value.

Calculated measure drivers deal with the Destination stage only, so you must designate a destination. Based on the driver definition, the values specified in the custom driver formula are posted to the destination in the measure specified within the driver definition.

For example, you can create a custom formula to calculate some of the following sample tasks:

- Compute the time value of money where all of the parameters exist on the destination object, such as an invoice amount, average days to pay, interest rate, and so on.
- Compute the extended cost for an invoice line where the unit cost and volume exist on the destination.
- Compute the standard cost of goods where the unit cost and volume exist on the destination.

See the following procedures:

- [Defining Calculated Measure Drivers](#)
- [Modifying Calculated Measure Drivers](#)
- [Deleting Calculated Measure Drivers](#)

Defining Calculated Measure Drivers

To define calculated measure drivers:

1. From Oracle Hyperion Enterprise Performance Management Workspace, select **Navigate**, then **Applications**, then **Profitability**, and then select the application for which you want to create the driver.
2. From **Task Areas**, select **Manage Allocations**, and then **Driver Definitions**.
3. In **Driver Definitions**, click the Add New Driver button.
4. In **Name**, enter a unique name for the new driver.

 **Caution:**

Do not use special or restricted characters in the driver name, such as /, +, or @ signs, because doing so may cause import operations to fail. See the *Oracle Essbase Database Administrator's Guide* to view the latest restrictions.

5. **Optional:** In **Description**, enter a brief description of the purpose of the driver.
6. Under **Write Result to Destination Measure**, click the Browse button to select the Destination measure to which the driver will write the allocated values, and then click **OK**.
7. In **Define Driver**, under **Operation Type**, select **Calculated Measure**.
8. In **Sequence Priority**, enter the calculation priority as a positive integer. By default, 100 is displayed. The highest priority is 1.
9. Under **Calculation Formula**, enter the custom driver formula equation.
You can build the formula using both the keyboard and the Insert button.
To use the Insert Selector:
 - a. Click **Insert** to display the Insert selector for the available measures for the driver.
 - b. From the list, select **Destination** to display available Destination measures.
 - c. From the dimension list, select the measure for the formula.
 - d. Click **OK**.
10. After entering the formula, click **Validate**.
The SQL driver formula is validated, and a success message is displayed. Address any errors before proceeding.
11. Click **OK** to save the new driver.

Modifying Calculated Measure Drivers

To modify calculated measure drivers:

1. From Oracle Hyperion Enterprise Performance Management Workspace, select **Navigate**, then **Applications**, then **Profitability**, and then select the application for which you want to modify the driver.
2. From **Task Areas**, select **Manage Allocations**, and then **Driver Definitions**.
3. In Driver Definitions, click the Edit Driver button.
The Define Driver dialog box for the selected driver is displayed.
4. On **Define Driver**, modify any of the following parameters for the selected driver:
 - Name
 - Description
 - Operation Type
 - Sequence Priority
 - Write Result to Destination Measure

▲ Caution:

Do not use special or restricted characters in the driver name, such as /, +, or @ signs, because doing so may cause import operations to fail. See the *Oracle Essbase Database Administrator's Guide* to view the latest restrictions.

5. **Optional:** Under **Calculation Formula**, modify the custom formula, and then click **Validate**.

The SQL driver formula is validated, and a success message is displayed. Address any errors before proceeding.

6. Click **OK** to save the modified driver.

If you want the modified driver to be applied to the calculated results, you must recalculate the model.

Deleting Calculated Measure Drivers

▲ Caution:

If a driver is deleted, all stage calculated measures that used the deleted driver are also removed.

To delete calculated measure drivers:

1. From Oracle Hyperion Enterprise Performance Management Workspace, select **Navigate**, then **Applications**, then **Profitability**, and then select the application that contains the driver to be deleted.
2. From **Task Areas**, select **Manage Allocations**, and then **Driver Definitions**.
3. In Driver Definitions, Select the driver that you want to delete.
4. Click the Delete button.
5. Click **Yes** to confirm deletion of the driver.

Working with Detailed Profitability Drivers

After a driver is created, it must be associated with the dimension members to which it applies.

A maximum of five dimensions are available for the Source stage.

Drivers must be associated with an intersection that contains a value in order for the value to be allocated. If a driver has not been assigned to an intersection that contains assignments or assignment rules, a "Missing Driver Assignments" error is created during model validation.

- [Selecting Detailed Profitability Drivers](#)
- [Creating Detailed Profitability Driver Selections for a Single Intersection](#)

- [Deleting Detailed Profitability Driver Selections](#)
- [Deleting Detailed Profitability Driver Selections for One Intersection](#)
- [Adding a Single Driver to Multiple Source Stage Rules](#)
- [Removing Drivers from Multiple Source Stage Rules](#)

Creating Duplicate Drivers

Using the Create Duplicate Driver option, you can copy an existing driver definition, and assign the driver a new name. The copy can be modified as required, as outlined for the driver type.

This option enables you to rapidly create many similar drivers without having to reopen the Driver Definition dialog box.

To create new drivers from existing driver definitions:

1. From Oracle Hyperion Enterprise Performance Management Workspace, select **Navigate**, then **Applications**, then **Profitability**, and then select the application for which you want to create the driver.
2. From **Task Areas**, select **Manage Allocations**, and then **Driver Definitions**.
3. Select the driver that you want to use as the template for the new driver definition.
You can select any driver type.
4. Click **Create Duplicate Driver** 

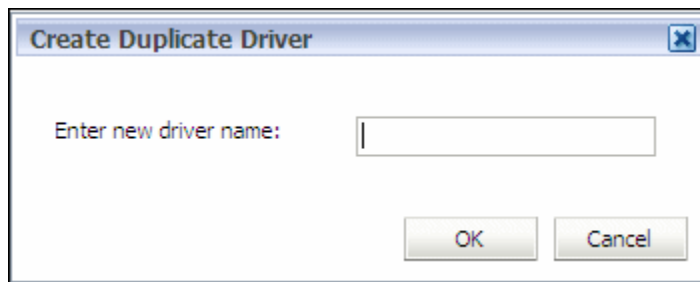

5. Enter the name of the new driver, and then click **OK**.

The new driver is added to the list of Driver Definitions, and the type and information for the driver are the same as the original driver.

Caution:

Do not use special or restricted characters in the driver name, such as */*, *+*, or *@* signs, because doing so may cause import operations to fail. See the *Oracle Essbase Database Administrator's Guide* to view the latest restrictions.



6. Modify the driver as required.

Selecting Detailed Profitability Drivers

To associate drivers:

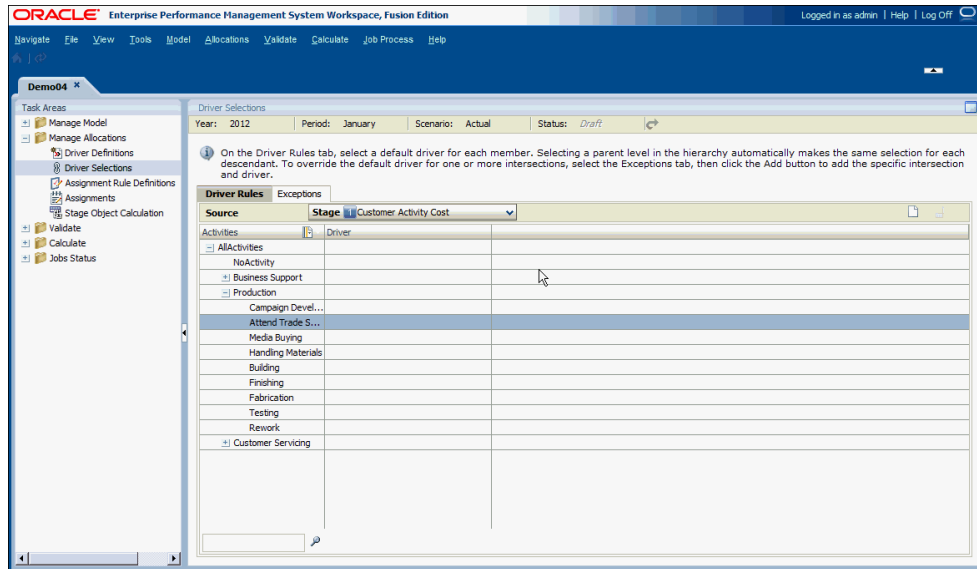
1. From Oracle Hyperion Enterprise Performance Management Workspace, select **Navigate**, then **Applications**, then **Profitability**, and then select the application that you want to view.
2. In an open model, from **Task Areas**, select **Manage Allocations**, then **Driver Selections**.



3. Select a POV, and then click **Load the POV status** .
4. On the **Driver Rules** tab, under **Source**, view the selected Source stage.
The driver dimension of the selected stage is displayed in the first column, and all dimension members within that driver dimension are listed below.
5. Under the dimension, select the dimension member to which you want to apply the default driver. The parent level may be at the top of the stage, or a parent for a portion of the hierarchy.
6. Under **Driver**, double-click the cell to display **Selector** , or click **Add**  to select a driver for the dimension member from the Common Member Selector, and then click **OK**. See [Using the Common Member Selector](#).

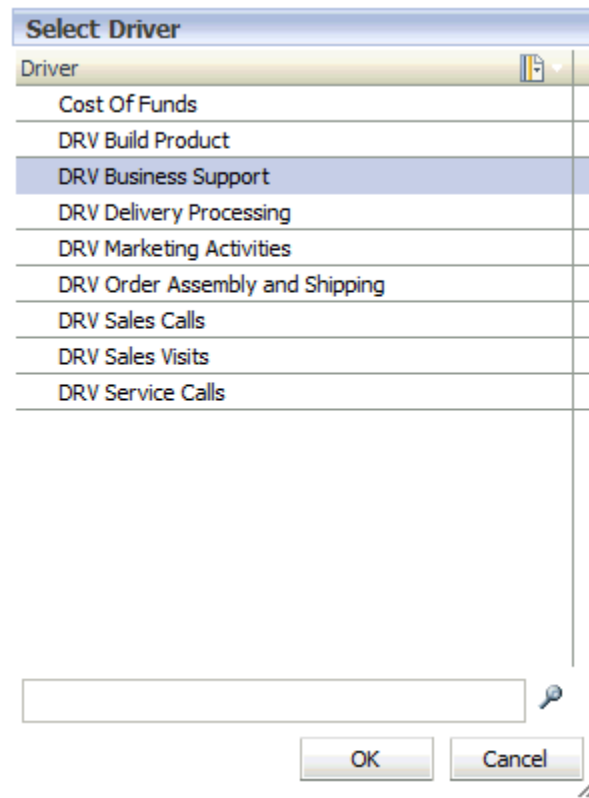

When the driver is applied to a parent, the same driver is automatically inherited by all descendants.

7. **Optional:** To select a driver other than the inherited driver for one member, perform the following steps:
 - a. Expand the parent dimension member.
 - b. Select the member that requires a different driver.
 - c. Under **Driver**, double-click the cell to display **Selector**  or click **Add** to select an alternative driver for selected dimension member from the Common Member Selector, and then click **OK**. See [Using the Common Member Selector](#).

The driver selection is automatically saved.

8. **Optional:** To set a driver for a single intersection, see [Creating Detailed Profitability Driver Selections for a Single Intersection](#).



Creating Detailed Profitability Driver Selections for a Single Intersection

To select a driver for a single intersection:

1. From Oracle Hyperion Enterprise Performance Management Workspace, select **Navigate**, then **Applications**, then **Profitability**, and then select the application that you want to view.
2. In an open model, from **Task Areas**, select **Manage Allocations**, and then **Driver Selections**.
3. Select the POV, then click **Go** .

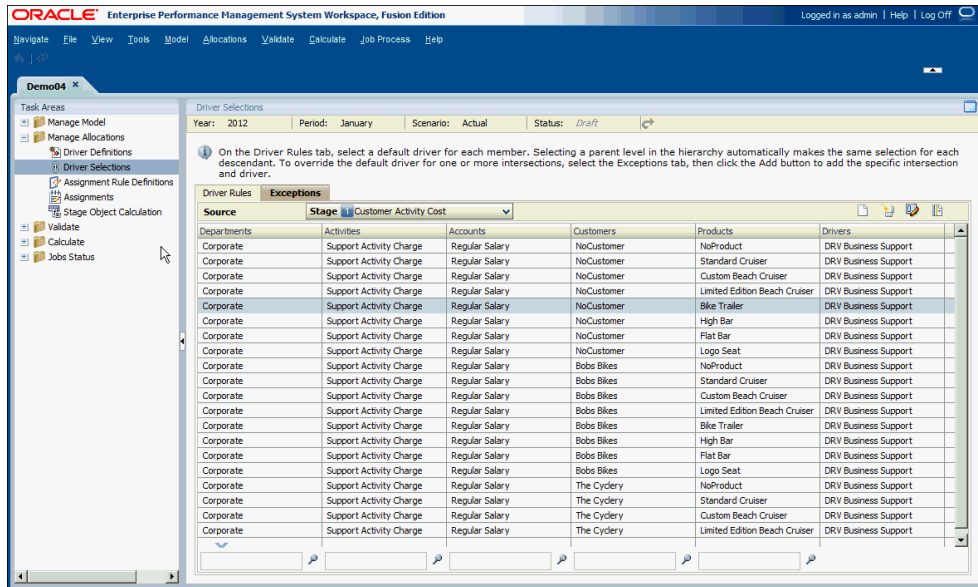
4. Select the **Exceptions** tab.
Under Source, the source stage is displayed.



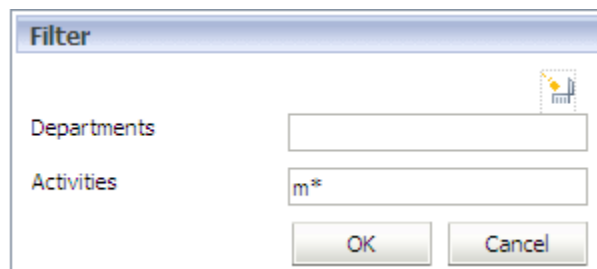

5. **Optional:** On the **Exceptions** tab, click Grid Options  to filter the list of available driver exceptions:
 - a. Select **Show Alias** or **Show Name**, as required.
 - b. Click **Filter**  to display the Filter dialog box.
 - c. Enter the filter criteria for one or more dimensions.

Enter the exact name or alias of the required members, or use a trailing asterisk (*) as a wild card to select a range of members, or a trailing question mark (?) to select a single character. For example, to find all members of a dimension that begins with the letter "M", enter "M*". Entering the asterisk before the letter does not work, for example "*M."

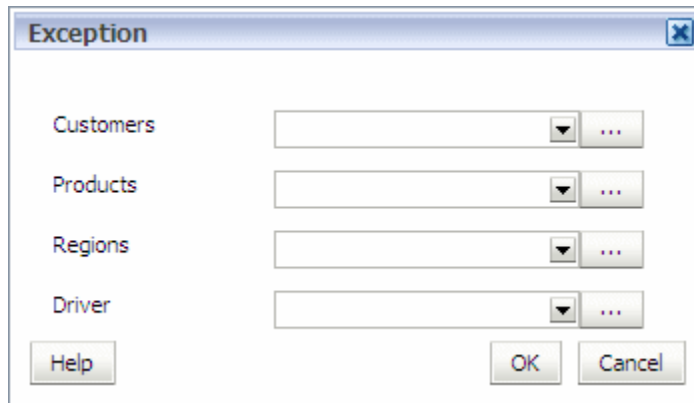

- d. Click **OK**.
Only the items that meet the filter criteria are displayed on the Exceptions tab.
6. Click **Add new driver exception** .





7. For each dimension listed on the Exception dialog box, click the **Selector**  and select the members for the specific intersection to which you need to apply the exception driver. See [Using the Common Member Selector](#).
8. Under **Drivers**, select the exception driver for the intersection.
9. Click **OK**.

Deleting Detailed Profitability Driver Selections

If a driver selection is deleted, and no new driver is selected, an error is reported during validation to indicate that an assignment does not have a driver selection.

To delete driver selections:

1. From Oracle Hyperion Enterprise Performance Management Workspace, select **Navigate**, then **Applications**, then **Profitability**, and then select the application that you want to view.
2. In an open model, from *Task Areas*, select **Manage Allocations**, then **Driver Selections**.
3. Select a POV, and then click **Go** .

On the **Driver Rules** tab, under **Source**, the source stage is selected.
4. Select the row containing the driver selection to be deleted.
5. Click **Delete driver rule** .
6. Click **Yes** to confirm the deletion of the driver.



Deleting Detailed Profitability Driver Selections for One Intersection

Select the intersection that is to be deleted. The entire intersection is removed from the Exception tab.

If a driver selection is deleted, and no new driver is selected, an error is reported during validation to indicate that an assignment does not have a driver selection.

To delete driver selections for one intersection:

1. In an open model, from *Task Areas*, select **Manage Allocations**, then **Driver Selections**.

2. Select a POV, and then click **Go** .
3. Select the **Exceptions** tab.
Under Source, the source stage is selected.
4. Select the intersection to be deleted.
5. Click **Delete driver exception** .
6. Click **Yes** to confirm the deletion.

Working with the Bulk Editor

Use the Bulk Editor on the Driver Selections, Exceptions or Assignment screen to create multiple driver selections and assignments quickly and efficiently, without having to create each driver selection and assignment individually.

You can perform bulk edits on both Drivers and Assignments. The Bulk Edit is intended for a one-time use only, and it is not saved. You cannot rerun a generated Bulk Edit. You must create a new Bulk Edit for each operation.

Caution:

If a bulk edit does not perform the update that you expected, you may have to clear and rebuild the stage.

To view the results of the bulk update, you must generate a report for the database.

See the following procedures:

- [Adding a Single Driver to Multiple Source Stage Rules](#)
- [Removing Drivers from Multiple Source Stage Rules](#)
- [Adding Assignment Rule to Multiple Source Stage Rules](#)
- [Removing Assignment Rules from Multiple Source Stage Rules](#)

Adding a Single Driver to Multiple Source Stage Rules

Use the Bulk Editor to add a single driver to multiple Source Stage Rules.

To add driver selections through Bulk Edit:

1. From Oracle Hyperion Enterprise Performance Management Workspace, select **Navigate**, then **Applications**, then **Profitability**, and then select the application that you want to view.
2. In an open model, from **Task Areas**, select **Manage Allocations**, and then **Driver Selections**.
3. Select the **Exceptions** tab.

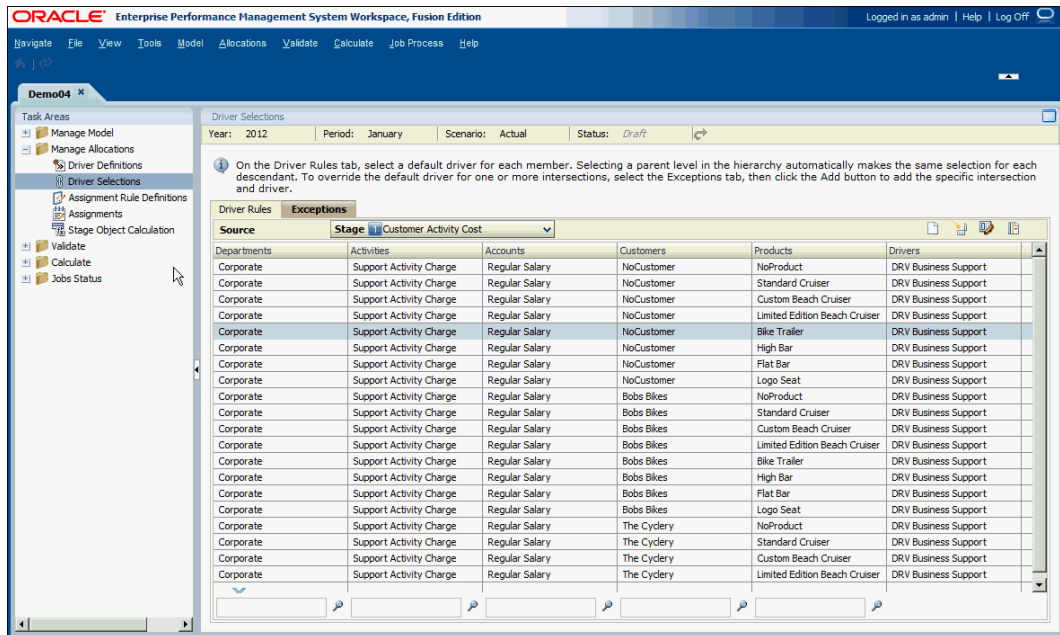

4. Click **Open Bulk Editor** .

Step 1: Select Edit Type

Edit Type: Add Drivers

Comment:

< Back
Next >
Cancel

5. **Optional:** On **Select Edit Type**, under **Comment**, enter a descriptive name for the Bulk Edit. This name is displayed for the selected bulk edit task on the Job Library screen.
6. Under **Edit Type**, select **Add Drivers**, and then click **Next**.

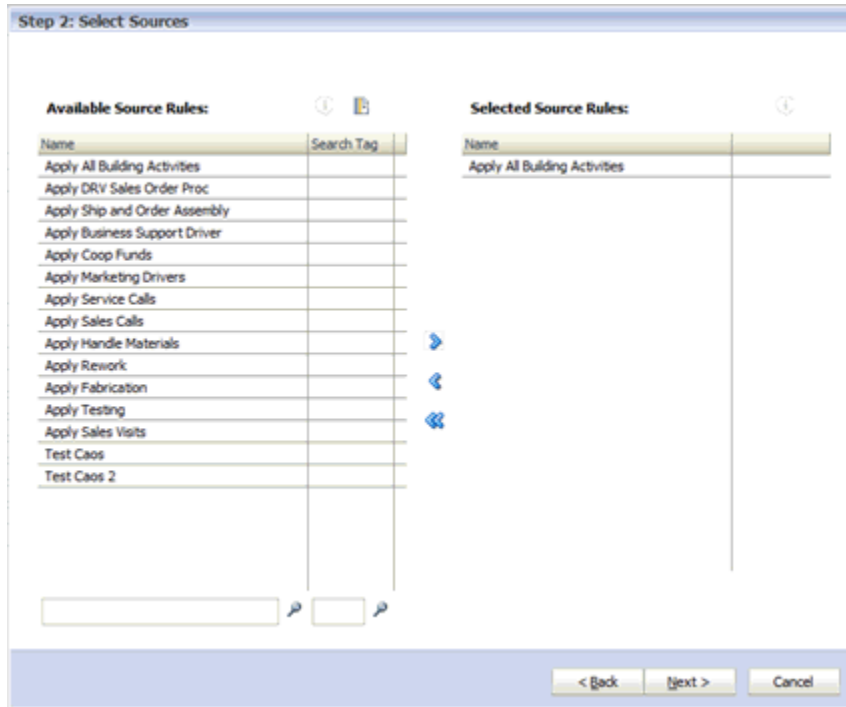

7. On **Select Sources**, from **Available Source Rules**, select the Source Stage Assignment Rules to which you want to apply the selected driver, and then use the arrow keys to move them to the **Selected Source Rules** column.
8. **Optional:** Click **Information**  to view the description of the selected stage rule.
9. Click **Next**.

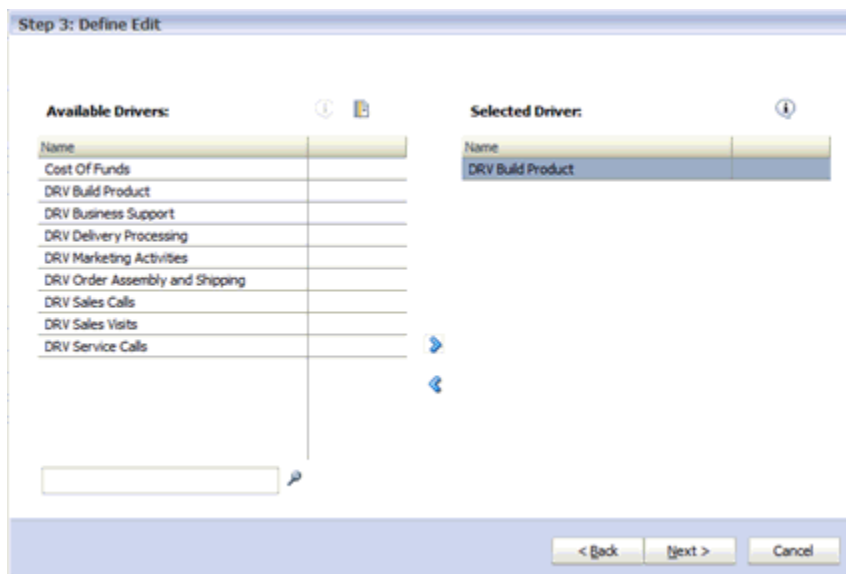

10. On **Define Edit**, under **Available Drivers**, select the name of the driver to be associated with the bulk edit. Only one driver can be selected.

11. Use the arrow keys to move the selected driver to **Selected Driver**, and then click **Next**.

The Bulk Edit Summary screen is displayed:

- Under **For These Sources**, the selected sources to which the selected driver will be applied are displayed.
- Under **Add This Driver**, the driver that will be applied to the selected sources is displayed.

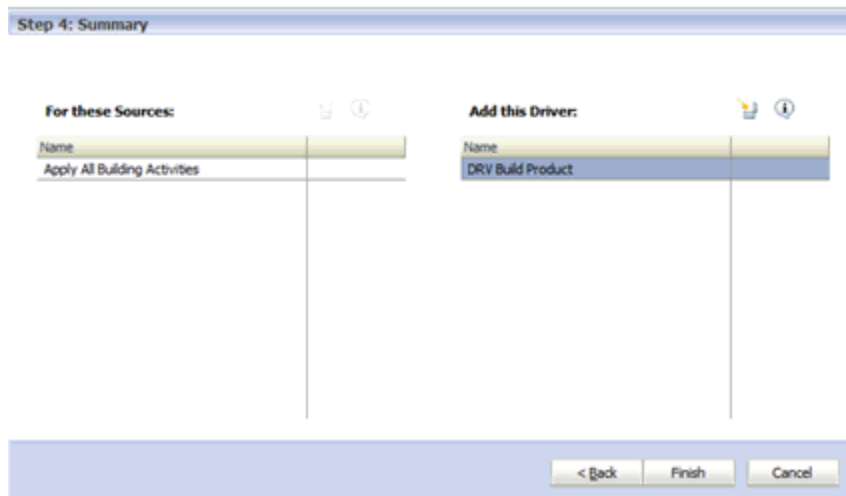

12. Click **Finish**.

The sources defined by the selected source rules are updated with the selected driver.

13. **Optional:** To view the results of the bulk update, generate a report for the database.

Removing Drivers from Multiple Source Stage Rules

Use the Bulk Editor to remove a single driver from multiple Source Stage Rules.

To remove a driver from multiple Source Stage Rules:

1. From Oracle Hyperion Enterprise Performance Management Workspace, select **Navigate**, then **Applications**, then **Profitability**, and then select the application that you want to view.
2. In an open model, from **Task Areas**, select **Manage Allocations**, and then **Driver Selections**.
3. Select the **Exceptions** tab.
4. Click **Open Bulk Editor** .
5. **Optional:** In **Select Edit Type**, under **Comment**, enter a descriptive name for the Bulk Edit. This name is displayed for the selected bulk edit task on the Job Library screen.
6. Under **Edit Type**, select **Remove Drivers**, and then click **Next**.
7. On **Select Sources**, under **Available Source Rules**, select the Stage Rules which you want to apply to the bulk edit, and then use the arrow keys to move them to the **Selected Source Rules** column.
 - **Optional:** Click **Select Entire Stage** to select all the node intersections on the stage.

- **Optional:** Click **Information**  to view the description of the selected stage rule.
8. Click **Next**.
 9. On **Define Edit**, under **Available Drivers**, select the drivers to be removed.
You can click **Remove All Drivers** to select all available drivers for removal.
 10. Use the arrow keys to move the selected drivers to **Selected Drivers**, and then click **Next**.
The Bulk Edit Summary screen is displayed:
 - Under **For These Sources**, the selected sources from which the selected drivers will be removed are displayed.
 - Under **Remove these Drivers**, the drivers to be removed are displayed.
 11. Click **Finish**.

 **Caution:**

Exercise extreme caution when performing a Bulk Edit Delete. No Delete confirmation is displayed when you click "Finish" so there is no opportunity to cancel the Bulk Edit Delete. The selected drivers from sources defined by the source stage rules are removed immediately.

12. **Optional:** To view the results of the bulk update, generate a report for the database.

Adding Assignment Rule to Multiple Source Stage Rules

Use the Bulk Editor to add Destination Stage Rules to Multiple Source Stage Rules.

To add Destination stage rules to Multiple Source stage rules:

1. From Oracle Hyperion Enterprise Performance Management Workspace, select **Navigate**, then **Applications**, then **Profitability**, and then select the application that you want to view.
2. In an open model, from **Task Areas**, select **Manage Allocations**, and then **Driver Selections**.
3. Select the **Exceptions** tab.

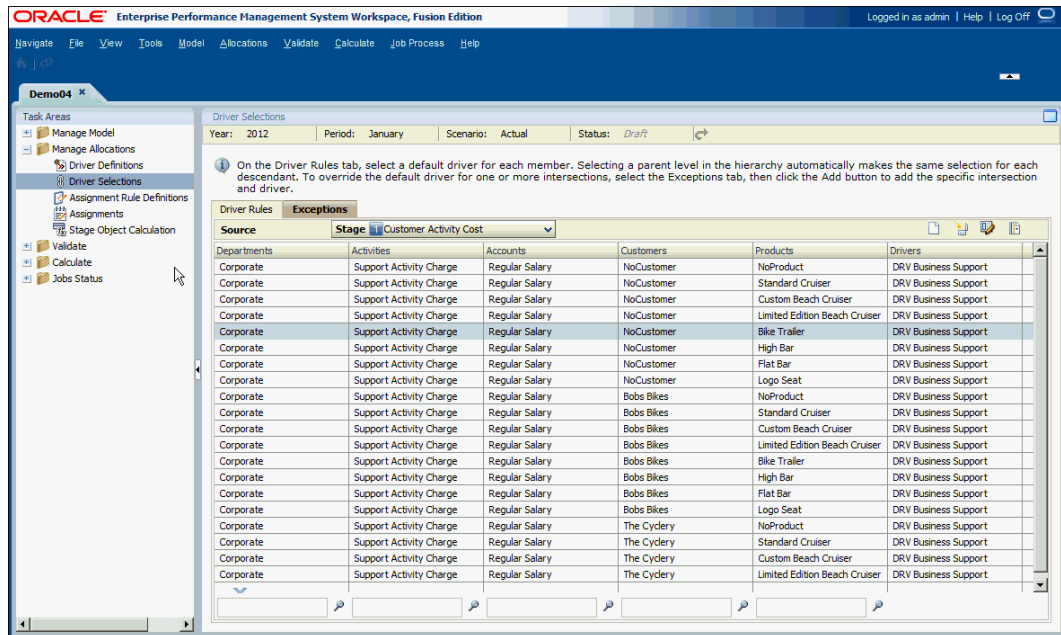

4. Click **Open Bulk Editor** .
5. **Optional:** On **Select Edit Type**, under **Comment**, enter a descriptive name for the Bulk Edit. This name is displayed for the selected bulk edit task on the Job Library screen.
6. Under **Edit Type**, select **Add Assignment Rules**, and then click **Next**.
7. On the **Select Sources** tab, under **Available Source Rules**, select the Source Stage Assignment Rules to be added, and then use the arrow keys to move them to the **Selected Source Rules** column.

Click **Information**  to view the description for the selected assignment rule.

8. Click **Next**.
Step 3: Define Edit is displayed.
9. On the **Define Edit** tab, under **Available Destination Rules**, select the Destination Stage Assignment Rules to be added, and then use the arrow keys to move them to the **Selected Destination Rules** column.

10. Click **Next**.

The Bulk Edit Summary screen is displayed:

- Under **For These Sources**, the selected Source Assignment Rules are displayed.
- Under **Add these Destination Rules**, the selected Destination Assignment Rules are displayed.

11. Click **Finish**.



The selected source stages are updated.

12. **Optional:** To view the results of the bulk update, generate a report for the database.

Removing Assignment Rules from Multiple Source Stage Rules

Use the Bulk Editor to remove assignment rules from multiple Source Stage Rules.

To remove assignment rules from multiple Source Stage Rules:

1. From Oracle Hyperion Enterprise Performance Management Workspace, select **Navigate**, then **Applications**, then **Profitability**, and then select the application that you want to view.
2. In an open model, from **Task Areas**, select **Manage Allocations**, then **Driver Selections**.
3. Select the **Exceptions** tab.
4. Click **Open Bulk Editor** .
5. **Optional:** On **Select Edit Type**, under **Comment**, enter a descriptive name for the Bulk Edit. This name is displayed for the selected bulk edit task on the Job Library screen.
6. Under **Edit Type**, select **Remove Assignment Rules**, and then click **Next**.
Step 2: Select Sources is displayed.
7. On **Select Sources**, under **Available Source Rules**, select the Stage Rules that you want to remove, and then use the arrow keys to move them to the **Selected Source Rules** column.
 - **Optional:** Click **Select Entire Stage** to select all node intersections on the stage.
 - **Optional:** Click **Information**  to view the description of the selected stage rule.
8. Click **Next**.
9. On the **Define Edit** tab, under **Available Destination Rules**, select the destination assignment rules to be removed.
You can click **Remove All Rules** to select all available destination assignment rules for removal.
10. Use the arrow keys to move the selected destination assignment rules to **Selected Destination Rules**, and then click **Next**.
The Bulk Edit Summary screen is displayed:
 - Under **For These Sources**, the selected sources from which the selected destination assignment rules will be removed are displayed.
 - Under **Remove these Destination Rules**, the destination assignment rules to be removed are displayed.
11. Click **Finish** to remove the selected assignment rules.

 **Caution:**

Exercise extreme caution when performing a Bulk Edit Delete. No Delete confirmation is displayed when you click "Finish" so there is no opportunity to cancel the Bulk Edit Delete. The selected assignment rules from sources defined by the source stage rules are removed immediately.

12. **Optional:** To view the results of the bulk update, generate a report for the database.

Working with Detailed Profitability Assignment Rules

Assignment rules define the sources and their destinations for the allocations or calculations that are posted.

Frequently, models include multiple assignments that use the same parameters. To simplify the creation of multiple assignments that are similar in nature, you can create and reuse assignment rules that specify the assignment parameters.

An assignment rule is a collection of member sets and optional filter sets. A filter is a collection of criteria that are applied to a dimension. The assignment rules are created based on one or more of the following criteria:

- Membership in a specific branch of the dimension hierarchy
- Member name
- Member alias

The Assignment Rule dialog, available from the Assignment Rule Definitions screen, enables you to create an assignment rule.

You can create assignment rules, using the following options:

- Define a specific set of member sets and optional filter sets for a single destination stage.
- Define a Same As Source assignment rule that replaces the destination stage dimension members with the selected source dimension member during the calculation.

See the following procedures:

- [Creating Assignment Rules](#)
- [Duplicating Detailed Profitability Assignment Rules](#)
- [Modifying Assignment Rules](#)
- [Deleting Assignment Rules](#)

Creating Assignment Rules

To create assignment rules:

1. From Oracle Hyperion Enterprise Performance Management Workspace, select **Navigate**, then **Applications**, then **Profitability**, and then select the application that you want to view.
2. In an open model, from **Task Areas**, select **Manage Allocations**, and then **Assignment Rule Definitions**.

The Assignment Rule Definition screen is displayed, showing the Name, Description, Stage, Search Tag and the creator's ID for each existing assignment rule.

3. Click **Add new assignment rule** .
4. On the **Assignment Rule** dialog box, in **Name**, enter the name for the new assignment rule.
5. Under **Stage**, select the stage for the assignment rule.

The associated dimensions are displayed under Dimension Selections.

6. **Optional:** Under **Description**, enter a brief description of the purpose or contents of the new assignment rule.
7. **Optional:** Enter a **Search Tag** to facilitate later searches for the rule.
8. Under **Dimension Selections**, review the dimensions for the selected stage.
9. Under the **Member Defined** column, click the cell for the dimension for which you want to define members.

The members for the selected dimension are displayed under **Dimension**

Member Selection. Use the Context Menu button  to change the view, filter, or sort the list of dimension members.

10. Under **Dimension Member Selection**, select the members to be included in the new assignment rule, and click the Add arrow icon  to move them under the **Selected Dimension Members** column.

Click **Filter**  to filter the non-0-level members selected, if required.

See [Using Filters](#).

Unmanaged dimensions can be viewed on the Data Filters tab (for destination assignment rules).

11. Click **OK**.

The Assignment Rule is added to the list of Assignment Rule Definitions.

Duplicating Detailed Profitability Assignment Rules

To easily create similar assignment rules, you can duplicate an existing assignment rule, and edit it to create a new assignment rule.

To duplicate assignment rules:

1. From Oracle Hyperion Enterprise Performance Management Workspace, select **Navigate**, then **Applications**, then **Profitability**, and then select the application that you want to view.
2. In an open model, from **Task Areas**, select **Manage Allocations**, then **Assignment Rule Definitions**.

The Assignment Rule Definition screen is displayed, showing the name, Description, Stage, Search Tag and the creator's ID for each existing assignment rule.

3. Select the assignment rule that you want to use as the template for the new assignment rule.

4. Click **Create Duplicate Rule** .

The Create Duplicate Assignment Rule dialog box is displayed.

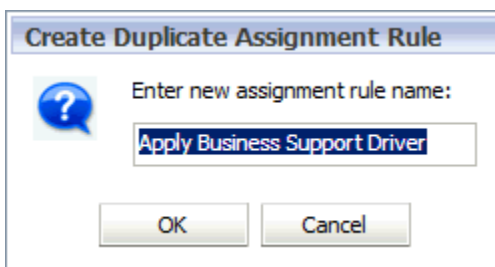

5. On the **Create Duplicate Assignment Rule** dialog box, enter a name for the new assignment rule, and then click **OK**.

The duplicated assignment rule is added to the list of Assignment Rule Definitions on the Assignment Rule Definitions screen.

6. Modify the new assignment rule as required. See [Modifying Assignment Rules](#).

Modifying Assignment Rules

To modify assignment rules:

1. From Oracle Hyperion Enterprise Performance Management Workspace, select **Navigate**, then **Applications**, then **Profitability**, and then select the application that you want to view.
2. In an open model, from **Task Areas**, select **Manage Allocations**, and then **Assignment Rule Definitions**.
3. On the **Assignment Rule Definition** screen, select the assignment rule that you want to modify.
4. Click **Edit assignment rule** .
5. On the **Assignment Rule** dialog box, modify any of the following elements:
 - Name
 - Description
 - Search Tag
 - Dimension Member Selection
 - Data Filter (for destination assignment rules)
 - Custom SQL Filter (for destination assignment rules)
6. Click **OK**.

The modified Assignment Rule is saved and displayed in the list of the Assignment Rule Definitions screen.

Deleting Assignment Rules

To delete assignment rules:

1. From Oracle Hyperion Enterprise Performance Management Workspace, select **Navigate**, then **Applications**, then **Profitability**, and then select the application that you want to view.

2. In an open model, from `Task Areas`, select **Manage Allocations**, and then **Assignment Rule Definitions**.
3. On the **Assignment Rule Definitions** screen, select the assignment rule that is to be deleted.
4. Click **Delete assignment rule** .

 **Caution:**

Deletion of an assignment rule affects the calculation of model data because the rule and its rule selections are deleted.

5. In the Confirmation dialog box, click **Yes** to confirm deletion of the assignment rule.

The selected assignment rule is deleted and removed from the list of Assignment Rule Definitions on the Assignment Rule Definition screen.

Working with Assignments in Detailed Profitability

Assignments define the flow of data from the source to the destination.

Each assignment is the combination of the selected source stage and the driver that performs the calculation of the source value into a result that is assigned to the destination of the assignment.

In Detailed Profitability, destinations for the assignments are defined by mapping the source intersection to one or more of the assignment rules. Explicitly defined destinations are not supported in Detailed Profitability. You can also create an assignment rule that can be used multiple times. See [Working with Detailed Profitability Assignment Rules](#).

For detailed instructions on working with assignments, see these sections:

- [Creating Assignments](#)
- [Deleting Assignments](#)

Creating Assignments

Oracle recommends that you create all assignments for a process or allocation in sequence to ensure that all elements are captured. After you create all assignments, the model structure is validated to verify that no appropriate driver selections are missing.

To create assignments:

1. From Oracle Hyperion Enterprise Performance Management Workspace, select **Navigate**, then **Applications**, then **Profitability**, and then select the application that you want to view.
2. In an open model, from `Task Areas`, select **Manage Allocations**, then **Assignments**.

- On the **Assignments** screen, select a POV for the selected model, and then click **Load the POV status** .

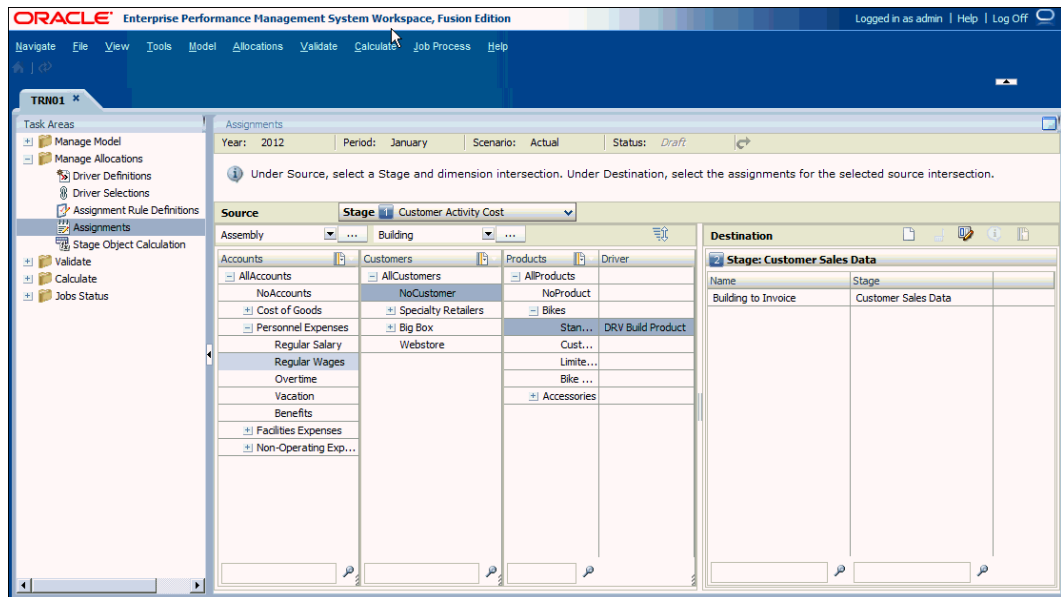

- Under **Source**, select a member from each dimension to create the intersection for the source of the assignment. The Source stage is pre-selected.

The first two dimensions for the source stage are displayed directly above the displayed dimensions, while the last three dimensions for the source stage are displayed with full member lists.

 **Note:**

To find a member in the hierarchy, type the member name in the text box at the bottom of the column, and then click Search.

- Optional:** To rearrange the dimensions that are displayed on the Assignments screen, click **Reorder Dimensions** .

Use the arrow keys to move the dimensions up or down into the required sequence, and then click **OK**. To revert to the original sequence, click **Use Default Order**.

- Optional:** Under **Destination**, select **Member Selector**  to filter the list of available destinations:

- Select **Filter**  to display the Filter dialog box.
- Enter the filter criteria in Name or Stage, and then click **OK**.

Enter the exact name of the required item, or use a trailing asterisk (*) as a wild card to select a range of items, or a trailing question mark (?) to select a single character. For example, to find all destination assignment rules with names that begin with the letter "M", enter "M*" in the Name field. Entering the asterisk before the letter does not work, for example "*M."

- Under **Destination**, click **Open Assignment Rules Management** .
To add multiple assignment rules, see [Working with the Bulk Editor](#).

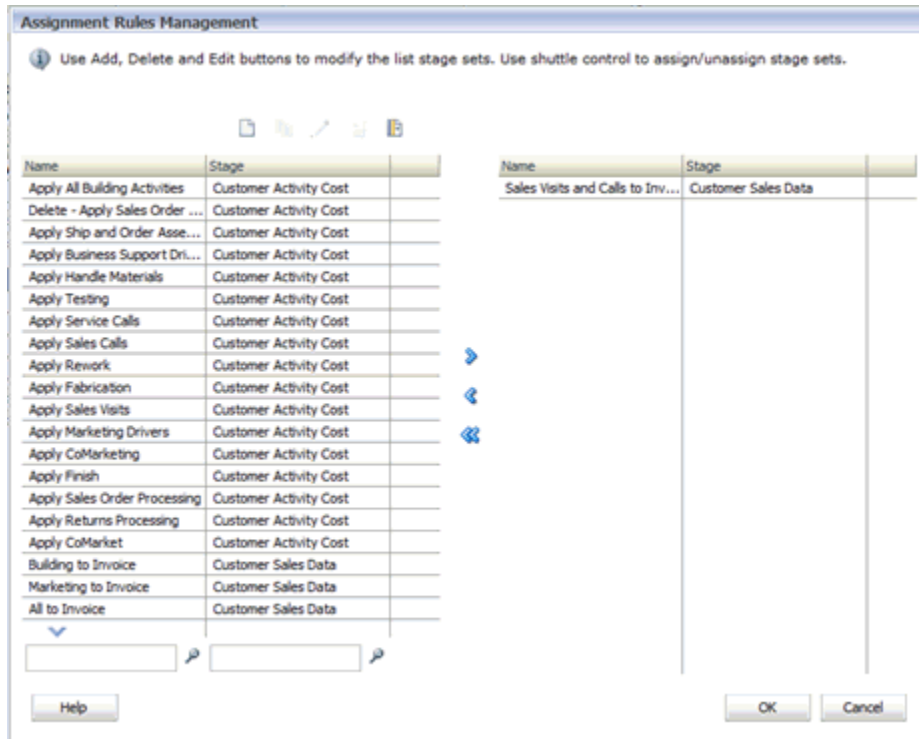

- On the **Assignment Rule Management** screen, click **Add new assignment rule** . See [Creating Assignment Rules](#)

Assignment Rule

Name: Description:

Stage: **Stage** Customer Activity Cost

Search Tag:

Dimension Selections

Dimension	Member Defined	
CostCenters		
Activities		
Accounts		
Customers		
Products		

Dimension Member Selection

CostCenters

- AllCostCenters
- NoCostCenter
- Corporate
- Warehouse
- Facilities
- Sales
 - Outside Sales
 - Inside Sales**
- Manufacturing
- Marketing
- Shipping
- Customer Service
- Administration

Selected Dimension Members:

Help OK Cancel

9. On the **Assignment Rule** screen, enter details for the new assignment rule:
 - In **Name**, enter the name for the new assignment rule.
 - From **Stage**, select the stage.
 - **Optional:** In **Description**, enter a brief description of the purpose of the new assignment rule.
 - **Optional:** Enter a **Search Tag** to help you locate the assignment rule at a later time.
10. Under **Dimensions** and **Dimensions Selection**, use the arrow keys to move the dimension members to the **Selected Dimension Members** column.
11. **Optional:** To filter the Destination stage on the Data Filters tab:
 - a. From **Stage**, select the Destination stage.
The Data Filters tab is displayed.
 - b. Click the **Data Filters** tab.

Assignment Rule

Name: Description:

Stage: **Stage 2** Customer Sales Data

Search Tag:

Dimension Selections **Data Filters**

Use Custom Filter

Dimension	Member Defined
Co-Marketing Expense	✓
Cost of Accounts Receivable	
Cost of Goods Sold	
Discount Amount	
Discount Rate	
Extended List	
General and Admin Expense	
Gross Margin	
Gross Profit	
Interest Expense	
Item List	
Materials Expense	
Net Profit	
Non-Operating Expense	
Operating Expense	
Operating Profit	

Filter Statement

Operation	Value	Condition
>	2	

Buttons: Help, OK, Cancel

- c. On the **Data Filters** tab, under **Columns**, select the dimension to be used for the assignment rule.
The Filter Statement is displayed in the right pane. For example, SELECT from Customer Zone Weight.
- d. **Optional:** To create a standard type of filter, double-click each field to enter the parameters for the filter:
 - Under **Operation**, select the type of operation to be used, such as <, >, Equal, Not Equal.
 - Under **Value**, double-click the field to enter the appropriate value.
 - Under **Condition**, double-click the field to select OR or AND from the drop-down list to append additional filter statements.
- e. **Optional:** To create a custom filter, click **Use Custom Filter**. A Filter Statement and blank edit pane are displayed, so you can enter a mathematically and syntactically correct SQL formula.

Assignment Rule

Name: Description:

Stage: **Stage 2 Invoice**

Search Tag:

Dimension Selections **Data Filters**

Columns

Use Custom Filter

Dimension	Member Defined
CostReceived	
Extended Unit Price	
Quantity	<input checked="" type="checkbox"/>
Unit Price	
Profit	
Revenue	
Weight	
Cube Size	
Unit Price	
Supplier Zone Weight	
Customer Zone Weight	

Filter Statement

SELECT from Invoice.businessobject

Destination.'Quantity' > 10



12. Click **OK**.
13. On the **Assignment Rules Management** dialog box, select stage sets using the arrow keys, and then click **OK**.

The Destination column is populated with the selected stage sets.

Deleting Assignments

You can delete assignments as required; however, be aware that any changes will affect the financial flow and the calculation results for the model.

To delete assignments:

1. From Oracle Hyperion Enterprise Performance Management Workspace, select **Navigate**, then **Applications**, then **Profitability**, and then select the application that you want to view.
2. In an open model, from **Task Areas**, select **Manage Allocations**, and then **Assignments**.
3. Select the POV of the model that contains the assignment to be changed, and then click **Load the POV status** .
4. Under **Destination**, select the assignment rule to be unassigned.
5. Click **Unassign assignment rule** .
6. In the Confirmation message, click **Yes** to confirm the deletion.

Calculating Detailed Profitability Models

After you validate the structure and data of a model, you can manage the database and calculate the model.

Caution:

Oracle recommends that the calculation of models be performed by an Admin or Power User who has a working knowledge of Detailed Oracle Hyperion Profitability and Cost Management and the client's model data and databases. For more detailed information on Pre- and Post-Calculation Custom Scripts, see the "Calculating Detailed Profitability" section in *Oracle Hyperion Profitability and Cost Management Administrator's Guide*.

Managing Detailed Profitability Databases

See the following sections:

- [Deploying Detailed Profitability Reporting Views](#)
- [Deploying Detailed Profitability Source Stage Database](#)
- [Deploying Detailed Profitability Contribution Database](#)
- [Deploying Detailed Profitability Destination Stage Database](#)

Deploying Detailed Profitability Reporting Views

After validating the structure and data of a model, you must deploy the dimension objects to create system-generated Reporting Views and synchronize the views. The views are created on the Detailed Profitability Product schema with access grants to the Model Data Schema that was selected on the Model Level Preferences tab.

All deployed dimensions are listed, including managed dimensions, POV dimensions, and attribute dimensions. To see which dimensions should be included, you can view the list for the application in the Application Library. Attribute dimensions are only displayed if they are in the application.

There are two categories of system-generated reporting views:

- Reporting Hierarchy Table – Displays one row for each ancestor level in the hierarchy (parent, grandparent, and so on).
- Reporting Attribute View – Displays one row per dimension member, including all levels of the hierarchy (the dimension member and any defined dimension attributes) This joins the dimension member with other attribute values.

The view and table names are generated in the following format:

<Product Name>_<Application Name>_<User-Defined Dimension Short Name><View/Table Type_V>(for views only)

For example:

- HPMD_DEMO_ACCOUNTS_HIER (Hierarchy Table)
- HPMD_DEMO_ACCOUNTS_ATTR_V (Attribute View)

The deployed views and tables are available under the Model Data Schema as synonyms, and these views and tables are useful for creating the custom reports.

To create the Reporting View, you must first deploy the application in Oracle Essbase. After the deployment, change the Short Names, if required.

To create or recreate the application dimension views:

1. Ensure that the selected application has been deployed in Essbase. See *Oracle Essbase Database Administrator's Guide* for instructions.
2. From Oracle Hyperion Enterprise Performance Management Workspace, select **Navigate**, then **Applications**, then **Profitability**, and then select the application for which you want to create reporting views.
3. In an open model, from **Task Areas**, select **Calculate**, and then **Manage Database**.

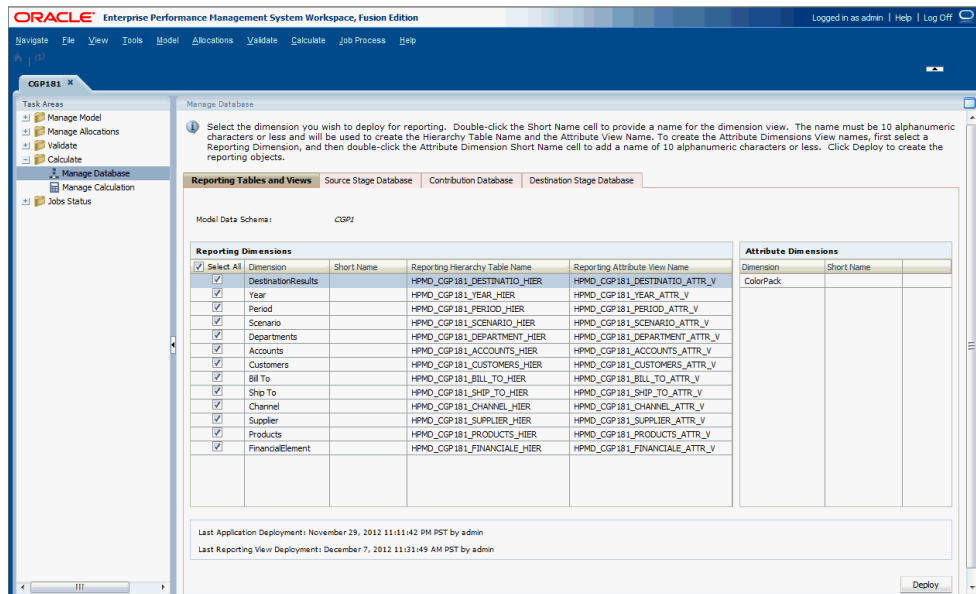

4. On **Manage Database**, on the **Reporting Tables and Views** tab, review the **Model Data Schema**.

If the Model Data Schema is not the one that you want to use, you cannot change it on this screen. You must go back to the Model Level Preferences tab to select the correct one. See [Selecting the Detailed Model Data Schema](#).

5. **Optional:** Under **Last Application Deployment** and **Last Reporting View Deployment**, review the displayed dates.

The Last Reporting View Deployment date should be later than the Last Application Deployment. If not, redeploy the Reporting Views to synchronize the applications.

6. On the **Reporting Dimensions** pane, select the dimensions to be included in the deployment:
 - Check **Select All** to include all listed dimensions.
 - Check individual dimensions to include only those dimensions.
7. **Optional:** Under the dimension **Short Name**, for any selected dimension, double-click the cell to open it for editing and enter a short name of up to 10 characters. This short name is used to create the Reporting View names.

By default, the first 10 characters of the dimension name are used when the table is generated. This short name is used in the Reporting View names. By default, the characters are all in uppercase.

 **Note:**

Do not use special or restricted characters in the Short Name, such as /,+, or @ signs. See the *Oracle Essbase Database Administrator's Guide* to view the latest naming restrictions.

8. Click **Deploy**.

The deployed views are based on the Oracle Hyperion Profitability and Cost Management application tables.

These views are created on the Profitability and Cost Management Product schema, and grants are made to access the Reporting Views in the Model Data Schema. See the *Oracle Hyperion Profitability and Cost Management Administrator's Guide*.

Deploying Detailed Profitability Source Stage Database

To deploy source stage database:

1. In an open model, from **Task Areas**, select **Calculate**, and then **Manage Database**.
Select the Source Stage Database tab.

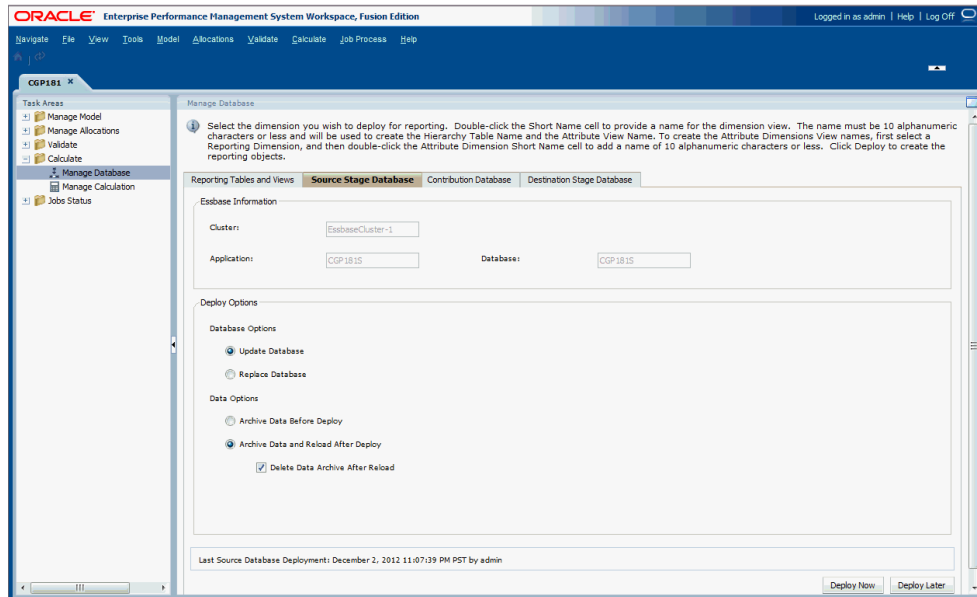

2. Under **Essbase Information**, review the following information:
 - **Cluster** displays the name of the Oracle Essbase database cluster that contains the model.
 - **Application** displays the name of the Essbase application to which the application is being deployed.
 - **Database** displays the name of the Essbase database to which the application is being deployed.
3. Under **Deploy Options**, select the **Database Options** for deploying the source stage database:
 - For the first deployment of a database, all selections are grayed out. This option creates the entire database for the first time.
 - To redeploy an existing database, select **Update Database** to retain existing artifacts and property settings in the new database, and change the outline to reflect current metadata.
 - For subsequent deployments, select **Replace Database** to remove the database and applications completely, and recreate them.
4. Under **Deploy Options**, select the **Data Options** to be used for the source stage database deployment:
 - Select **Archive Data Before Deploy** to export existing data to the application database folder. For the Calculation database, Only Level-0 data is exported for the ASO database. Data is always exported in the native format.
 - Select **Archive Data and Reload After Deploy** to automatically import the data back into Essbase, using the previously exported data files. A Rules File is not generated for ASO databases.

This option is available only if no dimensions are being added or removed. Dimensions can be added or removed in the Profitability Applications Console, or by adding, deleting, or changing a stage in Oracle Hyperion Profitability and Cost Management.

After deleting dimension members, the **Archive Data and Reload After Deploy** option for redeploying the cube to Essbase and preserving the data is not guaranteed to always work, depending on how Essbase is able to deal with those deleted members. As a workaround, you may have to export all data and remove the data for the deleted members and then reload the data in a separate step after deploying the cube without the **Archive Data and Reload After Deploy** option selected.

- **Optional:** If **Archive Data and Reload After Deploy** was chosen, you can select **Delete Data Archive After Reload** to automatically delete the archived data only after the successful data reload.
5. **Optional:** Click **Deploy Later** to schedule a convenient date and time to run the deployment.

If this option is not selected when the task is created, you will not be able to schedule the task.

6. **Optional:** Click **Deploy Now** to deploy the source stage database immediately.

A confirmation message is displayed, indicating that the job has started and identifying the assigned taskflow ID.

Depending on the size and complexity of the model, this operation may take a significant amount of time.

7. Select **Jobs Status**, and then **Job Library** to monitor the task status.
8. If the **Replace Database** option was chosen, or the data import failed for some reason, after deployment, rerun the **Data Transfer** for this database.
9. Run **Data Transfer** for the generated database.

Deploying Detailed Profitability Contribution Database

To deploy contribution database:

1. In an open model, from **Task Areas**, select **Calculate**, and then **Manage Database**. Select the **Contribution Database** tab.

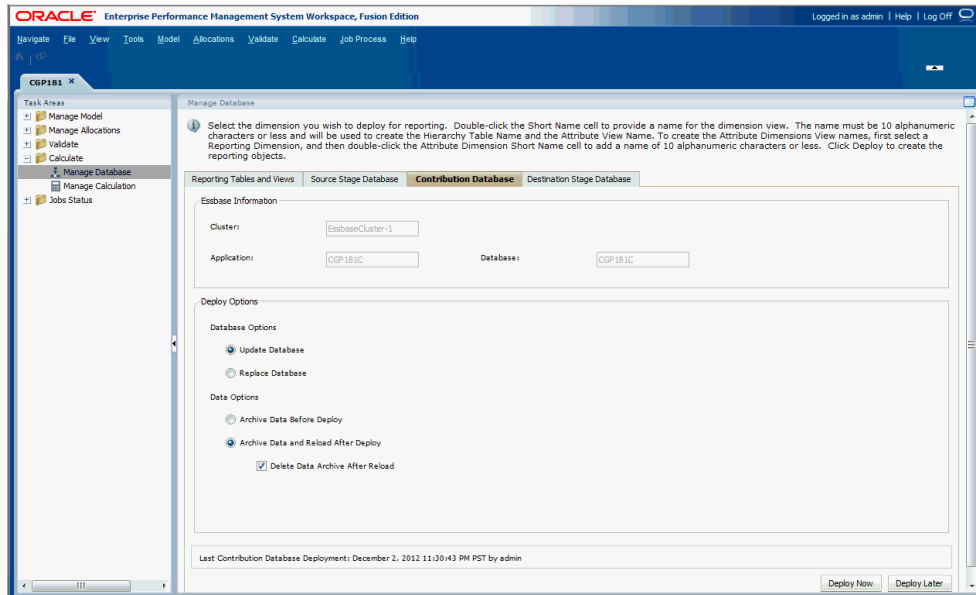

2. Under **Esbase Information**, review the following information:
 - **Cluster** displays the name of the Oracle Essbase database cluster that contains the model.
 - **Application** displays the name of the Essbase application to which the application is being deployed.
 - **Database** displays the name of the Essbase database to which the application is being deployed.
3. Under **Deploy Options**, select the **Database Options** for deploying the contribution database:
 - For the first deployment of a database, all selections are grayed out. This option creates the entire database for the first time.
 - To redeploy an existing database, select **Update Database** to retain existing artifacts and property settings in the new database, and change the outline to reflect current metadata.
 - For subsequent deployments, select **Replace Database** to remove the database and applications completely, and recreate them.
4. Under **Deploy Options**, select the **Data Options** to be used for the contribution database deployment for Update Database database option selected:
 - Select **Archive Data Before Deploy** to export existing data to the application database folder. Only level-0 data is exported for the ASO database. Data is always exported in the native format.
 - Select **Archive Data and Reload After Deploy** to automatically import the data back into Essbase, using the previously exported data files. A Rules File is not generated for ASO databases.

This option is available only if no dimensions are being added or removed. Dimensions can be added or removed in the Profitability Applications Console, or by adding, deleting, or changing a stage in Oracle Hyperion Profitability and Cost Management.

After deleting dimension members, the **Archive Data and Reload After Deploy** option for redeploying the cube to Essbase and preserving the data is not guaranteed to always work, depending on how Essbase is able to deal with those deleted members. As a workaround, you may have to export all data and remove the data for the deleted members and then reload the data in a separate step after deploying the cube without the **Archive Data and Reload After Deploy** option selected.

- **Optional:** If **Archive Data and Reload After Deploy** was chosen, you can select **Delete Data Archive After Reload** to automatically delete the archived data only after the successful data reload.
5. **Optional:** Click **Deploy Later** to schedule a convenient date and time to run the deployment.

If this option is not selected when the task is created, you will not be able to schedule the task.

6. **Optional:** Click **Deploy Now** to deploy the contribution database immediately.

A confirmation message is displayed, indicating that the job has started and identifying the assigned taskflow ID.

Depending on the size and complexity of the model, this operation may take a significant amount of time.

7. Select **Jobs Status**, and then **Job Library** to monitor the task status.
8. If the **Replace Database** option was chosen, or the data import failed for some reason, after deployment, rerun the **Data Transfer** for this database.
9. Run **Data Transfer** for the generated database.

Deploying Detailed Profitability Destination Stage Database

To deploy destination stage database:

1. In an open model, from **Task Areas**, select **Calculate**, and then **Manage Database**. Select the **Destination Stage Database** tab.

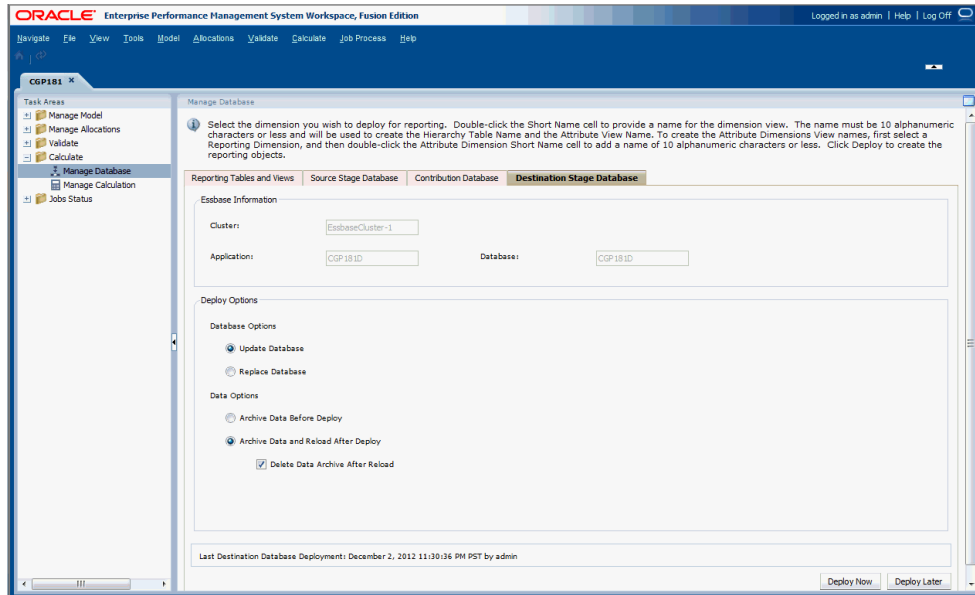

2. Under **Essbase Information**, review the following information:
 - **Cluster** displays the name of the Oracle Essbase database cluster that contains the model.
 - **Application** displays the name of the Essbase application to which the application is being deployed.
 - **Database** displays the name of the Essbase database to which the application is being deployed.
3. Under **Deploy Options**, select the **Database Options** for deploying the destination stage database:
 - For the first deployment of a database, all selections are grayed out. This option creates the entire database for the first time.
 - To redeploy an existing database, select **Update Database** to retain existing artifacts and property settings in the new database, and change the outline to reflect current metadata.
 - For subsequent deployments, select **Replace Database** to remove the database and applications completely, and recreate them.
4. Under **Deploy Options**, select the **Data Options** to be used for the destination stage database deployment for Update Database database option selected:
 - Select **Archive Data Before Deploy** to export existing data to the application database folder. Only Level-0 data is exported for the ASO database. Data is always exported in the native format.
 - Select **Archive Data and Reload After Deploy** to automatically import the data back into Essbase, using the previously exported data files. A Rules File is not generated for ASO databases.

This option is available only if no dimensions are being added or removed. Dimensions can be added or removed in the Profitability Applications Console, or by adding, deleting, or changing a stage in Oracle Hyperion Profitability and Cost Management.

After deleting dimension members, the **Archive Data and Reload After Deploy** option for redeploying the cube to Essbase and preserving the data is not guaranteed to always work, depending on how Essbase is able to deal with those deleted members. As a workaround, you may have to export all data and remove the data for the deleted members and then reload the data in a separate step after deploying the cube without the **Archive Data and Reload After Deploy** option selected.

- **Optional:** If **Archive Data and Reload After Deploy** was chosen, you can select **Delete Data Archive After Reload** to automatically delete the archived data only after the successful data reload.
5. **Optional:** Click **Deploy Later** to schedule a convenient date and time to run the deployment.

If this option is not selected when the task is created, you will not be able to schedule the task.

6. **Optional:** Click **Deploy Now** to deploy the destination stage database immediately.

A confirmation message is displayed, indicating that the job has started and identifying the assigned taskflow ID.

Depending on the size and complexity of the model, this operation may take a significant amount of time.

7. Select **Jobs Status**, and then **Job Library** to monitor the task status.
8. If the **Replace Database** option was chosen, or the data import failed for some reason, after deployment, rerun the **Data Transfer** for this database.
9. Run **Data Transfer** for the generated database.

Managing Detailed Profitability Calculations

After validating the model, you can calculate the model, select the processing options, including any Custom Scripts, or select distinct Data POVs.

Calculating Detailed Profitability Models

Processing times may be affected by calculation selections. You can run the operations directly from the screen or schedule a suitable time.

Running the Model Calculation creates two views for use within Reports, which you can use to create custom reports:

- **HPMD_DEMO_STAGE_BALANCE_V**—Contains the stage balance information viewed within the Stage Balance Report.
- **HPMD_DEMO_LEVEL_0_CONTRIB_V**—Contains the contribution information for each source and destination combination at Level Zero.

Caution:

There is a new dependency for the Detailed Profitability calculation engine on the dimension hierarchy reporting tables that were previously optional. To deploy these tables, select **Calculate**, and then **Manage Database**, and then select the **Reporting Tables and Views** tab. You must redeploy these tables each time you redeploy the Detailed Profitability application. To check whether the tables must be redeployed, see step 5 in [Deploying Detailed Profitability Reporting Views](#).

To calculate a model:

1. From Oracle Hyperion Enterprise Performance Management Workspace, select **Navigate**, then **Applications**, then **Profitability**, and then select the application that you want to calculate.
2. In an open model, from **Task Areas**, select **Calculate**, and then **Manage Calculation**.

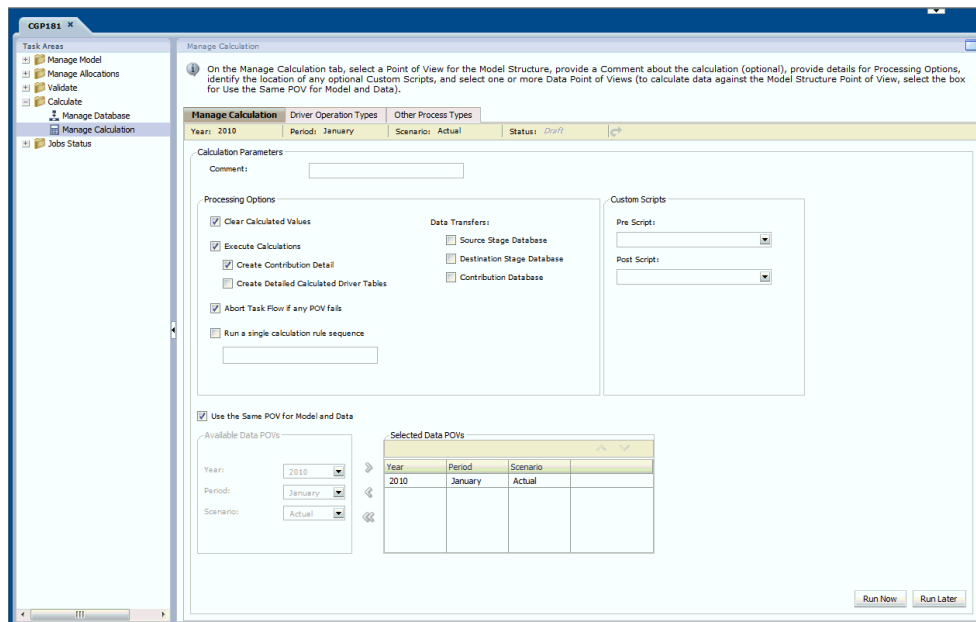

3. In the Task bar, select the POV for the model, and then click **Load the POV status** .
4. **Optional:** Under **Calculation Parameters**, in **Comment**, enter a brief description or name for the calculation.
5. **Optional:** Under **Processing Options**, check **Clear Calculated Values** to remove previously calculated data before beginning this calculation.
6. Under **Execute Calculations**, select the additional types of data that you want to generate for this calculation:
 - Check **Create Contribution Detail** to include all contributions in the model in the calculation.

- Check **Create Detailed Calculated Driver Tables** to retain the Calculated Driver tables that store the calculated driver values before the next source intersection is processed.

 **Note:**

If this option is selected, a large number of tables may be generated, so you must ensure that there is enough storage space available. Be aware that processing time might increase.

7. **Optional:** If you selected multiple POVs, check **Abort Task Flow if any POV fails**. If one of the POVs fails, the calculation is stopped, and the remaining POVs are not calculated.
8. If you select **Run a single calculation rule sequence**, enter the individual sequence number.
9. Under **Data Transfers**, select the Oracle Essbase analysis databases that you want to transfer data into:
 - **Source Stage Database:** Includes Source Stage Dimensions (including 'Source Measures Dimension') with stage prefix, Attribute Dimensions if any associated, 'MeasuresDetailed' Dimension, contains the detail of the source stage at level 0.
 - **Contribution Database:** Includes Source Stage Dimensions with stage prefix, Destination Stage Dimensions with stage prefix, 'MeasuresDetailed' Dimension, Attribute Dimensions if any associated, contains the detail from the Level 0 Contribution Table and the single measure ReceivedPriorStage.
 - **Destination Stage Database:** Includes Destination Stage Dimensions with stage prefix, Destination Measures Dimension, Attribute Dimensions if any associated, contains data from the destination stage table aggregated to the Level 0 members.
10. **Optional:** If you have Custom Scripts, enter the name of any pre- or post-calculation scripts that must be run.

Custom scripts are stored within the HPM Product Schema in the HPM_SQL_SCRIPT. For information on pre- or post-calculation scripts, see the *Oracle Hyperion Profitability and Cost Management Administrator's Guide*.
11. **Optional:** Under **Use the Same POV for Model and Data**, clear this option if you want to use a different POV to access Data; otherwise, the POV selected at the top of the screen is used for both model and data.

To set a different POV for Data:
 - a. Clear the **Use the Same POV for Model and Data** check box to enable POV selection.
 - b. Under **Available Data POVs**, select the Year, Period, and Scenario for the new Data POV.
 - c. Use the arrow keys to move the selected POV under **Selected Data POVs**.
 - d. Repeat step 11.b and step 11.c to create additional Data POVs.
12. Calculate the model, using one of the following options:
 - Click **Run Later** to submit a calculation task for further scheduling data and the time of execution. A confirmation message indicates that the job has been created and identified the assigned taskflow ID. See [Scheduling Detailed Profitability Task Flows](#).

 **Note:**

If this option is not selected when the task is created, you cannot schedule the task.

- Click **Run Now** to run the calculations immediately.

A confirmation message indicates that the job has started and identifies the assigned taskflow ID. Select **Jobs Status**, and then **Job Library** to monitor the task status.

 **Caution:**

Depending on the size and complexity of the model, this operation may take significant time.

Driver Operation Types

The Driver Operation Types tab on the Manage Calculation screen currently displays the current driver operation types for Detailed Profitability.

 **Caution:**

Do not create new driver operation types on this tab. Only an experienced Database Administrator should access this tab, as any changes may have a profound impact on the application, and may corrupt the model or data.

The Driver Operation Types is an administration feature intended for extending supported driver operations to solve performance issues or unique driver challenges. Its use requires advanced SQL knowledge, advanced understanding of Database Administration, and advanced understanding of an undocumented feature of Oracle Hyperion Profitability and Cost Management Detailed Profitability applications. Oracle does not recommend the use of this feature unless requested by Oracle in response to a customer service request.

Other Process Types

Two alternative calculation process types are available for this release of Detailed Profitability:

- Oracle Database 11g (the default)
- Oracle Database 10g

If the system is configured with Oracle Database 10g, use the Other Process Type tab to select the appropriate calculation process for the database.

Caution:

Oracle recommends that only experienced Database Administrators use the Other Process Type tab. Do not make any other modifications to the Other Process Type, as they may have a profound impact on the applications, and may corrupt the model or data.

Depending on the Oracle database version that you are using for Detailed Profitability, use this screen to change the database to the correct version.

To change the Oracle Database version:

1. From Oracle Hyperion Enterprise Performance Management Workspace, select **Navigate**, then **Application**, then **Profitability** and then select the application for which you want to modify the Oracle Database version.
2. Under Task Areas, select **Calculate**, then **Manage Calculation**, and then the **Other Process Types** tab.

Note:

This tab is only visible if you have been assigned an Administrator user role.

3. Select **Dimension Group Synchronize**, and then click **Edit**

The Define Other Process Type dialog box is displayed.

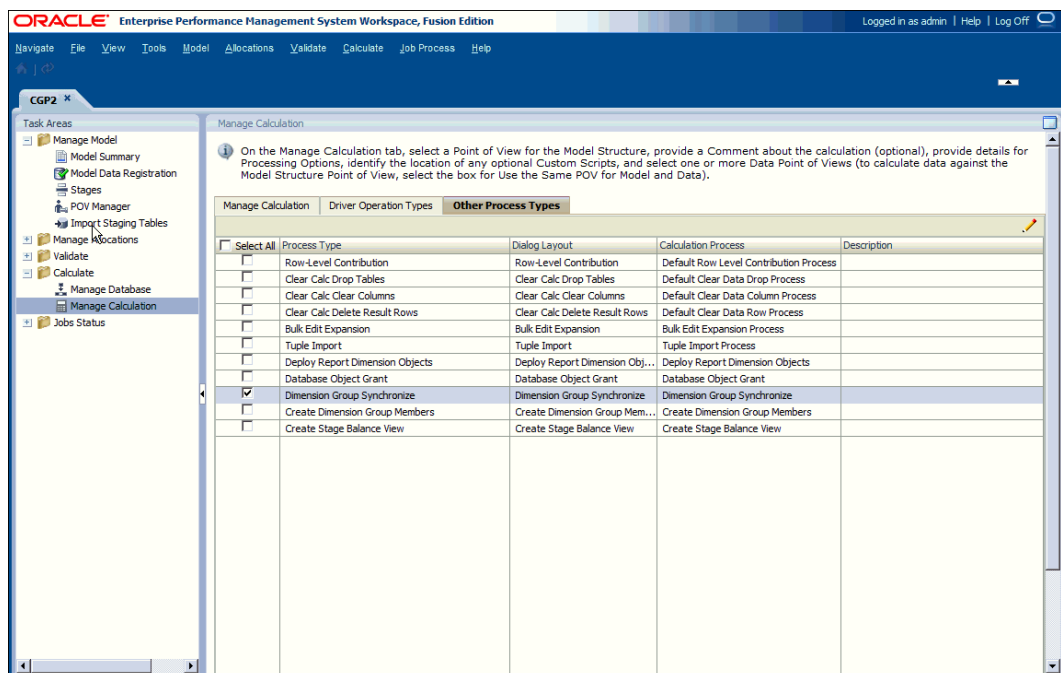

4. Under Calculation Process, select the appropriate option for the Oracle database:

- Dimension Group Synchronize (Oracle 11g)
 - Dimension Group Synchronize 10G (Oracle 10g)
5. Click **OK** to save the change.

Validating Detailed Profitability Models

Related Topics

- [About Detailed Profitability Validation](#)
A model must be validated multiple times during its lifecycle.
- [Detailed Profitability Model Validation Rules](#)
The model is verified against a set of model validation rules to ensure that the structure is sound before calculating the model.
- [Validating Detailed Profitability Model Structure](#)
The Detailed Profitability model structure must be validated before calculation to ensure all required modeling rules have been applied.

About Detailed Profitability Validation

A model must be validated multiple times during its lifecycle.

- After completing Model Data Registration, perform Model Validation for Model Data Registration to ensure that all tables have been properly registered for usage in the model before you proceed to define the rest of the model.
- After the model is built, perform Model Validation to ensure that the model structure conforms to modeling rules.
- After calculating the model, generate Source and Destination Stage Balancing Reports to balance all in and out entries for the model.

The tabs available on the Model Validation screen are read-only, and highlight issues with the Detailed Profitability model structure:

- Model Data Registration
- Drivers
- Calculation Rules
- Unused Drivers
- Missing Driver Assignments
- Assignment Rules

Any errors and missing information are displayed, along with the associated severity. You must correct errors encountered during the model structural validation cycle before you can continue to build or calculate the model.

See these sections to perform the appropriate validation on the model:

- [Detailed Profitability Model Validation Rules](#)
- [Validating Detailed Profitability Model Structure](#)
- [Detailed Profitability Stage Balancing Report](#)
- [Unassigned Values](#)

- [Idle Capability](#)
- [OverDriven Values](#)
- [Generating the Detailed Profitability Stage Balancing Report](#)

Detailed Profitability Model Validation Rules

The model is verified against a set of model validation rules to ensure that the structure is sound before calculating the model.

The structure validation checks to ensure these conditions are met:

- Model Data Registration is valid and complete
- Drivers are correctly formed
- Calculation Rules are correct
- All drivers are used
- No driver assignments are missing
- Assignment rules are correct

You must resolve any structural errors before you can calculate the model. Correct any errors, and submit the model for validation again. You may need to correct errors and revalidate several times.



Tip:

Sometimes correcting one error may cause another problem, so it is useful to revalidate the model after each correction.

Validating Detailed Profitability Model Structure

The Detailed Profitability model structure must be validated before calculation to ensure all required modeling rules have been applied.

You must click **Validate** on each tab of the Model Validation screen to evaluate the different components of the application. After the validation for the tab is performed, any errors or warnings are displayed.

Before a model can be successfully calculated, all errors in the model structure must be corrected.

To validate model stages:

1. From Oracle Hyperion Enterprise Performance Management Workspace, select **Navigate**, then **Applications**, then **Profitability**, and then select the application that you want to view.
2. In an open model, from **Task Areas**, select **Validate**, and then **Model Validation**.

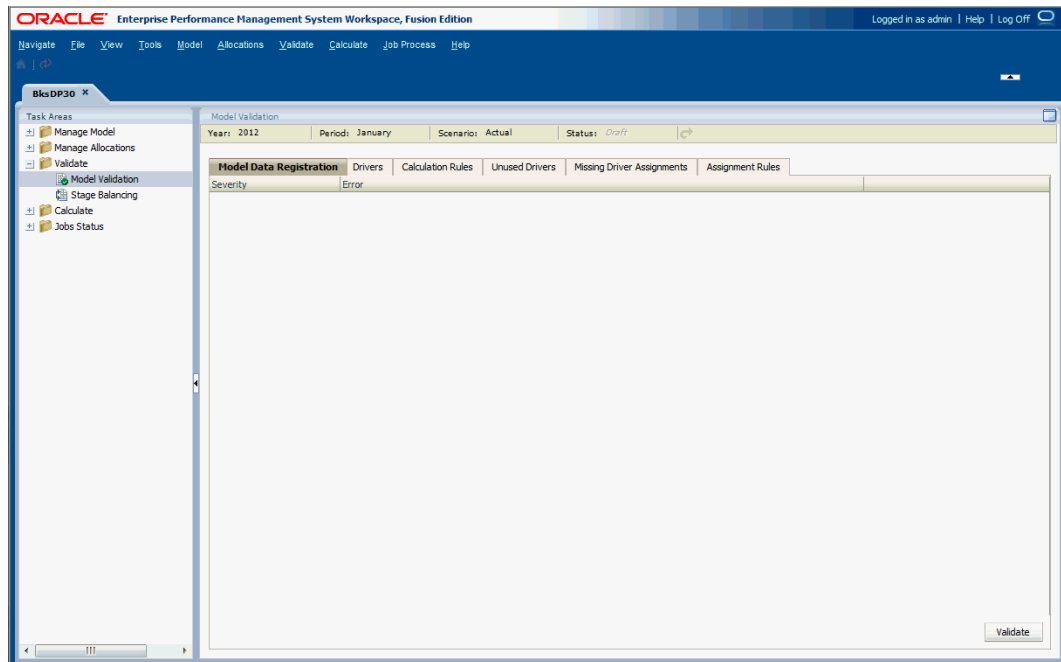

3. On the Model Validation screen, select the POV for the model to be validated and then click **Load the POV status** .
4. Click **Validate** on each of the following tabs to perform the validation:
 - Select **Model Data Registration** tab to see whether any column mappings or measures are incorrect. See [Registering Detailed Profitability Model Data](#).
 - Select **Drivers** tab to determine whether any errors exist for the drivers. See [Defining Detailed Profitability Drivers](#).
 - Select **Calculation Rules** tab to view any invalid calculation rules. See [Working With Calculation Rules](#).
 - Select the **Unused Drivers** tab to view any unassigned drivers in the model and to determine whether these drivers should be part of an assignment. See [Working with Detailed Profitability Drivers](#) to assign the driver, if required.
 - Select the **Missing Driver Assignments** tab to view all source intersections that are missing driver selections. See [Working with Detailed Profitability Drivers](#).
 - Select the **Assignment Rules** tab to view any invalid assignment rules. See [Working with Detailed Profitability Assignment Rules](#).

When the validation is complete, the screen is updated to reflect the results.

5. Correct all error or warning conditions on each tab.
6. When all errors on all tabs are corrected, repeat the model validation until no errors are detected.
7. When the validation is successful, calculate the model. See [Calculating Detailed Profitability Models](#).

Creating Detailed Profitability Reports

Related Topics

- [Detailed Profitability Stage Balancing Report](#)
After calculating the model, use the Stage Balancing Report to validate the results by balancing input values to account for any unassigned costs.
- [Detailed Profitability Level 0 Contribution Report](#)
A typical Detailed Profitability application may have one or more overlapping dimensions between the source and destination stages.
- [Running Detailed Profitability System Reports](#)
Following calculation of a Detailed Profitability model, you can run system reports.

Detailed Profitability Stage Balancing Report

After calculating the model, use the Stage Balancing Report to validate the results by balancing input values to account for any unassigned costs.

To generate the Stage Balancing report, the following conditions must be satisfied:

- Data must be loaded
- Model data must be registered and calculated

The Stage Balancing structure provides the following information:

Measure	Description
Stage Name	The name of the Source stage is displayed.
Input	This value is the Summary of the values associated with the Input balancing measure.
Total Output	The sum of all values assigned from the Source Stage. This value is associated with the AssignedPostStage balancing measure.
Idle	Input that is not assigned to the destination is the IdleCost value. Calculated results for IdleCost are assigned depending on the driver type: <ul style="list-style-type: none"> • For ratio-based drivers, if Allow Idle is selected, IdleCost is generated using the formula $\text{IdleDriverValue} / \text{OverrideTotalDriverValue}$. • For rate-based drivers, IdleCost is generated if the sum of allocates values is less than the source object's input value.
OverDriven	The OverDriven amount displayed on the Stage Balancing Report is the sum of all the calculated OverDriven values. This amount is associated with the OverDriven balancing measure.
Unassigned	The formula for the Unassigned values is equal to the following calculation: "Total IN" - "Total OUT" - "Idle" + "OverDriven"

For additional information on the Stage Balancing measures, see the following sections:

- [Idle Capability](#)
- [OverDriven Values](#)

- [Unassigned Values](#)
- [Generating the Detailed Profitability Stage Balancing Report](#)

Idle Capability

The terms *full capability* or *capacity* indicate that all model resources are being fully used to perform a task or assignment.

The terms *idle capability* or *idle capacity* indicate that some model resources are not being fully utilized. To maximize the use of resources, or to monitor inefficiencies, such as machine downtime, consider tracking idle capability.

Idle capacity is created by either Rate-Based or Ratio-Based drivers.

- Rate-Based drivers automatically create Idle and OverDriven where appropriate.
- Ratio-Based drivers only create Idle capacity when Allow Idle is checked.

You set the ability to calculate and report idle capability when you create or modify a driver, by selecting the Allow Idle option, and then selecting an `Override Total Driver Value Measure` to allocate the value. The `Override Total Driver Value Measure` is the location of the values that become the denominator of the Ratio for the distribution allocation.

See [Defining Detailed Profitability Drivers](#).

To view Idle Cost on the Stage Balancing Report, see [Generating the Detailed Profitability Stage Balancing Report](#).

OverDriven Values

Oracle Hyperion Profitability and Cost Management drives values from the source to the destination, using a combination of assignments that govern where to drive the value, and drivers that determine the amount that is being processed.

It is possible to drive more than the actual amount to the destinations. The OverDriven value is the amount that exceeds, or is "over" the actual amount that was driven from the source to the destination. OverDriven is reported as part of the Measures dimension.

To view OverDriven values on the Stage Balancing Report, see [Generating the Detailed Profitability Stage Balancing Report](#).

Unassigned Values

All values within a model should be assigned to a specific activity, product, account, and so on; however, some amounts may remain unallocated. These values are reported as Unassigned.

Depending on how a model is created, these unassigned values may be expected and acceptable, or they may represent an error in allocation that should be corrected. You need to determine where these amounts should be allocated. The Unassigned value is reported as part of the Measures dimension.

To view Unassigned values on the Stage Balancing Report, see [Generating the Detailed Profitability Stage Balancing Report](#).

Generating the Detailed Profitability Stage Balancing Report

To generate stage balancing reports:

1. Ensure the following conditions have been satisfied:
 - Model Data is registered
 - Model Data is loaded
 - Model is calculated successfully
2. From Oracle Hyperion Enterprise Performance Management Workspace, select **Navigate**, then **Applications**, then **Profitability**, and then select the application that you want to view.
3. In an open model, from **Task Areas**, select **Validate**, and then **Stage Balancing**.
4. On the Stage Balancing screen, select the POV for the model, and then click **Load the POV status** .
5. Select the type of Stage Balancing Report that you want to generate:
 - Click **Stage Summary** to view the summary of the balancing activity for the entire source stage.
 - From the **Source Measures Dimension Members** Selector, select a Source Measure to view the summary of the balancing activity for the selected Source Measure.
6. Click **Run** to generate the report.

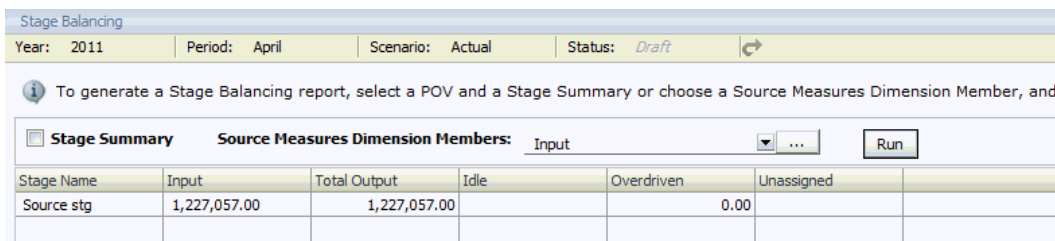

Stage Name	Input	Total Output	Idle	Overdriven	Unassigned
Source stg	1,227,057.00	1,227,057.00			0.00

7. Review the report, using one or more of these validations to verify the results:
 - Total Input – Total Output– Idle + OverDriven = Unassigned Values
 - Sum of all monetary or balance data loaded to the source stage = Input
 - Sum of unassigned values + Idle - OverDriven = Input
 - You can also launch some predefined Smart View integrations from the Stage Balancing screen. The launch data points are represented as hyperlinks in the Stage Balancing screen and present values that have been contributed from one stage to another. You can drill down further on input or allocation data. For example, you could drill-down into Unassigned costs after an allocation run, or to examine input data that was used in the same run.
8. **Optional:** To print the report, from the browser menu, select **File**, and then **Print**.

Example 21-1 Adding Destination Measures to the Report

Optionally, you can select Destination Measures from a popup dialog member selector. In that case, a Destination Measures table is added, which displays the summed values of measures from the destination table (Figure 1).

Figure 21-1 Detailed Profitability Stage Balancing Report with Destination Measures Table

The screenshot shows the 'Stage Balancing' application interface. At the top, it displays 'Year: 2012', 'Period: February', 'Scenario: Actual', and 'Status: Draft'. Below this is a 'Stage Summary' section with a 'Source Measures Dimension Members' dropdown and a 'Run' button. A table below shows 'Cost Profit' with values of 4,000,000 for Input and Total Output, and 0 for Side, Overblown, and Unassigned. The main part of the screenshot is a 'Destination Measure Balance' table with columns for Measures, Target, Assigned Values, and Calculated Measures. The table lists various measures like Extended List, Discounts, Sales Revenue, Materials Expense, Product Expense, Gross Margin, Sales Expense, Service Expense, Operating Expense, Net Profit, and Total, with their respective values in the Target, Assigned, and Calculated columns.

Measures	Target	Assigned Values	Calculated Measures
Extended List	12,000,000		
Discounts	3,700,000		
Sales Revenue	9,000,000		
Materials Expense	9,000,000		
Product Expense	500,000	500,000	
Gross Margin	4,500,000		4,500,000
Sales Expense	1,250,000	1,250,000	
Service Expense	2,250,000	2,250,000	
Operating Expense	3,500,000		3,500,000
Net Profit	1,000,000		1,000,000
Total	34,000,000	4,200,000	4,200,000

The first column shows all the measures selected. Their order enables the table to read like a Profit and Loss statement since the computations for calculated measures can follow the sequence of measures from top to bottom.

The second and third columns isolate the values of measures that were targets or assignments and calculated measures. This enables users to compare the sum of assigned values more easily to the stage balancing summary section. With this feature, users can emulate stage to stage balancing.

Detailed Profitability Level 0 Contribution Report

A typical Detailed Profitability application may have one or more overlapping dimensions between the source and destination stages.

For example, in the BksDP30 sample model, note that the Customer and the Product dimensions are used in both the Source stage and in the Destination stage.

This results in a Level 0 Contribution view (for example, HPMD_BKSDP20_LEVEL_0_CONTRIB_V for the sample model) which has two columns for each of these overlapping dimensions – one for the source context and one for the destination context.

In order to use this view to successfully generate a contribution report in Oracle BI EE, you must know how to properly register the system-generated dimension reporting views within the Physical Layer in OBIEE, so that each can join properly to both sets of dimension columns in the Level 0 Contribution view. Within the physical layer, you must create two alias tables from the Level 0 view to the same dimension. For example, Level 0 view must join to the Customer dimension once for the Source (SRC) and once for the Destination (DEST).

The following instructions use the hierarchy dimension view from the Customer dimension in the sample model as an example of how to do this.

Generating the Level 0 Contribution Report

To generate a Level 0 Contribution Report:

1. Log in to Oracle Business Intelligence Enterprise Edition, and navigate to the Profitability and Cost Management repository.
2. In the Physical Layer, right-click a dimension view that you want to use in the report, then select **New Object**, and then **Alias**.

For example, click **HPMD_BKSDP20_CUSTOMERS_HIER_V** in the Sample Model as the model for the Alias table.

3. Enter a name for the new Source Alias table (such as **HPMD_BKSDP20_SRCCUST_HIER_V**), and then click **OK**.
4. In the Physical Layer, right-click the dimension view again, then select **New Object**, and then **Alias**.
5. Enter a name for the new Destination Alias table (such as **HPMD_BKSDP20_DESTCUST_HIER_V**), and then click **OK**.
6. In the Physical Layer, select the following objects, then right-click and select Physical Diagram – Selected Objects Only:
HPMD_BKSDP20_SRCCUST_HIER_V
HPMD_BKSDP20_DESTCUST_HIER_V
HPMD_BKSDP20_LEVEL_0_CONTRIB_V
7. In the diagram, make physical joins between each of the new Alias tables and the Level 0 Contribution view.
8. Drag the Source and Destination Alias tables to the Business Model Layer.
9. In the Presentation Layer, modify the Level 0 Report to include columns from each of the new Alias tables.

For additional information on working with Physical Tables and Aliases, see the *Oracle Fusion Middleware Metadata Repository Builder's Guide for Oracle Business Intelligence Enterprise Edition 11g Release (11.1.1)*, Chapter 7: Working with Physical Tables, Cubes and Joins.

Running Detailed Profitability System Reports

Following calculation of a Detailed Profitability model, you can run system reports.

- **Dimension Statistics** — Number of dimension members, number of level 0 members, and number of hierarchy levels for each dimension in the current application.
- **Execution Statistics** — Runtime statistics collected for the selected Allocation Calc - Standard job following the end of the job

To generate a Detailed Profitability system report:

1. In an open Detailed Profitability model, in the **Reporting** task area, select **System Reports**.
2. In the **System Reports** screen, select one of the following for each setting:
 - **Report Name** — **Dimension Statistics**, **Execution Statistics**

- **Output Type** — PDF (Adobe PostScript), Microsoft **EXCEL**, Microsoft **WORD**, **XML**, **HTML**
3. Enter the **Job Id** from the **Job Library** task area for **Execution Statistics** reports.

 **Note:**

Dimension Statistics reports do not require **Job Id** or other parameter information.

4. Click **Run**.
5. Indicate whether to open or save the report.

See these sections to review report examples:

- [Figure 1](#)
- [Figure 1](#)

Detailed Profitability Dimension Statistics Report Example

Dimension Statistics reports show the number of dimension members, number of level 0 members, and number of hierarchy levels for each dimension in the current application. Potential values are possible mathematical combinations that might not all be used (similar to [Figure 1](#)).

Figure 21-2 Example of a Detailed Profitability Dimension Statistics Report

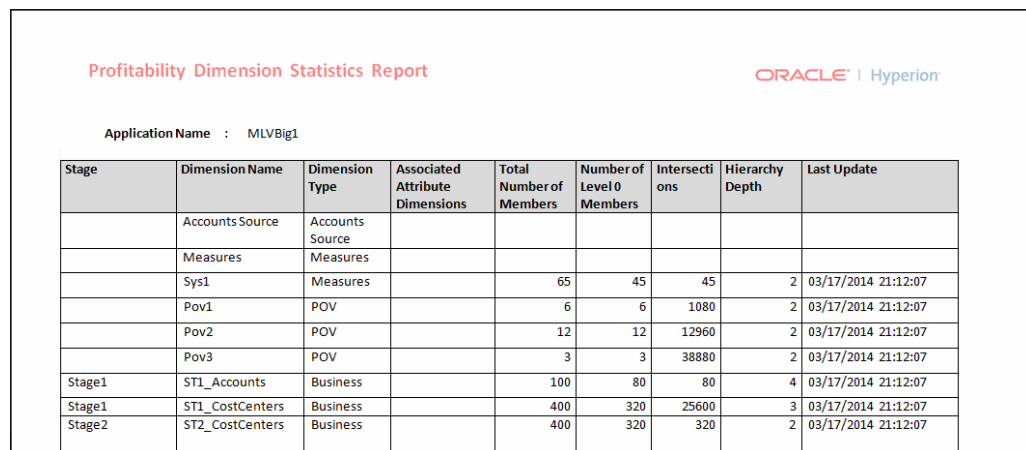

Stage	Dimension Name	Dimension Type	Associated Attribute Dimensions	Total Number of Members	Number of Level 0 Members	Intersections	Hierarchy Depth	Last Update
	Accounts Source	Accounts Source						
	Measures	Measures						
	Sys1	Measures		65	45	45	2	03/17/2014 21:12:07
	Pov1	POV		6	6	1080	2	03/17/2014 21:12:07
	Pov2	POV		12	12	12960	2	03/17/2014 21:12:07
	Pov3	POV		3	3	38880	2	03/17/2014 21:12:07
Stage1	ST1_Accounts	Business		100	80	80	4	03/17/2014 21:12:07
Stage1	ST1_CostCenters	Business		400	320	25600	3	03/17/2014 21:12:07
Stage2	ST2_CostCenters	Business		400	320	320	2	03/17/2014 21:12:07

Detailed Profitability Execution Statistics Report Example

Execution Statistics reports show runtime statistics collected for the selected Detailed Calculation job type following the end of the job (similar to [Figure 1](#)).

Figure 21-3 Example of a Detailed Profitability Execution Statistics Report

Profitability Execution Statistics Report				ORACLE Hyperion				
Application Name :	BksDP30							
Point Of View :	Year : Period : Scenario							
	2010 : January : Actual							
Statistics Source :	Model Calculation							
Job Id :	2356							
Job Type :	Detailed Calculation							
Job Status :	Success							
Start Time :	13-MAY-14 03.36.18.211000000 AM							
End Time :	13-MAY-14 04.02.50.354000000 AM							
User Name :	admin							
Calculation Rule Summary Statistics								
Rule Name	Rule Type	Driver Type	Uses Same as Source?	Start Time	End Time	Elapsed Time	Execution Steps	Destination Updates
Warehouse Support Exceptions	Single-source	Mixed	No	01:40:00	02:15:31	00:35:31	150	30,101,228
Warehouse Support	Multi-source	Ratio	Yes	02:15:33	02:30:45	00:15:12	42	3,671,245
Customer Support	Multi-source	Rate	No	02:30:46	03:10:48	00:40:02	10	115,000,007
Tax Expense	Multi-source	Ratio	No	03:10:50	03:17:22	00:06:32	1	11,071,501
Profit Calculation	Calculated Measure	Calculated Measure	No	03:17:23	03:19:35	00:02:12	1	11,071,501
Summary				01:40:00	03:19:35	01:39:35	204	170,915,482

Monitoring Detailed Profitability Job Status

Related Topics

- [Job Library](#)
The Job Library lists all currently submitted or scheduled jobs for all models and all users for Detailed Profitability applications.
- [Managing Detailed Profitability Task Flows](#)
Task flows automate business processes, in whole or part. Tasks are passed from one taskflow participant to another, according to a set of procedural rules
- [Viewing Detailed Profitability Task Flow Information](#)
The Taskflow Listing Summary shows the existing task flows for the selected application and provides basic details for each one.
- [Viewing Detailed Profitability Task Flow Status](#)
In the Taskflow Status Summary screen, you can view and update the status of existing task flows.
- [Viewing Detailed Profitability Task Details](#)
You can view the details for an existing task flow using the Task Details option.
- [Scheduling Detailed Profitability Task Flows](#)
You can schedule the running of a task flow on a one-time or recurring basis.

Job Library

The Job Library lists all currently submitted or scheduled jobs for all models and all users for Detailed Profitability applications.

Click any column in the Job Library to sort the jobs by Start Date and Time, Application Name, Job Type, Comment, User, Task Flow ID, or Status Message. Click again to reverse the sort.

Job Library Job Types

There are four job types that may be processed, and the Job Details information on the Job Library changes, depending on the Job Type:

- **Allocation Calc**
 - Job Details: Processing Options, custom scripts, and model and data POV's
 - Job Finished: Date and time that the job is finished
 - ODL Task ID

See the Manage Calculation tab in [Managing Detailed Profitability Calculations](#).
- **Apply Bulk Edit**
 - Job Details: POV and Edit Selections (Source rules and Destination drivers or Destination rules)

- Job Finished: Date and time that the job is finished
- ODL Task ID

See [Working with the Bulk Editor](#).

- **Copy POV**

- Job Details: Copy POV, showing the Source and Target POVs that were selected, and the Copy Configuration
- Staging Table Selections for the import
- Job Finished: Date and time that the job is finished
- ODL Task ID

See [Copying POVs](#).

- **Import Staging Tables**

- Job Details: Import configuration
- JDBC Connection
- Staging Table Selections for the import
- Job Finished: Date and time that the job is finished
- ODL Task ID

See [Importing Detailed Profitability Staging Tables](#).

Viewing the Job Library

To view the Job Library:

1. From Oracle Hyperion Enterprise Performance Management Workspace, select **Navigate**, then **Applications**, then **Profitability**, and then select the application for which jobs have been submitted.
2. In an open model, from **Task Areas**, select **Jobs Status**, and then **Job Library**.
3. Under **Job Listing**, view the information for each job:
 - **Start Date/Time** displays the date and time on which the job was submitted or is scheduled to be run.
 - **Application** displays the name of the application for which the task is being run.
 - **Job Type** displays the type of task that is being performed. See [Job Library Job Types](#)
 - **Comment** shows a user-entered note or details about that specific job, such as Initial Run, Bulk Edit or Add Drivers. The Comment is entered when the task is submitted.
 - **User** identifies the User ID of the individual who submitted the task for processing.
 - **Task Flow ID** is the system-generated task ID for the specific task, displayed in the format *<application name>:<task name><generated taskflow number>*.

For example, the generated taskflow number may be displayed as **Demo04_RunCalcs_D20111103T183447_fbe**, where **Demo04** is the application name, **RunCalcs** is the task, and **D20111103T183447_fbe** is the

generated taskflow instance ID. See [Managing Detailed Profitability Task Flows](#).

- **Status** displays a message about the current state of the taskflow, such as Running, Success or Failure.
 - **Errors**
 - **Warnings**
4. **Optional:** Under **Job Details**, review the job options that were used for the execution of the highlighted job. The format of the details changes depending on the job type highlighted. The Processing Options, Custom Scripts, and POV options are displayed as applicable.

For additional information, see [Job Library Job Types](#).

5. **Optional:** Use the Find text box at the bottom of each column to locate a job by entering text in the Find field attached to the column in which it resides. See [Using the Find Feature](#).
6. Under **Job Finished**, view the date and time that the highlighted task was completed.
7. Under **ODL Task ID**, view the ID for the highlighted job to assist in locating error or warning messages in `hpcm.log`.

In the `hpcm.log` file, use Find and the ODL Task ID to locate the start of the logging detail text for the selected job. After locating the start of the log entries, you can search down to find an "ERROR" in the file.

8. **Optional:** If required, click **Stop Job** to end the highlighted task in Running state.

 **Caution:**

While the task flow stops quickly after the button is pressed, activities that affect results may require additional time to ensure that the state of the data is consistent.

For detailed instructions on using EPM Workspace taskflows, see the *Oracle Hyperion Enterprise Performance Management Workspace User's Guide*.

Managing Detailed Profitability Task Flows

Task flows automate business processes, in whole or part. Tasks are passed from one taskflow participant to another, according to a set of procedural rules

. In Detailed Oracle Hyperion Profitability and Cost Management, task flows are created in these circumstances:

- Staging tables are imported
- POV data is copied
- Calculations are run
- Bulk Edit feature has been used to create or remove model elements
- Cube Deployment
- Create Application

- Duplicate Application
- Pre Update Analysis
- Update Dimensions
- Delete Application



Note:

Task flows are not available when validating the model contents or structure.

A task flow ID is automatically generated for each task. Every time you run a task, a new task ID is generated. A task flow can include one or more steps. Each task flow step represents one action in Profitability and Cost Management.

When you initiate a task flow, a task flow step is created and a task flow ID is assigned (for example, 'Demo04_RunCalcs_D20111103T183447_fbe'). The ID enables you to monitor the progress of the task flow. A new Task flow ID is created each time you initiate a task flow instance. If a is interrupted or restarted, it always begins again at step 1.

Each task flow step is executed in sequence, beginning with the first step. When the results for one step are completed, the next step is initiated. Status is only complete when all steps in the task flow have been performed.

Use the Job Status options under Task Areas to view the task flow status and details, or to schedule the running of the task flow on a one-time or recurring basis.

To access the Job Status monitoring option, the following conditions must be satisfied:

- Profitability and Cost Management must be configured to use external authentication and Oracle Hyperion Shared Services functionality. See the *Oracle Enterprise Performance Management System Installation and Configuration Guide*.
- Task flow users must be assigned one of the following Shared Services roles to perform task flow operations:
 - Manage Task flows—Permits users to create and edit task flows.
 - Run Task flows—Permits users to only run and view task flows. Users with this role cannot create or edit task flows.



Note:

Both Shared Services roles are global user roles. Users assigned these roles can either modify or run task flows for any application and product. See the *Oracle Enterprise Performance Management System User Security Administration Guide*.

 **Caution:**

Although you can add or remove steps and links and create new task flows from the Taskflow screens, Oracle recommends that you do not modify Detailed Profitability and Cost Management task flows. For additional information on using Oracle Hyperion Enterprise Performance Management Workspace task flows for other products, see the *Oracle Hyperion Enterprise Performance Management Workspace User's Guide*.

Viewing Detailed Profitability Task Flow Information

The Taskflow Listing Summary shows the existing task flows for the selected application and provides basic details for each one.

To view task flow information:

1. From Oracle Hyperion Enterprise Performance Management Workspace, select **Navigate**, then **Applications**, then **Profitability**, and then select the application for which jobs have been submitted.
2. In an open model, from **Task Areas**, select **Jobs Status**, and then **Manage Task Flow**.

The Summary displays this information for each taskflow that exists for the selected application:

- **Application** displays the application name.
- **Taskflow** displays the generated task flow number in the format *<application name>:<task name><generated taskflow number>*.
- **Created By** displays the ID of the user who created the task flow.
- **Description** provides a brief explanation of the task.

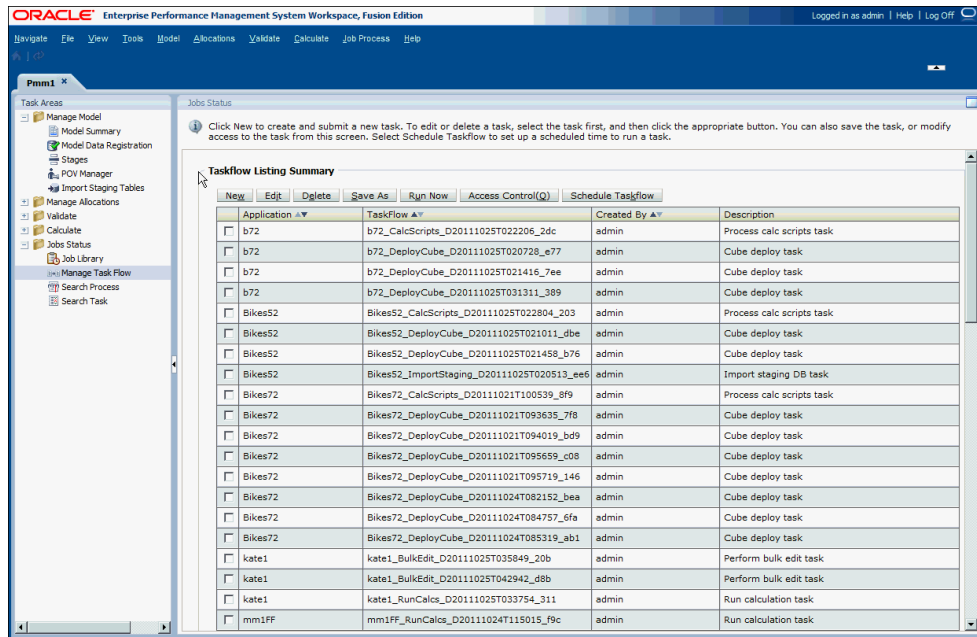

3. **Optional:** Click the radio button beside a task flow, and then click **Schedule Taskflow** to schedule the running of the task for a more convenient time or date.
4. Use the Task flow Listing Summary screen to perform various actions, such as deleting a task flow or scheduling the run of a task flow. For detailed instructions on using EPM Workspace task flows, see the *Oracle Hyperion Enterprise Performance Management Workspace User's Guide*.

Viewing Detailed Profitability Task Flow Status

In the Taskflow Status Summary screen, you can view and update the status of existing task flows.

You can also filter the task flow list to display task flows with a specified status or date range.

A participant ID is created for each generated step in the task flow. You can drill down on an individual task flow to view details of the associated participant summary.

To view task flow status:

1. From Oracle Hyperion Enterprise Performance Management Workspace, select **Navigate**, then **Applications**, then **Profitability**, and then select the application for which jobs have been submitted.
2. In an open model, from **Task Areas**, select **Jobs Status**, and then **Search Process**.

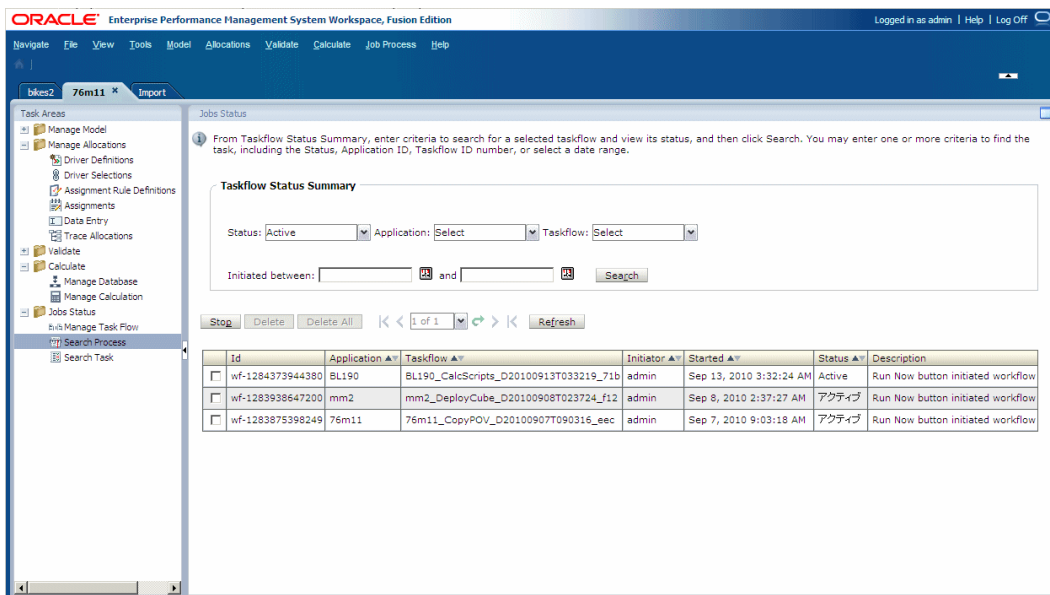

3. Select one or more search criteria to locate the task flow:

a. Under **Status**, select a status of the task flow:

- Active
- Done
- Stopped
- All

b. Under **Application**, select an Application ID.

c. Under **Taskflow**, select a Taskflow ID.

d. For **Initiated Between**, click **calendar** , and then select a start and end date for the search range.

 **Note:**

Depending on the requirements, you may leave all search fields blank to display all taskflows, or make the search as specific as possible to narrow the results.

4. Click **Search**.

The search results are displayed at the bottom of the screen:

- ID (This is the participant ID, which is automatically generated for the taskflow.)
- Application ID
- Taskflow ID
- Initiator of the task flow
- Time that the task flow began running
- Current Status of the task flow

- Description of the taskflow
5. **Optional:** Click **Refresh** to update status information.
 6. **Optional:** To end the currently running step of a multistep taskflow, select the checkbox beside the appropriate taskflow, and click **Stop**.

The taskflow stops when the application returns the results of the selected step. The results for previous steps are not discarded; however, if you rerun the taskflow, it begins at the first step.
 7. **Optional:** To view details of a taskflow and its status, double-click the taskflow name.

The Taskflow Participant Summary is displayed, showing details of the task and its status.
 8. Click **Cancel** to return to the Taskflow Status Summary.

Viewing Detailed Profitability Task Details

You can view the details for an existing task flow using the Task Details option.

A new task ID is generated each time you run a task.

To view task details:

1. From Oracle Hyperion Enterprise Performance Management Workspace, select **Navigate**, then **Applications**, then **Profitability**, and then select the application for which jobs have been submitted.
2. In an open model, from **Task Areas**, select **Jobs Status**, then **Search Task**.

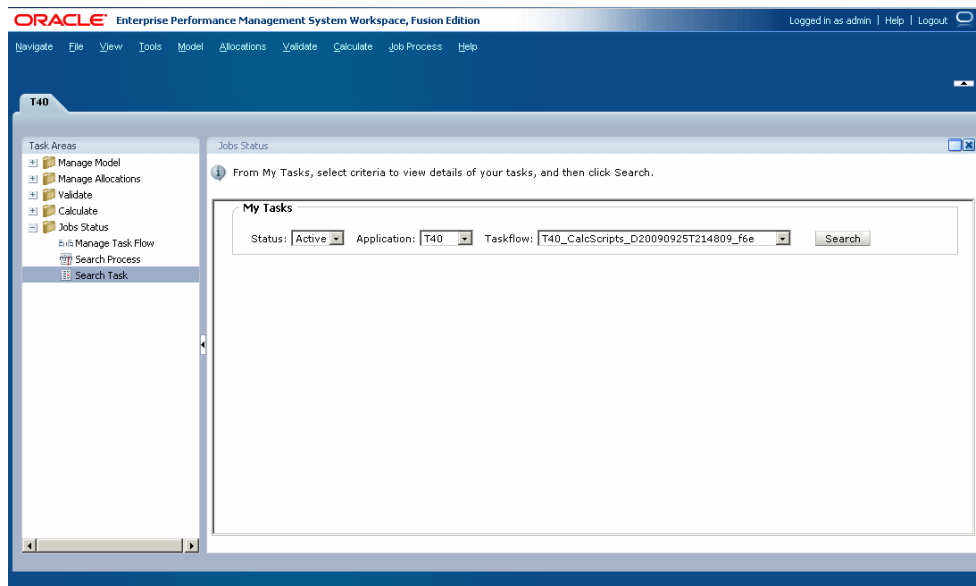

3. On **My Tasks**, select one or more search criteria to locate the task flow:
 - a. Under **Status**, select a status, such as **New**, **Active**, **Done**, or **All**.
 - b. Under **Application**, select an Application ID.
 - c. Under **Taskflow**, select the generated Taskflow ID.

 **Note:**

Depending on the requirements, you may leave all search fields blank to display all taskflows, or make the search as specific as possible to narrow the results.

4. Click **Search**.
The results of the search are displayed.
5. **Optional:** Use the forward and back arrows to scroll through the results. The current page in the sequence and the total number of pages are displayed.
6. **Optional:** Click **Refresh** to update status information.
7. Select a task flow, and then click **View Status**.
The Taskflow Participant Summary is displayed, showing details of the job and current status for the selected step in the taskflow.
8. Click **Cancel** to return to the Job Status screen.

Scheduling Detailed Profitability Task Flows

You can schedule the running of a task flow on a one-time or recurring basis.

 **Note:**

If you want to schedule the task flow, you must have selected the "Run Later" option when you created the task.

To schedule task flows:

1. From Oracle Hyperion Enterprise Performance Management Workspace, select **Navigate**, then **Applications**, then **Profitability**, and then select the application for which jobs have been submitted.
2. In an open model, from **Task Areas**, select **Job Status**, and then **Manage Task Flow**.

The Taskflow Listing Summary screen displays the following information for each existing task flow.

- **Application** displays the application name.
- **Taskflow** displays the generated task flow number in the format *<application name>:<task name><generated taskflow number>*.
- **Created By** displays the ID of the user who created the task flow.
- **Description** provides a brief explanation of the task.

 **Note:**

A new task ID is generated each time you run a task.

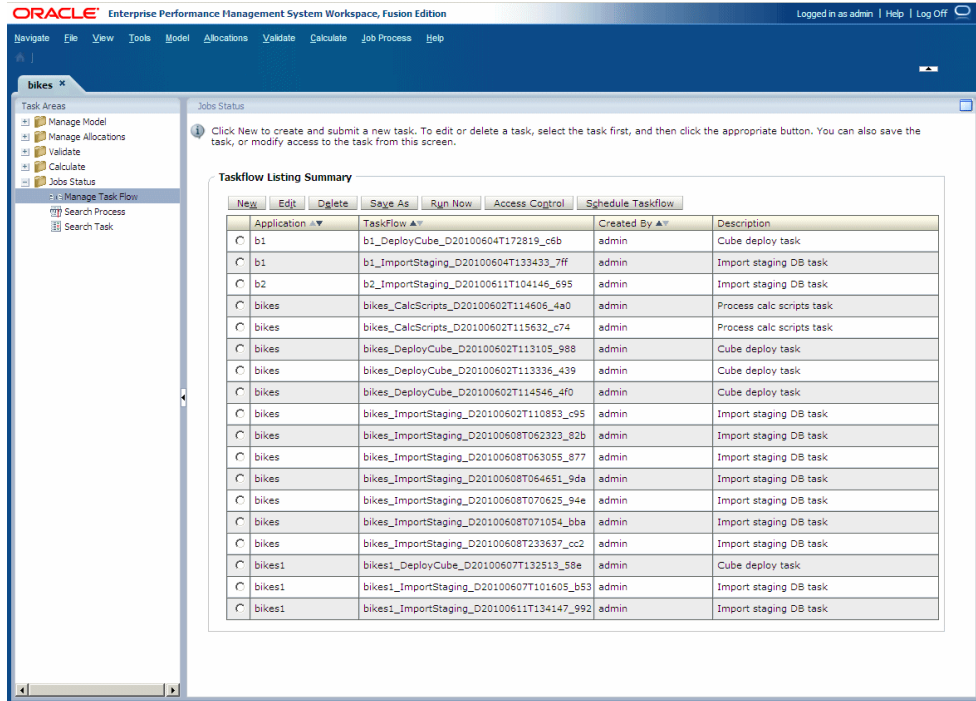

3. Select the checkbox beside the task flow for which you selected the "Run Later" option when creating the task.
4. Click **Schedule Taskflow**.

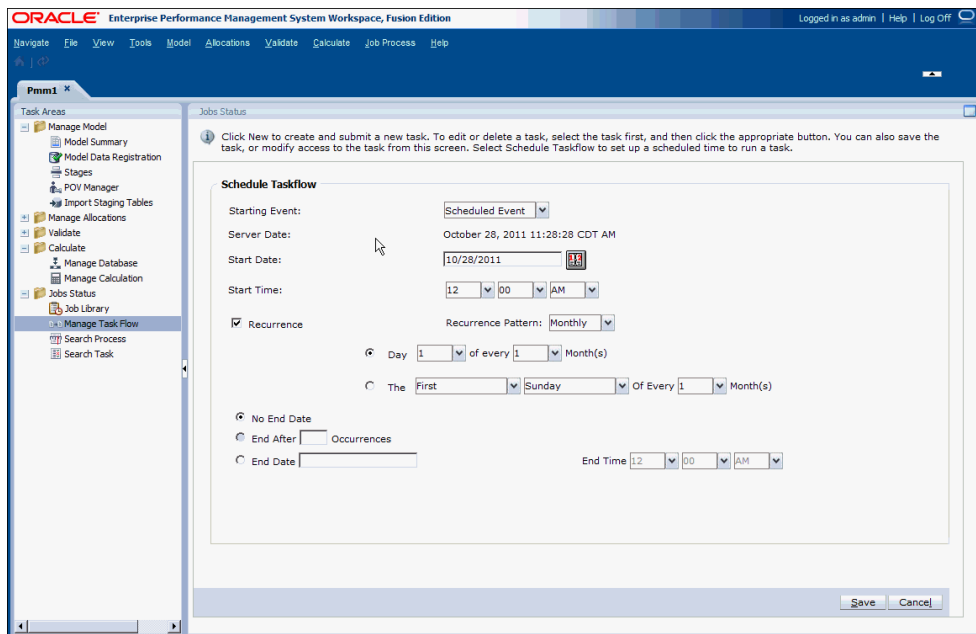

5. Under **Starting Event**, select **Scheduled Event**.
The Server Date is displayed.

6. Under **Start Date**, click **calendar**  to select the date on which the task flow is scheduled to run.
7. Under **Start Time**, use the drop-down lists to select the time at which the task flow is scheduled to begin.
You must select the hour and minutes, and whether the runtime is set for AM or PM.
8. **Optional:** To schedule jobs to run on a recurring basis:
 - a. Select **Recurrence**.
 - b. Under **Recurrence Pattern**, select a frequency, such as Monthly, Weekly, and so on.
 - c. Select a recurrence pattern, and enter the required variables, as indicated in the following examples:
 - Day x of every x Month(s)
 - The x *day* of Every x Month(s)
9. **Optional:** To schedule the task flow to run until it is manually cancelled or deleted, select **No End Date**.
10. **Optional:** To schedule the task flow to run a specified number of times, select **End After x Occurrences**. In the text box, enter the number of times the job is to be run.

 **Note:**

This option is available only if a Recurrence schedule of Daily or Weekly is selected.

11. **Optional:** To run the task flow until a specified date, select **End Date**, and select the date and time of the final run:
 - a. Under **End Date**, click **calendar**  to select a date.

 **Note:**

Calendar is displayed when the End Date option is selected.

- b. Under **End Time**, select the time of the last run. You must select the hour, minute, and whether the time is set for AM or PM.
12. Click **Save** to save the scheduled job.
The task flow runs as scheduled.

A

Working with Standard Profitability and Cost Management Applications

This appendix applies to Oracle Enterprise Performance Management System versions 11.2.0 through 11.2.15 only because EPM System version 11.2.16 does not support Standard Oracle Hyperion Profitability and Cost Management applications.

For customers on a version older than 11.2.16, this appendix provides information on working with Standard Profitability and Cost Management applications.

In this appendix

- [Getting Started with Standard Profitability and Cost Management](#)
- [About Standard Profitability Models and Scenarios](#)
- [Dimensions in Standard Profitability Applications](#)
- [Managing Standard Profitability Models](#)
- [Managing Standard Profitability Allocations](#)
- [Validating Standard Profitability Models](#)
- [Calculating Standard Profitability Models](#)
- [Monitoring Standard Profitability Job Status](#)
- [Running Standard Profitability Reports](#)
- [Managing Smart View Queries in Standard Profitability](#)

Getting Started with Standard Profitability and Cost Management

Related Topics

- [Architecture](#)
Oracle Hyperion Profitability and Cost Management runs on top of Oracle Essbase and uses other related software to handle and calculate a variety of data.
- [Modeling Process](#)
Before you can build a model, the dimensions and members must be defined using the Profitability Applications Console to build the database outline, or main objects within each stage of the model.
- [Launching Profitability and Cost Management](#)
- [About Standard Profitability and Cost Management Applications](#)
A Standard Oracle Hyperion Profitability and Cost Management model enables you to monitor and control direct contribution data for the entire model.

- [Comparison between Standard and Detailed Profitability Applications](#)
The type of application that you select depends on the type of modelling that you require to effectively manage your organization's models.
- [Common Tasks](#)
- [About Profitability and Cost Management Dimensions](#)
Oracle Hyperion Profitability and Cost Management uses dimensions and members created in the Profitability Applications Console to represent many of the structural elements of the business model in an Oracle Essbase application outline.

Architecture

Oracle Hyperion Profitability and Cost Management runs on top of Oracle Essbase and uses other related software to handle and calculate a variety of data.

The following figure shows architecture for Standard Profitability and Cost Management models.

Figure A-1 Standard Profitability and Cost Management Product Architecture

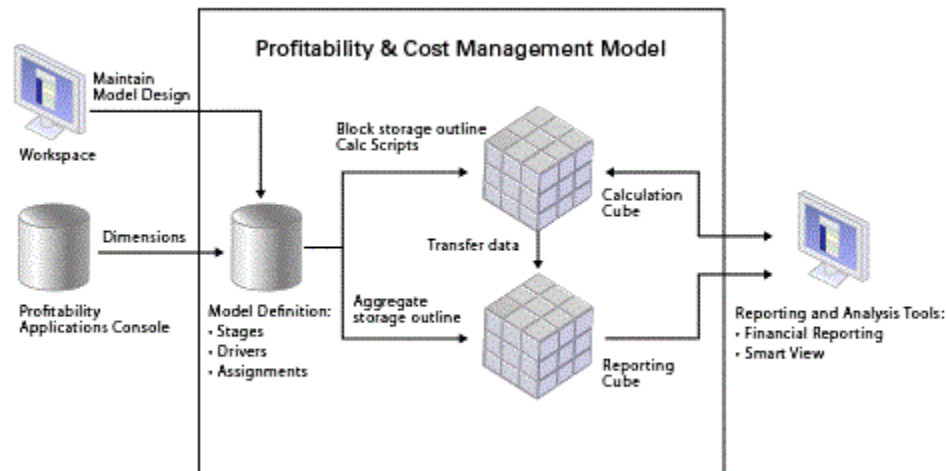

Modeling Process

Before you can build a model, the dimensions and members must be defined using the Profitability Applications Console to build the database outline, or main objects within each stage of the model.

The financial and other data required for allocation are imported to an Oracle Essbase multidimensional database for Management Ledger.

Requirements analysis is an important part of designing applications and models. See these information sources:

- [Steps to Create Standard Profitability Models](#) for a more detailed overview of the modeling process.

- [Modeling Process](#)

Launching Profitability and Cost Management

Oracle Hyperion Profitability and Cost Management can be accessed only through Oracle Hyperion Enterprise Performance Management Workspace.

To access Profitability and Cost Management:

1. Ensure the following software components have been configured, started and are running:

- EPM Workspace
- Oracle Hyperion Shared Services
- Profitability and Cost Management
- Oracle Essbase, for Standard Profitability applications only

Contact the Administrator for assistance if any other required software is not available.

2. In the Web browser, access the EPM Workspace Web page.

By default, the URL is `http://SERVER_NAME:19000/workspace/`.

 **Note:**

If the installation is customized, the port number may change.

3. Enter the EPM Workspace user name and password.

 **Note:**

Both the user name and password are case-sensitive.

4. Click **Log On**.

The main EPM Workspace page is displayed.

5. On the EPM Workspace main menu, select **Navigate**, then **Applications**, then **Profitability**, and then select the model you want to view.

About Standard Profitability and Cost Management Applications

A Standard Oracle Hyperion Profitability and Cost Management model enables you to monitor and control direct contribution data for the entire model.

The input amounts, the flow of cost and revenue and final destination of the funds can be tracked for both cost and revenue to ensure that resources are used to best advantage and profitability can be easily demonstrated. Calculation results are posted to individual cost centers or accounts.

Data for the Standard Profitability and Cost Management model is housed in both Oracle Essbase multidimensional databases and relational databases. You create the model in the Profitability Applications Console, and define the hierarchy of accounts, activities, and

operations within the organization using dimensions and dimension members. An AllocationType dimension is imported from the Profitability Applications Console. This dimension is used to correctly allocate costs and revenue, and store direct allocations and allocation genealogy.

After the application is deployed to Standard Profitability and Cost Management, you build the model, creating the drivers and assignments that generate the flow of funds to specific cost and revenue allocations. The models are constructed using up to nine stages, with up to three dimensions per stage. The allocations for each stage are passed to the next stage based on calculations and formulas that you specify in the drivers and assignments. To mirror the reality of the flow in the organization, the allocations may pass between stages (interstage), skip stages, or include allocations that are iterative within the same stage (inrastage).

Points of View (POVs) represent a specific instance of the model, and can be used to view or calculate different versions of a model; for example, to view values for different months or quarters, to compare budget versus actual figures, or to play scenarios to measure the impact of various changes on the bottom line.

The model is validated after creation to ensure that all allocations are have been accounted for, and calculations are balanced for each stage.

You deploy the Calculation and Reporting databases, and then calculate the model, and analyze the results.

For information about creating and working with Standard Profitability applications, see [Overview of Standard Profitability Models](#).

Comparison between Standard and Detailed Profitability Applications

The type of application that you select depends on the type of modelling that you require to effectively manage your organization's models.

The following table compares features and abilities of two types of Oracle Hyperion Profitability and Cost Management applications:

- Standard Profitability
- Detailed Profitability

Depending on the application, you may use one or the other.



Note:

For a description of the third type of application, Management Ledger Profitability, see [Management Ledger Profitability and Cost Management Applications](#).

Table A-1 Comparison between Standard and Detailed Profitability Applications

Feature Area	Standard	Detailed
General Application Information		
Primary Use	Cost Development	Cost and Revenue Application
Focus	Contribution analysis	Profitability analysis

Table A-1 (Cont.) Comparison between Standard and Detailed Profitability Applications

Feature Area	Standard	Detailed
Database	Oracle Essbase and Relational databases	Relational database only. The pre-existing customer database is mapped to Detailed Profitability
Volume of Target Objects	Hundreds of thousands to millions of unique targets as defined by dimension intersections in the target model stages. Practical limits are based on dimension sizes, with dimensions larger than 25,000 members considered to be very large.	Millions to hundreds of millions of unique targets as defined by row count in the target table. Practical limits are not bounded by dimension sizes because the target row is not required to be defined by a unique intersection of dimensions.
Allocations		
Type of Allocation	Multi-Step allocations For example, you can follow allocations from department to department, department to activity, product and so on.	Single step allocation of pools or rates to profit objects May use data from Multi-Step Standard model or external data
System Dimensions	Measures AllocationType	MeasuresDetailed
Genealogy Allocations	Yes	No
Trace Allocations	Yes	No
Intrastage Allocations	Yes	No
Reciprocal Allocations	Yes	No
Model Building		
Stages	Up to nine stage, with up to 3 dimensions in each stage	Only two stages: <ul style="list-style-type: none"> • Source - Up to 5 Source Dimensions • Destination - Up to 25 Destination Dimensions
Model Layers	Cost and Revenue	No
Data Entry	Yes	No
Pre-Defined Driver Measures	Yes	No
Driver Data Report	Yes	No

Common Tasks

Related Topics



- [Using the Common Member Selector](#)
- [Sorting Columns](#)
- [Using Tree and Grid View Modes](#)
- [Using Filters](#)
- [Using the Find Feature](#)

Using the Common Member Selector

The Common Member Selector enables you to quickly select and filter dimension members. The selector dialog box is available from several locations within the application, including Driver Selections.

The name of the selected dimension is listed at the top of the selector dialog box, and all available members for the selected dimension are listed in a tree or grid format.

To select members from the Common Member Selector:

1. From the application, click **Selector**  or **Add** .

The Select Member dialog box opens, showing all available members.

2. Expand the member list, and select the member.

To search for a member, type the member name in the text box at the bottom of the dialog box and click the Search button .

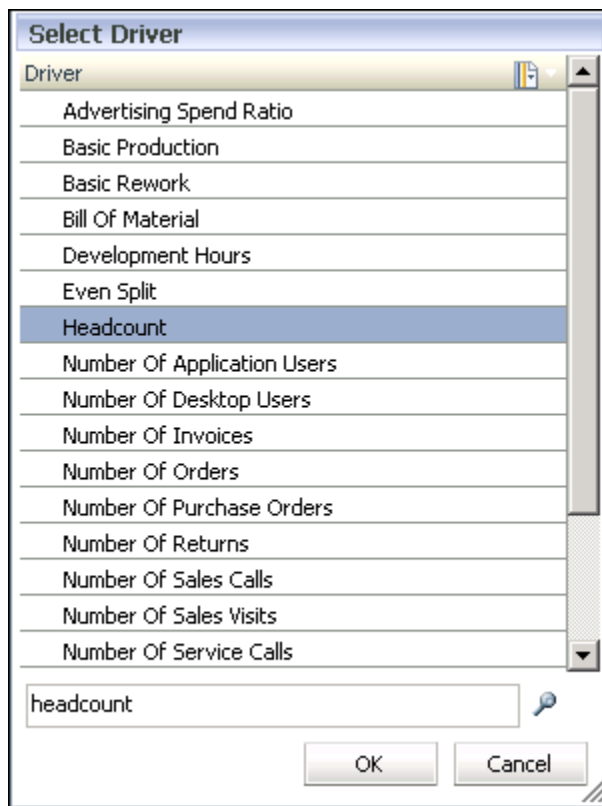

3. **Optional:** To filter or modify the display of members, click **Context Menu** , and select one or more options:
 - **Show Tree** displays members for the selected dimension in an expandable hierarchy.
 - **Show Grid** displays all members for the selected dimension in a flat, sequential list. This view mode must be selected if you want to filter members.

- **Show Alias** displays the member aliases, or alternate names for members and shared members.
- **Show Name** displays the member names.
- **Filter** is used to filter members.
- **Sort** to select the filter to display the members in ascending, descending or default order.

See [Using Filters](#).

4. Click **OK**.

The selected member is displayed in the required field.

Sorting Columns

Depending on the screen you are viewing, two methods are available for sorting columns:

- Using the Member Selector (on the Driver Definitions, Driver Selections, Assignments, and Data Entry screens)
- Clicking the column header (Assignments Destinations, Driver Exceptions tab, and Manage Task Flows)

To sort using the Member Selector:

1. On the screen, click the Member Selector  at the top of the column that you want to sort.

2. From the drop-down list, select **Show Grid**.

This step removes the hierarchical format to enable sorting.

3. On the screen, click the Member Selector  again, and choose the sort option that you require:

- Ascending (from lowest to highest)
- Descending (from highest to lowest)
- Default (as displayed in the Oracle Essbase database)

The list is redisplayed using the selected sort option.

To sort using the Column Header:

1. On the screen, double-click the column header to display the sort icon:

- **Ascending sort** 

- **Descending sort** 

2. Double-click the column header to toggle between sort options.

Using Tree and Grid View Modes

When editing data, you can toggle between two viewing modes to view dimensions and their members:

- Tree View displays dimensions and members in an expandable hierarchy.

A
A1
A11
A12
A13
A14

- Grid View displays the Level 0 members for the selected dimension in a sequential list. The Grid View mode is required to filter dimension members, drivers or measures.

A
A11
A12
A13
A14

To change view modes:

1. At the top of the dimension column on the data entry screen, click **Context Menu**  for the dimension for which you want to change the view mode.
2. Select the required view mode:
 - Select **Show Tree** to display dimensions and their members in an expandable hierarchy.
 - Select **Show Grid** to display the Level 0 members for the selected dimension in a sequential list. The Grid View mode is required to filter dimension members, drivers, or measures.

Using Filters

Filters are available to refine long lists of members to present only those that meet the filter criteria. The Filter is available on screens that require selections from multiple options, such as Driver Selections, Assignments, Data Entry, and so on.

- When entering a search value in a filter, enter the entire string if the filters are Attribute-based or UDA-based.
- If you require a wildcard at the beginning of a filter, only question marks can be used, as in "?ac".
- Trailing wildcard symbols, such as asterisks (*) and question marks (?) are supported in assignment rule name and alias filters. For example, enter "B*" to filter members having names or aliases beginning with the letter "B".

 **Note:**



You cannot use an asterisk at the beginning or within a filter for assignment rules, such as "*B" or "B*a".

Using the Filter dialog box, you build the filter in this format:

<Member Name> <Operation> <Value> <Condition>

If the filter contains more than one statement, the Condition appends additional statements using an AND or OR condition. Brackets for each statement are automatically inserted, and the filters are resolved from left to right.

To filter dimensions and members:

1. Click **Member Selector** .
 2. On the Filter drop-down list, select **Show Grid**.
The list is changed to a grid format, and the Filter option is activated.
 3. On the Filter drop-down list, select **Filter** .
- The Filter dialog box is displayed.

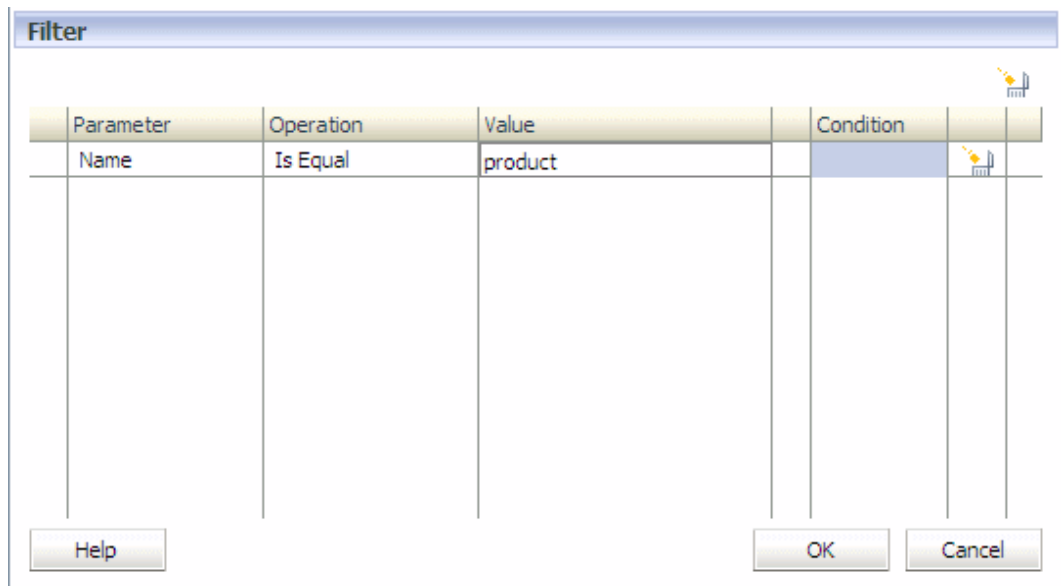

4. Under **Parameter**, click the cell to display the drop-down list of available parameters, and select the parameter to be filtered:
 - **Name:**
 - Displays Member Name if "Show Name" mode is selected.
 - Displays Alias Name if "Show Alias" mode is selected.

 **Note:**

For Assignment Rules, Standard Profitability "Name" filter matches criteria both on name and alias simultaneously.

- **Attribute** (Attribute, if available)
 - **UDA** (User-Defined Attribute, if available)
5. Under **Operation**, select the appropriate filter:
- **Is Equal**
 - **Not Equal**

 **Note:**

Both the EQUAL and NOT EQUAL operations are currently supported to filter Names, Aliases and Attributes.

Only the Is Equal operation is currently supported for UDAs.

When "Name" is selected as the parameter, matching is performed on both names and aliases.

6. Under **Value**, click the cell and select the filter value:
- For **Name**, enter the value or text. Matching is performed on both names and aliases.
 - For **Attributes** or **UDA** dimensions, select the member from the drop-down list of values for the selected Attribute or UDA dimension.
7. **Optional:** If more than one filter statement is to be added, under **Condition**, select the condition governing the filter:
- AND
 - OR
8. **Optional:** Repeat for each additional filter.
9. Click **OK**.

The filter is applied to display only those members that meet the filter criteria.

Using the Find Feature

The Find feature enables you to locate a single member in a list of members.

The Find feature is available on screens that require selections from multiple options, such as Driver Definitions, Driver Selections, Assignments, Data Entry, and so on. Each Find field is attached to the column in which it resides and can be used only in one column at a time.

To find a member:

1. Enter the member name in the Find text box at the bottom of the column.
You can enter a partial name.

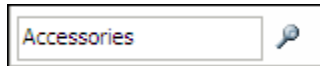

2. Click the Search button 

The first match to the selected name is highlighted on the member list.

About Profitability and Cost Management Dimensions

Oracle Hyperion Profitability and Cost Management uses dimensions and members created in the Profitability Applications Console to represent many of the structural elements of the business model in an Oracle Essbase application outline.

The following are dimensions used by all types of Profitability and Cost Management applications:

- **Business dimensions** that reflect the business-specific elements of the model, such as departments, accounts, activities, customers, or products; they may apply to one or more stages or models.
- **POV dimensions** that identify a specific point of view or version of the model, such as year, scenario, period, and version; version dimensions enable you to maintain multiple versions of a model and can be used to create alternate, or what-if, scenarios of the model, or different perspectives
- **Attribute dimensions** that enable analysis based on the attributes or qualities of dimension members. Attributes describe characteristics of data, such as the size or color of products
- **Alias dimensions** (optional), used to assign alternate names, descriptions, languages, or other items that help to define dimensions

Note:

The Management Ledger Rule and Balance dimensions are system dimensions that are seeded and should not be edited in any way, even if some part of the system allows it (for example, Update Dimensions in the Profitability Applications console). These dimensions are reserved for system use.

The database outline provides the data structure for the model, and includes calculation instructions and formulas. Dimensions in the Essbase outline are hierarchical. Data is stored at dimension intersections. Each stage in a detailed profitability model may include up to three dimensions.

Caution:

Members must not be repeated within the same dimension; however, a member can be repeated across several dimensions.

The following image shows a sample Essbase outline of a standard profitability calculation database, shown on the Essbase console.

Figure A-2 Standard Profitability Dimension Outline in Essbase

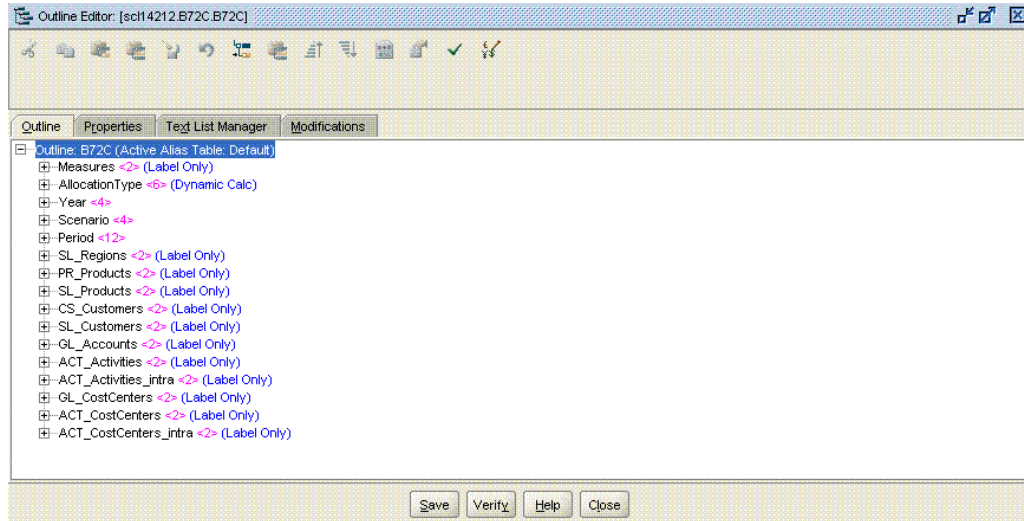

Although there is no physical limit to the number of dimensions and members that can be created, performance issues can occur with large dimensional structures.

The dimensions are created and maintained in the Profitability Applications Console, and must exist before they can be used in models. Through the Profitability Applications Console, the Profitability and Cost Management Administrator can select existing dimensions and members from other products, or create new dimensions and members specifically for the model. The common data can be shared and updated between multiple products and applications. The dimensions and their members are available in Profitability and Cost Management applications after the applications are deployed.

Caution:

Oracle recommends that you do not add or delete dimensions and dimension hierarchies after the modeling process has begun.

For each dimension, a dimension type and dimension name must be specified:

- The **dimension type** is a dimension property that enables the use of predefined functionality in the application. For Profitability and Cost Management dimension types, see [Dimension Types](#).
- The **dimension name** identifies the contents of the dimension, in relation to the organization or business. For example, a dimension of Account type may be given a dimension name, such as General Ledger or Chart of Accounts. The dimension name does not need to reflect the dimension type, although it may.

 **Note:**

It is advised to not use any of the system dimension member names for member names in any of the other dimensions or hierarchies. For example, DirectAllocation or GenealogyAllocation are system members in the AllocationType dimension and these names should not be used in any other dimensions in the model. This is good practice for all Profitability and Cost Management application types.

Oracle strongly recommends avoiding the use of special characters within dimension member names. The '_' (underscore) and ' ' (space) characters are supported in member names. Other special characters may not work in all cases and their use is discouraged.

To enter or load a data value to an Essbase database, you assign the data value a member from every dimension in the database. This is referred to as the dimension intersection for the data value. A dimension intersection identifies a unique database location or cell.

For naming conventions for dimensions and members, see the *Oracle Hyperion Profitability and Cost Management Administrator's Guide*.

Copying Standard Profitability POVs

You can copy a POV to provide a starting point for a new model or scenario, or to play what-if scenarios with an existing model.

For example, you can begin a period by copying driver selections and assignments from the previous period, or you can create seed data for a forecast scenario by copying data from an actual scenario.

To copy the POV, you must have a Source POV, which contains the information to be copied, and a Target POV, which is destination to which the data will be copied. You can copy information only to POVs with the Status of "Draft" that are listed on the Status tab of the Manage POVs screen. See [Adding Standard Profitability POVs](#).

 **Note:**

For information on all Profitability and Cost Management dimension types, see [Dimension Types](#).

To copy POVs:

1. **Optional:** If required, create a POV on the Status tab of POV Management to provide the target POV for the copy operation. See [Adding Standard Profitability POVs](#).
2. In an open model, from `Task Areas`, select **Manage Model**, then **POV Manager**.
The Status tab of the POV Manager window is displayed. All existing POVs are listed.
3. From POV Manager, select the **Copy** tab.

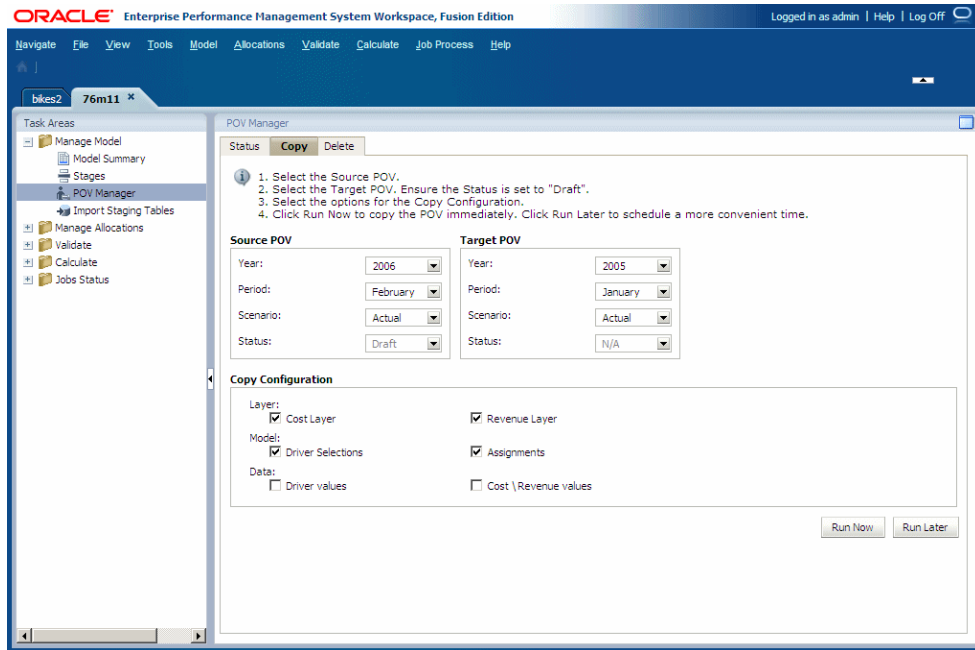

4. Under **Source POV**, select the POV that is to be copied.

 **Note:**

The Status for the Source is automatically set to the status assigned to this POV, and cannot be modified on this screen.

5. Under **Target POV**, select the POV that is to be the destination for the copied POV.

 **Caution:**

The Target POV must exist as a valid POV with the Status of "Draft" on the Status tab of the POV Manager screen, or the copy operation will not start.

6. Under **Copy Configuration**, select the elements of the POV that are to be copied:
 - Under **Layer**, select **Cost Layer**, **Revenue Layer**, or both.
 - Under **Model**, select **Driver Selections**, **Assignments**, or all.
 - Under **Data**, select **Driver values**, **Cost/Revenue values**, or both.

These options enable you to control the information that is required for the new POV. For example, you may want to include only cost, driver selection and driver values in the POV copy.

7. Perform one of the following tasks:
 - Click **Run Later** to schedule a date and time to copy the POV. See [Scheduling Task Flows](#)

 **Note:**

If this option is not selected when the task is created, you will not be able to schedule the task.

- Click **Run Now** to copy the POV immediately.

A confirmation message indicates that the job has started and identifies the assigned taskflow ID. Select **Jobs Status**, and then **Search Task** to monitor the status.

 **Caution:**

Depending on the size and complexity of the model, this operation may take a significant amount of time.

8. When the copy is complete, review the copied information under the target POV.

Alias Dimensions for Standard Profitability and Cost Management

Aliases are alternate names, descriptions, languages, or other items that help to define dimensions.

For Standard Profitability models, aliases may be cloned if a particular dimension is cloned in Oracle Essbase.

Also see, [Profitability and Cost Management Alias Dimensions](#).

About Standard Profitability Models and Scenarios

Related Topics

- [Overview of Standard Profitability Models](#)
A model is a representation of part or all of an organization, and contains costs and revenue categories that are similar to the organization's chart of accounts.
- [Steps to Create Standard Profitability Models](#)
The creation of a Oracle Hyperion Profitability and Cost Management standard model requires several steps.
- [Standard Profitability Workspace](#)
Accessed from Oracle Hyperion Enterprise Performance Management Workspace, the Oracle Hyperion Profitability and Cost Management workspace contains two main areas.

Overview of Standard Profitability Models

A model is a representation of part or all of an organization, and contains costs and revenue categories that are similar to the organization's chart of accounts.

Oracle Hyperion Profitability and Cost Management models enable you to accurately trace the processes and activities that contribute to costs and revenue within the organization.

A model is made up of the following elements:

- Stages, which organize the steps in the allocation process within the organization

- Dimensions, which are data categories that are used to organize business data for retrieval and preservation of values. Within Profitability and Cost Management, the following types of dimensions are used:
 - System dimensions, such as the Measure and AllocationType dimensions:

 **Note:**

AllocationType dimensions are used to correctly allocate costs and revenue and to store direct allocations and genealogy.

Measures dimension contains the dimensions and members required to build, validate, and calculate a model, such as measures for cost, revenue, and driver selections.

- Business dimensions, which describe the objects within each stage in the model, such as products, customers, regions, and so on. The dimensions and members, which are created in the Profitability Applications Console, are the foundation of the model.
 - POV dimensions identify a specific point of view or version of the model, such as year, scenario, period, and version. Version dimensions enable you to maintain multiple versions of a model. These versions can be used to create alternate, or what-if, scenarios of the model, or different perspectives.
 - Alias dimension is used to assign alternate names, descriptions, languages, or other items that help to define dimensions.
 - Attribute dimensions enable analysis based on the attributes or qualities of dimension members. Attributes describe characteristics of data, such as the size or color of products.
 - UDAs (User-defined attributes) dimensions
- Drivers that determine how cost or revenue source values are calculated and allocated. Selected drivers are applied to the entire dimension, a portion of the hierarchy, a single member, or even a single intersection.
 - Assignments that map source data to destinations, directly or by using defined assignment rules
 - Financial cost and revenue data, which is imported to Oracle Essbase directly through a data file, or manually entered through Profitability and Cost Management.
 - Some dimension types are available for use in Profitability and Cost Management models:
 - Account
 - Entity
 - Version
 - Time
 - Country
 - Currency

Together these elements organize the allocation points in the model into a logical flow. Careful modeling can capture the actual processes and activities, enabling you to realistically allocate costs and revenues.

The business, Measure and POV dimensions are created in the Profitability Applications Console, and are deployed to the Profitability and Cost Management relational database. Stages, drivers and assignments are created in Profitability and Cost Management.

After you create a model that reflects the current status of the organization, you can use the Copy POV feature to create alternate versions of the base model. The scenarios, or what-if scenarios, provide a risk-free method to predict the potential profitability of new opportunities and strategies, and to evaluate alternatives. or changes in the model.

See [Managing Standard Profitability POVs](#).

Steps to Create Standard Profitability Models

The creation of a Oracle Hyperion Profitability and Cost Management standard model requires several steps.

1. Define the requirements, the allocation methods, and the number and type of stages required, before creating the model in Profitability and Cost Management.

You should establish the business requirements for the model and the reporting expectations. Using pencil and paper, discussion among stakeholders, flowcharting, diagramming software and other tools, draft the conception of what the model needs to contain in order to accomplish the goals. In some instances, it may be useful to identify the results you want to achieve first, and then work backwards to formulate the best strategy to meet these goals.

When designing the Oracle Essbase outline, carefully define the reporting objectives and requirements. The effort expended in designing the outline is rewarded when generating reports. For information on creating the database outline, see *Oracle Essbase Database Administrator's Guide*.

2. Define dimensions (such as business, Measures, AllocationType, and POV dimensions) using the Profitability Applications Console to build the database outline, or main objects within each stage of the model. See [Dimension Types](#). For instructions on selecting dimensions, see the *Oracle Hyperion Profitability and Cost Management Administrator's Guide*.
3. Create model stages to define the calculation order from the beginning of the process to the delivery of the final product or service. Within a Stage, you assign the dimensions that apply to that the primary activity of the stage. The dimensions are sequenced within stages, and stages are sequenced in the order in which they are to be calculated. You can specify up to three dimensions in each stage. See [Setting Standard Profitability Model Stages](#).
4. Create drivers to specify how to calculate cost and revenue data. One dimension must be selected as the driver dimension for each stage. See [Defining Drivers and Formulas for Standard Profitability Models](#).
5. Assign drivers to selected driver dimension members or members of intersections in all stage dimensions. You can assign a driver to the entire hierarchy, or to a portion of the hierarchy, a single member or a single intersection. See [Creating Driver Selections](#).
6. Create assignments for stage intersections using assignment rules or explicit assignments to select dimensions. The destination intersections can be in a downstream stage or within the same stage. See [Working with Standard Profitability Assignments](#).

7. Validate model structure for each stage to ensure the model structure conforms to validation rules, such as completed assignments and no unused drivers. See [Validating Model Structure](#).
8. Create the Essbase database, and populate the database with cost, revenue and driver data, through Profitability and Cost Management or directly into the Essbase database, before generating calculation scripts. See [Importing Standard Profitability Data and Artifacts](#).
9. Load data into the model, either through Profitability and Cost Management or directly into the Essbase database. See the *Oracle Hyperion Profitability and Cost Management Administrator's Guide*.
10. Deploy the Calculation databases. See [Deploying the Calculation Database](#).
11. Deploy the Reporting Database. See [Deploying Reporting Databases](#).
12. Run the calculation scripts required to calculate each stage. Monitor the progress of long-running jobs, such as the generation of calculation scripts, and calculation. See [Monitoring Standard Profitability Job Status](#).
13. Calculate the Calculation Database to obtain the results of direct assignments for source and destination intersections. See [Calculating Standard Profitability Models](#).
14. Transfer data from the Calculation database which uses Block Storage Option (BSO) to the Reporting database which uses the Aggregate Storage Option (ASO). [Transferring Data](#).
15. Calculate the genealogy data. See [Calculating Multistage Contribution Paths in Genealogy](#).
16. Run the Stage Balancing, Driver Data and Trace Allocation reports. Make any edits or corrections to the model or data, and then rerun the calculations, as required. See these sections:
 - [Generating the Stage Balancing Report](#)
 - [Generating the Driver Data Report](#)
 - [Tracing Allocations](#)
17. Report on the calculated results, using reporting tools, such as Oracle Hyperion Financial Reporting or Oracle Smart View for Office. You can use the trace allocation feature to visually follow the flow of funds from one stage intersection throughout the entire model, either forwards or backwards.

Standard Profitability Workspace

Accessed from Oracle Hyperion Enterprise Performance Management Workspace, the Oracle Hyperion Profitability and Cost Management workspace contains two main areas.

- Use the Task Areas pane to navigate among the processes required to build, validate, and calculate the model, and to report results,
- Use the Contents pane to view task information, enter or modify data, and perform tasks associated with the creation and maintenance of a model and its data.

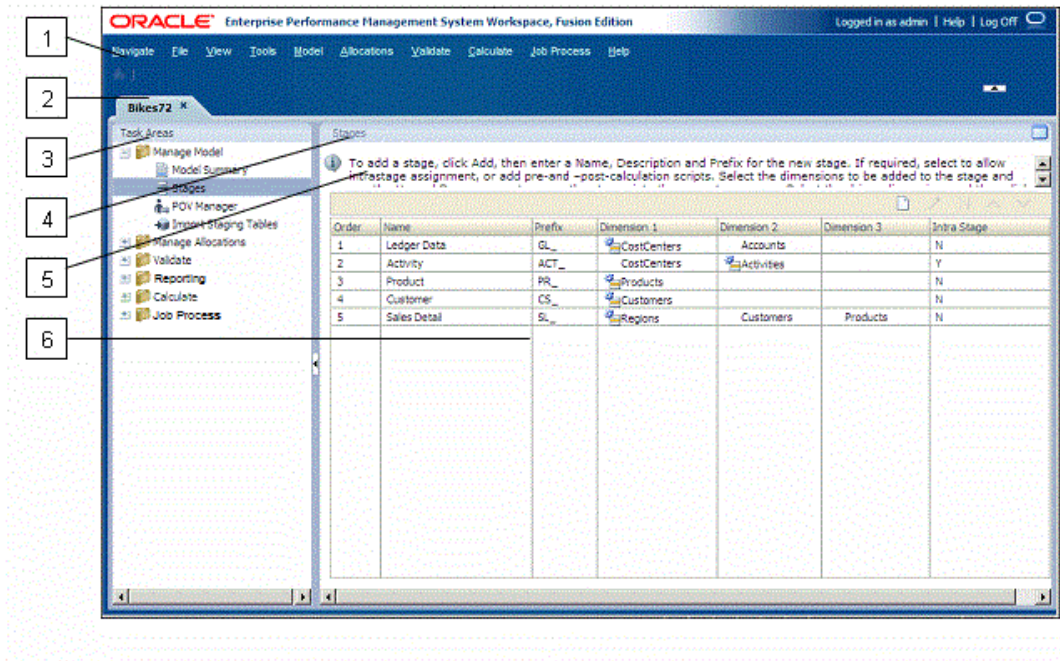

The Profitability and Cost Management workspace includes these items:

1. The main menu at the top of the window displays the common EPM Workspace menu options (Navigate, File, View, and Tools), and the Profitability and Cost Management main menu options, including Model, Allocations, Validate, Reporting, Calculate, Job Process and Help.
2. Application Name tab shows the name of the currently active application.
3. The Task Areas is used to select the tasks required to build, modify, validate model structure, and calculate models. You can also generate reports, or follow the allocation chain throughout a model.

 **Note:**

When you change a Task Area, the Point of View selection that exists in the current task is retained. This feature enables you to move from screen to screen without be required to reselect the POV. The POV selection state remains the same until it is changed by the user and the POV "refresh" icon is clicked.

4. The title bar displays the name of the window currently displayed in the contents pane.
5. The Information Bar offers shortcut instructions for the currently selected task.
6. The contents pane displays the screen for the currently selected task, such as Driver Definition or Model Summary.

Dimensions in Standard Profitability Applications

Related Topics

- [About Dimensions in Standard Profitability and Cost Management Applications](#)
Oracle Hyperion Profitability and Cost Management uses dimensions and members created in the Profitability Applications Console to represent many of the structural elements of the business model in an Oracle Essbase application outline.
- [Standard Profitability Measures Dimension](#)
The Measures dimension is imported from the Profitability Applications Console.
- [Standard Profitability AllocationType Dimensions](#)
The AllocationType dimension is imported from the Profitability Applications Console.
- [Cloned Standard Profitability Dimensions](#)
In instances where a dimension occurs in one or more stages in a model, after the model is deployed to Oracle Essbase and opened in Oracle Hyperion Profitability and Cost Management, an automatically-added cloned dimension is displayed.

About Dimensions in Standard Profitability and Cost Management Applications

Oracle Hyperion Profitability and Cost Management uses dimensions and members created in the Profitability Applications Console to represent many of the structural elements of the business model in an Oracle Essbase application outline.

A dimension type is a dimension property that enables the use of predefined functionality. The specific characteristics of the dimension type manage the behavior and functions of the dimension. Because Profitability and Cost Management and other Oracle Hyperion Enterprise Performance Management Workspace products may share certain dimension types, you can leverage the functionality of dimensions for different products.

See these sections for information about Profitability and Cost Management dimensions that are common to all application types::

- [About Profitability and Cost Management Dimensions](#)
- [Dimension Types](#)
 - [Profitability and Cost Management Business Dimensions](#)
 - [Profitability and Cost Management POV Dimensions](#)
 - [Profitability and Cost Management Attribute Dimensions](#)
 - [Profitability and Cost Management Alias Dimensions](#)

The following sections contain information about System dimensions that are specific to Standard Profitability applications and models:

- [Standard Profitability Measures Dimension](#)
- [Standard Profitability AllocationType Dimensions](#)
- [Cloned Standard Profitability Dimensions](#)

Standard Profitability Measures Dimension

The Measures dimension is imported from the Profitability Applications Console.

It contains the members required to build, validate, and calculate a model. The members store the data that is used for the allocation process. There are separate measures for Cost and Revenue data.

While the standard Measures dimensions are predefined, users may add any user-defined driver measures to the hierarchy under the member 'UserDefinedDriverMeasures'.

Caution:

Do not edit the system members in this dimension, as this may result in the loss of data or the corruption of the model.

The Measures dimension contains members that store the different types of data for business dimension members that are required for the allocation process:

- **Driver Measures**—Store values used as parameters in driver formulas, such as Quantity and Rate. There are ten predefined driver measures. You can also add an unlimited number of user-defined driver measures, but these driver measures must be unique in the Oracle Essbase outline.

To view the members included in the Driver Measures dimension, see [Standard Profitability Driver Measures](#).

- **Reporting Measures**—Designed for ease-of-use in report creation. Reporting measures form alternate hierarchies in the Measures dimensions. Reporting can be done on any measure.

To view the members included in the Reporting Measures dimension, see [Standard Profitability Reporting Measures](#)

For information on alternate hierarchies in Essbase, see the *Oracle Essbase Database Administrator's Guide*.

- **Allocation Measures**—System-defined measures that store the cost and revenue inputs from upstream model stages or from data loads and are used to control allocation of calculated and input costs for both costs and revenue.

Note:

The allocation measures in the Measures dimension should not be confused with the DirectAllocation and GenealogyAllocation measures in the AllocationType Dimension, described in [Standard Profitability AllocationType Dimensions](#).

There are separate allocation measures for the Cost Layer Allocation and Revenue Layer Allocation. To view the members included in the Cost Layer and Revenue Layer Allocation Measures dimensions, see [Standard Profitability Cost Layer Allocation Measures](#) and [Standard Profitability Revenue Layer Allocation Measures](#).

Standard Profitability Driver Measures

Driver Measures are used in the creation of driver types.

Table A-2 Driver Measures

Member Name	Alias	Description	Calculated or Input
FixedDriverValue	FixedDV	Default measure for use with driver types that require a fixed driver value parameter	Input
Rate	Rate	Default measure for use with driver types that require a rate parameter	Input
Quantity	Qty	Default measure for use with driver types that require a quantity parameter	Input
Weight	Weight	Default measure for use with driver types that require a weight parameter	Input
Percentage	Percent	Default measure for use with a percentage driver type	Input
CalculatedDriverValue	CDV	Measure that is the result of the driver formula used in an assignment	Calculated
TotalDriverValue	TDV	Measure that is used as the denominator in the allocation formula $\text{Driver Value} / \text{TotalDriverValue} (\text{DV} / \text{TDV})$	Calculated
EffectiveTotalDriverValue	EffTDV	Measure that is used to store the Effective Driver Total for drivers that have the "Allow idle" box checked when the driver is defined.	Calculated
OverrideTotalDriverValue	OvrTDV	User-entered value that overrides the TotalDriverValue measure as the denominator in allocations. This member causes idle calculations to be performed.	Input
TotalDriverValueAfter Reciprocals	TDVAftRcp	Measure that is used as the denominator in allocation formulas for non-reciprocal intrastage and post-stage allocations, when a source is involved in a reciprocal assignment	Calculated
IdleDriverValue	IdleDV	Measure that is used as the driver value (DV) for calculating IdleCost	Calculated

Table A-2 (Cont.) Driver Measures

Member Name	Alias	Description	Calculated or Input
UserDefinedDriverMeasures	N/A	<p>The member UserDefinedDriverMeasures is where the application-specific, user-defined driver measures are stored.</p> <p>Set the ASOMember DataStorage and BSOMember DataStorage properties as follows:</p> <ul style="list-style-type: none"> — If this member does not have children, set to StoreData. — If members are added as children to this member, and all these children have the consolidation symbols of IGNORE, then set to LabelOnly. <p>Note: All driver measures must be unique in the outline. Do not use the name of an existing driver measure in a dimension in the outline as the name of another member (including system, POV and business dimensions); otherwise, the Data Entry screen will not properly display the values.</p>	N/A

Standard Profitability Reporting Measures

Reporting Measures are used to generate reports, using the calculated and input values to generate total costs and revenue for the model. All the non-level-0 reporting measures are calculated.

Table A-3 Reporting Measures

Member Name	Alias	Description	Calculated or Input
GrossCost	GrossCost	<p>Total cost for an intersection, including all possible inputs:</p> <ul style="list-style-type: none"> • Input values • Prior stage assignments • Intrastage assignments including reciprocals <p>This calculation represents the true total cost of the intersection.</p>	Calculated

Table A-3 (Cont.) Reporting Measures

Member Name	Alias	Description	Calculated or Input
StandardCost		For Standard Basis driver, the calculated cost of $\text{StandardCostRate} * \text{TotalDriverValue}$	Calculated
StandardRevenue		For Standard Basis driver, the calculated revenue of $\text{StandardRevenueRate} * \text{TotalDriverValue}$	Calculated
InitialCost	InitialCost	Cost of an intersection before intrastage or reciprocal costs are calculated, including input costs and cost received on assignments from prior stages.	Calculated
NetCostAfter IntraStage	NetCostAftInt	Cost of an intersection, including all intrastage cost assignments	Calculated
GrossRevenue	GrossRev	Total revenue for an intersection, including all possible inputs: <ul style="list-style-type: none"> • Input values • Prior stage assignments • Intrastage assignments including reciprocals. This calculation represents the true total revenue for the intersection.	Calculated
InitialRevenue	InitialRev	Revenue for an intersection before intrastage or reciprocal revenue is calculated, including input revenue, and revenue received on assignments from prior stages.	Calculated
NetRevenueAfterIntraStage	NetRevAftInt	Revenue for an intersection after accounting for all types of intrastage revenue assignments	Calculated
Profit	Profit	Value of the calculated profit for the selected intersection. This value is the result of the calculation: $\text{NetRevenueForAssignment} - \text{NetCostForAssignment}$	Calculated

Standard Profitability Cost Layer Allocation Measures

Cost Layer Allocation Measures are used to control the direct allocation of calculated and input costs.

Table A-4 Cost Layer Allocation Measures

Member Name	Alias	Description	Calculated or Input
UnassignedCost	UnAsgCost	Remainder of cost at a source intersection after all assignment and idle calculations have been completed.	Calculated
CostAssigned	CostAsg	Total cost assigned from a source to post-stage destinations and non-reciprocal intrastage destinations	Calculated
CostAssigned IntraStage	CostAsgInt	Sum of costs assigned to intrastage destinations, excluding reciprocal destinations	Calculated
CostAssigned PostStage	CostAsgPost	Sum of costs assigned to post-stage destinations	Calculated
OverDrivenCost	OverDrivenCost	For a standard basis driver, if the total cost assigned is greater than the <code>NetCostForAssignment</code> , the overage amount is posted to <code>OverDrivenCost</code> .	Calculated
IdleCost	IdleCost	Depending on the driver type, idle cost is generated differently: <ul style="list-style-type: none"> For actual basis drivers, idle cost is generated using the allocation formula: $\frac{\text{IdleDriverValue}}{\text{OverrideTotalDriverValue}}$ For standard basis drivers, idle cost is generated if the total cost assigned is less than <code>NetCostForAssignment</code>. 	Calculated
NetCostFor Assignment	NetCostAsg	Total cost available for assignment after accounting for all prior stage, intrastage, and reciprocal assignments. Set the <code>DataStorage (BSO)</code> property to StoreData .	Calculated

Table A-4 (Cont.) Cost Layer Allocation Measures

Member Name	Alias	Description	Calculated or Input
GrossReceivedCost	GrRecCost	Sum of all costs assigned from prior stages and intrastage assignments, excluding reciprocals and user input costs Set the DataStorage (BSO) property to StoreData .	Calculated
StandardCostRate	StandardCostRate	For a Standard Basis driver, the user assigns a standard cost rate, and enters that value for use in calculations for the standard basis cost driver, as follows: $CostReceivedPriorStage = StandardCostRate * TotalDriverValue$	Input
CostInput	CostInput	User-entered cost value for the intersection	Input
CostReceived	CostRec	Sum of all costs assigned to an intersection by prior stage and intrastage assignments, excluding costs resulting from reciprocal assignments Set the DataStorage (BSO) property to StoreData .	Calculated
CostReceived PriorStage	CostRecPri	Sum of costs received on assignments from a prior stage	Calculated
CostReceived IntraStage	CostRecInt	Sum of all costs received on intrastage assignments, excluding reciprocal assignments	Calculated
NetReciprocalCost	NetRcpCost	Net effect of a reciprocal assignment on the amount available for assignment to post-stage and non-reciprocal intrastage destinations Set the DataStorage (BSO) property to StoreData .	Calculated
ReciprocalCost Assigned	RcpCostAsg	Total cost assigned to reciprocal destination, excluding costs received from the reciprocal	Calculated
ReciprocalCost Received	RcpCostRec	Total cost received from a reciprocal destination	Calculated

Table A-4 (Cont.) Cost Layer Allocation Measures

Member Name	Alias	Description	Calculated or Input
Reciprocal IntermediateCost	RcpIntCost	Intermediate value calculated for an intersection after simultaneous equations have been applied, but before reciprocal adjustments have been made	Calculated
CostPerDrvUnit	Cost Per Driver Unit	This measure is a child of AllocationMeasures. The formula uses the assigned cost (CostAssigned) divided by the sum of all driver values (TotalDriverValue) to calculate the cost for each unit of driver value.	Calculated
UnitCost	Unit Cost.	This measure is a child of AllocationMeasures. The formula uses the amount of cost at a source intersection (NetCostForAssignment) divided by a user-input quantity to calculate the cost per unit.	Calculated

Standard Profitability Revenue Layer Allocation Measures

Revenue Layer Allocation Measures are used to control the direct allocation of calculated and input revenue.

Table A-5 Revenue Layer Allocation Measures

Member Name	Alias	Description	Calculated/Input
UnassignedRevenue	UnAsgRev	Remainder of revenue at a source intersection after all assignment and idle calculations have been completed	Calculated
RevenueAssigned	RevAsg	Total Revenue assigned from a source to post-stage and non-reciprocal intrastage destinations	Calculated
OverDrivenRevenue		For a standard basis driver, if the total revenue is greater than the NetRevenueForAssignment, the overage amount is posted to OverDrivenRevenue.	Calculated

Table A-5 (Cont.) Revenue Layer Allocation Measures

Member Name	Alias	Description	Calculated/Input
RevenueAssignedIntraStage	RevAsgInte	Sum of revenue assigned to intrastage destinations, excluding reciprocal destinations	Calculated
RevenueAssignedPostStage	RevAsgPoste	Sum of revenue assigned to post-stage destinations	Calculated
IdleRevenue	IdleRev	Depending on the driver type, idle revenue is generated differently: <ul style="list-style-type: none"> For actual basis drivers, idle revenue is generated using the allocation formula: $\frac{\text{IdleDriverValue}}{\text{OverrideTotalDriverValue}}$ For standard basis drivers, idle revenue is generated if the total revenue assigned is less than NetRevenueForAssignment. 	Calculated
NetRevenueForAssignment	NetRevAsg	Total revenue available for assignment after accounting for all prior stage, intrastage and reciprocal assignments. Set the DataStorage (BSO) property to StoreData .	Calculated
GrossReceivedRevenue	GrRecRev	Sum of all revenue assigned from prior stages and intrastage assignments, excluding reciprocal assignments and user input revenue. Set the DataStorage (BSO) property to StoreData .	Calculated
StandardRevenueRate	StandardRevenueRate	For a Standard Basis driver, the user assigns a standard revenue rate, and enters that value for use in calculations for the standard basis revenue driver, as follows: $\text{RevenueReceivedPriorStage} = \text{StandardRevenueRate} * \text{TotalDriverValue}$	Input

Table A-5 (Cont.) Revenue Layer Allocation Measures

Member Name	Alias	Description	Calculated/Input
RevenueInput	RevInput	User-entered revenue values for the intersection. Define and store Revenue categories as a hierarchy under 'RevenueInput'. Set the DataStorage (BSO) property to StoreData .	Input
RevenueReceived	RevRec	Sum of all revenue assigned to an intersection by prior stage and intrastage assignments, excluding revenue results from reciprocal assignments. Set the DataStorage (BSO) property to StoreData .	Calculated
RevenueReceivedPriorStage	RevRecPrior	Sum of revenue received on assignments from a prior stage	Calculated
RevenueReceivedIntrastage	RecRecInt	Sum of all revenue received on intrastage assignments, excluding reciprocal assignments	Calculated
NetReciprocalRevenue	NetRcpRev	Net effect of a reciprocal assignment on the amount of revenue available for assignment to post-stage destinations and non-reciprocal intrastage destinations. Set the DataStorage (BSO) property to StoreData .	Calculated
ReciprocalRevenue Assigned	RcpRevRec	Total revenue assigned to reciprocal destinations, but excluding revenue received from the reciprocal assignment	Calculated
ReciprocalRevenue Received	RcpRevAsg	Total revenue received from a reciprocal destination	Calculated
ReciprocalIntermediateRevenue	RcpIntRev	Intermediate value calculated for an intersection after simultaneous equations have been applied, but before reciprocal adjustments have been made	Calculated

Standard Profitability AllocationType Dimensions

The AllocationType dimension is imported from the Profitability Applications Console.

This dimension is used to correctly allocate costs and revenue, and store direct allocations and allocation genealogy.



Note:

The AllocationType dimension can be renamed, if required.

In the Oracle Essbase outline created by Oracle Hyperion Profitability and Cost Management, the AllocationType dimension contains the following members:

- **AllAllocations** contains the following child members:
 - **DirectAllocation** stores calculated data that has been directly allocated within the model, between a specified source intersection and destination intersection. Direct allocation must be defined as an assignment by the user.
 - **GenealogyAllocation** stores the allocation genealogy that is calculated on indirect links between various concerned intersections in the model. For example, if stages 1-3-5 are selected:
 - * Stages 1-3 includes both direct and indirect allocations
 - * Stages 3-5 includes only indirect allocations
 Genealogy allocation is not directly defined by the user, but exists because of two or more direct allocations. For example, A-B-C allocation genealogy data exists because there is a direct allocation from A to B (A-B) and B to C (B-C).
- **SysAllocVar1** stores the value for intrastage assignments on the virtual link, which is part of the value allocated to another node on the same stage, and is available in the `DirectAllocation` member.
- **SysAllocVar2** is used to obtain a sum of the source links of `DirectAllocation`, `Genealogy Allocation` and `SysAllocVar1`.
- **SysAllocVar3** stores calculated genealogy data that is used within the system. For example, if stages 1-3-5 are selected:
 - Stages 1-3 includes both direct and indirect allocations
 - Stages 3-5 includes only indirect allocations

Caution:

This member is for internal use only. Do not use this member in reports.

- **TotalAllocation** dynamically calculates the sum of the source links of `DirectAllocation`, `GenealogyAllocation` and `SysAllocVar3`.
- **IndirectAllocation** dynamically calculates the sum of the source links of `GenealogyAllocation` and `SysAllocVar3`.

The data in these dimensions cannot be modified, and it is not visible in Profitability and Cost Management.

 **Caution:**

Do not edit the system members in this dimension, as any modifications may result in the loss of data or the corruption of the model.

The system automatically generates the AllocationType dimension if the user creates an application using the wizard, and checks "Auto Create Local Dimensions". If the user selects "Create Blank Application", the user must create their own dimensions and select the AllocationType dimension type.

When you create reports, the AllocationType dimension enables you to specify which type of allocation data to retrieve.

Cloned Standard Profitability Dimensions

In instances where a dimension occurs in one or more stages in a model, after the model is deployed to Oracle Essbase and opened in Oracle Hyperion Profitability and Cost Management, an automatically-added cloned dimension is displayed.

The cloned dimensions create a distinct version of the dimension for each stage in which it is used.

For example, if you create a dimension called "Department", and use this dimension in some stages within the model, after the model is deployed to Essbase, you see the cloned dimensions in the model:

Department (original dimension)

- GLDepartment (Cloned dimension for stage with prefix GL)
- OPSDepartment (Cloned dimension for stage with prefix OPS)
- OPSDepartment_intra (Cloned dimension for stage with prefix OPS that allows intrastage assignments).

If additional members are required, add the new members only to the original dimension. The new members are added to the cloned dimensions when the application is redeployed.

 **Note:**

Any updates to cloned dimensions are not passed to Profitability and Cost Management and Essbase.

Managing Standard Profitability Models

Related Topics

- [About Managing Standard Profitability Models](#)
The Managing Models options are used to build the top-level structure of a model, and to control model preferences and connections.
- [Working with the Standard Profitability Model Summary](#)
The Model Summary displays details of the system information for the selected application, and enables you to modify model level preferences.
- [Setting Standard Profitability Model Stages](#)
In Oracle Hyperion Profitability and Cost Management, you create model stages to reflect each major process or activity in the business.
- [Working with Standard Profitability Points of View](#)
The Point of View (POV) for a model provides a specific view of the model information for a selected time period, such as a year, status and scenario.
- [Querying Standard Profitability Model Statistics](#)
After a model is built, it may be useful to determine the number and usage of certain components, such as stages or POVs and their dimensions, assignments, and drivers.
- [Importing Standard Profitability Data and Artifacts](#)
You can enter data and model information directly into Oracle Hyperion Profitability and Cost Management; however, the data entry may be very time-consuming.

About Managing Standard Profitability Models

The Managing Models options are used to build the top-level structure of a model, and to control model preferences and connections.

From the Model Summary, you can view system information and set model-level preferences.

Within the Stages section, you assign Oracle Essbase dimensions to each stage defined in the model, and create the intersections in which data for the stage is stored.

Points of View (POVs) are used to create various versions of a model; for example, to hold budget versus actual figures, or to play scenarios to measure the impact of various changes on the bottom line.

To facilitate data entry, you can load data to Essbase or through data entry screens in Oracle Hyperion Profitability and Cost Management. The staging tables, which are created by the Profitability and Cost Management administrator, can be used to load model information, such as driver definitions, driver selections, assignments, and so on, to Profitability and Cost Management.

See these sections to manage the models:

- [Working with the Standard Profitability Model Summary](#)
- [Setting Standard Profitability Model Stages](#)
- [Working with Standard Profitability Points of View](#)
- [Importing Standard Profitability Data and Artifacts](#)

Working with the Standard Profitability Model Summary

The Model Summary displays details of the system information for the selected application, and enables you to modify model level preferences.

The Model Summary contains these tabs:

- [System Information Tab](#)
- [Setting Model Level Preferences](#)

System Information Tab

The System Information tab provides detailed information for the selected model, including the relational database, Oracle Essbase connections, authorized users and associated system components.

Most of the system information is read-only; however, you can enter or modify the names for the Calculation and Reporting applications and databases.

To access the System Information tab:

1. From Oracle Hyperion Enterprise Performance Management Workspace, select **Navigate**, then **Applications**, then **Profitability**, and then select the application that you want to view.
2. From Task Areas, select **Manage Model**, and then **Model Summary**.

The System Information tab is displayed.

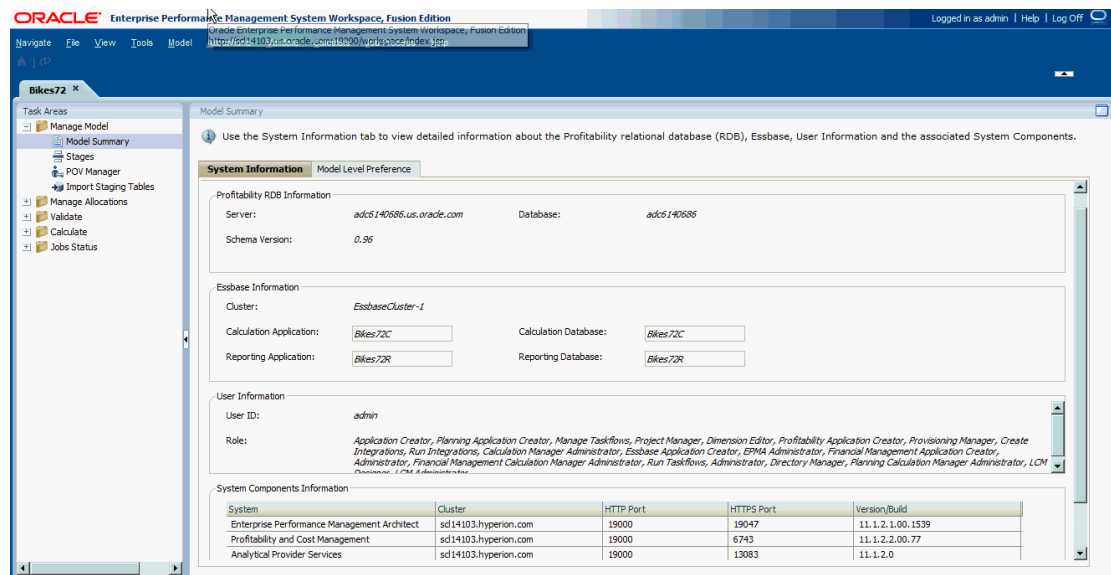

Table A-6 System Information Tab

Tab Area	Description
Profitability RDB Information	Name of the relational database (RDB) server and the database in which the model data resides. The Schema version being used with the selected application is also displayed.
Essbase Information	Name of the Essbase multidimensional database cluster or server that contains the model structure and the name of the associated database. Enter or modify the name of the Calculation and Reporting applications and databases. See the <i>Oracle Essbase Database Administrator's Guide</i> for restricted words and characters.
User Information	User ID for the user who is authorized to access the Oracle Hyperion Profitability and Cost Management database, and all associated security roles for that user. Note: Ensure that this user has been granted access to the Essbase databases and the application. See the <i>Oracle Hyperion Profitability and Cost Management Administrator's Guide</i> .
System Components Information	Details for each component in the installation, as follows: <ul style="list-style-type: none"> • System displays the name of the Enterprise Performance Management component. • Cluster displays the name of the cluster or server hosting that component. • HTTP Port displays the port being used by the component. • HTTPS Port displays the secure port being used by the component, if available. • Version/Build displays the version and build number for the listed component. <p>You can sort the columns by clicking any column header. The System and Host columns are sorted alphabetically, and the Ports and Version/Build columns are sorted numerically.</p>

Setting Model Level Preferences

You can customize the application to use the display preferences. The settings on the Model Level Preference tab apply to the entire model.

You also specify Oracle Essbase connection information for the selected model.

Caution:

Although you can change preferences at any point in the life cycle of a model, changes made later in the cycle may result in data loss.

To set model level preferences:

1. From Oracle Hyperion Enterprise Performance Management Workspace, select **Navigate**, then **Applications**, then **Profitability**, and then select the application that you want to view.
2. From **Task Areas**, select **Manage Model**, then **Model Summary**, and then select the **Model Level Preference** tab.

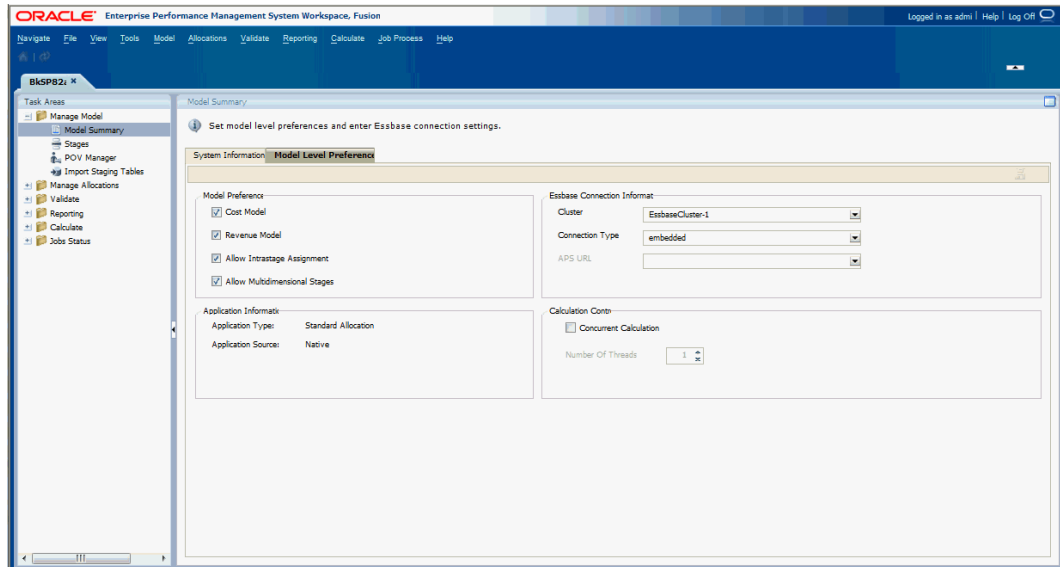

- Under **Model Preferences** on the **Model Level Preference** tab, select one or more preferences to control the content of the model. The available preferences are described in [Table 1](#).

Table A-7 Model Level Preferences

Setting	Description
Cost Model	Display all associated costs in modeling editors of the application
Revenue Model	Display all associated revenue in modeling editors of the application
Allow Intrastage Assignment	Enable the user to create multiple cost or revenue assignments within one stage.
Allow Multidimensional Stages	Enable the user to create a model stage that is composed of up to three dimensions

- Under **Esbase Connection Information**, enter Essbase connection information for the model. The required information is described in [Table 2](#).

Table A-8 Esbase Connection Information

Setting	Action
Cluster	Select the logical name of the Essbase server that provides the connection to the Essbase databases. This name may point to a clustered or non-clustered Essbase server.
Authentication Type	Select Single Sign-On as the Essbase authentication type.
Connection Type	Select the type of connection: <ul style="list-style-type: none"> Embedded APS See the <i>Oracle Hyperion Provider Services Administration Guide</i> .

Table A-8 (Cont.) Essbase Connection Information

Setting	Action
APS URL	<p>Activated only if APS is selected as the Connection Type</p> <p>Select the URL for the APS that represents the Logical Web Application (LWA) of the server on which Oracle Hyperion Provider Services is running.</p> <p>The available APS servers are registered in Oracle Hyperion Shared Services registry during configuration.</p> <p>By default, the APS URL is <code>http://localhost:13080/aps/JAPI</code>.</p>

- Under **Application Type**, **Standard Allocation** is displayed.

The application type is selected when the application is created in the Profitability Applications Console, and cannot be changed.

 **Note:**

To create a Detailed Allocation application, see [Managing Detailed Profitability Models](#).

- Optional:** Under **Calculation Control**, select **Concurrent Calculation** to enable certain steps within the calc script to be split into multiple scripts that runs concurrently in Essbase, to take advantage of the Exalytics platform's parallel architecture.

In **Number of Threads**, select how many calc scripts you want Essbase to execute at one time.

- Click **Save** .

Setting Standard Profitability Model Stages

In Oracle Hyperion Profitability and Cost Management, you create model stages to reflect each major process or activity in the business.

You assign dimensions to each stage to define the intersections where data for the stage is stored. Stages exist only in Profitability and Cost Management, and are not recognized in Oracle Essbase.

A stage can be created for almost any type of requirement, such as general ledger accounts, markets, resource groupings, materials, work categories, equipment, processes, products, subassemblies, service offerings, customer categories, and specific customers. You can define up to nine stages per model. The stage name must be unique for each model or application.

You must assign at least one dimension to each stage, and each stage may have up to three dimensions. The same dimension may be assigned to more than one stage; however, a unique stage prefix must be set to distinguish the dimension and stage combination. The number of dimensions within a stage may vary. For example, one stage might have three dimensions, and another may have one or two. If you require more than one dimension per stage, see [Setting Model Level Preferences](#) to enable that model level preference.

The stages should be sequenced logically from the first to the final process because that sequence is followed when costs and revenue are calculated. The results that are calculated and stored in one stage become the source values to be allocated in the following stage. You create allocations that require multiple steps by defining a calculation sequence through the stages. Cost decomposition values related to the stages are easily retrieved and evaluated.

Within the model stage, the calculation of cost and revenue is controlled by these conditions:

- The order of model stages must be set in the calculation order that reflects the general flow of activities, financial costs and revenue for the entire model.
- Only one dimension within each stage must be designated as a Driver dimension.

From the Stages screen, you order the stages and dimensions order using the Up and Down buttons in the application; however, if any changes are made to the order, name, or prefix for a stage after it has been deployed, the model must be redeployed.

A note, or text record of approximately 1,000 characters, may be entered for each stage record.

For detailed instructions on working with model stages, refer to these sections:

- [Adding Model Stages](#)
- [Modifying Model Stages](#)
- [Deleting Model Stages](#)

Adding Model Stages

Stages represent the network of allocations within the organization. The calculations flow forward from initial allocations to the delivery or resolution. Backward flows are not permitted.

The calculation sequence is critical to obtaining correct results. Calculation order is determined by dimension and stage order, as displayed in the Stages window. In the following example, the model calculation follows the specified sequence, and the results of each stage are carried forward to the next stage:

- Stage 1
 - Dimension 1
 - Dimension 2
 - Dimension 3
- Stage 2
 - Dimension 1
 - Dimension 2
 - Dimension 3
- Stage 3, and so on.

Each stage requires a name and a stage prefix.

To add model stages:

1. In an open model, from `Task Areas`, select **Manage Model**, then **Stages**.

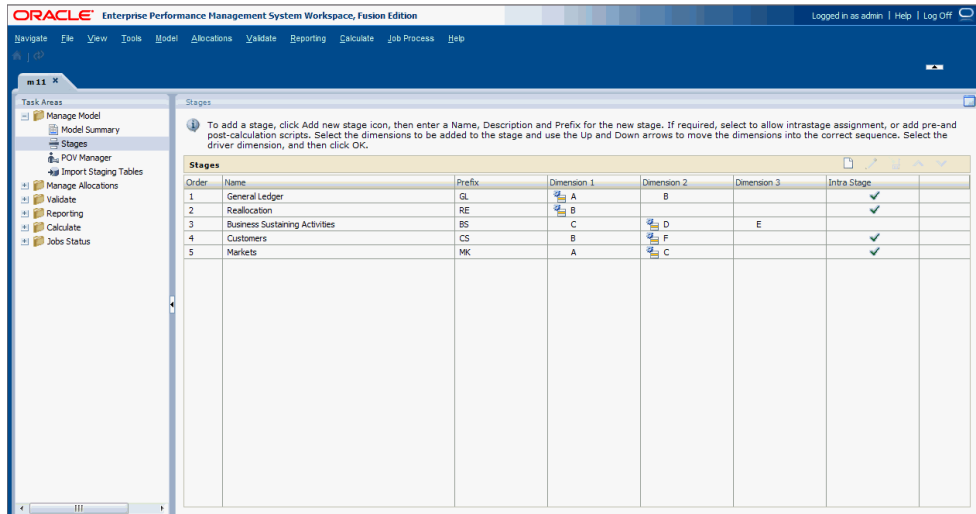

The Stages window provides the following information about the selected stage:

- **Order** displays the number of the sequential position of the stage within the model.
- **Name** shows the name of the stage and usually identifies the business function or process of the stage, such as General Ledger or Operating Activities.
- Alphanumeric **Prefix** assigned to the stage
- Dimensions included in the stage. The driver dimension for the stage is indicated by the driver icon .
- The **Intra Stage** field displays a check mark to indicate whether intrastage assignments are allowed for the stage.

2. Click **Add new stage** .

Stage

Name:

Description:

Prefix:

Allow Intrastage Assignments:

▼ Scripts

Precalculation:

Postcalculation:

Stage Dimensions

Order	Dimension	Driver
1	Accounts	<input type="radio"/>
2	Regions	<input checked="" type="radio"/>

Help OK Cancel

3. For **Name**, enter a unique, descriptive name for the stage, to a maximum of 80 characters.

The name should identify the business function or process of the stage, such as General Ledger or Operating Activities.

4. **Optional:** Under **Description**, enter a brief explanation of the type of information that is included in the stage, to a maximum of 255 characters.
5. Under **Prefix**, enter a unique alphanumeric prefix for the selected stage, to a maximum of 80 characters.

Stage prefixes are used to distinguish the dimension-stage combination. For example, if the dimension "Department" is used in two stages, the prefix "General Ledger" might be applied to one, and "Process" to the other. The resulting reports display the dimensions as "General LedgerDepartment" and "ProcessDepartment".

6. **Optional:** If you require allocations within the same stage, select **Allow Intrastage Assignments** to mark the stage for intrastage allocations.
7. **Optional:** If manually created calculation scripts are available, under **Scripts**, enter a **Precalculation** or a **Postcalculation** script name.



Optional pre- and post-calculation scripts are manually created in script editors in the EAS console for execution from Oracle Hyperion Profitability and Cost Management. The scripts, which are stored in Oracle Essbase, enable users to initialize Essbase cells to the correct values.





Based on the type of script selected for a stage, they are run to prepare the stages for allocations or reporting, as follows:

- Pre-calculation scripts are run before the stage calculation scripts.

- Post-calculation scripts are run after the stage calculation scripts.
8. On the **Stage Dimensions** toolbar, click **Add** .

A line is added to the list of Dimensions, showing the next sequential number in the Order. The Dimension list is populated with all dimensions available in the model.
 9. Under **Dimensions**, select a dimension that applies to the new stage.

Stage Dimensions		
Order	Dimension	Driver
1	Accounts	
2	Customers	





10. **Optional:** Repeat step 8 and step 9 to add up to three dimensions for each stage.
11. **Optional:** Under **Order**, select a dimension, and use the Up  or Down  buttons to move the dimension to the correct location in the calculation sequence.
12. Under **Driver**, select the driver dimension for the stage.
13. Click **OK**.
14. **Optional:** Select a stage from the Stages table, and use the Up  or Down  buttons to move each stage to the correct location in the calculation sequence.

Modifying Model Stages

Model stages can be easily modified; however, if you modify any items after the model is deployed, the model must be redeployed.

To modify model stages:

1. **Optional:** Modify metadata, such as dimension members, in the Profitability Applications Console, and deploy the modifications to Oracle Hyperion Profitability and Cost Management before you modify the stages.
2. In an open model, from **Task Areas**, select **Manage Model**, then **Stages**.
3. Select the stage to be modified, and click **Edit Stage** .
4. Modify any of these items:
 - Name
 - Description
 - Prefix
 - Intrastage Setting
 - Scripts
5. **Optional:** Under **Dimension**, modify the selected dimensions as required.

6. **Optional:** Under **Order**, use the Up  or Down  buttons to reposition the dimensions in the correct sequence.
7. **Optional:** Under **Driver**, select a different driver dimension for the stage.
8. Click **OK**.
9. **Optional:** Select a stage and use the Up  or Down  buttons to reorder the stages.

 **Note:**

This operation reorders the calculation and invalidates all assignments and assignment rules selections pertaining to this stage.

10. Redeploy the model if any items (Other than Stage Name, Description, Order of the dimensions in a stage) are modified.

 **Note:**

Stage Name, Description, Order of the dimensions do not influence the Essbase cube deployed state.

Deleting Model Stages

Deletion of a model stage automatically changes the calculation of the model. Any driver associations and assignments set for the stage dimensions are also deleted. After a stage is deleted, you must resequence the stages to properly reflect the new calculation flow.



To delete model stages:

1. In an open model, from **Task Areas**, select **Manage Model**, then **Stages**.
2. On the **Stages** dialog box, select the stage to be deleted.
3. Click **Delete stage** .

A message requests that you confirm the deletion.

 **Caution:**

Any driver selections and assignments pertaining to this stage are also deleted.

4. Click **Yes** to delete the stage and its driver selections and assignments.
5. **Optional:** Under **Order**, use Up  or Down  to reposition the remaining stages in the correct calculation sequence.

Working with Standard Profitability Points of View

The Point of View (POV) for a model provides a specific view of the model information for a selected time period, such as a year, status and scenario.

Members for POV dimensions are user-defined, and can provide a rich array of POV combinations for modeling and what-if analysis.

You must have at least one POV dimension, and you can have up to four. The user defines the POV dimensions, and the names of those dimensions. Calculations are performed using the specific data, drivers and assignments of that POV for different months or situations.

The names and structure of POV dimensions for the organization can be completely customized. A typical POV includes the Year, Period, and Scenario. The first step for almost every activity in Oracle Hyperion Profitability and Cost Management is the selection of a POV.

A model can only be edited if the POV is set to "Draft" status. You can modify the POV to reflect new drivers, criteria, or members, enabling you to create alternative scenarios. By comparing these scenarios, you can evaluate how changes affect the processes or bottom line.

You can also create POV versions that enable you to maintain separate versions of the same POV to monitor the impact of changes to the model, or track different versions of the same model.

See these sections for detailed information about POVs:

- [Profitability and Cost Management POV Dimensions](#)
- [Standard Profitability POV Status](#)
- [Managing Standard Profitability POVs](#)

Standard Profitability POV Status

A status must be set for the POV to show the current availability of the model for editing or viewing. The status is not an Oracle Essbase dimension.

The POV status must be set to one of the following states:

- Draft — Build or edit the model, and generate dynamic reports.
- Published — View the model, and generate dynamic reports. You cannot edit the model.
- Archived — View the model and generate dynamic reports. You cannot edit the model.

Managing Standard Profitability POVs

A POV displays a particular version of a model for a selected snapshot, such as year, period, and status.

When a new POV is added, the status is automatically set to "Draft" so the POV can be edited.

At least one POV dimension is required for a model; however, you can create multiple POV combinations for a single model. A selected POV with stage and layer information can be saved as an Oracle Hyperion Enterprise Performance Management Workspace user preference. You can also copy a POV, to begin a model for a new reporting period, or a different scenario. See [Copying Standard Profitability POVs](#).

The POV dimension defined for the application determines the potential POVs available for a model, but all POVs are not automatically available for assignment or data input. You cannot assign drivers or load data for a POV until it has been added to the model.

The following model elements must be specified for each POV combination:

- Drivers for source members
- Assignments, or assignment rule selections
- Driver data
- Cost and revenue data

Use the following procedures to work with POVs:

- [Adding Standard Profitability POVs](#)
- [Modifying the Standard Profitability POV Status](#)
- [Copying Standard Profitability POVs](#)
- [Deleting Selected Objects from Standard Profitability POVs](#)
- [Deleting Standard Profitability POVs and All Artifacts](#)

Adding Standard Profitability POVs

You add a POV to view the information and calculations for a model for a selected snapshot of the model, such as a year, period, scenario and status.

The values of the parameters available for a model are set in Oracle Essbase .



Note:

You cannot access a POV from other task windows until the POV has been added in POV Management.

To add POVs:

1. In an open model, from `Task Areas`, select **Manage Model**, then **POV Manager**.
The Status tab of the POV Manager screen is displayed. All existing POVs are listed.

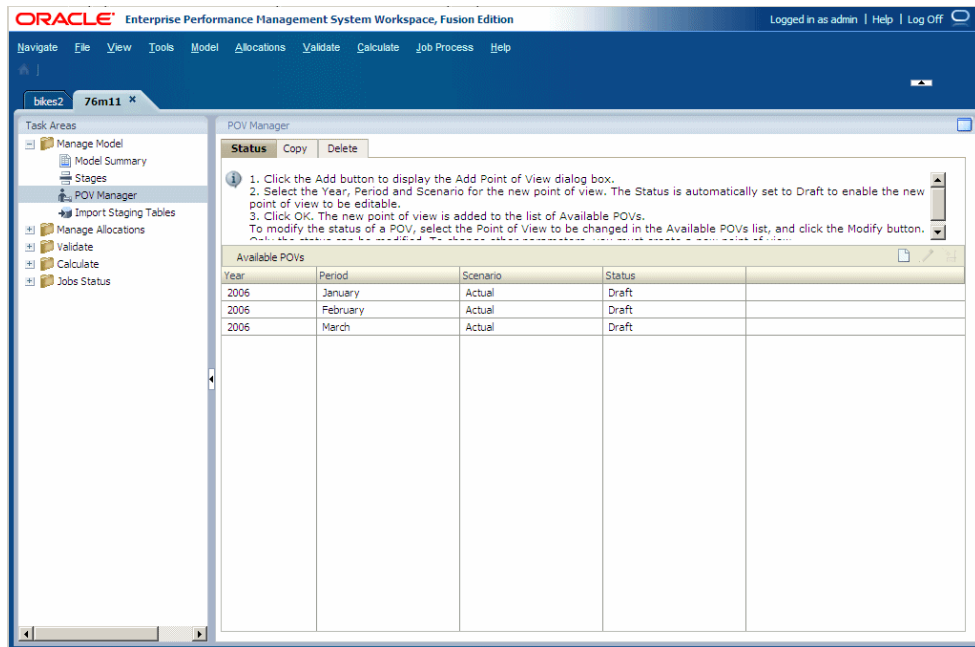

2. Click **Add new POV** .

The Add Point of View dialog box is displayed.

Add Point of View

Year: 2005

Period: January

Scenario: Actual

Status: Draft

Buttons: Help, OK, Cancel

3. Select the parameters in the model to identify the new POV.

Because this is a new POV, the Status is read-only, and set automatically to Draft to enable you to build and edit the model.

4. Click **OK**.

The POV is added to the list.

Modifying the Standard Profitability POV Status

The POV Status displays the availability of the model for editing or viewing. A model is available for editing only when the POV Status is set to Draft. When the model is finalized, change the POV status to ensure it cannot be modified.

The POV status can be set to one of these values:

- Draft — build or edit the model, and generate dynamic reports.
- Published — view the model or generate dynamic reports.
- Archived — view the model or generate dynamic reports.

You can change the status back to Draft at any time, in order to edit the model.

 **Note:**

If you modify the POV, only the status is changed; however you are no longer able to calculate the model if the status has been set to "Published" or "Archived".

To change the POV status:

1. In an open model, from **Task Areas**, select **Manage Model**, then **POV Manager**.
The Status tab of the POV Manager screen is displayed. All existing POVs are listed.
2. Select the POV that is to be modified, then click **Edit POV** .
3. Under **Status**, select the new status:
 - Draft
 - Published
 - Archived

Only the POV status can be changed. To modify any other parameters, you must create a new POV.

4. Click **OK**.

Copying Standard Profitability POVs

You can copy a POV to provide a starting point for a new model or scenario, or to play what-if scenarios with an existing model.

For example, you can begin a period by copying driver selections and assignments from the previous period, or you can create seed data for a forecast scenario by copying data from an actual scenario.

To copy the POV, you must have a Source POV, which contains the information to be copied, and a Target POV, which is destination to which the data will be copied. You can copy information only to POVs with the Status of "Draft" that are listed on the Status tab of the Manage POVs screen. See [Adding Standard Profitability POVs](#).

 **Note:**

For information on all Profitability and Cost Management dimension types, see [Dimension Types](#).

To copy POVs:

1. **Optional:** If required, create a POV on the Status tab of POV Management to provide the target POV for the copy operation. See [Adding Standard Profitability POVs](#).
2. In an open model, from **Task Areas**, select **Manage Model**, then **POV Manager**.
The Status tab of the POV Manager window is displayed. All existing POVs are listed.
3. From POV Manager, select the **Copy** tab.

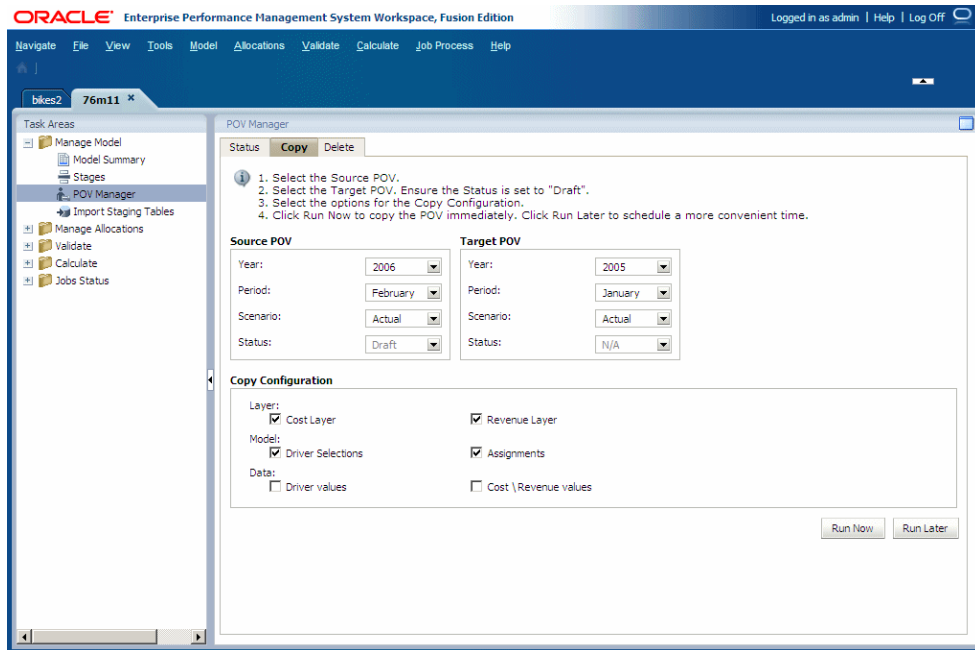

4. Under **Source POV**, select the POV that is to be copied.

Note:

The Status for the Source is automatically set to the status assigned to this POV, and cannot be modified on this screen.

5. Under **Target POV**, select the POV that is to be the destination for the copied POV.

Caution:

The Target POV must exist as a valid POV with the Status of "Draft" on the Status tab of the POV Manager screen, or the copy operation will not start.

6. Under **Copy Configuration**, select the elements of the POV that are to be copied:
 - Under **Layer**, select **Cost Layer**, **Revenue Layer**, or both.

- Under **Model**, select **Driver Selections, Assignments**, or all.
- Under **Data**, select **Driver values, Cost/Revenue values**, or both.

These options enable you to control the information that is required for the new POV. For example, you may want to include only cost, driver selection and driver values in the POV copy.

7. Perform one of the following tasks:

- Click **Run Later** to schedule a date and time to copy the POV. See [Scheduling Task Flows](#)

 **Note:**

If this option is not selected when the task is created, you will not be able to schedule the task.

- Click **Run Now** to copy the POV immediately.

A confirmation message indicates that the job has started and identifies the assigned taskflow ID. Select **Jobs Status**, and then **Search Task** to monitor the status.

 **Caution:**

Depending on the size and complexity of the model, this operation may take a significant amount of time.

8. When the copy is complete, review the copied information under the target POV.

Deleting Selected Objects from Standard Profitability POVs

Using the Delete tab of the POV Manager screen, you can delete selected objects from a POV.

To delete an entire POV, including its associated assignments and driver selections, see [Deleting Standard Profitability POVs and All Artifacts](#).

 **Caution:**

Oracle recommends that, before deleting a POV, you create a backup directory of the databases in Oracle Hyperion Enterprise Performance Management Workspace and Oracle Essbase. Contact the administrator for assistance, if required.

To delete selected objects from POVs:

1. Ensure that no other users require the POV and its contents.
2. In an open model, from **Task Areas**, select **Manage Model**, then **POV Manager**.
The POV Manager screen is displayed.
3. Select the **Delete** tab.

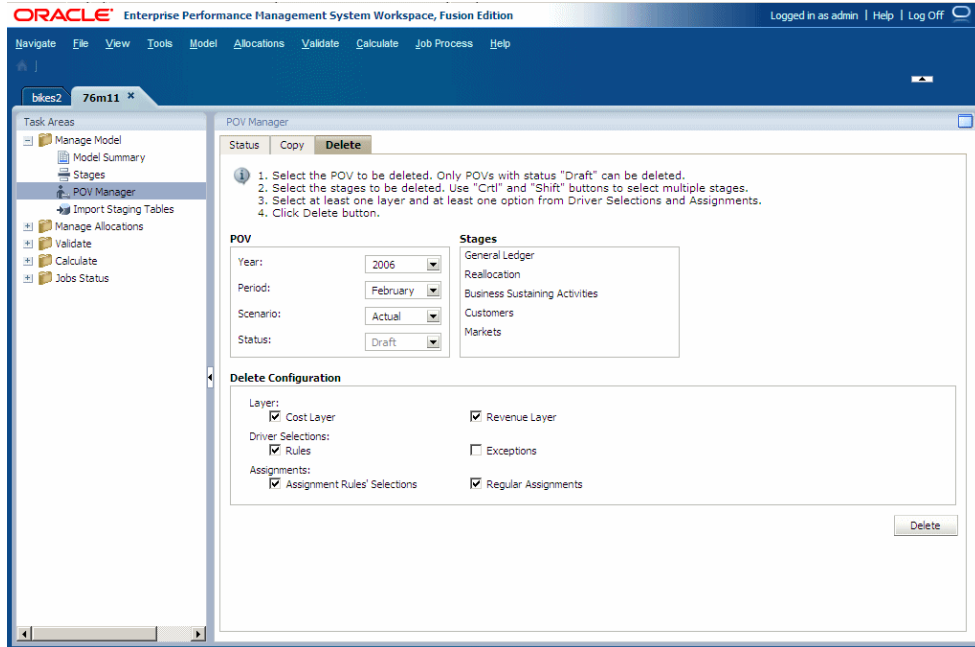

4. Under **POV**, select the POV that contains the artifacts that you want to delete.
5. Under **Stages**, select one or more source stages that contain the artifacts to be deleted.

You can use the Ctrl key to select multiple, random stages, or the Shift key to select the first and last stages in a range.

6. Under **Delete Configuration**, select the elements of the configuration that are to be deleted:
 - Driver Selections (Rules or Exceptions or both)
 - Assignments (Assignment Rule Selections or Regular Assignments or both).
7. Click **Delete**.

A confirmation message is displayed.

8. Click **OK** to confirm the deletion.

The selected records are removed. See `hpcm.log` to view a record of the operation, including the selections and the number of records expunged.

Deleting Standard Profitability POVs and All Artifacts

When a POV is deleted, all objects within that POV are deleted, including the associated assignments and driver selections.

To erase data in Oracle Essbase, before deleting the POV, perform the "Clear All" function for the selected POV. See [Calculating Direct Allocation Data](#).

▲ Caution:

Oracle recommends that, before deleting a POV, you create a backup directory of the databases in Oracle Hyperion Enterprise Performance Management Workspace and Essbase. Contact the administrator for assistance, if required.

To delete POVs and their associated assignments and drivers:

1. Ensure that no other users require the POV and its contents.
2. **Optional:** To erase data in Essbase, select **Clear All** data as described in [Calculating Direct Allocation Data](#).
3. In an open model, from **Task Areas**, select **Manage Model**, then **POV Manager**.

The POV Manager screen is displayed.

4. Select the **Status** tab.
5. Under **Available POVs**, select the POV you want to delete.
6. Click **Delete POV** 

A confirmation message is displayed.

▲ Caution:

When a POV is deleted, all objects within that POV are deleted.

7. Click **Yes** to confirm the deletion.

The POV is removed from the list and is no longer available for selection.

Querying Standard Profitability Model Statistics

After a model is built, it may be useful to determine the number and usage of certain components, such as stages or POVs and their dimensions, assignments, and drivers.

The SQL-based query, `modelstats.sql`, enables users to generate specific statistics for their models. These read-only queries can be used to view model characteristics and performance statistics, or to evaluate the impact of changes. The statistics can also be used to diagnose problems with models and performance.

In order to use the new query, you must have existing database views:

- Stages (HPM_EXP_STAGE)
- POVs (HPM_EXP_POV)
- Driver Selections (HPM_EXP_DRIVER_SEL)
- Assignments (HPM_EXP_ASSIGNMENT)
- Assignment Rule Selections (HPM_EXP_ASGN_RULE_SELECTION)

 **Note:**

The Drivers view (HPM_EXP_DRIVER) is not used with model statistics.

You must have proper access to the selected database and database views. For information on creating database views, see Appendix B, in the *Oracle Hyperion Profitability and Cost Management Administrator's Guide*.

After installation, the SQL script, `modelstats.sql`, is included in the application folder. The query is database neutral and can be run against MS SQL or Oracle databases. If the model contains errors, they are not reported in the query results, and the existing statistics are still generated.

Oracle recommends that you run the query for any application before you make significant changes and then save the queries and capture the output for comparison with later results. This snapshot provides you with baseline statistics for the application, against which you can compare subsequent changes or view information to evaluate the potential impact of proposed changes. For example, if an assignment rule is used thousands of times, any modification to that rule may have a much larger effect than originally expected.

To run the `modelstats.sql` query:

1. Locate the database and ensure you have proper access to the following items:
 - Database Views
 - Profitability and Cost Management RDB Schema
2. Navigate to the `modelstats.sql` query:
 - For Windows, `%hyperion_home%\products\Profitability\database\Common\MSSQLServer\view`
 - For UNIX, `$hyperion_home$/products/Profitability/database/Common/MSSQLServer/view`

 **Note:**

Because database views and queries are updated frequently, check to ensure that you have the latest versions.

3. Open the `modelstats.sql` query, and modify the "%" variable for each query to specify the model components against which the query is to be run, such as `"application_name like '%'",` or `"layer_name like '%'"`.

For example, in the code `application_name like '%'`, replace the percentage sign with the application name:

```
application_name like 'bikes2'
```

 **Note:**

You can use the percentage sign as a trailing wildcard to broaden the query range. For example, enter 'b%' to apply the query to all applications that begin with "b". To query all applications, enter '%'

4. Review the query results.

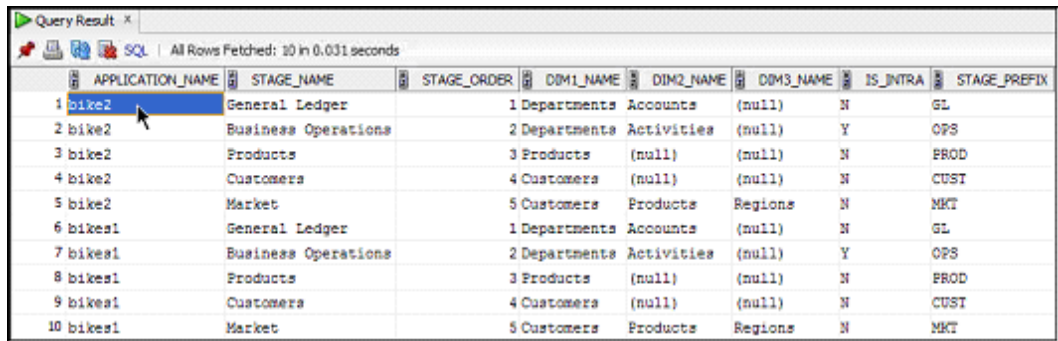

	APPLICATION_NAME	STAGE_NAME	STAGE_ORDER	DIM1_NAME	DIM2_NAME	DIM3_NAME	IS_INTRA	STAGE_PREFIX
1	bike2	General Ledger	1	Departments	Accounts	(null)	N	GL
2	bike2	Business Operations	2	Departments	Activities	(null)	Y	OPS
3	bike2	Products	3	Products	(null)	(null)	N	PROD
4	bike2	Customers	4	Customers	(null)	(null)	N	CUST
5	bike2	Market	5	Customers	Products	Regions	N	MKT
6	bikes1	General Ledger	1	Departments	Accounts	(null)	N	GL
7	bikes1	Business Operations	2	Departments	Activities	(null)	Y	OPS
8	bikes1	Products	3	Products	(null)	(null)	N	PROD
9	bikes1	Customers	4	Customers	(null)	(null)	N	CUST
10	bikes1	Market	5	Customers	Products	Regions	N	MKT

The results depend on the query selections. Some example queries are displayed below:

- **List All Stages and the Dimensions in the stage for matching Applications** displays all stages and the associated dimensions for the selected application, ordered by the application name and stage order.
- **List explicit Assignment counts by source Stage for both Cost & Revenue Layers** for the selected application, displaying the application name, layer, and source and destination stage names.
- **List Rule Names and how frequently they are used in an Application** displays a breakdown of individual rules and the number of times each one is used.
- **List the Driver usage count by stage in Driver Association** displays the usage count of each driver for the selected application, stage, and layer. As an example, you can use this information to determine whether some drivers are not really used, and whether you can safely delete them.

To view all queries, review the most current version of the `modelstats.sql` file.

Importing Standard Profitability Data and Artifacts

You can enter data and model information directly into Oracle Hyperion Profitability and Cost Management; however, the data entry may be very time-consuming.

To facilitate the population of the application, you can import model definitions, such as POVs, stages, drivers, driver selections, assignments, and assignment rule selections, directly into Profitability and Cost Management using a set of import staging tables and import configurations.

 **Note:**

Dimensions, costs, driver data, and assignment rules cannot be imported from staging tables.

Model data is imported from several sources:

- Model definition data is imported from staging tables.
- Model definition can be imported using Oracle Hyperion Enterprise Performance Management System Lifecycle Management. See the *Oracle Enterprise Performance Management System Lifecycle Management Guide*.

 **Caution:**

Oracle recommends that, before importing data or artifacts, you create a backup directory of the databases in Oracle Hyperion Enterprise Performance Management Workspace and Oracle Essbase. Contact the administrator for assistance.

In order to import staging tables, you must create an import configuration to specify which tables are to be imported. The configuration, which can be saved, can be used multiple times to import the same set of data. When importing the complete model, there are table dependencies that apply; however, these dependencies are not applicable if you are only importing sections of the model

For detailed instructions on creating staging tables and import configurations, see the *Oracle Hyperion Profitability and Cost Management Administrator's Guide*.

Managing Standard Profitability Allocations

Related Topics

- [About Standard Profitability Allocations](#)
In Oracle Hyperion Profitability and Cost Management, allocations control how costs and revenues are distributed throughout the model to specified accounts or elements.
- [Standard Profitability Cost and Revenue Layers](#)
When the drivers are created in a model, they are assigned to a cost or revenue layer, or both.
- [Defining Drivers and Formulas for Standard Profitability Models](#)
While assignments direct the data from a source to a destination, the drivers that are associated with these assignments are used to calculate the value of the allocations.
- [Selecting Standard Profitability Drivers](#)
After you create a driver, you must associate it with the dimension members to which it applies.

- [Working with Standard Profitability Assignments](#)
While the driver definition determines how cost and revenue flows are calculated, assignments specify where you want the calculated revenue and costs to be allocated.
- [Working with Standard Profitability Assignment Rules](#)
Assignments specify where allocation results are directed.
- [Using the Data Entry Window](#)
Use the Oracle Hyperion Profitability and Cost Management Data Entry window to directly add, edit, and verify data.
- [Tracing Allocations](#)
Using the Trace Allocations feature, you can visually follow the flow of funds through the model from beginning to end.
- [Reciprocal Allocation](#)
The net reciprocal cost for reciprocal allocations is calculated and reported on the Trace Allocations screen.
- [Exporting Trace Allocation Images](#)
After generating the trace allocation diagrams, you can export the image to another location for printing or viewing.

About Standard Profitability Allocations

In Oracle Hyperion Profitability and Cost Management, allocations control how costs and revenues are distributed throughout the model to specified accounts or elements.

A driver is used to determine how the funds for each allocation are calculated. The calculated results are assigned from a source to a destination, as the funds flow through the model.

See these sections for information about managing allocations:

- [Standard Profitability Cost and Revenue Layers](#)
- [Defining Drivers and Formulas for Standard Profitability Models](#)
- [Selecting Standard Profitability Drivers](#)
- [Working with Standard Profitability Assignments](#)
- [Using the Data Entry Window](#)
- [Tracing Allocations](#)

Standard Profitability Cost and Revenue Layers

When the drivers are created in a model, they are assigned to a cost or revenue layer, or both.

The cost and revenue members are treated as two separate layers of financial data. The cost layer reflects outgoing values from the model (such as expenses, rent, salaries, and so on). The revenue layer represents incoming values (such as sales earned, product or maintenance revenue, and so on).

Although the layers may be virtually identical in structure, each layer uses different drivers and assignments and produce different results. In general, you work with one layer at a time.

See [Defining Drivers and Formulas for Standard Profitability Models](#).

Defining Drivers and Formulas for Standard Profitability Models

While assignments direct the data from a source to a destination, the drivers that are associated with these assignments are used to calculate the value of the allocations.

The drivers provide the formulas for allocating source intersection values to destination intersections. Driver measures and formulas promote model flexibility by enabling you to use variables to represent model elements, and mathematical operands to calculate driver values.

Allocations range from simple calculations between one source and one destination, to complex calculations that are distributed to multiple destinations. When you create a driver, you associate a formula to control how the value is calculated. You can select from predefined formulas, such as an even split or percentage driver, or create custom formulas.

Driver measures, such as Volume and Rate, are used as variables in the construction of the formulas that drive the calculations. Any 0-Level member of the Measures dimension may be selected as a driver measure. Driver measures are created and stored in the Oracle Essbase database, but are not validated until the model is deployed.

Drivers can be applied to both cost and revenue values, and can be reused with many values. The formula associated with the driver is stored, not the data. If the driver is modified, the changes are automatically applied to every allocation using that driver.



Note:

If a driver used in the allocation is modified or deleted, you must regenerate the calculation script, and recalculate the model. The Essbase database structure is not impacted by this type of change, but it will calculate different results.

For each driver required in the model, perform these tasks:

- Define the new driver, including the model layer to which it is attached, and the associated formula. See [Defining Drivers](#).
- Associate the driver with dimension members that use this calculation. See [Selecting Standard Profitability Drivers](#).
- Assign the driver to the selected members of the driver dimension to set the calculation flow. [Working with Standard Profitability Assignments](#).

One dimension must be selected as the driver dimension for each stage. The driver formula is used to obtain the driver Value and then calculate the result.

For example, during the calculation process, the value for the "NetCostForAssignment" measure of the source intersection is multiplied by a factor to determine the amount to allocate to each destination intersection. The calculated amount is placed in the "CostReceivedPriorStage" measure of the destination intersection (or the "CostReceivedIntraStage" measure, if it is an intrastage assignment).

The driver factor is the ratio between the driver value of the destination intersection that is currently being calculated and the total driver value of all destination

intersections. The value for the current destination intersection is stored on the assignment in the "CalculatedDriverValue" driver measure. The total for all drivers is stored in the "TotalDriverValue" driver measure. An "OverrideTotalDriverValue" driver measure is entered on the source intersection only if tracking idle costs is enabled. Driver totals are always attached to the source.

For information and instructions about working with formulas and drivers, see these sections:

- [Driver Formulas](#)
- [Defining Drivers](#)
- [Modifying Driver Definitions](#)
- [Creating New Driver Definitions From Existing Driver Definitions](#)
- [Deleting Driver Definitions](#)

Driver Formulas

A driver formula can include any combination of variables, functions, and numeric values. For each element in the driver formula, you must select the driver measure and location.

Drivers are attached to source member intersections in allocations. The driver contains the formula used to calculate the factor by which measures are multiplied for the source intersection value. A separate factor is calculated for each destination intersection.

These types of driver formulas available:

- [Predefined Driver Formulas](#) are used to perform common calculations. See [Predefined Driver Formulas](#).
- [Custom Driver Formulas](#) are used to calculate unusual or specific situations. See [Custom Driver Formulas](#).
- [Driver Basis Types](#) offer alternative means of setting rates on a formula. Actual basis drivers use calculated results, and the standard basis driver enables you to set an assigned rate on a driver to allocate the costs downstream. See [Driver Basis Types](#).
- [Priority Sequence Drivers](#) are used to define which allocations within a stage should be calculated first

Predefined Driver Formulas

Drivers use predefined formulas to perform common calculations. For each element in the driver formula, you must select the driver measure and location. For predefined drivers, the formula is set in the calculation script.



Note:

The same driver measure cannot be mapped to a different variable in the formula. For example, in the formula `"DriverValue"={Rate}*{Quantity}`, you cannot select the same measure for both Rate and Volume.

The various driver types and the predefined formulas that they use are described in [Table 1](#).

Table A-9 Predefined Drivers

Driver Type	Driver Formula	Available Locations	Description
Even	Calculated DriverValue = 1.0;	None	Applies the same value to all measures using this driver.
Simple	Calculated DriverValue = {FixedDriverValue};	<ul style="list-style-type: none"> • Source • Destination • Assignment • Global 	Applies a preset value for the driver to each measure using the driver.
Percentage	Calculated DriverValue = {Percentage};	<ul style="list-style-type: none"> • Source • Destination • Assignment • Global 	<p>Enter a set percentage of the total value on an assignment destination on the Data Entry page or directly into Oracle Essbase.</p> <p>For example, if there are three measures, you may allocate 30% to the first assignment, 65% to the second and 5% to the third.</p> <p>If the percentage total is less than 100% and idle capacity is enabled on the driver, the unallocated remainder is treated as idle capacity.</p> <p>When using percentage drivers, if the TotalDriverValue (the sum of all driver values) is greater than 100, the driver is treated as a Simple Driver and the allocations are performed. The result is full allocation of source to the destinations based on the ratio of percentage values entered.</p> <p>Note: If a Percentage driver is used in reciprocal allocations, the TotalDriverValueAfterReciprocals must always be a value less than 100, in order to avoid "Unassigned Costs". Any allocations performed after the reciprocal relationships are resolved converts the Driver to a simple driver.</p>
Simple Weighted	Calculated DriverValue = {FixedDriverValue}* {Weight};	<ul style="list-style-type: none"> • Source • Destination • Assignment • Global 	Enter a value that you specify to represent the weight, or relative importance, for the task or process.

Table A-9 (Cont.) Predefined Drivers

Driver Type	Driver Formula	Available Locations	Description
Variable	Calculated DriverValue = {Rate}* {Quantity};	<ul style="list-style-type: none"> • Source • Destination • Assignment • Global 	Applies the result of the calculation of the rate and volume to each measure using that driver.
Weighted Variable	Calculated DriverValue = {Quantity} * {Rate} * {Weight};	<ul style="list-style-type: none"> • Source • Destination • Assignment • Global 	<p>Enter a value that you specify to represent the weight, or relative importance, for the task or process.</p> <p>For example, the formula might represent the number of technical support calls in a department, weighted by the length or complexity of each type of call.</p> <p>As another example, the formula could represent the assignment of staff to different tasks — each one weighted slightly differently to distinguish different pay grades or responsibilities.</p>
Fixed and Variable	Calculated DriverValue = {FixedDriverValue} + ({Quantity} * {Rate} * {Weight});	<ul style="list-style-type: none"> • Source • Destination • Assignment • Global 	Applies the result of the calculation of the quantity and volume, multiplied by the rate and weight for each measure using that driver.
Custom	Calculated DriverValue = {Custom Variable};	<ul style="list-style-type: none"> • Source • Destination • Assignment • Global 	See Custom Driver Formulas for information on creating custom formula types.

Custom Driver Formulas

If the predefined driver formulas do not accurately reflect the required calculation flow for the model, you can create a custom driver formula using the Formula Editor. The formula created to calculate the driver value may be simple, or it may be a complex formula that includes IF statements.

The assignment for which the custom driver is used automatically provides the FIX context in the calculation script. The formula should be defined considering the FIX context. The FIX context always FIXes on assignment blocks for the assignment. For information on the FIX command, see the *Oracle Essbase Database Administrator's Guide*.

A custom formula can include unlimited variables, both custom and predefined, such as Volume or Rate. The custom variables must be defined in the Profitability Applications Console in the Measures dimension.

You can additionally specify a location for a variable used within the custom formula to enable the custom formula to be used in different stages. The Location (Global, Source, Destination or Assignment) must be defined with the variable using curly brackets ({}), even though curly

brackets are not used in Oracle Essbase. The location is resolved dynamically during calc script generation.



Note:

If a location for a variable is not specified, it is considered to be an Assignment.

You can use functions (operands) between elements to control the formula calculation, including simple operands such as the following examples:

- Add (+)
- Subtract (-)
- Multiply (*)
- Divide (/)

Each formula must end with a semicolon(;).

This example displays a generic format for a custom driver formula:

```
"CalculatedDriverValue" = {Custom Variable -> Source} * {Custom Variable -> Destination};
```

The following example displays a custom driver formula which does not use any location syntax:

```
"CalculatedDriverValue" = "Variable1" * "Variable2" -> "[GL Departments].[NoMember]";
```

Custom formulas must be mathematically correct, and syntactically correct according to Essbase syntax, with the following exceptions for Oracle Hyperion Profitability and Cost Management:

- Custom Variables (driver measure) and Locations (Global, Source, Destination or Assignment) must be enclosed in curly brackets, even though curly brackets are not used in Essbase.
- Variables specified using the Profitability and Cost Management syntax should not be surrounded by double quotes.

Profitability and Cost Management resolves and translates the location syntax into Essbase syntax. After resolving the correct dimensional references on any variables with locations that use Profitability and Cost Management syntax, the formula is copied into Essbase calculation scripts and verified for Essbase syntax within the scripts.

For instructions on using the Formula Editor to create custom formulas, see the *Oracle Essbase Database Administrator's Guide*.

Custom Driver Formula Examples

The custom driver formula examples assume the following values:

- Stage 1 Dimensions: GL_Department x GL_Account
- Stage 2 Dimensions: ACT_Department x ACT_Activity

The calculation script generation process in Oracle Hyperion Profitability and Cost Management inserts the script defined for a custom driver for any source that uses this driver. The system-generated script creates the FIX statements to pinpoint the source and destination combinations defined by the assignment logic attached to the source.

The custom driver script need not provide this FIX, but it can take advantage of it, or modify the FIX to reference data from different locations that is normally defined for the *Destination*, *Source*, *Assignment*, or *Global* measure locations.

Common uses for custom drivers rely on the ability to reference data that is stored in locations other than the normal four, enabling the user to enter driver measures at higher levels in the hierarchy or at fewer intersections.

The default FIX statement that the CalculatedDriverValue measure computed reflects the link between source and destination. Using the example stages, the FIX created by the system-generated script is shown below:

```
GL_Department.member x GL_Account.member x ACT_Department.member x
ACT_Activity.member
```

where the dimension members for each dimension reflect the source intersection and destination intersection for the allocation being performed.

The examples below modify this default FIX to retrieve driver measures from another location. Remember that if the member referenced by the default FIX is correct for the purposes you need not override it.

Example 1: Referencing a driver measure located at only one of the destination dimensions cross NoMember in the other (in this case ACT_Department)

```
"CalculatedDriverValue" = "DriverMeasure" ->[ACT_Activity.NoMember] -
>[ GL_Department.NoMember] ->[ GL_Account.NoMember];
```

Use this formula when there is a single driver value for the entire department; for example, square feet, meters, or headcount.

Example 2: Referencing a driver measure located at the parent of one of the destination dimensions cross NoMember in the other dimension:

```
"CalculatedDriverValue" = "DriverMeasure" ->[ACT_Activity.NoMember] "-
>(@PARENT(ACT_Department))" ->[ GL_Department.NoMember] -
>[ GL_Account.NoMember];
```

Alternatively, you can reference the Generation of the ancestor from which you want to retrieve the value using @ANCSET function. In this example, the driver pulls the DriverMeasure value from the Generation 2 ancestor of the destination's Department member:

```
"CalculatedDriverValue" = "DriverMeasure" ->[ACT_Activity.NoMember] "-
>(@ANCEST(ACT_Department, 2))" ->[ GL_Department.NoMember] -
>[ GL_Account.NoMember];
```

Other common uses are to key the driver value calculation on the nature of the source/destination combination. This option enables the driver to adapt to specific circumstances based on characteristics of the intersections involved in the allocation.

Example 3: Referencing a different measure for driver calculation based on the UDA of one destination member:

```
IF(@ISUDA(Activity, "UDA1"))
```

```
"CalculatedDriverValue" = {Measure1->Destination};
ELSE IF (@ISUDA(Activity, "UDA2"))
"CalculatedDriverValue" = {Measure2->Destination};
ELSE IF (@ISUDA(Activity, "UDA3"))
"CalculatedDriverValue" = {Measure3->Destination};
ENDIF;
```

Use this formula to key the driver formula from a characteristic of the destination, such as product form factor or customer classification. Note that the syntax in the example: `{Measure1->Destination}` does not match usual Oracle Essbase calc Script syntax. The use of the curly brackets (`{ }`) enables Profitability and Cost Management to interpret the `'->Destination'` shorthand, and to replace it with the actual destination being targeted. When the script is deployed to Essbase, Profitability inserts the correct member references and syntax.

Driver Basis Types

The basis types can be applied to drivers in both the Cost and Revenue layers. A single stage can contain both "Actual Basis" and "Standard Basis" drivers; however, if a driver is changed from one basis driver type to the other, the calculation script for the affected Stage must be regenerated.

When defining drivers, you can specify whether you want to use a calculated or assigned rate, using these driver basis types:

Actual Basis Driver Type

The Actual Basis costing uses the "NetCostForAssignment" value on the source to allocate costs downstream. The Actual Basis driver uses the formula:

```
CostReceivedPriorStage = NetCostForAssignment on the Source *
CalculatedDriverValue / TotalDriverValue on the Source
```

If Driver Data is missing, the results are posted on the Stage Balancing Report to 'Unassigned Cost' at the intersection and stage level.

Standard Basis Driver Type

In circumstances where seasonal variations or fluctuating account values exist because of the timing differences between accounting data capture and actual usage of resources, you can set a standard rate that allows for consistency of measurements across time periods.

Using the Standard Basis Driver, you set a precalculated standard rate on a driver on the source intersection to allocate the costs downstream. The driver uses the formula:

```
Standard Rate on the source * Quantity on the assignment
```

Sources using that driver allocate the product of the Standard Rate on the source, and the Quantity on the assignment to the destination intersections.

 **Note:**

The Standard Basis driver cannot be used with Even or Percentage driver types.

If Standard Basis is selected, "Allow Idle" is automatically activated. Standard basis drivers can be used on intrastage assignments; however, they cannot be used in reciprocal assignments.

When the user selects a Standard Basis Driver, the Rate is entered on the source in the Measures dimension variable `StandardCostRate` for the Cost Layer and `StandardRevenueRate` for the Revenue Layer. The `StandardCostRate` on the source can be done using cost input data entry screens. The "Quantity" portion is calculated based on how the Driver is defined.

The basis types can be applied to drivers in both the Cost and Revenue layers. A single stage can contain both Actual and Standard Basis drivers; however, if a driver is changed from one basis driver type to the other, you must regenerate the calculation script for the affected stage.

Priority Sequence Drivers

In some business models, a driver may use one or more calculated measures in the formula. Dependencies between sources in the same stage may require the allocations to be calculated in a controlled sequence. Priority sequence drivers enable you to define which allocations within a stage should be calculated first.

For example, by setting the driver priority, you ensure that Source A using Driver A is calculated before Source B, using Driver B. The cost or revenue values calculated by allocating Source A first can then be used by Driver B.

Any Level-0 descendant of the Measures dimension can be picked as a driver measure. When defining the driver, enter the Sequence Priority on the Drivers dialog box. The sources associated with drivers that have a lower priority are resolved before sources associated with a driver that has a higher priority. The default value is set to 100, but this value can be changed. The highest priority is 1. The priority must be a positive integer. Sources associated with drivers with the same priority are processed in no defined order.

If you change the priority for a driver, you are potentially changing the calculation order of sources in that stage. In that case, the calculation script for that stage must be regenerated.

 **Note:**

For intrastage and reciprocal assignments, if the inherent sequence inside these allocations conflict with the Driver Priority Sequence, the conflicting intersections are logged to `hpcm.log` file.

Defining Drivers

To define drivers:

1. In an open model, from **Task Areas**, select **Manage Allocations**, then **Driver Definitions**.

The Driver Definitions screen is displayed.

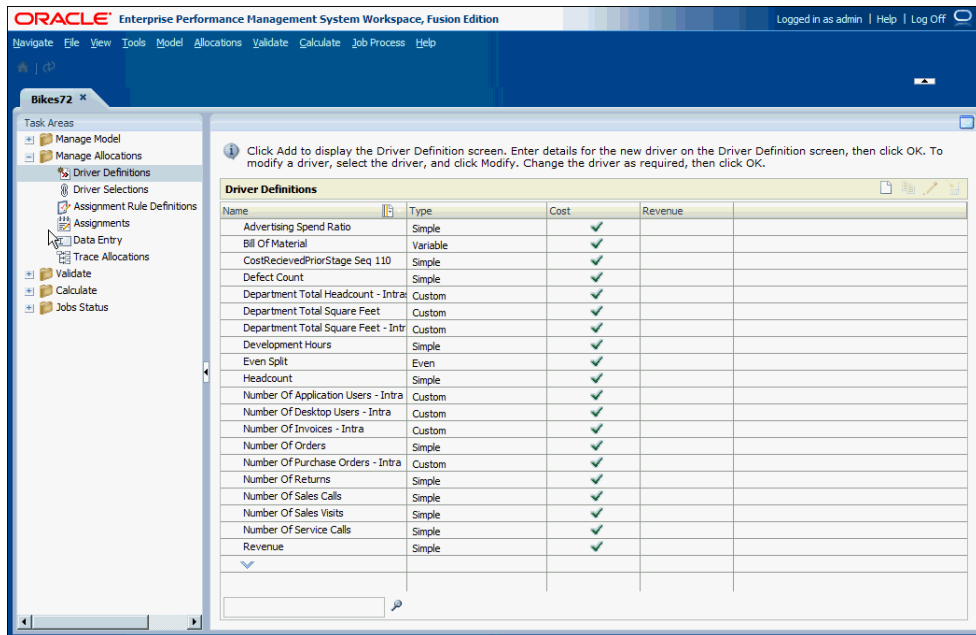

2. Click **Add** .

Drivers
✖

Name:

Description:

Basis Type:

Formula Type:

Cost Layer

Revenue Layer

Allow Idle

Sequence Priority:

Formula:

Template

Translated

```
"CalculatedDriverValue" = {Percentage};
```

Name	Measure	Location
Percentage	Percentage	Assignment

Help
OK
Cancel

3. In **Name**, enter a unique name for the new driver.

Do not use special or restricted characters, such as /, +, or @ signs, in the driver name, as this may cause import operations to fail. See the *Oracle Essbase Database Administrator's Guide* to view the latest restrictions.

▲ Caution:

Oracle strongly suggests that you review the Oracle Essbase naming conventions described in the *Oracle Essbase Database Administrator's Guide* to view the latest naming restrictions to avoid import failures.

4. **Optional:** In **Description**, enter a brief description of the purpose of the driver.
5. Select the **Basis Type** for the driver:

- **Actual**—To use the "NetCostForAssignment" value on the source to allocate costs downstream.
- **Standard**—To assign a user-determined standard rate to the driver on the source intersection.

See [Driver Basis Types](#).

6. From **Formula Type**, select a formula type for this driver:

- Even
- Simple
- Percentage
- Simple Weighted
- Variable
- Variable Weighted
- Fixed and Variable
- Custom

The formula type determines which variables are available for selection. For an explanation of each driver type, see [Defining Drivers and Formulas for Standard Profitability Models](#).

If you select a predefined formula, the actual formula is displayed in the Formula Template tab of the Formula text box. The driver measures that are available for each element are listed in Variable Selection.

If you select a Custom formula, the Formula text box is blank and can be edited.

7. Select the layer to which this driver applies:

- Cost Layer
- Revenue Layer
- Both Cost and Revenue layers

8. **Optional:** Select **Allow Idle** to enable this driver to accept idle costs or revenue. This option is automatically activated if the Standard Basis driver is selected.

After calculation, this information is reported under "IdleCost" or "IdleRevenue".

9. **Optional:** In **Sequence Priority**, enter a driver sequence priority. .

By default, 100 is displayed. The highest priority is 1. See [Priority Sequence Drivers](#)

10. **Optional:** For Custom formulas only, in **Driver Formula**, enter the user-defined formula.

Measures to be used for custom formula variables must already be defined in the Profitability Applications Console. Construct the formula using the Formula Editor, as outlined in the *Oracle Essbase Database Administrator's Guide*.

11. For each variable used in the formula, select these values:

- Under **Measure**, select the measure to be used for the formula.
- Under **Location**, select the location of the measure within the model, so the calculation script can locate the values:

- **Global**—The measure data is retrieved from the intersection formed by the current POV members. Members for all other dimensions are set to `NoMember`.
 - **Destination**—The measure data is retrieved from the intersection of the destination.
 - **Source**—The measure data is retrieved from the intersection of the source stage.
 - **Assignment**—The measure data is retrieved from the intersection of the destination and source stage.
12. **Optional:** On the **Formula** text box, select **Translated** to view the formula with the actual members displayed.
- If you select alternative members under the variable selection, the associated members are changed in the Translated formula.
13. Click **OK** to save the new driver.
- The driver is added to the list on the Driver Definitions screen, showing the name, formula type, sequence priority and layer.
14. Associate the driver with one or more dimension members. See [Selecting Standard Profitability Drivers](#).

Modifying Driver Definitions

You can modify any elements for a selected driver.

To modify drivers:

1. In an open model, from `Task Areas`, select **Manage Allocations**, then **Driver Definitions**.

The Driver Definitions screen is displayed.

2. Select the driver that is to be modified.

3. Click **Modify** .

The Driver dialog box is displayed, showing the current details for the driver.

4. Modify the Driver information as required.

You can change any details for the driver, including the name, description, formula type, layer, or variable selection.

If you modify the name, do not use special or restricted characters, such as `/`, `+`, or `@` signs, in the driver name, as this may cause import operations to fail. See the *Oracle Essbase Database Administrator's Guide* to view the latest restrictions.

Caution:

If you modify a layer associated with a driver, for example, clearing the Cost Layer, then all driver selections for the layer that use the modified driver are deleted.

5. Click **OK** to save the modified driver.

6. Regenerate the calculation script and recalculate the model to apply the driver change. See [Calculating Standard Profitability Models](#).

Creating New Driver Definitions From Existing Driver Definitions

Using the Create Duplicate Driver option, you can copy an existing driver definition, and assign the driver a new name. The copy can be modified as required.

This option enables you to rapidly create many similar drivers without having to reopen the Driver Definition dialog box.

To create new drivers from existing driver definitions:

1. In an open model, from **Task Areas**, select **Manage Allocations**, and then **Driver Definitions**.
The Driver Definitions screen is displayed.
2. Select the driver that you want to use as a template for the new driver definition.
3. Click **Duplicate Driver** .

The Create Duplicate Driver dialog box is displayed.

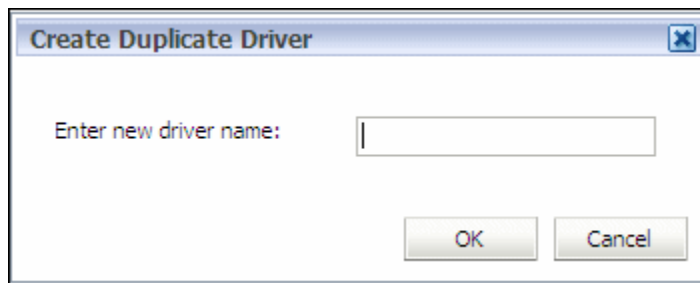

4. Enter the name of the new driver, and then click **OK**.

Caution:

Do not use special or restricted characters, such as /, +, or @ signs, in the driver name, as this may cause import operations to fail. See the *Oracle Essbase Database Administrator's Guide* to view the latest restrictions.

The new driver is added to the list of Driver Definitions, showing the same Type and Cost or Revenue details as the original driver.

5. Click **Modify**  to view details of the newly created driver.

The Driver dialog box is displayed, showing the current details for the new driver. If required, you can modify any details for the new driver, as outlined in [Modifying Driver Definitions](#).

Deleting Driver Definitions

⚠ Caution:

If a driver is deleted, all driver selections that used the deleted driver are also removed.

To delete drivers:

1. In an open model, from **Task Areas**, select **Manage Allocations**, then **Driver Definitions**.
The Driver Definitions screen is displayed.
2. Select the driver you want to delete.
3. Click **Delete** .
A message is displayed, asking you to confirm the deletion.
4. Click **Yes** to delete the driver.
5. Select another driver for the allocation to replace the deleted driver, in order to correctly calculate the allocation.
6. Regenerate the calculation script and recalculate the model. See [Calculating Standard Profitability Models](#).

Selecting Standard Profitability Drivers

After you create a driver, you must associate it with the dimension members to which it applies.

When you select drivers, apply a driver selection using these methods:

- Apply the driver to the top-level member of a dimension. The driver is inherited by every member within that dimension.
- Apply the driver to the top-level member of a dimension sub-hierarchy. Only descendants of the selected member inherit the driver.
- Apply the driver to a single member.
- Apply the driver to a single intersection, or exception.

Drivers must be associated with any intersection that contains a cost or revenue value for the value to be allocated. If a driver has not been assigned to an intersection that contains assignments or assignment rules, a "Missing Driver Assignments" error is created during model validation. Driver selections may change from period to period.

The results of any changes to selections are evident when the model is deployed; however, no warnings or errors are displayed if a selection is changed.

 **Note:**

If a stage contains only one dimension, a driver selection for a dimension member must be created. If a stage contains two dimensions, it may have either a driver selection for a dimension member, or a driver selection for a single intersection, or both.

For detailed instructions on working with driver selections, see these procedures:

- [Creating Driver Selections.](#)
- [Creating Driver Selections for a Single Intersection.](#)
- [Modifying Driver Selections.](#)
- [Modifying Driver Selections for a Single Intersection](#)
- [Deleting Driver Selections.](#)
- [Deleting Driver Selections for a Single Intersection](#)

Creating Driver Selections

To associate drivers:

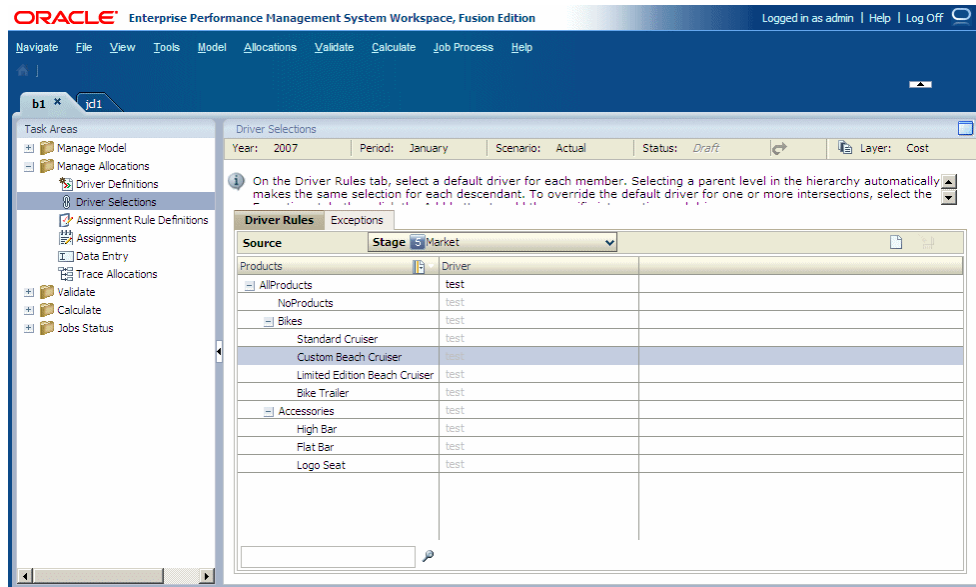

1. In an open model, from **Task Areas**, select **Manage Allocations**, then **Driver Selections**.

The Driver Selections screen is displayed.



2. Select a POV, and then click **Go** .
3. Select a Layer.
4. On the **Driver Rules** tab, under **Stage**, select the model stage.

The driver dimension for the selected stage is displayed in the first column, and all dimension members within that driver dimension are listed below.

5. Under the dimension, select the parent level or Level-0 members at which you want to apply the default driver. The parent level may be at the top of the stage, or a parent for a portion of the hierarchy.
6. Under **Driver**, click the cell to display the selector icon , or click **Add**  to select a driver for the parent dimension from the Common Selector, and then click **OK**. See [Using the Common Member Selector](#).

When the driver is applied to a parent, the same driver is automatically inherited by all descendants. To show the driver is inherited, it is grayed out.

7. **Optional:** To select a driver other than the inherited driver for one member, perform the following steps:
 - a. Expand the parent dimension.
 - b. Select the member that requires a different driver.
 - c. Select the alternative driver from the Common Selector. See [Using the Common Member Selector](#).

The driver selection is automatically saved.

8. **Optional:** If you need to set driver for a single intersection, see [Creating Driver Selections for a Single Intersection](#).

Creating Driver Selections for a Single Intersection

To select a driver for a single intersection:

1. In an open model, from **Task Areas**, select **Manage Allocations**, and then **Driver Selections**.
2. Select the POV and the Layer, then click **Go** .
3. Select **Exceptions**.

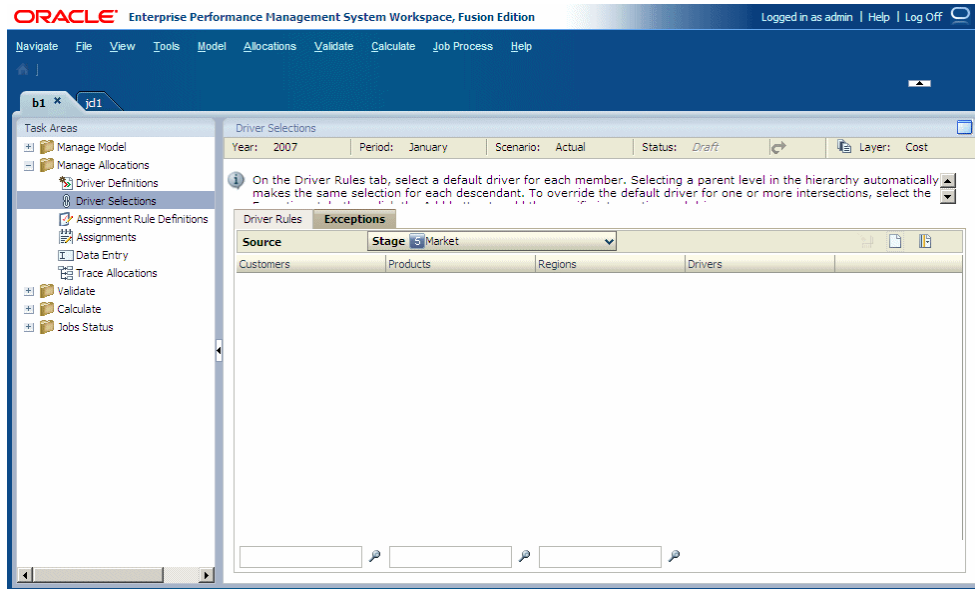

4. Under **Stage**, select the model stage that contains the intersection.
5. **Optional:** On the **Exceptions** tab, click **Member Selector**  to filter the list of available dimensions:
 - a. From the drop-down list, select **Show Alias** or **Show Name**, as required.

- b. Select the **Filter** .
- c. Enter the filter criteria for one or more dimensions.

Enter the exact name or alias of the required members, or use a trailing asterisk (*) as a wild card to select a range of members, or a trailing question mark (?) to select a single character. For example, to find all members of a dimension that begins with the letter "M", enter "M*". Entering the asterisk before the letter does not work, for example "*M."

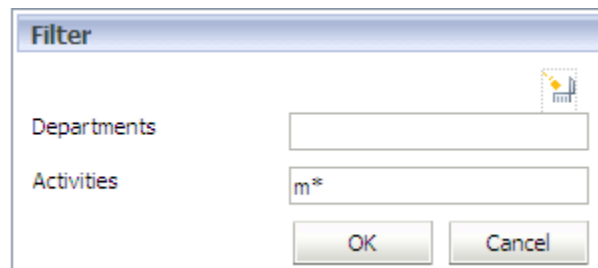

- d. Click **OK**.
Only the items that meet the filter criteria are displayed on the Exceptions tab.
6. Click **Add** .

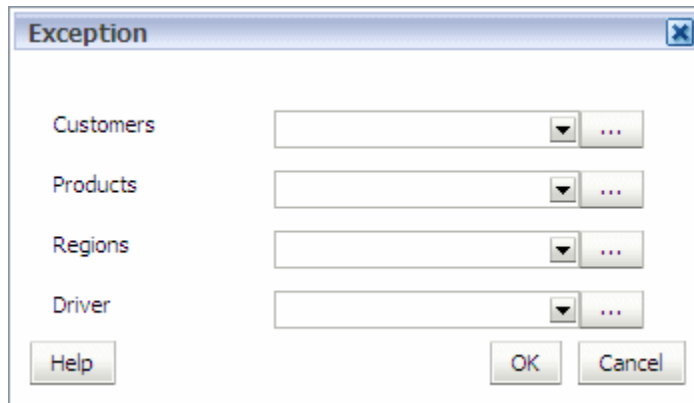

7. For each dimension listed on the Exception dialog box, click Selector  and select the members required for the specific intersection to which you need to apply the exception driver.
8. Click **OK** when all members for the intersection have been selected.
9. Under **Drivers**, select the exception driver for the intersection.
10. Click **OK**.

The driver selection is automatically saved and is displayed in the table.

Modifying Driver Selections

To modify driver selections:

1. In an open model, from **Task Areas**, select **Manage Allocations**, then **Driver Selections**.
2. Select a POV, and then click **Go** .
3. Select a Layer.
4. On **Driver Rules**, under **Stage**, select the model stage.

The driver dimension for the selected stage is displayed in the first column, and all members within that driver dimension are listed below.

5. Under **Driver**, click the cell that contains the driver to be modified to display the Common Member Selector, or click **Add**  to select another driver.
6. From the Common Member Selector, select another driver, and then click **OK**.

The driver selection is automatically saved.

Modifying Driver Selections for a Single Intersection

To select a driver for a single intersection:

1. In an open model, from **Task Areas**, select **Manage Allocations**, and then **Driver Selections**.
2. Select the POV and the Layer, then click **Go** .

3. Select the **Exceptions** tab.
4. Under **Stage**, select the model stage that contains the intersection.
5. Under **Driver**, click the cell that contains the driver to be modified.

The drop-down and Common Selector  are displayed.



6. Click **Selector**  to display the Select Member dialog box.
7. Select the dimension member required for the specific intersection.
8. Click **OK**.

The driver selection is automatically saved and is displayed in the table.

Deleting Driver Selections

If a driver selection is deleted, and no new driver is selected, an error is reported during validation to indicate that an assignment does not have a driver selection.

To delete driver selections:

1. In an open model, from **Task Areas**, select **Manage Allocations**, then **Driver Selections**.
2. Select a POV, and then click **Go** .
3. Select a Layer.
4. On **Driver Rule**, under **Stage**, select the model stage.
5. Select the row containing the driver selection to be deleted.
6. Click **Delete** .



A message asks you to confirm the deletion.

7. Click **Yes** to confirm the deletion of the driver.
- The driver is deleted from the row.

Deleting Driver Selections for a Single Intersection

Select the intersection that is to be deleted. The entire intersection is removed from the Exception tab.

To delete driver selections for a single intersection:

1. In an open model, from **Task Areas**, select **Manage Allocations**, then **Driver Selections**.
2. Select a POV, and then click **Go** .
3. Select a Layer.
4. Select the **Exceptions** tab.
5. Under **Stage**, select the model stage
6. Select the intersection to be deleted.
7. Click **Delete** .

A message asks you to confirm the deletion.

8. Click **Yes** to confirm the deletion.

The entire intersection is deleted from the row.

Working with Standard Profitability Assignments

While the driver definition determines how cost and revenue flows are calculated, assignments specify where you want the calculated revenue and costs to be allocated.

Assignments define the flow of data from sources to destinations. The flow is established by creating relationships between a source and destination for each node or intersection in the model, the destination for one member becoming the source for the next intersection in the allocation flow.

For each intersection of dimension members within a stage that contains source data, you assign downstream member intersections as destinations.

Assignments can only flow forward, or to the same stage. Cost and revenue allocations are traced from start to finish, and cannot flow backwards. Before a model can be calculated, the assignments are validated against internal flow rules to ensure the integrity of the model. You can skip stages in assignments. For example, a source intersection in Stage One could be assigned a destination in Stage Three.

The flow for a specific process may use some or all of the assignment types. See [Types of Assignments](#).

Assignments are controlled by one dimension member's intersection within each stage. Assignments are created for a specific Level-0 members' intersection. Assignments can be set individually, or you can create an assignment rule that can be used multiple times.

To create an assignment, select a valid POV and a layer (Cost or Revenue) to make a unique assignment for each time, period, scenario and layer combination. A Source may be applied in the source pane, and the destination is selected in the Destination pane. The destination can be an explicit node or intersection, or an assignment rule. For information on creating assignment rules, see [Working with Standard Profitability Assignment Rules](#).

For detailed instructions on working with assignments, see these sections:

- [Types of Assignments](#)
- [Creating Assignments](#)
- [Modifying Assignments](#)
- [Deleting Assignments](#)
- [Working with Standard Profitability Assignment Rules](#)

Types of Assignments

Assignments may be set in a variety of ways:

- **Interstage Assignments**—Have a source and destination combination located in different model stages. For example, an assignment from Stage 1 to Stage 2.
- **Intrastage Assignments**—Intrastage assignments are assignments for which the source and destination are located within the same stage.

- **Reciprocal Assignments**—Reciprocal assignments are intrastage assignments in which the source and destination for two or more processes transfer costs into each other. A simple reciprocal relationship is defined as the direct allocation from Intersection 1 to Intersection 2, and a direct allocation from Intersection 2 back to Intersection 1. Reciprocal assignments are always intrastage assignments.

▲ Caution:

Only simple reciprocal loops are supported in Oracle Hyperion Profitability and Cost Management. Complex reciprocal relationships are not supported. For example, a complex reciprocal loop, such as Intersection 1 to Intersection 2 and Intersection 2 to Intersection 3 and Intersection 3 to Intersection 1, is not supported.

As an example of a reciprocal loop, an assignment for the Human Resources department would transfer some portion of costs for processing payroll or employee reports to Information Technology, while costs for administering Information Technology personnel requirements would be allocated back to Human Resources. Each department is a support function that provides services to the other.

When creating the model, the reciprocal assignment is defined by the assignments that are set within the loop. When a reciprocal relationship is detected, a specialized calculation process is followed that resolves the reciprocal assignments first, then continues with the normal assignments.

If a Percentage driver is used in reciprocal allocations, the `TotalDriverValueAfterReciprocals` will always be a value less than 100, in order to avoid "Unassigned Costs". Any allocations performed after the reciprocal relationships are resolved would convert the Driver to a simple driver.

Creating Assignments

Assignments carry costs and revenues from one intersection to another, creating a financial flow within a model.

Oracle recommends the following flow:

1. Create all assignments for a process or allocation in sequence to ensure that all elements are captured.
2. Validate the model structure to verify that no appropriate driver selections are missing.

To create assignments:

1. In an open model, from `Task Areas`, select **Manage Allocations**, then **Assignments**.

The Assignments screen is displayed.

2. Select a POV for the selected model, and then click **Go** .
3. Select a Layer.
4. Beside **Source**, from the **Stage** drop-down list, select a model stage for the assignment.

The dimensions and members for the selected model stage are displayed.

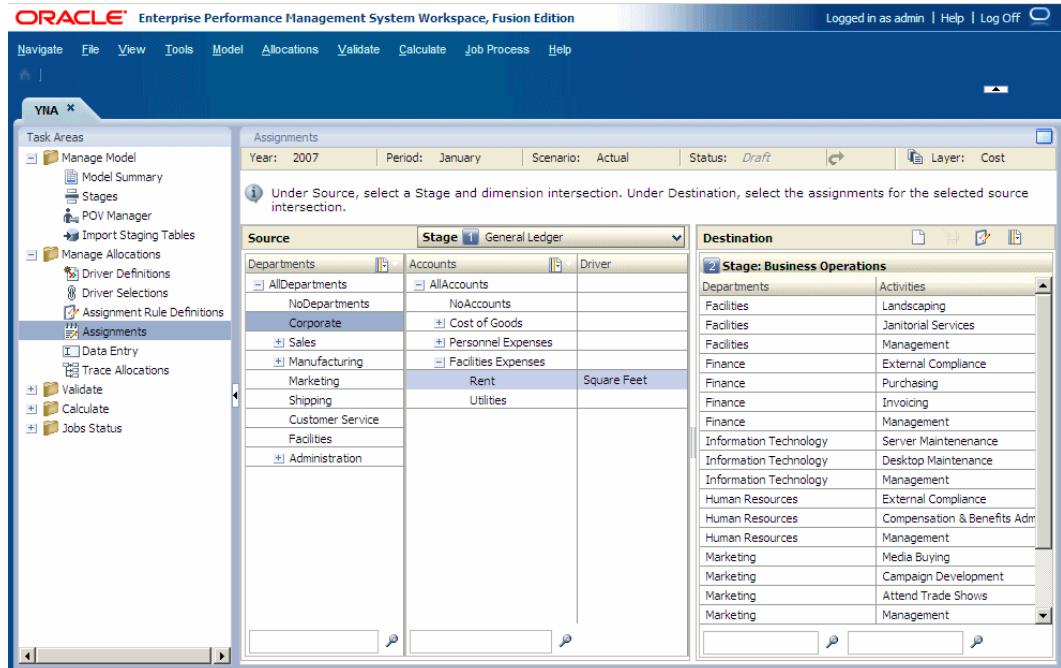

5. Under **Source**, select a member from each dimension to create the intersection for the source of the assignment.

The driver is identified in the Driver column. The Destination column is populated with the dimensions and members of the destination stages.

 **Note:**

To find a member in the hierarchy, type the member name in the text box at the bottom of the column, and then click Search.

6. **Optional:** Under **Destination**, select **Member Selector**  to filter the list of available destinations:

- a. From the drop-down list, select **Show Alias** or **Show Name**, as required.

- b. Select **Filter** 

- c. Enter the filter criteria in one or more dimensions, and then click **OK**.

Enter the exact name of the required members, or use trailing asterisk (*) as a wild card to select a range of members, or a trailing question mark (?) to select a single character. For example, to find all members of a dimension that begins with the letter "M", enter "M*". Entering the asterisk before the letter does not work, for example "*M."

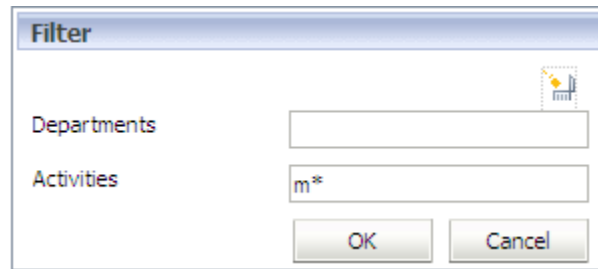

The Filter dialog box has a title bar labeled "Filter". It contains two input fields: "Departments" which is currently empty, and "Activities" which contains the text "m*". At the bottom of the dialog are two buttons: "OK" and "Cancel".

7. Under **Destination**, click **Add** .

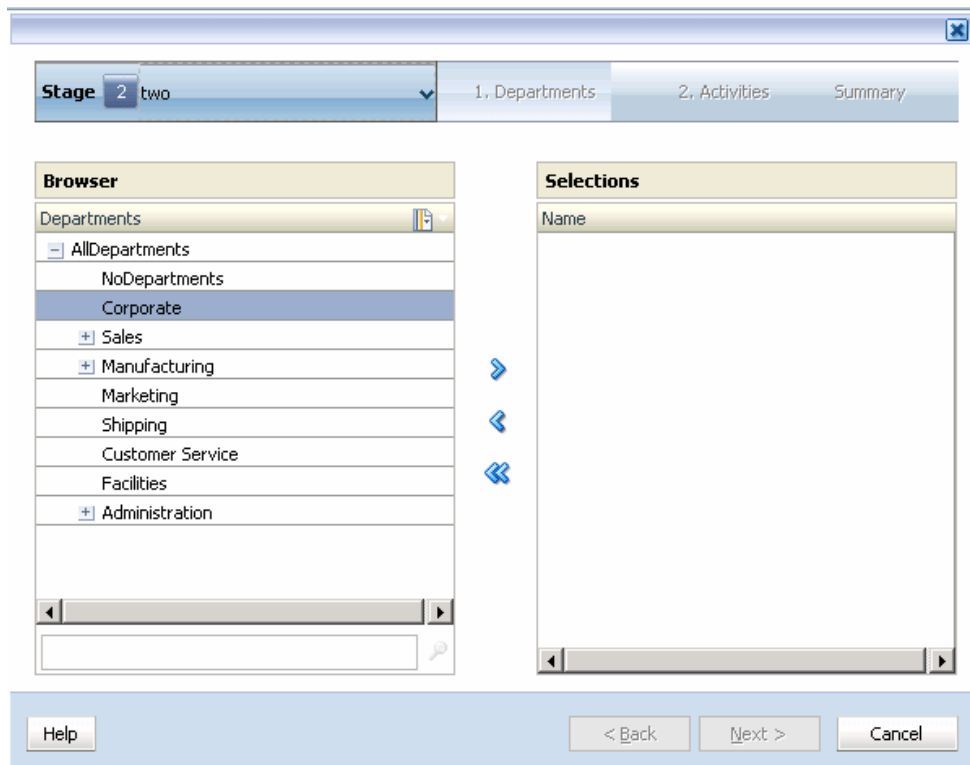

The main configuration window shows a "Stage" dropdown menu set to "2 two". Below the stage menu are three tabs: "1. Departments", "2. Activities", and "Summary". The "2. Activities" tab is active. On the left is a "Browser" pane showing a tree view of departments: "AllDepartments", "NoDepartments", "Corporate" (selected), "Sales", "Manufacturing", "Marketing", "Shipping", "Customer Service", "Facilities", and "Administration". On the right is a "Selections" pane with a "Name" header and an empty list. Between the panes are three arrow buttons: a right-pointing arrow, a left-pointing arrow, and a double left-pointing arrow. At the bottom are buttons for "Help", "< Back", "Next >", and "Cancel".



8. Under **Stage**, select the stage that is to be the destination for this assignment:
- For an interstage assignment, select any stage following the Source stage.
 - For an intrastage assignment, select the same stage as the Source stage.

 **Note:**

For stages that allow intrastage allocations, in which the source and destination intersections are within the same stage, the Oracle Essbase outline contains separate dimensions to store the destination intersection values. These dimension have the suffix '_intra'. For example, if the stage dimensions are OPS_Products and OPS_Activities, the destination data for intrastage allocations is stored in the OPS_Departments_intra and OPS_Activities_intra dimensions.

9. Under Step 1, select the first member of the intersection for the Destination of the assignment.
10. Click **Add**  to move the selected member to **Selections**.

 **Note:**

To remove a member from the Selections list, highlight the member to be removed, and click **Remove** . To remove the entire list, click the **Remove All** .

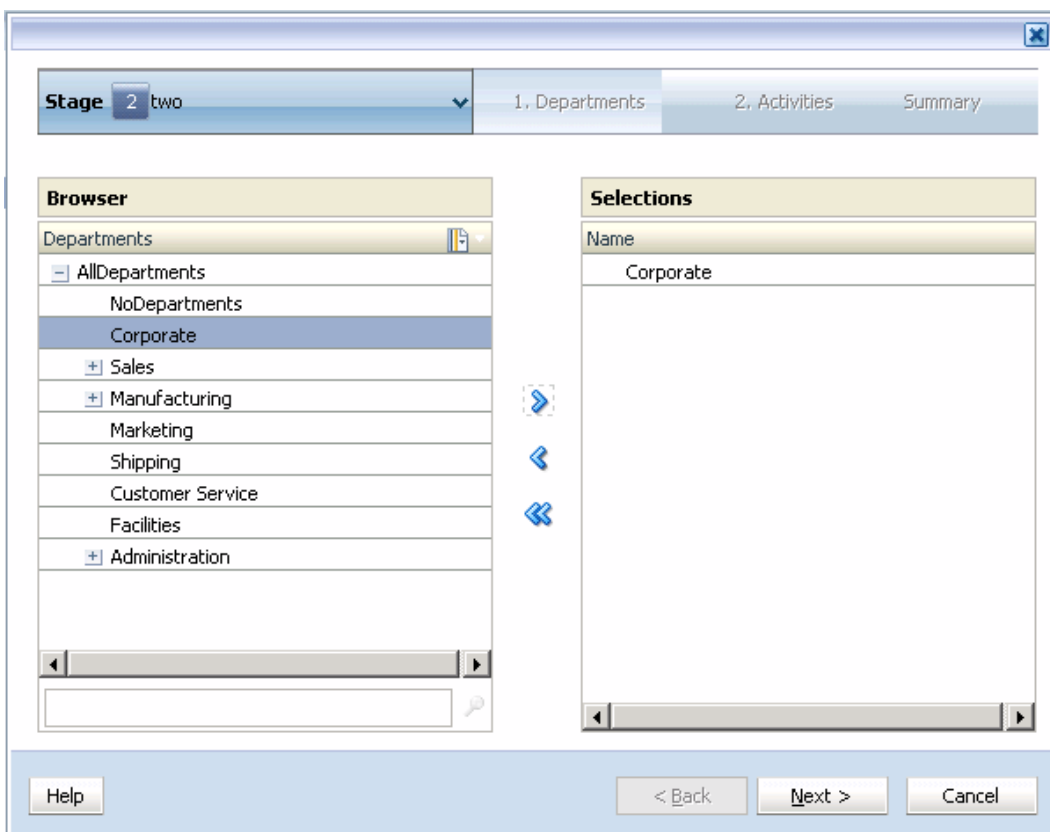

11. Click **Next**.
12. Under Step 2, select the second member of the intersection for the Destination of the assignment, and then click **Next**.
13. **Optional:** Repeat step 9 and step 10 to select additional members.
When all members have been selected, the Destination Selection Summary is displayed.



Selection Summary	
Departments	Activities
Corporate	Building Maintenance

14. Verify the selections are correct, and then click **Finish**.

Modifying Assignments

You can modify the destination of any assignment; however, you should be aware that any changes will affect the financial flow and the calculation results for the model.

To modify assignments:

1. In an open model, from **Task Areas**, select **Manage Allocations**, then **Assignments**.
The Assignments screen is displayed.
2. Select the POV and Layer of the model that contains the assignment to be changed, then click **Go** .
3. Under **Source**, select the model stage and the dimension members' intersection that contains the source of the assignment.
4. Under **Destination**, select the destination member to be modified.
5. Double-click the destination member cell, and edit the assignment. Begin typing the new member name, and then select the member from the drop-down list.
6. Verify that the modifications are correct.
7. Click **Save**  to save the changes.

Deleting Assignments

Caution:

The deletion of an assignment affects the financial flow and calculation results for the model.

To delete assignments:

1. In an open model, from **Task Areas**, select **Manage Allocations**, then **Assignments**.

The Assignments screen is displayed.

2. Select the POV and the Layer for the selected model, then click **Go** .

3. Under **Source**, select the model stage and the dimension members' intersection that contains the assignment to be deleted.

The dimensions and members for the selected stage are displayed.

4. Under **Destination**, select the destination to be deleted.

To select multiple destinations for deletion:

- To select a range of destinations, press **Shift** and select the first and last destinations in the range to be deleted.
- To select multiple random destinations, press **Ctrl** and select individual destinations from the list.

5. Click **Delete** .

A message asks you to confirm the deletion.

Caution:

The financial flow of the model will be modified by the removal of the assignment.

6. Click **Yes**.

Working with Standard Profitability Assignment Rules

Assignments specify where allocation results are directed.

Frequently, models include multiple assignments that use the same parameters. To simplify the creation of multiple assignments that are similar in nature, you can create and reuse assignment rules that specify the assignment parameters.

An assignment rule is a collection of member sets and optional filter sets for a single destination stage. A filter is a collection of criteria that are applied to a dimension. The rules are created based on one or more of the following criteria:

- Membership in a specific branch of the dimension hierarchy

- Member name
- Member alias
- UDAs (User-defined attributes)
- Attribute associations

The destinations returned by an assignment rule are the cross-product of the Level-0 members from all the dimensions in the destination stage, that pass the filter criteria applied to the rule.

While the assignment rules reduce the effort of creating and maintaining many individual assignments, they also react to metadata changes over time, so that the original business logic captured in the rule definition continues to generate correct assignment relationships.

You can create assignment rules, using the following options:

- Define a specific set of member sets and optional filter sets for a single destination stage.
- Define a Same As Source assignment rule that replaces the destination stage dimension members with the selected source when the calculation script is generated. See [Creating Same As Source Assignment Rules](#).

Within a model, the definition of an assignment rule is the same in all POVs. Assignment rule selections can be imported into Oracle Hyperion Profitability and Cost Management, using the HPM_STG_ASGN_RULE_SEL staging table. See the "Standard Profitability Import Staging Tables" section in the *Oracle Hyperion Profitability and Cost Management Administrator's Guide*.

Two options are available to create and manage assignment rules, as follows:

- To create an assignment rule and apply it to a source, see [Using the Assignment Rule Wizard](#)
- To create and manage assignment rules, and easily view the complete list of assignment rules, see [Using the Assignment Rule Definition Screen](#). Note that this option does not allow you to apply the rule to a source

Using the Assignment Rule Wizard

The Assignment Rule Wizard, available from the Assignments screen, enables you to create an assignment rule AND apply it to a source.

Use the following procedures:

- [Creating Assignment Rules](#)
- [Creating Assignment Rules from Existing Assignment Rules](#)
- [Creating Same As Source Assignment Rules](#)
- [Modifying Assignment Rules](#)
- [Deleting Assignment Rules](#)
- [Applying an Existing Assignment Rule](#)
- [Applying an Existing Same as Source Assignment Rule](#)

Creating Assignment Rules

To create assignment rules:

1. In an open model, from **Task Areas**, select **Manage Allocations**, then **Assignments**.
The Assignments screen is displayed.
2. Select the POV and Layer for the selected model, then click **Go** .
3. Under **Stage**, select the stage for the assignment.
The dimensions and members for the stage are displayed.

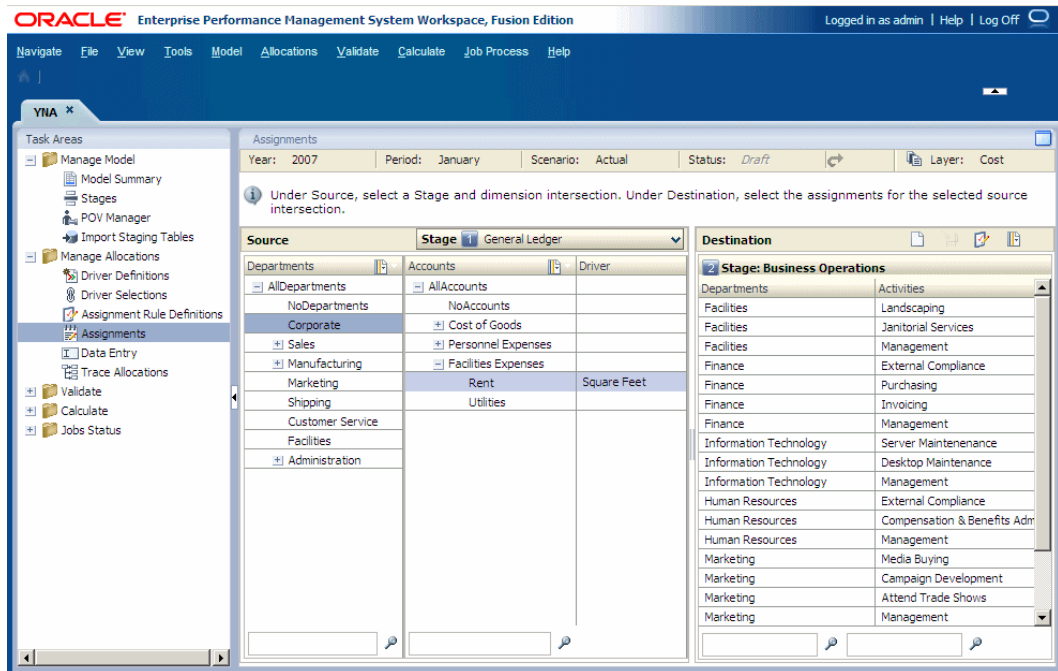

4. Under **Source**, select the members of each dimension that create the intersection for the source of the assignment rule. The associated driver for the intersection is identified in the Driver column.

When all dimensions of the intersection have been selected, the Destination column is populated with this information:

- With the dimensions and members of the destination stages, if there are assignments for this intersection.
- With the names of the destination stages and assignment rules, if they are applied to this intersection.

5. Under **Destinations**, click **Open Assignment Rules Management** .

The Assignment Rules Management dialog box is displayed.

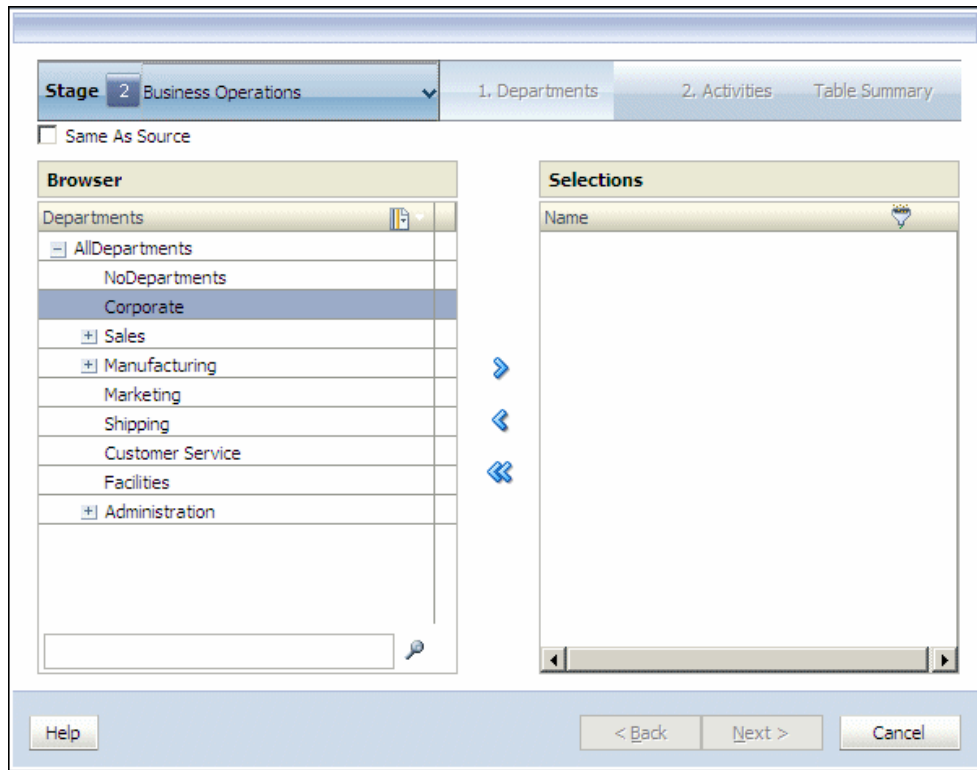

6. In the **Available Rules** column, click **Add** .
The Add Rule dialog box is displayed.

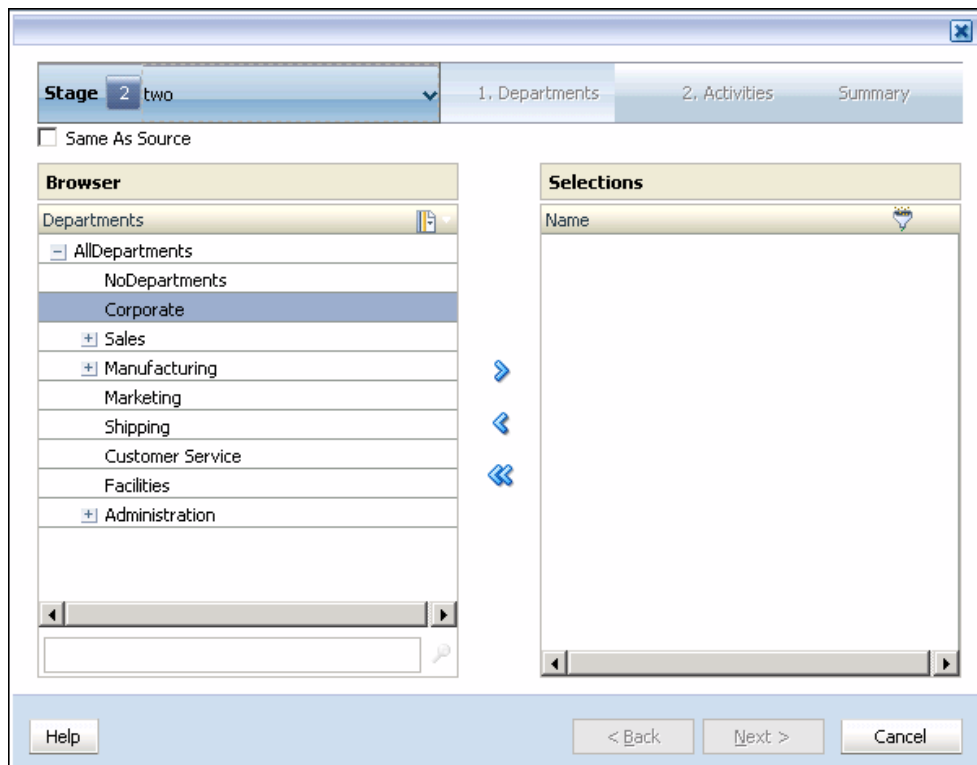

7. Under **Stage**, select the stage for which the rule is to be created.
8. **Optional:** Select **Same As Source** to create an assignment rule to use a single source for one or more destination intersections.

When the calculation script is generated, the script inserts the selected source into the rule, to create the appropriate allocation.

9. Under Step 1, select the first member of the intersection for the assignment rule.
10. Click **Add**  to move the selected member to **Selections**.
11. Click **Next**.
12. **Optional:** Filter the list for selected non-Level-0 dimension members.

When entering a value in a filter for UDA or Attribute parameters, enter the entire string. Wildcard symbols, such as asterisks (*) and question marks (?) are supported in assignment rule Name filters. For example, enter "B*" to filter members having names or aliases beginning with the letter "B". You cannot use "*B" as this means that the filter is beginning with a wildcard, which is not allowed.

See [Using Filters](#).

 **Note:**

For Assignment Rules, the Filter with Name criterion is applied to both the member Name and Alias, regardless of which mode was selected during filter creation (Show Alias or Show Name).

13. Under Step 2, select the second member of the intersection for the Destination of the assignment.
14. Click **Add**  to move the selected member to **Selections**.
When all members have been selected, the Destination Selection Summary is displayed.
15. Click **Next**.
When all members have been selected, the Assignment Rule Summary is displayed.

The screenshot shows a software interface for configuring assignment rules. At the top, there is a navigation bar with 'Stage 2 Business Operations' selected, and other tabs for '1. Departments', '2. Activities', and 'Table Summary'. Below this is a 'Selection Summary' section with two columns: 'Departments' and 'Activities'. Under 'Departments', 'Corporate' is selected. Under 'Activities', 'Compensation & Benefits Admin' is selected. Below the selection summary, there are input fields for 'Rule Name' (containing 'Corporate Benefits'), 'Search Tag' (containing 'Benefits'), and 'Rule Description' (which is empty). At the bottom of the dialog, there are buttons for 'Help', '< Back', 'Finish', and 'Cancel'.

16. Verify that the selections are correct.
17. In **Rule Name**, enter a name for the assignment rule. The rule name can contain a maximum of 80 characters.
18. **Optional:** Enter a **Search Tag** to facilitate later searches for the rule.
19. **Optional:** Enter a description of the assignment rule.
20. Click **Finish**.

The Rule Name is added to the list of Available Rules on the Assignment Rules Management dialog box.

Creating Assignment Rules from Existing Assignment Rules

You can edit an existing assignment rule, and use the Save As option to save it as a new assignment rule, as follows:

- Edit an existing rule, and save as a new rule.
- Edit an existing rule, modify its contents, and rename the rule.

To save an existing assignment rule as a new rule:

1. From Task Areas, select **Manage Allocations**, and then **Assignments**.
2. Select the source stage and intersection.
3. Select the assignment rule that is to be copied or modified, and then click **Edit**.
4. **Optional:** Modify the selections for the assignment rule.
5. Under **Rule Name**, enter the name of the new rule.
6. **Optional:** Enter a **Search Tag** to facilitate later searches for the rule.

7. **Optional:** Enter a description of the assignment rule.
8. Click **Save As** to save the rule under the new name.
9. Click **Finish**.

The new rule is displayed under Available Rules.

Creating Same As Source Assignment Rules

When defining a Same as Source assignment rule, you create an assignment rule that enables you to use a wild card for member selection in one, some or all of the destination stage dimensions. When the rule is selected using "rule selection," the dimensions marked for Same As Source would use the same member on both the destination and source stage dimensions.



Note:

The Level-0 members that are used in the Same As Source member selection within the rule must be present as Level-0 members in both the source and destination stage dimensions.

The rule that contains the Same as Source setting acts as a wildcard to pull in individual members of the selected dimension as the new destination each time you select the rule.

When the calculation script is generated, the script inserts the selected source into the rule, to create the appropriate allocation.

Example: Same As Source Assignment Rule

In a model, there are two dimensions required for the allocation:

- Products (Cola and Lime)
- Regions (US and Can)

An assignment rule, for example, 'Rule 1,' is created to use the dimension 'Products' as the source for any allocation. Use the following procedures to create and apply the Same as Source assignment rules.

- To run the first allocation, select the associated member "Cola", then select the Destination "US", and then select Rule 1. When the calculation script is generated, it inserts the selected source: Product (Cola) X US.
- To run the second allocation, select the associated source member "Lime", then select the Destination "US", and then select Rule 1. This time, when the calculation script is generated, it inserts the selected source: Product (Lime) X US.

To create Same as Source assignment rules:

1. In an open model, from **Task Areas**, select **Manage Allocations**, then **Assignments**.
The Assignments screen is displayed.
2. Select the POV and Layer for the selected model, then click **Go** .
3. Under **Stage**, select the stage for the assignment.
The dimensions and members for the stage are displayed.

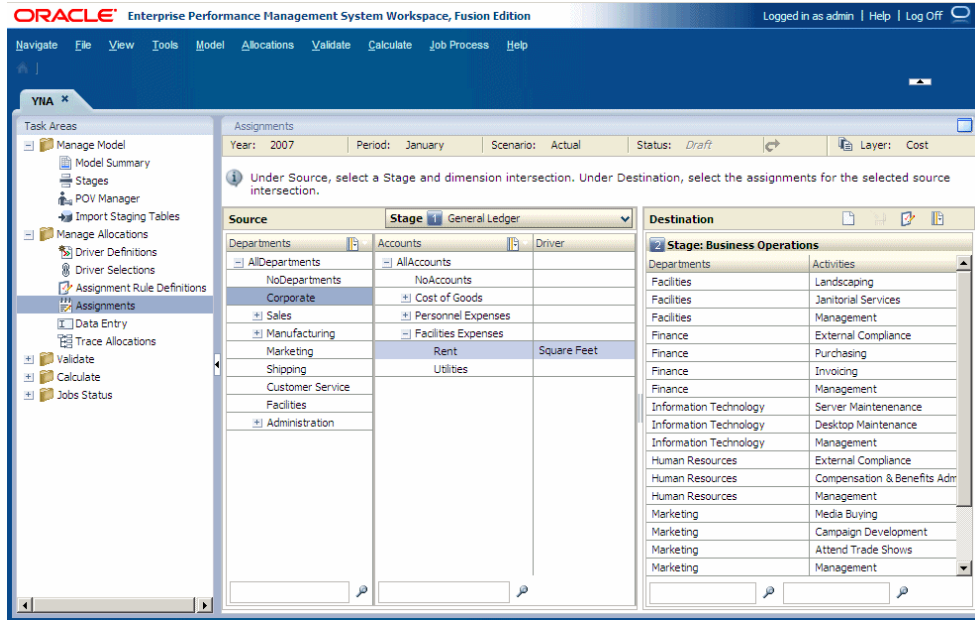

- Under **Source**, select the members of each dimension that create the intersection for the source of the assignment rule.

The associated driver is identified in the Driver column. The Destination column is populated with the following information:

- With dimensions and members of the destination stages, if there are assignments for this intersection
- With the names of destination stages and assignment rules, if there are any applied to this intersection.

- Under **Destinations**, click **Rules Management** .

The Assignment Rules Management dialog box is displayed.

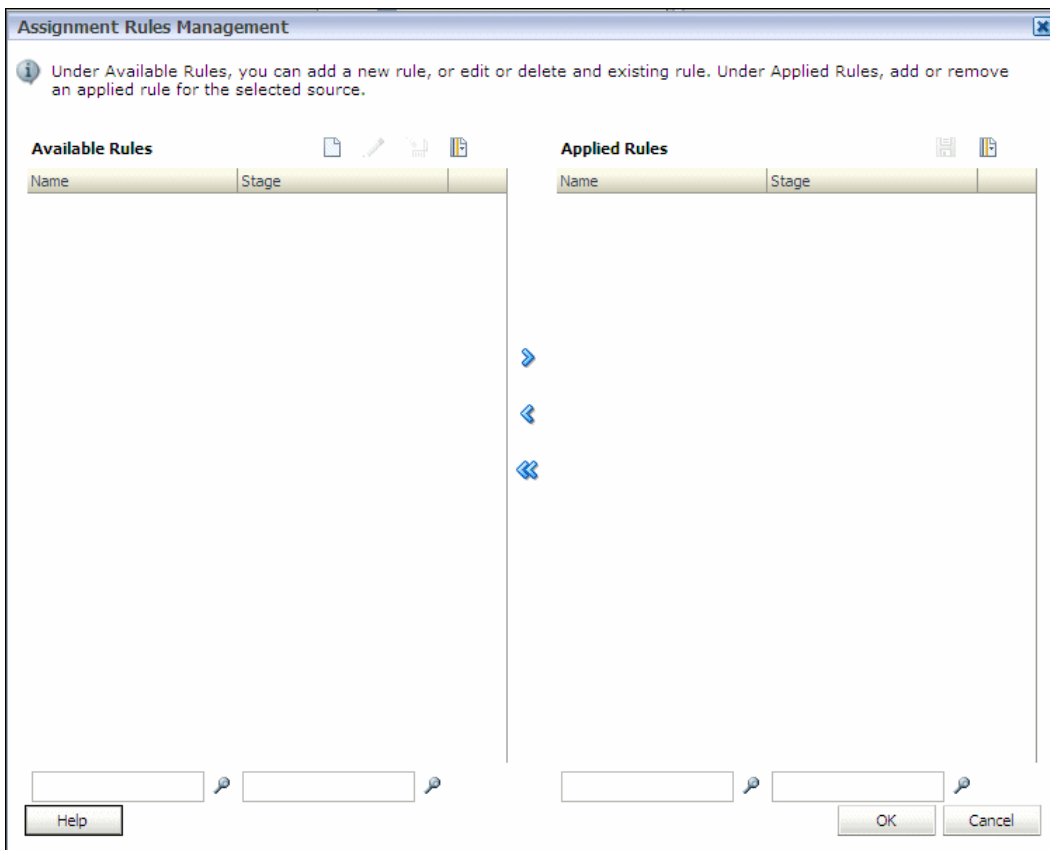

6. In the **Available Rules** column, click **Add** .
7. Under **Stage**, select the destination stage for which the rule was created.
8. Under Step 1, select **Same As Source** to create an assignment rule to use a single source for one or more destination intersections.

When the calculation script is generated, the script inserts the selected source into the rule, to create the appropriate allocation.

 **Note:**

After you select "Same as Source", member selection for that dimension and the Filter Icon are disabled because the members are essentially "pre-selected" in the defined source. No further member selection is necessary or allowed for that dimension.

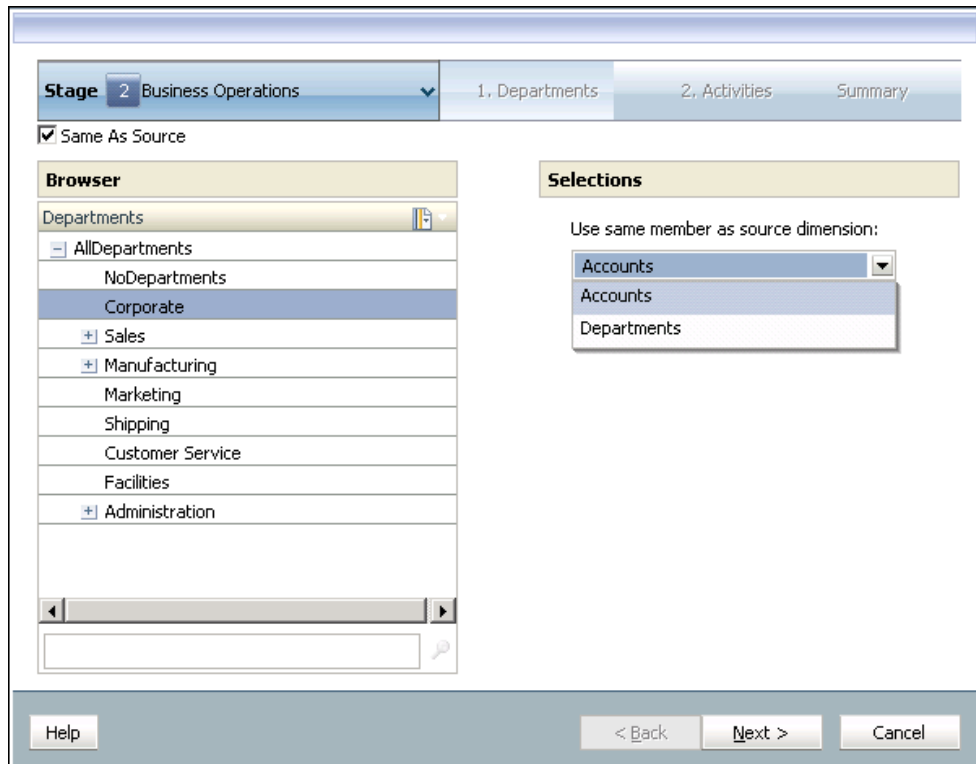

9. Under **Selections**, from the **Use same member as source dimension** drop-down list, select the dimension that is to be the default source dimension for each allocation.
10. Click **Next**.
11. Under **Step 2**, repeat step 8 and step 9 to select each member of the intersection for the Destination of the assignment.
12. Click **Next**.

The Assignment Rule Summary is displayed.

The screenshot shows a software interface for configuring assignment rules. At the top, there is a 'Stage' dropdown menu set to '2 Business Operations'. To its right are three tabs: '1, Departments', '2, Activities', and 'Summary'. Below this is a 'Selection Summary' section with two columns: 'Departments' and 'Activities'. The 'Departments' column contains the text 'Use same member as source dimension:' and 'Accounts'. The 'Activities' column contains 'Purchasing'. At the bottom of the dialog, there is a 'Rule Name' text box containing 'Purchasing'. The bottom right corner features three buttons: 'Help', '< Back', 'Finish', and 'Cancel'.

13. Review the selections.
14. In **Rule Name**, enter a name for the Same as Source assignment rule. The assignment rule name can contain a maximum of 80 characters.
15. Click **Finish**.

The Rule Name is added to the list of Available Rules on the Assignment Rules Management dialog box.

Modifying Assignment Rules

You can modify the destination stage, selected dimension members, filter set, and rule name, rule description, and search tag in an existing assignment rule.

To modify assignment rules:

1. In an open model, from **Task Areas**, select **Manage Allocations**, then **Assignments**.
The Assignments screen is displayed.
2. Select the POV and the layer for the selected model, then click **Go** .
3. Under **Stage**, select the stage for the assignment rule to be modified.
The dimensions and members for the stage are displayed.
4. Under **Source**, select the members that create the intersection for the source of the assignment rule.
The associated driver is displayed in the appropriate Driver column. The icons in the Destination column are activated.

5. Under **Destinations**, click **Open Assignment Rules Management** .
The Assignment Rules Management dialog box is displayed.

6. Select the Rule to be modified, and then click **Modify** .
The Edit Rule dialog box is displayed.

 **Note:**

Modify filters, if required. See [Using Filters](#).

7. Under **Selection** for each **Step** on the Edit Rule dialog box, modify the dimension members selected for the rule intersection, as required, using the arrow keys to add or remove members, and then click **Next**.

When modifications for all dimensions are complete, the Edit Rule summary is displayed.

8. On the Edit Rule Summary, review the selections.
9. **Optional:** In **Rule Name**, enter a different name for the assignment rule. The rule name can contain up to a maximum of 80 characters.
10. Select the appropriate option to save the rule:
 - Click **Save** to save the modified rule under the original rule name.
 - Click **Save As** to create a new rule with a different rule name.
11. Click **Finish**.

The modified rule is displayed in the list of Available Rules list on the Assignment Rules Management dialog box.

Deleting Assignment Rules

To delete assignment rules:

1. Ensure that no other users require the assignment rule that is to be deleted.
2. In an open model, from **Task Areas**, select **Manage Allocations**, then **Assignments**.

The Assignments screen is displayed.

3. Select the POV and layer for the selected model, then click **Go** .
4. Under **Stage**, select the stage for the assignment rule to be deleted.

The dimensions and members for the stage are displayed.

5. Under **Source**, select the members that create the intersection for the source of the assignment rule.

The associated driver is displayed in the appropriate Driver column. The icons in the Destination column are activated.

6. Under **Destinations**, click **Rules Management** .
The Assignment Rules Management dialog box is displayed.

- Under **Available Rules**, select the Rule to be deleted, and then click **Delete** .
- A message asks you to confirm the deletion.



Caution:

Deletion of an assignment rule impacts the calculation of model data because the rule and its rule selections are deleted.

- Click **Yes**.
The rule is removed from the Available Rules list.
- Click **OK**.

Applying an Existing Assignment Rule



To apply assignment rules:

- In an open model, from **Task Areas**, select **Manage Allocations**, then **Assignments**.
The Assignments screen is displayed.
- Select the POV and layer for the selected model, then click **Go** .
- Under **Stage**, select the stage to which the assignment rule is to be applied.
The dimensions and members for the stage are displayed.
- Under **Source**, select the members that create the intersection for the source to which you want to apply the assignment rule.
The associated driver is displayed in the appropriate Driver column. The icons in the Destination column are activated.
- Under **Destinations**, click **Rules Management** .
- Under **Available Rules**, select the assignment rule to be applied to this intersection.
- Click **Add**  to move the selected assignment rule to **Applied Rules**, and then click **OK**.
The assignment rule is applied to the selected assignment.

Applying an Existing Same as Source Assignment Rule



To apply Same as Source assignment rules:

- In an open model, from **Task Areas**, select **Manage Allocations**, then **Assignments**.
The Assignments screen is displayed.
- Select the POV and layer for the selected model, then click **Go** .
- Under **Stage**, select the stage to which the assignment rule is to be applied.
The dimensions and members for the stage are displayed.

4. Under **Source**, select the members of each dimension that create the intersection for the source to which you want to apply the assignment rule.
5. Under **Destinations**, click **Assignment Rules Management** .
The Assignment Rules Management dialog box is displayed.
6. Under **Available Rules**, select the assignment rule with the Same as Source option to be applied to this intersection, and then click **OK**.
7. Click **Add**  to move the selected assignment rule to **Applied Rules**, and then click **OK**. The assignment rule is applied to the selected intersection.
When the calculation script is generated, the selected Source and Dimension members are inserted to generate the correct results for the allocation.

Removing an Existing Assignment Rule Selection

To remove assignment rule selections:

1. In an open model, from **Task Areas**, select **Manage Allocations**, then **Assignments**.
The Assignments screen is displayed.
2. Select the POV and layer for the selected model, then click **Go** .
3. Under **Stage**, select the stage that contains the assignment rule to be removed.
The dimensions and members for the stage are displayed.
4. Under **Source**, select the members that create the intersection for the source of the assignment rule which you want to remove.
The associated driver is displayed in the appropriate Driver column. The icons in the Destination column are activated.
5. Under **Destinations**, click **Assignment Rules Management** .
The Assignment Rules Management dialog box is displayed.
6. Under **Applied Rules**, select the assignment rule to be removed from this assignment.
7. Click **Remove**  to move the selected assignment rule to **Available Rules**, and then click **OK**.
The assignment rule is removed from the selected assignment.

Using the Assignment Rule Definition Screen

The Assignment Rule Definition screen, available from the Task Areas pane, enables you to create and manage assignment rules, and easily view the complete list of assignment rules in a single location; however, this option does not allow you to apply the rule to a source.

The Assignment Rule Definition screen displays the Name and Description of any assignment rules, and the Destination stage. The associated Search Tag is listed, and the ID of the user who created or modified the assignment rule. All assignment rules

are available, regardless of whether they have been created in the Assignment Rule wizard or the Assignment Rule Definition screen.

Use the following procedures:

- [Creating Assignment Rule Definitions](#)
- [Creating Same As Source Assignment Rule Definitions](#)
- [Modifying Assignment Rule Definitions](#)
- [Deleting Assignment Rule Definitions](#)

Creating Assignment Rule Definitions

To create assignment rule definitions:

1. In an open model, from **Task Areas**, select **Manage Allocations**, then **Assignment Rule Definitions**.

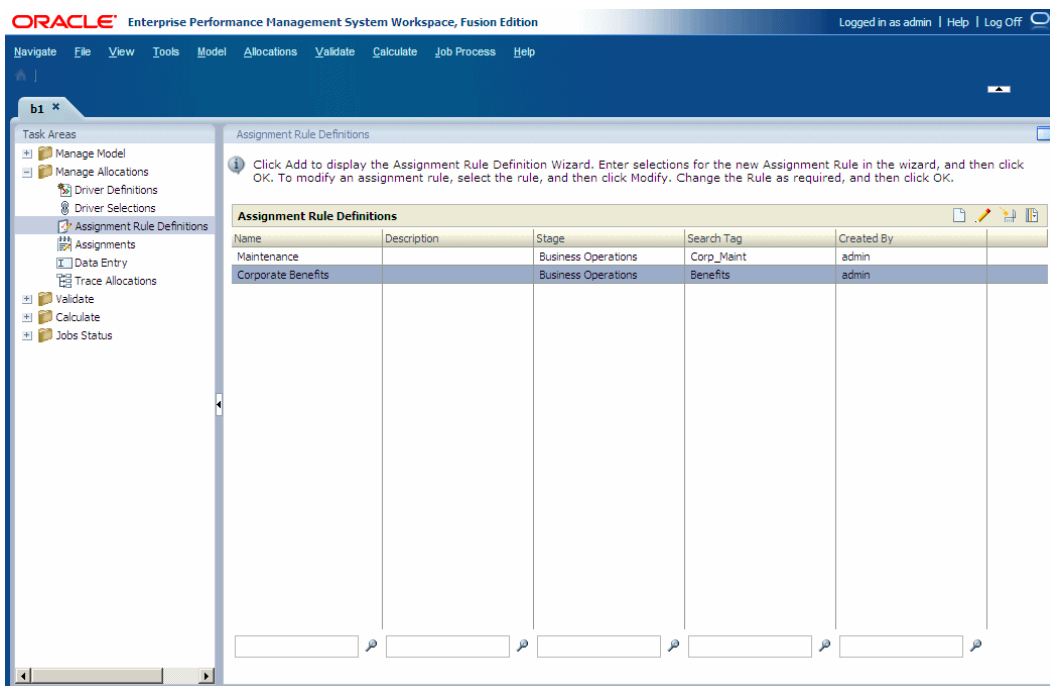

The Assignment Rule Definitions screen is displayed. The screen displays the Name and Description of any assignment rules, and the Destination stage. The associated Search Tag is listed, and the ID of the user who created or modified the assignment rule.

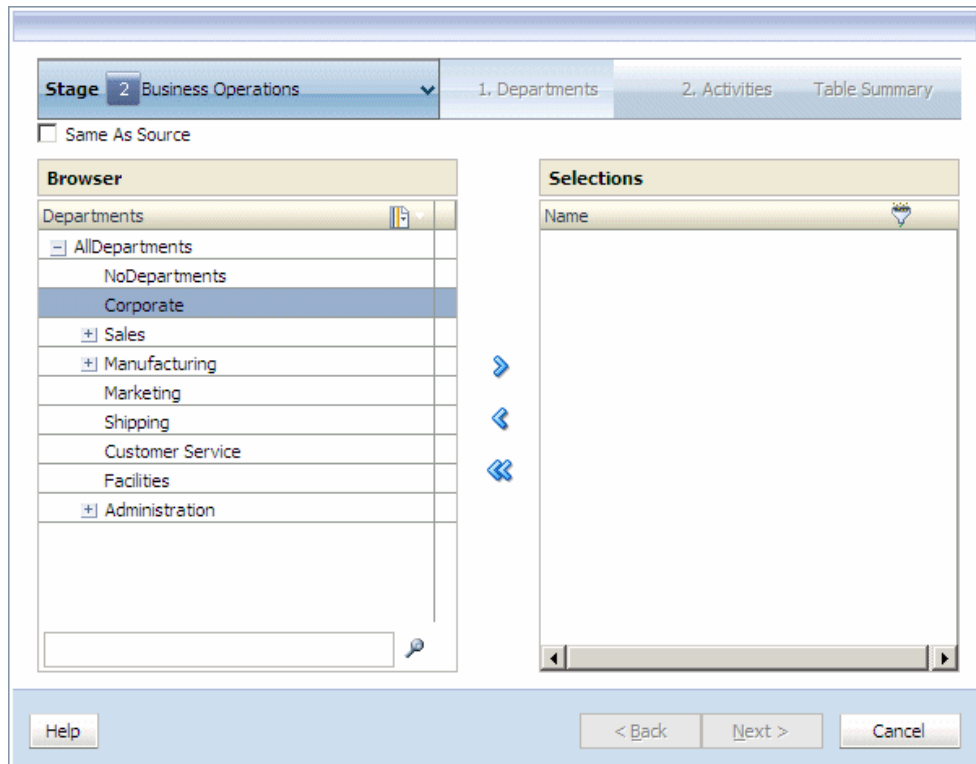

2. Click **Add** 

The Assignment Rules wizard is displayed.



3. For Step 1, under **Browser**, select the first member of the intersection for the assignment rule.
4. Click **Add**  to move the selected member to **Selections**, and then click **Next**.
5. Under Step 2, under **Browser**, select the second member of the intersection for the Destination of the assignment.
6. Click **Add**  to move the selected member to **Selections**, and then click **Next**. Repeat this step for additional dimensions, if required.

When all members have been selected for the intersection, the Destination Selection Summary is displayed.

The screenshot shows a software interface for managing profitability allocations. At the top, there's a 'Stage' dropdown set to '2 Business Operations' and three tabs: '1. Departments', '2. Activities', and 'Table Summary'. Below the tabs is a 'Selection Summary' section with two columns: 'Departments' containing 'Corporate' and 'Activities' containing 'Compensation & Benefits Admin'. Underneath are input fields for 'Rule Name' (filled with 'Corp Benefits'), 'Search Tag' (filled with 'Benefits_Corp'), and 'Rule Description' (empty). At the bottom, there are buttons for 'Help', '< Back', 'Finish', and 'Cancel'.

7. **Optional:** Filter the list for selected non-level 0 dimension members.

When entering a value in a filter for UDA or Attribute parameters, enter the entire string. Wildcard symbols, such as asterisks (*) and question marks (?) are supported in assignment rule Name filters. For example, enter "B*" to filter members having names or aliases beginning with the letter "B". You cannot use "*B" as this means that the filter is beginning with a wildcard, which is not allowed.

See [Using Filters](#).

 **Note:**

For Assignment Rules, the Filter with Name criterion is applied to both the member Name and Alias, regardless of which mode was selected during filter creation (Show Alias or Show Name).

8. Enter the following information for the new rule:

- **Rule Name**— The rule name can contain a maximum of 80 characters.
- **Search Tag**—The search tag may contain a maximum of 80 characters.
- **Rule Description**

9. Click **Finish**.

The Rule Name is added to the list of Available Rules on the Assignment Rules Management dialog box.

10. Verify that the selections are correct.

11. In **Rule Name**, enter a name for the assignment rule. The rule name can contain a maximum of 80 characters.

12. Click **Finish**.

The Rule Name is added to the list of Available Rules on the Assignment Rules Management dialog box.

Creating Same As Source Assignment Rule Definitions

When defining a Same as Source assignment rule, you create an assignment rule that enables you to use a wild card for member selection in one, some or all of the destination stage dimensions. When the rule is selected using "rule selection," the dimensions marked for Same As Source would use the same member on both the destination and source stage dimensions.



Note:

The Level-0 members that are used in the Same As Source member selection within the rule must be present as Level-0 members in both the source and destination stage dimensions.

The rule that contains the Same as Source setting acts as a wildcard to pull in individual members of the selected dimension as the new destination each time you select the rule.

When the calculation script is generated, the script inserts the selected source into the rule, to create the appropriate allocation.

To create Same As Source assignment rule definitions:

1. In an open model, from **Task Areas**, select **Manage Allocations**, then **Assignment Rule Definitions**.

The Assignment Rule Definitions screen is displayed.

2. Click **Add** 

The Assignment Rules wizard is displayed.

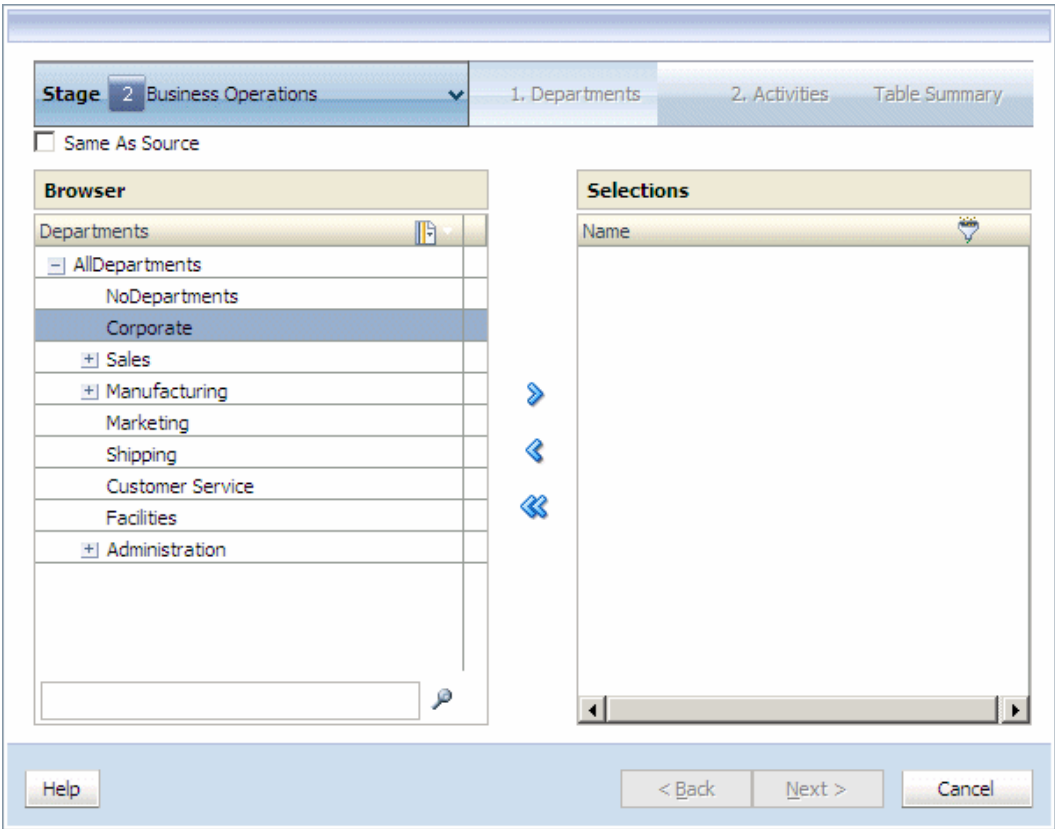

3. Under **Browser**, select the first member for the intersection.
4. Above **Browser**, click **Same As Source**.

The Selections column of the screen is modified to display the Same as Source drop-down list.

Stage Reallocation

1. B Table Summary

Same As Source

Browser

B

- AllB
- B1**
- B2
- E11

Selections

Use same member as source dimension:

A

Help < Back Next > Cancel

5. Under **Selections**, select the dimension to be used as the source for the for the assignment rule, and then click **Next**.

Stage 2 Reallocation

1. B Table Summary

Selection Summary

B

Use same member as source dimension:

A

Rule Name Search Tag

Rule Description

Help < Back Finish Cancel

6. Click **Finish**.

The Rule Name is added to the list of Available Rules on the Assignment Rules Management dialog box.

7. Click **Add**  to move the selected member to **Selections**, and then click **Next**.

8. Under Step 2, under **Browser**, select the second member of the intersection for the Destination of the assignment.

9. Click **Add**  to move the selected member to **Selections**, and then click **Next**. Repeat this step for additional dimensions, if required.

When all members have been selected for the intersection, the Destination Selection Summary is displayed.

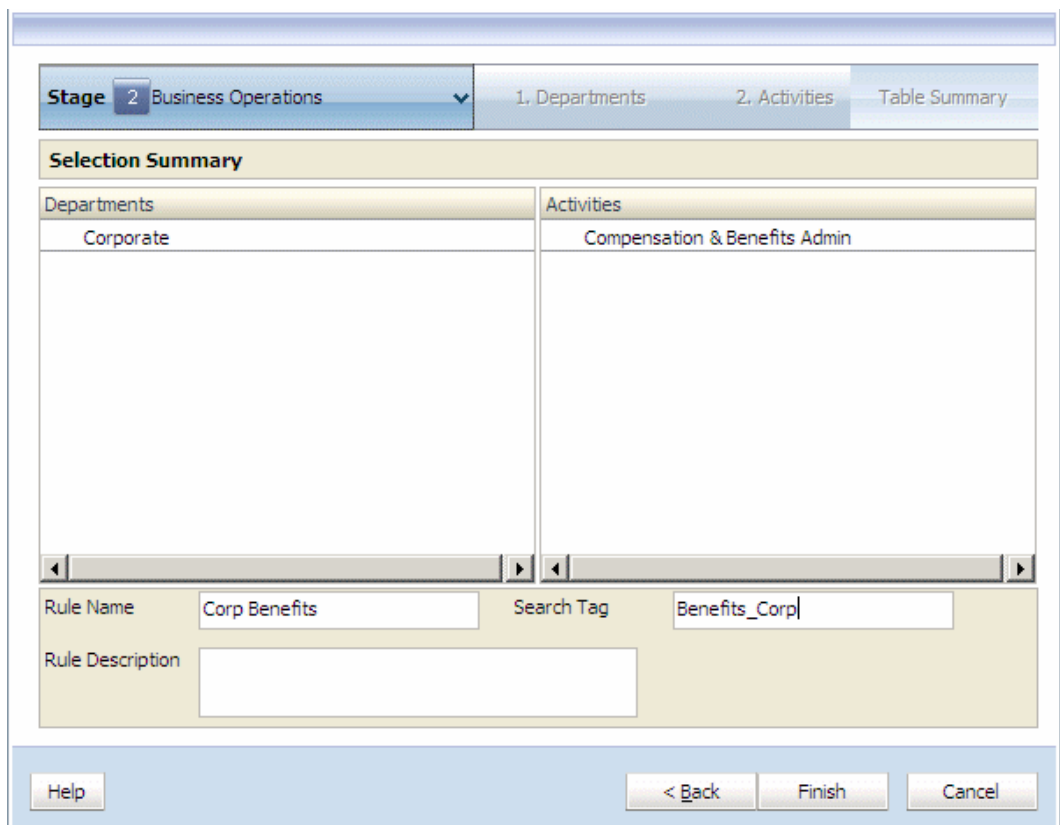

Selection Summary	
Departments	Activities
Corporate	Compensation & Benefits Admin

Rule Name: Corp Benefits Search Tag: Benefits_Corp

Rule Description:

Buttons: Help, < Back, Finish, Cancel

10. Enter the following information for the new rule:

- Rule Name. The rule name can contain a maximum of 80 characters.
- Search Tag. The search tag may contain a maximum of 80 characters.
- Rule Description

11. Click **Finish**.

The Rule Name is added to the list of Available Rules on the Assignment Rules Management dialog box.

Modifying Assignment Rule Definitions

You can modify any assignment rule definition.

The modified assignment rule definition can be saved as the original, or you can rename it to create a new assignment rule definition.

To modify assignment rule definitions:

1. In an open model, from **Task Areas**, select **Manage Allocations**, then **Assignment Rule Definitions**.

The Assignment Rule Definitions screen is displayed.

2. Select the assignment rule to be modified.

3. Click **Edit Selected Assignment Rule** .

The Assignment Rules wizard is displayed.

4. **Optional:** For Step 1, under **Browser**, use the Add arrow or the Remove arrow to move the appropriate members under the **Selection** column, and then click **Next**.
5. **Optional:** Under Step 2, under **Browser**, use the Add arrow or the Remove arrow to move the appropriate members under the **Selection** column, and then click **Next**.

Repeat this step for additional dimensions, if required. When all members have been selected for the intersection, the Destination Selection Summary is displayed.

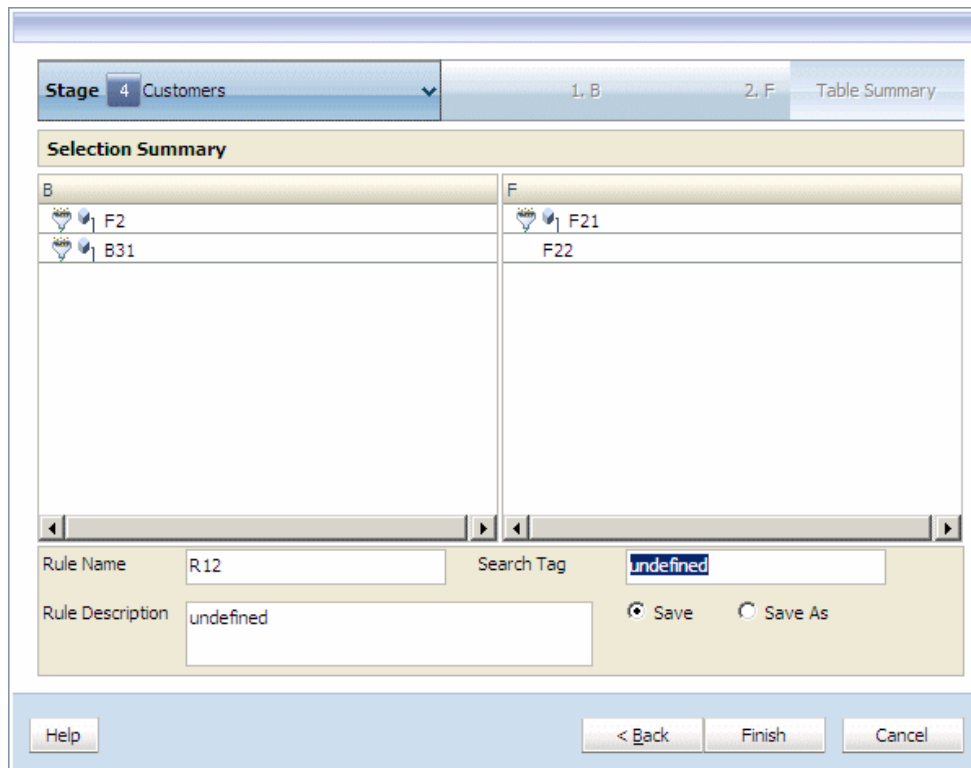

Stage 4 Customers

1, B 2, F Table Summary

Selection Summary

B	F
F2	F21
B31	F22

Rule Name: R12 Search Tag: undefined

Rule Description: undefined

Save Save As

Help < Back Finish Cancel

6. Review the modifications to the assignment rule.
7. **Optional:** To save the modifications to the existing assignment rule under the same rule name, click **Save**, enter a Search Tag and Rule Description for the existing Rule Name, and then click **Finish**.
The modified Assignment Rule is saved.
8. **Optional:** To save the assignment rule as a new assignment rule, click **Save As**, enter a new Rule Name, Search Tag and Rule Description, and then click **Finish**.
The new assignment rule is saved with the selected dimensions under the new rule name.

Deleting Assignment Rule Definitions

To delete assignment rules:

1. In an open model, from `Task Areas`, select **Manage Allocations**, then **Assignment Rule Definitions**.
The Assignment Rule Definitions screen is displayed.
2. Select the assignment rule to be deleted.
3. Click **Delete Assignment Rule** .
A Delete Confirmation message is displayed.
4. Click **Yes**.
The selected assignment rule definition is removed from the Assignment Rule Definitions list.

Using the Data Entry Window

Use the Oracle Hyperion Profitability and Cost Management Data Entry window to directly add, edit, and verify data.

Standard data entry views that provide several predefined views are available upon deployment of the application. You can also create customized Edit Views that contain a set of measures (members of the Measures dimension), so you can easily view that set of data. This option is useful if you have sets of data that must be updated frequently.

You can create different types of data entry views:

- Standard Data Entry views are available after deployment of the application and provide predefined views. See [Standard Data Entry Views](#).
- User-defined custom Data Entry view definitions are stored in the Profitability and Cost Management schema. The views are defined per application and are shared between all users. This functionality applies to named views only.
- Ad-hoc views are stored in user preferences and are not shared between users. These views are created when the user selects measures, and then click Apply instead of Save.

See these sections to manually manage data:

- [Standard Data Entry Views](#)
- [Creating Custom Edit Views](#)
- [Editing Stage Data](#)

- [Editing Data Manually](#)
- [Editing Driver Data](#)
- [Deleting Edit Views](#)

Standard Data Entry Views

After deployment of the application from the Profitability Applications Console to Oracle Hyperion Profitability and Cost Management, standard data entry views are created. These views can be used to quickly and easily evaluate data detail for cost balancing, driver and cost statistics, and intrastage assignment details.

Standard data entry views display a selection of associated measures on the Data Entry screen. If required, the standard data entry views can be modified, as required, to customize the results for the organization.

When you select a standard data entry view from Available Views on the Data Entry screen, the screen changes to reflect the associated measures for that view, as shown on the following table:

Table A-10 Standard Data Entry Views

Data Entry View	Associated Measures
Cost Balancing	<ul style="list-style-type: none"> • UnassignedCost • CostInput • CostReceived • NetCostForAssignment • Cost Assigned • IdleCost • OverDrivenCost
Driver Statistics	<ul style="list-style-type: none"> • CostPerDriverUnit • TotalDriverValue • OverRideTotalDriverValue • IdleDriverValue
Cost Statistics	<ul style="list-style-type: none"> • NetCostForAssignment • UnitCost • Quantity
Intrastage Costs This view is available even if the model does not have stages that support intrastage assignments.	<ul style="list-style-type: none"> • CostInput • CostReceivedPriorStage • CostReceivedIntraStage • NetReciprocalCost • NetCostForAssignment • CostAssignedIntraStage • NetCostAfterIntraStage

To view standard data entry views:

1. In an open model, from **Task Areas**, select **Manage Allocations**, and then **Data Entry**.
2. From the Data Entry screen, select the required POV, and then click **Go** .
3. On the **Stage Data** tab, under **Stage**, select the source stage.
4. Under **Available Views**, select a standard data entry view.

The associated measures for the selected data entry view are displayed on the Data Entry screen.

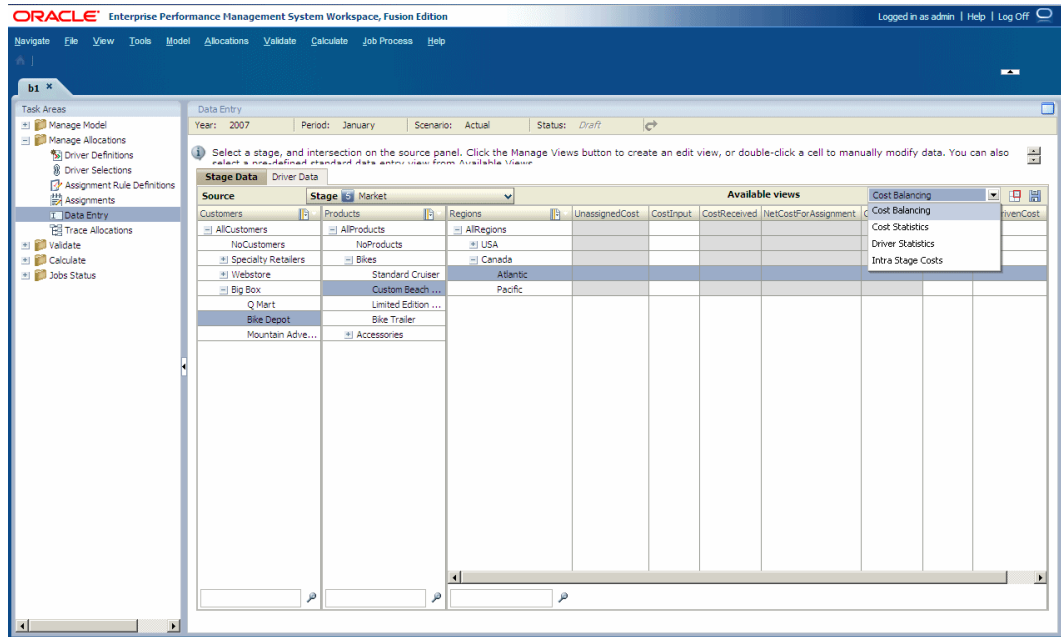

5. **Optional:** Customize the selected standard data entry view for the organization by adding or removing associated measures. See [Creating Custom Edit Views](#)



Creating Custom Edit Views

Edit views are used to simplify the editing of data that changes frequently, for playing scenarios or to capture last minute information. The saved views can be selected from the Available Views list.

To create edit views:

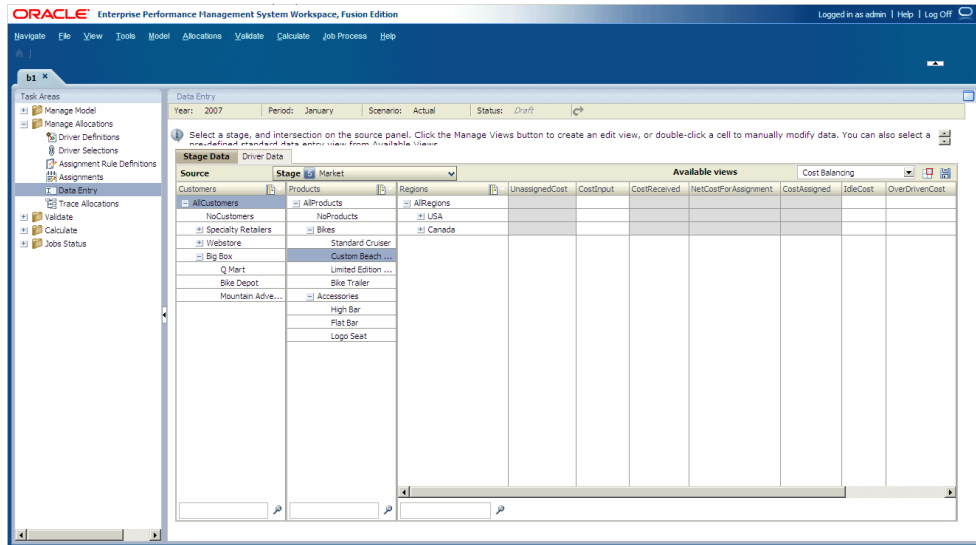
1. In an open model, from **Task Areas**, select **Manage Allocations**, then **Data Entry**.
The Data Entry screen is displayed.



2. Select the POV for the data to be modified, then click **Go** .
 3. Under **Stage**, select the source stage.
 4. On the **Stage Data** tab, click **Manage Views** .
- The Manage Views dialog box is displayed.

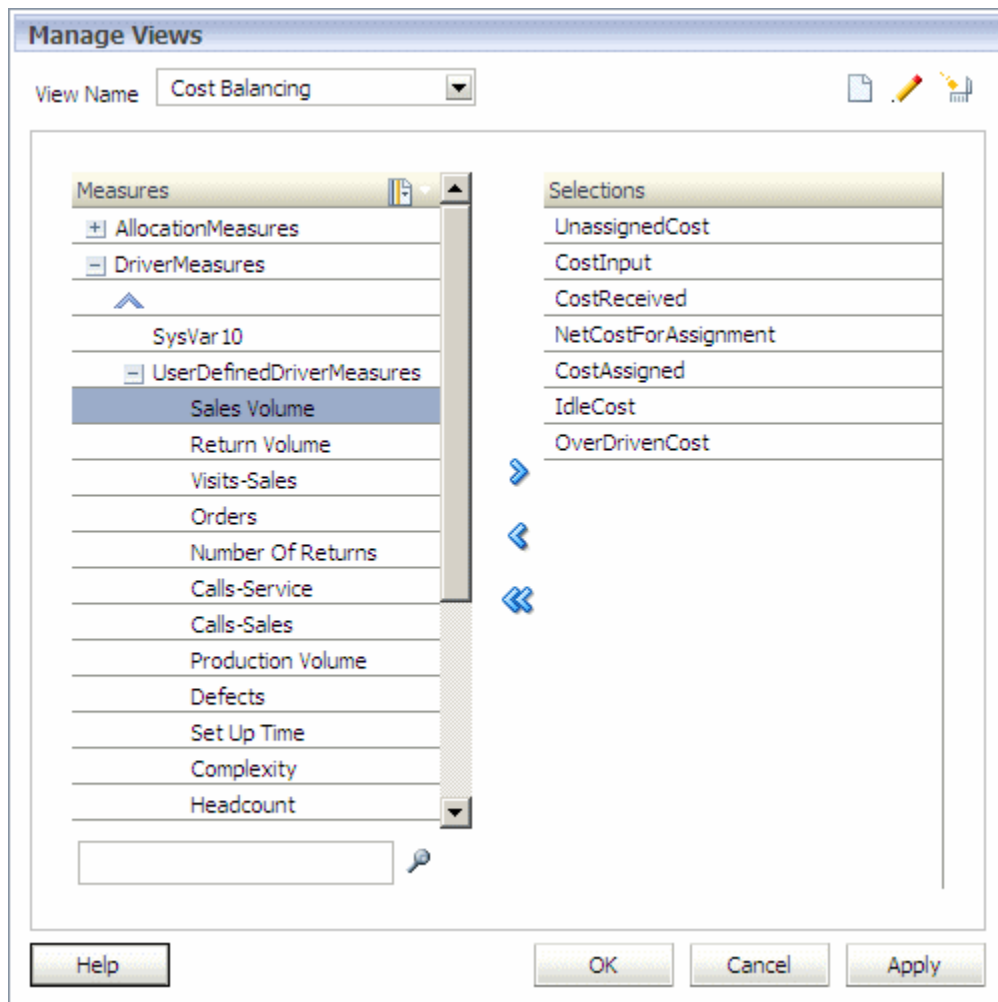

5. Click **Add** .

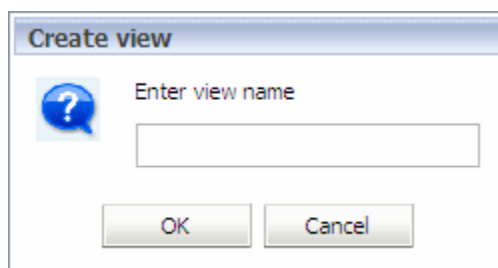

6. In the **Create View** dialog box, enter a name for the new view, and then click **OK**.
7. Under **Measures**, select one or more measures that are to be included in this view, and then click **Add**  to move the measures to the **Selection** list.
8. Perform one of the following actions:
 - To temporarily save the edit view for a one-time use, click **Apply**.
 - To save the edit view for multiple uses, click **OK**.

The name of the new Edit View is added to the Available Views list.

Editing Data Manually

In some instances, you may need to modify data to correct an entry, or change a value. Use the Data Entry window to access and modify data manually.

To modify data manually:

1. In an open model, from **Task Areas**, select **Manage Allocations**, and then **Data Entry**.

The Data Entry screen is displayed.

2. Select the tab that contains the cell to be modified:
 - Stage Data
 - Driver Data
3. Edit data as described in [Editing Stage Data](#).

Editing Stage Data

From the Data Entry Stage Data screen, you can manually add new data, or edit imported data.

To edit data:

1. In an open model, from **Task Areas**, select **Manage Allocations**, then **Data Entry**.

The Data Entry screen is displayed.

2. Select the POV and Layer for the data to be modified, and then click **Go** .
3. On the **Stage Data** tab, under **Source**, select a stage.
4. **Optional:** From the **Available Views** list, select a saved view.

All measures for the selected view are listed; however, parent measures cannot be modified.

5. On the **Stage Data** tab, select the members that create the intersection value which is to be modified.
6. Double-click the intersection cell, and edit the data.
7. Click **Save**  to save the change.



Editing Driver Data

The Driver Data tab displays the dimensions of the source and destination stages. For a selected source member intersection, the tab displays the assigned destination members and driver measures.

If a driver measure includes the Assignment location in the driver formula definition, data for the driver is stored at the intersection formed by the source and destination members. Because the intersection includes dimensions from multiple stages, you cannot view the intersection from the Stage Data tab.

To edit driver data:



1. In an open model, from **Task Areas**, select **Manage Allocations**, then **Data Entry**.
2. Select a POV, and then click **Go** .
The Data Entry screen is displayed.
3. Select the **Driver Data** tab, and then select a layer.
4. Under **Source**, select the model stage and the dimension members for the source intersection that is to be modified.

All driver measures for the selected assignments are listed: source driver measures on the Source pane, and Destination and Assignment driver measures on the Destination pane.
5. **Optional:** To select the destination intersections to be viewed, under **Destination**, click **Member Selector**  and select one of the following options:
 - Show Empty
 - Show All
 - Show Regular Assignments
 - Show Assignment Rules
6. Double-click a driver measure field, and enter the new value in the cell.
7. Click **Save**  to save the changes.

Deleting Edit Views

You can delete an edit view.

To delete edit views:

1. Ensure the edit view is not required by other users.
2. In an open model, from **Task Areas**, select **Manage Allocations**, then **Data Entry**.
3. Select a POV, and then click **Go** .
The Data Entry screen is displayed.
4. On the **Stage Data** tab, click **Manage Views** .
The Manage Views dialog box is displayed.
5. From the **View Name** drop-down, select the edit view to be deleted, and click **Delete** .
A confirmation message is displayed.
6. Click **Yes**.
The Edit View is deleted, and is no longer available from the Available Views list.

Tracing Allocations

Using the Trace Allocations feature, you can visually follow the flow of funds through the model from beginning to end.

From any selected member intersection, you can move through the entire financial model:

- Backward to view the source members that contributed to the value for the intersection, and the amount that each member contributed.
- Forward to view the destination members to which the value for the intersection is allocated, and how much is allocated to each member.

All related assignments are displayed. You can customize the information that you choose to display. You can also export the trace allocation images to another location, to be viewed or printed as required.

By default, calculations are performed using the Reporting database because the data is automatically aggregated.

Refer to these sections for instructions on tracing allocations:

- [Tracing Allocation Detail](#)
- [Tracing Allocation Flow](#)
- [Reciprocal Allocation](#)
- [Exporting Trace Allocation Images](#)

Tracing Allocation Detail

Allocation Detail enables you to follow allocations, step-by-step, directly from a source intersection to its ultimate destination, or from a destination intersection to its source. The intersections that contribute to, or receive value from, the starting point show the stage and associated members.

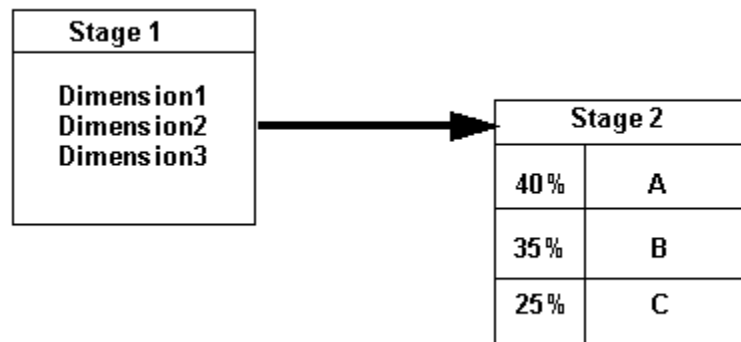

Direct allocation data is used to calculate the percentage for each step along the flow using the following formulas:

- For drilling forward:

$$\% = \text{ASSG CostReceivedPrior(orIntra)Stage} / \text{SRC NetCostForAssignment}$$
- For drilling backwards:

$$\% = \text{ASSG CostReceivedPrior(orIntra)Stage} / \text{DEST NetCostForAssignment}$$

For each stage, the percentage of each allocation contributing to the next intersection is displayed, from highest to lowest. The percentages displayed for a stage will not equal 100% if the following conditions exist:

- If there are idle costs on an intersection.
- If there is cost input at a destination when drilling upstream (back to the source).

To trace allocation detail:

1. Ensure all allocation scripts have been run.

See [Calculating Direct Allocation Data](#).

2. In an open model, from **Task Areas**, select **Manage Allocations**, then **Trace Allocations**.

The Traceability screen is displayed.

3. Select a POV, and then click **Go** .

4. Select a Layer.

5. Under **Starting Point**, select **Prefs** to choose the preferences for the information to be traced:

- Select the type of trace to be performed:
 - Allocation Detail to follow allocations, step-by-step, directly from a source intersection to its ultimate destination
 - Allocation Flow to display the source and destination intersections that have an indirect relationship, rather than a direct assignment, to the selected intersection.
- Select a display mode for the map:
 - Display Alias
 - Display Name

 **Note:**

If Display Alias is selected, and no alias is set, the Display Name is shown in square brackets ([]).

6. For each dimension, click **Selector** , and select the member to specify the intersection from which you want to begin tracing.

 **Note:**

You must select the lowest level member in order to display the allocation.

7. Select **Allocation Detail**.

8. Click **Trace**  to begin mapping the financial flow.

The selected intersection is displayed on the screen, showing the name of the stage, and the members selected for each dimension in the intersection. The Properties for the starting point of the selected intersection are displayed at the bottom of the screen.



 **Note:**

You can drag the entire flow diagram to position it for a more effective view. Depending on the number of dimensions in the model stage, you may need to stretch or scroll the window to see the Trace button on the far right side of the task bar.

9. **Optional:** On the intersection header, select the Trace Allocation Context Menu , and then select the maximum number of nodes that you want to display when the selected intersection is expanded (3, 5, 10 or 20). You can repeat this selection on any intersection.
10. Click the intersection to highlight the source node.

 **Note:**

Expand node  is only displayed on the intersection after it has been selected.

11. Under **Properties**, review the **Source Detail** that pertains to the selected intersection.

The following information is provided about the source:

- Source lists all dimension members selected for the starting point.
- Net Cost For Assignment
- Idle Cost, if any.
- Cost Assigned
- Total Driver Value
- OverDriven, if any
- StandardCostRate, if any

12. Select the next intersection to view, and click **expand**  to view the incoming or outgoing allocations for the selected intersection. You can navigate either upstream or downstream by expanding the nodes on either side of the intersection.

The intersections that contribute to, or receive value from, the starting point show the stage and associated members. The percentage for each allocation is displayed, from highest to lowest.

The percentages displayed for a stage will not equal 100% if the following conditions exist:

- If there are idle costs on an intersection.
- If there is cost input at a destination when drilling upstream (back to the source).

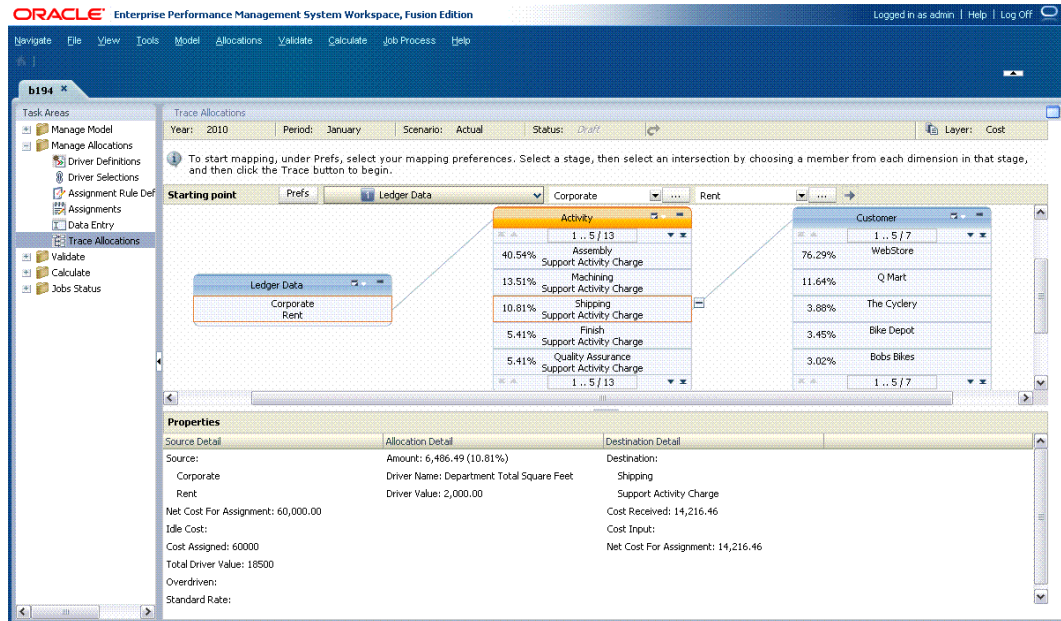



13. Double-click the stage header to expand and view the intersections that are included in the allocation. The source and destination intersections are highlighted.
14. Click any intersection to view its details in the **Properties** pane at the bottom of the screen.

The following details are displayed:

- Under **Source Detail**:
 - Source displays the dimension members included in the intersection from which the value has been contributed
 - Net Cost For Assignment
 - Idle Cost, if any
 - Cost Assigned
 - Total Driver Value
 - OverDriven, if any
 - Standard Rate, if any
- Under **Allocation Detail**:
 - Amount of the allocation
 - Driver Name
 - Driver Value
- Under **Destination Detail**:

- Destination displays the dimension members included in the intersection to which the value is allocated
- Cost Received
- Cost Input
- Net Cost For Assignment

15. Follow the flow throughout the model, as required:

- Use **expand**  to follow the direct allocations throughout the model
- Use **collapse**  to close the list of intersections.

Tracing Allocation Flow

The Allocation flow displays the source and destination intersections that have an indirect relationship, rather than a direct assignment, to the selected intersection. For example, you may have values from Stage 1 allocated to Stage 3, without any intermediate steps. By following the flow of each allocation, you can examine the contributions from the source at each step, to understand the impact of an allocation on its ultimate source or destination.

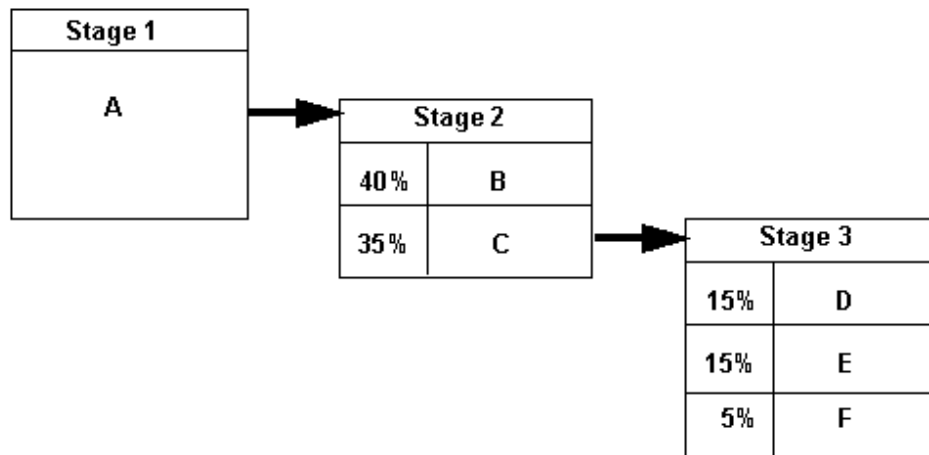

Direct allocation data is used to calculate the percentage for each step along the flow using the following formulas:

- For drilling forward:

$$\% = (\text{ASSG CostReceivedPrior}(\text{orIntra})\text{Stage} / \text{SRC NetCostForAssignment}) * \text{SRC } \%$$

- For drilling backward:

$$\% = (\text{ASSG CostReceivedPrior}(\text{orIntra})\text{Stage} / \text{DEST NetCostForAssignment}) * \text{DEST } \%$$

For each stage, the percentage of each allocation contributing to the next intersection is displayed, from highest to lowest. The percentages displayed for a stage will not equal 100% if there are idle costs on an intersection.

To trace allocation flow:

1. Ensure all allocation scripts have been run. See [Calculating Direct Allocation Data](#).
2. In an open model, from **Task Areas**, select **Manage Allocations**, then **Trace Allocations**.

The Traceability screen is displayed.

3. Select the POV and Layer, then click **Go** .
4. Under **Starting Point**, select **Prefs** to choose the preferences for the information to be traced:
 - Select **Allocation Flow** to display the source and destination intersections that have an indirect relationship, rather than a direct assignment, to the selected intersection.
 - Select a display mode for the map:
 - Display Alias
 - Display Name

 **Note:**

If Display Alias is selected, and no alias has been set, the Display Name is shown in square brackets.

5. Under **Starting Point**, select the **Stage** to be viewed.
6. For each dimension, click **Selector**  to choose the member for the intersection at which you want to begin tracing. You must select the lowest level member in order to display the allocation.

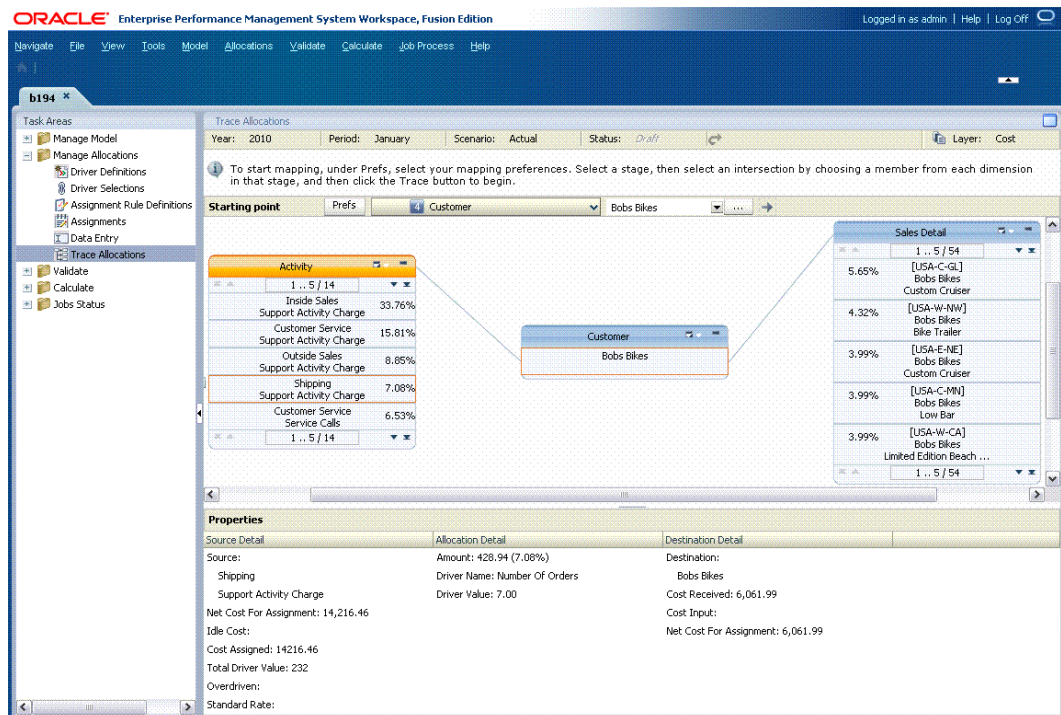

Oracle Enterprise Performance Management System Workspace, Fusion Edition

Logged in as admin | Help | Log Off

Task Areas: Manage Model, Manage Allocations, Driver Definitions, Driver Selections, Assignment Rule Definitions, Assignments, Data Entry, Trace Allocations, Validate, Calculate, Jobs Status

Trace Allocations: Year: 2010, Period: January, Scenario: Actual, Status: Draft, Layer: Cost

To start mapping, under Prefs, select your mapping preferences. Select a stage, then select an intersection by choosing a member from each dimension in that stage, and then click the Trace button to begin.

Starting point: Prefs, Customer, Bobs Bikes

Activity	Percentage
Inside Sales	33.76%
Support Activity Charge	
Customer Service	15.81%
Support Activity Charge	
Outside Sales	8.85%
Support Activity Charge	
Shipping	7.08%
Support Activity Charge	
Customer Service	6.53%
Service Calls	

Percentage	Intersection
5.65%	[USA-C-GL] Bobs Bikes Custom Cruiser
4.32%	[USA-W-MW] Bobs Bikes Bike Trailer
3.99%	[USA-E-NE] Bobs Bikes Custom Cruiser
3.99%	[USA-C-MW] Bobs Bikes Low Bar
3.99%	[USA-W-CA] Bobs Bikes Limited Edition Beach ...

Properties

Source Detail	Allocation Detail	Destination Detail
Source:	Amount: 428.94 (7.08%)	Destination:
Shipping	Driver Name: Number Of Orders	Bobs Bikes
Support Activity Charge	Driver Value: 7.00	Cost Received: 6,061.99
Net Cost For Assignment: 14,216.46		Cost Input:
Idle Cost:		Net Cost For Assignment: 6,061.99
Cost Assigned: 14216.46		
Total Driver Value: 232		
Overdriven:		
Standard Rate:		

- Click **Trace**  to begin mapping the financial flow.

 **Note:**

Depending on the number of dimensions in the model stage, you may need to stretch the window to see the Trace button on the far right side of the task bar.

The selected intersection is displayed on the screen, showing the name of the stage, and the members selected for each dimension in the intersection. The Properties for the starting point are displayed at the bottom of the screen.



- Optional:** On the intersection header, select the Trace Allocation Context Menu , and then select the maximum number of nodes you want to display when the selected intersection is expanded (3, 5, 10 or 20). You can repeat this selection on any intersection.
- Click the intersection to highlight the source node.

 **Note:**

Expand  is only displayed on the intersection after it has been selected.

- Under **Properties**, review the **Source Detail** that pertains to the selected intersection.
 - Source lists all dimension members selected for the starting point.
 - Net Cost For Assignment
 - Idle Cost, if any.
 - Cost Assigned to the starting point.
 - Total Driver Value
 - OverDriven, if any
 - Standard Rate, if any
- Highlight the next intersection, and click **expand**  to view the incoming or outgoing allocations for the selected intersection. You can navigate either

upstream or downstream by expanding the nodes on either side of the intersection.

The intersections that contribute to, or receive value from, the starting point show the stage and associated members. The percentage for each allocation is displayed, from highest to lowest. If there are idle costs on an intersection, the total percentage for the stage will not equal 100%.

 **Note:**

You can drag the entire flow diagram to position it for a more effective view. Depending on the number of dimensions in the model stage, you may have to stretch or scroll the window to see the Trace button on the far right side of the task bar.

12. Double-click the stage header to expand and view the intersections that are included in the allocation. The source and destination intersections are highlighted.

13. Double-click any intersection to view its associated details in the **Properties** pane.

The following details are displayed:

- Under **Source Detail**:
 - Source displays the dimension members included in the intersection from which the value has been contributed
 - Net Cost For Assignment
 - Idle Cost, if any
 - Cost Assigned
 - Total Driver Value
 - OverDriven, if any
 - Standard Rate, if any
- Under **Allocation Detail**:
 - Amount of the allocation
 - Driver Name
 - Driver Value
- Under **Destination Detail**:
 - Destination displays the dimension members included in the intersection to which the value is allocated
 - Cost Received
 - Cost Input
 - Net Cost For Assignment

14. **Optional:** Click **expand**  to follow the allocations throughout the model.

Reciprocal Allocation

The net reciprocal cost for reciprocal allocations is calculated and reported on the Trace Allocations screen.

Net Reciprocal Cost is calculated as the difference between `ReciprocalCostReceived` and `ReciprocalCostAssigned`. The calculated percentage of the selected intersection is also displayed.

To locate reciprocal allocations in the model, you can view the intersections and values for the reciprocal allocations in Oracle Essbase under the following Cost Layer Allocation Measures:

- `ReciprocalCostAssigned`
- `ReciprocalCostReceived`

The calculated amounts and percentage values may be displayed as negative values, which represent the amount or calculated percentage of the intersection that is being allocated back to the other portion of the reciprocal allocation.

By default, reciprocal allocations on the Trace Allocations screen are listed at the end of each list of intersections.

Example: Reciprocal Allocations

In the following allocation flow diagram, the intersection of Information Technology, Desktop Maintenance maintains a reciprocal allocation with Human Resources, Compensation and Benefits Admin.

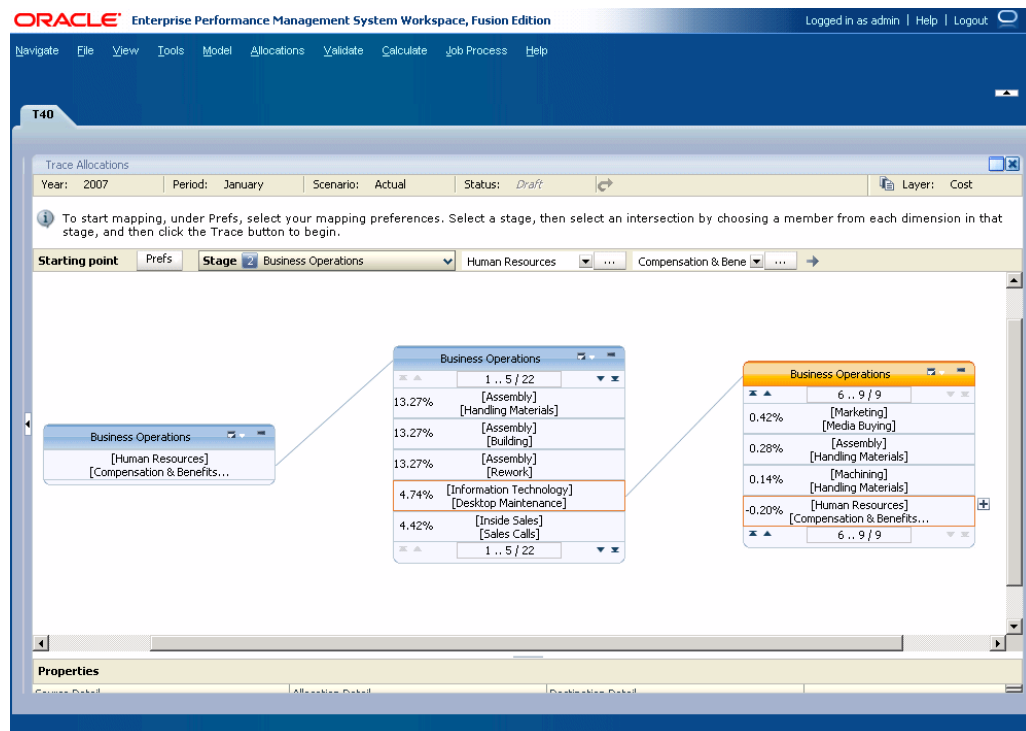

The net reciprocal cost for each intersection is calculated as follows:

- **Information Technology, Desktop Maintenance** — Net reciprocal cost of 216.24, which represents 4.74% of Human Resources, Compensation & Benefits Admin.
- **Human Resources, Compensation and Benefits Admin** — Net reciprocal cost of -216.24, which is -0.20% of Information Technology, Desktop Maintenance.

The negative (-) value in Human Resources, Compensation and Benefits Admin represents the amount that is being allocated back to Information Technology, Desktop Maintenance.

Exporting Trace Allocation Images

After generating the trace allocation diagrams, you can export the image to another location for printing or viewing.

To export trace allocation images:

1. Generate the traceability diagram, as outlined in these sections:
 - [Tracing Allocation Detail](#)
 - [Tracing Allocation Flow](#)
 - [Reciprocal Allocation](#)
2. From the Oracle Hyperion Enterprise Performance Management Workspace main menu, select **Allocations**, and then **Export Traceability** (Ctrl+Shift+E).
A new browser opens, displaying the traceability diagram. The diagram is exported as a .png image.
3. Right-click the image, and select **Save Picture As**.
4. Save the traceability diagram as a .png image to a new location from which the diagram can be viewed or printed.

Caution:

Do not change the graphic format file extension from .png, or the graphic may be corrupted.

Validating Standard Profitability Models

Related Topics

- [About Validation](#)
A model must be validated several times during its lifecycle.
- [Model Structure Validation Rules](#)
The model is verified against a set of model validation rules to ensure the structure is sound before adding data.
- [Unassigned Values](#)
Costs and revenue within a model should be assigned to a specific activity or account; however, some costs or revenue may remain unassigned at any stage of the model.
- [Idle Capacity](#)
The term, full capacity, indicates that all model resources are being fully used to perform a task or assignment.

- [OverDriven Costs and Revenue](#)
Oracle Hyperion Profitability and Cost Management drives cost or revenue from a source to a destination, using a combination of assignments, which govern where to drive the cost, and drivers, which determine the amount to drive.
- [Validating Model Structure](#)
The model structure must be validated, one stage at a time, to ensure all required modeling rules have been applied.
- [Generating the Stage Balancing Report](#)
After calculating the model, use the Standard Stage Balancing Report to validate the results by balancing assigned and input values to account for any unassigned costs.
- [Generating the Driver Data Report](#)
The Data Driver report documents, confirms, and updates the driver data entered into the model.

About Validation

A model must be validated several times during its lifecycle.

- After the model is built, perform Model Validation to ensure the model structure conforms to modeling rules.
- After data is added, generate Driver Data Reports for selected drivers to ensure that all data required for calculations is present.
- After calculating the model, generate a Stage Balancing Report to balance all in and out entries for the model stage.

The tabs available on the Structure Validation screen are read-only, and highlight any drivers that have not been used, or assignments that are missing an associated inbound or outbound assignment. You can also view a list of intrastage and reciprocal assignments for any stage within the model. Errors encountered during the model structural validation cycle must be corrected before you can continue to build or calculate the model.

See these sections to perform the appropriate validation on the model:

- [Model Structure Validation Rules](#)
- [Unassigned Values](#)
- [Idle Capability](#)
- [Validating Model Structure](#)
- [Generating the Stage Balancing Report](#)
- [Generating the Driver Data Report](#)

Model Structure Validation Rules

The model is verified against a set of model validation rules to ensure the structure is sound before adding data.

The structure validation checks to ensure these conditions are met:

- Each assignment of destinations to a source member has a driver
- Inbound assignments are associated with an outbound assignment

- No drivers are unused.
- Reciprocal assignments work correctly.
- Intrastage assignments work correctly.
- Assignment rules are correct.

Any structural error must be resolved before you can calculate the model. Correct any structural errors, and submit the stage for validation again. You may need to correct errors and revalidate several times. The only exception is the "No drivers are unused" warning, which can exist while still enabling the calculations to be successfully performed with unused drivers in the model.

 **Tip:**

Sometimes correcting one error may cause another problem, so it is useful to revalidate the model stage after each correction.

Unassigned Values

Costs and revenue within a model should be assigned to a specific activity or account; however, some costs or revenue may remain unassigned at any stage of the model.

These values are reported as unassigned cost or revenue.

There are two types of unassigned values:

- Costs or revenue that are allocated to a node, and do not continue to flow forward. See [Example 1 — Flow Stops](#).
- Costs or revenue allocated from a node that have some residual value at the node. See [Example 2 — Residual Value](#).

Depending on how a model is created, these unassigned values may be expected and acceptable, or they may represent an error in allocation that needs to be corrected.

 **Tip:**

If certain costs or revenue are logically stopped before the end of the model flow, Oracle recommends that you create a specific area of the dimension hierarchy to accept the unassigned values. When the model is validated, this modeling method helps distinguish between expected unassigned values and allocation errors require correction.

During validation, unassigned costs and revenue are flagged. All aggregated unassigned values for a stage and intersection are reported in the `UnassignedCost` or `UnassignedRevenue` members in the Measures dimension. Review unassigned values to determine whether they need to be allocated.

Example 1 — Flow Stops

In the example below, the value from stage A (\$100) is allocated to B1, B2, and B3.

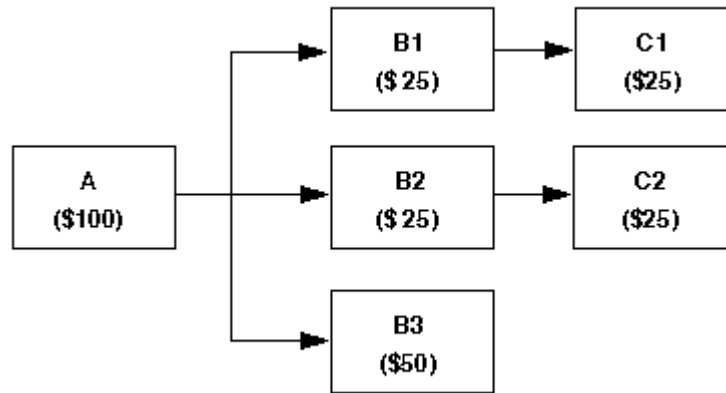

The values from B1 and B2 are allocated to C1 and C2 respectively; however, B3 has no further assignments. In this example, the \$50 from B3 will be reported under `UnassignedCost` or `UnassignedRevenue` in the Measures dimension.

Example 2 — Residual Value

In the following example, which uses a percentage driver, the allocation of values to subsequent assignments leaves a residual value at the original intersection.

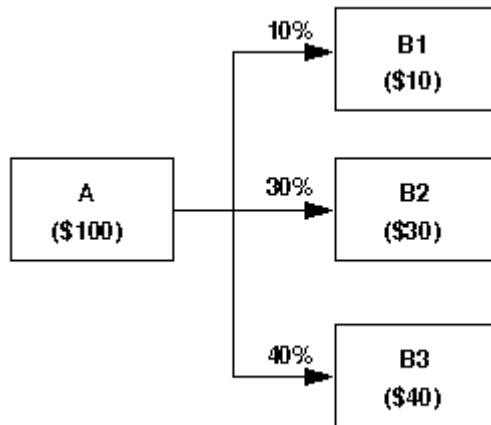

Stage A contains \$100. Based on the percentage drivers, allocations to intersections in Stage B account for 80% of the value of the original amount. These assignments mean that 20%, or \$20, of the original amount remains unallocated. The \$20 is treated as `IdleCost`.

Idle Capability

The term, full capacity, indicates that all model resources are being fully used to perform a task or assignment.

The term, idle capability or idle capacity, indicates that some model resources are not being fully utilized. To maximize the use of resources, or to monitor inefficiencies, such as machine downtime, you may want to track idle capability.

You set the ability to calculate and report idle capability when you create or modify a driver, by selecting the Allow Idle option, and then entering a total driver quantity as part of the driver data.

The Idle cost or revenue on each node is reported in the `IdleCost` or `IdleRevenue` members in the Measures dimension.

These driver measures are related to idle capability for actual basis drivers only:

- `IdleDriverValue` - Measure that is used as the driver value (DV) for calculating `IdleCost`.
- `TotalDriverValue` - Idle costs are based on a total driver quantity calculated, based on driver data entered by the user.
- `EffectiveTotalDriverValue` - Measure that is used to store the Effective Driver Total for those drivers for which the "Allow Idle" box has been selected on the source.

Idle capability is reported during structural validation of a model. If an unallocated remainder is detected, and the driver has not been set to allow idle capability, an error is generated.

Standard basis drivers are enabled to calculate idle capacity by default. If the total cost or revenue assigned is less than the `NetCostForAssignment`, then the remainder is stored as idle cost or revenue.

Example of Idle Cost for Standard Basis Drivers

Source X – 100 `NetCostForAssignment` assigned to 3 destinations (A,B,C)

- Destination A – 30 `CostReceived`
- Destination B – 30 `CostReceived`
- Destination C – 30 `CostReceived`

Source X – `NetCostForAssignment` = 100

Total amount driven from X to all destinations (`CostAssigned`) = 90

`IdleCost` = 10

`UnassignedCost` = 0

You can view Idle Cost on the Stage Balancing Report. See [Generating the Stage Balancing Report](#).

OverDriven Costs and Revenue

Oracle Hyperion Profitability and Cost Management drives cost or revenue from a source to a destination, using a combination of assignments, which govern where to drive the cost, and drivers, which determine the amount to drive.

With Actual basis drivers, the amount driven from the source to all destinations is always the actual amount. With Standard basis drivers, it is possible to drive more than the actual amount to the destinations. Overdriven cost is the amount that exceeds, or is "over" the actual amount that was driven from the source to all destinations

Example of OverDriven Cost

Source X - 100 NetCostForAssignment assigned to 3 destinations (A,B,C)

- Destination A - 35 CostReceived
- Destination B - 35 CostReceived
- Destination C - 35 CostReceived

Source X - NetCostForAssignment = 100

Total amount driven from X to all destinations (CostAssigned) = 105

OverdrivenCost = 5

UnassignedCost = 0

These measures are related to overdriven costs and revenue:

- Measures on Stage Balancing Report
 - OverDrivenCost
 - OverDrivenRevenue
- Cost Layer Allocation Measures
 - OverDrivenCost
- Revenue Layer Allocation Measures
 - OverDrivenRevenue

You can view OverDriven Cost or Revenue on the Stage Balancing Report. See [Generating the Stage Balancing Report](#).

Validating Model Structure

The model structure must be validated, one stage at a time, to ensure all required modeling rules have been applied.

All stages must be validated before deploying the model.

The Structure Validation displays this information for the selected model stage:

- Unused Drivers displays any existing drivers that are not being used.
- Intrastage Assignments shows assignments with a source and destination within the same stage.

- Missing Assignment Destinations displays unassigned costs or revenue.
- Missing Driver Assignments lists assignments for which a valid driver has not been selected.
- Reciprocal Assignments shows any reciprocal assignments within the selected stage.
- Assignment Rules list any errors associated with an assignment rule.
- Rules and Explicit displays all sources within the model that have both assignment rules and explicit assignments attached to the same source. Because only one type of assignment is allowed on an intersection, one of the assignments must be removed from that source.

Before a model can be successfully calculated, all errors in the model structure must be corrected. The only exception is the "No drivers are unused" warning, which can exist while still enabling the calculations to be successfully performed with unused drivers in the model.

To validate model stages:

1. In an open model, from **Task Areas**, select **Validate**, then **Model Validation**.

The Model Validation screen is displayed.

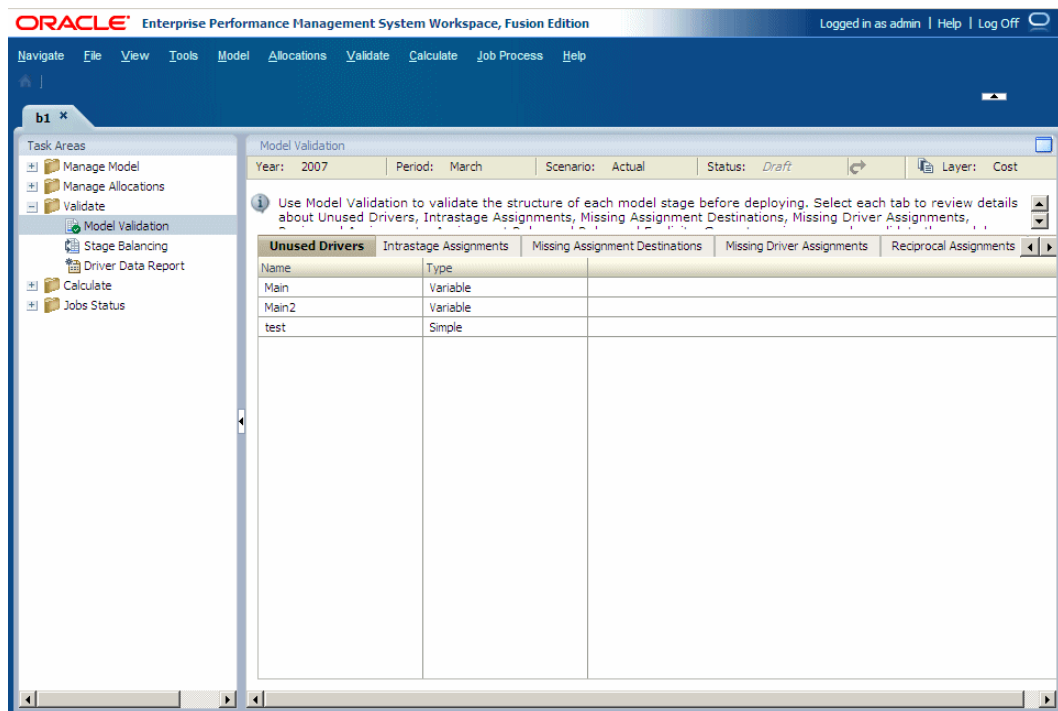

2. Select the POV for the model to be validated and then click **Go** .
3. From **Layer**, select the cost or revenue layer to begin the validation process.
When the validation is complete, the screen is updated to reflect the results.
4. **Optional:** Select the **Unused Drivers** tab to view any unassigned drivers in the model, and determine whether these drivers should be part of an assignment.
See [Selecting Standard Profitability Drivers](#) to assign the driver.
5. On the **Intrastage Assignments** tab, view Assignments for the selected stage.

If any changes are required for the intrastage assignment, see [Working with Standard Profitability Assignments](#).

6. **Optional:** Select the **Missing Assignment Destinations** tab to view all intersections that have value coming in, but no outgoing assignment. By definition, the final stage of the model is the only stage that does not require an outgoing assignment.

For each model stage, you must select the stage and the type of assignment:

- Select **Show Assignments** Rules to view all missing assignment rules destinations.
- Select **Show Regular Assignments** to view all missing regular assignment destinations.

With the exception of planned and expected unassigned costs or revenue, you must correct any missing assignments before the model can be calculated. See [Working with Standard Profitability Assignments](#).

7. **Optional:** Select the **Missing Driver Assignments** tab to view all intersections that are missing driver assignments.

For each model stage, you must select the stage and the type of assignment.

You must correct any missing driver assignments before the model can be calculated. See [Selecting Standard Profitability Drivers](#).

8. **Optional:** Select the **Reciprocal Assignments** tab to view any reciprocal assignments for a specific stage:
 - a. Under the **Select Stage** drop-down, select the stage of the model for which you want to view reciprocal assignments. Only stages that are marked as potential intrastage assignments are available from the list.
 - b. Select the regular assignments that you want to view.

The number of reciprocal assignments included in the loop in the model stage is displayed under **Reciprocals**. The dimension and member combinations for each part of the reciprocal loop are listed in sequence of operation. If any changes are required for the intrastage assignment, see [Working with Standard Profitability Assignments](#).

 **Note:**

An exclamation mark (!) is displayed beside any reciprocal assignments that do not have other outbound assignments in the "Closed-loop cycle" column, or that have Standard Basis driver in the "Standard Basis" column.

9. **Optional:** On the **Assignment Rules** tab, click **Validate** to display error messages for the Assignment Rules.
You must correct incorrect assignment rules before the model can be calculated. After fixing the error, click **Validate** to ensure that the assignment rule is now correct.
10. **Optional:** Select the **Rules and Explicit** tab to view all sources within the model that have both assignment rules and explicit assignments attached. In this case, one of the assignments must be removed from the source.

11. Optional: Select the **Queries** tab.

If dimensions or dimension members have been renamed or deleted, Smart View queries which reference the dimensions or dimension members become invalid. Smart View query validation screen will validate all the queries and show the invalid queries with the error message.

12. When all errors on all tabs have been corrected, repeat the structure validation until no errors are detected.

13. When the validation is successful, calculate the model. See [Calculating Standard Profitability Models](#).

Generating the Stage Balancing Report

After calculating the model, use the Standard Stage Balancing Report to validate the results by balancing assigned and input values to account for any unassigned costs.

Separate reports must be generated for cost and revenue data.



Note:

In order to generate the Stage Balancing report, the database must be deployed, data should be loaded, and then the database must be calculated.

The outline structure provides the following information for each stage:

- Inputs - summation of the values associated with the input balancing measure
- Total Output is the sum of all output measure values on the Destination stage. This value is associated with the Received balancing measure
- Amount output to each downstream stage
- Total output to downstream stages
- Total unassigned cost or revenue
- Total idle cost or revenue
- Over Driven costs or revenues

Depending on the contents of the model, some or all of these types of data are available in each model stage:

Table A-11 Sources of Data for Stage Balancing Reports

Measure or Formula	Oracle Essbase Measure Name	Source of Data
Direct Input (User-entered cost and revenue)	<ul style="list-style-type: none"> • CostInput • RevenueInput 	Essbase
Assg Input (Assigned Input)	<ul style="list-style-type: none"> • CostReceivedPriorStage • RevenueReceivedPriorStage 	Essbase
Total Input	=Direct Input + Assigned Input	Calculated
Cost Assigned	CostAssignedPostStage NetCostForAssignment	Essbase

Table A-11 (Cont.) Sources of Data for Stage Balancing Reports

Measure or Formula	Oracle Essbase Measure Name	Source of Data
Numbers representing each stage	CostReceivedPriorStage or CostAssignedPostStage These numbers represent cost that is assigned from previous stages to the selected one. The calculated numbers can be compared to numbers in "Assg Input" to check for inconsistencies in Essbase.	Essbase
Total Out	SUM for all stages in current row	Calculated
Idle	<ul style="list-style-type: none"> IdleCost IdleRevenue 	Essbase
Over Driven	<ul style="list-style-type: none"> OverDrivenCost OverDrivenRevenue 	Essbase
Unassigned (in Essbase)	<ul style="list-style-type: none"> UnassignedCost UnassignedRevenue 	Essbase
Unassigned (in Essbase)	= "Total IN" - "Total OUT" - "Idle"	Calculated The calculated values can be compared against data from Essbase.

To print the report, select **File**, and then **Print** from the browser menu.

To generate stage balancing reports:

1. Before generating the report, ensure these applications and services are running:
 - Oracle Hyperion Provider Services
 - Oracle Hyperion Shared Services
 - Essbase

 **Note:**

In order to generate the Stage Balancing report, the database must be deployed, data should be loaded, and then the database must be calculated.

2. **Optional:** If you want to display the Stage Balancing Report using the calculation database, run a default Calc All on the Calculation (BSO) database before generating the report.
3. In an open model, from **Task Areas**, select **Validate**, then **Stage Balancing**.
The Stage Balancing screen is displayed.
4. Select the POV for the model, and then click **Go** .
5. From **Layer**, select the cost or revenue layer for the selected model.
6. From **Source database**, select the type of report to be generated:
 - **Reporting** (ASO database results) — Recommended

- **Calculation** (BSO database results) — Before using the Calculation database (BSO) to generate the Stage Balancing Report, all calculations and default calculations must be executed and complete.
7. Click **Run**.
- The report is generated.

Oracle Enterprise Performance Management System Workspace, Fusion Edition. Logged in as admin | Help | Log Off

Task Areas: Manage Model, Manage Allocations, Validate, Model Validation, Stage Balancing, Driver Data Report, Calculate, Jobs Status

Stage Balancing: Year: 2010, Period: January, Scenario: Actual, Status: Draft, Layer: Cost

To generate a Stage Balancing report, select a POV, Layer and Source Database, and then click Run.

#	Stage Name	Direct Input	Assigned Input	Total Input	Ledger Data	Activity	Product	Customer	Sales Detail	Total Output	Idle	Overdriven	Unassigned
1	Ledger Data	368,867.00		368,867.00		163,759.40	185,419.10			349,178.50	23,327.60	3,639.10	0.00
2	Activity		163,759.40	163,759.40						163,759.40			0.00
3	Product		291,553.61	291,553.61					291,553.61	291,553.61			0.00
4	Customer		57,624.89	57,624.89					57,624.89	57,624.89			0.00
5	Sales Detail		349,178.50	349,178.50						0.00			349,178.50

8. Review the report, using one or more of these validations to verify the results:
- Total Input – Total Output – Idle = Unassigned Values
 - Sum of all allocations to the stage = Assigned Input
 - Sum of unassigned values + Idle = Direct Input
 - You can also launch some predefined Smart View integrations from the Stage Balancing screen. The launch data points are represented as hyperlinks in the Stage Balancing screen and present values that have been contributed from one stage to another. You can drill down further on input or allocation data. For example, you could drill-down into Unassigned costs after an allocation run, or to examine input data that was used in the same run.

Generating the Driver Data Report

The Data Driver report documents, confirms, and updates the driver data entered into the model.

In order to generate the Driver Data report, the database must be deployed, and data loaded, although the data load is optional

You must run separate reports for cost and revenue data. If corrections are required, you may change the model structure in Oracle Hyperion Profitability and Cost Management, or directly edit the data in Oracle Essbase, or Microsoft Excel.

A log file is automatically generated when the Driver Data Report is run to record any errors and warnings. The file, `validationReport.txt`, is saved in the home directory of the user who is running the Profitability and Cost Management application server.

To generate Driver Data reports:

1. Before generating the report, ensure these applications and services are running:
 - Oracle Hyperion Provider Services
 - Oracle Hyperion Shared Services
 - Essbase

 **Note:**

In order to generate the report, the database must be deployed, and data loaded, but not calculated. In order to generate the Driver Data report, the database must be deployed, and the data should be loaded, although the data load is optional.

2. In an open model, from **Task Areas**, select **Validate**, then **Driver Data Report**. The Driver Data Report screen is displayed.

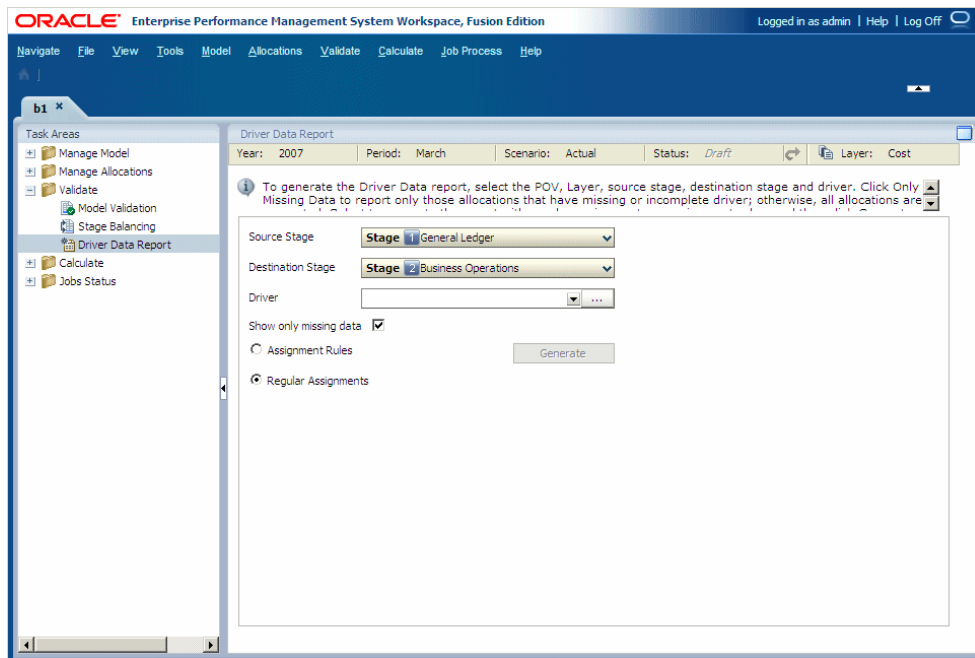

3. Select a POV for the selected model, and then click **Go** .
4. From **Layer**, select either the cost or revenue layer.
5. From **Source Stage**, select a source stage for the report.
6. From **Destination Stage**, select a destination stage for the report.
7. From **Driver**, select the driver for which you want to validate data.

You can edit the report directly in its text format, and import the results into Essbase.

Also, you can paste the data into Microsoft Excel, edit it, and return the driver data back to the report file, and then import it to Essbase.

14. **Optional:** To print the report, select **File**, and then **Print** from the text file menu.

Calculating Standard Profitability Models

Related Topics

- [About Calculating Standard Profitability Models](#)
After you validate the structure and data of a model, you must deploy the databases and then calculate the model.
- [Managing Databases](#)
After validating the structure and data of a model, you must deploy both the Reporting and Calculation databases to create the metadata outlines.
- [Managing Calculations](#)
After deploying the databases, you can calculate the model. Oracle Hyperion Profitability and Cost Management performs two calculations.
- [Calculation \(Calc\) Scripts](#)
Calculation scripts detail all the calculations required for a model, and they must be generated for each model.
- [Calculating Direct Allocation Data](#)
The Allocation tab of the Manage Calculation screen is used to calculate the results of direct assignments for source and destination intersections.
- [Transferring Data](#)
After the Reporting database is deployed, transfer calculated allocation data to the Reporting database for one or more POVs.
- [Genealogy Data](#)
Genealogy data calculates the allocation detail for source and destination intersections that are indirectly related, rather than directly assigned to each other.
- [Calculating Multistage Contribution Paths in Genealogy](#)
When calculating genealogy, you can generate data to analyze contributions through multiple stage combinations.

About Calculating Standard Profitability Models

After you validate the structure and data of a model, you must deploy the databases and then calculate the model.

For Standard Profitability models, Oracle Hyperion Profitability and Cost Management performs two calculations:

- Direct Allocation calculates the results of direct assignments for source and destination intersections.
- Genealogy calculates the allocation detail for source and destination intersections that are indirectly related rather than directly assigned to each other.

The direct allocation data is required for genealogy, so it must be calculated first.

You can run the operations directly from the screen, or schedule a suitable time.

 **Caution:**

Before calculating a model, ensure that cost, revenue, and driver data have been loaded into Oracle Essbase; otherwise, the calculation scripts run using an empty data set.

Managing Databases

After validating the structure and data of a model, you must deploy both the Reporting and Calculation databases to create the metadata outlines.

 **Note:**

Whenever metadata is changed, you should redeploy the application. Any redeployment should be followed by an Oracle Essbase deployment to keep metadata synchronized.

Use the following procedures to deploy the databases:

- [Deploying the Calculation Database](#)
- [Deploying Reporting Databases](#)

Deploying the Calculation Database

The options on the Calculation Database tab apply only to the calculation database. A Calculation database is created using the Oracle Essbase Block Storage option (BSO) to create the metadata outline.

 **Note:**

- Reporting cube deployment fails when a generic dimension is associated with a dynamic hierarchy type. An ASO cube cannot have attribute dimensions associated with dynamic generic dimensions.
- Oracle recommends that, before importing data or artifacts, you create a backup of the data in Oracle Hyperion Enterprise Performance Management Workspace and Essbase. Contact the administrator for assistance.

For the first deployment of a database, you should select the Replace Database option to create the database in its entirety. After the first deployment, when you need to redeploy the calculation database, you can select deployment options to retain or restore the existing artifacts and property setting in the new database.

The following artifacts may be retained:

- Essbase data
- System-generated and user-created calculation scripts

- Report scripts
- Substitution variables
- Rules Files
- Security Filters
- Database settings

For the Calculation database only, data may be exported using one of these formats:

- If there is at least one dense dimension with less than 1,000 dimension members, data is exported in a column format and a rule file is generated. The Rules file is generated after the new outline is created.

This Rules File specifies the format of the data for Essbase. The file is located in the same folder as the Essbase Database Application folder that contains the exported data. The file name is formatted as follows:

RMMddxxx.rul or RMMddxxx.txt

where MM is the current month, dd is the current day of the month, and xxx is a generated unique identifier. The file name with the extension .rul contains the rule file, and the file name with the extension .txt contains the data file.

- If there is no dense dimension with less than 1,000 dimension members, data is exported in a flat file.

Before redeploying, the system analyzes the dimensions and generates a message advising which export option will be used. Any errors in the deployment are reported in hpcm.log.

To deploy calculation databases:

1. In an open model, from Task Areas, select **Calculate**, and then **Manage Database**.

The Calculation Database tab of the Manage Database screen is displayed.

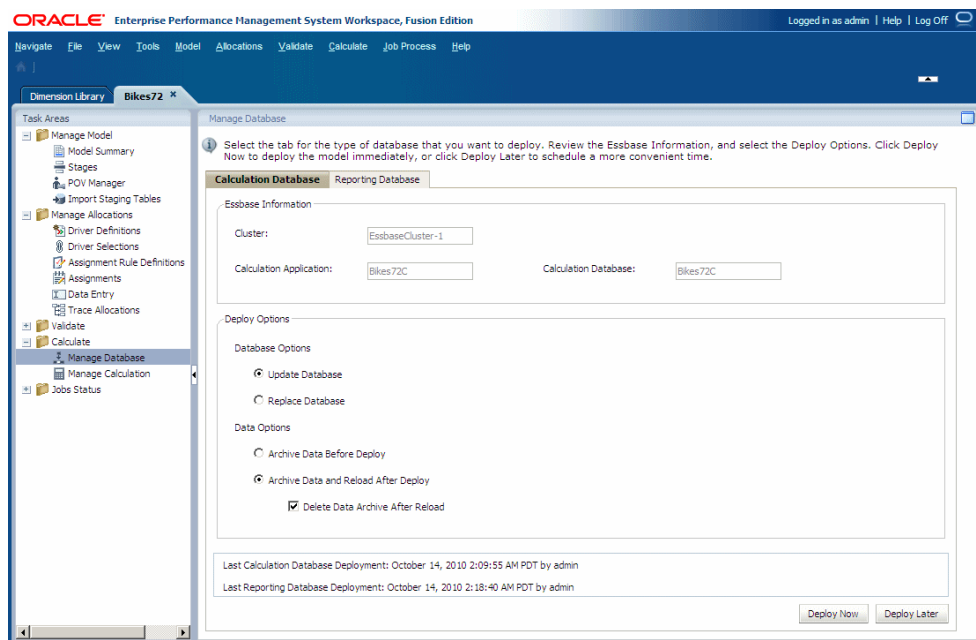

2. Under **Essbase Information**, review the following information:
 - **Cluster** displays the name of the Essbase database server that contains the model.
 - **Calculation Application** displays the name of the application being deployed.
 - **Calculation Database** displays the name of the Essbase database to which the application is being deployed.
3. Under **Deploy Options**, select the **Database Options** for deploying the calculation database:
 - For the first deployment of a database, all selections are grayed out. This option creates the entire database for the first time.
 - To redeploy an existing database, select **Update Database** to retain existing artifacts and property settings in the new database, and change the outline to reflect current metadata.
 - For subsequent deployments, select **Replace Database** to remove the database and applications completely, and recreate them.
4. Under **Deploy Options**, select the **Data Options** to be used for the calculation database deployment:
 - Select **Archive Data Before Deploy** to export existing data to the application database folder. For the Calculation database, only level-0 data is exported. Data is exported in a column format only if a dense dimension with fewer than 1,000 members exists; otherwise, the data is exported in native format.
 - Select **Archive Data and Reload After Deploy** to automatically import the data back into Essbase, using the previously exported data files. A Rules File is generated if the data was exported in the column format when the new outline is created.

 This option is available only if no dimensions are being added or removed. Dimensions can be added or removed in the Profitability Applications Console, or by adding, deleting, or changing a stage in Oracle Hyperion Profitability and Cost Management.

 After deleting dimension members, the **Archive Data and Reload After Deploy** option for redeploying the cube to Essbase and preserving the data is not guaranteed to always work, depending on how Essbase is able to deal with those deleted members. As a workaround, you may have to export all data and remove the data for the deleted members and then reload the data in a separate step after deploying the cube without the **Archive Data and Reload After Deploy** option selected.
 - **Optional:** If **Archive Data and Reload After Deploy** was chosen, you can select **Delete Data Archive After Reload** to automatically delete the archived data only after the successful data reload.
5. **Optional:** Under **Last Calculation Cube Deployment**, review the date and time of the previous deployment.
6. **Optional:** Click **Deploy Later** to schedule a convenient date and time to run the deployment. See [Scheduling Task Flows](#).

 If this option is not selected when the task is created, you will not be able to schedule the task.
7. **Optional:** Click **Deploy Now** to deploy the Calculation database immediately.

 A confirmation message is displayed, indicating that the job has started and identifying the assigned taskflow ID.

Depending on the size and complexity of the model, this operation may take a significant amount of time.

8. Monitor the progress of the deployment on the Status Page using the taskflow ID, as described in [Monitoring Standard Profitability Job Status](#).
9. If the **Replace Database** option was chosen, or the data import failed for some reason, after deployment, load data from the Essbase database to ensure that the calculations are not run on an empty data set.

You can load input level cost, revenue, and driver data in two ways:

- Load data directly into the application through the Data Entry window, under Manage Allocations. See [Editing Driver Data](#).
- Load data into Essbase using Essbase data load techniques. See the *Oracle Essbase Database Administrator's Guide*.

10. Calculate the model.

See [Calculating Direct Allocation Data](#).

Deploying Reporting Databases

A Reporting database is created using the Oracle Essbase Aggregate Storage option (ASO). All calculations are performed through the database outline; and no calculation scripts are required. This option decreases retrieval times and increases scalability.

After you create the Reporting database, the dimension information in the Oracle Hyperion Profitability and Cost Management model is used to generate the aggregate storage outline.

Any errors in the deployment are reported in `hpcm.log`.

To deploy calculation databases:

1. In an open model, from `Task Areas`, select **Calculate**, and then **Manage Database**.

The Calculation Database tab of the Manage Database screen is displayed.

2. Select the **Reporting Database** tab.

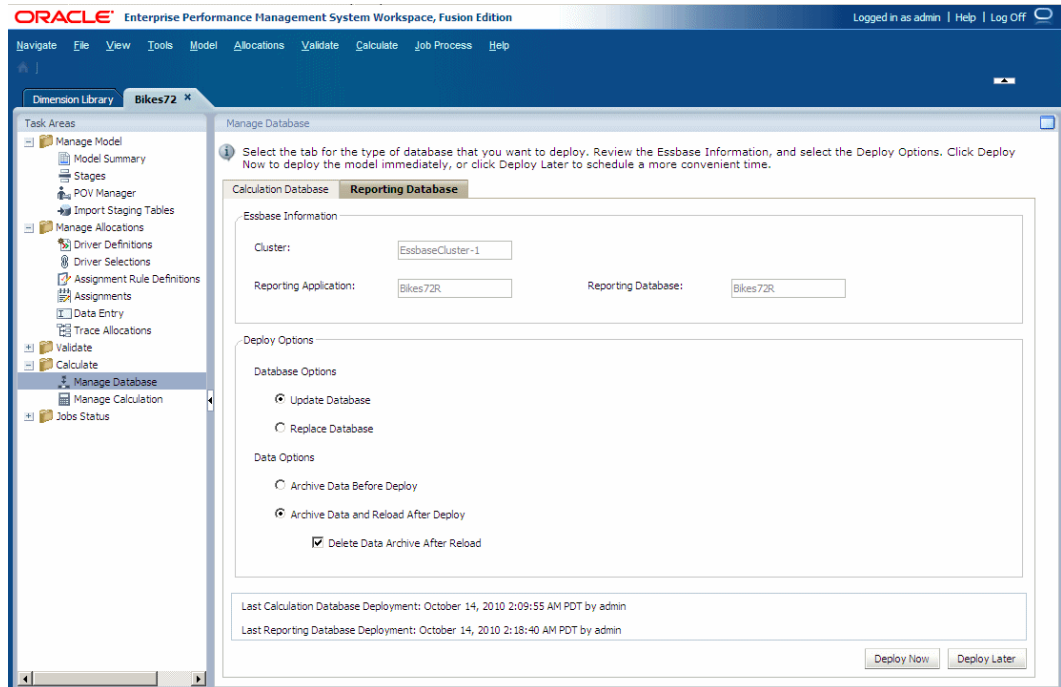

3. Under **Essbase Information**, review the following information:
 - **Essbase Server** displays the name of the Essbase database server that contains the model.
 - **Reporting Application** displays the name of the application being deployed.
 - **Reporting Database** displays the name of the Essbase database to which the application is being deployed.
4. Under **Deploy Options**, select the **Database Options** for deploying the calculation database:
 - For the first deployment of a database, all selections are grayed out. This option creates the entire database for the first time.
 - To redeploy an existing database, select **Update Database** to retain existing artifacts and property settings in the new database, and change the outline to reflect current metadata.
 - For subsequent deployments, select **Replace Database** to remove the database and applications completely, and recreate them.
5. Under **Deploy Options**, select the **Data Options** to be used for the Reporting database deployment:
 - Select **Archive Data Before Deploy** to export existing data to the application database folder. Only Level-0 data is exported for the Reporting database. For the Reporting database, data is always exported in the native format.
 - Select **Archive Data Before Deploy and Reload After Deploy** to automatically import the data back into Essbase, using the previously exported data files. A Rules File is not generated for Reporting databases.

This option is available only if no dimensions are being added or removed. Dimensions can be added or removed in the Profitability Applications Console, or by adding, deleting or changing a stage in Profitability and Cost Management.

After deleting dimension members, the **Archive Data and Reload After Deploy** option for redeploying the cube to Essbase and preserving the data is not guaranteed to always work, depending on how Essbase is able to deal with those deleted members. As a workaround, you may have to export all data and remove the data for the deleted members and then reload the data in a separate step after deploying the cube without the **Archive Data and Reload After Deploy** option selected.

- **Optional:** If **Archive Data and Reload After Deploy** is selected, you can select **Delete Data Archive After Reload** to automatically delete the archived data only after the successful data reload.
6. **Optional:** Under **Last Reporting Cube Deployed**, review the date and time of the previous deployment.
 7. **Optional:** Click **Deploy Later** to schedule a date and time to run the deployment. See [Scheduling Task Flows](#).

If this option is not selected when the task is created, you will not be able to schedule the task.

8. **Optional:** Click **Deploy Now** to deploy the Reporting database immediately.

A confirmation message is displayed, indicating that the job has started and identifying the assigned taskflow ID.

Depending on the size and complexity of the model, this operation may take a significant amount of time.

9. Monitor the progress of the deployment using the taskflow ID, as described in [Monitoring Standard Profitability Job Status](#).

Managing Calculations

After deploying the databases, you can calculate the model. Oracle Hyperion Profitability and Cost Management performs two calculations.

- Direct Allocation calculates the results of direct assignments for source and destination intersections.
- Genealogy calculates the allocation detail for source and destination intersections that are indirectly related rather than directly assigned to each other.

Because the direct allocation data is required for genealogy, it must be calculated first.

You can run the operations directly from the screen or schedule a suitable time.

Caution:

Before calculating a model, ensure that cost, revenue, and driver data have been loaded into Oracle Essbase; otherwise, the calculation scripts run using an empty data set.

Use the following procedures to manage calculations:

- [Calculation \(Calc\) Scripts](#)
- [Calculating Direct Allocation Data](#)

- [Transferring Data](#)
- [Genealogy Data](#)
- [Calculating Multistage Contribution Paths in Genealogy](#)

Calculation (Calc) Scripts

Calculation scripts detail all the calculations required for a model, and they must be generated for each model.

If only the cost, revenue, or driver data is changed, the calculation script can be used more than once for the same model. If any other model information is modified, the script must be regenerated to reflect the new calculations before it can be reused.

The calculation scripts are generated in the `$ARBORPATH/app/<application name>/<database name>` directory, on the machine where the configured Oracle Essbase server is running. If required, the administrator can view calculation scripts on the Essbase console.

Calculating Direct Allocation Data

The Allocation tab of the Manage Calculation screen is used to calculate the results of direct assignments for source and destination intersections.

The results for each level contribute to the results and calculations for the next level.

From this option, you can select the stages for which you want to generate and run the calculation scripts. If a selected calculation script is obsolete, a warning message is displayed, and the calculation script should be regenerated.

To calculate direct allocation data:

1. In an open model, from `Task Areas`, select **Calculate**, then **Manage Calculation**.

The Allocation tab of the Manage Calculation screen is displayed.

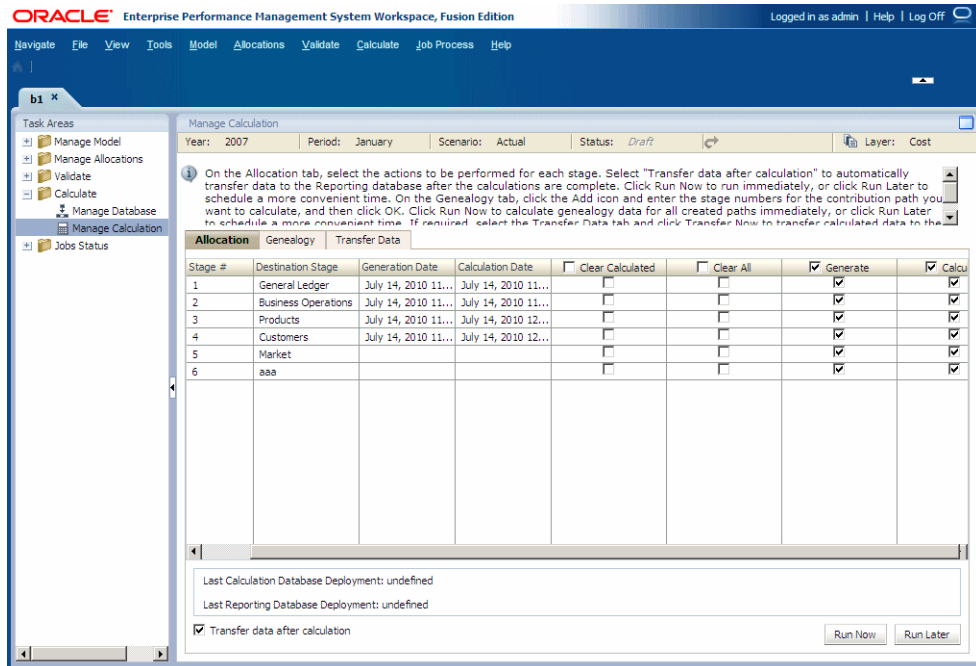

2. Select the action to be performed for the selected stage:
 - **Clear Calculated** to remove previously calculated data
 - **Clear All** to remove any existing data
 - **Generate** to generate the calculation scripts
 - **Calculate** to calculate the data
3. **Optional:** Review the date and time of the last deployment of the calculation and reporting databases.
4. **Optional:** Select **Transfer data after calculation** to automatically transfer *both* the Cost and Revenue data to the Reporting database after the calculations are complete. The calculated data must be transferred to the ASO Reporting database in order to view the Stage Balancing report, or to generate validation reports.
5. Perform one of the following tasks:
 - Click **Run Later** to schedule a date and time to deploy the Calculation scripts, run the calculations or clear data. See [Scheduling Task Flows](#)

 **Note:**

If this option is not selected when the task is created, you will not be able to schedule the task.

- Click **Run Now** to deploy the Calculations scripts, run the calculations or clear data immediately. A confirmation message indicates that the job has started, and identifies the assigned taskflow ID.

 **Caution:**

Depending on the size and complexity of the model, this operation may take a significant amount of time.

6. Monitor the progress of the deployment using the taskflow ID, as described in [Monitoring Standard Profitability Job Status](#).
7. After the Calculation database is calculated, transfer data to the Reporting database, as described in [Transferring Data](#).

Transferring Data

After the Reporting database is deployed, transfer calculated allocation data to the Reporting database for one or more POVs.

All Level 0 data — allocation and genealogy — is included in the transfer.

 **Note:**

The Calculation database must be calculated before the data can be transferred to the Reporting database.

To transfer data to the Reporting Database:

1. From **Task Areas**, select **Calculate**, then **Manage Calculation**.
The Manage Calculation screen is displayed.
2. Select a POV and Layer for the data transfer.
3. Select the **Transfer Data** tab to copy the calculated data to the reporting database.

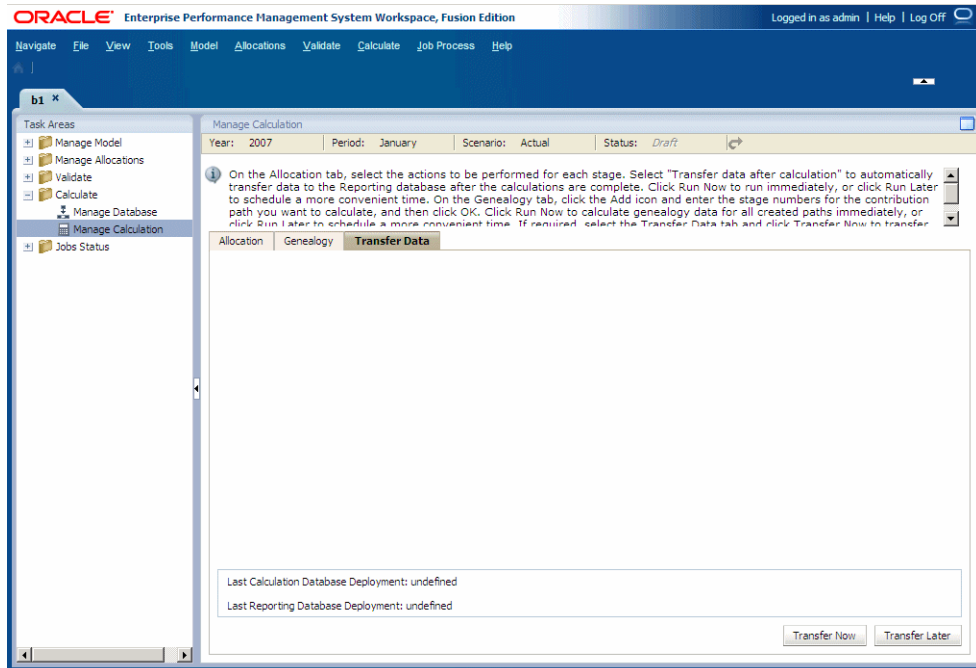

4. Perform one of the following tasks:
 - Click **Transfer Later** to schedule a date and time to run the transfer. See [Scheduling Task Flows](#).
 - Click **Transfer Now** to run the transfer immediately.

Caution:

Depending on the size and complexity of the model, this operation may take a significant amount of time.

5. When the data transfer is complete, use Reporting and Analysis tools, such as Web Analysis and Financial Reporting, or Microsoft Excel, to create reports and view results. See [About Running Reports for Standard Profitability Models](#).

Genealogy Data

Genealogy data calculates the allocation detail for source and destination intersections that are indirectly related, rather than directly assigned to each other.

Therefore, the results of one level may not contribute to the next level, but must contribute to some downstream intersection. Genealogy can be calculated for both the Cost and Revenue layers.

For example, in the following diagram, the results for Personnel and Manufacturing in Stage One of the model contribute to Bike Trailer costs in Stage Three.

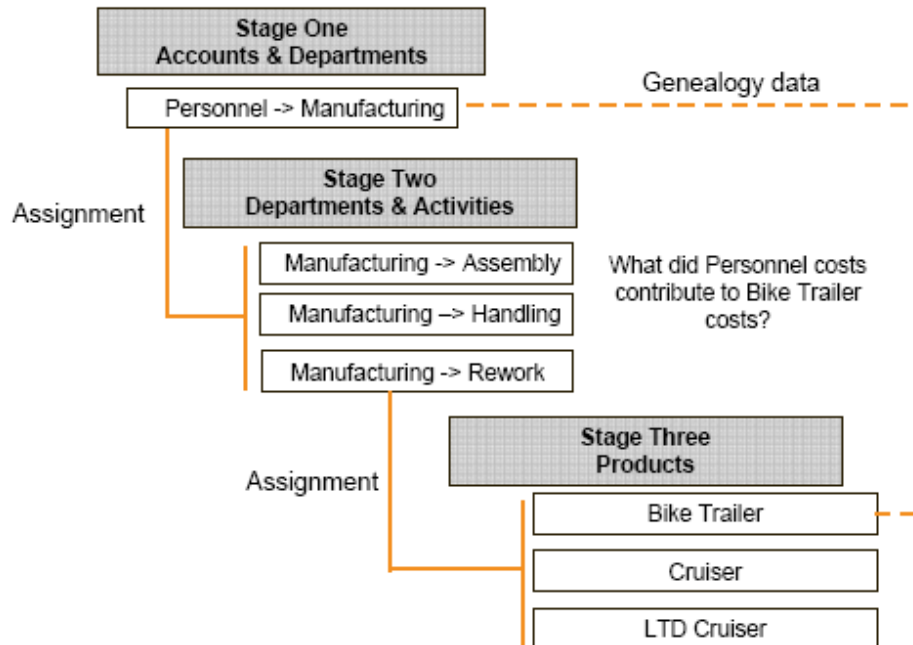

Calculating Multistage Contribution Paths in Genealogy

When calculating genealogy, you can generate data to analyze contributions through multiple stage combinations.

This feature enables you to examine how values from one stage contribute to results in a later stage, and provides visibility on the intermediate stages through which those values passed.

Genealogy data is calculated for multiple paths. Depending on the layer selection when you run the calculation, either cost or revenue is calculated in a single run. You cannot run both layers in one genealogy calculation.

After the genealogy calculation is performed, the data for all stage selections is saved, so that any time you return to the screen, you see the last combination of stage selections. When a new genealogy calculation is performed, all previously calculated genealogy data is erased and is replaced by the new results.

To trace contributions through multiple stages:

1. **Optional:** From Task Areas, select **Manage Model**, and then **Stages** to view the valid stage names and numbers.
2. From Task Areas, select **Calculate**, and then **Manage Calculation**.
3. Select the **Genealogy** tab.

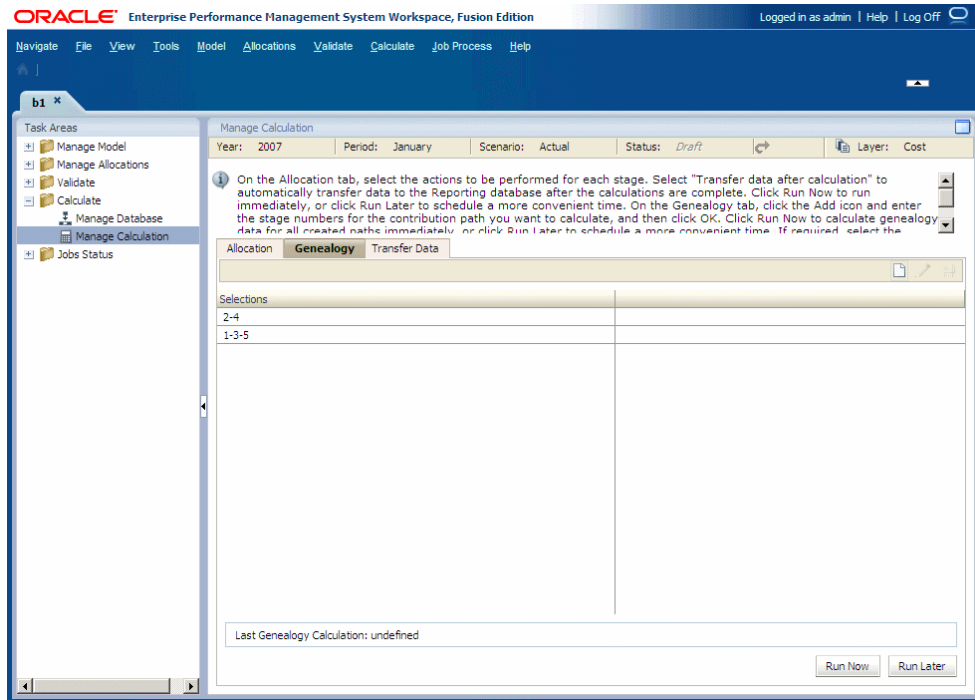

4. Click **Add**  to display the Add Contribution Path dialog box.

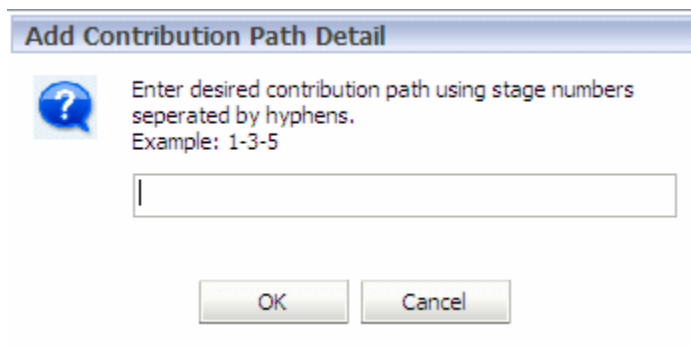

5. Enter the stage numbers for the required contribution path in the text box, separated by hyphens, and then click **OK**.

When selecting the stages for inclusion in the Contribution report, these restrictions are applied:

- At least two stages must be entered.
- Valid stage numbers must be entered in ascending order, separated by a hyphen. For example, "1-3-5" or "2-4".
- Each stage number must be entered only once in a contribution path.
- There must be at least one stage between the first and last stages selected for genealogy calculations. For example, "2-3" is an invalid selection.

The contribution path is listed under Selections on the Genealogy tab.

 **Note:**

The date of the Last Genealogy Calculation is displayed. Data from that calculation is saved and is available until the next genealogy calculation.

6. Select an option to run the calculations:
 - To schedule the task to run at a more convenient time, click **Run Later**. See [Scheduling Task Flows](#).
 - To perform the operation immediately, click **Run Now**.

To optimize calculations and to enable more than one path to be calculated at the same time, all calculations are run at once.
7. Click **Yes**.

An information message is displayed, advising that the job has been started, and providing the Taskflow ID.
8. Make a note of the Taskflow ID, and then click **OK**.
9. From Task Areas, select **Job Status**, and then **Search Task** to monitor the progress of the task.
10. After the taskflow is completed, verify the results in the Essbase database.
11. Create a Contribution Report in the reporting tool of the choice to view the calculation results.

Monitoring Standard Profitability Job Status

Related Topics

- [Job Library](#)

The Job Library lists all currently submitted or scheduled jobs for all models and all users for Standard Profitability applications.
- [Managing Task flows](#)

Task flows automate business processes, in whole or part.
- [Viewing Task flow Information](#)

The Task flow Listing Summary shows the existing task flows for the selected application, and provides basic details for each one.
- [Viewing Task Flow Status](#)

In the Task flow Status Summary screen, you can view and update the status of existing task flows.
- [Viewing Task Details](#)

You can view the details for an existing task flow using the Task Details option.
- [Scheduling Task Flows](#)

You can schedule the running of a task flow on a one-time or recurring basis.

Job Library

The Job Library lists all currently submitted or scheduled jobs for all models and all users for Standard Profitability applications.

Click any column in the Job Library to sort the jobs by Start Date and Time, Application Name, Job Type, Comment, User, Task Flow ID, or Status Message. Click again to reverse the sort.

Job Library Job Types

There are six job types that may be processed, and the Job Details information on the Job Library changes, depending on the Job Type:

- **Allocation Calc-Standard**
 - Job Details: Processing Options, custom scripts and model and data POVs that were selected when the calculation was set.
 - Job Finished: Date and time that the job is finished
 - ODL Task ID

See [Managing Calculations](#).
- **Copy POV**
 - Job Details: Source and Target POVs that were selected when the calculation was set, and the Copy Configuration
 - Job Finished: Date and time that the job is finished
 - ODL Task ID

See [Copying Standard Profitability POVs](#).
- **Cube Deployment**
 - Job Details: Name of the Oracle Essbase application, database options, and data options
 - Job Finished: Date and time that the job is finished
 - ODL Task ID
- **Genealogy Calculation**
 - Job Details: Selected POV
 - Stages: Stages of the genealogy; for example: 1-3-5, 1-5
 - Job Finished: Date and time that the job is finished
 - ODL Task ID
- **Import Staging Tables**
 - Job Details: Import configuration
 - JDBC Connection
 - Staging Table Selections for the import
 - Job Finished: Date and time that the job is finished
 - ODL Task ID

See [Importing Standard Profitability Data and Artifacts](#) and the "Standard Profitability Import Staging Tables" section in the *Oracle Hyperion Profitability and Cost Management Administrator's Guide*.
- **Transfer Data**
 - Job Details: Selected POV

- Job Finished: Date and time that the job is finished
- ODL Task ID

Viewing the Job Library

To view the Job Library:

1. From Oracle Hyperion Enterprise Performance Management Workspace, select **Navigate**, then **Applications**, then **Profitability**, and then select the application for which jobs have been submitted.
2. In an open model, from `Task Areas`, select **Jobs Status**, and then **Job Library**.
3. Under **Job Listing**, view the information for each job:

- **Start Date/Time** displays the date and time on which the job was submitted or is scheduled to be run.
- **Application** displays the name of the application for which the task is being run.
- **Job Type** displays the type of task that is being performed. See [Job Library Job Types](#)
- **Comment** shows a user-entered note or details about that specific job, such as Initial Run, Bulk Edit or Add Drivers. The Comment is entered when the task is submitted.
- **User** identifies the User ID of the individual who submitted the task for processing.
- **Task Flow ID** is the system-generated task ID for the specific task, displayed in the format `<application name>:<task name><generated taskflow number>`.

For example, the generated taskflow number may be displayed as

Demo04_RunCalcs_D20111103T183447_fbe, where **Demo04** is the application name, **RunCalcs** is the task, and **D20111103T183447_fbe** is the generated taskflow instance ID. See [Managing Detailed Profitability Task Flows](#).

- **Status** displays a message about the current state of the taskflow, such as Running, Success or Failure.
 - **Errors**
 - **Warnings**
4. **Optional:** Under **Job Details**, review the job options that were used for the execution of the highlighted job. The format of the details changes depending on the job type highlighted. The Processing Options, Custom Scripts, and POV options are displayed as applicable.

For additional information, see [Job Library Job Types](#).

5. **Optional:** Use the Find text box at the bottom of each column to locate a job by entering text in the Find field attached to the column in which it resides. See [Using the Find Feature](#).
6. Under **Job Finished**, view the date and time that the highlighted task was completed.
7. Under **ODL Task ID**, view the ID for the highlighted job to assist in locating error or warning messages in `hpcm.log`.

In the `hpcm.log` file, use Find and the ODL Task ID to locate the start of the logging detail text for the selected job. After locating the start of the log entries, you can search down to find an "ERROR" in the file.

8. **Optional:** If required, click **Stop Job** to end the highlighted task in Running state.

 **Caution:**

While the task flow stops quickly after the button is pressed, activities that affect results may require additional time to ensure that the state of the data is consistent.

For detailed instructions on using EPM Workspace taskflows, see the *Oracle Hyperion Enterprise Performance Management Workspace User's Guide*.

Managing Task flows

Task flows automate business processes, in whole or part.

Tasks are passed from one task flow participant to another, according to a set of procedural rules. In Oracle Hyperion Profitability and Cost Management, task flows are created in these circumstances:

- Staging tables are imported
- POV data is copied
- Calculation database is deployed
- Reporting database is deployed
- Calculation and genealogy scripts are generated and executed
- Data is transferred from the calculation database to the reporting database

 **Note:**

Task flows are not available when validating the model contents or structure.

A task flow ID is automatically generated for each task. Every time you run a task, a new task ID is generated. A taskflow can include one or more steps. Each task flow step represents a single action in Profitability and Cost Management:

- A one-step task flow performs one action, such as the generation of the Oracle Essbase database.
- Multistep task flows perform multiple actions, such as the script processing to generate or execute a calculation script.

In [Figure 1](#), you can see an example of a multistep task flow with six steps:

- Three steps for creating scripts (shown with a "C" prefix), and
- Three steps for executing scripts (shown with an "E" prefix).

 **Note:**

The taskflow step numbers indicate the task sequence, not the stage sequence.

Figure A-3 Example of Multiple Step Task flow

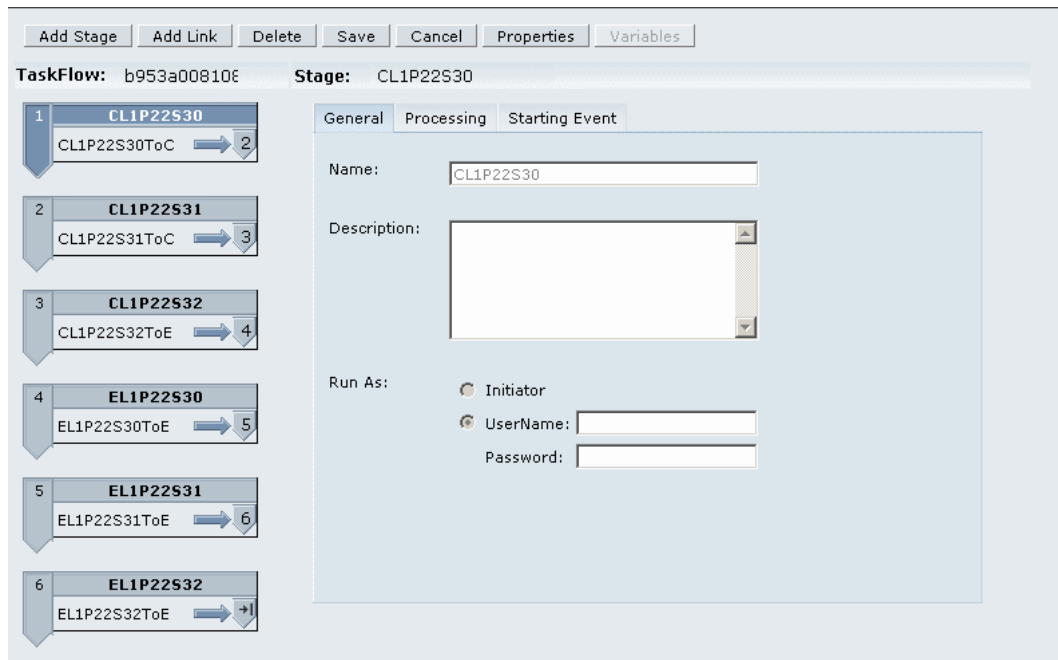

When you initiate a task flow, a task flow step is created and a task flow ID is assigned (for example, 'wf-1201275329264'). The ID enables you to monitor the progress of the task flow. A new Task flow ID is created each time you initiate a task flow instance. If a task flow is interrupted or restarted, it always begins again at step 1.

Each task flow step is executed in sequence, beginning with the first step. When the results for one step are completed, the next step is initiated. Status is only complete when all steps in the task flow have been performed.

You can use the Job Status option to view the task flow status and details, or to schedule the running of the task flow on a one-time or recurring basis.

In order to access the Job Process monitoring option, the following conditions must be satisfied:

- Profitability and Cost Management must be configured to use external authentication and Oracle Hyperion Shared Services functionality. See the *Oracle Enterprise Performance Management System Installation and Configuration Guide*.
- Taskflow users must be assigned one of the following Shared Services roles to perform task flow operations:
 - Manage Task flows—Permits users to create and edit task flows.
 - Run Task flows—Permits users to only run and view task flows. Users with this role cannot create or edit task flows.

 **Note:**

Both Shared Services roles are global user roles. Users assigned these roles can either modify or run task flows for any application and product. See the *Oracle Enterprise Performance Management System User Security Administration Guide*.

- A task flow must be created by calculating or generating calculation scripts and models before you can view details in the Job Status options. See [Calculating Standard Profitability Models](#).

 **Caution:**

Although you can add or remove steps and links, and create new task flows from the Task flow screens, Oracle recommends that you do not modify Profitability and Cost Management task flows. For additional information on using Oracle Hyperion Enterprise Performance Management Workspace task flows for other products, see the *Oracle Hyperion Enterprise Performance Management Workspace User's Guide*.

Use these procedures to monitor and schedule task flows:

- [Viewing Task flow Information](#)
- [Viewing Task Flow Status](#)
- [Viewing Task Details](#)
- [Scheduling Task Flows](#)

Viewing Task flow Information

The Task flow Listing Summary shows the existing task flows for the selected application, and provides basic details for each one.

To view task flow information:

1. In an open model, from **Task Areas**, select **Jobs Status**, then **Manage Task Flow**.

The Task flow Listing Summary screen is displayed.

The Summary displays this information for each task flow that exists for the selected application:

- **Application** displays the application name.
- **Task flow** displays the generated task flow number.

For example, the generated task flow number may be displayed as **HPM_ImportStaging_382728be43623bc2**, where **HPM** is the product name, **Import Staging** is the task, and **382728be43623bc2** is the generated application instance ID.

- **Created By** displays the ID of the user who created the task flow.

- **Description** provides a brief explanation of the task.

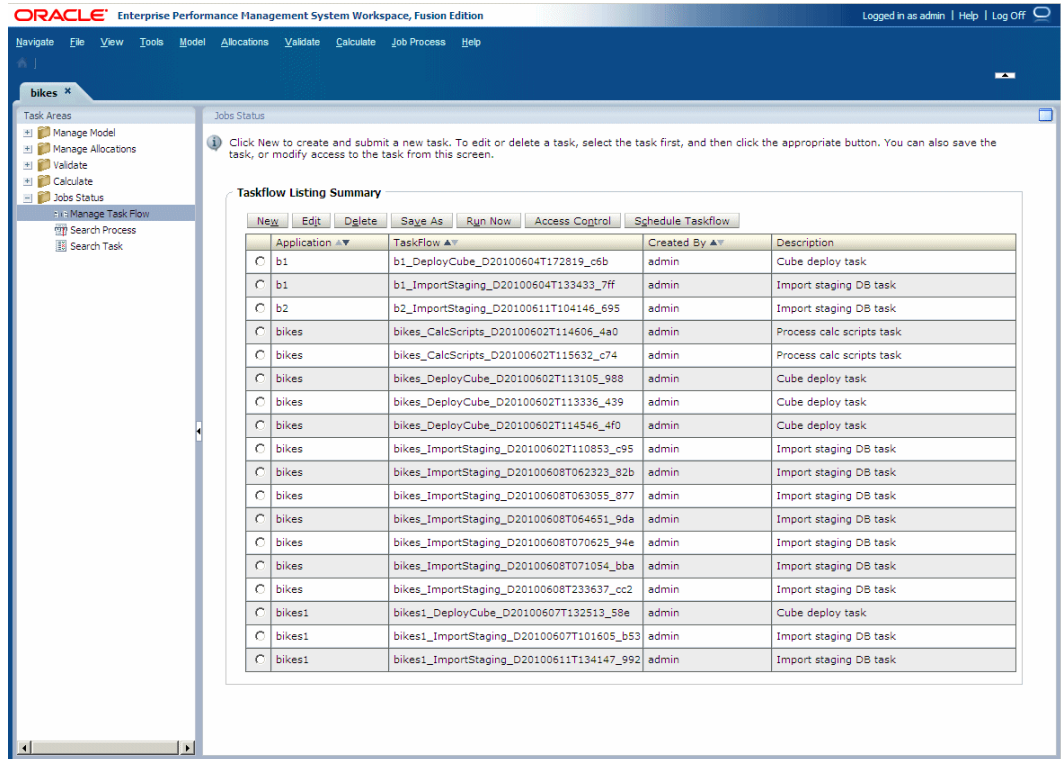

2. **Optional:** Click the radio button beside a task flow, and click **Schedule Task flow** to schedule the running of the task for a more convenient time or date.
3. Use the Task flow Listing Summary screen to perform various actions, such as deleting a task flow or scheduling the run of a task flow. For detailed instructions on using Oracle Hyperion Enterprise Performance Management Workspace task flows, see the *Oracle Hyperion Enterprise Performance Management Workspace User's Guide*.

Viewing Task Flow Status

In the Task flow Status Summary screen, you can view and update the status of existing task flows.

You can also filter the task flow list to display task flows with a specified status or date range.

A participant ID is created for each generated step in the task flow. You can drill-down on an individual task flow to view details of the associated participant summary.

To view task flow status:

1. In an open model, from **Task Areas**, select **Jobs Status**, then **Search Process**.

The Task flow Status Summary screen is displayed.

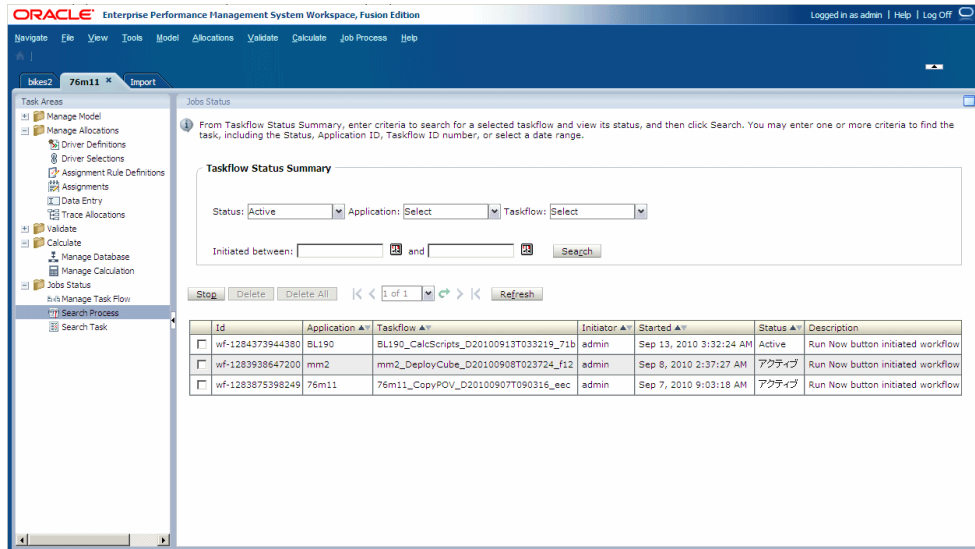

2. Select one or more search criteria to locate the task flow you want to view:

- a. Under **Status**, select a status of the task flow you want to view:
 - Active
 - Done
 - Stopped
 - All
- b. Under **Application**, select an Application ID.
- c. Under **Taskflow**, select a Task flow ID.
- d. For **Initiated Between**, click **calendar** , and select a start and end date for the search range.

 **Note:**

Depending on the requirements, you may leave all search fields blank to display all task flows, or make the search as specific as possible to narrow the results.

3. Click **Search**.

The search results are displayed at the bottom of the screen:

- ID (This is the participant ID, which is automatically generated for the taskflow.)
- Application ID
- Task flow ID
- Initiator of the task flow
- Time that the task flow began running
- Current Status of the task flow

- Description of the task flow
4. **Optional:** Click **Refresh** to update status information.
 5. **Optional:** To end the currently running step of a multi-step task flow, click the checkbox beside the appropriate task flow, and click **Stop**.
The task flow stops when the application returns the results of the selected step. The results for previous steps are not discarded; however, if the task flow is re-run, it begins at the first step.
 6. **Optional:** To view details of a task flow and its status, double-click the task flow name.
The Task flow Participant Summary is displayed, showing details of the task and its status.
 7. Click **Cancel** to return to the Task flow Status Summary.

Viewing Task Details

You can view the details for an existing task flow using the Task Details option.

A new task ID is generated each time you run a task.

To view task details:

1. In an open model, from **Task Areas**, select **Jobs Status**, then **Search Task**.

The My Tasks screen is displayed.

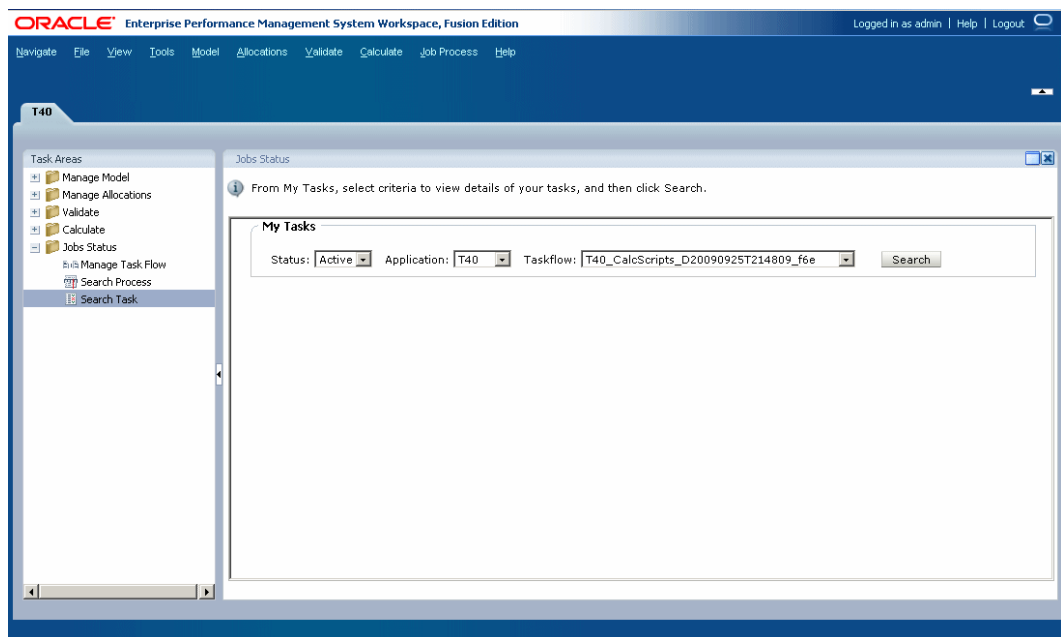

2. Select one or more search criteria to locate the task flow you want to view:
 - a. Under **Status**, select a status, such as **New**, **Active**, **Done**, or **All**.
 - b. Under **Application**, select an Application ID.
 - c. Under **Taskflow**, select the generated Task flow ID.

 **Note:**

Depending on the requirements, you may leave all search fields blank to display all task flows, or make the search as specific as possible to narrow the results.

3. Click **Search**.

The results of the search are displayed.

4. **Optional:** Use the forward and back arrows to scroll through the results. The current page in the sequence and the total number of pages are displayed.

5. **Optional:** Click **Refresh** to update status information.

6. Select a task flow, and then click **View Status**.

The Taskflow Participant Summary is displayed, showing details of the job and current status for the selected step in the task flow.

7. Click **Cancel** to return to the Job Status screen.

Scheduling Task Flows

You can schedule the running of a task flow on a one-time or recurring basis.

 **Note:**

If you want to schedule the task flow, you must have selected the "Run Later" option when you created the task.

To schedule task flows:

1. In an open model, from **Task Areas**, select **Job Status**, then **Manage Task Flow**.

The Taskflow Listing Summary screen is displayed. The Summary displays this information for each existing task flow:

- Application Name in the format *<product name>:<application ID>*. For example, **HPM:382728be43623bc2** where **HPM** is the product name and **382728be43623bc2** is the generated application instance ID.
- Generated Taskflow Number
- ID of the user who created the task flow
- Description of the purpose of the task flow

 **Note:**

A new task ID is generated each time you run a task.

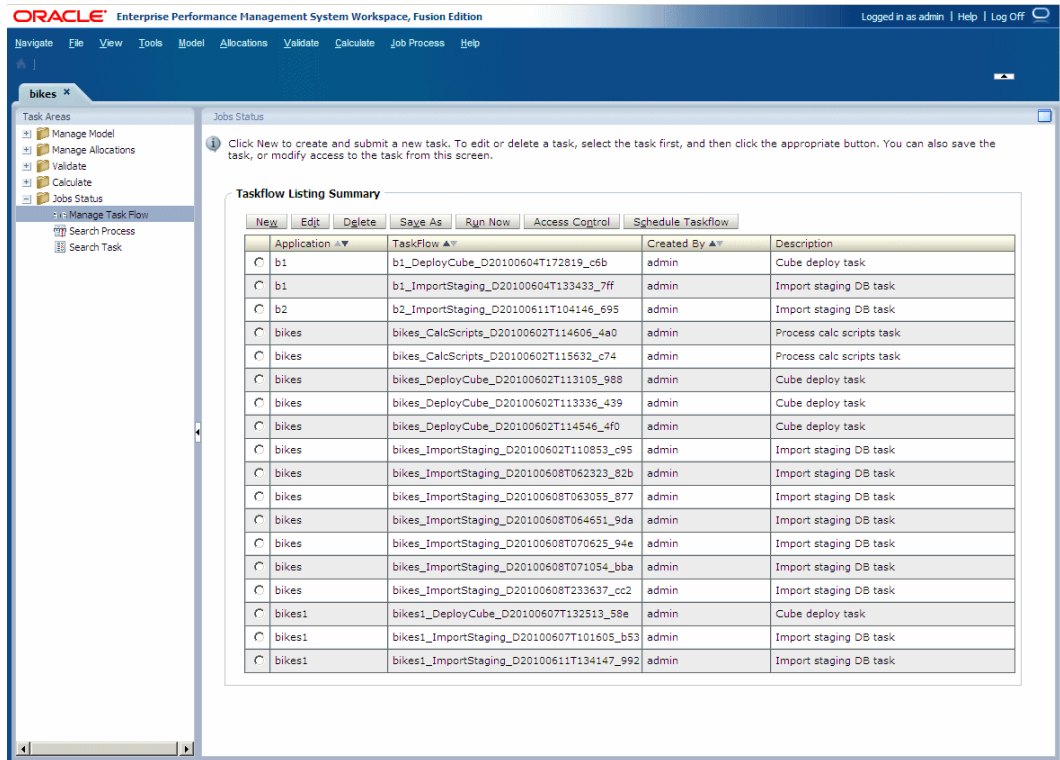

2. Select the task flow for which you selected the "Run Later" option when creating the task.
3. Click **Schedule Taskflow**.

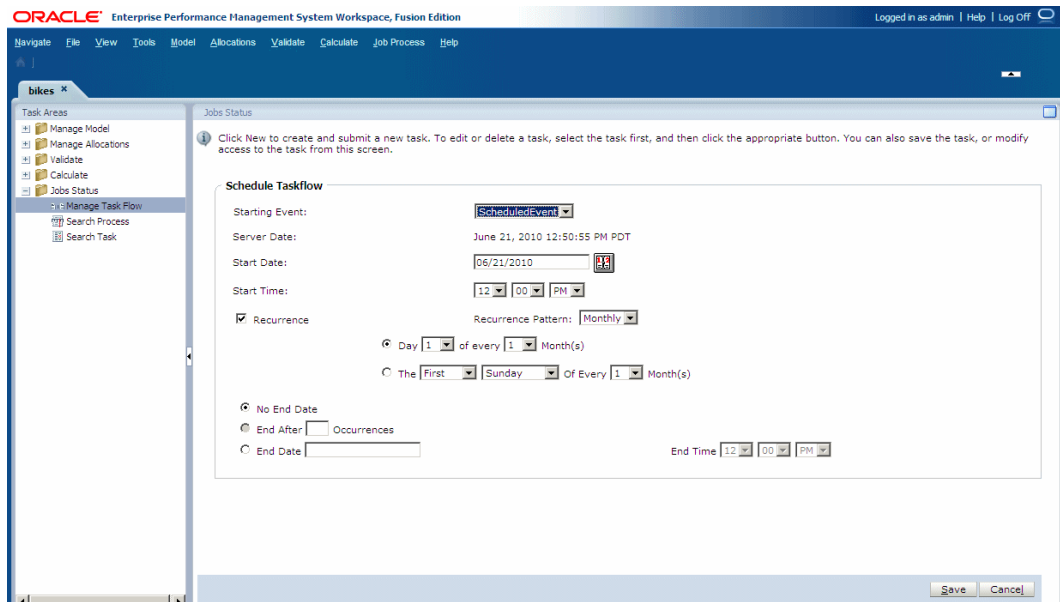

4. Under **Starting Event**, select **ScheduledEvent**.
The Server Date is displayed.

5. Under **Start Date**, click **calendar**  to select the date on which the task flow is scheduled.
6. Under **Start Time**, use the drop-down lists to select the time at which the taskflow is scheduled to begin.

You must select the hour and minutes, and whether the time is set for AM or PM.
7. **Optional:** To schedule jobs to run on a recurring basis:
 - a. Select **Recurrence**.
 - b. Under **Recurrence Pattern**, select a frequency, such as Monthly, Weekly, and so on.
 - c. Select a recurrence pattern, and enter the required variables, as indicated in the following examples:
 - Day x of every x Month(s)
 - The x *day* of Every x Month(s)
8. **Optional:** To schedule the task flow to run until it is manually cancelled or deleted, select **No End Date**.
9. **Optional:** To schedule the task flow to run a specified number of times, select **End After x Occurrences**. In the text box, enter the number of times the job is to be run.

 **Note:**

This option is available only if a Recurrence schedule of Daily or Weekly is selected.

10. **Optional:** To run the task flow until a specified date, select **End Date**, and select the date and time of the final run:
 - a. Under **End Date**, click **calendar**  to select a date.

 **Note:**

Calendar is displayed when the End Date option is selected.

- b. Under **End Time**, select the time of the last run. You must select the hour, minute and whether the time is set for AM or PM.
11. Click **Save** to save the scheduled job.

The task flow runs as scheduled.

Running Standard Profitability Reports

Related Topics

- [About Running Reports for Standard Profitability Models](#)
There are internal reports for validating the model; for example, the stage balancing screen and data entry views.
- [Essbase Outlines and Reporting](#)
The Oracle Essbase outline created for the Oracle Hyperion Profitability and Cost Management model contains separate dimensions to store the data for each stage.
- [Reporting on Stage Data](#)
You can generate reports to provide details about an individual model stage.
- [Reporting on Direct Allocations](#)
A direct allocation is an allocation for which the source and destination intersections are directly linked by an assignment.
- [Reporting on Allocation Genealogy](#)
The Allocation Genealogy report calculates the allocation detail for source and destination intersections that do not have an assignment, but which have an indirect relationship.
- [Running Standard Profitability System Reports](#)
Following calculation of a Standard Profitability model, you can run several system reports.
- [Reporting Using Smart View](#)
Oracle Smart View for Office provides a Microsoft Office interface for Oracle Essbase and other data sources.

About Running Reports for Standard Profitability Models

There are internal reports for validating the model; for example, the stage balancing screen and data entry views.

You can also run system reports following calculations. In addition to these, you can use the Manage Queries screen to build and manage Oracle Smart View for Office queries to be run against the Calculation or Reporting Cubes created by Oracle Hyperion Profitability and Cost Management. Running the queries from the query management screen launches Smart View with the query results. The details are discussed in the following sections.

You can also use other Oracle reporting tools or third-party reporting tools to report against the Oracle Essbase cubes to view calculation results:

- Oracle Hyperion Web Analysis
- Oracle Hyperion Financial Reporting
- Smart View can also be independently used to report against the Essbase cubes or launched in the context of a query from the Manage Queries screen

Using these reporting tools, you can generate the reports to view exactly the information you require. The procedures shown in this section suggest steps you need to take to build the reports, but you must use the supporting documentation for the selected reporting tool for detailed instructions on creating and running the reports.

See these sections:

- [Essbase Outlines and Reporting](#)
- [Reporting on Stage Data](#)
- [Reporting on Direct Allocations](#)
- [Reporting on Allocation Genealogy](#)
- [Reporting Using Smart View](#)

Essbase Outlines and Reporting

The Oracle Essbase outline created for the Oracle Hyperion Profitability and Cost Management model contains separate dimensions to store the data for each stage.

Although stages do not exist in the Essbase outline, they are used to organize dimensions and members within the model. When creating the stage in Profitability and Cost Management, a prefix is defined to identify the stage to which a dimension belongs, and this prefix is displayed in the outline.

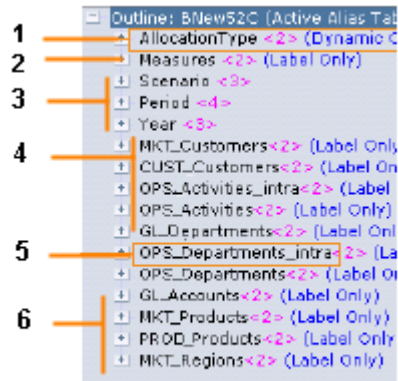

The sample Essbase outline shown in the graphic above displays some of these characteristics:

1. AllocationType identifies DirectAllocation or GenealogyAllocation data
2. Measures dimension identifies measures used in the model.
3. POV dimensions - at least one must be available.
4. Stage prefix identifies the stage to which the dimension belongs.
5. The _intra suffix identifies dimensions which are used in intrastage assignments.
6. Business dimensions from the model.

Using the dimensions in the Essbase outline, you build the report with the information and level of detail that you require. You can select the dimensions that you want to include in the report, although these dimensions are usually required:

- AllocationType dimension to specify whether the report includes DirectAllocation or GenealogyData.
- POV dimensions
- Measures dimensions

- Business dimensions
- Attribute dimensions

For stages that allow intrastage allocations, Essbase attaches a suffix "_intra" to the dimension to identify it as part of an intrastage allocation. For example, if the stage dimensions are OPS_Products and OPS_Activities, the destination data for intrastage allocations is stored in the OPS_Departments_intra and OPS_Activities_intra dimensions.

▲ Caution:

In any Essbase outline, ensure all dimensions have a unique name; otherwise, the creation of the outline will fail. For example, an attribute dimension member name cannot match a regular dimension name.

Reporting on Stage Data

You can generate reports to provide details about an individual model stage.

Example of Stage Data Report Selections

	A	B	C	D
1	Period	January	GL_Accounts	NoMember
2	Year	2008	GL_Departments	NoMember
3	Scenario	Actual	OPS_Departments_intra	NoMember
4			OPS_Activities_intra	NoMember
5	AllocationType	DirectAllocation	PRODS_Products	NoMember
6			CUST_Customers	NoMember
7			MKT_Customers	NoMember
8			MKT_Products	NoMember
9			MKT_Regions	NoMember
10				
11				
12	OPS_Departments	OPS_Activities	Measures	
13			CostReceivedPriorStage	CostInput
14	Assembly	Building		200
15	Assembly	Rework		150
16	Assembly	Testing		100

The sample report above shows the layout of dimensions used to create the stage data report:

1. AllocationType set to DirectAllocation
2. All dimensions in other stages are set to NoMember.
3. Stage dimensions

To report on Stage Data:

1. Generate and calculate the Oracle Essbase cube for the model, as outlined in [Calculating Standard Profitability Models](#).
2. From the reporting application, connect to the Essbase cube.
3. Drag and drop the dimensions into the configuration you require. For example, place source stage intersections in the rows, and destination stage intersections in the columns, or vice versa.

4. Select members from each dimension in the source stage to define the source intersections on which you want to report.
5. Select members from each dimension in the destination stage to define the destination intersections on which you want to report.
6. From the AllocationType dimension, select **DirectAllocation**.
7. Select a member from each POV dimension.
8. From the Measures dimension, select the measures on which you want to report.
9. For all other dimensions, select **NoMember**.
10. Using instructions for the reporting application, run the report.

Reporting on Direct Allocations

A direct allocation is an allocation for which the source and destination intersections are directly linked by an assignment.

Example of Direct Allocation Report Selections

	A	B	C	D	E
1	Period	January		GL_Accounts	NoMember
2	Year	2008		GL_Departments	NoMember
3	Scenario	Actual		OPS_Departments_intra	NoMember
4				OPS_Activities_intra	NoMember
5	AllocationType	DirectAllocation		CUST_Customers	NoMember
6	Measure	CostReceivedPriorStage		MKT_Customers	NoMember
7				MKT_Products	NoMember
8				MKT_Regions	NoMember
9					
10	OPS_Departments	OPS_Activity	PROD_Products		
11					
12			Bike Trailer	Standard Cruiser	LTD Cruiser
13	Assembly	Building	5000	3800	4100
14	Assembly	Testing	300	270	325
15	Assembly	Rework	800	600	480

The sample report above shows the layout of dimensions used to create the direct allocation data report:

1. AllocationType set to DirectAllocation
2. All dimensions in other stages are set to NoMember.
3. Source stage intersections
4. Destination stage intersections

To report on Direct Allocations:

1. Generate and calculate the Oracle Essbase cube for the model, as outlined in [Calculating Standard Profitability Models](#).
2. From the reporting application, connect to the Essbase cube.
3. In the Source Stage, select members from each dimension on which you want to report.
4. In the Destination Stage, select members from each dimension on which you want to report.

 **Note:**

If there is an intrastage allocation, use the dimensions with the suffix `_intra` to specify the destination intersections.

5. From the AllocationType dimension, select **DirectAllocation**.
6. Select a member from each POV dimension.
7. From the Measures dimension, select the measures on which you want to report.
8. For all other dimensions, select **NoMember**.
9. Using instructions for the reporting application, run the report.

Reporting on Allocation Genealogy

The Allocation Genealogy report calculates the allocation detail for source and destination intersections that do not have an assignment, but which have an indirect relationship.

Example of Allocation Genealogy Report Selections

	A	B	C	D
1	Period	January	OPS_Departments	NoMember
2	Year	2008	OPS_Activities	NoMember
3	Scenario	Actual	CUST_Customers	NoMember
4			OPS_Departments_intra	NoMember
5	AllocationType	IndirectAllocation	OPS_Activities_intra	NoMember
6	Measure	CostReceivedPriorStage	MKT_Customers	NoMember
7			MKT_Products	NoMember
8			MKT_Regions	NoMember
9				
10	GL_Departments	GL_Accounts	PROD_Products	
11			LTD Cruiser	STD Cruiser
12	Assembly	Personnel		200 75
13	Assembly	Personnel		150 100
14	Assembly	Personnel		200 80

The sample report above shows the layout of dimensions used to create the allocation genealogy report:

1. AllocationType set to IndirectAllocation
2. All dimensions in other stages set to NoMember
3. Start point intersections
4. End point intersections

To report on Allocation genealogy:

1. Generate and calculate the Oracle Essbase cube for the model, as outlined in [Calculating Standard Profitability Models](#).
2. From the reporting application, connect to the Essbase cube.
3. In the Source Stage, select members from each dimension in the stage that is the starting point.

4. In the Destination Stage, select members from each dimension in the stage that is the ending point.

 **Note:**

If there is an intrastage allocation, use the dimensions with the suffix `_intra` to specify the destination intersections.

5. From the AllocationType dimension, select **GenealogyAllocation**.
6. From the Measures dimension, select the measures on which you want to report.
7. Select a member from each POV dimension.
8. For all other dimensions, including dimensions for intermediate stages between the start and end point stages, select **NoMember**.
9. Using instructions for the reporting application, run the report.

Running Standard Profitability System Reports

Following calculation of a Standard Profitability model, you can run several system reports.

- **Genealogy Statistics** — Statistics including Start Time, End Time, Elapsed Time, and Number of Actual Cells, by genealogy subpath, for genealogy calculations where source and destination intersections have an indirect relationship
- **Dimension Statistics** — Number of dimension members, number of level 0 members, and number of hierarchy levels for each dimension in the current application.
- **Execution Statistics** — Runtime statistics collected for the selected Allocation Calc - Standard job following the end of the job

To generate a Standard Profitability system report:

1. In an open Standard Profitability model, in the **Reporting** task area, select **System Reports**.
2. In the **System Reports** screen, select one of the following for each setting:
 - **Report Name** — **Genealogy Statistics**, **Dimension Statistics**, **Execution Statistics**
 - **Output Type** — **PDF** (Adobe PostScript), Microsoft **EXCEL**, Microsoft **WORD**, **XML**, **HTML**
3. Enter the **Job Id** from the **Job Library** task area for **Genealogy Statistics** and **Execution Statistics** reports.

 **Note:**

Dimension Statistics reports do not require **Job Id** or other parameter information.

4. Click **Run**.

5. Indicate whether to open or save the report.

See these sections to review report examples:

- [Figure 1](#)
- [Figure 1](#)
- [Figure 1](#)

Standard Profitability Genealogy Statistics Report Example

Genealogy Statistics reports show runtime statistics for genealogy calculations, where source and destination intersections have an indirect relationship. Statistics include Start Time, End Time, Elapsed Time, and Cells Updated, listed by genealogy subpath (similar to [Figure 1](#)).

Figure A-4 Example of a Standard Profitability Genealogy Statistics Report

Main Path Name		Sub Path Name	Start Time	End Time	Elapsed Time	Cells Updated
1-4	1-3-4		04:10:04	04:12:53	00:02:48	28
1-4	1-2-4		04:10:05	04:10:49	00:00:43	456
1-4	1-2-3-4		04:10:49	04:11:30	00:00:41	892

Standard Profitability Dimension Statistics Report Example

Dimension Statistics reports show the number of dimension members, number of level 0 members, and number of hierarchy levels for each dimension in the current application. Potential values are possible mathematical combinations that might not all be used (similar to [Figure 1](#)).

Figure A-5 Example of a Standard Profitability Dimension Statistics Report

Profitability Dimension Statistics Report									
ORACLE Hyperion									
Application Name : MLVBig1									
Stage	Dimension Name	Storage Type	Dimension Type	Associated Attribute Dimensions	Total Number of Members	Number of Level0 Members	Intersections	Hierarchy Depth	Last Update
	Sys1	Sparse	Measures		65	45	45	2	03/17/2014 21:12:07
	Sys2	Sparse	Allocation		5	4	180	2	03/17/2014 21:12:07
	Pov1	Sparse	POV		6	6	1080	2	03/17/2014 21:12:07
	Pov2	Sparse	POV		12	12	12960	2	03/17/2014 21:12:07
	Pov3	Sparse	POV		3	3	38880	2	03/17/2014 21:12:07
Stage1	ST1_Accounts	Sparse	Business		100	80	80	4	03/17/2014 21:12:07
Stage1	ST1_CostCenters	Sparse	Business		400	320	25600	3	03/17/2014 21:12:07
Stage2	ST2_CostCenters	Sparse	Business		400	320	320	2	03/17/2014 21:12:07
Stage2	ST2_Activities	Sparse	Business		60	50	16000	2	03/17/2014 21:12:07
Stage2	ST2_CostCenters_intra	Sparse	Business		400	320	5120000	2	03/17/2014 21:12:07
Stage3	ST3_Customers	Sparse	Business		400	300	300	3	03/17/2014 21:12:07

Standard Profitability Execution Statistics Report Example

Execution Statistics reports show runtime statistics collected for the selected Allocation Calc - Standard job type following the end of the job (similar to [Figure 1](#)).

Figure A-6 Example of a Standard Profitability Execution Statistics Report

Profitability Execution Statistics Report									
ORACLE Hyperion									
Application : BksSP4									
Point of View : Year:Period:Scenario 2014:January:Actual									
Job Id : 9601851									
Job Type : Allocation Calc - Standard									
Job Status : Success									
Concurrent Calculation : 4									
Number of Threads									
Start Time : 07/07/2014 04:10:04									
End Time : 07/07/2014 04:12:53									
UserId : admin									
Stages Information									
Stage Name	Start Time	End Time	Elapsed Time	Explicit Assignments		Assignment Rule Selections	Total		
				Intra Stage	Inter Stage				
Stage1	04:10:04	04:12:53	00:02:48	2	1	3	7		
Stage2	04:12:05	04:14:08	00:02:08	1	2	2	5		
Stage3	04:12:05	04:14:08	00:02:08	2	2		4		

Reporting Using Smart View

Oracle Smart View for Office provides a Microsoft Office interface for Oracle Essbase and other data sources.

From Excel, Word or PowerPoint, you connect to Essbase and access Smart View functionality through the Hyperion menu that is displayed on the Office product

toolbars when Smart View is installed. You can generate reports that can be displayed as a grid, chart or scrollable table.

This procedure is designed to provide an overview of the report creation process, but you must refer to the *Oracle Smart View for Office User's Guide* for detailed procedures on setting up and using Smart View to view the results.

To report using Smart View for Office:

1. Generate and calculate the Essbase cube for the model, as outlined in [Calculating Standard Profitability Models](#)
2. Open Microsoft Excel.
3. In Smart View, select **Hyperion, Connection Manager** and connect to the Essbase database. See the *Oracle Smart View for Office User's Guide*.
4. Create the report as outlined in the *Oracle Smart View for Office User's Guide*.

Managing Smart View Queries in Standard Profitability

Oracle Smart View for Office integrations are available for Standard Profitability models only to provide help with data management, run diagnostics for allocation data, and enable analysis of both allocation and genealogy data. In addition, the Smart View integration provides context-sensitive investigation tools that can be launched from Stage Balancing.

Smart View queries provide users with quick access to views of Oracle Hyperion Profitability and Cost Management data. The queries can be defined against either the Calculation or Reporting database, and after Smart View is launched, the grid can be used for analysis. Data entry may also be performed against the Calculation database.

The Manage Queries screen enables you to select a query type, and then refine the query using a grid and a Smart View POV. The queries can be saved and reused, or cloned by other Profitability and Cost Management users. The queries can also be exported and reimported using Oracle Hyperion Enterprise Performance Management System Lifecycle Management.

The default queries offer different views, depending on the query type selected. Each of the queries enable additional selections for the selected type. For example, the Driver Measures query type prompts the user to specify the driver location (Source, Assignment, Destination) and the stage combinations in order to complete the dimension defaults that are presented on the dimension layout and member selection screen.

You can also launch some predefined Smart View integrations from the Stage Balancing screen. The launch data points are represented as hyperlinks in the Stage Balancing screen and present values that have been contributed from one stage to another. You can drill down further on input or allocation data. For example, you could drill-down into Unassigned costs after an allocation run, or to examine input data that was used in the same run.

If any dimensions or dimension members are renamed or deleted, the Smart View queries that reference those dimensions become invalid. The Smart View query validation screen validates all queries, and displays an error message for any invalid queries.

Smart View queries in Standard applications fail with validation errors when they reference dimension members containing '&' characters in the member name.

Only users provisioned as Admin or Power users may create, edit, copy, or delete queries. Admin, Power and Interactive users may all launch queries from the application.

Creating Custom Queries

You can create custom queries in Oracle Hyperion Profitability and Cost Management.

To create queries:

1. Before creating the query, ensure the following products are installed, configured and running:
 - Oracle Hyperion Provider Services
 - Oracle Hyperion Shared Services
 - Oracle Essbase
 - Microsoft Excel is installed with Oracle Smart View for Office on the client machine
2. From the Task Area, select **Reporting**, and then **Manage Queries**.

The **Manage Queries** screen is displayed, showing all existing queries for all applications for which the user is provisioned as an Admin or Power user.

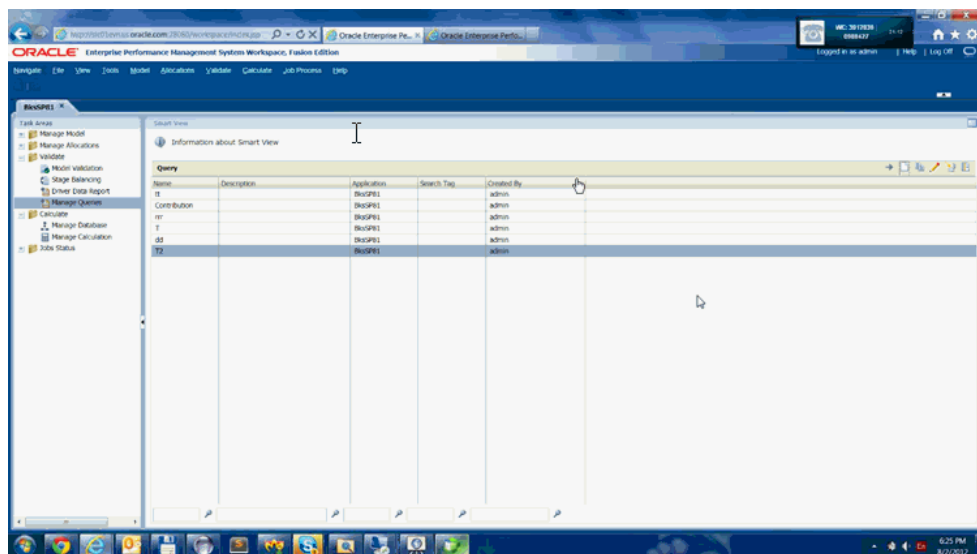

3. Click **Add**  to open the Query wizard.

4. In **Step 1: Query Options**, enter the following information for the new query:
 - **Name** for the query
 - **Optional: Description** of the query
 - Select the **Application** to be used for the query from the drop-down list
 - Select the **Database** to be used for the query from the drop-down list:
 - **Calculation** (BSO)
 - **Reporting** (ASO)
 - **Optional:** Enter a descriptive **Search Tag** to be used to sort queries in the main Smart View Query screen.
5. Under **Type**, select the type of query to be created:
 - **Driver Measures**
 - **Stage Measures**
 - **Contribution**
 - **Custom**

Depending on the Type that is selected, the additional query options change to reflect the choice. See [Table 1](#).

6. Select the **Query Options** based on the selected Type:

Table A-12 Query Type Options

Query Type Selected	Type	Query Options
Driver Measures	Assignment	Select the Source and Destination stages.
Driver Measures	Source	Select the Source stage.
Driver Measures	Destination	Select the Destination stage.
Driver Measures	Global	N/A
Stage Measures		Select the Stage to be used for the query.
Contribution	Direct Allocation	Select the Source and Destination Stages.
Contribution	Genealogy	Select the Contribution Path (for example, 1-3-5).
Custom		Select as required. No default is expected.

7. **Optional:** Under **Smart View Options**, select **Suppress #Missing** to set the data suppression option for the first query in Smart View, if required.
 - If you select **Suppress #Missing**, the Smart View option is only set for the first query run, not all queries. To set the option for subsequent drills into the data, set the option manually in Smart View.
 - Selecting **Suppress #Missing** in a Query definition returns the error "Cannot perform cube view operation.null" when you run the query. If you deselect this option, the query runs, and you will see data along with missing data rows.
8. **Optional:** Under **Smart View Options**, select **Use Dimension Aliases** to display any assigned aliases for all dimensions in the query.
9. Click **Next**.
Step 2 - Dimension Layout is displayed.

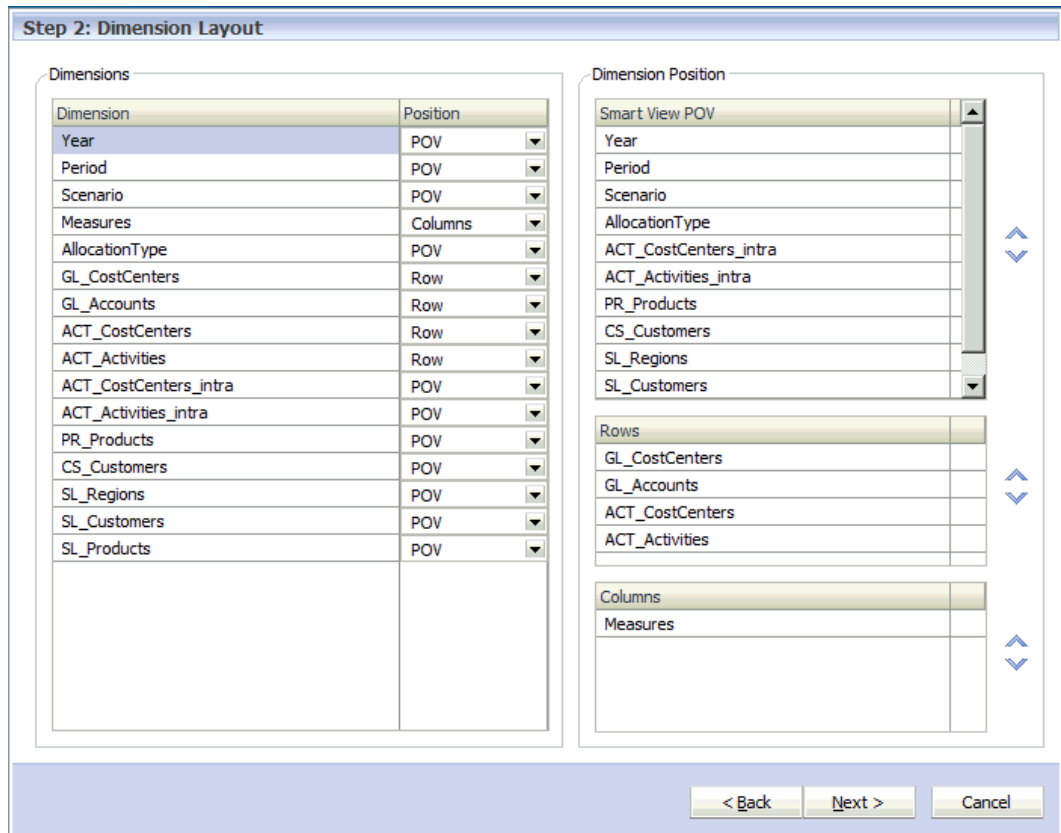

10. Under **Dimensions**, for each **Dimension**, select the **Position** for the placement of the dimension under the Dimension Position column on the screen using the drop-down list:

- **POV**
- **Rows**
- **Columns**

By default, all dimensions in the application outline are displayed, and selections are set to defaults that are appropriate for the type of query you are creating.

For example, if you select stage measures for a specific stage, the dimensions for that stage display in the Rows section, and the top member of the first hierarchy is pre-selected for each of the stage dimensions. The other stage dimensions are placed in the Smart View POV section, and the "NoMember" member from each stage is selected.

11. **Optional:** Under **Dimension Position**, in the **Smart View POV** section, use the Up and Down arrows to change the position of a highlighted dimension in the query.
12. **Optional:** Under **Dimension Position**, in the **Rows** section, use the Up and Down arrows to change the position of a highlighted dimension in the query.
13. **Optional:** Under **Dimension Position**, in the **Columns** section, use the Up and Down arrows to change the position of a highlighted dimension in the query.
14. Click **Next**.

Step 3 - Member Selections is displayed. All dimensions from the Smart View POV, Rows and Columns are displayed in the order defined on the Dimension Layout screen. Use the arrows to scroll up or down through the list.

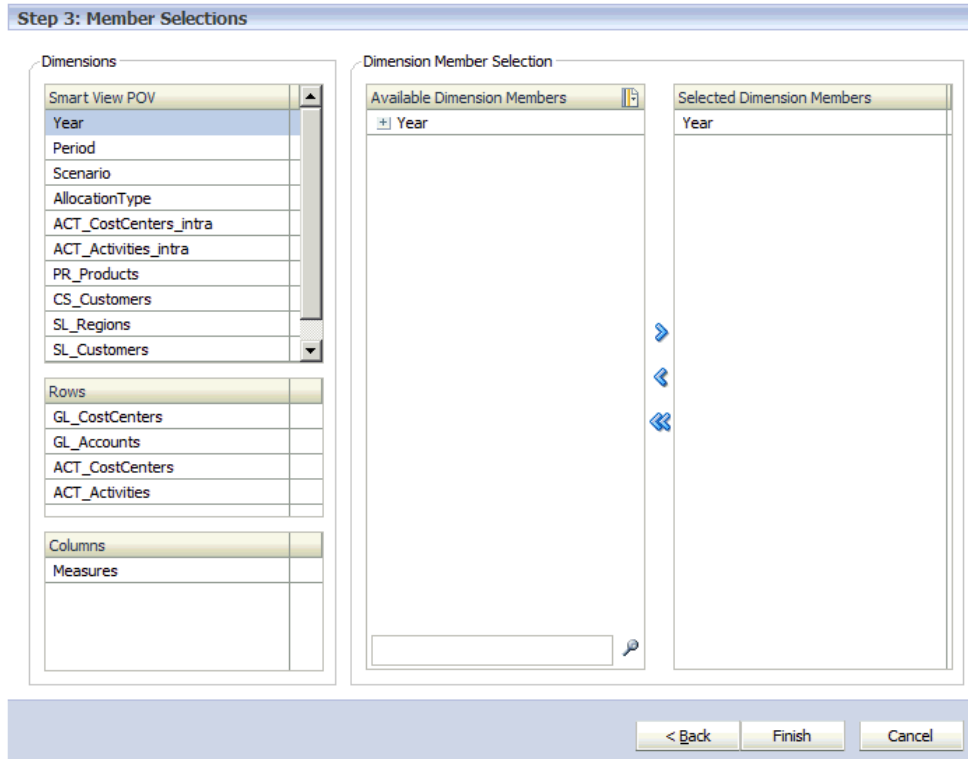

- Under **Dimension Member Selections**, use the Add arrow  to move the dimension members to be included in the query to the **Selected Dimension Members** column.

The list displays all dimension members, including alternate hierarchies and the NoMember member. Because there are no restrictions on level, alternate hierarchy, shared or base member, any member may be selected.

Use the Ctrl key to select multiple dimensions, or the Shift key to select the first and last members in a range.

- Click **Finish**.

The new query is added to the Manage Queries screen.

 **Note:**

Before running the query, the database must be deployed. Although the database does not need to be calculated before running the query, results will be missing if it is not.

Editing Custom Queries

You can edit custom queries.

To edit queries:

- From the Task Area, select **Reporting**, and then **Manage Queries**.

The **Manage Queries** screen is displayed, showing all existing queries for all applications for which the user is provisioned as an Admin, Power.

2. Click the Edit Query button  to open the query wizard.

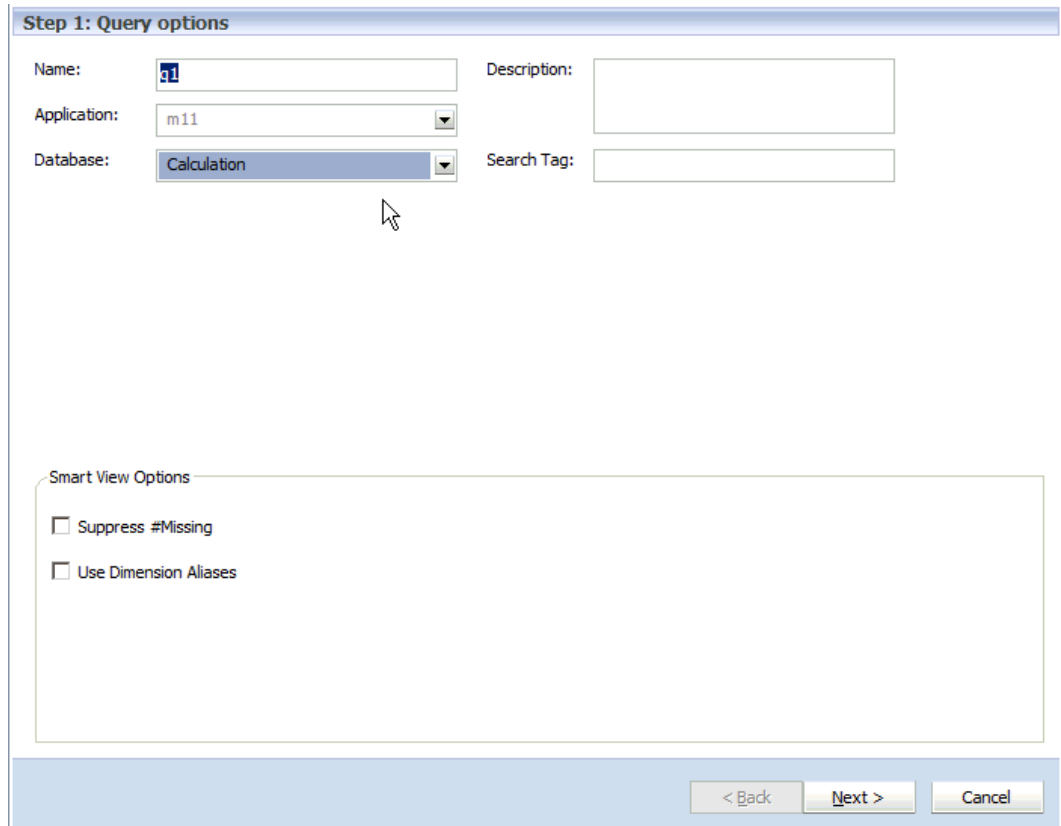

Step 1: Query options

Name:

Description:

Application:

Database:

Search Tag:

Smart View Options

Suppress #Missing

Use Dimension Aliases

< Back Next > Cancel

3. On **Step 1: Query Options**, modify any of the following fields to modify the query:
 - **Name** for the query
 - **Optional: Description** of the query
 - Select another **Database** to be used for the query from the drop-down list:
 - **Calculation** (BSO)
 - **Reporting** (ASO)
 - **Optional:** Enter a descriptive **Search Tag** to be used to sort queries in the main Smart View Query screen.

 **Note:**

You cannot modify the Query Type or Query Options. To change the Type, create a new query.

4. **Optional:** Under **Smart View Options**, select **Suppress #Missing** to set the data suppression option for the first query in Oracle Smart View for Office, if required.

- If you select **Suppress #Missing**, the Smart View option is only set for the first query run, not all queries. To set the option for subsequent drills into the data, set the option manually in Smart View.
 - Selecting **Suppress #Missing** in a Query definition returns the error "Cannot perform cube view operation.null" when you run the query. If you deselect this option, the query runs, and you will see data along with missing data rows.
5. **Optional:** Under **Smart View Options**, select **Use Dimension Aliases** to display any assigned aliases for all dimensions in the query, if required.
 6. Click **Next**.

Step 2 - Dimension Layout screen is displayed.

Dimension	Position
Year	POV
Period	POV
Scenario	POV
Measures	Columns
AllocationType	POV
GL_CostCenters	Row
GL_Accounts	Row
ACT_CostCenters	Row
ACT_Activities	Row
ACT_CostCenters_intra	POV
ACT_Activities_intra	POV
PR_Products	POV
CS_Customers	POV
SL_Regions	POV
SL_Customers	POV
SL_Products	POV

Smart View POV
Year
Period
Scenario
AllocationType
ACT_CostCenters_intra
ACT_Activities_intra
PR_Products
CS_Customers
SL_Regions
SL_Customers

Rows
GL_CostCenters
GL_Accounts
ACT_CostCenters
ACT_Activities

Columns
Measures

7. Under **Dimensions**, for each **Dimension**, select the **Position** for the placement of the dimension under the Dimension Position column on the screen using the drop-down list:

- **Smart View POV**
- **Rows**
- **Columns**

By default, all dimensions in the application outline are displayed, and selections are set to defaults that are appropriate for the type of query you are creating.

For example, if you select stage measures for a specific stage, the dimensions for that stage display in the Rows section, and the top member of the first hierarchy is pre-selected for each of the stage dimensions. The other stage dimensions are placed in the Smart View POV section, and the "NoMember" member from each stage is selected.

8. **Optional:** Under **Dimension Position**, in the **Smart View POV** section, use the Up and Down arrows to fine tune the position of a highlighted dimension in the query.
9. **Optional:** Under **Dimension Position**, in the **Rows** section, use the Up and Down arrows to fine tune the position of a highlighted dimension in the query.
10. **Optional:** Under **Dimension Position**, in the **Columns** section, use the Up and Down arrows to fine tune the position of a highlighted dimension in the query.
11. Click **Next**.

Step 3 - Member Selections is displayed. All dimensions from the Smart View POV, Rows and Columns are displayed in the order defined on the Dimension Layout screen. Use the arrows to scroll up or down through the list.

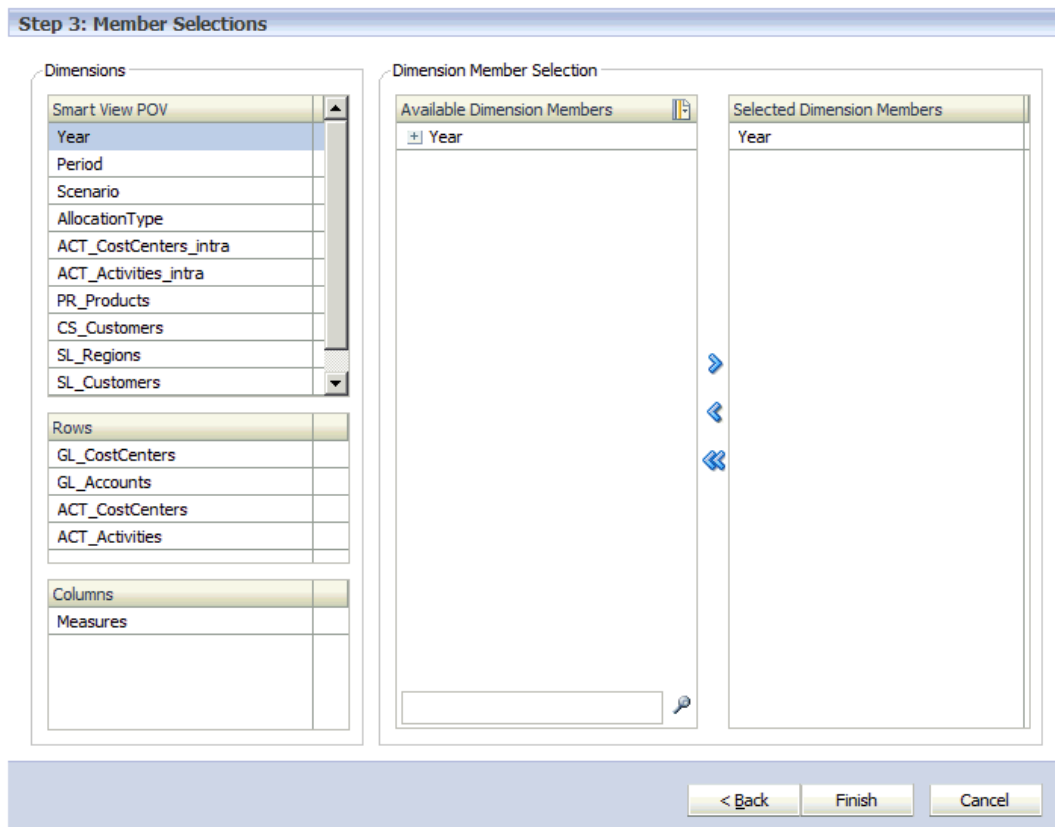

12. Under **Dimension Member Selections**, use the Add arrow  to move the dimension members to be included in the query to the **Selected Dimension Members** column.

The list displays all dimension members, including alternate hierarchies and the NoMember member. Because there are no restrictions on level, alternate hierarchy, shared or base member, any member may be selected.

Use the Ctrl key to select multiple dimensions, or the Shift key to select the first and last members in a range.

13. Click **Finish**.

The modified query is saved and available on the Manage Queries screen.

Duplicating Smart View Queries

You can duplicate Oracle Smart View for Office queries.

To duplicate Smart View queries:

1. From the Task Area, select **Reporting**, and then **Manage Queries**.

The **Manage Queries** screen is displayed, showing all existing queries for all applications for which the user is provisioned as an Admin or Power user.

2. Click the Duplicate Query button .

The Create Duplicate Smart View Query dialog box is displayed.

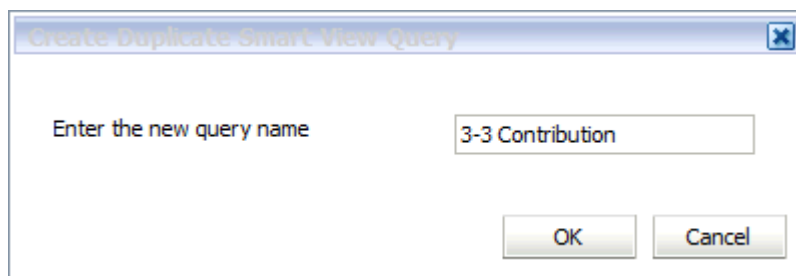

3. Enter a name for the new query, and then click **OK**.

The new query is saved and added to the list on the Manage Queries screen.

Deleting Custom Smart View Queries

You can delete custom Oracle Smart View for Office queries.

To delete Smart View queries:

1. Ensure no other users require this query.
2. From the Task Area, select **Reporting**, and then **Manage Queries**.

The **Manage Queries** screen is displayed, showing all existing queries for all applications for which the user is provisioned as an Admin or Power user.

3. From the Queries List, select the query to be deleted, and click the Delete button



A confirmation message is displayed to confirm that you do want to delete the selected query.

4. Click **Yes**.

The selected query is removed from the Manage Queries screen.

Running Queries from the Stage Balancing Screen

You can launch some predefined query integrations from the Stage Balancing screen.

The launch data points are represented as hyperlinks in the stage balancing screen. The hyperlinks in the columns represent values that have been contributed from one stage to another.

Click the hyperlinks to immediately access an analysis capability to analyze the calculations and determine whether areas may need to be repaired, and to explore details of any discrepancies or missing information.

Data displayed in the query always opens the Reporting database.

To access queries through the Stage Balancing screen:

1. From Oracle Hyperion Enterprise Performance Management Workspace, select **Navigate**, then **Applications**, then **Profitability**, and then select the application for which queries have been created.

2. Deploy the database before running the query.

It is not necessary to calculate the database before running the query; however, you should be aware that some results will be missing.

3. In an open model, from *Task Areas*, select **Validate**, and then **Stage Balancing**.

The Stage Balancing screen is displayed.

4. Select a POV and Layer, and then click the Launch button 

The Stage Balancing report for the selected POV is displayed, with highlighted active links. By default, the following hyperlinks are available:

- Direct Input
- Idle
- Overdriven
- Unassigned Columns

Additional columns may also contain hyperlinks. The hyperlinks in the columns represent values that have been contributed from one stage to another. If there is no contribution from one stage to another, the intersection is empty.

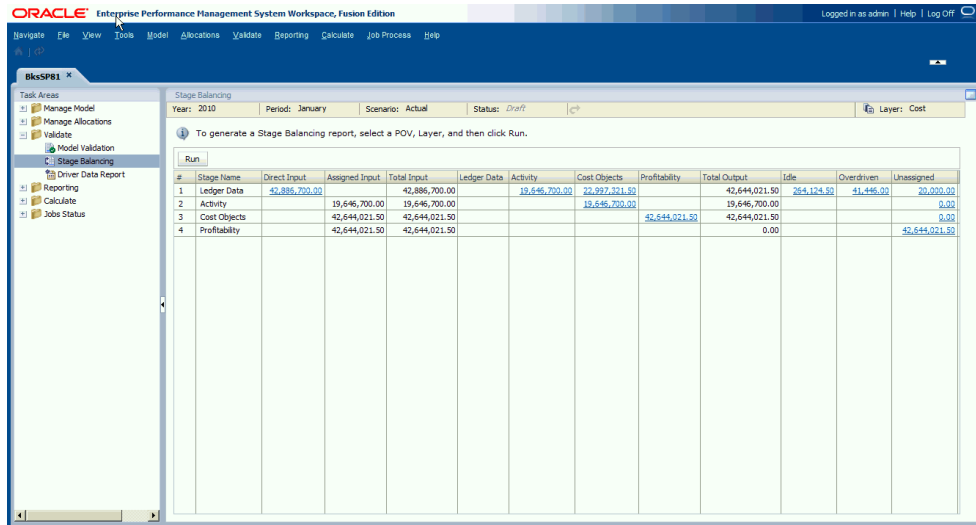

5. Click any hyperlink to view the results for that intersection in Oracle Essbase for the currently selected POV.

The results display the total for the default hyperlink (for example, CostReceivedPriorStage) for all intersections of the selected members. Because the results are from the Reporting databases, all values are automatically aggregated.

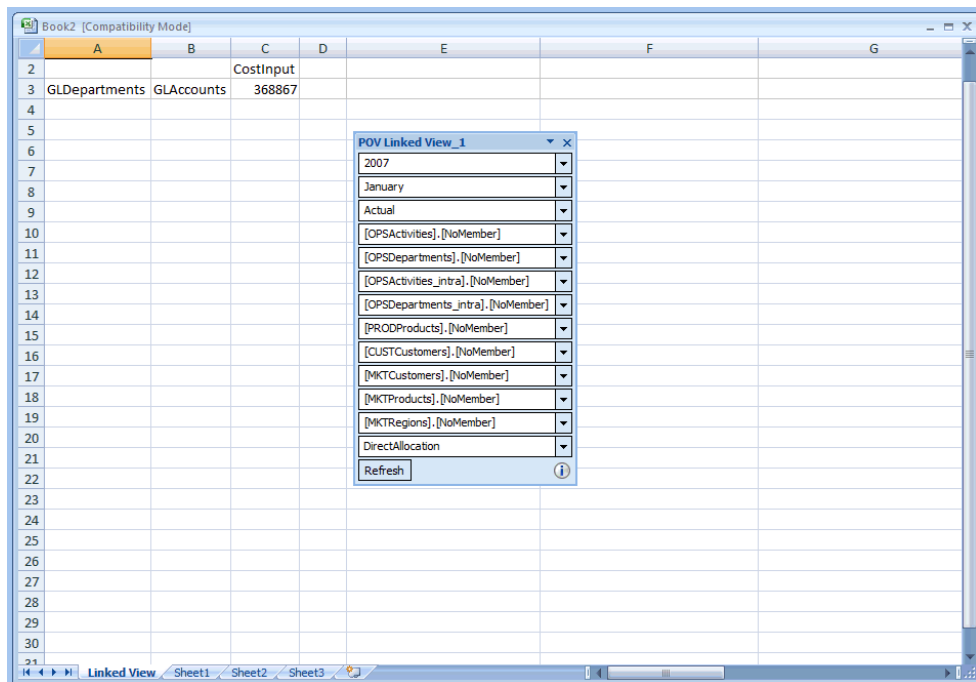

6. **Optional:** To modify the current POV, on the **POV_Linked_View** pane, click the down arrow beside any dimension listed for the current POV, and click the ellipsis (...) to open a Member Selector. Select any members that you want to change, and then click **Refresh** to activate the POV change.
7. Review the results of the query.

- Optional:** To view a specific intersection, use the Zoom commands on the Essbase tab to drill down or back up to a specific intersection.

 **Note:**

When invoking Oracle Smart View for Office from Manage Queries, you may encounter errors such as: "connection refused" and "Web launch operation cancelled". Oracle recommends the Full SSL Deployment of Oracle Enterprise Performance Management System as described by the *Oracle Enterprise Performance Management System Security Configuration Guide* to support invoking Managed Queries from Management Ledger with SSL. If you terminate SSL at the OHS server, then additional configuration may be required within the OHS configuration files.