

Core Services
Oracle FLEXCUBE Universal Banking
Release 11.80.02.0.0 CN Cluster
Oracle Part Number E64368-01
[January] [2016]



Table of Contents

1. ABOUT THIS MANUAL.....	1-1
1.1 INTRODUCTION.....	1-1
1.1.1 Audience	1-1
1.1.2 Organization.....	1-1
1.1.3 Related Documents	1-3
1.1.4 Glossary of Icons	1-3
2. BANK PARAMETERS.....	2-1
2.1 DEFINING BANK LEVEL PARAMETERS.....	2-1
2.1.2 Maintaining Financial Preferences.....	2-2
2.1.3 Generating Automatic Balancing Entries.....	2-4
2.1.4 Maintaining General Preferences.....	2-5
2.1.5 Placing User Restrictions on Data Entry Batches.....	2-8
2.1.6 Specifying UDF Details.....	2-11
2.1.7 Specifying Account Generation Parameters at Bank Level	2-12
2.1.8 Defining Bank-wide Preferences	2-19
3. DEALER MAINTENANCE	3-1
3.1 DEFINING DEALER.....	3-1
4. BRANCH PARAMETERS	4-1
4.1 CREATING BRANCHES	4-1
4.1.1 System Features	4-1
4.1.2 Creating Reporting Structure	4-2
4.1.3 Basic Parameters for Branch.....	4-3
4.1.4 Maintaining General Details for Branch.....	4-4
4.1.5 Maintaining Financial Details for Branch	4-8
4.1.6 Specifying Suspense GL.....	4-8
4.1.7 Maintaining SWIFT Address for Branch	4-12
4.1.8 Defining Account Mask.....	4-13
4.1.9 Maintaining Customer Number Range	4-14
4.1.10 Maintaining Global Interdict Functions.....	4-16
4.1.11 Maintaining Preferences.....	4-17
4.1.12 Maintaining LCY Message Preference for Branch.....	4-24
4.2 MAINTAINING VALUE DATE SPREAD FOR BRANCH.....	4-25
4.3 MAINTAINING TAX CYCLE	4-26
4.3.1 Updating Tax Cycle	4-27
4.3.2 Maintaining Tax.....	4-27
4.3.3 Maintaining Clearing Currencies.....	4-28
4.3.4 Account Statement Handoff.....	4-29
4.3.5 Account Statement Generation	4-29
4.4 MAINTAINING ROLE TO HEAD MAPPING AT BRANCH LEVEL	4-31
4.4.1 Viewing Accounting Role to Head Mapping Details	4-33
5. SYSTEM DATES MAINTENANCE	5-1
5.1 INTRODUCTION.....	5-1
5.1.1 Maintaining Dates Change.....	5-2
6. ACCOUNTS FOR INTER-BRANCH TRANSACTIONS.....	6-1
6.1 DEFINING ACCOUNTS FOR INTER-BRANCH TRANSACTIONS	6-1
6.1.1 System Features	6-2
6.1.2 Specifying Customer Accounts.....	6-4

7.	CURRENCY MAINTENANCE.....	7-1
7.1	INTRODUCTION.....	7-1
7.2	MAINTAINING CURRENCY DETAILS.....	7-1
7.2.2	<i>Specifying Exchange Rate Limits.....</i>	7-9
7.2.3	<i>Mapping Currency to Country.....</i>	7-10
7.2.4	<i>Specifying User Defined Fields</i>	7-10
7.2.5	<i>Annexure.....</i>	7-11
7.2.6	<i>Specifying Currency Cut-Off Parameters.....</i>	7-15
7.3	HANDLING EURO.....	7-16
7.4	MAINTAINING EURO RELATED INFORMATION.....	7-16
7.4.1	<i>Maintaining Currency Details</i>	7-16
7.4.2	<i>Maintaining Conversion GLs.....</i>	7-19
7.4.3	<i>Implications of Currency Redenomination</i>	7-20
7.4.4	<i>Specifying Preferred ERI Currency for Counterparty</i>	7-23
7.4.5	<i>Specifying Settlement Message Details.....</i>	7-23
7.4.6	<i>Settlements of Foreign Exchange Deals</i>	7-24
7.4.7	<i>Reports and Advices.....</i>	7-25
7.4.8	<i>Maintaining Transaction Limits</i>	7-25
7.5	MAINTAINING SEQUENCE GENERATION FORMAT.....	7-28
8.	MAINTAINING CURRENCY DENOMINATION	8-1
8.1	INTRODUCTION.....	8-1
8.2	MAINTAINING CURRENCY DENOMINATION DETAILS	8-1
9.	EXPRESSING AMOUNTS IN WORDS.....	9-1
9.1	INTRODUCTION.....	9-1
10.	DEFINING CURRENCY PAIRS.....	10-1
10.1	INTRODUCTION.....	10-1
10.2	SYSTEM FEATURES.....	10-1
10.3	MAINTAINING PARAMETERS FOR CURRENCY PAIR	10-2
10.3.1	<i>Specifying Points Multiplier</i>	10-5
11.	MAINTAINING EXCHANGE RATES	11-1
11.1	INTRODUCTION.....	11-1
11.1.1	<i>Authorizing Exchange Rates.....</i>	11-4
11.1.2	<i>Revising Exchange Rates.....</i>	11-4
11.1.3	<i>Viewing Exchange Rates.....</i>	11-4
11.1.4	<i>Specifying Limits for Cross Currency Transactions</i>	11-5
12.	MAINTAINING CURRENCY SPREAD FOR CUSTOMER.....	12-1
12.1	MAINTAINING CUSTOMER SPREAD DETAILS	12-1
12.1.2	<i>Computing Buy and Sell Spreads.....</i>	12-2
12.1.3	<i>Maintaining Currency Margins for Customer</i>	12-3
13.	DEFINING CURRENCY RATE TYPES.....	13-1
13.1	INTRODUCTION.....	13-1
14.	MAINTAINING FLOATING RATES	14-1
14.1	FLOATING RATES	14-1
15.	PERIOD CODE MAINTENANCE.....	15-1
15.1	INTRODUCTION.....	15-1
15.2	INVOKING PERIOD CODE MAINTENANCE SCREEN	15-1
15.3	SYSTEM FUNCTIONS	15-3
16.	STATUS CODE MAINTENANCE.....	16-1
16.1	INTRODUCTION.....	16-1

16.2	INVOKING STATUS MAINTENANCE SCREEN.....	16-1
16.2.1	<i>Maintaining Status Codes for Contracts.....</i>	<i>16-2</i>
17.	TRANSACTION CODE MAINTENANCE.....	17-1
17.1	INTRODUCTION.....	17-1
17.2	INVOKING TRANSACTION CODE SCREEN.....	17-1
17.2.1	<i>Maintaining Transaction Details.....</i>	<i>17-2</i>
17.2.2	<i>Maintaining Country Name Details.....</i>	<i>17-8</i>
18.	ACCOUNT REVALUATION MAINTENANCE.....	18-1
18.1	INTRODUCTION.....	18-1
19.	MAINTAINING BRANCH HOLIDAYS.....	19-1
19.1	INTRODUCTION.....	19-1
19.2	INVOKING LOCAL HOLIDAY SCREEN.....	19-1
19.2.1	<i>Steps to Define Yearly Holidays.....</i>	<i>19-2</i>
19.2.2	<i>Defining Holidays.....</i>	<i>19-2</i>
19.2.3	<i>Annual Holidays.....</i>	<i>19-3</i>
19.2.4	<i>Designating Unexpected Holidays for Branch.....</i>	<i>19-3</i>
20.	MAINTAINING CURRENCY HOLIDAYS.....	20-1
20.1	INTRODUCTION.....	20-1
20.2	INVOKING CURRENCY HOLIDAY SCREEN.....	20-1
20.2.1	<i>Steps to Define Currency Holidays.....</i>	<i>20-2</i>
20.2.2	<i>Defining Currency Holidays.....</i>	<i>20-2</i>
20.3	UPLOADING HOLIDAY FILE.....	20-3
21.	MAINTAINING CLEARING HOLIDAYS.....	21-1
21.1	INTRODUCTION.....	21-1
21.1.1	<i>Steps to Define Clearing House Holidays.....</i>	<i>21-1</i>
21.1.2	<i>Defining Clearing House Holidays.....</i>	<i>21-2</i>
21.1.3	<i>Designating Unexpected Holidays for Clearing House.....</i>	<i>21-2</i>
22.	MAINTAINING RETAIL AND CORPORATE HOLIDAYS.....	22-1
22.1	INTRODUCTION.....	22-1
23.	MAINTAINING BUSINESS DETAILS.....	23-1
23.1	INTRODUCTION.....	23-1
23.2	MAINTAINING KYC DOCUMENT TYPES.....	23-2
23.3	MAINTAINING CUSTOMER SECTORS.....	23-4
24.	CONFIGURING OVERRIDES.....	24-1
24.1	INTRODUCTION.....	24-1
24.1.1	<i>Types of Overrides.....</i>	<i>24-1</i>
24.1.2	<i>Specifying Override Type.....</i>	<i>24-2</i>
25.	PURGING DATA.....	25-1
25.1	INTRODUCTION.....	25-1
25.2	MAINTAINING PURGE DETAILS.....	25-2
26.	TANKING OF MAINTENANCE RECORDS.....	26-1
26.1	INTRODUCTION.....	26-1
26.2	TANKING NEW AND MODIFIED MAINTENANCE RECORDS.....	26-1
26.2.1	<i>Tanking New Records.....</i>	<i>26-2</i>
26.2.2	<i>Tanking Modified Records.....</i>	<i>26-2</i>
26.2.3	<i>Closing a Record.....</i>	<i>26-2</i>
26.2.4	<i>Re-opening a Record.....</i>	<i>26-2</i>
26.2.5	<i>Authorizing a Record.....</i>	<i>26-2</i>
26.2.6	<i>Deleting a Record.....</i>	<i>26-2</i>

26.2.7	<i>Viewing Summary of Records</i>	26-2
26.2.8	<i>Modifying Tanking Preferences</i>	26-3
27.	REPRINTING VOUCHERS	27-1
27.1	VIEWING VOUCHER REPRINT DETAILS.....	27-3
28.	ANNEXURE - B - FILE FORMATS	28-1
28.1	INTRODUCTION.....	28-1
28.2	UPLOAD FILE FORMATS	28-1
29.	ANTI-MONEY LAUNDERING REPORTING	29-1
29.1	GUARDING AGAINST MONEY LAUNDERING	29-1
29.1.1	<i>Creating Product Categories in Oracle FLEXCUBE</i>	29-1
29.2	MAINTAINING LIMIT CODES	29-3
29.3	MAINTAINING ANTI MONEY LAUNDERING CUSTOMER GROUPS	29-4
29.4	MONITORING AML ACCOUNTING	29-6
30.	REPORTS	30-1
30.1	INTRODUCTION.....	30-1
30.2	LIST OF DELETED TRANSACTIONS	30-1
30.2.1	<i>Contents of Report</i>	30-3
30.3	ACCOUNTING JOURNAL.....	30-4
30.3.1	<i>Contents of Report</i>	30-5
30.4	CASH FLOW REPORT	30-6
30.4.1	<i>Contents of Report</i>	30-8
30.4.2	<i>Cash Flow (Summary) Report</i>	30-8
30.5	FUTURE DATED ACCOUNT BALANCE REPORT.....	30-9
30.6	CURRENT RATES REPORT.....	30-10
30.6.1	<i>Contents of Report</i>	30-11
30.7	RATE HISTORY REPORT.....	30-11
30.8	ACCOUNT OPENING CONFIRMATION	30-12
30.8.1	<i>Contents of the Report</i>	30-13
30.9	ACCOUNT CLOSING CONFIRMATION	30-13
30.9.1	<i>Contents of Report</i>	30-14
30.10	ACTIVITY JOURNAL REPORT	30-14
30.10.1	<i>Contents of Report</i>	30-14
30.11	CORE EXCEPTION REPORT.....	30-15
30.11.1	<i>Contents of Report</i>	30-16
30.12	UNCOLLECTED FUNDS REPORT	30-16
30.12.1	<i>Contents of Report</i>	30-17
30.13	REVALUATION REPORT	30-18
30.13.1	<i>Contents of Report</i>	30-18
30.14	ACCOUNTS MOVEMENT REPORT	30-19
30.14.1	<i>Contents of Report</i>	30-20
30.15	CUSTOMER DETAILS REPORT	30-20
30.15.1	<i>Contents of Report</i>	30-21
30.16	CUSTOMER ACCOUNTS REPORT	30-22
30.16.1	<i>Contents of Report</i>	30-23

1. About this Manual

1.1 Introduction

This manual is designed to help you quickly get acquainted with the Core Services module of Oracle FLEXCUBE.

It provides an overview to the module, and provides information on using the Core Services module of Oracle FLEXCUBE.

Besides this User Manual, you can find answers to specific features and procedures in the Online Help, which can be invoked, by choosing 'Help Contents' from the Help Menu of the software. You can further obtain information specific to a particular field by placing the cursor on the relevant field and striking <F1> on the keyboard.

1.1.1 Audience

This manual is intended for the following User/User Roles:

Role	Function
Back office clerk	Input functions for contracts
Back office managers/officers	Authorization functions
Product Managers	Product definition and authorization
End of day operators	Processing during end of day/ beginning of day
Financial Controller/Product Managers	Generation of reports

1.1.2 Organization

The manual is organized in the following manner:

Chapter 1	<i>About this Manual</i> gives a brief introduction of the module, the audience it addresses and the organization of the various chapters. It also includes the list of related documents to be referred, if any, and the conventions used in the document
Chapter 2	<i>Bank Parameters</i> explains the maintenance of various basic details about your bank
Chapter 3	<i>Dealer Maintenance</i> explains how you can capture profiles of dealers involved in buying and selling of foreign exchange
Chapter 4	<i>Branch Parameters</i> explains the process of creating and maintaining branches of your bank, with all necessary details

Chapter 5	<i>System Dates Maintenance</i> explains how you can maintain system dates for the branches of your bank
Chapter 6	<i>Accounts for Inter-Branch Transactions</i> explains how you can maintain internal accounts for branches involved in inter-branch transactions
Chapter 7	<i>Currency Maintenance</i> explains the process of maintaining currencies in the system, with all necessary static attributes
Chapter 8	<i>Maintaining Currency Denomination</i> explains the maintenance of standard currency denominations for each currency
Chapter 9	<i>Expressing Amounts in Words</i> describes the details of maintaining amounts in words
Chapter 10	<i>Defining Currency Pairs</i> explains the maintenance of static attributes for currency pairs for which exchange rate quotes are available
Chapter 11	<i>Maintaining Exchange Rates</i> explains the maintenance of exchange rates used to buy and sell currencies one for another
Chapter 12	<i>Maintaining Currency Spread for a Customer</i> explains the maintenance of currency spread and margin details for a customer
Chapter 13	<i>Defining Currency Rate Types</i> explains the maintenance of different types of currency rates applicable to the different transaction categories in your bank.
Chapter 14	<i>Maintaining Floating Rates</i> explains the maintenance of floating rates for a currency.
Chapter 15	<i>Period Code Maintenance</i> explains the maintenance of financial periods into which each financial cycle is to be divided.
Chapter 16	<i>Status Code Maintenance</i> explains the maintenance of codes that you can assign to the different statuses that a contract or a customer account can attain.
Chapter 17	<i>Transaction Code Maintenance</i> explains the maintenance of codes that you can use to represent different types of transactions.
Chapter 18	<i>Account Revaluation Maintenance</i> explains the maintenance of parameters for account revaluation.
Chapter 19	<i>Maintaining Branch Holidays</i> explains the maintenance of the holiday calendar for the different branches of your bank.
Chapter 20	<i>Maintaining Currency Holidays</i> explains the maintenance of the holiday calendar for the different currencies in which your bank transacts.
Chapter 21	<i>Maintaining Clearing Holidays</i> explains the maintenance of the holiday calendar for the different clearinghouses with which your bank transacts.
Chapter 22	<i>Maintaining Retail and Corporate Holidays</i> explains the maintenance of the

	holiday calendar for the different types of customers.
Chapter 23	<i>Maintaining Business Details</i> explains how you can maintain details of your customer's business, the associated risk classification and applicable Know Your Customer (KYC) review period.
Chapter 24	<i>Configuring Overrides</i> details on configuring overrides of the system.
Chapter 25	<i>Purging Data</i> explains the details of purging data.
Chapter 26	<i>Tanking of Maintenance Records</i> explains the process of tanking maintenance records.
Chapter 27	<i>Reprinting Vouchers</i> explains how to reprint vouchers for authorized transactions.
Chapter 28	<i>Annexure B – File Formats</i> contains a list of file formats
Chapter 29	<i>Anti-Money Laundering Reporting</i> explains the process of guarding against money laundering, a facility provided by Oracle FLEXCUBE.
Chapter 30	<i>Reports</i> explains the procedure of generating Reports.







Conventions Used in this Manual













Important information is preceded with the  symbol.

1.1.3 Related Documents

- The Procedures User Manual
- The Settlements User Manual

1.1.4 Glossary of Icons

Icons	Function
	New
	Copy
	Save
	Delete
	Unlock
	Print

Icons	Function
	Close
	Re-open
	Reverse
	Template
	Roll-over
	Hold
	Authorize
	Liquidate
	Exit
	Sign-off
	Help
	Add
	Delete

2. Bank Parameters

2.1 Defining Bank Level Parameters

In the 'Bank Wide Parameters' screen, you maintain basic information about your bank such as its name, head office, account number structure, local currency and so on.

The details that you maintain in this screen will be made applicable to all branches of your bank. For instance, the account number structure that you define in this screen will be a common format for customer accounts in all branches of your bank.

Invoke the 'Bank Parameters' screen by typing 'STDBANKP' in the field at the top right corner of the Application tool bar and clicking the adjoining arrow button.

Bank Parameters Maintenance -- Webpage Dialog

Bank Code * _____ Name _____

Description _____

Financial Preferences | General Preferences

Bank Default Currency Codes

Local * _____ Description _____

Discount * _____ Description _____

Head Office * _____ Description _____

Reporting * _____ Description _____

Head Office Branch

Code * _____

Control Accounts For Real Entries

Currency Mismatch Control Account _____

Value Date Mismatch Control Account _____

Control Accounts for Contingent Entries

Currency Mismatch Control Account _____

Value Date Mismatch Control Account _____

Auto Generate Currency Mismatch Entries

Auto Generate Value Date Mismatch Entries

R.O.Level Uniqueness

Fields | Account Mask | Preferences

Input By _____ Date Time _____ Modification Number _____ Authorized

Authorized By _____ Date Time _____ Open Exit

You can maintain the following details in this screen:

Bank Code

In Oracle FLEXCUBE a bank is identified by a unique four-character code. You can follow your own convention in devising this code. In all inter-bank transactions this code identifies your bank.

Name

You can also specify the detailed name of the bank. This name will always be displayed whenever the bank code is used.

2.1.1.1 Specifying Details of Head Office Branch

After specifying a code to identify your bank, you should specify details of the head office of your bank.

Code

From the list of the branches you have already maintained of your bank, designate one as your Head Office

Description

The description of the branch designated as Head Office is displayed

2.1.2 Maintaining Financial Preferences

In this screen, you can maintain information regarding default currency for the branch, specify if balancing entries must be automatically generated in case of mismatches, define routing mask, clearing bank code etc.

2.1.2.1 Specifying Default Currency Codes

You can indicate currency preferences for your bank. You can specify preferences to indicate the default currencies for the following purposes:

- **Local** — The currency that you indicate as the local currency will be taken as the local currency for all branches of your bank and the default currency for all transactions input into Oracle FLEXCUBE. The income and expense balances of your bank will also be maintained in this currency
- **Discount** — If the discount rate for a particular currency is not maintained the discount rate of the specified discount currency will be picked up for discounting profits on forward foreign exchange contracts
- **Head Office** — The default currency for the Head Office
- **Reporting** — The default currency in which all financial reporting should be done

You will not have an option to modify the default currencies that you specify after the Bank Parameters record has been stored and authorized.

RO Level Uniqueness

Check this box to indicate that a customer identification number (CIF) should be unique across all branches linked to a certain regional office. This means that the same CIF can be created in any other branch under a different regional office. If you leave this box unchecked, the system will allow saving of a CIF record only if it is unique across all branches of your bank as a whole.

Auto Generate Currency and Value Date Mismatch Entries

You can specify that balancing entries must be generated automatically by Oracle FLEXCUBE, in the case of currency or value date mismatches in accounting entries due to transactions that are not balanced with respect to currency or value dates, for each branch (single entity) of your bank.

To specify the automatic generation of such balancing entries for currency mismatches, select the options 'Auto Generate Currency Mismatch Entries' and for generation of balancing entries to correct value date mismatches, select 'Auto Generate Value Date Mismatch Entries' in the Bank Wide Parameters screen.

If indicated in the Bank Wide Parameters, balancing entries will be automatically generated for any event if a mismatch of currency or value date entries (or both) is involved in any module of Oracle FLEXCUBE, with the exception of manually entered journal entries.

2.1.2.2 Specifying Control Accounts for Auto Balancing Entries (Real and Contingent)

If you specify that such automatic balancing entries must be generated, you can also specify the control accounts into which the entries must be booked.

There are two sets of accounts that you can maintain in the Bank-Wide Parameters screen, one for mismatches arising out of entries to real accounts and another for mismatches arising out of entries to contingent accounts. The relevant Control accounts must therefore be of Real or Contingent nature (as defined in the GL – Chart of Accounts). Such balancing entries will be automatically generated if a mismatch of currency or value date entries (or both) is involved in any module of Oracle FLEXCUBE, except Journal Entry.

In your Chart of Accounts, you must ensure that the following conditions are not indicated for the control accounts that you have specified for the currency mismatch and value date mismatch entries:

- Position accounting: Even if position accounting is set to “Yes” for the control account, the system will not pass any position accounting entries, since position accounting is done only for the main set of entries and not for the auto-balancing entries.
- Account revaluation: Account revaluation must be set for the control accounts since the effect of revaluing these balances would be offset the effect of revaluing the original GLs. (the GLs into which the main entries were posted).
- Direct posting: If you post a manual entry to one of the Control Accounts and the Position Entry Flag for the Control Account is set to 'Yes', then the system will do position accounting for that entry. Hence, for the GLs set-up as Control Accounts, the “Direct Posting” flag in the Chart of Accounts maintenance must be turned OFF.

 Additionally, it is also recommended that these Control Account GL's that you have specified in the Bank Wide Parameters screen for the mismatch entries are not used as part of Role to Head Mapping in any of the products. If maintained, the system would pass mismatch adjustment entries into the same GLs in which the main entries have been passed. There is no system-enforced validation of this and this aspect needs to be taken care of during Product set-up.

2.1.3 Generating Automatic Balancing Entries

In the case of transactions entered in any of the front-end modules of Oracle FLEXCUBE, the accounting process checks the entries at each business event, and automatically generates the balancing entries in case of a mismatch in currency or value date entries (or both).

Manually entered journal entries

In the case of manually entered journal entries, a journal batch that has been opened must be closed before it is authorized. During closure, the accounting process checks to see that the batch is balanced with respect to currency and value date entries. If a mismatch is detected, the accounting process raises an override to this effect. Depending upon how the override is configured, for your bank, the user who has opened the batch could adopt either of the following courses of action:

- If the override is configured to be an error, the system will not allow the user to close the batch without balancing the mismatches.
- If the override is configured to be a warning (either 'Override' or 'Ignore'), the user can save the batch with the mismatches. No balancing entries are automatically generated by the system for the mismatch.

Uploaded journal entries

In the case of uploaded journal entries, a journal batch that has mismatched entries is not rejected, but an override is raised by the accounting process. Depending upon how the override is configured, for your bank, the accounting process takes either of the following paths:

- If the override is configured to be an error, then the batch is rejected, and must be uploaded again with the corrected entries.
- If the override is configured to be a warning, the accounting process automatically generates the balancing entries for the currency or value date mismatches, for the batch, and posts them to the requisite control accounts specified in the Bank Parameters.

In each case, the transaction reference for the balancing entries is the same as that of the original accounting entry, in which the mismatch occurred, and the other details of the balancing entries are, by default, the corresponding values in the original entries.

The mismatch balancing entries are generated in the following order or preference:

- Currency mismatch balancing entries
- Value Date mismatch balancing entries

In the case of mismatches in accounting entries due to inter-branch transactions, the inter-branch balancing entries are generated before any balancing entries for currency mismatches, and then, finally, the value date mismatches.

Routing Mask

A mask defines the manner in which a Routing Number is generated for your bank. It is on the basis of the routing number that Oracle FLEXCUBE processes clearing transactions.

The following is a typical mask format: 'BBBbbbSSS', wherein, 'BBB' indicates the bank code, 'bbb' indicates the branch, and 'SSS' indicates the sector to which the branch belongs. On the basis of the routing number, clearing transactions are routed to the appropriate branch of your bank.

Clearing Bank Code

Specify the code by which your bank is identified in the Clearing Network you participate in. This has to be the same as that specified for your bank in the Clearing Bank Code Maintenance screen.

2.1.4 Maintaining General Preferences

In this screen, you can define format masks (for general ledger, CIF), choose if batch numbers should be auto-generated by the system, specify the details for cheque numbering etc.

2.1.4.1 Defining Format Masks

A format mask is a structure that you can define for various elements that need to be entered in Oracle FLEXCUBE. You can define format masks for the following elements:

- General Ledgers
- Customer Identification File codes
- Customer account numbers

Once defined, you can modify the structure of a format mask only if no Customer or General Ledger Account has been opened using the mask. Customer Account mask is defined from the 'Account Mask' Button.

For more details on defining customer account mask, refer the section titled 'Specifying Account Generation Parameters at Bank Level'.

CIF Mask

You can maintain a mask for generation of identification numbers (CIF Number) for customers of your bank. During customer information maintenance, the system will automatically generate the CIF numbers based on the mask you define here and the customer number range maintained at the branch level.

A CIF mask consists of a maximum of 9 digits. The CIF mask could have only numbers or could be alpha numeric or could also have the branch code as a part of it.

For instance, you can maintain the CIF Mask as 'bbbnnnnnn' where 'bbb' represents a three-digit branch code and 'nnnnnn' represents a 6-digit number.

GL Mask

You can indicate a mask for the general ledgers that are maintained for your bank. The mask that you define here will be enforced whenever a General Ledger is created in the Chart of Accounts screen.

A GL mask can consist of a maximum of nine alphanumeric characters. It can be built using a combination of numbers and letters to indicate for instance, the category of the GL - asset, liability etc., the GLs hierarchical position and so on.

Each element used to define the mask would represent a single character. To represent an alphabet of the English language, indicate "a". To represent a number, indicate "n". The last character would be a D or d, which indicates a check digit generated by the system. For a numeric check digit define it as 'd'; for an alphanumeric check digit define it as 'D'.

You may use any of the following punctuation in the GL mask:

- dash (-)
- comma (,)
- asterisk (*)
- Full Stop (.)
- Forward slash (/)

Example

You wish to create a two level GL structure for your bank. You could define the first two characters of the GL to represent the category asset, liability etc., aa; the next two characters, nn, to represent the first level GL; and the next three characters, nnn, to represent the second level GL. A GL based on the given structure would read as AS01001 where AS represents the GL category - asset; 01 represents the first level GL; 001 represents the second level GL.

For creating this structure you would define your GL mask as - aannnnn'd/D'.

If you want to define your second level GL with a 4 digit numeric code instead of 3; other parameters remaining the same your mask would read as aannnnnn 'd/' 'D'.

2.1.4.2 Indicating Year-end Profit & Loss

General Ledger

At the end of any financial year the balances in the income and expense accounts are posted by Oracle FLEXCUBE into a separate year-end account for the purpose of consolidation of balances and turnovers. This account is called the Year End profit and loss General Ledger Account.

You also specify year-end profit and loss GL for each GL account you maintain in the 'Chart of Accounts' screen. The year-end account specified at the bank level is the default year end profit and loss GL for all GL accounts maintained in the 'Chart of Accounts - GL' screen. If you do not specify the account to which year end balances of a particular GL should be posted, it will be posted to the bank's year-end profit and loss account.

You can select a GL code from the option list of all assets, liabilities, income and expense GLs maintained in the chart of accounts screen.

Transaction Code

Indicate the transaction code that should be used to post the balances in the income and expense accounts to the year-end GL account.

You can select a transaction code from the list of transaction codes maintained in the 'Transaction Code Maintenance' screen.

Spread

Capture the following details.

Spread Application

Indicate the transaction legs for which the spread should be applicable. Choose the appropriate option from the following available in the adjoining drop-down list:

- Single Leg
- Both Legs

Spool File Purge Days

Specify the duration for which spool files should be stored in the spool file directory.

Interpay Lead Days

Specify the inter-pay lead days required for fetching billing records for inter-pay files for automatic billing of clients..

Auto Batch

Each time you post journal and multi offset entries, you need to open a batch. You can specify that the batch numbers of the journal entry batches opened in your bank should be generated automatically by enabling the Auto Batch option.

Consequently, the system automatically generates batch numbers while posting journal and multi offset entries.

2.1.5 Placing User Restrictions on Data Entry Batches

You can restrict the usage of batches to specific user by placing bank-wide User level batch restrictions. If you enable this option as a Bank Parameter, you need to allocate the batch number range for each user through the 'Batch Restriction Maintenance' screen.

The restriction on the usage of batch numbers is made applicable on data entry and PC transactions. The user will be allowed to enter only those batches reserved for the user profile. As a result, each time a user specifies a batch number; it will be validated against the 'Allocated Batch Number Range'.

This feature is applicable only when batch generation is manual. Therefore, if you enable this option, you must ensure that the Auto Generate option has not been enabled. In a scenario where the User Restriction for Batch Number field is enabled and Auto Batch option has also been enabled, the following error message will be displayed:

Not a Valid Batch Number For the User

In case you choose to auto generate batch numbers, the System will not perform the batch restriction validation.

You can invoke the **Branch Parameters** screen by typing 'STDBREST' in the field at the top right corner of the Application tool bar and clicking the adjoining arrow button.

Batch Restriction Maintenance -- Web Page Dialog

User Identification * AMIT2
User Name AMIT2

Branch Code * CHO
Branch Name BANK OF INDIA

Module Code * PC
Module Description Local Payments

Allocated Batch Number Range	
Start Number *	End Number
45	46

Fields

Input By PRAGNYA Date Time 7/3/2000 15:28:13 Modification Number 1 Open
Authorized By BISHNU Date Time 7/3/2000 15:31:58 Authorized

Specify the following details in this screen:

- The User Profile for which the restrictions are being maintained. A list of all the User Profiles with access rights to the DE and PC modules is displayed in the option list. You can select the appropriate.
- The branch of your bank for which the restrictions will be made applicable. You can either choose a specific branch or make the restriction applicable to 'All' the branches of your bank.
- The module for which you are maintaining the Allocated Batch Number Range. This can either be PC or DE.
- The batch number range, which is indicated in terms of Start and End numbers. The range that you specify is allocated to the user. For distinct numbers, the start number and end number of the range will be the same.



While processing DE and PC transactions, the batch number specified by the user is validated against the allotted range. If the validation fails, an error message is displayed.

These validations are made applicable even during the Batch Upload operations for the following functions:

1. Journal Online – Single Entry
2. Multi-offset Entry
3. Teller Transaction Input

SSO Enabled

To enable Single Sign On (SSO) for your installation check the SSO Enabled check box. This enables restricted login from external systems into Oracle FLEXCUBE.

General Ledger Purge Days

You can specify here the maximum number of working days, the average GL balance computation for which is to be retained in the System.

2.1.5.1 Specifying Cheque Numbering Details

Scheme

In Oracle FLEXCUBE, cheque numbers can be generated automatically or can be manually entered. If you indicate manually, you can draw up numbering conventions and assign numbers to the cheques that are issued.

Checksum Algorithm

If you choose the automatic generation option you can indicate the algorithm based on which the cheque digit should be generated. A cheque number consists of three components:

- A check digit

- A cheque type
- A running serial number

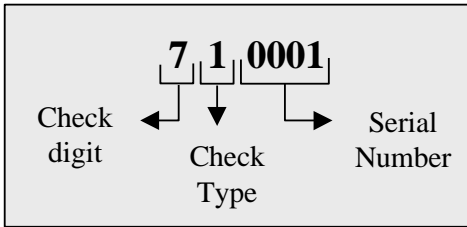

You have the option to choose the algorithm to be used to arrive at the check digit. Currently Oracle FLEXCUBE supports only the Modulo-7 algorithm. Based on this algorithm the check type and serial number is divided by seven, and the remainder is taken to be the check digit. If the remainder is zero, then the check digit is set to seven.

The cheque type indicates whether the cheque is a Euro or Commercial cheque. The numeral 1 before a cheque serial indicates a Euro cheque and 2 indicates a Commercial cheque.

The cheque serial number is generated sequentially starting from 0001. This running serial number is assigned taking into account the last check number issued for the account.

Cheque Numbers Unique For Branch

For cheque numbers that are automatically generated, you can choose to make cheque numbers unique across the branches of your bank.

If you indicate that serial numbers need not be unique, you can have the same cheque number assigned to cheque leaves of different accounts within a branch. In effect cheque numbers remain unique to an account.

Lodgment Numbers Unique for Branch

You can indicate whether lodgment leaves must have unique numbers in a branch, or must be unique for individual accounts.

Example

In the Bank Wide Parameters, you have specified that lodgment book numbers must be unique for the branch. This means that lodgment numbers need to be unique across all accounts of that branch. For instance, if a book is maintained with the Start Number as 1, and containing 25 leaves, you cannot start another book in respect of any other account, with these numbers.

If you have specified that lodgment book numbers must be unique to accounts in the branch, and a book is maintained with the Start Number as 1, and containing 25 leaves, you cannot start another book in respect of the same account, with these numbers. However, you can start a book with the same numbers in respect of another account in the branch.

2.1.5.2 Specifying TRS Details

You can maintain the following details that will be used by the system to raise direct debit for Tax Relief at Source (TRS) rebate availed by customers on mortgage loans. The direct debit is raised during the End of Day (EOD) process after the LD batch processes.

Sort Code

Specify the destination bank code for which the bank raises direct debits for TRS claims.

Account Number

The destination account for which the bank raises direct debits for TRS claims.

Payment& Collection Product Category

Specify the Payments and Collections (PC) product category that would be used by the bank to raise direct debits for TRS claims.

Suspense Account

Specify the account that would be debited with the TRS amount, to credit customer account.

For more details about processing for TRS, refer the Loans module user manual and the Payments and Collections user manual.

2.1.6 Specifying UDF Details

You can associate values to all the User Defined fields created and attached to the Bank Parameters Screen. You can view the list of User Defined fields associated by clicking the 'Fields' button. The screen appears as shown below:

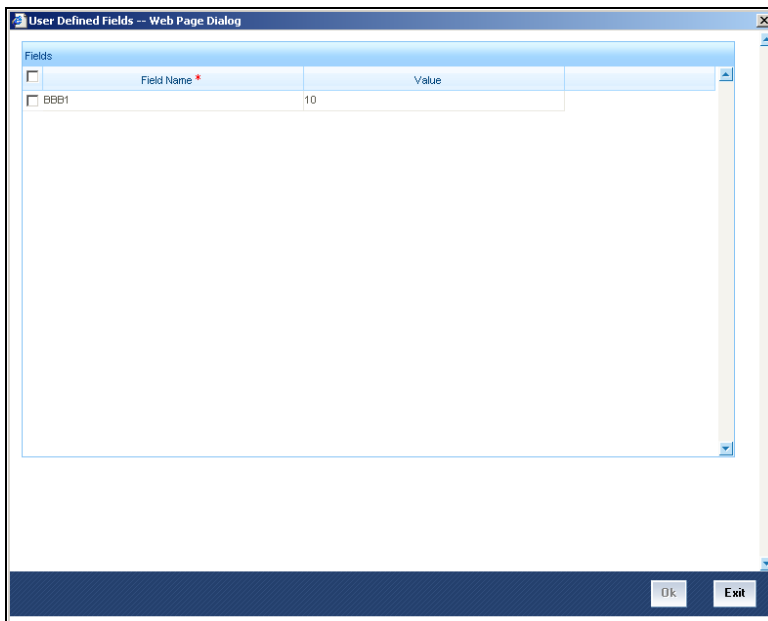

You can enter the value for the UDFs listed here in the 'Value' column.

For more details on how to create user Defined fields, refer chapter 'Creating custom fields in Oracle FLEXCUBE' in the User Defined Fields User Manual under Modularity.

2.1.7 Specifying Account Generation Parameters at Bank Level

Account numbers in your bank are generated in the format of the account mask that you specify through the 'Account Parameters' sub-screen of the Bank-wide Parameters screen. Click 'Account Mask' button in the Bank-wide Parameters screen. Account Parameters screen is displayed. The screen appears as shown below:

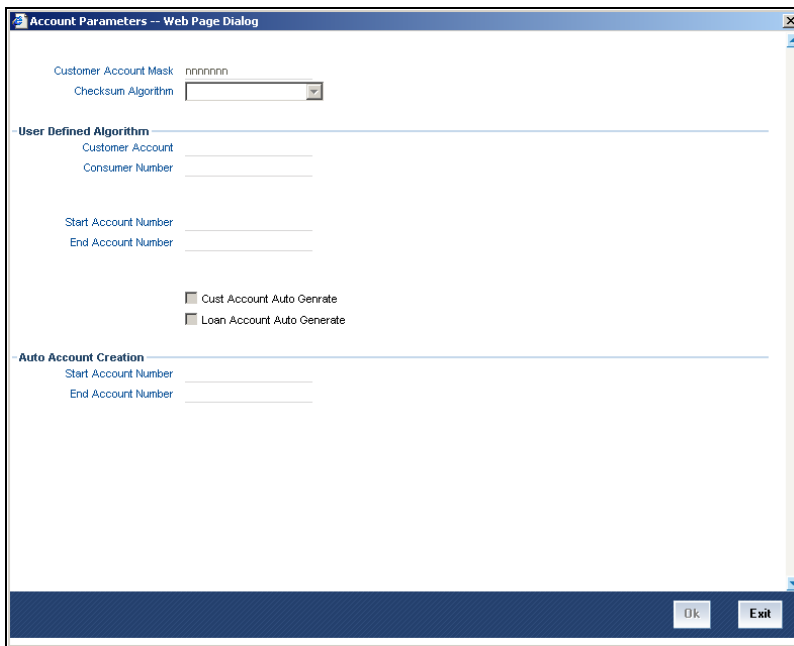

STOP Since account level parameters are defined at the bank-level, by default these parameters will be defaulted to all the branches of your bank. However, individual branches of your bank will be allowed to change these specifications.

2.1.7.1 Specifying Customer Account Mask

Account numbers can either be generated automatically or you can choose to allocate them manually. In Oracle FLEXCUBE you have the option of maintaining three types of account masks.

They are as follows:

- Alphanumeric – this type of an account mask is a combination of alphabets and numbers where you can build the mask with components such as the Branch Code, the Account Class, the Currency Code, a check digit, etc
- Numeric - is a numeric type of account mask where the checksum algorithm associated with the account mask is either Modulo 11, Modulo 11 with weights or Modulo 97.

- **Pure Numeric** – is a numeric type of account mask, which does not have a checksum algorithm, associated with it. If you are maintaining a pure numeric mask you have to identify the start and end account number which is to be associated with it.

Alphanumeric customer account masks

The alphanumeric customer account mask can have a maximum of twenty alphanumeric characters. It can comprise of one or more of the following elements in combination:

- **Account Class** — Use “ACCLASS” to indicate that the account class to which the account belongs should be part of the mask.
- **CIF Number** — You can incorporate the nine-character CIF code assigned to the customer into the mask. To do so indicate ‘CIF Number’ in the mask.
- **Currency** — To add the currency of the customer account, use ‘CCY’
- **To indicate an alphabet or number** — Each element used to define the mask would represent a single character. To represent an alphabet of the English language, indicate “a”. To represent a number, indicate “n”.
- **Punctuation Marks** — When defining the customer account mask you have the option of separating the elements. To do this, you may use the following punctuation marks:
 - Dash (-)
 - Comma (,)
 - Asterisk (*)
 - Full stop (.)
 - Forward slash (/)

For Check Digit - The last character in the customer account mask should always be a ‘D’ or ‘d’. This indicates the check digit, which is generated by the system. When specified in the mask, the check digit component is generated using either of the following methods:

- Modulo 11
- Modulo 97
- Modulo 11 with Weights
- User Defined Algorithm

If you choose Modulo 97, all components of the account mask (for example, the Branch Code, the Account Class, the CIF ID, etc.) should be numeric. For example, if you enter ‘bbb’ in the account mask field (indicating that the branch code should be part of the account number), and choose the Modulo 97 option, ensure that the branch code is a numeric value, such as ‘000’, ‘123’, etc.



The maximum length of twenty characters for the customer account mask is inclusive of the check digit

All customer accounts that are entered in any branch of your bank will compulsorily have to conform to the mask.

Example

You want the following elements to be part of the customer account mask:

- The currency of the account
- The nature of the account (savings, current etc.) and
- The Customer Id

Given the above criteria the customer account mask would be:

AClassCCYcIFNUMBERn'D'

This corresponds to:

LLLLL\$\$\$CCCCCND

All customer accounts entered in any branch of your bank would now comprise of these elements, in the order defined in the mask.

A customer with CIF number 10005 has opened his first USD savings account with your bank, and the Account class for savings accounts is INDSB. His account number would read:

INDSB-USD-10005-01'D'

Similarly, the second GBP current account of a corporate customer with CIF Number 20005, would read

CUCOR-GBP-20005-02'D'

'CUCOR' being the account class representing current accounts of corporate customers.

Customer Account Number Containing a UDF Value

While defining a customer account if you include 'U' in the account mask, it indicates that the customer account numbers will have the value of a user-defined field.

The number of U's will depend on the length of the UDF value that has to be included in the customer account number. For example, if you want to include 3 characters from a UDF, the account mask should consist of UUU (in addition to other parameters which you want to include in the customer account numbers).



Note the following:

- A user-defined field can be part of the customer account mask only if the customer account number generation is not automatic.
- Since a customer account number in Oracle FLEXCUBE can accommodate only up to 20 characters you have to ensure that the account mask you have defined does not exceed this number.

Numeric Account Masks with Modulo 11 and Modulo 97 as Checksum Algorithms

A numeric type of mask can have a maximum of twenty numeric characters, inclusive of the checksum algorithm.

If you associate Modulo 11, as the checksum algorithm, a single character D will be appended to the numeric mask. Let us assume that you have an account mask with five numeric values – 'nnnnn' and associated Modulo 11 as the checksum algorithm. The system automatically appends 'D' to the numeric mask. The generated account numbers will have the following format – nnnnnD.

Similarly, if you associate Modulo 97, with an account mask of five numeric values, the system appends a double-digit value of DD to the mask. The generated accounts will have the following format – nnnnnDD.

Numeric Account Masks with 'Modulo 11 with Weights' as Checksum Algorithm

The account mask with 'Modulo 11 with Weights' algorithm can have a maximum of 13 digits. It comprises of the following elements:

- Branch Code (3 digits) – Indicates the branch at which the customer account is maintained.
- Account Code (1 digit) – This will indicate the account code of the account class to which the customer account belongs. During account number generation (in the Customer Account Maintenance screen), you need to select the account class from the option-list provided. The system will then convert it to the account code maintained for that account class. The account code thus becomes a part of the customer account number.
- Currency Type (1 digit) – This will represent the currency type of the account currency. As explained for account code, you will select a 3-digit currency code during account generation. The system will convert it to the currency type maintained for that currency. The currency type will then form a part of the account mask.
- CIF Number – You can also include the CIF number of the customer as part of the account mask. The CIF number is automatically generated by the system when you capture customer details in the Customer Information Maintenance screen. During customer account maintenance, you can select the CIF number from the option list provided.
- Sequence Number (1 digit) – The sequence number is automatically generated by the system for a combination of account code + currency type + customer. This means that, for this combination, you can maintain nine accounts. To maintain the 10th account for the same combination, the system will use the 'Dummy Customer No. Range' maintained at the branch level'.

Refer the section titled 'Creating Branches' of this document for more details on dummy number range.

- Control Number (1 digit) - This is the 13th digit of the account number. This number is also automatically generated by the system based on the 'Modulo 11 with Weights' algorithm.

For the above combination, the customer account mask would be:

'bbbTZCCCCCSd'

Where,

- bbb – is the branch code

- T – indicates the account code
- Z – is the currency type
- CCCCCC – is the CIF number of the customer
- S – is the sequence number for a combination of account code, currency type and customer
- d – is the control number generated by 'Modulo 11 with Weights' algorithm

The following example illustrates the manner in which the system calculates the 13th digit for a customer account number using the 'Modulo 11 with Weights' algorithm.

Assume that the account number of a customer is '000-4-1-123456-1'. As per this algorithm, the value of each position (1 to 12) is multiplied with the weight for each position (the weights are provided by your bank). Further, the sum of the product obtained is divided by 11. The remainder of the division will determine the value of the 13th digit.

The position-wise weight and account number and the product (of weight and number) is as follows:

Position	1	2	3	4	5	6	7	8	9	10	11	12
Weight (W)	2	4	8	5	10	9	7	3	6	2	3	5
Acct. No (N)	0	0	0	1	2	3	4	5	6	4	1	1
Product (W * N)	0	0	0	5	20	27	28	15	36	8	3	5

Sum of the product = 147.

Divide the value 147 by 11 to obtain the remainder

Remainder = (147/11) = 4

As per this algorithm, if the remainder is 10, then the control number will be zero. If it is any value other than 10, the remainder itself will be taken as the control number.

Therefore, the 13th digit = 4.

The customer account number will now read as '000-4-1-123456-1-4'

Numeric Account Masks with User Defined Algorithms as Checksum Algorithm

If the check digit component within a Customer Account Number is to be generated using a method of your choice you must identify the following:

- The User Defined Algorithm for the Customer Account Number – this identifies the name of the user-defined algorithm for check digit generation of account numbers.
- The User Defined Algorithm for Consumer Number – this stores the name of the user-defined algorithm for validating consumer numbers.

While capturing Customer Account numbers, the System checks for your specification for the checksum algorithm. If you have selected User Defined, the check digit is generated using the specified user-defined algorithm.



Since these parameters are maintained for your bank, they are defaulted to the branches of your bank. You will not be allowed to change these for a specific branch of your bank.

Pure Numeric Masks

A numeric account mask, which does not have a checksum algorithm associated with it, is called a pure numeric mask. Since it does not have a checksum algorithm associated with it you will have to specify the start and end account numbers and enable the auto-generated option.

The start account number forms the basis on which customer accounts numbers are to be generated. Similarly, you will not be allowed to maintain account numbers beyond the end account number.

Let us assume, that you are have maintained the following details in the Account Parameters screen at your bank:

Customer Account Mask	nnnnn
Start Account Number	1
End Account Number	50000
Cust Acc Auto Generate	Yes

While generating a new account number the system will automatically generate 00001 corresponding to nnnnn. The next account will be – 00002.

Including Value of a UDF as Part of Customer Account Number

If your bank has not opted for automatic generation of account numbers, you can specify a structure for customer account numbers. The structure can be a combination of CIF number, account class, value of a user defined field, currency, branch code, alphabets/numeric and a check digit which is automatically generated by the system.

Example for an account mask is CCCCCCLLbbbUUU\$\$\$ad.

This implies that a customer account number will contain:

- CIF Id – represented by C
- Account Class represented by L
- Branch Code represented by b
- Values of a user defined field represented by U
- Any user-input alphabet represented by a (enter 'n' if you want to include a numeric)
- Currency Code represented by \$\$\$
- A check digit (which is automatically generated by the system) represented by 'd'



The number of C's in the account mask should match with the CIF mask that you have specified. For instance, if the CIF mask is aaaannn (7characters), the account mask should consist 7 C's to include the CIF Id in the customer account number.

The value of a user-defined field can be used to include an additional parameter (for example: the code of the country to which the customer belongs) in the customer account number.

The steps involved for including the value of a user-defined field in a customer account number are as follows:

1. Include 'U' in the customer account mask to indicate that the customer account number should contain the value of a UDF
2. Create a new user defined field
3. Link it to the Function Id STDCIF
4. Specify the value of the user defined field at the time of creating a customer
5. Specify the UDF whose value has to be included in the customer account number to the Oracle FLEXCUBE implementer. The implementer will indicate this at the back end.

Maintaining Ten Digit Masks with Running Sequence Numbers

You can maintain a 10-digit mask of any combination, wherein the last two digits will necessarily be a running sequence number. This number will be automatically generated by the system. For instance, if you want to maintain a mask for the customer number and currency combination followed by the two digit running number, you will have to maintain the mask as CCCCC\$\$\$SS. Here, CCCCC stands for the customer number, \$\$\$ stands for the currency of the account and SS stands for the running number. The system will generate the last two-digit number in a continuous sequence irrespective of the combination that you specify in the mask.

Example

Let us assume that you want the customer account number to be a combination of the customer number and the account currency followed by the serial number. To achieve this, you have to specify the mask as CCCCC\$\$\$SS. Based on this mask, for a customer with CIF ID 40207 with account in USD, the account number will be 40207USD01. If the same customer has another account in GBP, the next account number would be 40207GBP02. That is, there will not be any holes in the system generated running number.

2.1.7.2 Specifying Auto Account Creation Parameters

You may wish the system to automatically create current accounts for customers at the time of loan initiation. These system-created current accounts are for use as settlement accounts.

Here, you need to specify the range of numbers available for such auto created accounts by mentioning a start and an end number.

If you wish to retain the facility of auto creation of current accounts at loan initiation, you will have to ensure that the account number mask does not have any user input character.

2.1.8 Defining Bank-wide Preferences

In the Bank-Wide Preferences screen, you can specify the following:

- The route of inter-branch accounting — through HO, through RO or directly between branches
- Exchange rate preferences — to be maintained for the bank as a whole or at each branch
- Preference relating to update of GL balances — on-line or at the End of day
- Preference relating to Position Accounting
- Interface details

Click the 'Preferences' button to invoke the 'Preferences' screen.

The screenshot shows a 'Preferences -- Web Page Dialog' window. It is organized into three main sections:

- Interface Details:** Contains two input fields: 'Journal Account' and 'Width'.
- Inter Branch Scheme:** Contains two dropdown menus: 'Inter Branch Entity' and 'Inter Branch Account Schedule'.
- Preferences:** A list of checkboxes for various options:
 - Online General Ledger Update
 - Auto Generate CIF Numbers
 - Copy Exchange Rates to Branches
 - Position Accounting Required
 - Daily MIS Refinancing
 - Propagate Floating Rates to Branches
 - Limits History Required
 - Branchwise Limits
 - Pairwise Positioning Required
 - Propagate CIF to other Nodes
 - Propagate Customer Address to Nodes
 - Propagate Bank Instruction Codes Details to Nodes
 - Allow Inventory Tracking

At the bottom left, there is a dropdown menu for 'Maintenance of Customer Identification Mask at'. Below this is a button labeled 'Nodewise CIF mask Maintenance'. At the bottom right, there are 'Ok' and 'Exit' buttons.

2.1.8.1 Specifying Inter Branch Scheme

Inter Branch Account Schedule

You can indicate the route through which accounting entries for inter-branch transactions should be settled. You can select one of the following routes from the option list that is available:

- Choose 'Through HO' to indicate that inter-branch transactions should be settled through the Head Office
- If you specify 'Through RO' the accounting entries would be routed through the regional office. If two branches involved in a transaction do not report to a common regional office, the accounting entry would be routed through the HO
- If you specify 'Direct', each branch would have a direct accounting relationship with every other branch

The receivable and payable accounts between the branches, referred to as 'due from' and 'due to' accounts, are maintained in the 'Inter-branch parameters' screen.

Example

Suppose the University Savings Bank has the following set up for its head office and branches in Headington, Oxford:

- Roosevelt Avenue Branch, is the HO with Branch Code 000
- Foxlake Drive Branch (Branch Code 001)
- Mountainwood Road branch (Branch Code 002)

You have indicated that inter-branch transactions should be routed through the Head Office. Ms. Tanya Agnihotri has an account in Branch 002. She makes a cash withdrawal from Branch 001. This being an inter-branch transaction, Branch 001 will have to recover the money from Branch 002.

In this example the following movement of funds is involved:

- At Branch 001, the cash account is credited for the transaction amount and due from Head Office account debited.
- At Branch 000, the due from Branch 002 is debited and the due to Branch 001 is credited.
- At Branch 002, the Customer Account is debited and the due to Head Office account credited

Inter Branch Entity

Oracle FLEXCUBE allows you to post accounting entries related to inter-branch transactions to either of the following:

- Customer Accounts
- General Ledgers

If you select Customer Accounts as an inter-branch entity, you can specify the currency and the actual customer accounts involved in an inter-branch transaction between two branches of your bank. If the inter-branch entity is specified as 'General Ledgers', you need to specify the internal accounts that would be involved in a transaction between two different branches of your bank.

Online GL Updates

The update of GL balances can take place either on-line or during End of Day. For an on-line update select this checkbox.

Auto- Generate CIF Numbers

This indicates whether or not the CIF should be generated automatically. Check this box to indicate the CIF number needs to be generated automatically.

Copy Exchange Rates to Branches

Exchange rates are maintained for a currency pair and are used to calculate the equivalent of one currency against the other. These exchange rates can be maintained in each branch or at the Head office. You can indicate your preference.

If you check against the option 'Copy to Branches' the exchange rates maintained at the Head Office will be made applicable to all branches of the bank. Leave it unchecked to indicate that exchange rates should be maintained at each branch.

Position Accounting Required

You can retrieve the position of a foreign currency, any time, by opting for position accounting in your bank. When you opt for position accounting, you maintain a Position GL and a Position Equivalent GL for every foreign currency maintained in your bank. The Position GL reflects the current position of the currency.

If you opt for position accounting while defining Bank-Wide Parameters, you have to maintain Position GLs and Position Equivalent GLs for every foreign currency that your bank deals in. When maintaining GLs for your bank, you can opt to link the different currencies, associated with the GL to either of the following:

- The Position GLs that you have specified for the currency (Your specifications in the Currency Definition screen will default here)
- Position GLs of your choice

Daily MIS Refinancing

As part of setting up the bank level preferences you can indicate whether MIS refinancing processing is required on a daily basis for the particular branch of your bank.

If you indicate that MIS refinancing should be done on a daily basis, refinance processing will be done on a daily basis for the following modules:

- Loans and Deposits
- Money Market



You can indicate the rate type that is to be used for individual LD, and MM transactions while processing the contract.

Propagate Floating Rates to Branches

You have to indicate whether the floating rates maintained at the head-office of your bank should be propagated across all the branches of your bank.

Check the box positioned next to this field to indicate that floating rates need to be propagated across branches. Consequently, each time you maintain a floating rate for a particular rate code and currency combination at your bank, a corresponding floating rate record will be created and sent to all the branches of your bank.

Limits History Required

You can indicate whether date-wise limits history needs to be maintained for the Bank. If you choose to enable this option, the limits history is maintained at the following levels:

- Liability level history for storing liability records
- Limit level history for storing Lines records
- Line level history for storing Line Utilization records

Conditions for collating Limits History data:

- There is no retrospective effect on limits history.
 - Back-valued contracts and account transactions do not result in any adjustment to the previous records in the history. Such transactions are inserted with the current EOD date. Similarly any future-dated contracts and account transactions are also inserted with the current EOD dates.
 - In cases where the main line is changed to a sub line, the utilization is transferred from the old main line to the new main line and the effect cascades to the ultimate parent line. But existing records are not changed or updated.
 - Existing data will not reflect the change in the liability number for a customer.
- Revaluation has no effect on the limits history data
- Limits history is not maintained country-wise

The data is archived during the EOD processing. The history data is not updated for holidays.



If there is no change for a liability/limit/line, data is not archived for that day

The example below illustrates the functionality:

* All the Currencies are in USD

Customer	Liability	Liability Amount
Cust1	Cust1	100000
Account	Credit Line	Limit Amount
Acct1	Line 1	60000
Acct2	Line 2	40000

Case I

On Day 1, which is 1st Jan 2001, No Transactions have been processed. Therefore no data is stored in any of the history tables.

Case II

On Day 2, which is the 3rd of Jan 2001 (2nd Jan 2001 was a holiday) no transactions have been processed in the System. Therefore data is not stored in any of the limits history tables.

Case III

On Day 3, which is The 4th of Jan 2001, transactions have been processed in the System. The data in the History tables after the EOD will be as follows:

Account	Type of transaction	Debit Amount	Contract Ref No
Acct1	Journal Entry	10000	ACCT1
Acct1	Loan	20000	Laon1

Liability History

History Date	Overall Limit	Utilized Amount
4-Jan-2001	100000	30000

Lines History

History Date	Line	Limit Amount	Available Amount	Utilization
4-January-2001	Line1	60000	30000	30000
4-January-2001	Line2	40000	40000	0

Line Utilizations History

History Date	Reference No	Line	Amount	Liability Utilization
4-January-2001	Acct1	Line1	10000	10000
4-January-2001	Loan1	Line1	20000	20000

Further drill down to the contract screens/ account balances screen will be possible from the line utilization history level

Case IV

On Day 4, which is the 5th of Jan 2001, the following loan transactions have been processed in the System. The data in the History tables after the EOD processes will be as follows:

The value date of the contract is 2nd January 2001.

Account	Type of transaction	Debit Amount	Contract Ref No
---------	---------------------	--------------	-----------------

Account	Type of transaction	Debit Amount	Contract Ref No
Acct1	Loan	15000	LOAN2

The value date of the contract is 8th January 2001

Account	Type of transaction	Debit Amount	Contract Ref No
Acct2	Loan	6000	LOAN3

Liability History

History Date	Overall Limit	Utilized Amount
4-January-2001	100000	30000
5-January-2001	100000	51000

Lines History

History Date	Line	Limit Amount	Available Amount	Utilization
4-Jan-2001	Line1	60000	30000	30000
4-Jan-2001	Line2	40000	40000	0
5-Jan-2001	Line1	60000	15000	45000
5-Jan-2001	Line2	40000	34000	6000

Line Utilizations History

History Date	Reference No	Line	Amount	Liability Utilization
4-January-2001	Acct1	Line1	10000	10000
4-January-2001	Loan1	Line1	20000	20000
5-January-2001	Loan2	Line1	15000	15000
5-January-2001	Loan3	Line2	6000	6000



This option can be enabled or disabled at any point of time. Limits history will be recorded with effect from the day the option is enabled. Disabling the option will however not automatically purge history data.

You have the option of querying Liability history and drilling down to Limits Line history and further drilling down to Contract-wise Utilization history. Clean risk data is displayed only as of the date of query and history for the same is not maintained.

Branch wise Limits

This option indicates whether or not the limits tracking must be done at the branch level. If this box is checked, you will be allowed to view/change only the lines created from that branch for a given liability.

To illustrate, if you open any credit line facility in branch BR1, then in the Limit Restriction screen, the only branch available will be BR1.

Checking this option will also allow you to View details of line utilization at the branch level in the Limits Query screen.

Example

Consider that the Liabilities Liab 1, 2 and 3 are present and different branches want to open different lines under these liability numbers

Liab1	Line1	BR1
Liab2	Line2	BR2
Liab3	Line3	BR3

In the above case, line 1, line 2 and line 3 are opened in Branches 1, 2 and 3 respectively for liability numbers Liab 1, 2 and 3.

If the Branchwise Limits parameter specified at the bank level is checked, then the branch allowed for each of the above lines would default as the branch in which these lines are opened and you will not be able to change the branch restriction setting in the Limits Restrictions screen under Limits.

This in turn would restrict the above-mentioned lines for liability, to only the corresponding branch.

Example

For Liab1 Line1 BR1

The branch allowed would be BR1. Hence, during contract input, in BR1, you would be provided with only one option i.e. line1.

Now, if you wanted to use another line facility in Branch 1, you would have to open one more line called line4

You would not be allowed to use Line 2 or 3 because the branches allowed for these lines are BR2 and BR3 respectively.

Therefore, if the Branch-wise Limits option is checked at the Branch level, then the following becomes true:

Current Branch	Liability	Line	Branch Allowed
BR1	Liab1	Line1	BR1
BR1	Liab2	Line4	BR1
BR2	Liab3	Line2	BR2

Current Branch	Liability	Line	Branch Allowed
BR3	Liab4	Line3	BR3

The Branch Allowed would default as the current branch. If you are viewing the records, then the system would provide the records for the current branch only. As per this example, Line1 and Line4 would be available for View/change in branch BR1.

Similarly, if the Branch-wise Limit option is checked, the records related to the current branch would be shown in the Limits Summary View.

If Branch-wise Limits option is left unchecked, then the existing setup would hold good; that is, you would be able to see all the line facility records for any branch. You would also be able to utilize any line during contract input irrespective of the branch it was opened in.

With the above setup, Line Utilization would be tracked at the branch level but liability utilization would be tracked at instance level

To go back to the first example, if there are 3 instances, then for the 3rd instance, line 2 and line 3 would be tracked at branch BR2 and BR3 respectively. However, liability tracking would be a consolidation of line 2 and line 3.

Hence, Liability tracking would be at the instance level whereas line tracking would be at the branch level.

For a total utilization of a global customer maintained in HO, you would have to generate a report of the limit utilization for each instance.

Pairwise Positioning Required

You have to select this option to indicate whether pair wise positioning entries need to be stored/handed off or not. If selected, the system will store position creating pair entries separately for handoff to other external systems.

When processing accounting entries, the system will check whether you have opted for pair wise positioning. If you opt for this option, the system will check for the following conditions in all the accounting entries that are posted:

- The set of entries posted are balanced i.e. total LCY debit is equal to total LCY credit
- At least one pair of accounting entry is in FCY
- Both the currencies are not the same

If the above conditions hold true, the system will store the entries along with the following information:

- Dr. Account: indicates the debit leg's account GL
- Cr. Account: indicates credit leg's account GL
- Event Code: is the event of the transaction
- Dr CCY/Bought Currency
- Dr. Amount/Bought Amount

- Cr. CCY/Sold Currency
- Cr. Amount/Sold Amount
- Dr Booking Date/Cr Booking Date
- Dr Value Date/ Cr Value Date
- Dr Transaction Code/Cr Transaction Code
- Exchange Rate
- Hand Off Flag



While passing pair wise position entries, the main component will be passed with TRF_AMT tag and the equivalent entry will be passed with the AMT_EQUIV tag.

Example

Let the local currency of your branch be JPY.

Dr/Cr	Acc/GL	Amount	Rate	LCY Eqv.
Dr	Loan GL	1000 USD	100	100,000 JPY
Cr	Customer Acc.	1600 EUR	62.5	100,000 JPY
Position Entries created				
Dr	Position Eqv.			100,000 JPY
Cr	Position	1000 USD	100	100,000 JPY
Dr	Position	1600 EUR	62.5	100,000 JPY
Cr	Position Eqv.			100,000 JPY

As seen in the table above, the actual loan disbursement entries have created an FCY position in both USD and EUR. Therefore, these two entries will be captured and stored separately as a single entry with the Dr currency (bought currency) as USD and Credit currency (sold currency) as EUR. The same would be applicable if FCY-LCY or LCY-FCY transaction is considered.

In case of accruals/revaluation also, if position entries are created, the corresponding entries will be stored separately for hand off.



Pair-wise Positioning Required will decide whether position creating pair entries need to be stored by the accounting processor separately for handing off to other system.

Propagate CIF to other Nodes

You need to indicate whether or not the CIF number maintained in HO has to be propagated to other branches present in different instances. Check this box to indicate the CIF number has to be propagated to other Nodes/instances.

Propagate Customer Addresses to Nodes

You need to indicate whether or not the customer addresses maintained in HO has to be propagated to other branches present in different instances. Check this box to indicate the Customer addresses has to be propagated to other Nodes/instances.

Propagate Bank Instruction Codes Details to Nodes

This indicates whether or not the BIC data maintained in HO has to be propagated to other branches present in different instances. Check this box to propagate BIC details.

Maintenance of Customer Identification Mask at Branch/Node level

This option gives you the flexibility to define different CIF masks at the Nodes/Bank level. If you select 'Bank' from the option list, then the CIF mask given at Bank level will be applied to all the branches under it.

If you select 'Node' from the option list, you will need to maintain CIF masks at the Node level in the 'Node-wise CIF Mask Maintenance' screen. This would ensure that the branches maintained in different nodes/instances have different CIF masks.

Click 'Nodewise CIF mask Maintenance' button to access this screen. The screen appears as shown below:

Nodes *	Customer Identification File Mask *	Autogenerate Customer Identification File Number *
FCKERNEL.WORLD	nnnnnn	<input type="checkbox"/>

You can specify the following details here:

Nodes

This indicates the node/instance for which the CIF mask is required. Select a node from the option list provided.

Customer Identification File Mask

This indicates the CIF mask for the corresponding instance/node. Select a CIF mask from the option list provided.

Autogenerate Customer Identification File Number

This indicates whether or not the CIF should be generated automatically. Check this box to indicate the CIF number needs to be generated automatically.

Allow Inventory Tracking

You can use this check box to allow/disallow inventory management and tracking. To use inventory management module, check this box.



If inventory tracking is allowed then 'Cheque Numbering Scheme' should be left blank/null.

For more details on Inventory Tracking, refer the Instruments Inventory Tracking module manual.

3. Dealer Maintenance

3.1 Defining Dealer

At the time of entering the details of a foreign exchange, money market, or securities deal, you will be required to enter details of the dealer who has struck the deal.

The dealers at your bank, who are associated with the buying and selling of foreign exchange, money or securities in the treasury, should each be assigned an identification number (ID number). The dealer list is maintained for the bank through the 'Dealer Maintenance' screen. Invoke this screen by typing 'STDDEALR' in the field at the top right corner of the Application tool bar and clicking the adjoining arrow button.



The screenshot shows a web page dialog titled "Dealer Maintenance -- Web Page Dialog". The main content area contains two input fields: "Dealer Id * MIKE" and "Dealer Name Mike Peter". Below the input fields is a "Fields" tab. At the bottom of the dialog, there is a status bar with the following information: "Input By SCRIPT5", "Date Time 12/28/1999 16:14:53", "Modification Number 1", "Open" (checked), "Authorized By SCRIPT5", "Date Time 12/28/1999 16:14:53", "Authorized" (checked), and an "Exit" button.

The following parameters need to be maintained to define a dealer ID:

Dealer Id

Enter a unique code to identify the dealer. The identification code can have a maximum of six alphanumeric characters.

The dealer will be identified by this code for all transactions entered in Oracle FLEXCUBE. You can also retrieve dealer-wise information on the treasury deals entered into by your bank.

Dealer Name

You can also enter a detailed name of the dealer. The name of the dealer will be displayed whenever the dealer Id is used.

4. Branch Parameters

4.1 Creating branches

In the 'Branch Parameters' screen you create the various branches of your bank, define their reporting hierarchy, and maintain parameters such as their names, their address of location, SWIFT, TELEX, and HOST addresses.

In this screen you can do the following:

- Create the Regional Offices and branches of your bank by assigning each a unique branch code
- Maintain the address of location of each of the branches and also their SWIFT, TELEX and HOST addresses
- Specify the Suspense GL for posting all those accounting entries for which no GL has been specified or the specified GL has been closed
- Define preferences, such as - the retention duration, a CIF number for walk-in customers and the GL for netting FX contracts
- Maintain customer number range for generation of CIF numbers for customers of your bank.

The HO creates the branches at the bank level. All subsequent modifications on the table are done from the respective branches.

4.1.1 System Features

Oracle FLEXCUBE supports a three level reporting structure.

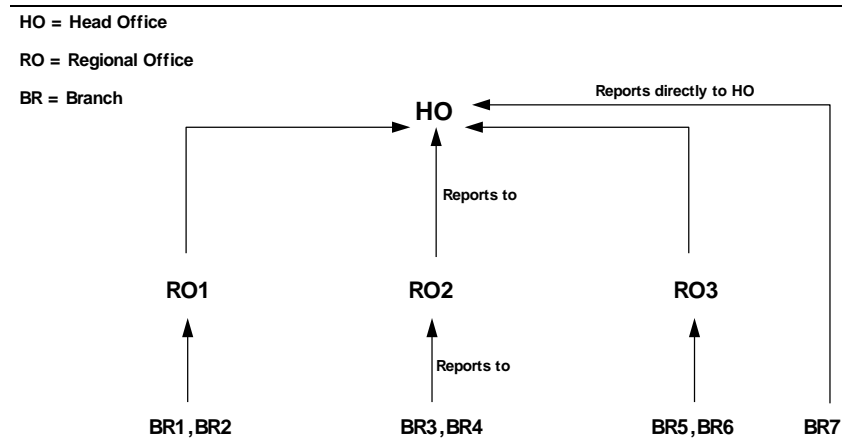

At the top stands the Head Office followed by the Regional Offices. At the lowest level are the branches. There can be any number of branches or regional offices.

The branches report to the RO; and the ROs in turn report to the HO. Within this three level structure you can also have a branch reporting independently to the Head office (as branch, BR7 in the diagram).

It is also possible to have a two level reporting structure with only the HO and the branches, where each individual branch reports directly to the HO.

4.1.2 Creating Reporting Structure

The order in which you create the HO, the ROs and the branches should follow the hierarchy. Hence, the first branch to be created should be the HO, followed by the ROs, and then the branches.

The Head Office of your bank is created during installation. You only have to create the Regional Offices and the various branches. During installation, the system automatically populates this screen with the branch code and name of your Head Office that you have specified to the CITIL implementer. The 'Parent branch' and the Regional Office fields' also default to this branch code.

To create an RO, invoke a new screen. Then, enter the code and name of the RO against 'Branch Code' and 'Name' respectively. You do not need to specify the 'Regional office' because the HO Code is the default for the field. (All ROs report to the HO).

Then create all the branches. If a branch reports to an RO, to specify that RO is the branch's 'Regional Office', select the code you want from the option list provided for this field. But before designating, you should authorize all the RO records you have created; the system will not allow you to use any unauthorized record.

(Diagrammatic Representation)

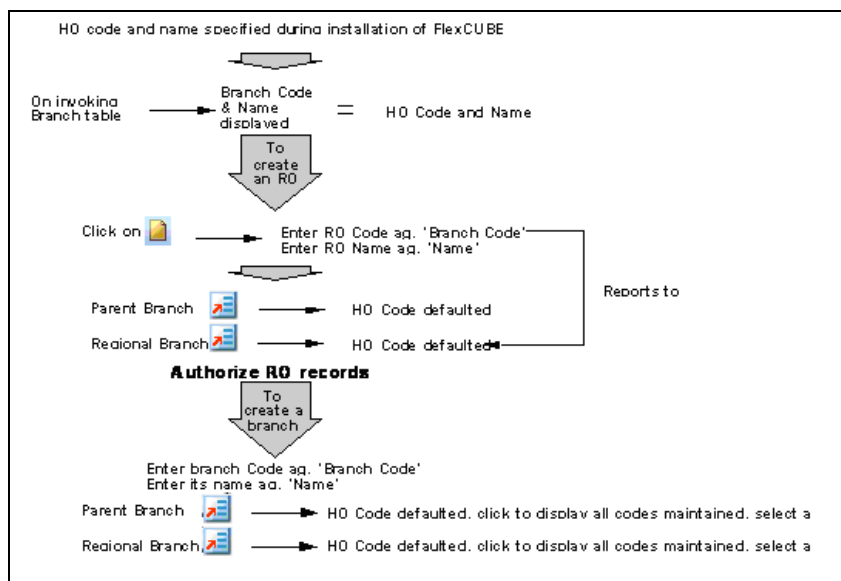

4.1.3 Basic Parameters for Branch

In Oracle FLEXCUBE, the Head Office and the Regional Offices are defined as branches. You can maintain the details of the Head Office, regional offices and branches in the 'Branch Parameters Maintenance' screen. Invoke this screen by typing 'STDBRANC' in the field at the top right corner of the Application tool bar and clicking the adjoining arrow button.

The screenshot displays the 'Branch Parameters Maintenance' web page dialog. The window title is 'Branch Parameters Maintenance -- Web Page Dialog'. The main content area is divided into several sections: 'General Details' (with sub-tabs for General and Financial), 'ATM Details', 'Address', and 'Local Payments'. The 'General Details' section includes fields for Parent Branch (CHO), Regional Office (CHO), Country Code (USA), Customer Identity, Local Currency (USD), BANK OF INDIA, United States of America, U.S.DOLLAR, External Value, Fund Branch (checkbox), EOC Status (N), Time Level (0), Time Zone Offset (Hours: 4, Minutes: 30, Ahead checkbox), ATM Details (ATM Branch, Institution Identification, Inter Branch Transaction Code, Customer Transfer checkbox), CutOff Offset Time (Hours: 4, Minutes: 30), Local Payments (Clearing Branch * CHO), Address (Branch Address * #21 LINCOLN HIGHWAY, WASHINGTON, USA), BIC (AMBKWASH), Telex (AMBKWV), and Host Name (FCKERNEL.WORLD). The bottom of the window has tabs for Preferences, SWIFT Address, Account Mask, CIF Range, GI Functions, Tax, Branch Currency, and UDF. The status bar shows input by VEENAAUTH, date/time 7/3/2000 15:36:45, modification number 1, and buttons for Open and Authorized.

You can specify the following details here:

Branch Code

This is the code you assign to the office or branch. The code acts as an identifier in the system for the office / branch. Input a code using a maximum of 3 characters, alphanumeric.

Branch Name

This is the name of the office or branch, the code of which is input. Enter the name using a max. Of 35 characters, alphanumeric

Branch Available

The system displays the Branch Available status. If the status is 'Yes', it indicates that the branch can accept transactions for the day and if the status is 'No', then it indicates that the transactions will be accepted but it will be in effect only from the next business day.

Accordingly accounting entries will be passed checking the following, for tanking branch transactions:

- The Branch Available Status
- The Branch date and host date i.e. entries will be tanked if branch date is ahead of host date

When the Branch Available status is 'NO' or if branch date is ahead of host date, then the transactions will be tanked. These transactions will be untanked by the BOD program which runs post date change i.e. POSTDTCH.



If you want to check whether the transaction is tanked or not, you should login to host and refer to the corresponding query function.

For more information on 'Querying the Transactions' refer Retail Teller, Clearing and Utility Payment Chapters under Oracle FLEXCUBE host module.

4.1.4 Maintaining General Details for Branch

You can maintain the branch details regarding the local currency, the parent branch, regional office of the branch, address details including telex, BIC etc.

Local Currency

Specify the currency of operation for your branch and the default currency for all transactions of your branch. The income and expense balances of your branch will also be maintained in this currency.

Parent Branch

Parent Branch is to define an alternate reporting line, other than the three level HO-RO-Branch structure. The 'Parent' for all the branches you create is the HO code (default). To specify the Parent, other than the HO, select from the options displayed. The name of the parent branch is displayed alongside.

Regional Office

This is the branch code of the Head Office or Regional Office to which the branch (whose code is input eg. Branch Code) reports.

For a Head Office or a Regional office, this code should be the Head Office branch code, which is also the default for this field. For the branches, specify that branch as the RO, to which the branch reports. Select from the list of options displayed.

Country Code

Specify the code of the country in which the branch operates. Select from the options provided in the pick list

Customer Identity

Specify the customer's identity

4.1.4.1 Specifying ATM Details

Specify the following details

ATM Branch

Specify the ATM branch

Institution Identification

Your bank may have a branch or multiple branches for different countries. You have to capture the identification code that uniquely identifies your bank branch in the ATM transactions interchange environment. Specify a code to identify the institution. This institution ID will help identify whether a particular transaction has been sent from an external network or whether it has originated from your bank branch.

Inter Branch Transaction Code

You can specify the Transaction Code through which accounting entries for inter-branch transactions should be settled.

Customer Transfer

Check this option to indicate that transfer transaction should be permitted through the ATM

4.1.4.2 Specifying Address Details

For each branch of your bank you maintain the following parameters:

Branch Address

Input the address of location of the branch. Each line can have a maximum of 35 characters

BIC

Input the SWIFT address for a branch using 8 or 11 characters, alphanumeric

Telex

Specify the branch's TELEX address, using a maximum of 14 characters, alphanumeric

Host Name

Against 'HOST' enter the name of the Host server for this branch, in not more than 35 characters, alphanumeric

Time Level

In this field is displayed the system time level status, represented by a number between 0 and 9

In Oracle FLEXCUBE, user access to the system can be controlled by assigning each user and the system, a time level. Both the system and the users are set to different time levels. Only those users who have a time level equal to or greater than the system time level can log into the system.

A control clerk, during the EOC process, does the change in time level status

Fund Branch

Even though the fund and the bank are in the same database, the fund is treated as a different legal entity and as such the books of the fund are maintained separately from those of the bank. Funds are created in a separate branch and any transaction initiated in the fund branch belongs to a fund. Check this box to indicate that the branch you are maintaining if is a fund branch. Since the fund is a different legal entity, it should not be possible to initiate inter-branch accounting entries from the fund branch.

Any settlement with an external entity is routed through the normal settlements interface. In order to facilitate this, all the account fields in the system accept only the accounts in the transaction branch, if the branch happens to be a fund branch.

External Value

Specify the name of the branch as maintained in an external system. This value can be used to interface with the external system.

EOC Status

Under EOC status one of the following alphabets will be displayed which stand for the following:

B - Beginning of financial input; indicates system transactions in progress

I -- Indicates that user transactions are in progress

T-- End of user transaction input; indicates system transactions in progress

F -- End of financial input; system transactions also completed

E -- End of Day, Branch awaiting date change

The values are updated by EOC process.

4.1.4.3 Specifying Time Zone Offset

For branches with different time zones, you can define the offset time that is to be displayed in maker/checker stamp and all the reports generated for the branch.

The offset time is specified in terms of hours and minutes, and the time will be added/subtracted from the Server Time maintained for the bank.

Hours

Specify the number of hours to be offset from Server Time to arrive at the local branch time

This is the number of hours by which the branch leads or lags behind the Server Time

Minutes

Indicate the additional minutes by which the branch leads or lags behind the Server Time



The reference of time is always the System Time (Server Time)

Ahead

The system calculates the local time of the Branch by adding/subtracting the Server Time and the Time Zone Offset time. When you maintain the offset time for the time zone, you need to specify whether the system should add or subtract the offset time from the Time Zone Offset.

Checking the Ahead box indicates that the offset time is added to the Server Time. Consequently, if the box is unchecked, the offset time is subtracted from the Server Time.

Additionally, the system validates the cutoff time depending on the time you specify here. The validation is based on following 3 parameters:

- Cutoff Time maintained for the currency in Currency Definition Screen
- Cutoff Offset Time maintained for the Branch in Branch Parameters Screen
- Time Zone Offset maintained for Branch in Branch Parameters Screen

4.1.4.4 Indicating Cutoff Offset Time

When defining a currency, you can indicate a cut-off time for the currency. If your bank operates in branches located in different time zones, the cut-off time maintained for the bank will not be applicable across branches.

Therefore, you can set up an offset time for your branch based on the cut-off time set for the bank. You can specify an offset time for your branch in the Branch Parameters screen.

Hours & Minutes

The offset time is expressed in hours and minutes. The time you specify here is added or subtracted from the cut-off time maintained for the bank. This depends on the time difference between your branch and the Head Office.

The following example demonstrates time zone offset time and cutoff offset time:

Assume:

Head Office: '000'

Branch: 'XYZ'

'000' and 'XYZ' are located in places falling under different Time Zones.

For '000', 'Cut Off Time' for Currency 'INR' (specified in Currency Definition Detailed Screen) is 18.00 Hrs.

In the 'Branch Parameters - Detail View' for 'XYZ' suppose the 'CutOff Offset Time' is maintained as 2 Hrs, then 'Cut Off Time' for Currency 'INR' for Branch 'XYZ' will be 18.00 + 2.00 = 20.00 Hrs.

In the 'Branch Parameters - Detail View' for 'XYZ' suppose the 'Time Zone Offset' is maintained as 1 Hr and 30 Minutes (and 'Ahead' box is checked). Then if the 'Server Time' is 15.00 Hrs, then 'Local Time of 'XYZ' will be 15.00 + 1.30 = 16.30 Hrs.

If an FT Contract is booked in 'INR' from the Branch "XYZ" @ < 20.00 Hrs, then the system does not display the Override Message – 'The cut off time has been exceeded'.

If the FT Contract is booked in 'INR' from the Branch "XYZ" @ > 20.00 Hrs, then the system displays the Override Message - "The cut off time has been exceeded."

4.1.5 Maintaining Financial Details for Branch

You can specify the details regarding suspense GLs, Financial cycle, preference for floating rate, message generation (103,103+) for the branch in this screen. The screen appears as shown below:

4.1.6 Specifying Suspense GL

The accounting entries generated by different modules of Oracle FLEXCUBE will be passed into the specified 'Suspense GL' account if:

- The GL into which the entries are to be passed is not defined, or

- If the GL has been closed

Suspense GLs are of two types:

Real Suspense GL (Local and Foreign Currency)

The accounting entries that belong to asset, liability, income or expense GL categories will be passed to the 'Real suspense GL'. To indicate the real suspense GL for a branch, click option list and select a GL code from the option list.

Contingent Suspense GL (Local and Foreign Currency)

The accounting entries that belong to contingent asset or contingent liability GL categories will be posted to a 'Contingent Suspense GL'.

To indicate the contingent suspense GL for a branch, click option list and select a GL code from the option list.

4.1.6.1 Specifying Euro Redenomination GL

To facilitate the currency conversion process, you have to maintain a common Conversion GL and a Transaction Code.

The conversion GL that you specify in this screen will be identified as the common suspense GL for all balance conversions while re-denominating the currency of an account either for specific customers or for generic conversions.

In addition to the conversion GL you have to indicate a Transaction Code, which identifies conversion, related entries.

4.1.6.2 Indicating Payment Messages

Generate 103

As a branch level parameter, you have to indicate whether your customers can receive MT 103 as payment messages. Check the box positioned next to the Generate MT103 field to indicate that the customers of your branch are capacitated to receive payment messages in the MT 103 format. If you leave this box unchecked, the system will automatically send all payment messages to the counterparty bank in the MT 100 format.

Generate 103+

The 'Generate MT 103 + option' allows you to generate outgoing MT 103 messages in the MT 103 + format. This check box can be enabled only if you have enabled the generation of MT 103 messages as Payment Messages.



Note the following:

- The system will generate MT 103 messages as payment messages for transactions in the branch, and generate them in the MT 103 + format only if you have enabled this option in the following cases:
 - For the counterparty of the transaction, in the BIC Code Maintenance
 - By choosing the Generate 103+ option for currency in the Currency Definition
 - For the product used by the transaction, in the Product Preferences
- The system is also capable of processing incoming MT 103 messages in the MT 103 + format. During the upload process the system considers an MT 103 payment message to be of MT 103 + Format based on the presence of the STP code in the 119 field. Field 119 is present in the third block of the message i.e., {3: {119:STP}}.

Branch Code for Clearing

Indicate the code that identifies your branch in the Clearing Network. The code you specify for your branch should be the same as that defined in the Clearing Bank Code Maintenance screen.

Clearing Through Branch

If clearing transactions involving your branch are routed through another branch, specify the Oracle FLEXCUBE branch code of that branch in this field.

On the basis of the Routing Number Mask defined for your bank, and your specifications in this screen, Oracle FLEXCUBE automatically generates the Routing Number for clearing transactions involving your branch in the Routing Number field.

Loan Direct Debit Generation Days

Loan DD Generation days specifies the number of days before the schedule payment date, when a Direct Debit Contract is generated for the schedule due. This is applicable only for Loan Contracts in the local currency.

In order to facilitate the processing of loan repayments by customers who have their current or settlement accounts in some other bank of the clearing network you can initiate Direct Debits to these accounts. When a payment is due on a loan, a direct debit is generated 'Loan DD Generation Days' before the payment date.

As a result in Oracle FLEXCUBE the following entries will be passed:

Dr	Clearing suspense
Cr	Dummy Settlement Account

During liquidation which is performed on the schedule date the entries passed are as follows:

Dr	Dummy Settlement Account
Cr	Loan Asset GL / Interest Income GL

Refer the 'Maintaining the attributes specific to PC products' chapter of the PC manual along with the Branch Parameters section of the Core Services Manual for details on processing DDs originating from a Loan.

4.1.6.3 Indicating Financial Cycle

Current Cycle

This is the code for the current financial year as defined by you in the 'Period Code' screen.

Current Period

Each financial year is divided into accounting periods called 'Period Codes' defined in the 'Period Code Maintenance' Screen (for details refer 'period Code screen'). The current accounting period of the financial year is displayed in this field.

4.1.6.4 Specifying Referral Cut-off Time

Referral refers to the process of handling customer transactions that force the accounts involved in such transaction to exceed the overdraft limit. Examples of typical transactions, which force an account to move into overdraft, are Payment and Collections, Funds Transfers, Standing Instructions or Clearing transactions. If an account is marked for referral, the details of transactions resulting in the account moving into Overdraft will be sent to the referral queue.

Hours & Minutes

In branch parameter, you have to specify the referral cut-off time for accepting / rejecting transactions in the referral queue.

In case a transaction is rejected from the referral queue after the cut-off time then system displays the following override message:

'Rejected after cut off time'



Transactions are accepted into the Referral Queue even after cut-off time if account goes into overdraft.

Auto Authorisation

Oracle FLEXCUBE enables you to allow certain users (of your choice, depending on your requirements at your installation) to automatically authorize transactions.

To indicate applicability of automatic authorization for users of the branch, you must enable the Auto Authorization option in the Branch Parameters screen. When you do, you can then allow automatic authorization rights to the appropriate users at the branch.

For more details about automatic authorization, refer the Security Management System and Procedures user manuals.

Deferred Statement Status

This is a display field. This field indicates whether or not the Branch is ready for Deferred Statement Generation. 'Y' indicates the Branch is ready for deferred statement generation.

For further details on Referrals refer to the Processing Referrals in Oracle FLEXCUBE chapter of the Core Entities manual.

Install

Select the appropriate value from the drop-down list to indicate whether Oracle FLEXCUBE installation is complete or incomplete.

Proceed Without Maintaining Floating Rate

Check this option to indicate that floating rates should be propagated across all branches,

Sector code

Specify the Sector Code of your branch, as specified in the Clearing Bank Code Maintenance screen.

Routing No

On the basis of the Routing Number Mask defined for your bank, and your specifications in this screen for clearing and sector, Oracle FLEXCUBE automatically generates the Routing Number for clearing transactions involving your branch in the Routing Number field.

4.1.7 Maintaining SWIFT Address for Branch

Click the 'SWIFT Address' in the Branch Parameters screen to invoke 'Additional SWIFT Address' screen.

The screen appears as shown below:

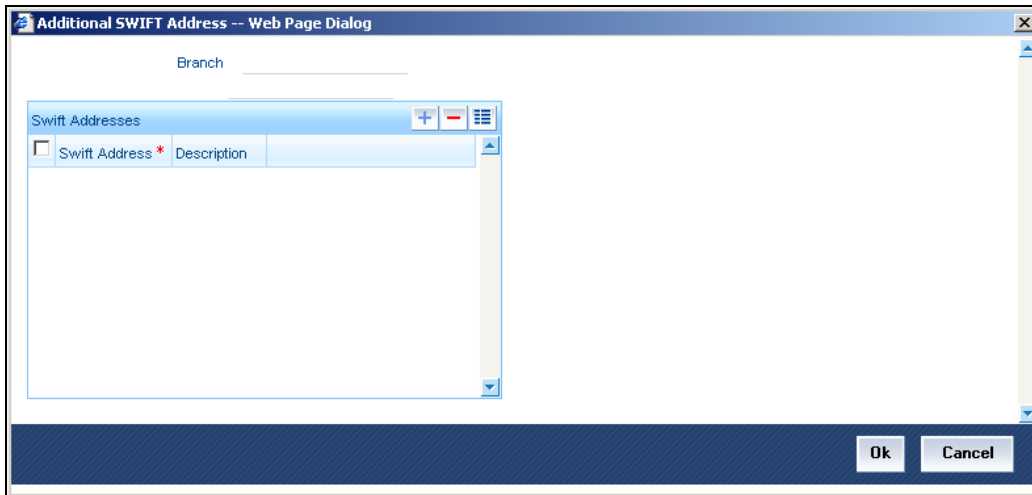

You can specify the SWIFT addresses related to the branch in this screen.

4.1.8 Defining Account Mask

Customer Account Masks can be defined at the Branch Level or at the Bank Level

Click the 'Account Mask' in the Branch Parameters screen to invoke 'Account Parameters' screen.

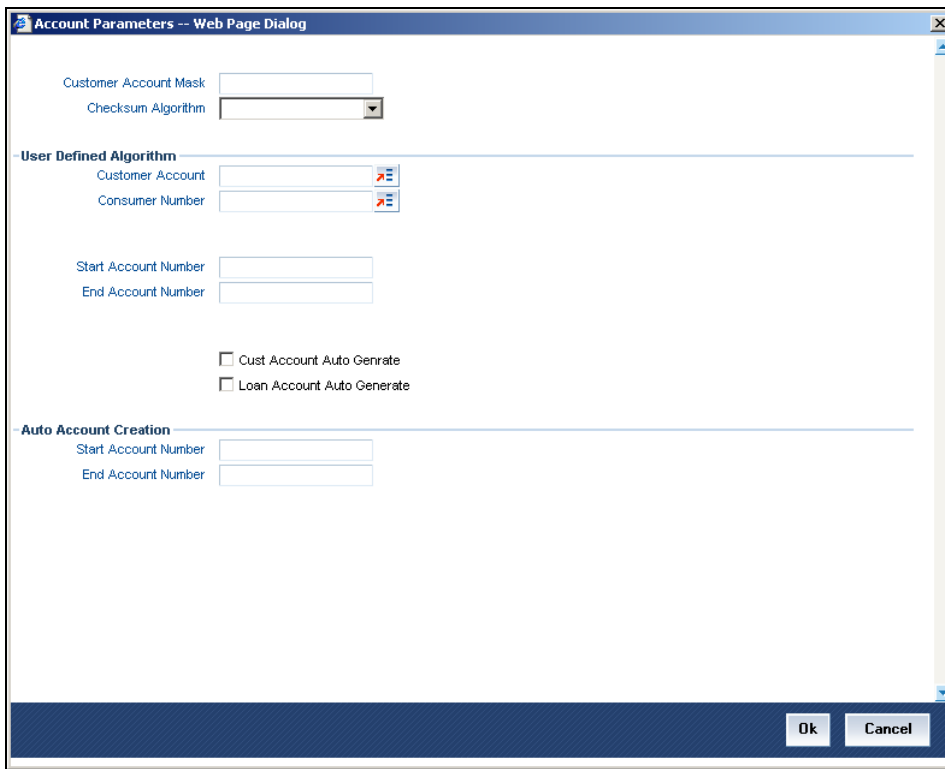

For further details please refer the Section 'Specifying the Account generation Parameters at bank level' under Bank Parameters

4.1.9 **Maintaining Customer Number Range**

You can specify a number range based on which the customers of your bank will be assigned CIF numbers for identification. Since the number range is maintained at the branch level, you can specify different number ranges for different branches of your bank.

To maintain the number range, click the 'CIF Range' in the Branch Parameters screen. The 'Customer Number Range' screen is displayed:

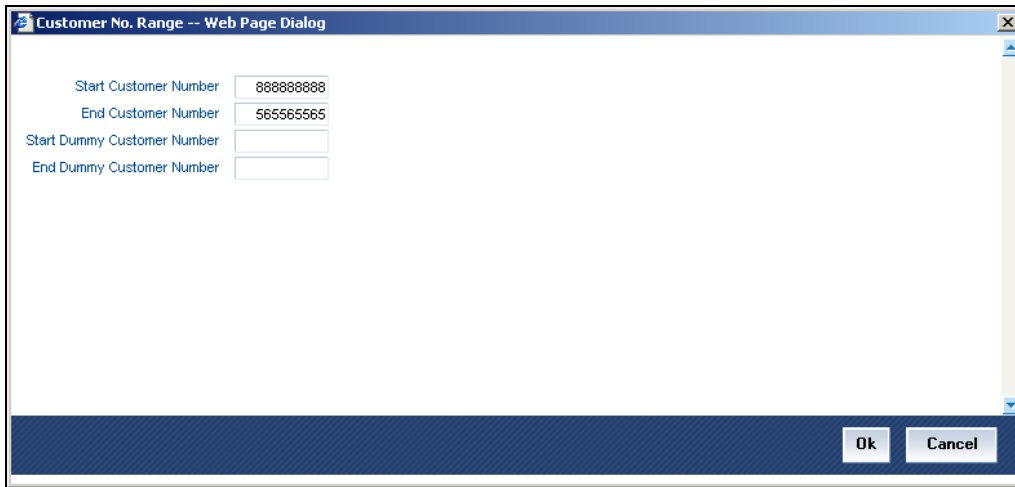

The screenshot shows a web page dialog titled "Customer No. Range -- Web Page Dialog". It contains four input fields for specifying customer number ranges. The "Start Customer Number" field is populated with "888888888" and the "End Customer Number" field is populated with "565565565". The "Start Dummy Customer Number" and "End Dummy Customer Number" fields are currently empty. At the bottom right of the dialog, there are "Ok" and "Cancel" buttons.

Specify the following in this screen:

Start Customer No.

This number is the basis on which the system generates the CIF numbers for customers of your branch.

The CIF number generation is determined by the following details:

- The CIF mask maintained in the Bank-Wide Parameters screen. Assume that the mask is 'bbbnnnnn' (where 'bbb' represents a 3-digit branch code and 'nnnnn' is a 6-digit number).
- The start customer no – assume that this number is 100

While generating CIF numbers, the system will automatically assign the number '00000100' to the first customer of your branch, assuming that the branch code is 000. This conforms to the CIF mask maintained for the bank. The next customer will be '00000101' and so on.

If the option 'Auto Generate CIF Numbers' is checked in the 'Bank Parameter Preferences' screen and the start CIF is zero or null, the new customer number will be generated for the branch as per the current running sequence number of the Head Office.

End Customer No

Just as you specify a Start Customer Number, you have to indicate the End Customer Number also. You will not be allowed to maintain customers beyond this range.

Let us assume that the 'End Customer No.' is 99999. As per the mask and the end number, the last customer CIF number that is generated at your branch will be '000099999'.

Start Dummy Customer Number & End Dummy Customer Number

You should also maintain a dummy customer number range in this screen. When maintaining a dummy range, you should ensure that dummy CIFs and the actual range do not overlap with one another.

The dummy CIF range will be used for account number generation. As explained earlier, the account number can be generated based on the following account mask:

'bbbTZCCCCCSd'

Where,

- bbb – is the branch code
- T – indicates the account code
- Z – is the currency type
- CCCCCC – is the CIF number of the customer
- S – is the sequence number for a combination of account code, currency type and customer
- d – is the control number generated by 'Modulo 11 with Weights' algorithm (explained earlier)

To recall, the sequence number that is automatically generated by the system is for an account code + currency type + customer combination. The sequence number is a single digit number (from 1 to 9). This means that, for the same combination, you will be allowed to maintain only nine accounts. To eliminate this limitation and to allow maintenance of more than nine accounts for the same combination, the dummy customer number range will be utilized. This is explained with the help of an example.

Example

Assume that you have maintained the following CIF range for your branch:

Start CIF No.	100000
End CIF No.	198999
Start Dummy No.	199000
End Dummy No.	199999

Ms. Jennifer approaches your bank to open a savings account in your branch (branch code is '000'). Further, the CIF and account number masks maintained for the branch are 'bbbnnnnn' and 'bbbTZCCCCCSd' respectively.

As per the CIF mask, Ms. Jennifer is assigned the CIF number: 000123456. According to the account number mask, the 6th to 12th digits will be the last six digits of the CIF number, which is '123456'.

The account number of the first savings account, in USD opened for Ms. Jennifer is: 000411234561 (we will consider only 12-digits for this example since the 13th digit is auto generated by the system based on Modulo 11 with Weights algorithm).

The components of the account number **000-4-1-123456-1** are as follows:

- 000 – is the branch code
- 4 – is the account code
- 1 – is the currency type
- 123456 – is the CIF number for Ms. Jennifer
- 1 – is the sequence number for the combination of account code, currency type and customer i.e. the number '4-1-123456' will be common for the first 9 accounts maintained for the same combination.

Now, Jennifer decides to open another account for the same combination. In this case, the sequence number gets incremented to 2 and the account will be assigned the number: **000-4-1-123456-2**.

This will go on till the 9th account for the same combination. The 9th account number would be **000-4-1-123456-9**.

If the customer decides to maintain the 10th account for the same combination, the sequence number will restart since it has reached the maximum allowed level. This would result in duplication of account numbers. To eliminate this, the system will now use the dummy CIF range to number the accounts.

Therefore, the 10th account number will be: **000-4-1-199000-1**. This sequence will continue for subsequent accounts maintained for the same combination.



You can view all the dummy CIF numbers linked to a customer in the 'Customer Accounts – Allocated Dummy CIF' screen.

4.1.10 Maintaining Global Interdict Functions

Click 'GI Functions' button in the Branch Parameters Maintenance screen to invoke 'Branch Global Interdict Functions' screen.

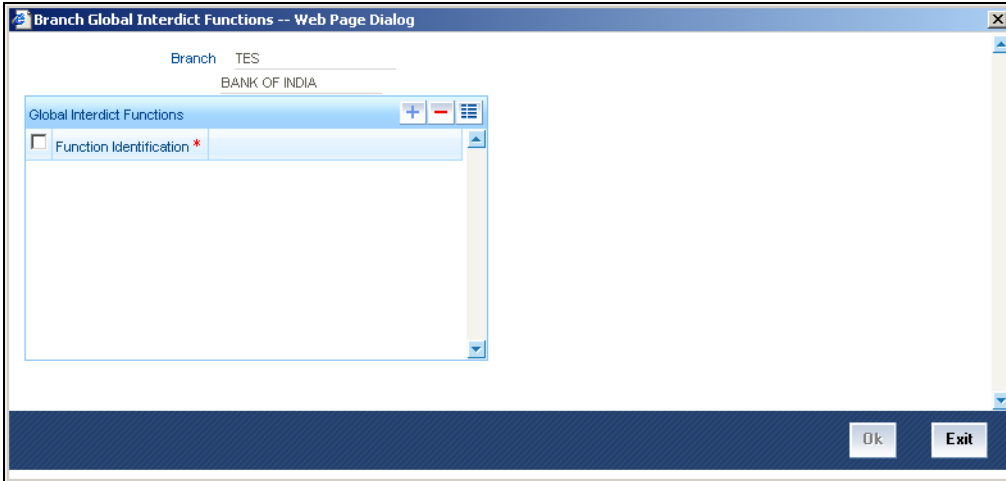

4.1.11 Maintaining Preferences

To specify your preferences, click 'Preferences' button from the Branch-wide parameters screen. The 'Preferences' screen is displayed.

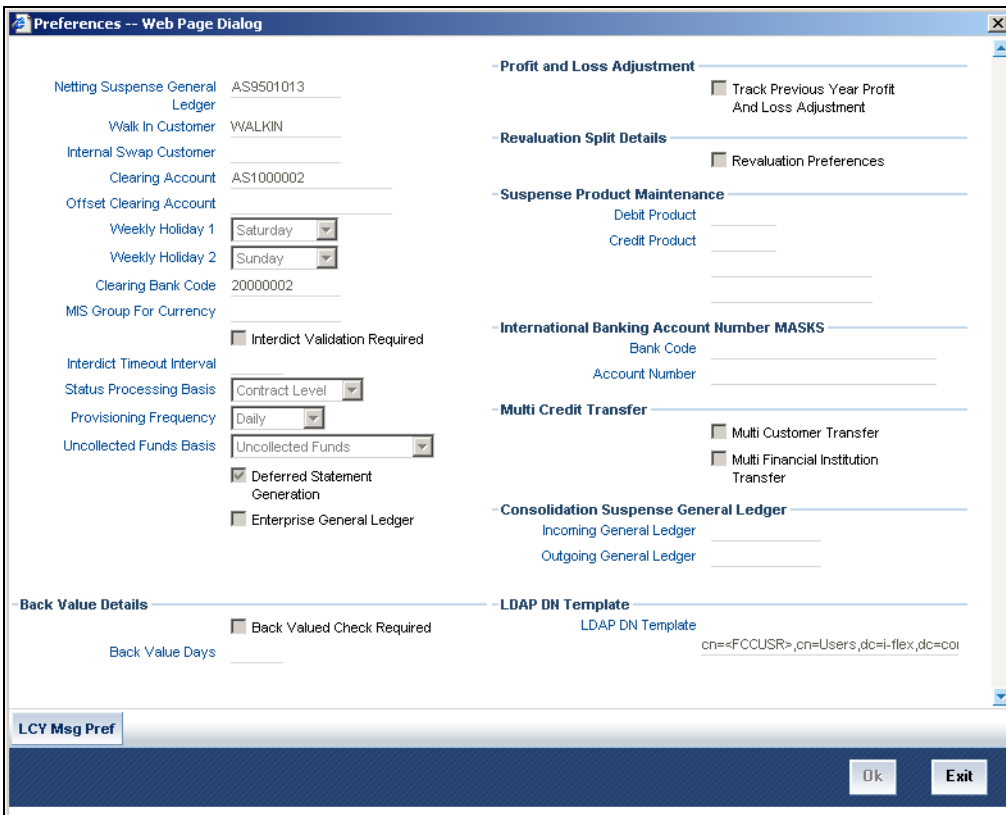

In this screen you define the following preferences:

- The netting suspense GL into which settlement entries for netted FX Contracts should be posted
- The CIF Number against which all Walk in customers should be identified
- The format in which the IBAN Account Number and the Bank Code should be captured
- The duration for which spool files should be stored in the spool file directory
- The directory into which the files should be spooled
- MIS codes for posting of automatic balancing entries

These details can be maintained by the respective branches. For a branch you maintain the following, in the 'Preferences' screen:

Netting Suspense GL

All settlement accounting entries relating to a netted FX contract, is passed into the specified 'Netting suspense GL'. The net amount of the settlement is transferred through the Nostro accounts. . For instance, let us take the following two outstanding contracts entered into by bank A; both settling on January 10, 1998:

- Bought from bank B 1 Million USD in exchange for 35 Million INR
- Sold to bank B 1/2 million USD in exchange for 18 million INR

The above contracts can be settled in either of the two ways given below, on the settlement date:

- Settle both contracts separately
- Net the settlements of the two contracts

If your bank has a netting agreement with the counterparty, the settlement entries are posted to this 'Netting suspense GL' and the net amounts are settled through the nostros.

Walk in Customer

For your branch you can create a walk in customer ID against which you track all those customers who do not hold a regular account with your bank but have approached the bank for a transaction, say, for encashment of traveler's checks or for manager's checks.

Internal Swap Customer

You need to specify an internal swap customer for processing internal swaps. The names of all the customers of your bank will be displayed in the option-list provided. This will be a unique customer meant for processing internal swaps.

Clearing Account

Specify the default GL account to be used for clearing transactions at the branch.

Offset Clearing Account

Specify the default offset GL account to be used for clearing transactions at the branch.

Weekly Holiday 1 & 2

Using this option you can indicate the holiday in a week for your branch. You can select the day for holiday from dropdown list. If you want to set only one holiday in a week for your branch, select the day for Weekly Holiday 1 and leave Weekly Holiday 2 Blank. If you want to opt for two holidays in a week, select the days for Weekly Holiday 1 & Weekly Holiday 2.

Clearing Bank Code

Specify the code by which your bank is identified in the Clearing Network you participate in. This has to be the same as that specified for your bank in the Clearing Bank Code Maintenance screen.

MIS Group for Currency (Mismatch Entries)

If the posting of automatic balancing entries due to currency and value date mismatches has been specified for your bank, you can specify the MIS codes or groups to be used for posting the balancing entries.

Interdict Validation Required

For your branch you need to indicate whether Interdict Validation is required for all Customers, Customer Accounts, Funds Transfers, Standing Instructions, Foreign Exchange, Letter of Credit and DD transaction processed within your branch.

The options available are:

- Yes – the details of CIFs and Customer Accounts, captured in the specific branch of your bank will be sent to the GI system as and when they are captured in Oracle FLEXCUBE.
- No – the details maintained in the specific branch will not be sent to the GI system for online verification.

Interdict Timeout Interval

If you indicate that the details should be sent to the GI system, you will also have to specify the interdict timeout interval period. If the response time from the GI system takes longer than the time that you specify in this field, the transaction will be timed out since the processing time exceeds the time stipulated in this field.

If you enable this preference, you will have to identify the Code or ID of the function in Oracle FLEXCUBE for which such a validation should be performed by clicking on the 'GI' button in the Branch Parameters screen.

For more details, refer 'Global Interdict Interface' user manual.

Status Processing Basis

In the Branch Parameters, you can indicate the basis upon which status processing must be done at the branch, for customer accounts as well as loan contracts.

Status processing can be done either at an individual contract / account level, or at a Group / CIF level.

If you opt for Group / CIF -level processing, it is done in two stages:

- The worst status among all contracts and accounts under a specific customer group or CIF is arrived at
- All accounts and contracts involving the customer group or CIF are then moved to the worst status that was arrived at

If you opt for status processing at individual contract / account level, the status of each contract or account would be assigned according to the status processing parameters that are operative for the contract or account.

For details about loan status processing and provisioning, consult the Loans user manual and the Core Entities user manual.

Provisioning Frequency

Provision processing depends upon status processing for accounts and contracts. The provisioning batch process executes after the status processing batch. If status processing is indicated to be processed at group / CIF level, you can indicate the frequency at which the provisioning batch is to be executed for your branch. The frequency options available are daily and monthly.

For details about loan status processing and provisioning, consult the Loans user manual and the Core Entities user manual.

(Withdrawable) Uncollected Funds Basis

You can define how the System enforces the allowable amount of uncollected funds (on an account) that can be withdrawn within a business day.

For each customer account, you designate a limit on the amount of uncollected funds that can be withdrawn (the Uncollected Funds Limit). You can also indicate whether, for a given business day, the System should consider the uncollected funds that are allowed to be withdrawn as:

- The funds scheduled to be released on the current date (today), OR,
- The total uncollected funds available against the account subject to the Uncollected Funds Limit

You can specify your preference by choosing any of the following options:

- **Uncollected Funds** : If you select this option, an amount up to or less than the uncollected funds limit defined for the account, is allowed to be withdrawn, on a given business day.
- **Uncollected Funds Available Same Day**: If you select this option, the funds allowed to be withdrawn against uncollected funds on a given business day are the funds scheduled to be released on the current date (today).

Deferred Statement Generation

Check this option to stop the automatic account statement generation at end of day.

If this option is checked, then the account statement generation will be deferred to whenever you initiate action for executing Batch Operations for statement generation. You can do this through the Branch Statement Status Change screen.

Enterprise GL

Check this option if this branch needs to have an enterprise GL hand-off. Once checked the system will identify the said branch for creating an ASCII hand-off file containing the relevant accounting entries to be sent to the external enterprise GL.

4.1.11.1 Specifying Back-Valued Details

For your branch you can specify the maximum period up to which back valued posting can be processed. This restriction can be made applicable by specifying the following preferences:

Back Value Check Required

It is used to indicate whether all back-valued transactions should be validated against a specific period.

Back Value Days

If you enable the Back Value Check Required option, you must indicate the number of calendar days up to which back-valued transactions can be allowed. During transaction processing you will be allowed to post back-valued transactions up to the specified date in the past (no check will be done). Further, if the option is checked but you have not maintained the 'Back Value Days' (maintained as NULL), the system will interpret it to be 'Zero' days allowed (for back valued transactions).

The restriction for the maximum period up to which back-valued posting can be allowed, will be made on transactions processed in following modules:

- Payment and collections
- Data Entry
- Retail Teller
- Utility Payments
- Foreign Exchange
- Money Market
- Expense Processing
- Fund Transfer
- Loans and Deposits

While saving transactions pertaining to any of these modules the System validates the Value Date of the contract to check whether it adheres to the restriction. You will be intimated with an override if the Value Date is earlier than the specified period. This restriction is made applicable on all uploads as well.

Refer the Contract Processing chapter of the individual modules for additional information.

4.1.11.2 Indicating Profit and Loss Adjustment

Track Previous Year Profit and Loss Adjustment

You can collect data pertaining to the unrealized income booked for each contract during the year by triggering the Year-end batch process. But, you will be allowed to trigger the batch process for splitting the unrealized profit and loss for the previous year and the current year only if you have specified this (Track PY PnL Adjustment) as a preferred option for your branch.

If you set this preference, the data pertaining to the unrealized income is collected at contract level for the following modules:

- Securities - Unrealized Interest, Discount and Premium accrued for the year.
- Derivatives - unrealized income
- Bills and Collections - unrealized income
- Letters of Credit - unrealized income
- Money Markets - unrealized income

4.1.11.3 Indicating Revaluation Split Details

Revaluation Split Required

You can choose to break-up revaluation profit/loss into:

- Trading P&L – P&L due to revaluation of foreign currency transactions during the day
- Revaluation P&L – P&L due to revaluation of opening balances (balances without current day's turnover)

If you enable this preference, all GLs which are marked for revaluation split will have their revaluation profit/loss broken up into trading and revaluation P & L for entries posted from this branch.

For further details on Split Revaluation refer the GL user manual.

4.1.11.4 Specifying International Banking Account Number MASKS

The IBAN or International Bank Account Number is a unique account number that is used to identify a customer's account in a financial institution internationally.

International Bank Account Numbers in your bank are generated in the format of the account mask that you specify in the Branch Parameters screen. Therefore, you have to first define IBAN masks.

The IBAN Mask

Since IBANs should be maintained in a particular format you should first define the format in which the IBAN should be captured. You should also indicate the format in which the bank code of the bank in which the account resides should be maintained.

The maximum length of an IBAN should be 34 characters. The IBANK Mask should be a combination of the following parameters:

- An **ISO Country Code**, which has a maximum length of two characters. The identifier that you can use to indicate the country code is DD. The identifier will be replaced by the actual country code while defining the account number. For instance, you will replace DD with PL for Poland, US for the United States and so on.
- A **Check Digit Number** calculated according to an ISO Standard algorithm, using the Country Code, Bank Code and Account Number combination. Since this is a two-digit number you can use the identifier CC to specify this algorithm. The system arrives at and replaces this identifier with the actual check-digit based on the Country Code, Bank Code and Account Number combination.
- The **Bank Code** of the bank where the IBAN resides. This code is assigned to the respective Bank by its national bank. There are no individual restrictions on the length of Bank Code and Account Number. However, the combined length of the Bank Code and Account Number should not exceed 30 characters. You can use the identifiers **a** (for alphabets) and **n** (for numerals) as the identifiers to capture the length of the bank code.
- The **Account Number** of the customer account. The bank in which the customer account resides assigns this number. You can use the identifiers **a** (for alphabets) and **n** (for numerals) as the identifiers to capture the length of the account number.



Suppose that you maintain an IBAN mask in the following format:

DDCCaaaaaaaaannnnnnnaaaaaannnnnnnnn

While capturing the IAB number you have to strictly adhere to the format mentioned above.

USccCHASEBANK000101CBNYLI450000026

In place of the 'cc's the system will generate the check digit algorithm based on the Country Code, Bank Code and Account Number combination.

The Bank Code Mask

After indicating the IBAN mask you have to specify the mask for the Bank Code. The Bank Code mask is a combination of alphabets and numerals. Therefore you can specify **A** and **N** as the identifiers. Subsequently, while capturing the bank code in the IBAN screen each of these characters will be replaced with the respective alphabet or numeral. For instance, let us assume that you have maintained a 15-character mask for the Bank Code:

A	A	A	A	A	A	A	A	A	A	N	N	N	N	N	N
---	---	---	---	---	---	---	---	---	---	---	---	---	---	---	---

You will have to capture the corresponding bank code in the same format:

C	H	A	S	E	B	A	N	K	0	0	0	1	0	1
---	---	---	---	---	---	---	---	---	---	---	---	---	---	---

 The combined length of the Bank Code and Account Number should not exceed 30 characters.

4.1.11.5 Indicating Multi Credit Transfer

Multi Customer Transfer

This option indicates whether or not the branch is Multiple Customer credit transfer compatible.

Multi Financial Institution Transfer

Enable this option to indicate that your branch is Multi Financial Institution Transfer compatible.

4.1.11.6 Specifying Consolidation Suspense General Ledger

Incoming GL

If your branch is Multi Customer Transfer or Multi Financial Transfer or both enabled, you have to mandatorily choose the incoming GL, which will be the bridge GL for all incoming MT102 and MT 203 type of transfers.

Outgoing GL

If your branch is Multi Customer Transfer or Multi Financial Transfer or both enabled, you have to mandatorily choose the outgoing GL, which will be the bridge GL for all outgoing MT102 and outgoing MT 203 type of transfers.

LDAP DN Template

The LDAP DN template needs to be maintained here for each branch. This is used in Oracle FLEXCUBE user maintenance form to populate corresponding LDAP user-id automatically from the template.

4.1.12 Maintaining LCY Message Preference for Branch

Click the 'LCY Msg Pref' button in the Preferences screen to invoke the 'LCY Message Preference' screen.

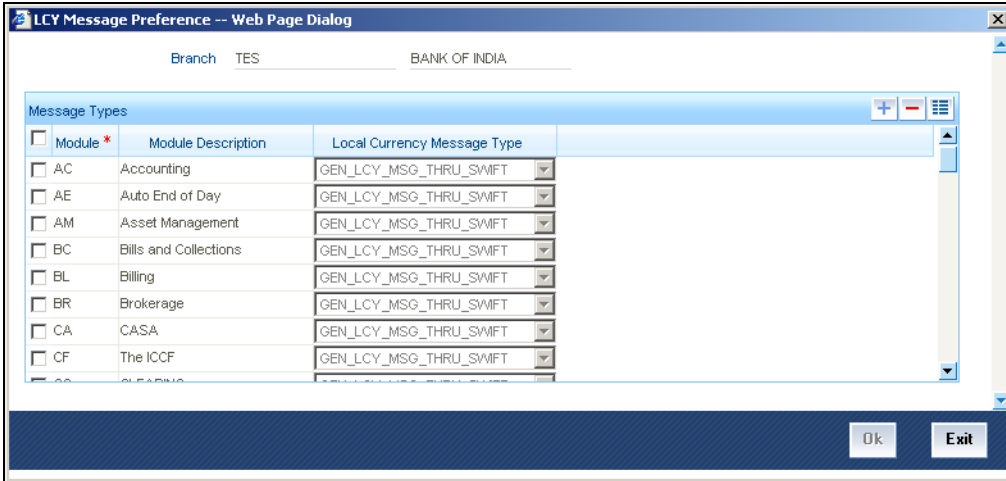

4.2 Maintaining Value Date Spread for Branch

The Branch Value Date Spread refers to the number of days that should be applied to transfers with a value date that is later than the effective cut-off date. You can maintain value date spread details in the 'Value Date Spread' screen. Invoke this screen by typing 'CYDVDSRP' in the field at the top right corner of the Application tool bar and clicking the adjoining arrow button.

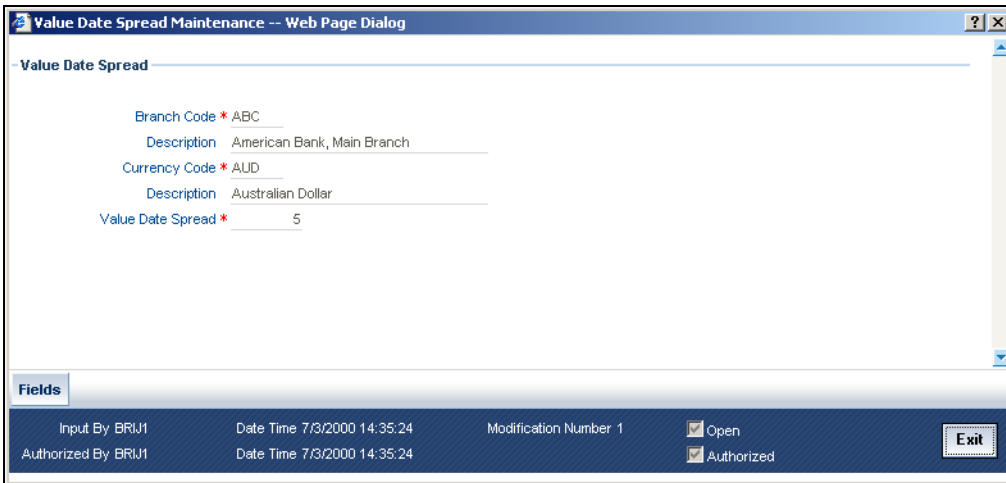

The Value Date Spread is maintained for a Branch + Currency combination. You can select a branch and currency code from the option list available. The spread should be expressed in calendar days and is applicable only to outgoing funds transfers.

All outgoing funds transfers should be generated earlier than the cut-off time maintained for the currency involved in the transfer. This is applicable to transfers that originate from the FT Module of Oracle FLEXCUBE, through settlements of any other transaction or transfers uploaded from an external source.

When the value date of a transfer is beyond the effective cut-off time (Cut-off Time + Branch Offset Time) the branch value date spread specified for the currency involved in the transfer is added to the transfer value date. In effect, such transfers are generated as follows:

Generation Date = Transfer Value Date + Branch Value Date Spread



The reference of time is always the System Time (server).

Example

You have maintained the following details:

- Branch Value Date Spread = **2 Days**
- Cut-off Time = **8 PM**
- Branch Offset Time = **3 hours**
- Effective cutoff time = **11 PM** (Cutoff time + Branch offset time)

You have effected a transfer with Value Date 15 June 2000 at 11:30 PM. In this case, the value date of the transfer is later than the effective cut-off time.

The Branch Value Date spread is applied to the transfer value date. The transfer will be generated on 17 June 2000.

How Uploaded FTs are handled

In the case of outgoing transfers that are uploaded from a source external to Oracle FLEXCUBE, the value date will be amended directly based on the cut-off time maintained for the currency and value date spread maintained for the customer.

4.3 Maintaining Tax Cycle

You can maintain tax cycle at the bank level through the 'Tax Cycle Maintenance' screen. Invoke this screen by typing 'STDTXCYL' in the field at the top right corner of the Application tool bar and clicking the adjoining arrow button.

The screenshot shows a web page dialog titled "Tax Cycle Maintenance -- Web Page Dialog". The main content area contains the following fields:

- Tax Cycle * TEST111
- Description TEST111
- Start Date * 7/1/2014
- End Date * 7/3/2014

At the bottom of the dialog, there is a "Fields" tab and a status bar. The status bar displays:

- Input By BRUJ1
- Date Time 7/3/2000 21:23:48
- Modification Number 1
- Open
- Authorized By BRUJ1
- Date Time 7/3/2000 21:23:48
- Authorized
- Exit button

Tax Cycle

You need to define the tax cycle, which will be uniquely identified in the system

Start and End dates for tax cycle

You need to specify the start and end date of the tax cycle you are defining.

4.3.1 Updating Tax Cycle

The Current Tax Cycle would be updated as and when the tax cycle changes. This would be done during authorization of date change function on the first day of the new Tax Cycle.

4.3.2 Maintaining Tax

To maintain Tax parameters at the branch level, click the 'Tax' button in the Branch Parameters Details screen. The screen appears as shown below:

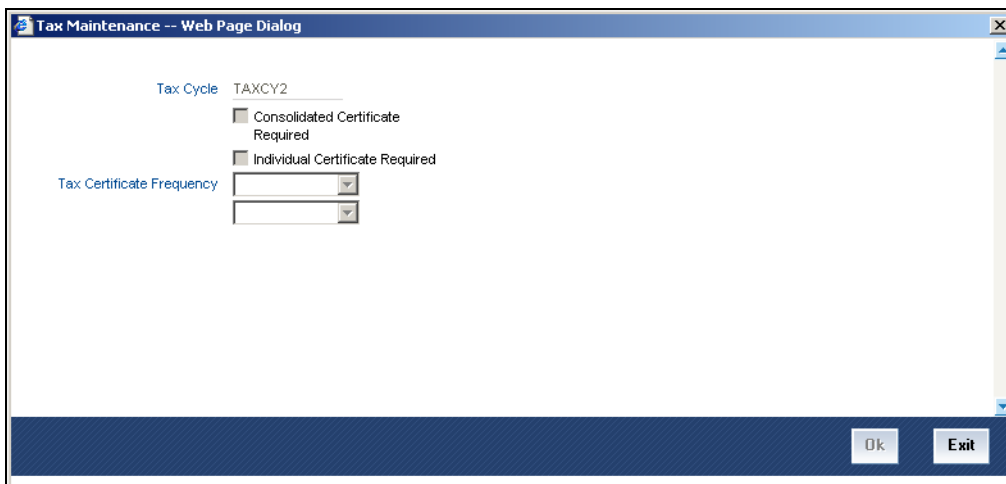

Tax Cycle

This is the current tax cycle for the branch. This is a display field. Whenever the tax cycle changes, the field is updated during the date change authorization for that day.

Consolidated Tax Certificate Required

Check this option to indicate Consolidated Tax Certificate is required for all the transactions done in the Tax Cycle. This option works in conjunction with a similar option in the Customer Information Maintenance and the Tax Category Maintenance screen.

The Consolidated Tax Certificate would be generated at the frequency specified at the branch level. Apart from this, the certificate would also be generated at the end of the Tax Cycle. The consolidated tax certificate would always display all the transactions pertaining to the current Tax Cycle.

Individual Tax Certificate Required

Check this option to indicate Individual Tax Certificate is required for individual transactions under the selected tax category. This option works in conjunction with a similar option in the Customer Information Maintenance and the Tax Category Maintenance screen.

Tax Certificate Frequency

This field is enabled only if the Consolidated Tax Certificate option is checked.

You need to specify the frequency with which the tax certificate should be generated. This would be a combination of the Tax Certificate Frequency and the Tax Certificate Day. It could be any of the following:

- Monthly - This indicates that the tax certificate would be generated every month. The day of the month on which the Tax Certificate would be generated is defined in the Tax Certificate Day field.
- Quarterly (Q) – This indicates that the tax certificate is generated once in three months. The end-month for the first quarter is defined in the Tax Certificate Day field. The Certificate would be generated on the last working day of the month defined in the Tax Certificate Day field. Subsequent end-months would be derived by the system.
- Half Yearly (H) – This indicates that the Tax Certificate would be generated once in six months. The end-month for the first half-year period is defined in the Tax Certificate Day field. The Certificate would be generated on the last working day of the month defined in the Tax Certificate day field. Subsequent end-months would be derived by the system.
- Yearly (Y) – This indicates that the tax certificate would be generated once a year. The month in which the certificate needs to be generated is defined in the Tax Certificate Day field. The Certificate would be generated on the last working day of the month defined in the Tax Certificate Day field.

4.3.3 Maintaining Clearing Currencies

You can maintain a list of currencies in which clearing transactions can be processed under a branch. In order to achieve this, you need to invoke the 'Clearing Currency' screen by clicking the 'Branch Currency' button in the 'Branch Parameters – Detail View' screen.

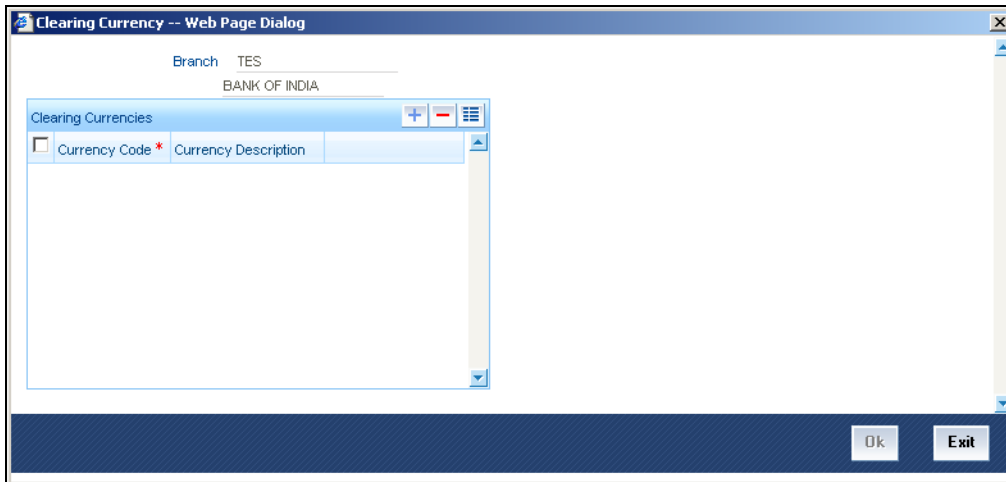

Here you can capture the following details:

Branch Code

The branch code gets defaulted from the 'Branch Parameters – Detail View' screen. A brief description of the branch is displayed alongside.

Currency Code

Specify the currency in which you wish to allow clearing transactions under this branch. You can specify multiple currencies for a branch. Click on the adjoining option list and select the appropriate code from the list of currencies maintained in the system.

Currency Description

A description of the chosen currency code is displayed here

4.3.4 Account Statement Handoff

The account statement handoff will consider the movements on accounts based on the Statement Date and not the Transaction Date. The Statement Status Change will itself run the Account Statement handoff for the previous working date before marking the Branch Statement Status as ready.

4.3.5 Account Statement Generation

Accounting entries with Statement Date lying between From Date and To Date populated in the handoff records will be picked up for Account Statement Generation processing.

Example

The table shows the list of transactions for a customer for statement processing on 01/08/2003.

Booking date	Value date	Transaction Number	Clearing Transaction?	Appear on statement?
31/07/2003	30/07/2003	C1	N	Y
31/07/2003	31/07/2003	C2	N	Y
31/07/2003	01/07/2003	C3	N	Y
31/07/2003	30/07/2003	C4	Y	Y
01/08/2003	31/07/2003	C5	N	N
01/08/2003	31/07/2003	C6	Y	Y

As illustrated, Clearing Transactions have a special treatment as compared to other transactions. To achieve the above set up, the following set up is expected:

For Inward Clearing transactions, the Transaction Code will be maintained with the Statement Date Basis as previous working day. This means that the Clearing Transactions uploaded on 01/08/2003 will have the Statement Date as previous working day of 01/08/2003, i.e. 31/07/2003.

For transactions that are not Inward Clearing, the Transaction Code will be maintained with the Statement Date Basis as Current Working Day. This means, transactions that are not Inward Clearing and processed on 01/08/2003 will have the Statement Date as 01/08/2003.

So, when the Statement Generation processing is done on 01/08/2003 (for a statement till 31/07/2003), the Inward Clearing Transactions generated will be included and not the other transactions.

The following table will show the result of the processing with the Statement Date:

Booking Date	Value Date	Transaction Number	Clearing Transaction	Branch Statement Status	Statement Date	Appear on statement
31/07/03	30/07/03	C1	N	Y	31/07/03	Y
31/07/03	31/07/03	C2	N	Y	31/07/03	Y
31/07/03	01/07/03	C3	N	Y	31/07/03	Y
31/07/03	30/07/03	C4	Y	Y	31/07/03	Y

Booking Date	Value Date	Transaction Number	Clearing Transaction	Branch Statement Status	Statement Date	Appear on statement
01/08/03	31/07/03	C5	N	N	01/08/03	N
01/08/03	31/07/03	C6	Y	N	31/07/03	Y
01/08/03	31/07/03	C5	N	Y	01/08/03	N
01/08/03	31/07/03	C6	Y	Y	01/08/03	N

Thus the Statement Date derived will drive the transactions picked up for the statement between a given date if the Statement is a Booking Dated Statement.

4.4 **Maintaining Role to Head Mapping at Branch Level**

You can maintain different General Ledgers for different branches for the accounting roles defined in the system. If you have maintained Role to Head mapping for a product at the branch level, the system uses these accounting heads instead of the heads maintained at the product level.

You can maintain Role to Head mapping for a combination of branch, product and status in 'Branch Level Role to Head Mapping' screen. You can invoke this screen by typing 'CSDACRHM' in the field at the top right corner of the Application tool bar and clicking the adjoining arrow button.

The screenshot shows a web application dialog box titled "Branch level Role To Head Mapping -- Webpage Dialog". It features several input fields with dropdown menus: "Branch Code *", "Branch Name", "Product Code *", "Product Description", and "Status *". Below these is a table titled "Role To Head Mapping Details" with two columns: "Accounting Role *" and "Accounting Head *". The table is currently empty. At the bottom of the dialog, there are fields for "Maker", "Checker", "Date Time", "Mod No", "Authorized", and "Open", along with a "Cancel" button.

You can specify the following details in this screen:

Branch Code

The branch code of the current branch gets defaulted here.

Branch Name

The name of the current branch corresponding to the branch code gets displayed here.

Product Code

Specify the product code for which you wish to maintain role to head mapping or select the product code from the option list provided.

Status

Specify the status code for which you wish to maintain role to head mapping or select the status code from the option list provided.

Accounting Role

Select the accounting role to be used for role to head mapping, from the option list provided.

Accounting Head

Select the GL accounting head to be used for role to head mapping, from the option list provided.

You can add more rows to accounting role and heads by clicking the 'plus' icon provided. You can also delete a row from this table by selecting the required row and clicking the 'minus' icon.



The accounting roles and heads maintained here will override the default role head mapping maintained for the product.

4.4.1 Viewing Accounting Role to Head Mapping Details

You can view the details related to accounting roles and heads for a branch in 'Branch Level Role to Head Mapping Summary' screen. You can invoke this screen by typing 'CSSACRHM' in the field at the top right corner of the Application tool bar and clicking the adjoining arrow button.

The screenshot shows a web application window titled "Branch level Role To Head Mapping Summary -- Webpage Dialog". The interface includes several input fields and buttons:

- Authorization Status: A dropdown menu.
- Record Status: A dropdown menu.
- Branch Code: A text input field with a plus icon and a minus icon.
- Product Code: A text input field with a plus icon and a minus icon.
- Status: A text input field with a plus icon and a minus icon.
- Search: A button with a magnifying glass icon.
- Advanced Search: A button.
- Refresh: A button.
- Reset: A button.
- Records per page: A dropdown menu set to 15.
- Lock: A dropdown menu set to 3.
- Navigation: A set of icons for navigating between pages, showing "1 of 1".
- Go to Page: A text input field.
- Exit: A button in the bottom right corner.

The main area of the screen is a table with the following columns: Authorization Status, Record Status, Branch Code, Product Code, and Status. The table is currently empty.

The following details get displayed in this screen:

- Authorization status
- Record status
- Branch code
- Product code
- Status code

5. System Dates Maintenance

5.1 Introduction

In the 'System Dates Maintenance' screen you maintain the system dates for your branch, for instance, the business date for your branch, which is the booking, date for all transactions input in the branch.

The dates screen is maintained at the branch level by the respective branches.

Invoke this screen by typing 'STDDATES' in the field at the top right corner of the Application tool bar and clicking the adjoining arrow button.

System Dates Maintenance -- Web Page Dialog

Branch Code * 001
American Bank, NY Branch

Todays Date 7/3/2000
Previous Working Date 6/30/2000
Next Working Date 7/4/2000

Fields

Input By RAJESHK Date Time 12/28/1999 15:42:22 Modification Number 2 Open
Authorized By RAMREDDY Date Time 12/31/1999 15:42:50 Authorized

In this screen the following fields are maintained for your branch:

You define today's date, previous working date and next working date, for the first time, during installation of the system (for details refer to the installation manual).

Suppose Oracle FLEXCUBE is installed on 1 January 1998, in your bank. In the dates screen you would input the following:

Today's date: 01-JAN-1998

Previous working date: 31-DEC-1997

Next working date: 02-JAN-1998

After EOD for a branch is run, the system will not allow you to run any other operation in the branch, till a date change has been invoked.

If you try to run any other application, you will be prompted to invoke a date change first.

- Simultaneously two different branches can be running on two different system dates. This may happen when EOD for a branch is delayed for some reason.
- Based on 'today's date' (post authorization) the system computes and updates the 'Current financial cycle' and the 'Current period' in the Branch Parameters screen.

5.1.1 **Maintaining Dates Change**

For maintaining date change, invoke the 'System dates maintenance' screen after EOD for the day is run. Click 'Unlock' in the Action menu or click unlock icon. The system populates the default dates in the screen.

For instance, on the first working date i.e., 2nd of January, 1998; the system dates will be updated to:

Today's date = 02-Jan-1998

Previous working date = 01-Jan-1998

Next working date = 03-Jan-1998

'Today's date' is defaulted from 'Next working date' of the old record. 'Previous working date' is defaulted from 'today's date' of the old record. The 'Next working date' is picked up from the 'Local branch holiday calendar' as maintained by you. You can modify 'today's date' and the 'next working date' by either clicking unlock icon on the toolbar/selecting 'unlock' from the action menu. 'Previous working date' cannot be modified.

Today's date, if modified, should always be greater than the 'previous working date' and less than the 'next working date'. Similarly, 'next working date' if modified should be greater than 'today's date'. On modifying the dates, the system will ask you for an override. On confirmation the change will be effected.

Date change should be immediately authorized because no application of Oracle FLEXCUBE can be run without date change authorization.

- If you have input any date modification, you cannot authorize it. A user with a different login ID should do it.
- For a branch you can have only one system dates record
- Any modification in date, (be it an authorized or unauthorized record), can be done any time after today's EOD and before BOD for the next day is run. You can modify the 'next working date' any time before running the EOD for the current day.

To authorize, click authorize icon on the toolbar. If any modifications were made, on the system date, the old and the new values will be displayed. After which an alert box will warn you that the dates change will be authorized. You will be prompted to confirm. Click  to confirm. The change will be authorized. If you do not want to authorize the change then click delete icon, you will be returned to the screen from where you invoked the authorization function.

Click 'Exit' button to exit and return to the Application Browser.

6. Accounts for Inter-Branch Transactions

6.1 Defining Accounts for Inter-Branch Transactions

A transaction that takes place in a branch of your bank may involve accounts that are maintained in another branch. For example, a customer has an account in the Head Office branch and approaches another branch of the bank for a cash withdrawal.

For each combination of branches that may be involved in an inter-branch transaction, you can define the currency and the respective customer accounts to which the related accounting entries will be posted.

The accounting entries for such inter-branch transactions can be routed in one of the following ways:

- **Directly** - where each branch will have a direct accounting relationship with all other branches
- **Through a Regional Office** -- where two branches involved in a transaction will interact through a common RO
- **Through the Head Office** -- where the two branches involved in the inter-branch transaction will interact only through the HO.

This route for all transactions is defined in the 'Bank parameters' screen.

In the 'Inter-branch Parameters Maintenance' screen you define the internal accounts for pairs of branches that would be involved in any inter-branch accounting.

Invoke this screen by typing 'ACDIBMNT' in the field at the top right corner of the Application tool bar and clicking the adjoining arrow button. The screen appears as shown below:

The screenshot shows a web-based maintenance dialog for inter-branch parameters. It is titled "Interbranch Parameters Maintenance -- Web Page Dialog".

Branch Information:

- Branch1 * CHO
Description: BANK OF INDIA
- Branch2 * LC5
Description: LC AND BC BRANCH

General Ledger (Left Side - LC5):

- Accounts for: LC5
- Due To Branch2 * AS3501021
Description: DUE FROM BRANCH 001
- Due From Branch2 * AS3501065
Description: DUE FROM BRANCH RO2
- Inter Branch Currency * Account Currency

General Ledger (Right Side - CHO):

- Accounts for: CHO
- Due To Branch1 * AS3501065
Description: DUE FROM BRANCH RO2
- Due From Branch1 * AS3501098
Description: DUE FROM BRANCH PC1
- Inter Branch Currency * Account Currency

MIS Group (Left Side - LC5):

- Due to Branch 2
- Description
- Due from Branch 2
- Description

MIS Group (Right Side - CHO):

- Due to Branch 1
- Description
- Due from Branch 1
- Description

Fields:

Input By: ARV6 Date Time: 7/3/2000 10:23:30 Modification Number: 1 Open
 Authorized By: ARV7 Date Time: 7/3/2000 10:26:38 Authorized

In this screen you maintain the following for each combination of branches that may be involved in an inter-branch transaction:

- Branch Code of both the branches that are involved in the transaction
- For each of the branches, whether inter-branch entries must be posted in transaction currency or settlement account currency
- Customer accounts of Branch 1
 - Due to Branch 2
 - Due from Branch 2
- Customer accounts of Branch 2
 - Due to Branch 1
 - Due from Branch 1

6.1.1 System Features

The system generates a set of pairs of branches for which internal accounts should be maintained. The pairs generated depend upon on two factors:

- The reporting structure for the branches as created in the 'Branch parameters' screen and
- The route defined for inter-branch transactions in the 'Bank-wide parameters -- Preferences' screen,

Example

Suppose the following represents the reporting structure of your bank:

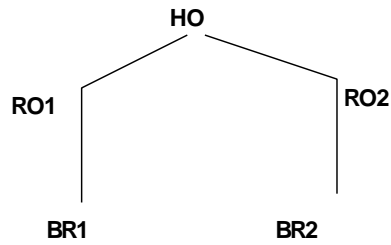

If you have defined a direct inter-branch accounting route then you need to maintain an accounting relationship for each possible combination of

- Branch and branch
- Branch and RO
- RO and HO
- Branch and HO

For the above mentioned reporting structure the system will offer the following pairs of branch combinations to be maintained:

1. BR1- BR2
2. BR1- RO1
3. BR2- RO2
4. RO1- HO
5. RO2- HO
6. BR1 - RO2
7. BR2 - RO1
8. BR1 – HO
9. BR2 – HO
10. RO1 - RO2

If you have defined 'through RO' inter-branch accounting route then you need to maintain an accounting relationship for each possible combination of

- Branch and RO/HO
- RO and RO

In the branch and RO pair, the RO should be that RO to which this branch reports. For the above mentioned reporting structure the system will offer the following branch pairs to be maintained:

1. BR1 - RO1
2. BR2 - RO2
3. RO1 – HO
4. RO2 – HO
5. RO1 - RO2

If you have defined 'through HO' inter-branch accounting route then you need to maintain an accounting relationship for each possible combination of,

- Branches and HO
- ROs and HO

For the above mentioned reporting structure the system will offer the following branch pairs to be maintained:

1. HO - RO1
2. HO - RO2
3. HO - BR1
4. HO - BR2

The system has an in-built auto escalation path for inter-branch accounting transaction which escalates from Direct to Through RO to Through HO.

Example

Suppose in the 'Bank preferences' screen you have defined a 'direct' inter-branch accounting relationship. But in the 'Inter-branch Accounts' maintenance screen (where all inter-branch accounts are maintained), you have not maintained an accounting relationship between two branches -- 000 and 002. Then, in case of an inter-branch accounting transaction between 000 and 002, the system will first look for a 'direct relationship' since that has not been maintained it will look for a relationship through RO i.e., if the two branches have a common RO; if that too does not exist then 'through HO' the transaction would take place.

6.1.2 Specifying Customer Accounts

System determines the settlement route for inter-branch transactions by considering the customer accounts that you specify for a particular currency in this screen.

Example

Let us assume that your bank has to process a transaction in USD involving your branch (Branch Code 001) and another branch (Branch Code 002). If you maintain the customer accounts for the branch pair 001-002 and currency USD, system will accordingly determine the settlement route.

Branch1 and Branch2

To specify a branch pair for which you want to define the customer accounts, you can choose from a list of maintainable branch pairs displayed by the System. The description of Branch 1 and Branch 2 are displayed below the respective branch codes.

6.1.2.1 Specifying General Ledger Details

Specify the customer accounts which are involved in the inter-branch transaction, in the respective branches

To maintain customer accounts for the branch pair specified, the following parameters should be maintained:

Inter Bank Currency

For each branch, you have the option of specifying whether the inter-branch entries must be posted in the transaction currency or the settlement account currency.

For the booking branch, if the Inter-branch Transaction Currency option specified is Transaction Currency, inter-branch entries are posted in the transaction currency only if:

- The local currency of both branches involved in the transaction is the same
- One of the accounts in the entries belongs to the booking branch

Due To Branch 2

This field identifies the customer account maintained in Branch 1 into which the credit accounting entry is passed.

To specify the customer account, select the appropriate account from the picklist of all the customer accounts maintained at Branch 1 .

Due From Branch 2

This field identifies the customer account maintained in Branch 1 into which a debit entry will be passed.

Due to Branch 1

This identifies the customer account maintained at Branch 2 into which a credit entry will be passed.

Due From Branch 1

This account identifies the customer account maintained at Branch 2 into which a debit entry will be passed.

System uses the customer accounts specified in this screen and determines the settlement route for a transaction between two different branches of your bank.

Inter-Branch Transactions through Customer Accounts with Currency – An Example

Assume that Friendly Neighborhood Bank has three branches:

- Los Angeles Branch, which is the Head Office Branch (Branch Code 000)
- Houston Branch (Branch Code 001),
- Chicago Branch (Branch Code 002)

Ms. Sally Williams has an account in branch 002 and wants to withdraw USD 20,000 from her account in Branch 001.

If the inter-branch scheme is 'Through HO', this inter-branch will be routed through the Head Office.

For this inter-branch withdrawal, you need to specify the following:

- Currency Code: USD
- Customer Accounts at Branch 1:
 - Due From – Sally Williams' account in Branch 001.
 - Due To – Account of Branch 002 maintained at the Head Office (Branch 000).
- Customer Accounts at Branch 2:
 - Due From – Account of Branch 002 maintained at the Head Office (Branch 000).
 - Due to – Sally Williams' account in Branch 002.

Therefore, by specifying the customer accounts involved in an inter-branch transaction, you are indicating the settlement route for the transaction.

Accounting Entries in Inter-Branch Accounting - An example

Suppose the University Savings Bank in Headington, Oxford has three branches:

1. Roosevelt Avenue Branch, which is the Head Office branch (Branch code 000)
2. Foxlake Drive Branch (Branch Code 001)
3. Mountainwood Road branch (Branch Code 002)

Branch 000 has a nostro account with Citibank, USA bearing a balance of USD 1 million. Branch 001 and 002 do not maintain USD nostro accounts, but are authorized to operate the nostro account maintained by the Head Office.

Suppose Ms. Tina Shenoy has an account with branch 001. She makes a request to her branch manager, to pay one Mrs. Tanya Agnihotri, in New York, 1000 USD from her account.

Thus, Branch 001 will instruct Citibank, New York to make the payment to Mrs. Agnihotri and debit the nostro account of it's Head Office.

If the 'preference' specified is 'Through HO' then this inter-branch transaction will be routed through the main branch 000.

The following movement of funds will be involved:

1. At branch 001, the customer's account will be debited and the 'due to branch 000' account will be credited.

2. At branch 000, the Nostro account will be credited and the 'due from branch 001' will be debited.

At branch 001	Debit Ms. Shenoy's account Credit 'Due to Branch 000' account
At branch 000	Debit 'Due from Branch 001' account Credit Nostro account

7. Currency Maintenance

7.1 Introduction

In the 'Currency Definition' screen, you define the attributes of the currencies in which your bank can deal. For each currency, you can define attributes like, the SWIFT code for the currency, the country to which the currency belongs, the interest method, the spot days, the settlement days, etc.

Currencies can be maintained only at the Head Office. The list of currencies will be made available to all the branches of your bank.

Invoke this screen by typing 'CYDCDEFN' in the field at the top right corner of the Application tool bar and clicking the adjoining arrow button.

The screenshot shows a web-based dialog box titled "Currency Definition - Web Page Dialog". The interface includes several input fields and checkboxes. Key fields include "Currency Code" (marked with a red asterisk), "Alternate Currency Code", "Currency Name", "Currency Type", "ISO Numeric Currency Code", "Country" (with a dropdown arrow), "Decimals", "Interest Method" (set to "30(Euro)/360"), "Spot Days", "Foreign Exchange Netting Days", "Settlement Days", "Position General Ledger", "Position Equivalent General Ledger", "Tolerance Limit", and "Index Base Currency". A "Cut-Off Time" section has fields for "Days", "Hour", and "Minute". At the bottom, there are checkboxes for "Generate 103+", "CLS Currency", "Index Flag", "Euro Conversion", "New COV format Required", and "Validate Tag-SOF". The status bar at the very bottom displays "Input By: DOC16", "Date Time", "Modification number", "Open", "Authorized", and a "Cancel" button.

7.2 Maintaining Currency Details

Currency Code

Currencies are identified in Oracle FLEXCUBE by the SWIFT codes assigned to them. The currency will be identified by this code in all transactions that involve it.

Currency Name

You can enter the detailed name of the currency in not more than thirty-five alphanumeric characters.

Currency Type

As per your bank's requirement you can choose to classify currencies into different currency types. The bank can use its own discretion to decide the basis of classifying currencies into different currency types. A currency type can consist of a maximum of three characters.

Depending on the customer account mask maintained, the value in the currency type field would be used during the generation of customer account numbers through the Customer Accounts Maintenance screen.

If you have decided to include currency type as part of the customer account number (in the account number mask), then at the time of creating a new customer account number, you will need to select the currency of the account number being generated. In the option-list provided for currency, the currency code is displayed along with the associated currency type say, USD – 1, GBP – 2 etc. When the account number gets populated, it is the currency type that forms a part of the customer account number.

ISO Numeric Currency Code

Specify the currency code specified by the International Standardization Organization.

Country

After you have identified the currency, you should indicate the country to which the currency belongs. You can select a country code from the option list available.

Decimals

You can indicate the number of decimal units up to which the currency can be denominated. The number of decimals allowed for any amount in the currency can be:

- 0 - Currency with no decimals
- 2 - Currency with two decimals
- 3 - Currency with three decimals

Interest Method

You can indicate the interest rate to be used for transactions that involve this currency. The interest options available are:

- Actual/Actual
- 30(US)/360
- Actual/360
- 30(Euro)/365
- 30(US)/365
- Actual/365

- 30(Euro)/Actual
- 30(US)/Actual
- Actual/Actual

Select the interest method that should be used by default whenever the currency is used in transactions. While processing a transaction that involves this currency, the interest method defined for the currency is defaulted. You have the option to change it for a specific transaction.

However, if you do not specify an interest method for a transaction, the method defined for the currency will be used (For details refer to Annexure on Page 140).

Spot Days

The number of spot working days applicable for the currency is specified here. Payment advices for FX and MM contracts will be generated on a date, which is calculated as the number of spot working days before the Maturity Date of the contract.

Example

The tenor of an MM contract is as follows:

Value Date - 01/01/99

Maturity Date - 31/01/99

Contract Currency - USD

Contract Amount - 5000

For USD, the number of Spot Days is specified as: **Spot Days** - 3

For this contract, the payment advices will be sent on 28/01/96.

Foreign Exchange Netting Days

Oracle FLEXCUBE provides a facility wherein all transactions relating to a customer, meant to be settled on a particular day and are made before a specific cut off day are collated, netted and a single payment message is sent instead of individual messages for each payment. This cut off day can be parameterized and is called 'Netting Days'. The number of FX netting days applicable for the specified currency is maintained here.



The system will validate that the FX Netting days are lesser than or equal to the spot days.

Settlement Days

In this screen, you can specify the 'Settlement Days' for a currency. Settlement messages for the components of a contract (in the LC, BC, LD, MM, FX, and FT modules) will be generated according to the settlement days specified for the currency of the settlement account. The following example illustrates this.

Example

When maintaining the details of USD in the Currency screen, you specify the 'Settlement Days' as '2'. This implies that two working days prior to the settlement of a component through a USD account, a settlement message will be automatically generated if specified (when you run the Settlement Messages function at the end of day).

The settlement details of a contract are as follows:

Settlement Date: 06 May 1999

Settlement Account Currency: USD

Component: Principal

Settlement Message: **Yes**

Component Currency: GBP

When you generate the Settlement Messages function, at the end of day, on 04 May 1999, a settlement message for the Principal component of the contract will be generated.

You can run Settlement Messages function as part of EOD operations from the Application Browser to automatically generate settlement messages for contracts marked out for automatic liquidation.

The settlement day specification for a currency will determine the contracts that are picked up for settlement message generation.

Cut-off Time

The Currency Cut-off time refers to the time by which all transactions involving a currency should be generated. For a currency, you can indicate the cut-off hour and minute. This time should be expressed in the local time of the bank.

The maintenance of a cut-off time for a currency has particular reference to outgoing funds transfers involving it.



Holidays are handled based on the currency holiday preferences specified for your bank.

Cut-off days

You can also specify the cut-off days and time for payment transactions involving the currency.

Example

The value date of a funds transfer transaction (incoming payment) involving USD, is 3rd June 2001. The number of cut-off days specified for the currency is 2. This means that the payment must be received on or before 1st June 2001. If the payment is received on 1st June, it must be received before the cut-off time specified for USD.

If the USD cut-off time is 1200 hrs, then, if the payment is received on 1st June 2001, it must be received before 1200 hrs.

The cut-off time (in hours and minutes) that you maintain to be applicable for payment transactions involving a currency are applicable to the head office branch of your bank.

If the branches are in time zones other than the head office branch time zone, you must maintain the offset time applicable for each branch, in the Branch Parameters screen.



Even when cut-off days and cut-off time for a currency have both been specified, the cut-off checks are performed for a funds transfer transaction only if specified as applicable for the product involved in the transaction.

Position or Position Equivalent GL for a currency

If you have opted for position accounting in your bank, you should indicate the Position GL and the Position Equivalent GL, when maintaining a foreign currency, in the currency screen (the Currency Definition screen).

When maintaining the GLs in your bank, you can opt to link the different foreign currencies, associated with the GL to either of the following:

- The Position GLs that you specify here (for the corresponding currency)
- Position GLs of your choice

Tolerance Limit

When you are maintaining an 'In' Currency, or the Euro, in the Currency Definition screen, you can define a 'Tolerance Limit' for it. The limit is expressed as a percentage.

The implication:

During the transition period, settlement of components in 'In' currencies can be made either in the same currency or in the Euro (EUR) depending on the settlement account(s) maintained. (Similarly, components in Euro can either be settled in EUR or in an 'In' currency.) In the settlement messages that are generated (MT 100, MT202), the settlement amount would be reported in the Settlement Account Currency. However, you can opt to additionally furnish the value of the component in Euro Related Information (ERI) currency. You have to manually specify the settlement amount value, in the ERI currency, in the Settlement Message Details screen.

When generating the message towards settlement (MT100, MT202), the system ensures that the value you specify as the ERI Amount conforms to the Tolerance Limit defined for the ERI Currency (in the Currency Definition screen). That is, the system computes the ERI equivalent of the settling amount using the pegged rates, and compares the same against the ERI amount input by the user. If the difference is within the tolerance limits defined for the ERI currency, the user specified amount is used.

If the user specified ERI amount breaches the Tolerance Limit defined for the ERI currency, the system calculates and reports the ERI Amount on the basis of the exchange rate defined for the settlement currency vis-à-vis the ERI currency.

Example

In the SWIFT messages (MT 100 and MT 202) that are generated towards settlement, the value of the component can be reported both in Nostro account currency (in Field 32A) and in an ERI currency that you specify (in Field 72). In Oracle FLEXCUBE, this information is captured in the European Related Information (ERI) fields in the Settlement Message Details screen.

Assume the following scenario:

- The settlement account is an EUR account
- You have to settle an amount of DEM 10000
- You have defined the ERI currency for DEM as DEM
- The Tolerance Limit for DEM as 0.05%
- The exchange rate: 1 Euro = 1.30 DEM

The settlement amount in Euro would therefore be 7692.36 (rounded to nearest higher cent). This amount will be reported in Field 32A of the settlement messages. Now, if you want to furnish the settlement amount in the ERI currency (in this case, DEM) you have to manually enter the DEM value in the ERI Amount field. You may enter DEM 10000. (EUR 7692.36 actually converts into DEM 10000.068.)

The value that you have entered is well within the Tolerance Limit of 0.05% defined for DEM. Therefore, this value will be reported in Field 72 of the settlement messages.

Since the Tolerance Limit for DEM is 0.05%, you can specify an ERI Amount between DEM 9995 and DEM 10005 ($DEM\ 10000 * 0.05/100 = DEM\ 5$). If you enter an ERI value exceeding DEM 10005 or less than DEM 9950, the system recalculates the ERI Amount at the time of generating the settlement messages. The recalculation will be on the basis of the pegged rates between the Settlement Currency and the ERI currency.



The system validates the ERI amount only when generating the settlement messages. It does not validate the ERI amount at the time of input (in the Settlement Message Details screen).

Index Base Ccy

Specify the currency that should be used to handle index-based securities traded by the banks, wherein the deals are done in index currency and their settlement is done through the local currency.

Generate 103+

You can enable the MT 103 + format option only if you would like to generate outgoing MT 103 messages in the MT 103 + format.

If you are enabling this option for a specific currency, ensure to also enable this option:

- For your bank branch in the Branch Parameters Maintenance
- For the customer of the contract, in the BIC Code Maintenance
- For the product used by the contract, in the Product Preferences

Consequently, while processing transactions in the specified currency for such a customer, branch and product, for which the MT 103+ option is enabled, the system generates outgoing payment messages in the MT 103 + format.



Since the system is also capable of processing incoming MT 103 messages in the MT 103 + format. Therefore, during the upload process for your branch, the system considers an MT 103 payment message to be of MT 103+ format for those customer, currency and product combinations, for which the MT 103+ option has been enabled.

CLS currency

To allow customers of your bank to settle their FX deals via the CLS (Continuous Linked Settlements) Bank, you can identify the currency to be a 'CLS Currency'. FX deals in the CLS currency only will be eligible to be routed through the CLS bank.

From the available list of CLS currencies, you can further maintain a list of 'allowed' or 'disallowed' currencies for a specific customer. Every customer who is a 'CLS Participant' will be allowed to trade in all the available CLS currencies unless specifically mentioned.

Refer the 'Continuous Linked Settlements' chapter of the Foreign Exchange User Manual for details on maintaining currency restrictions and other maintenances required for processing CLS deals in Oracle FLEXCUBE.

New COV Format Required

Check this box to indicate that cover message needs to be sent in the new format, for transactions involving the currency specified here.

For more details on new cover message formats, refer settlements user manual.

Validate Tag 50F

Check this box to indicate that validations need to be performed for the 50F details captured for the ordering customer during contract input.

For more details on 50F validations, refer the chapter titled 'Maintaining Addresses for a Customer' in Messaging System user manual.

7.2.1.1 Indicating Rounding Preferences

Rule

This refers to the method to be followed for rounding off fractional units of a currency. The rounding preferences available are:

- Truncate — The amount is truncated to the number of decimals specified for the currency
- Round Up — The amount is rounded up based on the number of decimals and the nearest rounding unit
- Round Down —The amount is rounded down based on the number of decimals and the nearest rounding unit

Example

Amount before Rounding	Rounding Method	No. of Decimals	Rounding Unit	Amount after Rounding
1234.678	Truncate	2	-	1234.67
1234.678	Round up to the nearest rounding unit	2	.01	1234.68
1234.678	Round down to the nearest rounding unit	2	.01	1234.67

Unit

If you have selected Round Up or Round Down in the Rule field, you need to indicate the nearest unit to which the rounding should take place. The number of units specified here should not be greater than the number of decimals allowed for the currency.

Example

The decimal points specified for currency 'A' is 2. Rounding unit is .05

Amount for transaction is USD 100.326, which will be rounded off depending upon the decimals specified and the rounding rule and rounding unit.

For Rounding Rule 'Up', the amount available for transaction would be USD 100.35. For rounding rule 'Down', the transaction amount would have been rounded down to 100.30

If the rounding rule was specified as 'truncate' then, the amount would have rounded off to 100.32 (simply, knock off all decimal points beyond the stated decimals places to be rounded off). Thus whenever you specify a 'truncate' option you need not state the 'Rounding unit'.

7.2.1.2 Specifying Amount Format Mask

Specify the format in which amounts in this currency are to be displayed for contracts in this currency. Two options are available:

999,999,999

9,999, 999, 99

The system defaults to the 999,999,999 format.

Euro Type

When maintaining a currency in the Currency Definition screen, you have to specify the 'type' of the currency with relation to transition phase of the European Economic and Monetary Union (EMU). You can do this in the 'Euro Type' field.

Your specifications in this field enable you to handle the *first phase* of the EMU, which commenced on 01 January 1999.

For more details on the manner in which Oracle FLEXCUBE handles the Euro, refer the chapter 'Handling the Euro'.

By choosing the appropriate option, you can indicate if the currency is:

- The Euro
- An 'In' currency
- An 'Out' currency
- 'Euro Closed'

National currencies of 'In' countries are referred to as 'In' currencies. When maintaining other currencies, you have to choose the 'Out Ccy' option under Euro Type.

When the transition period ends, the national currencies of the participating countries would cease to exist as valid legal tenders. The Euro would be the only legal tender in the participating countries. Consequently, the Euro changes made to Oracle FLEXCUBE will no longer be required.

You can turn off the changes at the end of the transition period by:

1. Closing all 'In' currencies, and
2. Choosing the 'Euro Closed' option (for the Euro)

7.2.2 Specifying Exchange Rate Limits

Click 'PC' button in the Currency Definition screen to invoke 'Limits' screen.

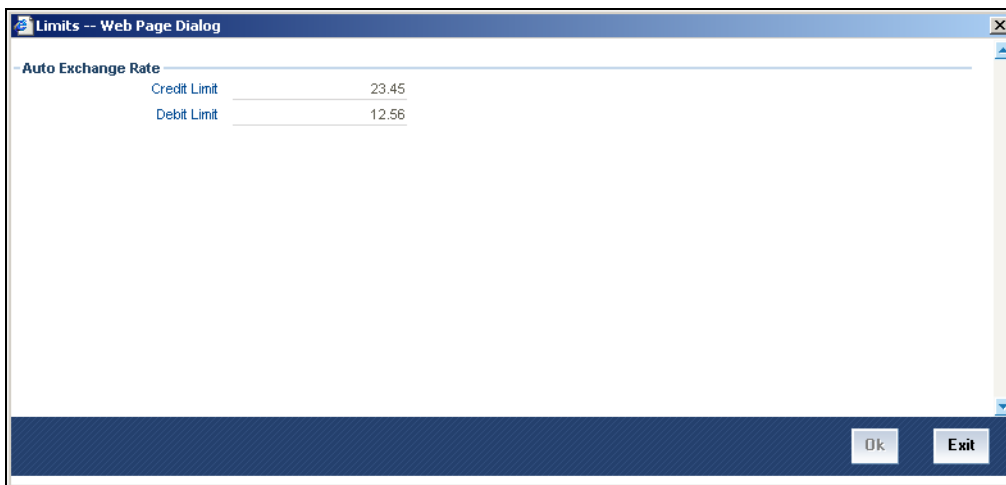

You can specify the credit limit and the debit limit for the exchange rate in this screen.

7.2.3 Mapping Currency to Country

Click 'Currency Country Mapping' button in the Currency Definition screen to invoke 'Clearing Zones Country Codes for Currency' screen.

The screen appears as shown below:

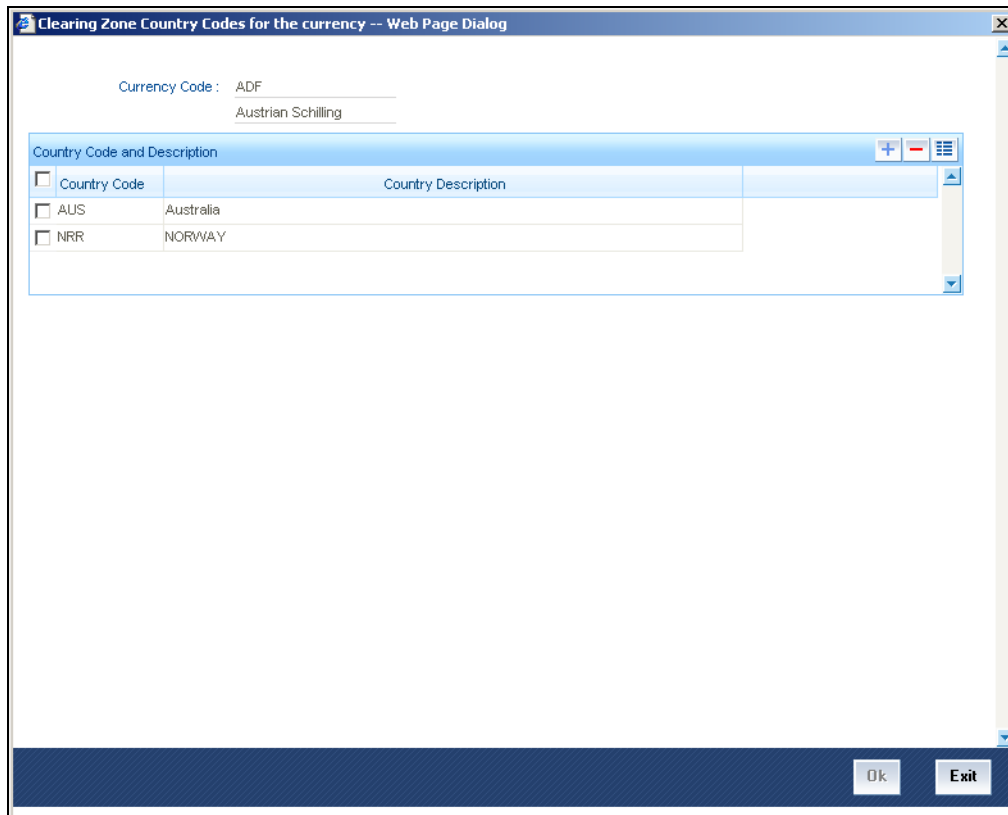

You can map a currency code to a country in this screen.

7.2.4 Specifying User Defined Fields

You can associate values to all the User Defined fields created and attached to the Currency Definition Screen. You can view the list of User Defined fields associated by clicking the 'Fields' button.

The screen appears as shown below:

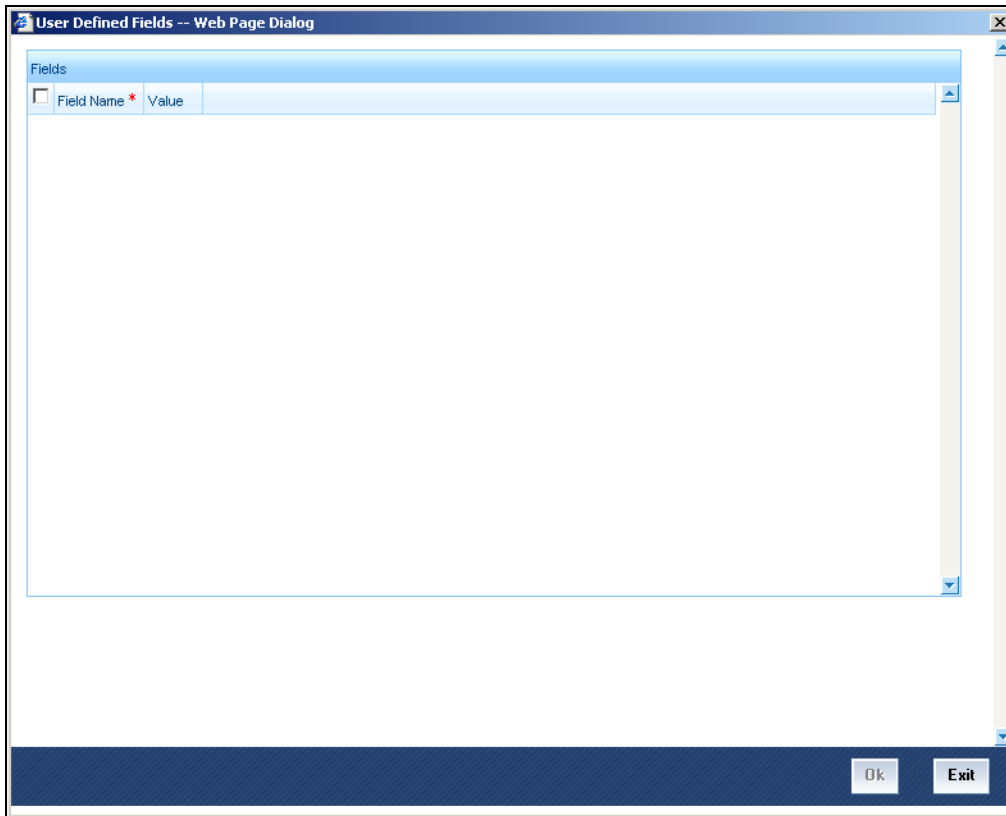

You can enter the value for the UDFs listed here in the 'Value' column.

For more details on how to create user Defined fields, refer chapter 'Creating custom fields in Oracle FLEXCUBE' in the User Defined Fields User Manual under Modularity.

7.2.5 **Annexure**

The treatment for interest calculation varies with each of the interest calculation methods. Each method is dealt with individually below:

Actual/Actual Method

$$10,000 \times 10 / 100 \times (31 / 365 + 84 / 366)$$

In this method, the number of days is calculated as follows:

Dec. -31 days (include from date exclude to date)

Jan -31 days

Feb.-29 days (leap year)

March - 24 days (include from date exclude to date)

Total = 31 + (31+29+24=84) =115



When the interest period crosses from a non-leap year to a leap year (or otherwise), the basis of actual days has to be treated separately in each year.

Therefore, the denominator for the 31 days in December is 365 as it is a non-leap year and the denominator for the 84 days in 2000 is 366 as it is a leap year.

Actual /365 Method

$10,000 \times 10 / 100 \times 115 / 365$

In this method, the number of days is calculated as follows:

Dec. -31 days (include from date exclude to date)

Jan -31 days

Feb.-29 days (leap year)

March - 24 days (include from date exclude to date)

Total=31+31+29+24=115

Actual/360 Method

$10,000 \times 10 / 100 \times 115 / 360$

In this method, the number of days is calculated as follows:

Dec. -31 days (include from date exclude to date)

Jan -31 days

Feb.-29 days (leap year)

March - 24 days (include from date exclude to date)

Total=31+31+29+24=115

30 Euro/Actual Method

$10,000 \times 10 / 100 \times (30 / 365 + 84 / 366)$

In this method, the number of days is calculated as follows:

Dec. - 30 days (include from date exclude to date)

Jan - 30 days (In 30 Euro Method, all months have 30 days, February included.)

Feb. - 30 days (In 30 Euro Method, February always has 30 days, leap year or not)

March - 24 days (include from date exclude to date)

Total = 114 days



When the interest period crosses from a non-leap year to a leap year (or otherwise), the basis of actual days has to be treated separately in each year.

30 Euro/365 Method

$10,000 \times 10 / 100 \times 114 / 365$

In this method, the number of days is calculated as follows:

Dec. - 30 days (include from date exclude to date)

Jan - 30 days (In 30 Euro Method, all months have 30 days, February included.)

Feb. - 30 days (In 30 Euro Method, February always has 30 days, leap year or not)

March - 24 days (include from date exclude to date)

Total = 114 days

30 Euro/360 Method

$10,000 \times 10 / 100 \times 114 / 360$

In this method, the number of days is calculated as follows:

Dec. - 30 days (include from date exclude to date)

Jan - 30 days (In 30 Euro Method, all months have 30 days, February included.)

Feb. - 30 days (In 30 Euro Method, February always has 30 days, leap year or not)

March - 24 days (include from date exclude to date)

Total = 114 days

30 US/Actual Method

$10,000 \times 10 / 100 \times (30 / 365 + 84 / 366)$

In this method, the number of days is calculated as follows:

Dec. - 30 days (include from date exclude to date)

Jan - 30 days (In 30 US Method, all months have 30 days, only for February are the actual number of days calculated.)

Feb. - 29 days (In 30 US Method, actual days are accounted for the leap year.)

March - 24 days (include from date exclude to date)

Total = 114 days



When the interest period crosses from a non-leap year to a leap year (or otherwise), the basis of actual days has to be treated separately in each year.

30US/365 Method

$10,000 \times 10 / 100 \times 114 / 365$

In this method, the number of days is calculated as follows:

Dec. - 30 days (include from date exclude to date)

Jan - 30 days (In 30 US Method, all months have 30 days, only for February are the actual number of days calculated.)

Feb. - 29 days (In 30 US Method, actual days are accounted for the leap year.)

March - 24 days (include from date exclude to date)

Total = 114 days

30US/360 Method

$10,000 \times 10 / 100 \times 114 / 360$

In this method, the number of days is calculated as follows:

Dec. - 30 days (include from date exclude to date)

Jan - 30 days (In 30 US Method, all months have 30 days, only for February are the actual number of days calculated.)

Feb. - 29 days (In 30 US Method, actual days are accounted for the leap year.)

March - 24 days (include from date exclude to date)

Total = 114 days

7.2.6 Specifying Currency Cut-Off Parameters

You can choose to restrict the time within which (or before which) funds transfer transactions involving a specific customer, product, and a currency, must be received for processing. For a specific customer, product, and a currency, you can specify a certain number of days before which a transaction involving the combination must be received, as well as a cut-off time before which transactions must be received. These parameters are known as currency cut-off parameters, and you maintain these parameters in the 'Value Dated Spread' maintenance screen.

Invoke this screen by typing 'FTDVDSPP' in the field at the top right corner of the Application tool bar and clicking the adjoining arrow button.

The screenshot shows a web page dialog titled "Value Date Spread Maintenance -- Web Page Dialog". The form contains the following fields and values:

- Value Date Spread:**
 - Customer Identification * PAV101PAV
 - Currency Code * USD
 - Customer Name PAVAN
 - Description U.S.DOLLAR
 - Product Code * FTIN
 - Description INTERNAL
- Spread Details:**
 - Debit Value Date Spread * 5
 - Credit Value Date Spread * 5
- Cut Off Details:**
 - Days
 - Cut Off Time HR
 - Minutes

At the bottom of the dialog, there is a "Fields" tab and a status bar with the following information:

- Input By DEEPA
- Date Time 7/3/2000 21:47:02
- Modification Number 1
- Open
- Authorized By DEEPA
- Date Time 7/3/2000 21:47:03
- Authorized
- Exit button

In this screen, you can maintain the cut-off time, cut-off days and the value spreads to be applicable for:

- Each customer, for a product and currency combination
- All customers, for each product and currency combination

These currency spread cut-off parameters are validated in respect of a funds transfer transaction only if currency cut-off checks are specified as applicable in the product preferences, for the product involving the transaction.

For details about how the currency cut-off checks are applied on a funds transfer transaction, refer the chapter 'Processing a Funds Transfer Contract' in the Funds Transfer User Manual.

7.3 Handling Euro

On 1 January 1999, eleven countries that are part of the European Union embarked on the first phase of economic integration, called the 'Economic and Monetary Union' (EMU). In Oracle FLEXCUBE, the eleven countries participating in the first phase of the EMU are referred to as 'In' countries and the respective national currencies as 'In' currencies. All other countries are referred to as 'Out' countries.

The first phase of the EMU, referred to as the 'transition period', ushered in a new, single European currency: the **Euro (EUR)**. During this phase, the National Currency Denominations of 'In' countries would co-exist with the Euro. That is, transactions involving an 'In' currency would, typically, be routed through the Euro during this phase. At the end of the transition period, in mid 2002, however, the national currencies of the participating countries would cease to exist as valid legal tenders. The Euro would be the only legal tender in 'In' countries.

In Oracle FLEXCUBE, you can handle the Euro and the attendant implications for your bank, by capturing additional currency and settlements related information. This chapter details how this information is to be captured, and its implications.

7.4 Maintaining Euro Related Information

In Oracle FLEXCUBE, the details that you need to maintain in order to handle the EMU include:

- Maintaining Euro as a valid currency
- Indicating if a currency is 'In', 'Out', 'Euro', or 'Euro Closed'
- Maintaining Currency Redenomination details
- A common conversion GL and a transaction code to identify the redenomination entry
- Maintaining a 'Tolerance Limit' for a currency (to check against ERI information)
- Capturing additional settlement details (Euro related information for the MT 100 and MT 202 SWIFT messages)

You can maintain currency related information in the Currency and the Currency Pair Definition screens. 'Settlement' details can be captured in the Settlement Instruction Details screen.

7.4.1 Maintaining Currency Details

Your specifications for a currency in the Currency Definition screen determine the manner in which transactions in the currency are handled in Oracle FLEXCUBE.

Currency Type

When maintaining a currency in the Currency Definition screen, you have to specify the 'type' of the currency. You can do this in the 'Euro Type' field. Choose the appropriate option from the following:

- The Euro itself
- An 'In' currency

- An 'Out' currency
- 'Euro Closed'

National currencies of 'In' countries are referred to as 'In' currencies. When maintaining other currencies, you have to choose the 'Out Ccy' option under Euro Type.

When the transition period ends, the national currencies of the participating countries would cease to exist as valid legal tenders. The Euro would be the only legal tender in the participating countries. Consequently, the Euro changes made to Oracle FLEXCUBE will no longer be required.

You can turn off the changes at the end of the transition period by:

- Closing all 'In' currencies, and
- Choosing the 'Euro Closed' option (for the Euro)

Tolerance Limit

When you are maintaining an 'In' Currency, or the Euro, in the Currency Definition screen, you can define a 'Tolerance Limit' for it. The limit is expressed as a percentage.

The implication:

During the transition period, settlements of components in 'In' currencies can be made either in the same currency or in the Euro (EUR) depending on the settlement account(s) maintained. (Similarly, components in Euro can either be settled in EUR or in an 'In' currency.) In the settlement messages that are generated (MT 100, MT202), the settlement amount would be reported in the Settlement Account Currency. However, you can opt to additionally furnish the value of the component in Euro Related Information (ERI) currency. You have to manually specify the settlement amount value, in the ERI currency, in the Settlement Message Details screen.

When generating the message towards settlement (MT100, MT202), the system ensures that the value you specify as the ERI Amount conforms to the Tolerance Limit defined for the ERI Currency (in the Currency Definition screen). That is, the system computes the ERI equivalent of the settling amount using the pegged rates, and compares the same against the ERI amount input by the user. If the difference is within the tolerance limits defined for the ERI currency, the user specified amount is used.

If the user specified ERI amount breaches the Tolerance Limit defined for the ERI currency, the system calculates and reports the ERI Amount on the basis of the exchange rate defined for the settlement currency vis-à-vis the ERI currency.

The following example illustrates the application of the Tolerance Limit.

Example

In the SWIFT messages (MT 100 and MT 202) that are generated towards settlement, the value of the component can be reported both in Nostro account currency (in Field 32A) and in an ERI currency that you specify (in Field 72). In Oracle FLEXCUBE, this information is captured in the European Related Information (ERI) fields in the Settlement Message Details screen.

Assume the following scenario:

- The settlement account is an EUR account
- You have to settle an amount of DEM 10000
- You have defined the ERI currency for DEM as DEM
- The Tolerance Limit for DEM as 0.05%
- The exchange rate: 1 Euro = 1.30 DEM

The settlement amount in Euro would therefore be 7692.36 (rounded to nearest higher cent). This amount will be reported in Field 32A of the settlement messages.

Now, if you want to furnish the settlement amount in the ERI currency (in this case, DEM) you have to manually enter the DEM value in the ERI Amount field. You may enter DEM 10000. (EUR 7692.36 actually converts into DEM 10000.068.) The value that you have entered is well within the Tolerance Limit of 0.05% defined for DEM. Therefore, this value will be reported in Field 72 of the settlement messages. Since the Tolerance Limit for DEM is 0.05%, you can specify an ERI Amount between DEM 9995 and DEM 10005 (DEM 10000 * 0.05/100 = DEM 5). If you enter an ERI value exceeding DEM 10005 or less than DEM 9950, the system recalculates the ERI Amount at the time of generating the settlement messages. The recalculation will be on the basis of the pegged rates between the Settlement Currency and the ERI currency.



The system validates the ERI amount only when generating the settlement messages. It does not validate the ERI amount at the time of input (in the Settlement Message Details screen).

Currency pairs

In the Currency Pair Definition screen, you can specify a 'Through Currency'. When maintaining a pair involving an 'In' currency ('In' – 'Out' and 'In' – 'In'), you can only specify the Euro as the 'Through Currency'.



You cannot maintain a 'Through Currency' for a pair constituted by an 'In' currency and the Euro.

7.4.2 Maintaining Conversion GLs

To facilitate the currency conversion process, two additional parameters need to be maintained in the 'Branch Parameters' screen. You have to maintain a common Conversion GL and a Transaction Code that identifies redenomination entries.

Branch Parameters Maintenance -- Web Page Dialog

Branch Code * 006 Branch Name * American Bank, Chicago Branch Available

General Details **Financial Details**

Suspense General Ledger

Real Local Currency * AS9501104 SUSPENSE ACCOUNT
Cont Local Currency * CA9501102 SUSPENSE ACCOUNT - BR 006
Real Foreign Currency AS9501104 SUSPENSE ACCOUNT
Cont Foreign Currency CA9501102 SUSPENSE ACCOUNT - BR 006
ATM

Financial Cycle

Current Cycle FY2000
Current Period QT3

Referral Cut Off Time

Hours 4
Minutes 30

Euro Redenomination General Ledger

Conversion General Ledger
Conversion Transaction Code

Job Status
 Auto Authorisation

Payment Messages **Floating Rate**

Generate 103 Proceed without maintaining float rate
 Generate 103+ Deferred Statement Status Y
Default Bank Operation Code CRED Install Installation Completed

Branch Code for Clearing Sector Code
Clearing Through Branch Routing No AMB
Loan Direct Debit
Generation Days

Preferences SWIFT Address Account Mask CIF Range GI Functions Tax Branch Currency UDF

Input By ARLIN Date Time 7/3/2000 11:43:59 Modification Number 3 Open
Authorized By ANAND Date Time 7/3/2000 11:44:43 Authorized Exit

7.4.2.1 Indicating Euro Redenomination General Ledger

Conversion GL

The conversion GL that you specify will be identified as the common Suspense GL for all balance conversions while re-denominating the currency of an account either for specific customers or for generic conversions.

Transaction Code

In addition to the conversion GL, you have to indicate a Transaction Code, which identifies conversion related entries.

7.4.3 Implications of Currency Redenomination

In the IC Product Accounting Role Definition screen

For the purpose of currency conversion, an accounting role called 'Acquired' is available.

End of day processes

Maintaining a Conversion GL and Transaction Code simplifies the End of day process. Basically two important things happen when the End of day processes are run. Firstly interest is liquidated to the Acquired Interest GL and secondly all balances will be reduced to zero.

When you run the Beginning of day processes the next day the change in the currency conversion will be in place. In addition balances will get restored.

Example

You decide to re-denominate the account 'BOAB001BNKCUFINRA2' of Customer Number 'SP1000' from Deutsche Mark (DEM) to EURO.

You have specified that the liquidation cycle is to be monthly. The currency conversion is carried out on the 17th of the month.

The interest liquidated from the 1st to the 17th will be put in the Acquired Interest GL. On the next liquidation date (i.e. the 30th of the month) the interest liquidated from the 1st to the 17th is converted to Euro and transferred from the Acquired Interest GL to account 'BOAB001BNKCUFINRA2'.

Additionally the interest calculated from the 17th to the 30th is also credited or debited to the account depending upon the type of account.

An example of the EOD/BOD processes

The following example illustrates the accounting entries passed when currency conversion is made.

Account Name BOAB001BNKCUFINRA2

Account Currency Deutsche make (DEM)

The Bank's LCY	USD
The Standard Exchange Rate between DEM and EURO	2.5

Requirement:

The account currency has to be converted from DEM to EURO.

The Value Dated balances as of the 17th of the month are as follows:

17 th Jan 99	18 th Jan 99	19 th Jan 99
100,000 Cr.	120,000 Cr.	80,000 Cr.

The following are the accounting entries passed as of the 17th for the Account BOAB001BNKCUFINRA2.

Account	CCY	Dr./Cr.	FCY	LCY	Txn Code	Val. Date
BOAB001BNKCUFINRA2	DEM	Dr.	100,000	33333.33	ECV	17 th
BOAB001BNKCUFINRA2	DEM	Dr.	20,000	6666.67	ECV	18 th
BOAB001BNKCUFINRA2	DEM	Dr.	40,000	13333.33	ECV	19 th
CNV GL	DEM	Cr.	80,000	26666.67	ECV	17 th

The following are the entries passed on the 18th of the month:

Account	CCY	Dr./Cr.	FCY	LCY	Txn Code	Val. Date
BOAB001BNKCUFINRA2	EURO	Cr.	48000	40000	ECV	18 th
BOAB001BNKCUFINRA2	EURO	Dr.	16000	13333.33	ECV	19 th
CNV GL	EURO	Dr.	32000	26666.67	ECV	18 th

Change in field values due to conversion

The change in currency re-denomination impacts amount based fields pertaining to Accounts, Collaterals, Credit Lines and Customer Limits. The change in the value of these fields is reflected when you run the beginning of day processes.

The amount-based fields, which are affected by the change in currency denomination, will be updated with the equivalent value in the new currency

Accounts

The following fields will reflect the new values:

- Temporary Over Draft limit
- Sub-limit
- Uncollected Funds limit
- Offline limit
- Account Currency

These fields can be found in the Customer Accounts Maintenance screen.

Collateral

In the Limits Maintenance Collaterals screen the following fields will be updated:

- Collateral Currency
- Collateral Value
- Limit Contribution
- Issuer Exposure Amount

Credit Lines

In the Limits screen of the Limits Maintenance module the following fields will reflect the new values:

- Credit Line Currency
- Tenor limits
- Tenor utilization
- All Related Amounts

Customer Limits

In the Customer Maintenance screen of the Core Services module the following fields will be updated at BOD.

- Limit Currency
- Liability Risk Limit
- Customer Risk Limit



Note the following:

- Once the conversion process is complete the advices generated for your customer will carry the following information:
 - The Old Value
 - The New Value
 - And the Exchange Rate used for the conversion
- As a consequence of currency re-denomination you will not be able to pass entries where the value date falls before the currency conversion date.

7.4.4 Specifying Preferred ERI Currency for Counterparty

For a counterparty and currency (combination), you can maintain a preferred ERI currency. You can state this preference in the 'Settlement Instructions' screen.

The implication

During the transition period, settlements of components in 'In' currencies can be made either in the same currency or in the Euro (EUR) depending on the settlement account(s) maintained. (Similarly, components in Euro can either be settled in EUR or in an 'In' currency.) In the settlement messages that are generated (MT 100, MT202), the settlement amount would be reported in the Settlement Account Currency. However, you can opt to additionally furnish the value of the component in Euro Related Information (ERI) currency. You can maintain this ERI currency (for a counterparty and currency combination) in the 'Settlement Instructions Maintenance' screen.

In the SWIFT messages that are generated towards settlement of a component (involving the counterparty and the currency), the component value will be expressed in this (ERI) currency, by default. Invoke this screen by typing 'ISDINSTR' in the field at the top right corner of the Application tool bar and clicking the adjoining arrow button.

The screenshot displays the 'Settlement Instructions Maintenance' web page. The interface includes several input fields for configuration: Branch (101), Counterparty (1010011), Currency (INR), and Account (1009). It features sections for 'Pay' and 'Receive' details, including 'Cover Required' and 'Charges Details' options. At the bottom, there are tabs for 'Pay Parties', 'Receiver Parties', 'Cover Parties', 'Clear Details', 'Cover Details', and 'Other Details'. A status bar at the very bottom shows user information like 'Input By: BHATT1' and 'Date Time: 7/3/2000 16:44:03', along with 'Open' and 'Authorized' buttons and an 'Exit' button.

7.4.5 Specifying Settlement Message Details

SWIFT messages (MT 100/MT202) generated towards settlement can furnish the value of the settlement amount in both the settlement account currency, and an 'ERI' currency. If you opt to furnish the ERI value of the amount, you have to enter the following in the 'Settlement Details' screen:

- The ERI currency
- The ERI Amount

The screen appears as shown below:

Component	Currency	Branch	Account	Account Currency	D/C	Exchange Rate	Rate Code	Spread Definition
<input type="checkbox"/> BILL_AMOUNT	USD	CHO	AS3908029	USD	C			
<input type="checkbox"/> BILL_AMT_EQUIV	USD	CHO	AS3908029	USD	D			
<input type="checkbox"/> BILL_LIQ_AMT	USD	CHO	AS3908029	USD	D			
<input type="checkbox"/> BILL_LIQ_AMTEQ	USD	CHO	AS3908029	USD	C			

The system defaults to the ERI currency specified for the customer and currency combination. You can change the default ERI currency. The ERI amount that you specify will be validated against the Tolerance Limit specified for the ERI currency.

7.4.6 Settlements of Foreign Exchange Deals

Oracle FLEXCUBE allows cross currency settlements of foreign exchange deals that involve an 'In' currency. You can settle the 'In' currency leg in another 'In' currency or in 'Euro'.

Example

Assume you enter into the following Foreign Exchange deal. You sell 1,00, 000 FRF against USD.

The scenario:

You specify the exchange rate: 1 USD = 5.2 FRF

The bought amount is therefore: 19230.769 USD

The settlement account is in EUR

The exchange rate between EUR/FRF: 1 EUR = 6.475 FRF

Since FRF is an 'In' currency, you can settle the *sell* leg of the deal through EUR (in this example). The settlement amount would be EUR 15444.015.

7.4.7 Reports and Advices

The following reports furnish the equivalent Euro values of amounts in an 'In' currency. The 'locked in' exchange rates defined for the Euro against the 'In' currency will be used for currency conversions.

The reports with this feature are the:

- Currency Position report
- Cash Flow report
- FX Maturity report

 These reports will not furnish the 'In' currency and equivalent Euro values when you close the 'In' currencies, and choose the 'Euro Closed' option (for the Euro) in the Currency Definition screen.

All advices that provide 'In' currency details will also provide the equivalent Euro values

Account Statements

Statements provided for accounts in an 'In' currency provide the Euro equivalent values of the following:

- The opening balance
- The closing balance
- Every transaction

7.4.8 Maintaining Transaction Limits

This paragraph explains in detail about Maintaining Transaction Limits for Module, Product and Currency combination

Oracle FLEXCUBE offers you a facility, whereby, each time a particular transaction processed in the system exceeds a certain limit; an override will be generated by the system.

You can maintain transactional limits for a Module, Product and Currency combination through the 'Product Transactional Limits Maintenance' screen. Invoke this screen by typing 'CSDPLMNT' in the field at the top right corner of the Application tool bar and clicking the adjoining arrow button.

The screen appears as shown below:

Product Transaction Limits Maintenance -- Webpage Dialog

Module Code*

Description

Product Code*

Description

Transaction Limit Currency*

Product Transaction Limit Details

<input type="checkbox"/>	Transaction Limit*	Level Of Authorization Reqd*	Role Identification*
--------------------------	--------------------	------------------------------	----------------------

Fields

Input By Date Time Modification Number Authorized

Authorized By Date Time Open

Module Code

Each module in Oracle FLEXCUBE is identified by a code. First, you have to identify the module for which the currency-wise transactional limit is to be maintained. A list of all the modules operational at your bank will be displayed in the option list. You can choose the appropriate module code. The description associated with the module will be defaulted in the adjacent field.

Product Code

Each module contains a number of products within it. After you identify the module, indicate the product within the module for which you would like to maintain a currency-wise transactional limit. You can select the appropriate product code from the option list.

In the Product Transactional Limits screen, you can maintain the limits for:

- A specific module and a specific product
- A specific module and all products (select 'ZALL' as the Product Code)
- All modules (Select 'AL' as the Module Code) and all products

Limit Currency

The transaction limit currency is the currency in which you would like to maintain the amount limit.

Product Transaction Limit Details

Transaction Limit

Specify the transaction limit that requires multi level authorization.

This is used to capture the transaction limit amount for which the different levels of authorization levels are required. It is a numeric text field and the values should be maintained in the ascending order and should not be duplicated.

Level of Authorization Required

Specify the number of levels of authorization required.

This is a numeric text field and is used to capture the authorization level required for each of the identified transaction limit amount. This should be maintained in ascending order and should not be duplicated.

Role Identification

Specify the role from the adjoining option list. The Role ID identified for the captured Authorization Level is maintained in this field. This should be maintained in ascending order and should not be duplicated.

7.4.8.1 Validating Transaction Amount during Contract Processing

While saving a contract, the system will check the transaction amount against the cut-off amount maintained for the module, product and the currency involved in the transaction. If both the transaction currency and the limits currency are same, the comparison will be done directly. If different currencies are involved, the system will first convert the transaction amount into the cutoff amount currency using the STANDARD mid rate and then perform the validations.



To perform the check, the System will look for the limits maintained, in the following order:

1. The System looks for the limits maintained for a specific module and specific product combination
2. If the first option is not available, it checks the limits maintained for a specific module + ZALP (all products) combination
3. It checks the maintenance for AL (all modules) + ZALP (all products) combination

If the third option is also not available, the system displays an error message

When a transaction exceeds the amount limit, the system displays an override message while saving the transaction

7.5 Maintaining Sequence Generation Format

Every contract in Oracle FLEXCUBE is identified by a unique Contract Reference Number that is generated internally by the system. You are not allowed to modify this number. In addition, a contract is also identified by a unique User Reference Number. By default, the Contract Reference Number will be taken as the User Reference Number. But you have the option to change the User Ref Number.

Oracle FLEXCUBE also provides you the facility to generate the user reference number in a specific format.

To maintain a specific format, you need to identify the various components that would be part of the user reference number including details such as the length, order, value etc. of each component.

You can maintain a unique format through the 'Sequence Generation Input' screen. You can invoke this screen by typing 'CSDSEQGN' in the field at the top right corner of the Application tool bar and clicking the adjoining arrow button.

The screen appears as shown below:

Component Order	Component	Component Type	Use in Sequence Generation	Component Length	Component Value	Component
-----------------	-----------	----------------	----------------------------	------------------	-----------------	-----------

You can maintain the following details of the sequence format:

Sequence Code

Each sequence format is identified by a unique sequence code. You can devise a code comprising a maximum of 20 alphanumeric characters.

Branch Code and Module Code

You can maintain the format for a specific branch and module combination. Select the branch code and the module code from the option-list. All authorized and active records will be displayed in the list.

Alternatively, you can maintain a sequence format that will be applicable to all the branches (ALL) and all the modules (AL) available in your bank.

Reset Frequency

You need to specify the frequency at which the system will drop and recreate the sequence numbers once again. At the reset frequency that you specify, all sequence numbers of the sequence format will be dropped and recreated again during the End of Day processing.

The options available are:

- None
- Daily
- Monthly
- Yearly

For example, let us assume that the running number in the sequence format is 4 characters long (starting from 0001) and the reset frequency is Monthly. Further, let us assume that the sequence number of the last contract processed on the last day of the month is 0199. At EOD of the last day of the month, the sequence numbers generated till date will be dropped and the system will begin regeneration starting from 0001 once again for all subsequent contracts.

Range

You can specify a range of sequential reference numbers. If you specify such a range, then no additional details need be specified. If you do not specify a range, you can specify additional details specific to each component of the sequence format.

In addition to the above details, you should also maintain details specific to each component of the sequence format. The details are as follows:

Component Order

Each component is assigned an order number based on which they would appear in the user reference number. The component order is automatically generated by the system and is non-editable.

Component

Each component in the sequence format is identified as one of the following:

- An Oracle FLEXCUBE Component – If your sequence format uses an Oracle FLEXCUBE column directly, you can specify it as an Oracle FLEXCUBE Component. For instance, you may want to include the product group associated with the product code involved in a contract, as a component in sequence number generation. To achieve this, you will use the Oracle FLEXCUBE column PRODUCT_GROUP (available in the table CSTM_PRODUCT) as an Oracle FLEXCUBE Component.
- A User Component – You may want the first two characters of your bank's name to be part of all the user reference numbers generated at your bank. You can define it as a user component. In addition, if you want to use the manipulated value of an Oracle FLEXCUBE Column in the sequence format, you can specify it as a User Component. For eg, you may want to include ONLY the first four characters of the product group in the sequence number. In this case, the component would be defined as a User Component.
- A Separator – To separate the various components from one another, you can use the component known as the separator. Eg: a back slash, a hyphen etc.
- A Running Number – Each contract is identified by a unique sequence number. It is mandatory to maintain a running number as a component in the sequence format. If not included, you will not be allowed to save the details of the format. A running number is internally generated by the system.

Component Type

You need to identify the type of each component in the sequence format. A component can be constant through out or change for every contract processed at your bank. You can associate a component with one of the following types:

- Static – To include any hard coded component in the sequence format, you will specify the type to be static. For instance, you may want the first two characters of your bank's name to be part of all the user reference numbers generated at your bank. The component type would be static in this case.
- Dynamic – You will specify the component to be of the dynamic type if its value is picked up from the Oracle FLEXCUBE table. Eg: Product Group. A running number would always be dynamic in nature.

Use in Sequence Generation

You need to indicate whether the component being defined should be used in sequence generation or not. Specify 'YES' or 'NO' as per your choice.

You can also choose to display the reference number in the advices that are generated for a contract.

Component Length

You can also specify the length of each component in the sequence format. The component value is dependent on the component length maintained. For instance, if you specify 2 as the component length, the value should comprise of only two characters.

Component Value

As stated earlier, the component value is dependent on the component length. Based on the length, you can specify a value comprising of as many characters as specified in the Component Length field. However, this field is used only if the value of the component is required to be constant (static type) in all the user reference numbers generated at your bank. If the component value is changing constantly (Dynamic type) for every contract, the system will automatically pick up the value from the DB table based on the SQL query that you maintain for the purpose.

Component Column and Component Table

If your component is of the dynamic type, you will need to mention the name of the Oracle FLEXCUBE column from where the system will pick up the component value. Further, if you wish to include a manipulated column value in sequence generation, you will need to include 'SUBSTR' as well in the column name. For eg, to include only the first four characters of the product group associated with the product code involved in a contract, you will specify the following in the Component Column field:

```
SUBSTR (PRODUCT_GROUP, 1, 4)
```

You need to mention the table name also, if the component type is dynamic. The following table names are available in the option-list provided.

- DUAL
- STTM_BANK
- STTM_BRANCH
- CSTM_PRODUCT

For our example, the table name would be CSTM_PRODUCT.

Component Where Clause

The condition or the 'where clause' of the SQL code is specified here. In the example discussed above, the system will pick up the appropriate product group depending on the product code involved in the contract being processed. You can specify the following where clause as an extension of the SQL statement specified earlier:

```
WHERE PRODUCT_CODE = SUBSTR (P_CRN, 4, 4);
```

Click add icon to define each subsequent component in the format. Use the navigating icons to move between the various components of a sequence format.

8. Maintaining Currency Denomination

8.1 Introduction

In the Data Entry module, you can specify a break up of a transaction amount for Teller transactions by denomination. The system also maintains a break-up of the till balances by denomination.

In the 'Currency Denomination' screen, you maintain the standard currency denominations for each currency that your bank deals with. You can invoke this screen by typing 'CYDCDENO' in the field at the top right corner of the Application tool bar and clicking the adjoining arrow button.

Denomination Code *	Description	Value	Sequence Number	Type
<input type="checkbox"/> E100	100 Euros		100	1 NOTE
<input type="checkbox"/> E50	50 Euros		50	2 NOTE
<input type="checkbox"/> E20	20Euros		20	3 NOTE
<input type="checkbox"/> E10	10 Euros		10	4 NOTE
<input type="checkbox"/> E5	5 Euros		5	5 NOTE
<input type="checkbox"/> E1	1 Euro		1	6 NOTE
<input type="checkbox"/> C50	50 cent		.5	7 COIN
<input type="checkbox"/> C10	10 cent		.1	8 COIN

8.2 Maintaining Currency Denomination Details

To maintain the denominations of a currency, you need to specify the following:

- The code of the currency for which you are defining denominations
- A unique code to identify each denomination of the currency. For example, you can assign D1, D10, D50 for USD 1, 10, 50.
- A description of the denomination unit
- The denomination type coin or note
- The value of the denomination in relation to one unit of the currency. It could be a fraction for coins

Example

For the currency USD you can maintain the denominations as follows:

CURRENCY CODE	DENM CODE	DESCRIPTION	VALUE	NOTE / COIN
USD	D100	100 dollars	100.00	NOTE
USD	D50	50 dollars	50.00	NOTE
USD	D20	20 dollars	20.00	NOTE
USD	D10	10 dollars	10.00	NOTE
USD	D5	5 dollars	5.00	NOTE
USD	D1N	1 dollar Note	1.00	NOTE
USD	D1C	1 dollar Coin	1.00	COIN
USD	C25	25 cents	0.25	COIN
USD	C10	10 cents	0.10	COIN
USD	C5	5 cents	0.05	COIN
USD	C1	1 cent	0.01	COIN

9. Expressing Amounts in Words

9.1 Introduction

You can describe the amounts printed on account statements, messages, advices, etc., in words, for the benefit of your customers. To describe 'amounts' in a specific language, you have to maintain the verbal equivalents of numerals in the language. You can maintain verbal equivalents of numerals in the 'Amount Text Maintenance' screen.

You can invoke this screen by typing 'STDAMTRN' in the field at the top right corner of the Application tool bar and clicking the adjoining arrow button.

Amount *	Description	Prefix One
50 FIFTY		<input checked="" type="checkbox"/>
100 HUNDRED		<input checked="" type="checkbox"/>

Currency *	Pre Decimal	Post Decimal	Final Text	Text Before	Fractions
------------	-------------	--------------	------------	-------------	-----------

Fields

Input By MSK2 Date Time 7/3/2000 17:45:10 Modification Number 5 Open
Authorized By Date Time Authorized

Amount translation details can be maintained as one time maintenance at the time Oracle FLEXCUBE is installed at your bank. Once maintained, the amount descriptions printed on account statements, and other messages, will be described according to your specifications in this screen.

Language

You can maintain verbal equivalents of numerals in any language that Oracle FLEXCUBE supports. This means that you can maintain the verbal equivalents of numerals in as many languages as you generate messages.

Text

You must describe the following numerals in the Description field (in the language that you specify in the Language field):

- 1, 2, 3, upto 10
- 20, 30, 40, 50, 60, 70, 80, and 90
- 100
- 1,000
- 10,000
- 100,000
- 1,000,000
- 10,000, 000, and so on

In certain languages, One thousand, One million, and so on are expressed, simply, as 'thousand', and 'million'. If you are defining verbal equivalents of amounts in such a language, do not choose the 'Prefix One' option. Statements and messages printed in such a language will describe amounts such as '1000', simply, as 'thousand'.

Choose the 'Prefix One' option, if you would like amounts such as '1000' described as 'One thousand'.

Currencies

In this screen, you can also describe the pre-decimal and the post-decimal units of a currency in different languages. Enter the verbal equivalent of the 'pre' and 'post' decimal units of a currency in the Pre-Decimal and Post-Decimal fields respectively. For example, if you would like to describe the decimal units of USD, enter:

1. The currency in the Currency field
2. The pre-decimal description as 'Dollars'
3. The post-decimal description as 'Cents'
4. Final Text to be attached to the currency.

You can opt to prefix, or suffix, an amount with its currency. If you would like the suffix an amount with its currency, do not choose the 'Text Before' option. If you would like to prefix an amount with its currency, choose the 'Text Before' option.

For example, if you would like to describe USD 1000, as Dollars One Thousand, choose the 'Text Before' option.

10. Defining Currency Pairs

10.1 Introduction

In the foreign exchange markets, the exchange rates for some currency pairs such as the USD-GBP or USD-JPY are easily obtainable, since these are frequently traded. The exchange rates of other currencies such as the ZAR-INR (South African Rand - Indian Rupee), which is not traded very often, is determined through a third currency. This third currency is usually the US dollar, since the US dollar is quoted in all trading centres.

In the Currency pair definition screen, you define the static attributes of currency pairs for which a regular market quote is readily available. For other pairs, which do not have a regular market quote, you need to specify the third currency through which the system should compute the exchange rate. This screen need not be maintained for a currency pair if the third currency is the local currency (as defined in the Bank-wide Parameters screen) because, in the exchange rate computation the default third currency is assumed to be the local currency.

The currency pair screen is maintained at the bank level by your Head Office branch using the 'Currency Pair Maintenance' screen.

You can invoke this screen by typing 'CYDCPAIR' in the field at the top right corner of the Application tool bar and clicking the adjoining arrow button.

The screenshot shows a web-based form for defining currency pairs. The form is titled "Currency Pair Maintenance" and is displayed in a "Web Page Dialog" window. It contains several sections for data entry:

- Currency Pair:** Includes fields for "Currency1" (set to AUD, description "Australian Dollar") and "Currency2" (set to DEM, description "Deutsche Mark"). A "Through Currency" checkbox is checked.
- Through Currency:** Includes fields for "Code" (set to EUR) and "Description" (set to EURO).
- Number Of Units:** Radio buttons for "One", "Hundred", and "Thousand".
- Spread Definition:** Radio buttons for "Percentage".
- Quotation Method:** Radio buttons for "Direct".
- Fields:** A footer section containing user and system information: "Input By VIJAYALAK", "Date Time 7/3/2000 16:50:36", "Modification Number 1", "Open" (checked), "Authorized By", "Date Time", and "Authorized" (unchecked). An "Exit" button is also present.

10.2 System Features

From among the currencies maintained in the currency screen, the system builds all possible combinations of currencies in pairs. For example, if you have maintained the following currency codes: USD, DEM, YEN. The system will give you a choice of defining parameters for the following pairs.

- USD-DEM
- USD-YEN

- DEM-USD
- DEM-YEN
- YEN-USD
- YEN-DEM

It is however, not obligatory to define parameters for all these pairs. A currency pair needs to be maintained only if:

- You want to define a direct exchange rate for the pair: for frequently traded currencies like DEM-USD or USD-GBP or USD-JPY for which market quotes are available.
- You want to define a through currency for the pair: for those currencies which are not so well traded, market quotes may not be available. Therefore you can route the conversion rate for the pair via a 'through currency'. For example, in the case of GBP-NLG, for which a direct exchange rate may not be available, you can define a through currency say, USD. The exchange rate between GBP-USD and NLG-USD will be picked up by the system to compute the exchange rate between GBP-NLG.

In the absence of a direct exchange rate, the system will look for a through currency to compute the rate. If a 'through currency' has not been maintained then the default local currency will be picked up as the through currency to compute the rate for a currency pair.

10.3 **Maintaining Parameters for Currency Pair**

Currency Pair

A currency pair (specified as Currency1 and Currency2, in the Currency Pair screen) represents the two currencies for which you need to maintain exchange rates.

To specify the pair, choose from the list provided against Currency1. Select the pair for which you want to maintain parameters.

The pair should be selected according to the quotation method followed by the market, which could be direct or indirect (for details refer to the field 'quotation method'). Exchange rates can be defined for currency1 against currency2 or currency2 against currency1.

The descriptions of the respective currencies are displayed below.

Through Currency

If the exchange rate for a particular currency pair is not to be maintained, specify the 'Through Currency' via which the exchange rate between the currencies should be calculated.

To maintain a through currency for a currency pair, check against the box 'Through Currency'.

Then choose from the list codes provided against Code, Select the currency code, which you want to specify as the 'through currency'. The exchange rate for the currencies involved in the pair will be calculated using the through currency.



While maintaining a pair involving an 'In' currency ('In' – 'Out' and 'In' – 'In'), you can only specify the Euro as the 'Through Currency'. Please note that you cannot maintain a 'Through Currency' for a pair constituted by an 'In' currency and the Euro.

For more details on the manner in which Oracle FLEXCUBE handles the Euro, refer the chapter 'Handling the Euro' in this manual.

Whenever, you define a through currency for a currency pair, you will not be allowed to specify the following for the pair:

- Number of units
- Spread definition

Quotation Method

This is the method to be followed for quoting the exchange rate. There are two methods direct and indirect.

In the Direct method the exchange rate for the currency pair is quoted as follows:

Buy rate = mid rate - buy spread

Sell rate = mid rate + sell spread

Ccy 1 = Rate x Ccy 2

In the Indirect method the exchange rate for the currency pair is quoted as follows:

Buy rate = mid rate + buy spread

Sell rate = mid rate - sell spread

Ccy 2 = Rate x Ccy 1

Example

The market follows the direct quote convention for the currency pair USD-DEM e.g., 1USD=1.6051DEM. To maintain this pair, you would specify currency 1 as USD and currency 2 as DEM, and specify "direct" in this field.

For the USD-GBP pair, which is quoted indirectly (1 GBP = 1, 5021 USD), the USD will be defined as currency 1 and the GBP as currency 2, with the quotation method "indirect".

Number of Units

This indicates the number of units of currency to be used for currency conversion

Example

Quotation Method	No. Of Units	Formula for calculating conversion rate
Direct	1	$1\text{ccy1} = \text{rate} \times \text{ccy2}$
Direct	100	$100\text{ccy1} = \text{rate} \times \text{ccy2}$
Direct	1000	$1000\text{ccy1} = \text{rate} \times \text{ccy2}$
Indirect	1	$1\text{ccy2} = \text{rate} \times \text{ccy1}$
Indirect	100	$100\text{ccy2} = \text{rate} \times \text{ccy1}$
Indirect	1000	$1000\text{ccy2} = \text{rate} \times \text{ccy1}$

Spread Definition

You need to indicate the method in which the spread for a currency pair needs to be defined. There are two ways of defining the spread -- in points and in percentage.

The effective spread can be calculated using any of the following two methods:

- In points — spread x points multiplier
- In percentage — spread/100 x mid rate

Example

We shall examine the impact of each of these spread definition methods on the currency pair USD: DEM.

Mid rate = 1.6040

Spread = 10

In points the buy rate and sell rate would be calculated as:

Buy rate = Mid rate - spread x points multiplier

Sell rate = Mid rate + spread x points multiplier

If points multiplier = .0001 then

Buy rate would be = $1.6040 - 10 \times .0001$

Sell rate would be = $1.6040 + 10 \times .0001$

In percentage the buy rate would be calculated as:

Buy rate = Mid rate - spread x points multiplier

Sell rate = Mid rate + spread x points multiplier

Buy rate would be = $1.6040 - 10/100 \times 1.6040$

Sell rate would be = $1.6040 + 10/100 \times 1.6040$

The default-spread definition is through the points method.

The method of spread definition that you specify here applies to two instances:

- While maintaining exchange rates for this currency pair
- While maintaining Customer Spread for this currency pair

10.3.1 **Specifying Points Multiplier**

Points are the smallest unit of measurement in the exchange rate of a currency pair. If you have opted for a points system of defining spread, you should specify the multiplication factor for the points to compute effective spread.

Suppose for the currency pair USD-DEM your rates are as follows:

Mid-Rate: 1.6045

Buy rate: 1.6040

Sell rate: 1.6051

The effective buy spread is 0.0005 (1.6045 - 1.6040) and the effective sell spread is 0.0006 (1.6051 - 1.6045).

In the Rates screen, where you define rates and spreads for a currency pair, you can specify the buy and sell spreads as 5 and 6 instead of as 0.0005 and 0.0006 (i.e., as spread points), and specify here the points multiplier as 0.0001.

The effective spread, buy and sell rates are then computed as follows:

Effective buy spread = Buy spread x Points multiplier = 5 x 0.0001 = 0.0005

Buy rate = Mid rate - Buy spread = 1.6045 - 0.0005 = 1.6040

11. Maintaining Exchange Rates

11.1 Introduction

In the Currency Rates screen, you can maintain exchange rates for a currency pair, the rates at which you buy and sell one currency for another.

A bank determines its buy and sell rate for a currency pair by applying a spread (i.e., its profit margin) to the mid-rate of the currency pair. Mid rate is the basic rate at which a currency pair is exchanged.

The spread applied for a currency pair varies with the transaction type, while the mid-rate usually remains constant. Consequently, different rates are applicable to different transaction types. For instance dollars in currency are purchased at a certain rate, while USD traveler's checks are bought at a different rate. In Oracle FLEXCUBE, you can define a rate type which you would like to associate with a transaction type e.g., 'CASH', 'TRAVCHKS', etc., in the Rates screen.

In the Currency Rates Maintenance screen, you define the mid-rate, buy and sell spread applicable to each rate type; the buy and sell exchange rates are computed by the system.

Buy rates and sell rates can either be maintained by individual branches or can be input by the HO and propagated to all the branches. If in the Bank-wide parameters - Preferences screen you have specified your preference as 'copy exchange rates to branches' then the 'currency rates maintenance' screen is maintained at the bank level by your Head Office. These rates are then propagated to the branches. The branches can only view the rates but cannot make changes to them.

In the Bank-wide Preferences screen, if you have not specified 'copy exchange rate to branches' then the 'Currency Exchange Rates Input' screen is maintained at the branch level by the different branches.

You can invoke this screen by typing 'CYDRATES' in the field at the top right corner of the Application tool bar and clicking the adjoining arrow button.

The screen appears as shown below:

<input type="checkbox"/> Rate Type *	Mid Rate	Buy Spread	Sale Spread	Buy Rate	Sale Ra
<input type="checkbox"/> BILLS	.797	.0025	.0025	.7995	
<input type="checkbox"/> CASH	.797	.0025	.0025	.7995	
<input type="checkbox"/> STANDARD	.797	.002	.002	.799	
<input type="checkbox"/> TC	.797	.002	.002	.799	
<input type="checkbox"/> TT	.797	.0018	.0018	.7988	

In this screen you maintain the following parameters for each rate type of a currency pair:

- Mid rate
- Buy spread and Sale spread
- Buy rate and Sale rate

Specify the currency pair for which you want to compute the exchange rates. The pair should be selected keeping in mind the quotation method for exchange rates as followed by the market. The system offers the choice of maintaining both the currencies as currency1 or currency 2 -- USD against DEM and DEM against USD.

For the pair specified the following parameters need to be maintained to arrive at the buy and sell rate of currencies:

- Rate Type
- Mid Rate
- Buy Spread
- Sell Spread
- Buy Rate
- Sell Rate

Rate Type

This is the rate type for which you are maintaining exchange rates for a currency pair. For different transaction categories your bank would like to maintain different exchange rates. For example, traveler's check is purchased at a certain rate whereas a bill of exchange is bought at a different rate.

In the front-end-modules, where you define products to cater to the various transaction types of your bank, you can link an appropriate rate type to the product. For instance, you create a product to cater to outgoing cross currency transfers by SWIFT. For this product, if you define the rate type to be STANDARD then for all contracts linked to this product, the Standard Rate Type would be applied.

Mid Rate

Mid rate is an indicative exchange rate for a currency pair. It is the average of the buy and sell rate quoted by the market for a currency pair.

Example

Suppose, currency 1 = USD

Currency 2 = DEM

Buy rate -- 1 USD = 1.7020 DEM

Sell rate -- 1 USD = 1.7040 DEM

Mid-Rate = 1.7030

Buy Spread

This is the buy spread for a currency pair. It can be defined as the profit margin specified over the mid rate when you buy currency 1 for currency2. You can define the buy spread in two ways -- either in points or in percentage. The system computes the effective buy spread for you.

Sale Spread

This is the sell spread for a currency pair. It can be defined as the profit margin specified over the mid rate when you sell currency 1 for currency 2. You can define the sell spread either in points or in percentage. The system computes the effective sell spread for you.

Buy Rate

Buy rate is the rate of exchange for a currency pair, which is computed by the system based upon the mid rate, the spread specified, the spread definition and the quotation method maintained in the 'Currency definition' screen.

Sale Rate

Sell rate is the rate of exchange for a currency pair, which is computed by the system based upon the mid rate, the spread specified, the spread definition and the quotation method maintained in the 'Currency definition' screen.

You can also input the buy and sell rate for a currency pair. In which case, the system will compute the spread for the rate type.

Rate Date

This is a display field. When you enter the exchange rate for a currency pair, the system will default the Rate Date as the Application Date. The rate date will always be less than or equal to the application date.

Rate Serial

This is a running serial number for the Rate Date. You need to specify the serial number. Your entry will be validated for uniqueness. For example, there could be only one exchange rate between USD and EUR for 31/07/2003 with Rate Type STANDARD with Rate Serial as 0001. Thus, this will be a unique rate serial for a currency pair, rate type combination for a given rate date.

When you enter the exchange rate for a currency pair, the system will default the Rate Date as the Application Date and the Rate Serial as the latest available serial for the currency pair + 1. The Rate Serial Number will be system generated. However, you can modify it if required. This number takes into account the Rate Serial Number present in the Currency Rates History screen too. The Rate Serial Number and the Rate Date will be displayed during authorization of the Rate in the Currency Authorization screen.

11.1.1 Authorizing Exchange Rates

Authorization of exchange rates is done from the Currency Exchange Rates input screen. Details like old value, new value for each field (buy rate, mid rate etc) are displayed. Click  to authorize the record.

11.1.2 Revising Exchange Rates

For revising the exchange rates for your bank or the branches invoke the 'Currency Maintenance' screen. Click the currency pair whose exchange rate you want to revise and click  on the toolbar or unlock in the Action menu. Input/modify the new rates for the pair.

11.1.3 Viewing Exchange Rates

You can view the exchange rates in the 'Currency Exchange Rates View' screen. You cannot input any values. You also have the option of specifying whether you want to view authorized rates or the unauthorized rates for any currency pair.

You can invoke this screen by typing 'CYSRATES' in the field at the top right corner of the Application tool bar and clicking the adjoining arrow button.

The screen appears as shown below:

Authorization Status	Record Status	Branch Code	Currency1	Currency2
U	O	CHO	AUD	CHF
A	O	CHO	AUD	EUR
A	O	CHO	AUD	GBP
A	O	CHO	AUD	INR
A	O	CHO	AUD	USD

If the branches pick up the exchange rates maintained by the HO, then each time you invoke the 'currency view' screen from a branch it is advisable to update this screen with the latest rate input, from the HO. To do this, click on 'Refresh'. Refresh updates the screen with the last exchange rates input.

11.1.4 Specifying Limits for Cross Currency Transactions

Typically, the exchange rates applicable for cross currency funds transfer or teller transactions is defaulted by the system depending upon the preference indicated in the product preferences, for the product involving the transaction.

In your bank, for high-value cross currency transactions, you may want the user to manually enter the exchange rate involved, rather than let the system automatically pick up a default rate during transaction input.

You can define such a preference to be applicable to cross currency transactions involving:

- A currency pair
- A specific product, or all products
- A specific module, or all modules

- A specific branch, or all branches
- A specific rate code

The transaction amount limit, above which the exchange rate must be entered, for a high value transaction, could be defined in terms of currency pair where the currency of the transaction is currency1 in the CCY pair defined in the maintenance.

Example

In the San Francisco branch of your bank, you do not wish to allow default of exchange rates automatically for funds transfer payments for the currency pair USD GBP exceeding 10000 USD.

So this Limit Amount of 1000 USD will be maintained as follows:

Branch – 000, Module – FT, CCY1 – USD, CCY2 – GBP

Rate Code – Standard, Limit CCY– USD, Limit Amount – 100000

When an FT transaction with transaction currency as USD happens where the offset currency is GBP, the system will check for the Limit Amount defined for the currency pair USD-GBP. If the transaction amount is more than the limit amount defined here, the system will not default the exchange rate for the pair. Instead, it will force the User to enter the rate manually for the transaction.

To ensure that users manually enter exchange rates for high-value cross currency transactions in Oracle FLEXCUBE, you must specify the limit amounts that must be validated for each transaction in terms of currency pair, product, module, and branch combination. You can use the 'Product Limits Maintenance' screen to specify the limits.

When you have specified these limits, the system automatically validates the amount with each transaction for the currency pair, product, module and branch combination, and accordingly, if the limits are exceeded, enforces the manual entry of exchange rates.

In case, the limit between ccy1 and ccy2 is given in ccy2, the system will automatically convert the transaction amount to an amount in ccy2 using standard mid rate and check against the limit amount whether or not manual entry of exchange rates is required. You can invoke the 'Product Limits Maintenance' screen, by typing 'CSDPXMNT' in the field at the top right corner of the Application tool bar and clicking the adjoining arrow button.

The screen appears as shown below:

Product Limits Maintenance -- Web Page Dialog

Branch Code * 0AA
Module Code * FT
Product Code * ALL
Currency1 * AAA
Currency2 * CHF

<input type="checkbox"/> Rate Code *	Limit Currency *	Limit Amount *
<input type="checkbox"/> CASH	CHF	1,000.00

Fields

Input By PRAGNYA Date Time 7/3/2000 17:08:24 Modification Number 3 Open
Authorized By Date Time Authorized

Branch Code

You must specify the branch for which the limit amount will be applicable. You can specify that the limits must be applicable for all branches.

Module Code

You must specify the module for which the limit amount will be applicable. You can indicate that these limits must be applicable for both the Data Entry (DE) and Funds Transfer (FT) modules.

Product Code

You must specify the product, transactions involving which the limit amount will be applicable. You can specify that the limits must be applicable for all products.

Currency 1

You need to specify the currency1 applicable for defining the Transaction Amount limit, beyond which the system will not default the Auto Exchange Rate.

All valid currencies defined in the Currency Pair Maintenance will appear for selection. This currency is always the transaction currency of the contract.

Currency2

You need to specify the currency2 applicable for defining the Transaction Amount limit, beyond which the system will not default the Auto Exchange Rate.

All valid currencies defined in the Currency Pair Maintenance will appear for selection. The Currency2 should be part of a Currency Pair Maintenance in which the Currency1 defined here is the first currency. Currency 2 can be specified as ALL.

11.1.4.1 Specifying Limit Details

Rate Code

You need to specify the Rate Type (code) for the Exchange Rate Limit

Limit Currency

You need to specify the currency in which the Limit Amount should be expressed. All valid currencies defined in the system will be applicable for selection. There will be a validation for the limit currency as either Currency1 or Currency2.

Limit Amount

You need to specify the maximum amount up to which the system should default the Exchange Rate or perform the Rate Variance validation.

11.1.4.2 Validating Exchange Rate Limits

The Funds Transfer Contract Input will default the Rate only if the Transaction Amount is less than the Maximum Amount defined for the Rate Code maintained at the product level for FT. If the amount is more than the specified amount, then the system will not default the Rate. Instead, it will force the user to enter the Rate. Once the user enters the Rate, the system will not add the Customer Spread etc. as this will be final Exchange Rate for the contract.

The Rate Variance validation will also be done only if the amount is less than the maximum amount defined for the Rate Code maintained at the product level for FT. If the amount is more than the specified amount, the system will not perform the Rate Variance validation. Instead, there will be an override to specify that the transaction amount is greater than the maximum amount for Rate Variance check.

For details about how limits are applied when a transaction is entered, refer the chapter Processing a Funds Transfer, in the Funds Transfer user manual.

12. Maintaining Currency Spread for Customer

12.1 Maintaining Customer Spread Details

For a customer and currency pair, you can maintain tenor-wise spread details in the 'Customer Spread Maintenance' screen.

You can invoke this screen by typing 'CYDCUSPR' in the field at the top right corner of the Application tool bar and clicking the adjoining arrow button.

Tenor	Buy Spread	Sale Spread

In this screen, for a customer and currency pair, you can maintain buy and sell spreads for different tenors.

You need to maintain customer spreads in each branch. Transactions initiated in a branch will pick up the spread(s) maintained for that branch.



Note the following:

- Funds Transfer, Loans and Deposit contracts have tenor = 0 (zero). Therefore, you need to maintain Customer Spreads for zero tenor also.
- The tenor is specified in days

12.1.1.1 Specifying Spread Details

When processing an FX deal involving a customer (for whom you have maintained spread details), the system picks up the customer spread corresponding to the tenor of the deal and builds it into the exchange rate. If spread details are unavailable for a specific tenor, the system picks up the spread defined for the nearest lower tenor.

For example, assume for a customer and currency pair you maintain spread details for the following tenors: '3', '5', and '10' days. When processing a deal with a tenor of '4' days (involving the customer and the currency pair), the system picks up the spread details defined for a tenor of three days. This is because spread details for a '4' day tenor is unavailable for the customer and currency pair.



You can also maintain customer spreads for the wildcard entry – ALL. If spread details for a specific counterparty (for the currency pair) are unavailable, the System looks for the customer spread maintained for the wildcard ALL entry. If even that is not available, then the customer spread defaults to zero.

12.1.2 Computing Buy and Sell Spreads

Using percentage system -- suppose the bank wants to make a profit of 5% over and above the mid rate quoted. Suppose the dealing currencies are USD and AUD. 1USD = 1.4166 AUD for Standard rate type. (Mid rate being 1.4166). Now to arrive at the spread the bank will use the following formula:

$$\text{Spread} = 5 / 100 \times \text{Mid rate (1.4166)} = 0.07083$$

Example

Currency Code 1	Currency Code 2	Rate Type	Mid Rate	Buy Spread	Sale Spread
USD	AUD	STD	1.4166	0.07083	0.07083
USD	AUD	TT	1.3666	0.06833	0.06833
USD	AUD	CASH	1.2666	0.06333	0.06333

Using the points system -- suppose the point quoted by the bank is 708.3. The points multiplier in this case would be 0.0001 (depends on the decimal points that the mid rate extends to. Usually it is 4 decimal places).

$$\text{Spread} = \text{Points (708.3)} \times \text{Points Multiplier (0.0001)}$$

Now coming to the buy and sale rate computing, there are two ways of computing the buy and sale rates -- Direct and Indirect. Depending upon the quotation method you have specified in the Currency pair screen, the system computes the spreads.

In the **Direct** method, the buy and sell rates are calculated as follows:

$$\text{Buy Rate} = \text{Mid-Rate} - \text{Buy Spread}$$

$$\text{Sell Rate} = \text{Mid-Rate} + \text{Sell Spread}$$

For cross currency contracts, the rate for the currency pair is:

1 unit of Ccy 1 = Rate * 1 unit of Ccy 2

In the **Indirect** method, the buy and sell rates are calculated as follows:

Buy Rate = Mid-Rate + Buy Spread

Sell Rate = Mid-Rate - Sell Spread

For cross currency contracts, the rate for the currency pair is:

1 unit of Ccy 2 = Rate * 1 unit of Ccy 2

Example

You have entered into a Buy contract and the currency pair involved is USD/AUD (where 1 USD = 1.4166 AUD). In the Currency Rate Maintenance screen, the following details are maintained:

Mid-Rate - 1.4166 (from the Currency screen)

Rate Type - STD

Buy Spread - 0.07083

Sell Spread - 0.07083

You have specified the Quotation method for this currency pair as Direct in the Currency Pair screen. In this method, the Buy Rate is calculated as -- Mid-Rate - Buy Spread. So the Buy Rate for this contract is:

$$\text{Buy Rate} = 1.34577 = (1.4166 - 0.07083)$$

In addition, you have the option of defining the fields that should be computed and those that should be input. You can either input the buy and sale rates and get your spreads computed by the system or define the spreads and let the system compute the rates.

The method of spread definition – percentage or points – that you have maintained for the currency pair is displayed on this screen.

12.1.3 Maintaining Currency Margins for Customer

For each customer of your bank you can define buy and sell margins for a specific currency. This spread is applied to floating interest components that involve the customer and currency combination.

You can define buy and sell margins for a customer in the Customer Spread Maintenance screen invoked from the Application Browser. You can invoke this screen by typing 'CFDCUMRG' in the field at the top right corner of the Application tool bar and clicking the adjoining arrow button.

The margin that you define will be appropriately picked up and applied to arrive at the final rate that is applied to floating components of contracts that involve the customer - currency combination.

The buy and sell margins that you define are for a customer and currency combination. You can select the customer and currency combination from the option lists available.

For the selected currency – customer combination, you can define amount slabs and specify a Borrow and Lend margin for each slab. To add a slab to the list click add icon and enter the slab details. To remove a slab from the list, highlight it and click delete icon.

Whenever you enter a contract in Oracle FLEXCUBE that involves the customer and currency combination, the appropriate spread is applied to arrive at the floating rate to be charged. The slab is selected based on the contract amount and depending on the nature of the contract, the Borrow or Lend spread is applied.

Customer * MARKT
Currency * AAA

BORROWLEND * Borrow
 Lend

Amount Slab	Spread
999999	.025

Fields

Input By ASH Date Time 7/3/2000 12:38:26 Modification Number 1 Open
Authorized By Date Time Authorized **Exit**

12.1.3.1 Making Margin Applicable to All Customers

For a given currency, you can define borrow and sell margins to be applied to All customers. At the customer field choose ALL. However, if you have maintained currency margins for a specific customer and currency combination, it takes precedence over the margin defined for all customers.

Currency margins can be maintained for customers across branches. In effect, a branch can maintain margins for a customer belonging to another branch. These margins are propagated across branches of your bank.

13. Defining Currency Rate Types

13.1 Introduction

Banks quote different exchange rates for different transaction types. For instance, traveler's checks are purchased at a certain rate; a different rate is applicable for buying of foreign currency notes, and so on.

In the 'Currency Rate Type Definition' screen, you define the rate types applicable to the different transaction categories of your bank. Each rate type is assigned a code. For instance, you could define a rate type called CASH, which will be applicable for all cash transactions in foreign currency; TRAV-CHKS for traveler's checks buying and selling, and so on. The buying and selling rates for each rate type are defined in the 'rate definition screen'.

In the front-end-modules, where you define products to cater to the various transaction types of your bank, you can link an appropriate rate type to the product. For instance, you create a product to cater to outgoing cross currency transfer by SWIFT. For this product if you define the rate type to be STANDARD then for all contracts linked to this product the Standard Rate Type would be effective.

The currency Rate Type Definition screen is maintained at the Bank level by your Head office branch. You can invoke this screen by typing 'CYDCRTYP' in the field at the top right corner of the Application tool bar and clicking the adjoining arrow button.

The screenshot shows a web-based application window titled "Currency Rate Type Maintenance -- Web Page Dialog". The main content area displays a form for defining a currency rate type. The "Type" field is populated with "CASH" and is marked with an asterisk (*). The "Description" field is also populated with "CASH". Below the form, there is a "Fields" section containing a table of system-generated information:

Input By	SCRIPT5	Date Time	12/28/1999 16:11:42	Modification Number	1	<input checked="" type="checkbox"/> Open
Authorized By	SCRIPT5	Date Time	12/28/1999 16:11:42			<input checked="" type="checkbox"/> Authorized

An "Exit" button is located in the bottom right corner of the form area.

In this screen you can maintain the following:

Type

Currency types in which your bank may be dealing with -- like cash, travelers check, telegraphic transfer etc

Description

Specify a description of the rate type

14. Maintaining Floating Rates

14.1 Floating Rates

A Floating Rate corresponds to the market rates for the day. These rates are maintained and updated daily (or whenever they change), in the 'Floating Rates Maintenance' screen. The rates can be applied on a loan with or without a spread.

You can invoke this screen by typing 'CFDFLTRT' in the field at the top right corner of the Application tool bar and clicking the adjoining arrow button.

The screenshot shows a web-based dialog box titled "LD MM Floating Rate Input -- Webpage Dialog". It features several input sections:

- Rate Code:** Includes fields for "Branch Code *", "Rate Code *", and "Description".
- Tenor Basis:** Radio buttons for "Days" (selected) and "Months".
- Currency:** A table with one row containing "Currency Code *".
- Effective Date and Amount Slab:** A table with one row containing "Amount Slab *", "Effective Date *", and "Borrow Lend Ind *".
- Tenor and Intreat Rate Details:** A table with one row containing "Tenor *" and "Interest Rate".

At the bottom, there are fields for "Input By", "Date Time", "Modification Number", "Authorized", and "Open", along with a "Cancel" button.

A Floating Rate Code identifies a set of rates defined, for a combination of Currency, Amount Limit, Tenor and Effective Date. The initial criteria for the rate calculation to happen successfully is that there should be a Zero tenor/Non zero tenor based rate slab existing for the particular Buy/Sell Indicator with Effective date less than/equal to the Value date.

You can associate a Floating Rate to a contract by linking the Rate Code to the contract. The rates defined for the Rate Code will be applied to the contract based on the application preferences that you set up here.

Branch and Rate Code

Specify the branch and rate for which the preferences (effective date, amount slab etc) are being set up

Tenor Basis

Select the basis of the tenor for loans from the following options:

- Days
- Months

The system allows maintaining only one record for a combination of Branch and rate code.

14.1.1.1 Specifying Currency Details

You can associate several currencies with a Rate Code. For example, you can have a Rate Code 'TERMLON45' (with a description of Rates for a Term Loan of 45 days). You can define rates for the same Rate Code in different currencies. Thus, you can define a set of rates, for contracts in USD and another set for contracts in GBP.

Click add icon and select a currency code, from the option list available.

When you link a contract in USD to the Rate Code TERMLON45, the rates defined for this currency will be applied. Similarly, if the contract is in GBP, the rates defined for that currency would be applied.

14.1.1.2 Specifying Effective Dates and Amount Slab

Amount Slab

A floating rate can be defined as per an amount slab structure. You should specify the upper limit of the slab to which a particular rate should be applied.

Example

Suppose the following is the slab structure you want to maintain for the Rate Code – FL01 and Currency – USD.

Amount Slab
250 Thousand
1 Million
3 Million
3 Million

The Basis Amount To for the first slab or tier should be indicated as 250,000 that for the second slab as 1,000,000, and so on.

In case component amount is greater than the highest slab, the appropriate rate for highest amount slab is picked up and applied. Similarly, if the component amount is lesser than the lowest amount slab, the appropriate rate for lowest slab is picked up and applied.

Effective Date

Each rate that you define for a Rate Code and Currency combination should have an Effective Date associated with it. This is the date on which the rate comes into effect. Once a rate comes into effect, it will be applicable till a rate with another Effective Date is given, for the same Rate Code and Currency combination.



The revised rates will be applied on specific effective dates depending on whether it has been defined, with Auto Rate Code Usage or Periodic Rate Code Usage. You can specify this in the Product ICCF Details screen.

Borrow Lend Ind

Here you indicate the type of contracts to which the floating rate should be applied. Select one of these options from the picklist:

- Borrow
- Lend
- Mid

Typically, a floating rate maintained as Borrow can be applied on Deposits. Rates marked with Lend can be made applicable to Loans and Bill contracts.

Tenor

For each amount slab that you define for a Floating Rate Code, you can define tenors and indicate the rates applicable to each tenor. The rate will be applied to contracts based on the slab into which it falls and the reset tenor defined for the component.

15. Period Code Maintenance

15.1 Introduction

Banks, like all business houses compute their profits and losses and assess their financial position at the end of each financial year, which typically extends to 12 months -- from January to December or from March to April. However, this could be changed, depending upon the Bank's policies and regulatory requirements.

For interim reporting needs, the financial year is further divided into accounting periods, the duration of which is again determined by the bank's accounting requirements. For example, your bank's Board of Directors meets once a month therefore, you would divide the financial cycle into monthly periods.

The financial year and the accounting periods are referred to in the Oracle FLEXCUBE system as the 'Financial Cycle' and the 'Financial Periods' respectively and are maintained at the bank level by your Head Office branch.

At the end of each financial period and financial cycle you can generate profit and loss statement and a balance sheet. The system also offers you the flexibility of keeping a financial period/financial cycle open, allowing you to post adjustments to it and obtain a revised profit or loss statement/balance sheet. You can maintain these details in the 'Period Code Maintenance' screen.

15.2 Invoking Period Code Maintenance Screen

You can invoke this screen by typing 'STDACPER' in the field at the top right corner of the Application tool bar and clicking the adjoining arrow button.

The screen appears as shown below:

Period Code *	Start Date	End Date *
<input type="checkbox"/> QT1	1/1/1998	3/31/1998
<input type="checkbox"/> QT2	4/1/1998	6/30/1998
<input type="checkbox"/> QT3	7/1/1998	9/30/1998
<input type="checkbox"/> QT4	10/1/1998	12/31/1998
<input type="checkbox"/> FIN	1/1/1998	12/31/1998

In this screen you define the following:

- The financial cycle of your bank giving the start date and end date of each financial year
- The period group - financial periods into which each financial cycle is to be divided

The following are the features of the Period Code screen

Financial Cycle

For each financial cycle you maintain the following parameters:

Cycle

This is a code for the financial cycle. It acts as an identifier for the cycle. For example, while posting adjustments into a previous financial cycle -- you would identify the year through this code.

Input the code using a maximum of 9 characters, alphanumeric.

Example

The financial cycle extends from 1st April to 31st March in India. A bank here could define its code for the year 1996-97 as FY 1996-97.

Description

This describes the financial cycle. Enter description using a maximum of 35 characters, alphanumeric. Taking the above example, you could enter Financial Year - 1996-97.

Start Date

This is the first day of this Financial Cycle

End Date

This is the last day of this Financial Cycle

Period Group

The financial cycle defined above, can be divided into different accounting periods. To define individual accounting periods click on the first row under period code. A period called 'FIN' is created by the system. This is an open ended period coinciding with the last day of the financial cycle (for details refer to the section 'System Functions').

You can maintain the following parameters for each accounting period within a financial cycle:

Period Code

This code identifies the accounting period. Enter a code using a maximum of 3 characters, alphanumeric. For example, if your period length is a quarter you can enter - Q1 for the first period; Q2 for the second; Q3 for the third and so on. If your period length is a bimonthly you can enter BM1, BM2. If your period length coincides with a month you can input M1, M2.

Start Date

This is the first day of the corresponding period

End Date

This is the last date of the corresponding period. 'End date' of a period should always end on a month end. Please note:

- The period codes could be of varying lengths but no gaps should be left between periods
- The duration of two periods should not overlap
- You can modify the period code of the current or a future period; however, a past period cannot be modified even if it has not been closed
- All details maintained in the 'Period Code Screen' will automatically apply to any new branch opened by you in the Branch Parameters Screen
- The current financial cycle code and the current period code are displayed in the 'Branch Parameters Screen'

Period Code Status

After authorisation, you can view whether a financial period is open or it has been closed. Each branch can view the status of a period in every other branch. Click the period whose status you want to view.

Branch

Displays the codes of the different branches of your bank

Status

Displays the corresponding status of the period code highlighted. 'O' - indicates open status; 'C' - indicates closed status



The current financial cycle code and the current period code are displayed in the 'Branch Parameters Screen'

All details maintained in the 'Period Code Screen' will automatically apply to any new branch if incorporated to your bank post maintenance of this screen. The status of all periods in the new branch will be open.

15.3 System Functions

The system offers you the flexibility of posting transactions into a previous accounting period which has passed its due end date. For example, let's assume your bank's financial cycle extends from 1st January to 31st December; the first period starts on 1-01-96 and ends on 31-03-96. Even beyond 31-03-96 you can keep the period open to be able to post for example, expense bills you expect to receive in April. After you have posted all adjustments, you can close the period.

Even after you have closed the last accounting period of a year, the system offers you the flexibility of posting adjustments to the financial year.

For each financial year the system generates an open status period called FIN. Its start and end dates coincide with the last date of the financial cycle. Into this one day period you can post the accumulated profits and loss for the financial cycle, general reserves, and statutory reserves for the current year after paying off the dividends. After this one day period is closed the status of the financial cycle in the made by field 'status' is displayed as closed. With this the financial year stands closed and no adjustments can be posted to it.

Closure of a period/financial cycle can be invoked through the General Ledger/ Core Services module. The branches of the bank should close this period/financial cycle.

16. Status Code Maintenance

16.1 Introduction

Loans and bills, which are past their due maturity date of installment re-payment, but remain unpaid, are defaulted contracts. In the Oracle FLEXCUBE system these defaulted contracts can be assigned to different statuses, based on the number of days for which the contract is outstanding.

Each status can be assigned a code. For instance, you can define a status code PDO to represent 'past due obligation', and specify a period of 15 days after which an outstanding contract should be marked as 'PDO'. If they are due for more than 60 days, you could assign a 'doubtful' status; 'sub-standard' if due for 6 months, and so on. Contracts for which no installments are due, or which are regularly paid on their due dates are assigned the status 'Active' by the system. According to the number of days of default defined for each status, a loan would be moved from 'Active' to PDO status, then to doubtful and finally to sub-standard status.

Similarly, you can define status codes for current and savings accounts also. Current and Savings accounts that have not generated any interest over a specific period or have remained inactive with interest overdue may be identified as 'NPAs' (Non-Performing Asset). In Oracle FLEXCUBE, you can assign these accounts different status codes and define status criteria based on which the status movement will occur.

Refer the 'Core Entities' user manual for details on associating status codes with a customer account class /account.

These status codes are maintained in the 'Status Codes Maintenance' screen.

16.2 Invoking Status Maintenance Screen

You can invoke this screen by typing 'STDSTCOD' in the field at the top right corner of the Application tool bar and clicking the adjoining arrow button.

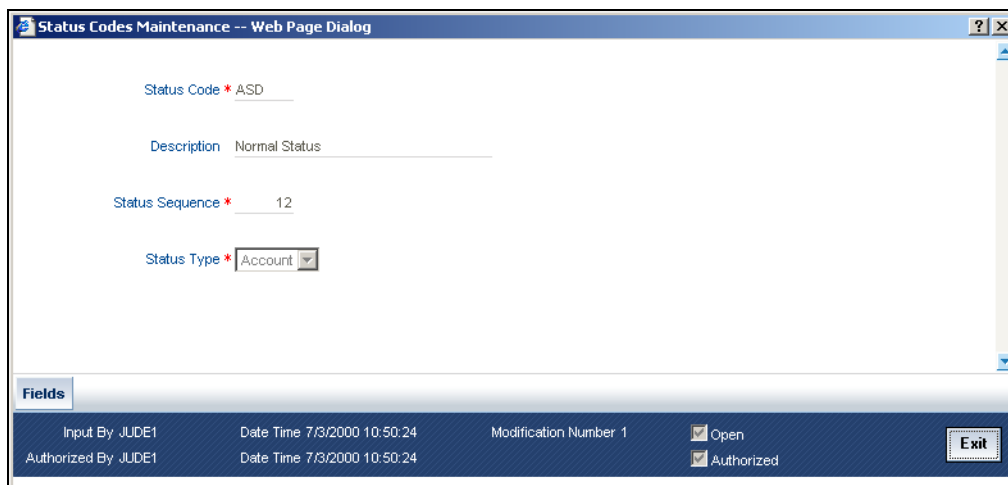

The screenshot shows a web page dialog titled "Status Codes Maintenance -- Web Page Dialog". The form contains the following fields:

- Status Code * ASD
- Description Normal Status
- Status Sequence * 12
- Status Type * Account (dropdown menu)

At the bottom of the dialog, there is a "Fields" section with the following information:

- Input By JUDE1
- Date Time 7/3/2000 10:50:24
- Modification Number 1
- Open
- Authorized By JUDE1
- Date Time 7/3/2000 10:50:24
- Authorized
- Exit button

In this screen you can maintain the following to define a loan or bill/account status:

- A unique code for the status
- A brief description for the status
- A sequence number for the status
- The type of status – Indicate whether the status codes are maintained for an 'Account' or for a 'Contract', or for 'Both'

The type of status you choose depends on the status processing basis for your branch, which is defined in the Branch Parameters Preferences maintenance. If status processing basis is at individual account / contract level, you can choose the applicable status types as 'Account' or 'Contract'. The status codes that have been maintained of type 'Account' are available for association in the Account maintenance and those maintained with type 'Contract' can be associated with contracts.

If status processing basis is at Group / CIF level, you can only maintain status codes of type 'Both' (that is, applicable for both accounts and contracts). In such a case, you must associate the statuses at both the Account maintenance as well as for contracts.



It is mandatory to maintain the status code "NORM" (Normal) with the sequence number as '0', for all the status types. The sequence number must not be repeated for a status type.

16.2.1 Maintaining Status Codes for Contracts

The following parameters need to be maintained for defining a status code:

Status Code

This is the code, which identifies the status to which the contract belongs

Example

Assign a code using a maximum of 3 characters, alphanumeric. For example, if your contract has past its due obligation status you can input code PD1. PD representing post due obligation. The number 1 stands for stage 1 of the post due obligation status

Status Description

This is the description of the status, Enter a description using a maximum of 35 SWIFT characters.

Example

Taking the above example, you can input here - Past Due Obligation 1 for Loan if you are maintaining status codes for Loans.

Link to

This represents the category of the product - asset or liability to which the contract status is applicable

Example

If you are maintaining status codes for loans or any money market placements, click on 'assets type of product'. If you are maintaining status codes for deposits, click on 'liability type of products'.

Effective days from Maturity

This indicates the number of days after the due date when this status becomes applicable to the contract. You can specify any number of days from 0-999.

The effective days defined here is defaulted to the product level in the Bills and Loans modules. You have the option of redefining the number of days at the product level.

17. Transaction Code Maintenance

17.1 Introduction

In the 'Transaction Codes Maintenance' screen you define transaction codes to representing various types of transactions, for example, transfer charges, incoming mail transfer, incoming telex transfer, reserve, incoming clearing transfer etc. All similar transactions can be grouped under a common transaction code with a description. This description will be printed on the account statements, reports and advices generated.

For a transaction type you also maintain other related processing details which will be applicable to all transactions posted under a common code. Details about availability of funds for liability checking, SWIFT code for the transaction type, preferences regarding charges to be levied on turnovers, payment to be made through cheques etc.

17.2 Invoking Transaction Code Screen

You can invoke 'Transaction Code Maintenance' screen by typing 'STDTRCOD' in the field at the top right corner of the Application tool bar and clicking the adjoining arrow button.

The screenshot shows a web-based application window titled "Transaction Code Maintenance -- Webpage Dialog". The interface is organized into several sections:

- Transaction Details:** Includes fields for "Transaction Code" (marked with a red asterisk), "Description" (marked with a red asterisk), "SWIFT Code", "MIS Head", and "External Code".
- Availability Information:** Features radio buttons for "Immediate", "On Value Date", "After Days with New Value Date", and "After 'X' Days", along with a "Days" input field.
- Anti Money Laundering Monitoring:** Contains checkboxes for "Anti Money Laundering Required" and "Intraday Release", and a dropdown menu for "Statement Day Basis" set to "Current working day".
- Preferences:** A list of checkboxes for various settings, including "Cheque Mandatory", "Interest and Charges Transaction Count", "Interest and Charges Turnover Inclusion", "Consider for Account Activity", "Interest and Charges Balance Inclusion", "Consider For Turnover Limit", "Available Balance Check Required?", "Interests and Charges Penalty Inclusion", "Inter Branch in Local Currency", "Acumen Transaction Code", and "Exempt Advance Interest".
- Fields:** A bottom section with input fields for "Input By", "Date Time", "Modification Number", "Authorized", "Authorized By", "Date Time", "Open", and an "Exit" button.

In this screen you maintain the following for a transaction:

- A code representing the transaction type
- Description of the transaction type
- The interval after which funds should be made available after the transaction
- Preferences regarding charges to be levied or not on number of transaction counts and total turnover amounts
- Preference stating whether a transactions booked under this code should cause an account marked as 'dormant' by the system to be re-instated to 'active'
- Preference whether payment for a transactions posted under this code should be made through cheque

17.2.1 Maintaining Transaction Details

The following parameters need to be maintained for a transaction type:

Transaction Code

This is the code you assign to a transaction type. This code identifies the type of transaction.

Enter 3 characters, Alphanumeric. For example, for all transfer charges transaction you can give the code as TCT; for incoming telex transfer you can input - ITT. In case, you want to assign numeric codes only, then for ease of operation similar transaction types should be grouped into a range. For example, you can set a range for all Money Market transactions say, A1-A30; a different range for Bills and Collections B1-B30 and so on.

Description

This is the description of the transaction type

Enter the description using a maximum of 35 characters, alphanumeric. For example, for TCT code you can enter 'Transfer Charges Transaction'.

SWIFT Code

This is the SWIFT code to which this transaction code is linked. It is used for posting transaction details on SWIFT format.

Select from the option list. It will display a list of SWIFT formatted codes representing transaction types. The following list is displayed:

SWIFT CODES	TRANSACTION TYPE
BOE	Bill of Exchange
BRF	Brokerage fee
CHG	Charges and other Expenses
CHK	Cheques

SWIFT CODES	TRANSACTION TYPE
CLR	Cash Letter/Cheque Remittance
COL	Collections
COM	Commission
DCR	Documentary Credit (for Principal Amount)
DIV	Dividends - Warrants
EQA	Equivalent Amount
ECK	Euro checks
FEX	Foreign Exchange
INT	Interest
LBX	Lock Box
LDP	Loan Deposit
MSC	Miscellaneous
RTI	Returned Item
SEC	Securities
STO	Standing Order
TCK	Travelers Cheques
TRF	Transfer
VDA	Value Date Adjustment

The codes COL -Collections, DCR - Documentary Credit and SCC- Securities are used when entering a principal amount.

MIS Head

Each Transaction Code that is created can be linked to an MIS Head. An MIS Head indicates the manner in which the type of entry should be considered for profitability reporting purposes.

17.2.1.1 Indicating Availability Information

This states the different time intervals after which funds will be available for withdrawal in case of all transactions posted under this transaction code.

The system defaults to immediate, which means that funds will be immediately available for withdrawal (the immediate option on the screen). Example: Teller Transaction. For all Clearing transactions you have the option to specify as to when will funds be made available for withdrawal. Click the desired option.

Click 'On Value Date' option if you want funds to be available on the date the transaction became effective. Example: A loan or a deposit

Incase you want to specify the number of days after which funds should be available for withdrawal, click on the option After Days. Enter the number in the box. It could be any two digit positive integer from 1 to 99. This option will make funds available for all transactions posted under this code, on the specified date from the value date. Example: Demand Draft

When you click the last option that is, After Days with New Value Date and enter the number of days in the box; then the original value date of the contract will take a new value date. This new value date = old value date + the number of days input by the user in the box against the option. Example: Future dated funds transfer.

The difference between the third and fourth option being that in the latter case the old value date changes; while in the former the value date does not change.

Intra-day Release

If you want uncollected funds on a transaction posted using the transaction code, to be manually released intra-day (that is, within the day), select the Intraday Release option. The Intraday Funds Batch, when manually executed during the day, picks up those transactions that are due for release on or before the system date, which have been posted with the transaction code (with the Intraday Release option enabled), for release of uncollected funds.

The Intraday Release option cannot be enabled if the Availability specified for the transaction code is Immediate.

You can use the Intraday Funds Release batch process to perform the intra-day release of uncollected funds in respect of transactions posted using a transaction code for which the Intraday Release option has been enabled.

For details about invoking the batch process, refer the Current and Savings Account user manual.

17.2.1.2 Specifying Preferences

This field indicates your preferences regarding transactions booked against this transaction code. The preferences marked relate to the following:

Interest and Charges Transaction Count

Every debit or credit entry is passed under a transaction code. If for a transaction code you have checked 'I&C transaction count' then all entries made under that code would be picked up by the system as chargeable transaction counts which would be used by the I&C system to compute charges. Therefore, you should take care not to check for all bank induced transactions like - service charges, interest payment, calculation, brokerage and charges, etc.

Example

Your bank has a policy of limiting savings withdrawals without additional charges to only 8 in a month. Beyond which all withdrawals would be charged. For the ninth and onward withdrawals in the month from any account the system will maintain a count for computing charges. However, care should be taken to exclude all bank-induced transactions from the count.

Interest and Charges Turnover inclusion

Every debit or credit entry is passed under a transaction code. If for a transaction code you have checked 'I&C turnover inclusion' then the debit turnover/ credit turnover balance under that code would be picked up by the system as chargeable depending upon the option specified in the I&C module. Therefore you should take care not to check for all bank induced transactions like - service charges, interest payment, calculation, brokerage and charges, etc.

Interest and Charges Balance Inclusion

Check this box to indicate that the transactions posted under this code should be considered for the purpose of computation of Remuneration (Interest). By default this option is checked. Uncheck this box for such loan transactions or any other transactions for which you wish to exclude computation of remuneration (interest).



Once the transaction code is authorized, you cannot change your preference.

Consider for Turnover Limit

Check this box to indicate that all transactions posted under this code should be considered as part of the turnover limit processing.

Consider for Account activity

If you check the field 'Consider for A/C activity' for a transaction code, then any debit or credit posted under this code would reinstate the status of an account from dormant to active and accounting activity shall be considered.

Cheque Mandatory

If for a transaction code you check 'Cheque Mandatory' then, for all transactions posted under this code, transaction will take place through cheque. For example: Incoming Clearing transfer.

Cheque Mandatory should be checked only for SB cheque withdrawals and Cash Account Cheque withdrawals.

Example

Transaction Code Maintenance Model Screen

TRANS CODE	DESCRIPTION	SWIFT CODE	AVAIL INFO	I & C TRANS COUNT	I & C TURN INCL	UPDATE ACTIVITY STATUS	CHEQUE MAND
A01	ACCOUNT TO ACCOUNT TRANSFER	MSC	I	Y	Y	Y	Y
A02	ACCEPTANCE	MSC		Y	Y	Y	Y
B01	BANK WIRE TRANSFER	TRF		Y	Y	Y	Y
B02	BANK WIRE TRF-OWN ACC	TRF		Y	Y	Y	Y
B03	BILL C/ A ENTRY	BOE		Y	Y	Y	Y
B04	BILLS REDISCOUNTED	BOE		Y	Y	Y	Y
C01	CANCEL CLEAN CREDIT	RTI		Y	Y	Y	Y
C02	CANCEL GUARANTEE	RTI		Y	Y	Y	Y
D01	DEBIT INTEREST	MSC		Y	Y	Y	Y
D02	DEMAND DRAFT ISSUED	MSC		Y	Y	Y	Y
E01	ENDORSED BILLS SOLD	BOE		Y	Y	Y	Y
F01	FEES ACCRUAL	BRF		Y	Y	Y	Y
G01	GL CREDIT	MSC		Y	Y	Y	Y
G02	GL DEBIT	MSC		Y	Y	Y	Y

Available Balance Check Required

Select this option if you want the system to check for the availability of funds before posting a debit entry to a customer account. The system will check for the available balance in all customer accounts associated with the Transaction Code for which the option is enabled. If the available balance check fails i.e. if the system detects insufficient funds in the customer account, it will display a warning message.



However, the system will check for the available balance only if you have selected the 'Available Balance Check required' option for both the transaction code associated with the accounting entry and the Customer Account Class to which the customer's account that is being debited, belongs. The check will not be performed if the option is not selected in both places.

Interest and Charges Penalty Inclusion

In the transaction code that you use for debit entries to time deposit accounts, you must indicate the computation of penalties on debit entries due to withdrawals from the account before the maturity date. You must select the IC Penalty Inclusion check box to indicate this.

Inter Branch in Local Currency

This indicates whether inter branch entries passed with this transaction code should be in Local currency. If this option is checked, the inter branch transactions would be passed in local currency. This way, the Treasury would be able to track its profit and the branch's profit by passing a single consolidated entry (Position transfer from one branch to the Treasury branch) at the treasury rate.

 This option is applicable only if the local currency of the different branches is the same. This option is applicable only for Fcy1- Fcy1 transactions namely, Fcy1-Fcy2, Lcy-Fcy, Fcy-Lcy, IB entries would be based on IB Parameters Maintenance.

Acumen Transaction Code

You need to check this option in order to eliminate the deals/transactions uploaded from the Acumen in the Hand-off of transactions affecting FCY Position to Acumen from Oracle FLEXCUBE..

 This is applicable where Oracle FLEXCUBE interfaces with Acumen. Acumen is an Integrated Turn-key solution for Treasury, Derivatives and Capital Markets Covering Front, Risk Control, Middle Office from Login SA.

Exempt Advance Interest

Check this box to indicate that all the postings with this transaction code should not be considered for penalty interest calculation

Statement Day Basis

You need to specify when the transaction associated with the selected Transaction Code should appear in the account statement. The available options are:

- Current Working Day
- Previous Working Day

17.2.1.3 Accounting Entry Processing to Calculate Statement Date

The accounting entry processing will be enhanced to calculate the Statement Date based on the Transaction Code Maintenance and the Statement Status at the Branch level. The following illustration explains the calculation of Statement Date.

Assume two Transaction Codes TXN1 and TXN2 have been defined with Statement Date Basis as Current Working Day and Previous Working day respectively. The Statement Date would be derived as follows:

For a transaction C1 posted on say 25th Jan, 2004 with TXN1, the Statement Date would be derived as 25th Jan, 2004 irrespective of the Branch Statement Status.

For a transaction C2 posted on 25th Jan, 2004 with TXN2, the Statement Date would be derived as the Previous Working Day of 25th Jan, 2004 if the Branch Statement Status is set to 'N' specifying that the Branch is not yet ready for periodic statements processing.

For a transaction C3 posted on 25th Jan, 2004 with TXN2, the Statement Date would be derived as 25th Jan, 2004 if the Branch Statement Status is set to 'Y' specifying that the Branch is ready for periodic statements processing.

The Statement Date would be stored as part of the archived data also

The Statement Date would be recomputed during the reversal entry in the same logic

17.2.1.4 Monitoring Anti Money Laundering

Anti Money Laundering Required

Check this box to indicate that AML monitoring is required for all accounting entries linked to the particular transaction code. Leave it unchecked to indicate otherwise.

Product Category

If you indicate that AML tracking is required for all transactions linked to the particular transaction code you have to identify the product category for which AML tracking is necessary.

17.2.2 Maintaining Country Name Details

You can define country name through the 'Country Code Maintenance' screen. You can invoke this screen by typing 'STDCOUNT' in the field at the top right corner of the Application tool bar and clicking the adjoining arrow button.

The screenshot shows a web page dialog titled "Country Code Maintenance -- Web Page Dialog". It contains the following fields and options:

- Country Code * (text input)
- Country Name (text input)
- Alternate Country Code (text input)
- ISO Country Code (text input)
- Limit Currency (text input with a dropdown arrow)
- Overall Limit (text input)
- Blacklisted (checkbox)
- EU Member (checkbox)
- Generate 205 (checkbox)
- IBAN Mandatory for Payment Messages (checkbox)
- Clearing Code in BIC+ (checkbox)

At the bottom, there is a "Fields" section with the following information:

- Input By: OFSSCOMAK5
- Date Time
- Modification Number
- Authorized (checkbox)
- Authorized By
- Date Time
- Open (checkbox)
- Cancel button

Here, you can capture the following details

Country Code

You can capture a unique three-character code to identify the country. For example: you can maintain USA as the country code for United States of America.

Alternate country code

You can also associate an alternate country code. This is for information purposes only and will not be printed on any customer correspondence.

For example you can have US as the alternate code for USA

Country Name

After you define an alphanumeric code to identify the country for which you would like to assign a name, you have to specify the name of the Country.

Limit Currency

Limit currency refers to the currency in which the bank wants to give credit facility to this account for the specified country. Select the Limit currency that should be used for defining the credit limit for this country from the option list.

Overall Limit

This is the maximum credit exposure that a bank is willing to take for a country. That is, the sum of all utilization's under this country liability cannot exceed the amount specified here.

Blacklisted

Further, in the 'Country Name Maintenance' screen you can black list a country for further usage. You are not allowed to deal in countries that are blacklisted.

You can only deal with countries that are *not* blacklisted

IBAN Mandatory for Payment Messages

If this is checked, it indicates that for every payment message an IBAN is mandatory. This is automatically checked if you have checked the 'EU Member' box.

If this option is unchecked for a country, the system will not process the outgoing payments wherein the ordering customer or the beneficiary customer belongs to that country.

EU Member

This indicates whether the country is recognized by Swift as a part of the Intra European countries.

If you check this flag the instructed amount field should be mandatory in the generated 103, 103+ and 102 messages. The instructed amount field is mandatory in the incoming messages.

Clearing Code in BIC+

Check this box to indicate that the National ID in the BIC plus file is the clearing code. During upload of clearing codes from BIC plus file, the records that belong to countries against which this box is checked will be selected.

Generate 205

Check this box to indicate that the cover message 205COV or 205 need to be generated for transactions involving this country. If you do not select this option, RTGS, 202 or 202COV message will be generated.

For more details on 202COV and 205COV cover message formats, refer settlements user manual.

Default Clearing Network

Once the National ID from BIC plus directory is uploaded into clearing codes, the network will be populated as the default clearing network for that country. This is mandatory when clearing code in BIC+ is chosen as 'Y'.

18. Account Revaluation Maintenance

18.1 Introduction

Account revaluation is a process by which the LCY equivalent of balances in the FCY accounts is marked to market.

In all foreign currency accounts, the FCY current balance is displayed along with the LCY equivalent of the current balance. The LCY equivalent current balance is the aggregate of the LCY equivalent of the various transactions that have been posted to the account.

In the 'Chart of Accounts - GL Details' screen you specify whether a GL should be revalued or not.

In the 'Account Revaluation Maintenance' screen, you specify parameters for account revaluation such as rate type, the GL to which the profit or loss from revaluation should be posted, etc. You can invoke this screen by typing 'RVDSETUP' in the field at the top right corner of the Application tool bar and clicking the adjoining arrow button.

Account Revaluation Setup -- Web Page Dialog

General Ledger Code * AS0102008
Description CASH IN HAND FCY

Transaction Code * 140
Description WB-MISC. CREDIT

Rate Type * TC
Description TRAVELLERS CHEQUE

Profit General Ledger
Description

Loss General Ledger
Description
Revalue into
Description

Trading Profit Account
Description

Trading Loss Account
Description

Netting of Offset Entries

Entry Based Revaluation

Rate Type
Transaction Code

Fields

Input By SANGEE Date Time 7/3/2000 15:38:33 Modification Number 1 Open
Authorized By SANGEETH Date Time 7/3/2000 11:33:33 Authorized

In this screen you can maintain the following parameters to define the revaluation parameters for a GL account:

- The general ledger accounts to which the profit or loss on revaluation is to be posted

- The account to which the revaluation profit is to be debited or loss credited
- The rate type to be used to revalue the GL
- The transaction code for posting the revaluation entries
- The rate type to be used for accounting entry-based revaluation of profit and loss GLs
- The transaction code that would be used to post revaluation entries due to accounting entry-based revaluation of profit and loss GLs

General Ledger Code

This is the code of the GL account for which you are specifying revaluation parameters.

Transaction Code

This is the transaction code under which the accounting entries would be posted to the defined revalued GL account

Rate type

This is the rate type to be used for revaluation of this GL

Profit General Ledger

If the result of revaluation is a profit, the profit amount is credited to this profit GL. If, for a GL, you have opted for revaluation split, then Revaluation Profit (as opposed to Trading Profit) is posted into this GL.

Revaluation split segregates revaluation profit / loss into:

- Trading Profit / Loss – Profit / Loss due to revaluation of FCY entries posted into the GL during the current day.
- Revaluation Profit / Loss – Profit / Loss due to revaluation of opening FCY balances (excludes current day's turnover).

Loss General Ledger

If the result of revaluation is a loss, the loss amount is debited to this loss GL. If, for a GL, you have opted for revaluation split, then Revaluation Loss (as opposed to Trading Loss) is posted into this GL.

Revalue into

This GL account is debited if the result of revaluation is a profit; and credited if the result of revaluation is a loss

This would typically be the GL code being revalued. For all non-contingent GLs belonging to the asset or liability categories, the system defaults to the GL being revalued.

If you wish to specify a different account for posting these entries specify by selecting from the list of maintained GLs. A list of all GLs would be displayed. Select.

Trading Profit Account/Trading Loss Account

This indicates the GL for posting profit/loss due to trading revaluation (Trading Profit / Loss) if you have indicated that revaluation split is required for a GL.

Netting of offset entries

A check against this indicates whether the offset entries for all accounts linked to the GL code need to be netted or not. If checked, a single consolidated entry would be passed (one for profit and one for loss).



Netting of offset entries is applicable only for normal account revaluation and not for accounting entry-based revaluation of Income/Expense GLs.

Accounting entry-based revaluation of Income / Expense GLs

Income/expense GLs that are marked for entry-based revaluation are picked up by the EOD revaluation batch process, which executes before the account revaluation batch process on a given business day.

In the Account Revaluation Maintenance, you must specify the following parameters that would be used by the batch revaluation process, for revaluing FCY entries in Income/Expense GLs:

- Rate type
- Transaction code for posting entry-based revaluation entries

You can maintain these parameters for specific Income/Expense GLs. If you wish to maintain these parameters for all Income/Expense GLs, you can specify the 'STDPNL' option in the GL Code field. The 'STDPNL' option signifies that the entry-based parameters being maintained are applicable for all Income/Expense GLs.

When the revaluation batch revalues an Income/Expense GL, it uses the rate type and transaction code maintained for the GL in the Account Revaluation screen. If no maintenance exists for the specific GL, the parameters maintained for the 'STDPNL' GL Code option are used.

19. Maintaining Branch Holidays

19.1 Introduction

For a year, you need to define your weekly holidays and your calendar year annual holidays. This is done in the 'Local Holiday Calendar' screen.

The system uses the information maintained in this screen to do the following:

- To check that the 'value date' of no Data Entry transaction falls on a holiday
- To check that the start date / maturing date and schedule date of a loans and deposit contract does not fall on a holiday
- To effect a date change on the system -- today's date and the next working date

For any schedule / contract maturing at a future date, say, 5 years hence, you can input a future date, only if the calendar for that year has been maintained. It is not necessary to maintain the list of all annual holidays, for future, you can merely define all regular weekly holidays.

This screen is maintained for each branch, of your bank, from the respective branches; thus making it possible to have a different set of holidays for different branches of the bank.

19.2 Invoking Local Holiday Screen

Invoke the 'Local Holiday Calendar' screen, by typing 'STDLCHOL' in the field at the top right corner of the Application tool bar and clicking the adjoining arrow button.

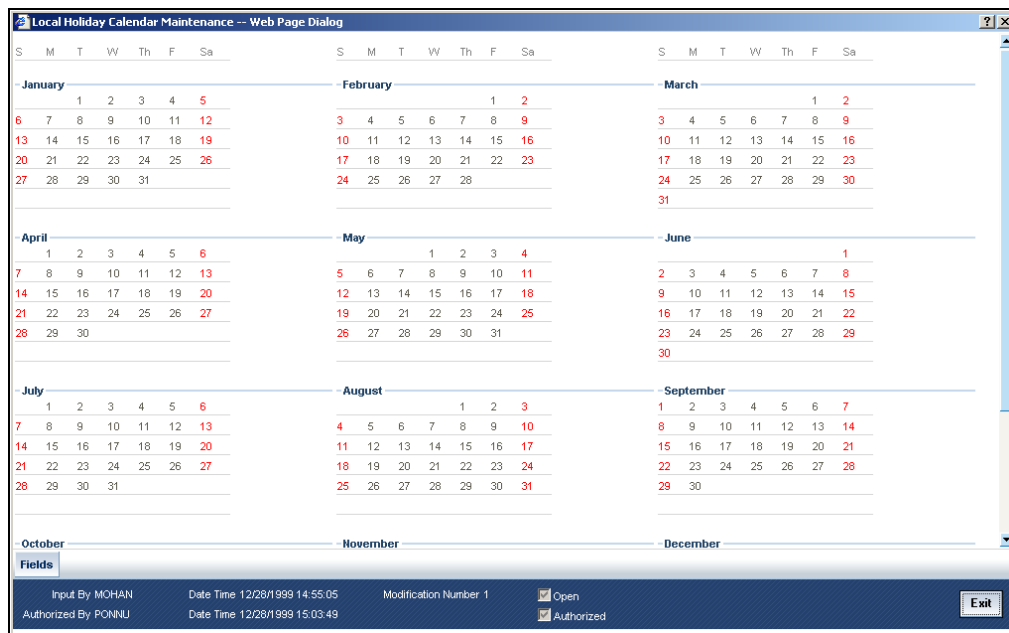

In this screen you can specify the weekly and also the annual holidays, for your branch, for any year between 1 AD and 4000 AD.

19.2.1 Steps to Define Yearly Holidays

To define holidays for a year, (for instance, for 2000) you have to do the following:

Building the calendar for the year

Step 1

Select 'New' from the Actions menu in the Application tool bar or click new icon

Step 2

Enter the year -- 2000 or move to the year 2000 using the arrows

Step 3

To build the calendar for the year, 2000 click the 'Refresh' button. This button is called the 'refresh / build up' button because it builds the calendar for you. Please note:

- On invoking the calendar of any year, you will notice that Saturdays and Sundays are marked as weekly holidays. This is the default setting of the system
- For identification, the working days are marked in black and the holidays in red
- All unauthorised records appear against a blue background. On authorisation of that record, the background is cleared.

19.2.2 Defining Holidays

To define any other weekly holiday, other than the default, double click the day of the week, listed on the top row of the screen. For instance, if you double click on 'F', all Fridays in the year would be marked as holidays.

To clear off the default weekly holidays — Saturdays and Sundays, double click on 'sa' and 's' written on the top row.

To specify, other annual holidays, double click on the date — the date would be marked as a holiday.

If you want to unmark a day specified earlier as a holiday, double click on it, once again. You will notice that the day gets marked in black. Because the change is yet unauthorised, it appears against a blue background.

19.2.3 Annual Holidays

These are the holidays you have defined for the year calendar on display

You will observe that all holidays are marked in red, while working days in black. (All unauthorised holiday dates appear against a blue background). To mark a date as a holiday, double click on it. In case you wish to undo a date marked off as a holiday, double click on it once again. It changes back to a working day.

With each modification you make, the Modification Number in the made by column below moves up serially.

If you want to ensure that interest accruals happen every day, you will have to maintain all days as working days.

19.2.4 Designating Unexpected Holidays for Branch

The holiday calendar for your branch is maintained in the Branch Holiday Calendar screen.

In addition to the holiday calendar, you may need to designate certain days as holidays unexpectedly, without forewarning. Alternatively, you may also need to roll back a previously defined holiday date or set of dates. You can do this using the 'Unexpected Branch Holiday Maintenance' screen. You can invoke this screen by typing 'CGDUNHOL' in the field at the top right corner of the Application tool bar and clicking the adjoining arrow button.

Unexpected Branch Holiday Maintenance -- Web Page Dialog

Branch Code * CHO
 Branch Name BANK OF INDIA

Holiday /Working Type HOLIDAY
 WORKING

Holiday Date From * 6/26/2000
 Holiday Date To * 6/26/2000
 Holiday Reason SYSTEM

Type Exceptions	
Holiday /Working Date	Reversed Flag
6/26/2000	<input type="checkbox"/>

Fields

Input By AMIT Date Time 7/3/2000 12:37:24 Modification Number 1 Open
 Authorized By IFLEXAUTH Date Time 7/3/2000 13:35:51 Authorized Exit

In this screen, for the current branch, you can maintain a range of dates, every date within which will be designated as holidays for the branch. You can also provide a reason for the designation.

Every unexpected holiday you designate must be authorized for it to be effective

19.2.4.1 Reversing Designated Holiday

In the Unexpected Holiday Maintenance screen, you can also reverse a designated holiday before the actual date. Specify the holiday date in the Holiday Date field, and check the Reverse box field alongside it.

When you designate unexpected holidays, any bank or customer value dates for any transactions, that coincided with the holiday are rolled forward. Any accounting entries passed are reversed and fresh entries are passed to reflect the new value date.

 For the release of uncollected funds, the original transaction date is considered for availability calculations

20. Maintaining Currency Holidays

20.1 Introduction

You need to maintain a yearly list of holidays, for the currencies, defined in the currency screen. This is done in the 'Currency Holiday Calendar' screen.

The system uses the information maintained in this screen to check whether any settlement, involving a foreign currency (in the foreign Exchange, Money market, Funds Transfer, Loans & Deposit modules) falls on that currency's holiday. If yes, then the system will display a message stating so, and ask the user for an override

For any schedule or contract maturing at a future date say, 5 years hence, you can input the future date, only if the calendar for that year has been maintained.

The currency holiday screen is maintained at the Bank Level by the Head Office

20.2 Invoking Currency Holiday Screen

You can invoke this screen by typing 'STDCCHOL' in the field at the top right corner of the Application tool bar and clicking the adjoining arrow button.

The screenshot displays the 'Currency Holiday Calendar Maintenance -- Web Page Dialog' window. It features a grid of 12 monthly calendars, one for each month from January to December. Each calendar shows the days of the week (S, M, T, W, Th, F, Sa) and the dates. Some dates are highlighted in red, indicating holidays. For example, in January, the 1st, 8th, 15th, 22nd, and 29th are highlighted. The footer of the window contains the following information: Input By: ARVIND, Date Time: 12/28/1999 16:21:55, Modification Number: 1, Open button, Authorized By: SATISH, Date Time: 12/28/1999 16:41:12, Authorized button, and an Exit button.

In this screen, you can maintain a list of holidays for each of the currencies maintained in the 'currency screen', for any year between 1 AD and 4000 AD.

20.2.1 Steps to Define Currency Holidays

To define currency holidays for a year, (for instance, for 2000) you have to do the following:

Building the calendar for the year

Step 1

Select 'new' from the Actions menu in the Application tool bar or click new icon. A blank screen appears and the cursor moves to the field 'Year'

Step 2

Enter the year -- 2000 or move to the year 2000 using the arrows

Step 3

To build the calendar for the year, 2000 click on the 'Refresh' button. This button is called the 'refresh / build up' button because it builds the calendar for you

Step 4

Select the currency for which you are defining holidays. Please note:

- On invoking the calendar of any year, you will notice that Saturdays and Sundays are marked as weekly holidays for the currency. This is the default setting of the system.
- For identification, the working days are marked in black and the holidays in red.
- All unauthorised records appear against a blue background. On authorisation of that record the background disappears.

20.2.2 Defining Currency Holidays

To define any other weekly holiday for the currency, other than the default, double click the day of the week, listed on the top row of the screen. For instance, if you double click 'F', all Fridays in the year would be marked as holidays.

To clear off the default weekly holidays — Saturdays and Sundays, double click on 'sa' and 's' written on the top row

To specify, other holidays, double click on that date — the date would be marked as a holiday

If you want to unmark a day specified earlier as a holiday, double click on it, once again. You will notice that the day gets marked in black. Because the change is yet unauthorised, it appears against a blue background

20.3 Uploading Holiday file

SWIFT provides a country-wise holiday file that can be uploaded into Oracle FLEXCUBE. For all countries where 'EUR' is not the local currency, the respective holidays can be uploaded into the currency holidays tables. For European countries, where 'EUR' is the currency, you can upload the TARGET holidays. Oracle FLEXCUBE allows you to upload these currency holidays through the 'BIC/BICPLUS – Upload' screen. You can invoke this screen by typing 'ISDBICPU' in the field at the top right corner of the Application tool bar and clicking the adjoining arrow button.

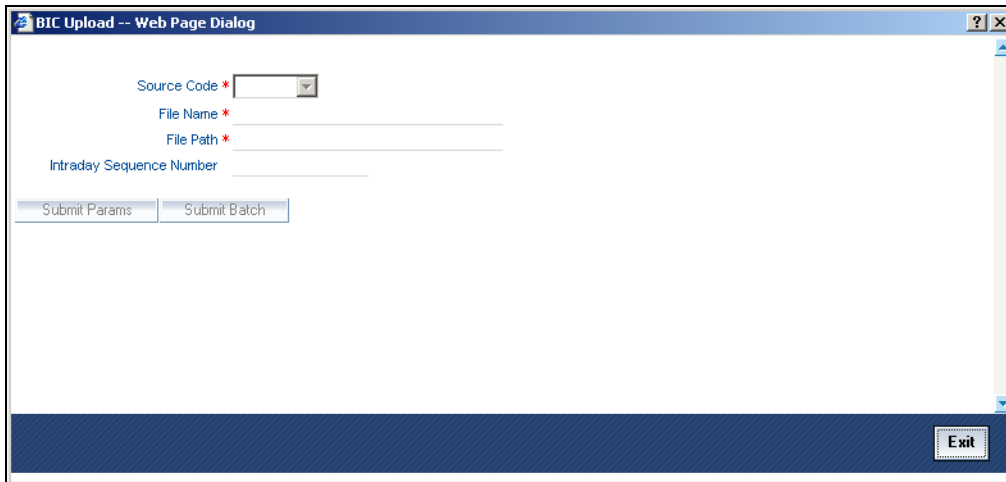
The image shows a web browser window titled "BIC Upload -- Web Page Dialog". The window contains a form with the following fields: "Source Code *" with a drop-down menu, "File Name *" with a text input field, "File Path *" with a text input field, and "Intraday Sequence Number" with a text input field. Below the fields are two buttons: "Submit Params" and "Submit Batch". At the bottom right of the window is an "Exit" button.

Here you need to choose the source code as 'CCH' from the drop-down list. For further details about this screen, refer the section titled 'Uploading the BIC/BICPLUS files into Oracle FLEXCUBE' in the 'Settlements' User Manual.

The holiday file gets uploaded with two records:

- HF Record – wherein 'EUR' is not the local currency
- HS Record - wherein 'EUR' is the local currency

For more details on the file formats of these records, refer the chapter titled 'Annexure – B – File Formats'.

21. Maintaining Clearing Holidays

21.1 Introduction

You need to maintain a yearly list of holidays of your Clearing House. This is defined in the 'Clearing House Holiday Calendar' screen.

This set of holidays is maintained at the bank level, by the Head Office. You can invoke this screen by typing 'STDCLHOL' in the field at the top right corner of the Application tool bar and clicking the adjoining arrow button.

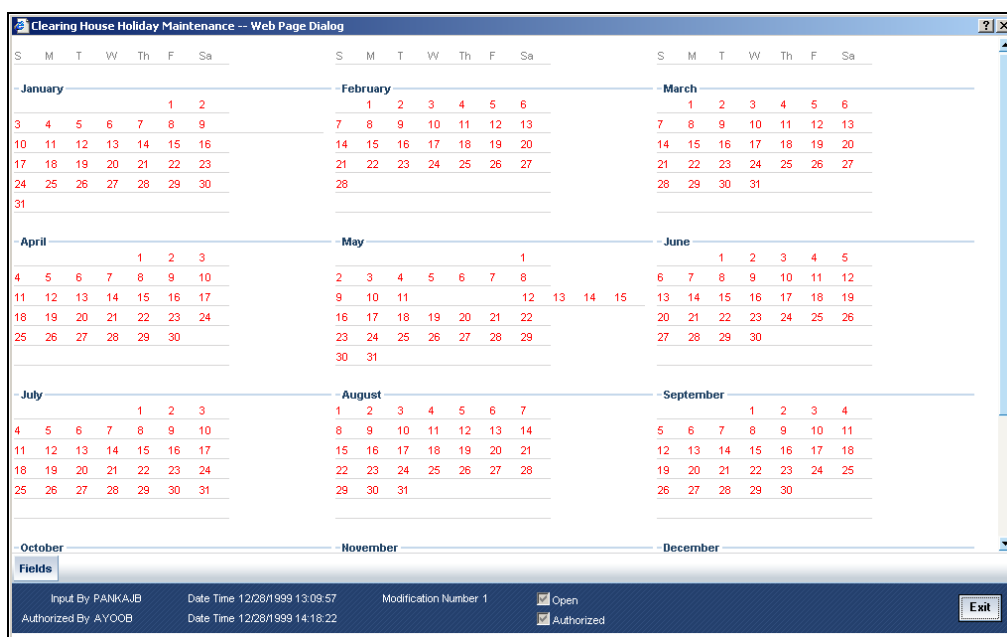

In this screen, you maintain a list of holidays of the Clearing House with which your bank is associated with.

21.1.1 Steps to Define Clearing House Holidays

To define Clearing House holidays for a year, (for instance, for 2000) you have to do the following:

Building the calendar for the year

Step 1

Select 'New' from the Actions menu in the Application tool bar or click new icon

Step 2

Enter the year — 2000 or move to the year 2000 using the arrows

Step 3

To build the calendar for the year, 2000 click the 'Refresh' button. This button is called the 'refresh / build up' button because it builds the calendar for you. Please note:

- Your clearing house can be identified with the name -- SYS, given to it by the Oracle FLEXCUBE system. This is displayed in the field 'Clearing House'
- Saturdays and Sundays are marked as weekly holidays for the Clearing House. This is the default setting of the system
- For identification, the working days are marked in black and the holidays in red
- All unauthorised records appear against a blue background. On authorisation of that record the background disappears

21.1.2 Defining Clearing House Holidays

To define any other weekly holiday for the Clearing House, other than the default, double click on the day of the week, listed on the top row of the screen. For instance, if you double click 'F', all Fridays in the year would be marked as holidays.

To clear off the default weekly holidays — Saturdays and Sundays, double click on 'sa' and 's' written on the top row.

To specify, other holidays, double click on that date – the date would be marked as a holiday.

If you want to unmark a day specified earlier as a holiday, double click on it, once again. You will notice that the day gets marked in black. Because the change is yet unauthorised, it appears against a blue background.

21.1.3 Designating Unexpected Holidays for Clearing House

The holiday calendar for your clearing house is maintained in the Clearing House Holiday Calendar screen

In addition to the holiday calendar, you may need to designate certain days as holidays unexpectedly, without forewarning. Alternatively, you may also need to roll back a previously defined holiday date or set of dates. You can do this using the 'Unexpected Holiday Maintenance' screen.

You can invoke this screen by typing 'CGDCLHOL' in the field at the top right corner of the Application tool bar and clicking the adjoining arrow button.

Unexpected Clearing House Holiday Maintenance -- Web Page Dialog

Clearing House * C01
Description Clearing House 01

Holiday / Working Type HOLIDAY
 WORKING

From * 7/11/2001
To * 7/11/2001
Reason

Holiday / Working Date	Reversed Flag
7/11/2001	<input type="checkbox"/>

Fields

Input By DINESHAU Date Time 7/3/2000 17:56:46 Modification Number 1 Open
Authorized By Date Time Authorized

In this screen, for a clearing house, you can maintain a range of dates, every date within which will be designated as holidays for the clearing house. You can also provide a reason for the designation.

Every unexpected holiday you designate must be authorized for it to be effective

21.1.3.1 Reversing Designated Holiday

In the Unexpected Holiday Maintenance screen, you can also reverse a designated holiday before the actual date. Specify the holiday date in the Holiday Date field, and check the Reverse box field alongside it.

When you designate unexpected holidays, any bank or customer value dates for clearing transactions, that coincided with the holiday are rolled forward. Any accounting entries passed are reversed and fresh entries are passed to reflect the new value date.

 For the release of uncollected funds, the original transaction date is considered for availability calculations.

22. Maintaining Retail and Corporate Holidays

22.1 Introduction

You can set up two different holiday calendars to process redemption of deposits for corporate and retail customers under every branch. Once the holiday calendar is set up differently for both types of customers for every branch, the system will look up the corresponding calendar and process deposit redemption. You can maintain retail and corporate holidays using the 'Corporate/Retail Holiday Calendar Maintenance'. You can invoke this screen by typing 'STDCRHOL' in the field at the top right corner of the Application tool bar and clicking the adjoining arrow button.

Corporate/Retail Holiday Calendar Maintenance -- Webpage Dialog

April	May	June	July	August	September	October	November	December

Customer Type * Retail
Branch * 3B4
Year * 2011
Refresh

Fields
Input By SANJIVANI1 Date Time Modification Number Authorized
Authorized By Date Time Open Cancel

Specify the following details:

Customer Type

Select the type of customer for which you want to set up the holiday calendar, from the adjoining drop-down list. The following options are available:

- Corporate
- Retail

Branch

Specify the branch code for which you want to set up the holiday calendar. The adjoining option list displays all valid branch codes maintained in the system. You can also select the appropriate one.

Year

Specify the Gregorian calendar year for which you are maintaining holidays.

Click on any day to mark it as holiday. The selected day will be highlighted in red.

During TD redemption, the system will refer this holiday calendar to see if the redemption is being done on a holiday or not. If yes, then no penalty will be charged on the TD. Similarly if redemption date is the last working day before maturity date (falling on a holiday), the system will not levy any penalty.

23. Maintaining Business Details

23.1 Introduction

You can maintain details of your customer's business, the associated risk classification and applicable Know Your Customer (KYC) review period in the 'Business Details' screen. You can invoke this screen by typing 'CODBUSDT' in the field at the top right corner of the Application tool bar and clicking the adjoining arrow button.

The screenshot shows a dialog box titled "Business Details -- Webpage Dialog". It contains the following fields and controls:

- Business Type Name: Text input field.
- Business Type Description: Text input field.
- Risk Classification: Radio buttons for Low (selected), Medium, and High.
- Periodicity of Review: A section with a "Unit" dropdown menu set to "Days" and a "Value" text input field.
- Bottom bar: Fields for "Maker", "Checker", "Date Time", "Mod No", "Authorized", and "Open", along with a "Cancel" button.

Specify the following details:

Business Type Name

Specify a unique code to identify a customer business type.

Business Type Description

Specify a brief description of the customer business type.

Risk Classification

Indicate the risk category of the business type by choosing one of the following options:

- Low
- Medium
- High

Periodicity of Review

Specify the review period applicable to KYC details.

Unit

Select the unit in terms of which you want to define the KYC review period, from the adjoining drop-down list. The following options are available:

- Days
- Months
- Years

Value

Specify the number of days/months/years (based on 'Unit') that should make up the KYC review period.

The record needs to be saved and authorized for it to become active in the system.

23.2 Maintaining KYC Document Types

Oracle FLEXCUBE offers the following literal types for maintenance of various documents required for KYC check during customer creation:

- KYC_RETAIL_CERT - for Retail type of customers
- KYC_CORP_CERT - for Corporate and Bank type of customers

You need to maintain the required documents for each type of customer creation using the 'Static Type Maintenance' screen. You can invoke this screen by typing 'CODTYPES' in the field at the top right corner of the Application tool bar and clicking the adjoining arrow button.

The screenshot shows a web-based dialog box titled "Static Type Maintenance -- Webpage Dialog". It features three input fields: "Type *" (with a red asterisk), "Type Name", and "Type Value". Each field has a small speech bubble icon to its right. Below the fields is a "Fields" tab. At the bottom of the dialog, there is a status bar with the following information: "Input By SANJIVANI1", "Date Time", "Modification Number", "Authorized" (checkbox), "Open" (checkbox), and a "Cancel" button.

Specify the following details:

Type

Specify 'KYC_RETAIL_CERT' as the type for retail customer related documents.

Similarly, specify 'KYC_CORP_CERT' for corporate customer related documents.

Type Name and Value

You need to maintain individual records with each of the following values in case of type 'KYC_RETAIL_CERT':

Type Name	Type Value
National ID card	National ID card
National register Card	National register Card
Passport	Passport
Military officer card	Military officer card
Solider card	Solider card
Military cadres' card	Military cadres' card
Armed police card	Armed police card
Police officer card	Police officer card
Mainland travel permit for Hong Kong and Macao residents	Mainland travel permit for Hong Kong and Macao residents
Mainland travel permit for Taiwan residents	Mainland travel permit for Taiwan residents
Foreigner residence permit	Foreigner residence permit
Others	Others

You need to to maintain individual records with each of the following values in case of type 'KYC_CORP_CERT':

Type Name	Type Value
Corporate Organization Code	Corporate Organization Code
Business registration card	Business registration card
Business license	Business license
Corporate legal person code	Corporate legal person code
Foreign trade permit	Foreign trade permit
Opening account permit	Opening account permit
Special industry permit	Special industry permit

FX operation license	FX operation license
Financial operation license	Financial operation license
National tax registration card	National tax registration card
Local tax registration card	Local tax registration card
Approval document	Approval document
Loan permit	Loan permit
Import & Export business card	Import & Export business card
Corporate permit card	Corporate permit card
FX register card	FX register card
Others	Others

Every record needs to be saved and authorized in order to become effective in the system.

23.3 Maintaining Customer Sectors

You can maintain different customer sectors for identifying high risk customers using the 'Customer Sector Maintenance' screen. You can invoke this screen by typing 'CODCSCMT' in the field at the top right corner of the Application tool bar and clicking the adjoining arrow button.

Specify the following details:

Customer Sector Code

Specify a unique code to identify the customer sector.

Sector Description

Specify a brief description of the sector.

High Risk Sector

Check this box to indicate that the customer sector is of high-risk type. Note that for customers belonging to high risk sector, the risk classification during KYC is updated as 'High-Risk'. For customers who don't belong to the high risk sector, the system checks the risk classification associated with the corresponding business type and marks the KYC risk classification.

The record needs to be saved and authorised for it to become active in the system.

24. Configuring Overrides

24.1 Introduction

The system displays messages in respect of errors that occur when you execute operations during a work session, in any module. These error messages are also displayed in respect of automatic or batch processes, such as end of day processes.

Depending upon your requirements at your installation, you might require some of the errors to be ignored, and others to result in an override being sought from the user for the operation to proceed. For still others, you might require an online authorization for the operation to proceed. Accordingly, the implementers at your installation configure the sensitivity of such errors. Subsequently, you might also need to configure errors to suit your requirements.

24.1.1 Types of Overrides

In Oracle FLEXCUBE, you can assign a level of sensitivity to each override that arises or occurs during system operation. This level of sensitivity that you assign to an override indicates the action that will result when that specific override occurs. Accordingly, you can assign any of the following sensitivity levels to an override:

Ignore

This would mean that no override message would be displayed and the exception would be ignored

Override

This sensitivity indicates that an override message should be displayed, seeking confirmation from the user. If the user confirms or accepts the override, processing of the transaction would proceed; if not, the exception would have to be corrected before transaction processing can proceed.

For such overrides, you can assign an additional parameter to indicate whether an online authorization is required if the override is accepted. If you have assigned online authorization to be required, then, for transactions involving such overrides, an online authorization is requested as a mandatory procedure. The online authorization limit specified for the authorizer would be checked during authorization, in addition to the time level of the authorizer, which should be greater than the user who is input the transaction.

For such overrides, if you have specified that no online authorization is required, the user can accept the override, and it will not require any online authorization.

Error

This would indicate that, when an exception occurs, an override message would be displayed, and the transaction cannot be processed further, that is, it would stop being processed until the exception is corrected.

Online Authorization

This would indicate that an override message would be displayed, seeking confirmation from the user. However, in this case, online authorization would be required as a mandatory procedure, if the override were accepted.

Dual Authorization

This would indicate that an override message would be displayed, seeking confirmation from the user. However, in this case, online authorization would be required as a mandatory procedure, if the override were accepted. Also, at least two authorizers would be needed to authorize the transaction.

Override Types for Batch Functions

For exceptions occurring during execution of automatic or batch processes, you can assign the Ignore, Override or Error sensitivities.

24.1.2 Specifying Override Type

In the 'Overrides Maintenance' screen, all the error messages that would appear in each module, with their respective error codes, are displayed. The functions, with respect to which the error messages could be encountered, are also displayed. You can invoke this screen by typing 'CSDOVDMT' in the field at the top right corner of the Application tool bar and clicking the adjoining arrow button.

The screenshot shows a web-based form titled "Overrides Maintenance -- Web Page Dialog". The form is organized into several sections:

- Language:** Includes a field for "Language * ENG" and a "Description" field.
- Error details:** Contains fields for "Error Code * 10001", "Message No Data Found", "Type Error" (a dropdown menu), "Function IFATMMIN", "Param 0", and "Batch Type Error" (a dropdown menu). There is also a "Confirm" checkbox.
- Branch Details:** Includes fields for "New Error Code", "Branch Code", "Function id", and "Old Error Code".

At the bottom of the form, there is a "Fields" section with the following information:

- Input By SYSTEM
- Date Time 8/12/2005
- Modification Number 1
- Open
- Authorized By SYSTEM
- Date Time 8/12/2005
- Authorized
- An "Exit" button.

In the Type field, you can specify, for each error message, the appropriate sensitivity level – Ignore, Override, Error, Online Authorization or Dual Authorization.

For error messages in respect of automatic or batch functions, you can specify the appropriate level in the Batch Type field – Ignore, Override or Error.

For certain overrides, (to which you have assigned the level Override, Online Authorization or Dual Authorization), you can indicate whether the authorizer must also confirm the override, by checking the Confirm box.



You can make changes to configurable overrides in the Error Codes Maintenance screen only after consulting the support team at your installation.

25. Purging Data

25.1 Introduction

Purging is a process by which you remove unwanted data from the system. For example, you may find the interest rates that you have maintained for a financial cycle useless a couple of years later. You would want to remove such data from the system. You can achieve this by 'purging' the system of the data.

The purge function of Oracle FLEXCUBE allows you to purge:

- Contracts and transactions that you have entered into,
- Data relating to transactions (such as, interest rates)
- Limits history (Liability, Lines and Line Utilization history)
- GL Average Balance and Customer Account statistics

You can purge the contracts (or transactions) that you have entered into in the following modules of Oracle FLEXCUBE:

- Foreign Exchange
- Money Market
- Loans
- Deposits
- Data Entry
- Standing Instructions
- Letters of Credit
- Bills and Collections

You can purge data from the following modules:

- Accounting
- Currency
- General Ledger
- Interest and Charges
- Messaging
- MIS
- Reconciliation
- Receivable Liquidation

You can also purge data relating to transactions. For example, you can purge the currency rates that you have maintained, the messages in the messaging system of Oracle FLEXCUBE, the User Data Elements that you used to compute interest, interest statement details, user information maintained in the Security Management System of Oracle FLEXCUBE, customer information, and so on.

The system will automatically purge data according to the parameters that you define in the Purge Details Maintenance screen.

25.2 Maintaining Purge Details

In the 'Purge Details Maintenance' screen, you can define the parameters for purging data from the system. For instance, you may want to purge the contracts entered into in the previous financial cycle. Or, you may want to retain exchange rates in the system for a specific period. These are examples of parameters that you can define in the Purge Details Maintenance screen. You can invoke this screen by typing 'CSDPURGE' in the field at the top right corner of the Application tool bar and clicking the adjoining arrow button.

The screenshot shows a web-based application window titled "Purge Details Maintenance -- Web Page Dialog". The window is divided into several sections. The top section is "Module Selection", which includes a "Module Identification" field with the value "BC" and a "Description" field with the value "Bills and Collections". Below this is the "Purge Criteria" section, which includes a "Status" dropdown menu set to "Liquidated" and a "Retention Period" field with the value "245". At the bottom of the window, there is a "Fields" section containing input and authorized user information, a date and time stamp, a modification number, and checkboxes for "Open" and "Authorized". An "Exit" button is located in the bottom right corner.

25.2.1.1 Specifying Module

In the Purge Details Maintenance screen you must first specify the module for which you are defining parameters. All parameters that you define subsequently will only apply to the module that you specify.

You can enter a description of the module for which you are maintaining purge details.

STOP For purging limits history which is Liability, Lines, and Lines Utilization history, you must specify LM as the module code. Limits history data is purged for the current branch only.

25.2.1.2 Specifying Nature of Data to be Purged

You can opt to purge contracts (of the module you specified) along the following criteria. You may either choose to purge any of the following:

- Liquidated contracts
- Closed (applicable only to the BC and LC modules)
- Reversed contracts

When you run the purge process, only those contracts that are in the status that you specified will be purged. That is, only contracts (in the module you specified) that are liquidated, closed, and/or reversed, depending on your specification, will be purged from the system.

Similarly, if you want to purge

- Exchange rates (from the Currency module), you should choose the 'None' option.
- Data from the Reconciliation module, you should choose any of the following options, depending on the data that you want to purge. The options available are:
 - System Date Relative
 - Match Relative
 - Closed Match
 - Closed External Statement

Retention Period

The retention period, as the term suggests, is the period for which data is stored in the system. For each module in Oracle FLEXCUBE, you can specify the retention period.

When you run the purge process on any given day, only the data that is beyond the retention period that you specified will be purged. The following example illustrates this concept.

Example

The requirement:

You would like to retain foreign exchange contracts that were liquidated 60 days prior to the running of the purge process, in the system. (That is, if the current system date is 30 June 1999 and you do not wish to purge the foreign exchange contracts that were liquidated between 1 May 1999 and 30 June 1999).

Solution:

In the Retention Period field enter '60' (note this value is expressed in days), and in the 'Status' field choose the 'Liquidated' option.

Result:

If this setup is authorised, and you run the purge process on 30 June 1999, the current system date, all foreign exchange contracts that you liquidated prior to 1 May 1999 will be purged. Contracts that were liquidated on or after 1 May 1999 will not be purged.

26. Tanking of Maintenance Records

26.1 Introduction

The maintenance records that are created or modified in the system can be tanked till they get authorized, so that it is possible to undo the modifications, if needed, before the records are authorized. The maintenance log also will store the changes till they get authorized. The new or the modified records are written to the static tables only after authorization.

26.2 Tanking New and Modified Maintenance Records

You can enable tanking of the creation and modification of maintenance records by selecting the 'Tanking Required' option provided at the function Id level. You need to enable the 'Tanking Required' option in RAD tool as well.

You can enable 'Tanking Required' option for individual function Ids in 'Function Description Maintenance' screen. You can invoke this screen by typing 'SMDFNDS' in the field at the top right corner of the Application tool bar and clicking on the adjoining arrow button.

Function Identification * STDCIF
Module List * CO
Custom Function ID
Name
Type Form
Menu Head MODULE
Type String Maintenance
 Tanking Required
 Available
 Automatic End Of Day aware
 Log Event
 Customer Access
 Auto Authorization
 Head Office Function
 Duplicate task check
Main Control String for functions and reports Duplicate Check Fields
Function Description
Language Code * Main Menu Sub Menu 1 Sub Menu 2 Balloon Help Description
Field Properties
Maker Checker Date Time: Date Time: Mod No Authorized Open Cancel

To enable tanking of maintenance records for a function Id you need to select the function Id in this screen and then select the 'Tanking Required' checkbox.

For more details on this screen, refer Security Management System user manual.



Tanking of records has been enabled only for the following function Ids:

- STDCIF
- STDCUSAC

26.2.1 Tanking New Records

During the creation of a new record, if 'Tanking Required' option is enabled, the system tanks the details of the newly created record till the record gets authorized. Any query on this data retrieves this stored information.

26.2.2 Tanking Modified Records

All modifications to unauthorized records get tanked and the modified data gets written to actual tables only after authorization. In this case, the record remains in 'Authorized' status in the actual table and the unauthorized modifications will be kept pending for un-tanking. The most recent modifications will be shown in both summary and detailed screens with the Authorization status as 'Unauthorized'.

26.2.3 Closing a Record

You can close a record only if it is in 'Authorized' state, without any unauthorized modifications pending for un-tanking. Closure is possible only for records that are in 'Open' status. When you close a record, the system tanks this and the record gets actually closed only after the closure gets authorized.

26.2.4 Re-opening a Record

You can re-open a record only if it has been closed and the closure is authorized. Re-opening of a record gets tanked till it gets authorized and the actual re-opening happens after the authorization.

26.2.5 Authorizing a Record

All unauthorized modifications get displayed when you click 'Authorize' menu option. You can select a modification number and the records get authorized till that modification. These records are un-tanked and their status gets updated as 'Authorized'. You can authorize the modifications partially, if required.

26.2.6 Deleting a Record

All unauthorized records will be available for deletion. You can select a modification number and system deletes all unauthorized modifications from the selected modification number. If the modifications getting deleted are made by a user other than the current user, the system displays an error message.

26.2.7 Viewing Summary of Records

All summary screens display data retrieved from both the summary data source and the table that contains the unauthorized tanked records.

26.2.8 Modifying Tanking Preferences

You can modify the tanking preferences specified for a function Id, if required. This modification is possible only if all records related to that function Id are in 'Authorized' status.

27. Reprinting Vouchers

Oracle FLEXCUBE allows you to reprint vouchers for authorized transactions for certain modules using the 'Voucher Print' screen. You can invoke this screen by typing 'STDVHRPT' in the field at the top right corner of the Application tool bar and clicking the adjoining arrow button.

Voucher Print Screen -- Webpage Dialog

Voucher ID

Function Id

Reference No

Host Reference No

Transaction Date

USER

Customer No

Branch Code

Account

Event Code

1 Of 1

Voucher ID	Function Id	Reference Number	Host Reference No	USER	Branch Code	Customer No	Account	Transaction Date
------------	-------------	------------------	-------------------	------	-------------	-------------	---------	------------------

In this screen, specify any combination of parameters and click the 'Query' button:

Voucher ID

Specify the ID of the voucher for which you require voucher reprinting. You can also select the required voucher ID from the adjoining option list.

Function ID

Specify the ID of the function for which you require voucher reprinting. You can also select the required function ID from the adjoining option list.

Reference No

Specify the reference number for which you require voucher reprinting. You can also select the required reference number from the adjoining option list.

Host Reference No

Specify the host reference number for which you require voucher reprinting. You can also select the required host reference number from the adjoining option list.

Transaction Date

Specify the transaction date for which you require voucher reprinting. You can also select the required date from the adjoining calendar.

USER

Specify the user for which you require voucher reprinting. You can also select the required user from the adjoining option list.

Customer No

Specify the customer number for which you require voucher reprinting. You can also select the required customer number from the adjoining option list.

Branch Code

Specify the branch code for which you require voucher reprinting. You can also select the required branch code from the adjoining option list.

Account

Specify the account for which you require voucher reprinting. You can also select the required account from the adjoining option list.

Event Code

Specify the event code for which you require voucher reprinting. You can also select the required event code from the adjoining option list.

The system displays the following details for the records matching the query criteria:

- Voucher ID
- Function ID
- Reference Number
- Host Reference Number
- Transaction Date
- USER ID
- Customer Number
- Branch Code
- Account number
- Event Code

The system displays the following details for records matching the parameters specified:

- Authorization Status
- Record Status
- Reprint Reference Number
- Voucher ID
- Branch Code
- User ID
- Function ID
- Event Code
- Reference Number
- Customer Number
- Account Number
- Transaction Date
- Host Reference Number

If you do not specify any parameters before clicking the 'Search' button, the system displays all the relevant records. Double-click a record to view it in detail.

28. Annexure - B - File Formats

28.1 Introduction

As mentioned earlier, SWIFT provides a country-wise holiday list that can be uploaded into Oracle FLEXCUE using the 'CCH' source code. This file consists of the 'HF' and 'HS' records. HF and HS are the tag identifiers through which the currency code can be obtained.

28.2 Upload File Formats

HF – Non-European countries

As mentioned before, the HF record comprises the holiday details for countries where 'EUR' is not the local currency. The currency code is obtained from the country code present in this record. The holiday record is then uploaded into the Oracle FLEXCUBE holiday upload table.

The HF record has the following format:

Position	Description	Length	Type	Mandatory	Data
1	Tag Identifier	2	VARCHAR2	Y	'HF'
3	Modification Flag	1	VARCHAR2	Y	'A' addition 'M' modification 'D' deletion 'U' unchanged
4	Country Code	2	VARCHAR2	Y	ISO Country Code
6	Country Name	35	VARCHAR2	Y	Country Name (first part)
41	Country Name	35	VARCHAR2	N	Country Name (second part)

Position	Description	Length	Type	Mandatory	Data
76	Date	8	VARCHAR2	Y	Date of a Holiday
84	Holiday type	1	VARCHAR2	Y	Code indicating type of Holiday (see below)
85	Special holiday info.	320	VARCHAR2	N	Restrictions applicable if a holiday is not applicable country-wide, or is not a full day

HS – For European countries

The HS record comprises the Target holiday details for countries where 'EUR' is the local currency. The holiday record is uploaded into the Oracle FLEXCUBE holiday upload table.

The HS record has the following format:

Position	Description	Length	Type	Mandatory	Data
1	Tag Identifier	2	VARCHAR2	Y	'HS'
3	Modification Flag	1	VARCHAR2	Y	'A' addition 'M' modification 'D' deletion

Position	Description	Length	Type	Mandatory	Data
					'U' unchanged
4	Service Code	3	VARCHAR2	Y	Value Added Service Code
7	Date	8	VARCHAR2	Y	Date of a Holiday
15	Holiday type	1	VARCHAR2	Y	Code indicating type of holiday(see below)
16	Special holiday info	320	VARCHAR2	N	Restrictions applicable if a holiday is not applicable country- wide, or is not a full day

29. Anti-Money Laundering Reporting

29.1 Guarding Against Money Laundering

In Oracle FLEXCUBE you can guard against Money Laundering by using the anti-money laundering option wherein you will be required to maintain certain basic information as a safeguard against Money Laundering activities that customers may indulge in.

The information that you need to maintain includes the maintenance of:

- Product Categories
- Limit Codes
- Customer Groups

29.1.1 Creating Product Categories in Oracle FLEXCUBE

You have to create product categories in Oracle FLEXCUBE, for the purpose of grouping common transactions. A product is a specific service that you offer your customers. Each transaction that you process in Oracle FLEXCUBE should be linked to a product. By maintaining amount limits at the product level, each time you link a transaction with a product the system verifies the amount limit maintained for the product. If the transaction amount exceeds the amount maintained at the product level the system intimates you with an override.

You can invoke the 'AML Product Categories Maintenance' screen by typing 'CSDAMLPC' in the field at the top right corner of the Application tool bar and clicking the adjoining arrow button.

The screenshot displays the 'AML Product Categories Maintenance' web page dialog. The form includes the following fields and options:

- Product Category:** RETRO ONLINE
- Description:** code for AML testing
- Limit Currency:** USD
- Exchange Rate Code:** STANDARD
- Exchange Rate Type:** Mid Rate
- Debit/Credit Indicator:** Radio buttons for Debit Indicator, Credit Indicator, Both (Aggregate Together), and Both (Aggregate Separately).
- Product Type:** Radio buttons for Cash and Non Cash.
- Frequency:** Tabs for Individual, Daily, Monthly, Online, and Online Daily.
- Limit Details:** A table with columns for Limit Code, Limit Amount, and Limit Currency.
- Fields:** Input By AN, Date Time 7/3/2000 10:09:52, Modification Number 2, Open, Authorized By AN, Date Time 7/3/2000 10:09:59, Authorized, and an Exit button.

Product Category

You should identify each product category with an identification code by giving it a unique name.

Description

With each product category you have to associate a brief description. This description is meant for information purposes and will not be used for any processing.

Limit Currency

You have to identify the currency in which limits have to be tracked for transactions associated with the product category.

A list of all the currencies maintained in Oracle FLEXCUBE is available in the option list positioned next to this field. You can select the appropriate.

Product Type

Transactions grouped under a product can either be cash based or non-cash based. Therefore, you would have created products catering to cash based and non-cash based transactions.

While creating a product category, you have to indicate whether the products grouped under the respective category cater to cash based or non-cash based transactions. You can select the appropriate option.

Exchange Rate Code and Rate Type

The rate associated with this rate code will be used to derive the exchange rate when the currency of the transaction is different from the limit currency of the product category.

Similarly, you have to select the Rate Type that is to be associated with the rate code. The options available are as follows:

- Mid
- Buy
- Sell

The rate code along with the rate type will determine the exchange rate that is to be used.

Debit/Credit Indicator

As part of Anti-Money Laundering you can indicate the manner in which the system should track the Debit and Credit turnover limits for any of the limit types, for the product category. The options available are:

- Both (Aggregate Together) – absolute values of debits and credits will be aggregated together
- Both (Aggregate Separately) – debits and credits will be aggregated separately
- Debits alone or Credits alone

Limit Code and Limit Amount

At the product category level, you can specify the limit amount that should be associated with each limit code for a limit type.

A list of all the limit codes maintained for the specific limit type (Online, Individual, Daily turnover Batch, Daily turnover Online and Monthly turnover), in the Limit Codes Maintenance screen, will be displayed in the option list positioned next to this field. You can select the appropriate limit code and specify the limit amount that is to be linked with the code.



For a particular product category you can choose to maintain Limit Code and Amount combinations for all of any of the five Limit types. They are:

- The Online transaction limit
- Individual limits
- Daily turnover limits
- Monthly turnover limits
- Online daily turnover limits

The transaction limits that you specify will be tracked online on a daily basis, whenever you process a transaction involving the product category. However, individual, daily and monthly turnover limits will be tracked only when the after the End of Day processes have been run successfully.

29.2 Maintaining Limit Codes

Before you begin the maintenance of product category records, you should necessarily maintain limit codes through the Limit Code Maintenance screen. While linking a limit amount with a limit code in the product category screen, only valid limit codes that you have maintained through this screen will be made available for mapping.

You can invoke this screen by typing 'CSDAMLLM' in the field at the top right corner of the Application tool bar and clicking the adjoining arrow button.

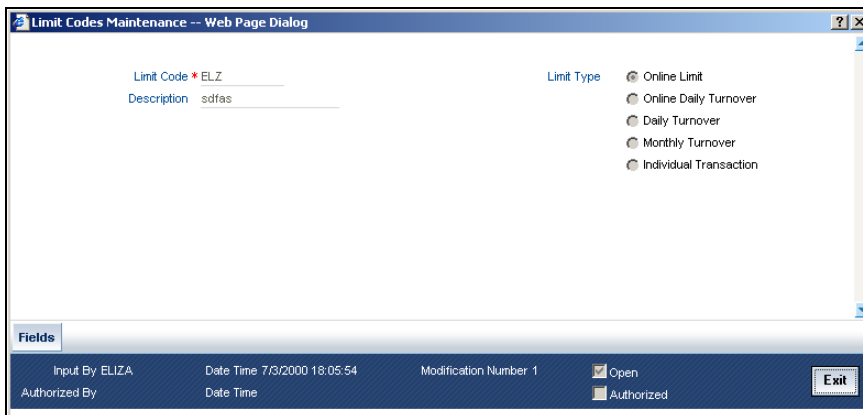

Limit Code

You can maintain limit codes for the various types of limit types like online tracking limits, individual tracking limits, daily turnover limits and monthly turnover limits.

You have to specify a unique name to identify each Limit Code that you would like to define. Subsequently, you can assign a brief description with each limit code that you define.

Limit Type

Since you can maintain separate limit codes for each limit type, you have to associate a limit code with each limit type. The options available are:

- Online Limit – tracks the limits of all online transaction that exceed limits
- Individual Transaction – during the batch processed executed at EOD the limit maintained for this type is used to tack all individual transactions that exceed the limit

- Online Daily Turnover –all transactions processed during the day are considered for an online tracking and an online reporting is done when the specified limit exceeds
- Monthly Turnover – all transactions processed during the month that have exceeded the specified limit will be reported
- Daily Turnover – during the batch processes executed at EOD all transactions for the business day that have exceed the limit will be reported

You can select the appropriate type from the list.

29.3 Maintaining Anti Money Laundering Customer Groups

Since you need to define transaction online, individual, daily and monthly limits for each customer, each product category that you maintain should be linked with a customer. To facilitate this linking, you are required to maintain AML Customer Groups. You have to link one of the limit codes of the respective type attached to the product category to the customer group

You can define product categories applicable to customer groups through the 'AML Customer Group Maintenance' screen. You can invoke this screen by typing 'CSDAMLCG' in the field at the top right corner of the Application tool bar and clicking the adjoining arrow button.

Customer Group

This is the AML group to which the particular customer belongs. You can select from the available option list and identify the AML group to which the customer belongs.

STOP In the CIF maintenance screen when you capture the customer code of a customer, the same will be defaulted in the AML Customer Group field since the system recognizes each customer code as a customer group. You can either choose to categorize the customer under the same group or choose another customer group.

You can capture a brief description that should be associated with every AML group

Next Review Date

While maintaining customer group and product category records you can specify the next date on which you would like to review the limits maintained for the various limit types.

Tracking

You have to specify whether the AML tracking is required for a customer or for all customers within a group. The system performs a group level tracking if you select Customer group. Conversely if you select Customer, the AML reporting, online tracking and data collection is done only at the customer level.



If you fail to indicate your preference specifically the system will perform a customer group level tracking by default

Risk Profile

You can identify the risk profile of the customer group by selecting any one of the following options:

- High – indicating that the limits for the customer group need to be tracked regardless of the amount involved since the customer group is meant for high-risk customers.
- Low – indicating that the customer group is meant for low risk customers therefore amount limits need not be tracked if the amount involved falls within the limit amount.

You can select the required specification.

29.3.1.1 Linking Product Category with Customer Group

You have the option of selecting and linking as many limit codes as required for each limit type from the product categories maintained in the system. After you select the product category that is to be linked to the customer group, you have to identify the limit code associated with the limit type and in turn link it with the customer group.

Given below is a sample of the Customer Group maintenance record:

The Main details of the record are as follows:

Customer Group	AMLCUS01
Description	AMLCUSTOMER GROUP 1
Next Review Date	10-FEB-2003
Risk Profile	High

The Product Category linkage details are as follows:

Product Category	Description	Online Limit Code	Individual Limit Code	Daily Limit Code	Monthly Limit Code	Online Daily Turnover
PDT01	Product 1	LIM31	LIM01	LIM11	LIM21	LIM41

Product Category	Description	Online Limit Code	Individual Limit Code	Daily Limit Code	Monthly Limit Code	Online Daily Turnover
PDT02	Product 2	LIM36	LIM06	LIM16	LIM26	LIM46

 Note the following:

- Consequently, while processing transactions for all customers linked to the Customer Group AMLCUS01, the system does an online verification of transaction limits based on the amount limits maintained for the limit code LIM31 (linked to the product category PDT01) and LIM36 (linked to the product category PDT02) respectively.
- It is mandatory for you to maintain a generic Customer Group called ALL for the customers of your bank. When product categories have not been linked to a specific customer or a customer group, the system picks up the limits maintained at the generic level for AML tracking purposes. Also, any new product category created and associated to the transaction code should be mandatorily associated with the ALL group.

29.4 Monitoring AML Accounting

For AML reporting purposes, while maintaining a transaction code you need to indicate whether AML monitoring is required for all accounting entries linked to the transaction code.

You can invoke this screen by typing 'STDTRCOD' in the field at the top right corner of the Application tool bar and clicking the adjoining arrow button.

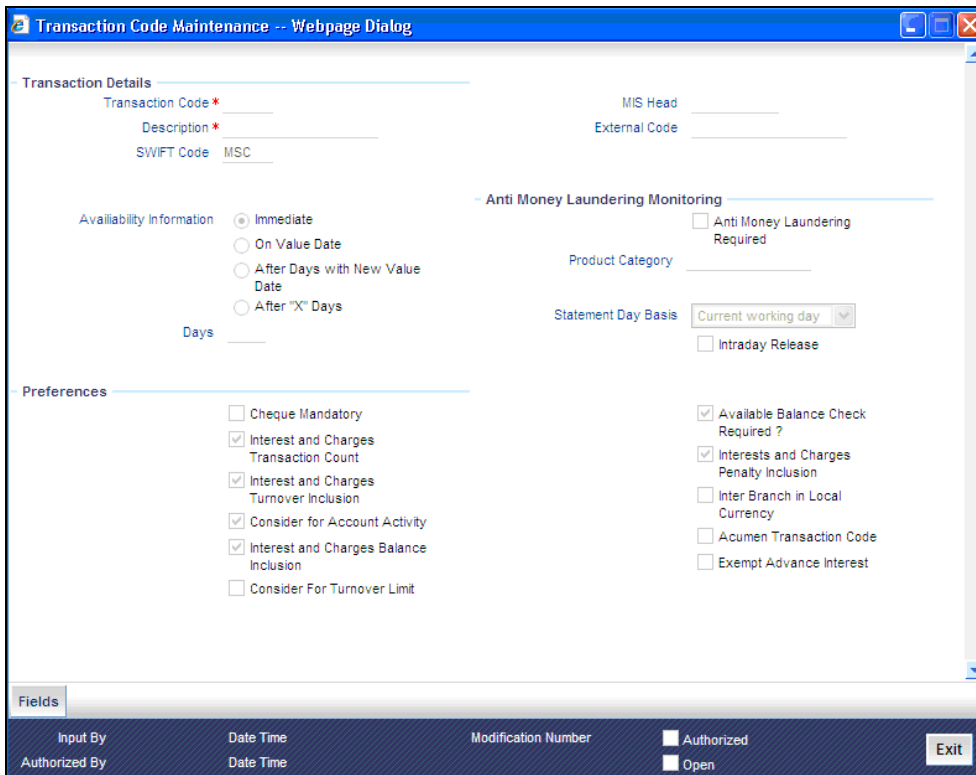

Transaction Code Maintenance -- Webpage Dialog

Transaction Details

Transaction Code * _____ MIS Head _____
Description * _____ External Code _____
SWIFT Code MSC _____

Availability Information

Immediate
 On Value Date
 After Days with New Value Date
 After "X" Days
Days _____

Anti Money Laundering Monitoring

Anti Money Laundering Required
Product Category _____
Statement Day Basis: Current working day (dropdown)
 Intraday Release

Preferences

Cheque Mandatory
 Interest and Charges Transaction Count
 Interest and Charges Turnover Inclusion
 Consider for Account Activity
 Interest and Charges Balance Inclusion
 Consider For Turnover Limit
 Available Balance Check Required ?
 Interests and Charges Penalty Inclusion
 Inter Branch in Local Currency
 Acumen Transaction Code
 Exempt Advance Interest

Fields

Input By _____ Date Time _____ Modification Number _____ Authorized
Authorized By _____ Date Time _____ Open **Exit**

If you indicate that AML tracking is required for transactions linked to the transaction code you have to identify the product category with which the transaction code is to be linked.

Consequently, the system does a check for every accounting entry passed during online processing. The system checks the transaction amount of the entry with the transaction online limit maintained for the specific customer group (of the customer to whose account the entry has been posted) and the product category (for the transaction code of the entry). If the system finds that the limit amount has been exceeded an override message informing you of the same will be displayed.

During the End of Day (EOD) processing, the system identifies all accounting entries posted during the day, which have been marked for AML monitoring, and verifies the individual amount limit for the customer group and product category combination and stores this data in the system. You will be able to view this data when you generate an AML report using Business Objects.

As part of the EOD processes the system also updates the daily turnover limits for the particular customer group and product category combination. Monthly turnovers are updated for the Customer Number, Product Category and Currency combination.

30.1 Introduction

You can generate the following reports:

- List of deleted transactions
- Accounting journal
- Cash flow report
- Balances of future dated transactions
- Current Rates Report
- Account Opening Confirmation
- Account Closing Confirmation
- Activity Journal Report
- Core Exception Report

30.2 List of Deleted Transactions

This report lists out the deleted transaction details pertaining to each product under each module pertaining to every user. You can invoke this screen by typing 'ACRDLTXN' in the field at the top right corner of the Application tool bar and clicking the adjoining arrow button.

The screenshot shows a web page dialog titled "Deleted Transactions Listing -- Web Page Dialog". The dialog has a light blue background and a dark blue header bar. It contains several sections for filtering data:

- Module:** Radio buttons for "Single" and "All" (selected). A dropdown menu shows "ALL".
- Products:** Radio buttons for "Single" and "All" (selected). A dropdown menu shows "ALL".
- User:** Radio buttons for "Single" and "All" (selected). A dropdown menu shows "ALL".
- Batch:** Two input fields labeled "From" and "To", each with a dropdown arrow.
- Transactions:** Radio buttons for "All" (selected), "This Branch", "Posted To Other Branch", and "This branch acted as bridge".
- Print Copies:** A checkbox labeled "Print Copies".
- Buttons:** "Ok" and "Exit" buttons at the bottom right.

Specify the following details.

Module

Indicate whether the reports should be generated for a single module or for all modules.

If you choose 'Single', you need to specify the module for which the report needs to be generated. The option list provided displays all valid module codes maintained in the system. You can select the appropriate one.

Transactions

Indicate the type of transactions that should be covered in the report. The following options are available:

- All
- This branch
- Posted to Other Branch
- This branch acted as bridge

Products

Indicate whether the reports should be generated for a single product or for all products.

If you choose 'Single', you need to specify the product code for which the report needs to be generated. The option list provided displays all valid product codes maintained in the system. You can select the appropriate one.

User

Indicate whether the reports should be generated for a transactions entered by all users or a single user.

If you choose 'Single', you need to specify the user ID based on which the report needs to be generated. The option list provided displays all valid user IDs maintained in the system. You can select the appropriate one.

From

Specify the date from which the transactions need to be considered for report generation.

To

Specify the date until which transactions need to be considered for report generation.

Print Copies

Check this box to indicate that the report needs to be printed.

Click 'OK' to generate the report.

30.2.1 Contents of Report

The contents of this report are discussed under the following heads:

Header

The Header carries the title of the report, information on the branch code, branch date, the ID of the user who generated the report, the date and time at which it was generated, the modules covered in the report, the product codes covered in the report, batch information, transactions covered in the report and printing preference.

Body of the report

This report is sorted module-wise. For every module the following details are displayed.

- Module
- Product
- User ID

The following transaction details are displayed.

Reference No	This is the reference number of the account for which deleted transaction details is being reported.
Ac Br	This is the branch where the account resides.
Account Number	This is the account number.
Ccy	This is the currency of the transaction.
Dr/Cr	This indicates the nature of the transaction – debit or credit.
Trn Code	This is the transaction code.
Account description	This is the account description.
Fcy Amount	This is the transaction amount in foreign currency.
Trn Description	This is the transaction description.
Narrative	This is the narrative text associated with the transaction.
Instrument No	This is the instrument number linked to the transaction.
Total Debits	Total amount debited under the product
Total Credits	Total amount credited under the product

Reference No	This is the reference number of the account for which deleted transaction details is being reported.
User ID	This is the user ID of the user who entered the transaction.

30.3 Accounting Journal

This report gives details of every journal entry transaction. You can invoke this screen by typing 'ACRJRNAL' in the field at the top right corner of the Application tool bar and clicking the adjoining arrow button.

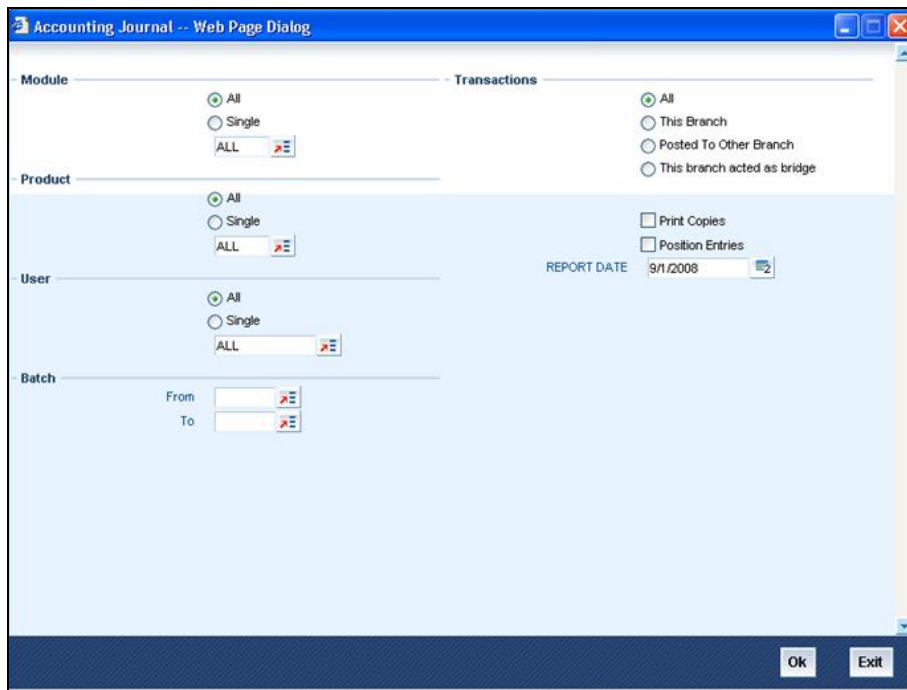

Specify the following details:

Module

Indicate whether the reports should be generated for a single module or for all modules.

If you choose 'Single', you need to specify the module for which the report needs to be generated. The option list provided displays all valid module codes maintained in the system. You can select the appropriate one.

Transactions

Indicate the type of transactions that should be covered in the report. The following options are available:

- All
- This branch
- Posted to Other Branch
- This branch acted as bridge

Products

Indicate whether the reports should be generated for a single product or for all products.

If you choose 'Single', you need to specify the product code for which the report needs to be generated. The option list provided displays all valid product codes maintained in the system. You can select the appropriate one.

User

Indicate whether the reports should be generated for a transactions entered by all users or a single user.

If you choose 'Single', you need to specify the user ID based on which the report needs to be generated. The option list provided displays all valid user IDs maintained in the system. You can select the appropriate one.

From

Specify the date from which the transactions need to be considered for report generation.

To

Specify the date until which transactions need to be considered for report generation.

Print Copies

Check this box to indicate that the report needs to be printed.

Position Entries

Check this box to indicate that the report needs to cover position accounting entries.

Report Date

Specify the date as on which the report needs to be generated.

Click 'OK' to generate the report.

30.3.1 Contents of Report

The contents of this report are discussed under the following heads:

Header

The Header carries the title of the report, information on the branch code, branch date, the ID of the user who generated the report, the date and time at which it was generated, the modules covered in the report, the product codes covered in the report, batch information, transactions covered in the report and printing preference.

Body of the report

The report is sorted by modules. Under every module, it lists out product-wise transaction details.

The following transaction details are displayed.

Product	This is the product code of the transaction.
User Id	This is the user ID of the user who entered the transaction.
Reference No	This is the transaction reference number.
Ac Br	This is the account branch.
Account Number	This is the account number.
Ccy	This is the currency of the transaction.
Dr/Cr	This is the nature of the transaction – either debit or credit.
Trn Code	This is the transaction code while posting the journal entry.
Description	This is the transaction description.
Status	Status of the transaction.
Value Date	This is the value date of the transaction.
Account Description	This is the description of the account.
Event	This is the event triggered on the transaction.
Fcy Amount	This is the transaction amount in a foreign currency
Exch Rate	This is the exchange rate used if the transaction is in any other currency.
Lcy Amount	This is the transaction amount in local currency.
Auth ID	This is the user ID of the user who authorized the transaction.
Total Debits	This is the total amount debited under the product.
Total Credits	This is the total amount credited under the product.

30.4 Cash Flow Report

The 'Cash flow report' gives details of the cash flow by accounts or by account class. The report contains details of the Account Number or Account Class, and the list of Accounts or Account Classes. You can invoke this screen by typing 'ACRPCASH' in the field at the top right corner of the Application tool bar and clicking the adjoining arrow button.

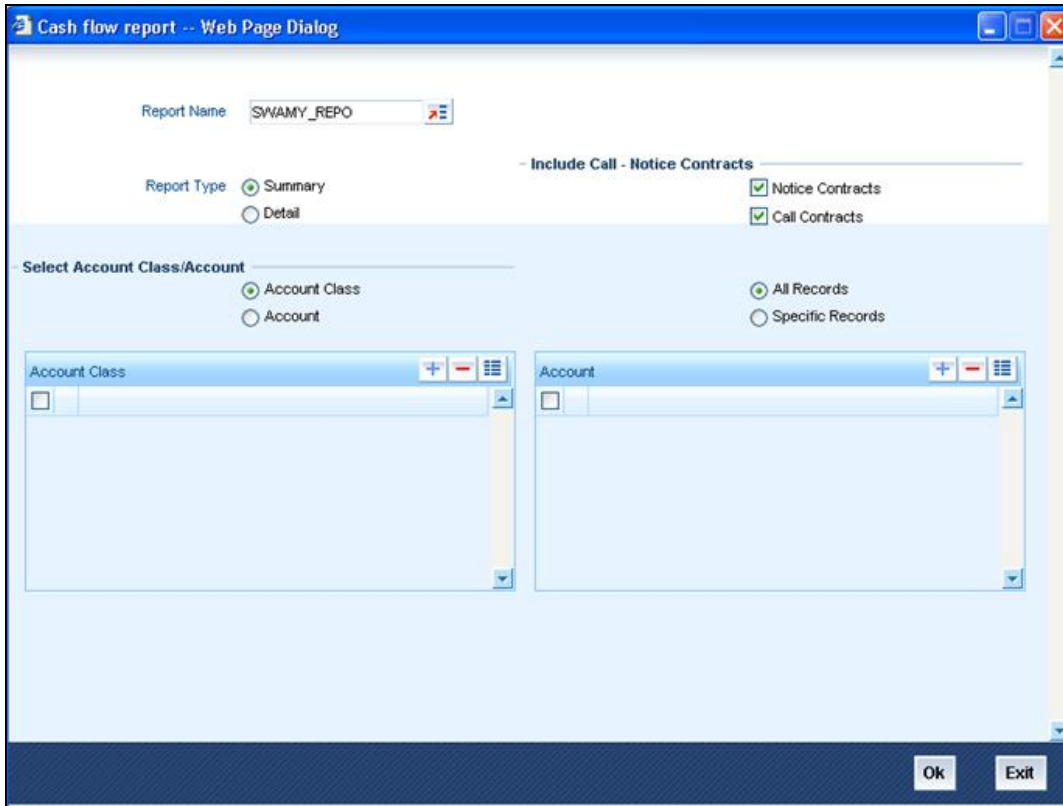

Specify the following details.

Report Name

Specify the name of the report. The option list provided displays all valid reports maintained in the system. You can select the appropriate one.

Report Type

Indicate whether the report should be a detailed report or a summary report.

Notice Contracts

Check this box to indicate that notice contracts should be covered in the report.

Call Contracts

Check this box to indicate that call contracts should be covered in the report.

Select Account Class/Account

Indicate whether the reports should be generated based on account class or account.

All/Specific Records

Indicate whether the reports should be generated for all records in an account class/account or for specific records.

Account Class

If you have indicated 'Account Class' as the basis for report generation, specify the account classes that should be considered. Click add icon to add rows. You can select a valid account class from the adjoining option list.

Account

If you have indicated 'Account' as the basis for report generation, specify the accounts that should be considered. Click add icon to add rows. You can select a valid account from the adjoining option list.

Click 'OK' to generate the report.

30.4.1 Contents of Report

The contents of the cash flow report are discussed under the following heads:

Header

The Header carries the title of the report, information on the branch code, the ID of the user who generated the report and the date and time at which it was generated.

Body of the report

The report is sorted on the currency of the cash flow.

Contract Reference Number	This is the reference number of the account for which transaction details is being reported.
Due Date	When the maturity of a deposit is being reported the Due Date will indicate the Maturity date. For a Call contract this will be Call. Similarly for a notice contract this will be Notice.
Amount In	This is the amount debited into the particular account for the particular period.
Amount Out	This is the amount credited from the account during the specified period.

30.4.2 Cash Flow (Summary) Report

The Cash Flow summary report summarizes the details of cash flow for particular Accounts or Account Classes.

Header

The Header carries the title of the report, information on the branch code, the ID of the user who generated the report and the date and time at which it was generated.

Body of the report

The report is sorted on the currency of the cash flow for different account classes and their accounts. The following details are displayed.

Amount In	This is the amount debited into the particular account for the specific period
Amount Out	This is the amount credited from the account during the specified period
Net Flow	This is the net amount available in the account for the specified period

30.5 Future Dated Account Balance Report

This report gives balances of future dated transactions. You can invoke the screen by typing 'ACRPFVBL' in the field at the top right corner of the Application tool bar and clicking the adjoining arrow button.

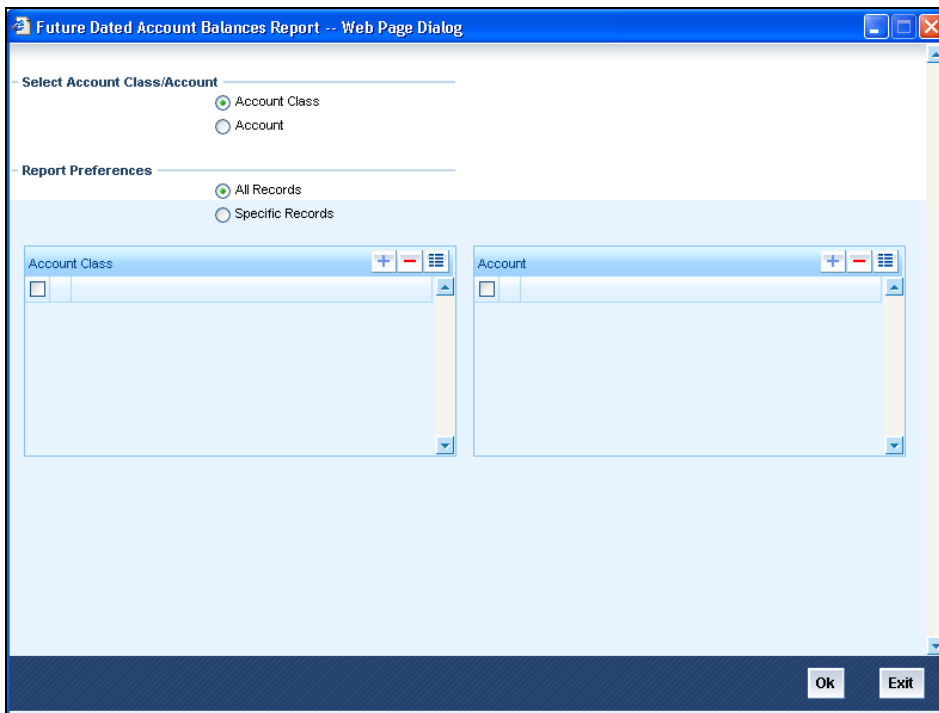

Header

The Header carries the title of the report, information on the branch code, branch date, the ID of the user who generated the report, the date and time at which it was generated and the modules covered in the report.

Body of the report

The following details are displayed.

Date	This gives the date for which the report is generated.
Reference No	This is the reference number for the report.
Inflow	This is the inflow amount.
Outflow	This is the outflow amount.

Date	This gives the date for which the report is generated.
Balance	This is the available balance.
Currency	This is the type of currency.
Customer	This is the name of the customer.
Account	This is the account number of the customer.
Account Class	This is the account class.
Opening	This is the opening balance.

30.6 Current Rates Report

This report gives details on rates for currency pairs. You can invoke the screen by typing 'CYRTCURR' in the field at the top right corner of the Application tool bar and clicking the adjoining arrow button.

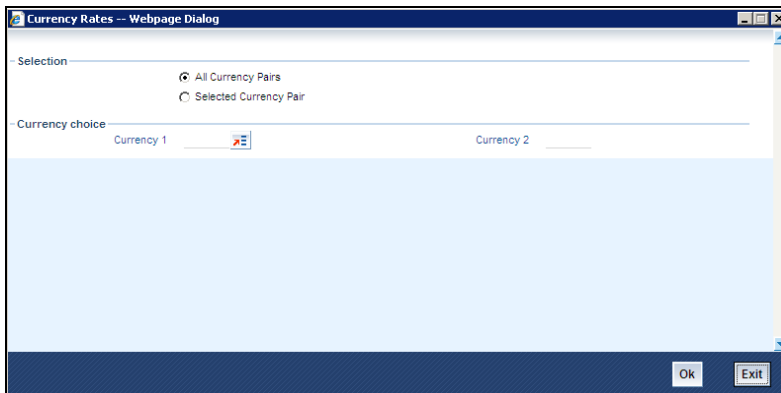

Specify the following details.

Selection

Indicate whether the report should be generated for all currency pairs or for a given currency pair.

Currency 1

If you have chosen, 'Selected Currency Pair', then specify the first currency that forms a pair. The adjoining option list displays all valid currency codes maintained in the system. You can select the appropriate one.

Currency 2

If you have chosen, 'Selected Currency Pair', then specify the second currency that forms the pair. The adjoining option list displays all valid currency codes maintained in the system. You can select the appropriate one.

Click 'OK' to generate the report.

30.6.1 Contents of Report

Header

The Header carries the title of the report, information on the branch code, the ID of the user who generated the report, the date and time at which it was generated, the module covered in the report and reporting options.

Body of the report

The report is sorted by currency pairs. The following details are displayed.

Currency Pair	This gives the currency pairs for which rate report has been generated.
Quotation	This indicates the quotation type – either direct or indirect.
No. of Units	This indicates the number of units of one currency being quoted against the other.
Rate Type	This is the rate type.
Mid Rate	This is the mid rate used for conversion.
Buy Rate	This is the buy rate used for conversion.
Sale Rate	This is the sell rate used for conversion.

30.7 Rate History Report

This report gives details on history of rates for currency pairs. You can invoke the screen by typing 'CYRTHIST' in the field at the top right corner of the Application tool bar and clicking the adjoining arrow button.

Currency Rate History Report - Options -- Web Page Dialog

Report For

All Currency Pairs
 Selected Currency Pair

Selected Pair

Currency1 USD Currency2 INR

Date Range

From Date 9/1/2008 To Date 9/1/2008

Ok Exit

Header

The Header carries the title of the report, information on the branch code, branch date, the ID of the user who generated the report, the date and time at which it was generated, the module covered in the report, reporting options, currency pair, from date and to date .

Body of the report

The report is sorted by currency pairs. The following details are displayed.

Currency Pair	This gives the currency pairs for which rate report has been generated.
Quotation	This indicates the quotation type – either direct or indirect.
No of Units	This indicates the number of units of one currency being quoted against the other.
Rate Type	This is the rate type.
Date	The effective date of the rates applied.
Mid Rate	This is the mid rate used for conversion.
Buy Rate	This is the buy rate used for conversion.
Sale Rate	This is the sell rate used for conversion.

30.8 Account Opening Confirmation

Account opening confirmation report provides information on the details of the customer account number and first account holder details. To invoke the screen, type 'CSRPACKO' in the field at the top right corner of the Application tool bar and clicking the adjoining arrow button.

Customer Account Opening Confirmation -- Web Page Dialog

Customer Report All Customers
 Single Customer

Customer Number

Date

Ok Exit

30.8.1 Contents of the Report

The contents of account opening confirmation have been discussed under the following heads:

Header

The Header carries the title of the report, information on the branch code, the ID of the user who generated the report, date and time at which it was generated, the modules covered in the report and customer number of the account holder for whom the report is being generated.

Body

You can find the following details in the body of the report:

Customer Account Number	The account number of the customer
Client Account Number	The account number of the client.
First Account Holder Details	Name, Address, Date of Birth, Telephone, E-mail, FAX, Account Opening Date and alternate Account Number of the first account holder

30.9 Account Closing Confirmation

This report gives details about closing confirmation of an account in 'Account Closing Confirmation' screen. To invoke this screen, type 'CSR PACCC' in the field at the top right corner of the Application tool bar and clicking the adjoining arrow button.

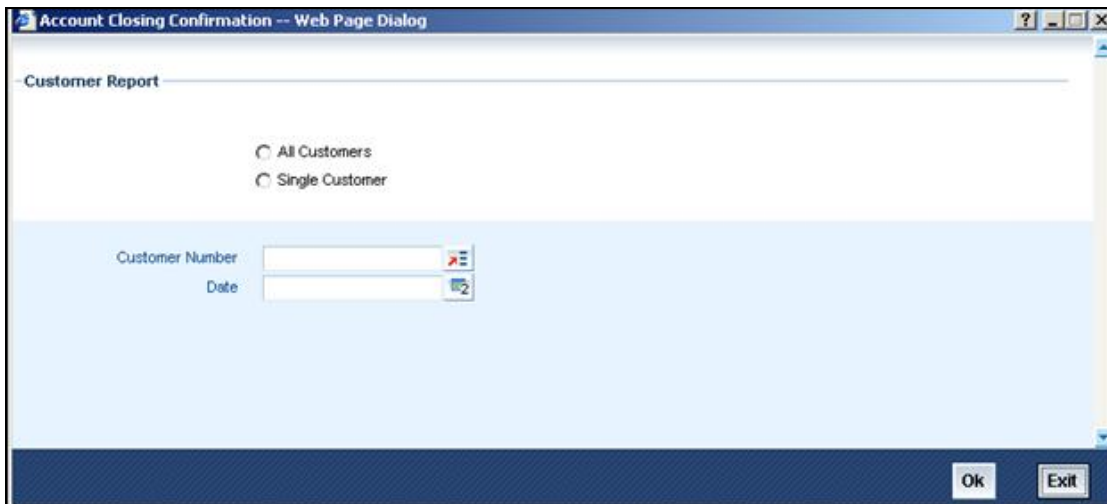

The screenshot shows a web page dialog titled "Account Closing Confirmation -- Web Page Dialog". The main content area is titled "Customer Report". Below the title, there are two radio buttons: "All Customers" and "Single Customer". Below the radio buttons, there are two input fields: "Customer Number" and "Date". At the bottom right of the dialog, there are "Ok" and "Exit" buttons.

30.9.1 Contents of Report

The contents of account closing confirmation have been discussed under the following heads:

Header

The Header carries the title of the report, information on the branch code, the ID of the user who generated the report, the date and time at which it was generated, the modules covered in the report and customer number of the account holder for whom the report is being generated.

Body

You can find the following details in the body of the report:

Client Number	The account number of the client
---------------	----------------------------------

30.10 Activity Journal Report

This report gives details about activity journal in 'Core Activity Journal' screen. To invoke this screen, type 'CSRFACTJ' in the field at the top right corner of the Application tool bar and clicking the adjoining arrow button.

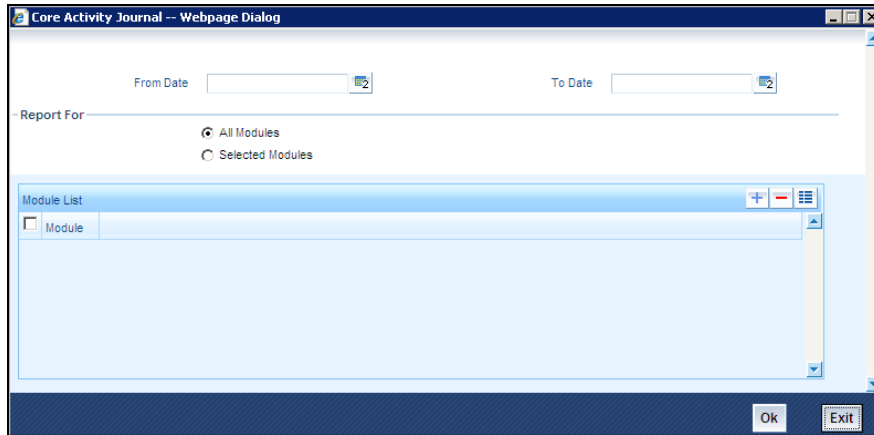

30.10.1 Contents of Report

The contents of account activity journal have been discussed under the following heads:

Header

The Header carries the title of the report, information on the branch code, the ID of the user who generated the report, the date and time at which it was generated and the modules covered in the report.

Body

You can find the following details in the body of the report:

Module	The module for which the report is being generated
Product Type	The type of product for which the report is being generated

Contract Ref No	The reference number of the contract being reported
Counter Party No	The CIF ID of the customer involved
Counter Party Name	This is the name of the customer involved
User Def. Status	The status if the user defined elements
Event Date	The date on which the event took place
Seq. No	The sequence number of the event
Event Description	The description of the event
Contract Status	The status of the contract i.e., active, closed etc.
Maker ID	The identification number of the maker
Checker ID	the identification number of the checker
Reversed Seq. No.	The reversed sequence number

30.11 Core Exception Report

This report gives details about core exception in 'Core Exception' screen. To invoke this screen, type **CSRPEXCP** in the field at the top right corner of the Application tool bar and clicking the adjoining arrow button.

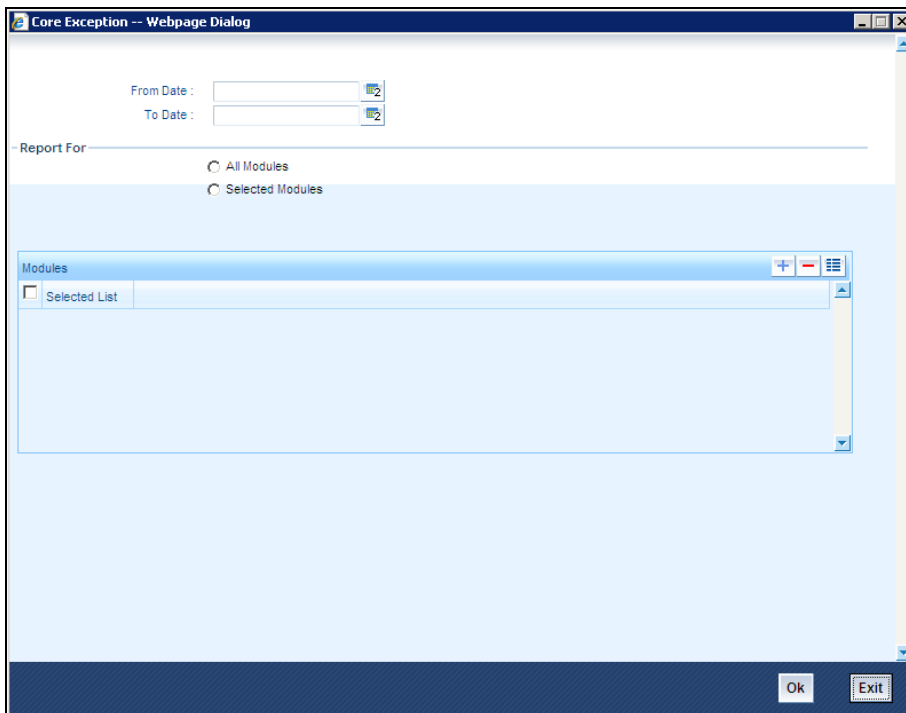

30.11.1 Contents of Report

The contents of core exception have been discussed under the following heads:

Header

The Header carries the title of the report, information on the branch code, the branch date, the ID of the user who generated the report, the date and time at which it was generated and the modules covered in the report.

Body

You can find the following details in the body of the report:

Module	The module for which the report is being generated
Contract Ref No	The reference number of the contract being reported
Counter Party	The name of the counter party
Counter Party Name	The name of the counter party involved
Date	The branch date
Event Description	The description of the event
Exception	The description about the exception

30.12 Uncollected Funds Report

This report gives details of all the uncollected funds. You can invoke this screen by typing 'ACRUNCOL' in the field at the top right corner of the Application tool bar and clicking the adjoining arrow button.

Uncollected Funds Print -- Web Page Dialog

Uncollected Funds Print

Accounts All One

Account

Date Option Present Date Between Dates

From Date 5/1/2008

To Date 12/1/2008

Ok Exit

Specify the following details.

Accounts

Select the type of account.

Account

Specify the account from the option list.

Date option

Select either Present Date or Between Dates option.

From Date

Specify the From date.

To Date

Specify the To date.

30.12.1 Contents of Report*Header*

The Header carries the title of the Report, information on the branch code, the branch date, the user ID, the module name, the date and time at which the report was generated and the page number of the report.

Body of the report

The details of the uncollected funds that would be displayed in the report are as follows:

Account	This is the account for which transaction details is being reported
Trn Refno	This is the reference number of the account for which transaction details is being reported
Amount	This is the amount debited into the particular account for the particular period
Total Amount	This is the total amount debited into the particular account during the specified period

30.13 Revaluation Report

This report gives details of the memo revaluation funds. You can invoke this screen by typing 'ACRREVAL' in the field at the top right corner of the Application tool bar and clicking the adjoining arrow button.

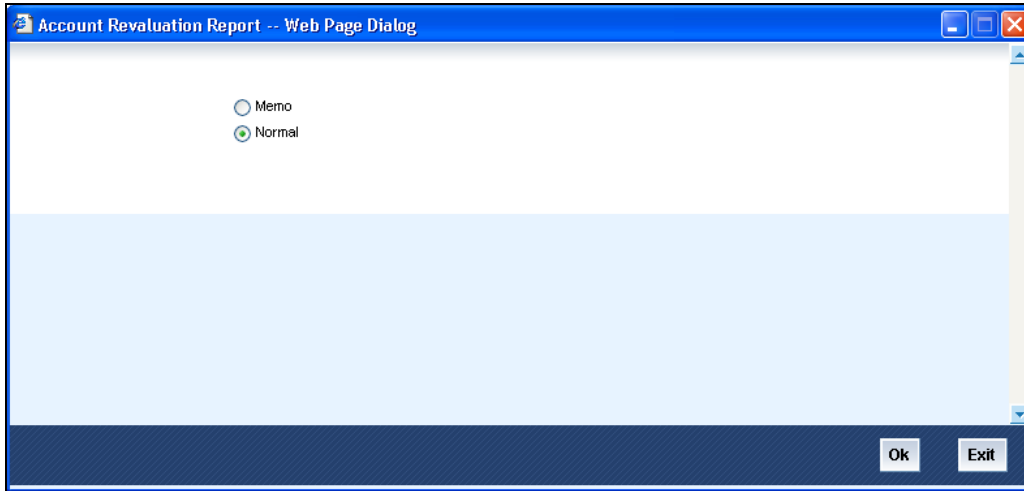

Memo or Normal

Specify the type of account revaluation report.

30.13.1 Contents of Report

Header

The Header carries the title of the Report, information on the branch code, the branch date, the user ID, the module name, the date and time at which the report was generated and the page number of the report.

Body of the report

The details of the uncollected funds that would be displayed in the report are as follows:

Currency	This is the currency for which transaction details is being reported
Revaluation Rate	This is the revaluation rate
Account	This is the account for which transaction details is being reported
Description	This is the description provided
Account Revalued	This is the revalued account
Account Balance	This indicated the account balance

Currency	This is the currency for which transaction details is being reported
Lcy Eq (before reval)	This indicates the local currency before revaluation
Lcy Eq (after reval)	This indicates the local currency after revaluation
Profit/ Loss	This is the profit or loss incurred
Profit/ Loss Amount	This is the profit or loss amount
Pnl Account	This is the profit or loss account
Currency	This is the currency for which transaction details is being reported
Rate	This is the revaluation rate
Category	This is the category

30.14 Accounts Movement Report

This report gives details of the movement of the accounts for that particular day. You can invoke this screen by typing 'ACRPMOVE' in the field at the top right corner of the Application tool bar and clicking the adjoining arrow button.

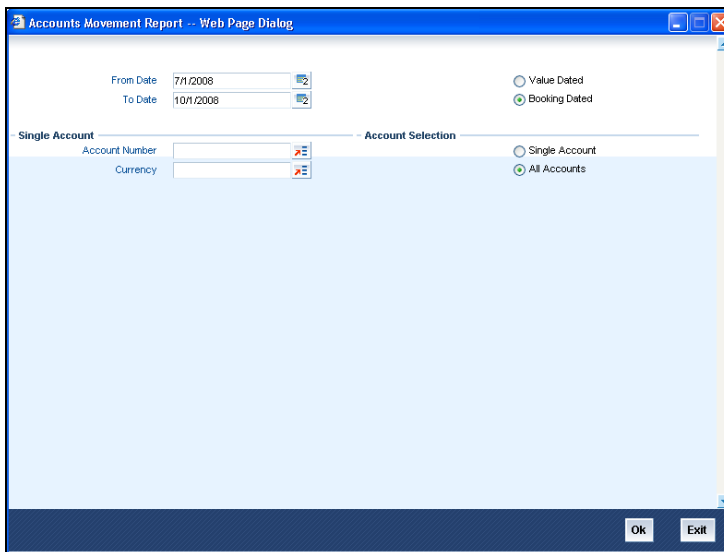

From Date

Specify the From Date from the option list.

To Date

Specify the From Date from the option list.

Account Number

Specify the account number from the option list.

Currency

Specify the currency from the option list.

Account Selection

Specify the type of account selection.

30.14.1 Contents of Report*Header*

The Header carries the title of the Report, information on the branch code, the branch date, the user ID, the module name, the date and time at which the report was generated and the page number of the report.

Body of the report

The details of the uncollected funds that would be displayed in the report are as follows:

Trn Date	This is the transaction date
Trn Refno	This is the reference number of the account for which transaction details is being reported
Value Date	This is the value date on which transaction details is being reported
Fcy Amount	This is the Foreign Currency debited into the particular account for the particular period
Rate	This is the revaluation rate
Lcy Amount	This is the Local Currency debited into the particular account for the particular period

30.15 Customer Details Report

This report gives details of the customer and you can generate this report using the 'Customer Details' screen.

You can invoke this screen by typing 'STRCIF' in the field at the top right corner of the Application tool bar and clicking the adjoining arrow button.

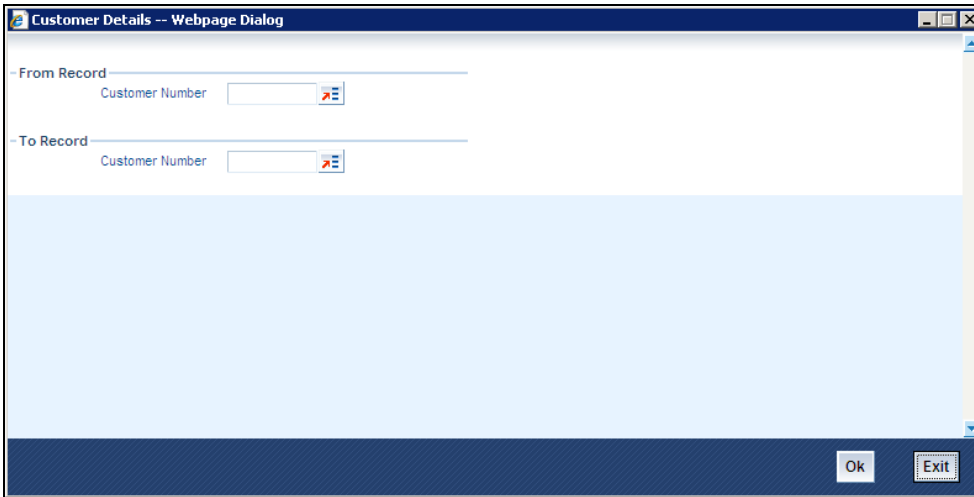

30.15.1 Contents of Report

Header

The Header carries the branch, information on the branch date, the user ID, the module name, the date and time at which the report was generated and the page number of the report.

Body of the report

The details of the customer information details that would be displayed in the report are as follows:

Customer	Customer Identification Number of the customer
Customer Name	Customer name
Address line	Displays the address of the customer.
Country	The country the customer belongs to.
Nationality	The nationality of the customer.
Type	Type of the customer (individual or Corporate or Bank).
Unique ID Name	Displays the customer's unique id name.
Unique ID Value	Displays the customer's unique id value.
Creation Date	Displays the date of customer's number creation.
Input By	The Login ID of the user that created the customer record.
Input Date	The date the customer record was created.

Auth By	The Login ID of the user that has authorized the record.
Auth Date	The date of the authorization.
Mod No	Displays the number of times the record was modified.
Auth Stat	Displays the current status of the customer record.
Record	Displays the record status.
Exposure Country	Displays the exposure country details.
Frozen	Displays the frozen status of the customer's account.
Local Branch	Displays the customer's local branch details.
Whereabouts Unknown	Gives the customer's details regarding the whereabouts.
Deceased	Indicates whether the customer is fit or deceased.
Short Name	Customer's abbreviated name.
Liability	This is the customer Liability ID number for which credit facility granted to the customer.
Language	Language.
Category	Category of the customer of the bank.

30.16 **Customer Accounts Report**

This report gives details of the customer account and you can generate this report using the 'Customer Accounts' screen.

You can invoke this screen by typing 'STRCUSAC' in the field at the top right corner of the Application tool bar and clicking the adjoining arrow button.

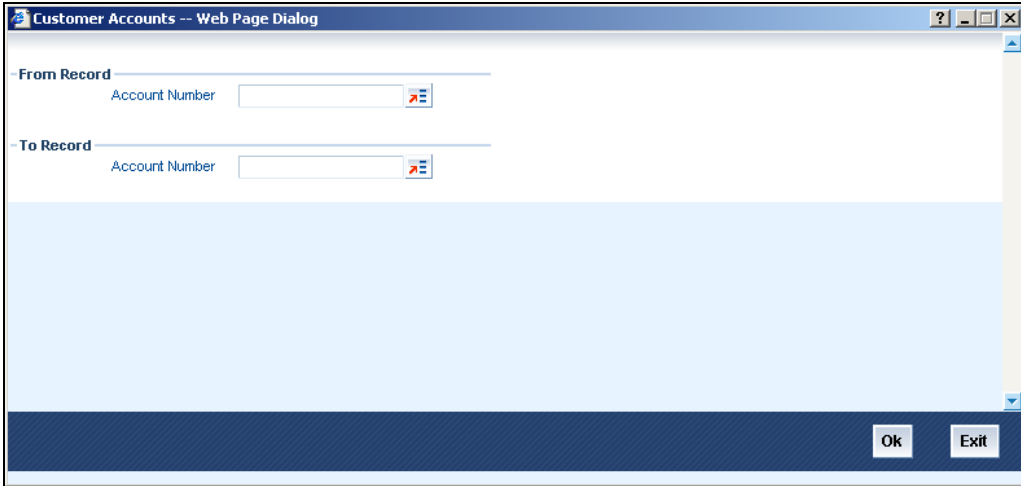

30.16.1 Contents of Report

Header

The Header carries the branch, information on the branch date, the user ID, the module name, the date and time at which the report was generated and the page number of the report.

Body of the report

The details of the customer accounts details that would be displayed in the report are as follows:

Customer Account No.	Details about customer account Number
Account Class	Details about account class
Ac Desc	Account Description
Ac open date	The opening date of the account.
Ac Stat Dormant	The account status as dormant
Ac Stat Frozen	Account status as frozen.
Ac Stat No Cr	Gives the credit account number status.
Ac Stat No Dr	Gives the debit account number status.
Ac Stat Stop Pay	Gives the accounts stop pay status.
Ac Stmt Cycle	Gives the account statement cycle.
Ac Stmt Day	Gives the account statement day.

Ac Stmt Type	Gives account statement type.
Alt Ac No	Gives an alternative account number.
Branch Code	Gives the branch code.
Ccy	Currency
Cust No.	Gives customer number.
Nominee1	Gives the first nominee details
Nominee2	Gives the second nominee details
Account Type	Gives the account type.
Dr Gl	Gives all debit balances within a specific account class
Cr Gl	Gives all credit balances within a specific account class.
Dr Ho Line	In this, all accounts belonging to account class will report, if they move to the status being defined.
Cr Ho Line	In this, all accounts belonging to account class will report, if they move to the status being defined.
Dr Cb Line	This is a GL to which all debit accounts belonging to an account class should report to.
Cr Cb Line	This is a GL to which all credit accounts belonging to an account class should report to.
Atm Facility	Availability of ATM facility.
Cheque Book Facility	Availability of cheque book facility.
Passbook Facility	Availability of passbook facility.
Previous Statement Date	Gives the date of the previous statement.
Previous Statement Balance	Gives the balance of the previous statement.
Previous Statement No.	Gives the number of the previous statement
Tod Limit	The temporary overdraft limit facility granted to the customer account

Sublimit	It the overdraft facility maximum permitted to this account associated and tracked against the line id maintained for the liability.
Tod Limit Start Date	The start date for the temporary overdraft facility
Tod Limit End Date	The end date for the temporary overdraft facility.
Uncoll Funds Limit	The funds hit the account which are debited / credited to the account with effect from the mentioned value days
Line ID	The line code is associated with the liability ID against which the overdraft facility is being tracked.
Tanked Status	It is the status of the transaction that hit the account in a specific branch once the branch is marked for EOTI.
Account Balance	Gives the total account balance
Maker ID	The identification number of the maker
Maker Dt Stamp	This is the date on which the contract was uploaded.
Checker ID	This is the Login ID of the user who authorized the product.
Checker Date Stamp	This is the date on which the product was authorized.
Mod No.	Displays the number of times the record was modified.
Record Stat	Displays the current status of the external account record.
Auth Stat.	Displays the current authorization status of the record.



Core Services
[January] [2016]

Oracle Financial Services Software Limited
Oracle Park
Off Western Express Highway
Goregaon (East)
Mumbai, Maharashtra 400 063
India

Worldwide Inquiries:

Phone: +91 22 6718 3000

Fax: +91 22 6718 3001

www.oracle.com/financialservices/

Copyright © [2013] [2016] , Oracle and/or its affiliates. All rights reserved.

Oracle and Java are registered trademarks of Oracle and/or its affiliates. Other names may be trademarks of their respective owners.

U.S. GOVERNMENT END USERS: Oracle programs, including any operating system, integrated software, any programs installed on the hardware, and/or documentation, delivered to U.S. Government end users are “commercial computer software” pursuant to the applicable Federal Acquisition Regulation and agency-specific supplemental regulations. As such, use, duplication, disclosure, modification, and adaptation of the programs, including any operating system, integrated software, any programs installed on the hardware, and/or documentation, shall be subject to license terms and license restrictions applicable to the programs. No other rights are granted to the U.S. Government.

This software or hardware is developed for general use in a variety of information management applications. It is not developed or intended for use in any inherently dangerous applications, including applications that may create a risk of personal injury. If you use this software or hardware in dangerous applications, then you shall be responsible to take all appropriate failsafe, backup, redundancy, and other measures to ensure its safe use. Oracle Corporation and its affiliates disclaim any liability for any damages caused by use of this software or hardware in dangerous applications.

This software and related documentation are provided under a license agreement containing restrictions on use and disclosure and are protected by intellectual property laws. Except as expressly permitted in your license agreement or allowed by law, you may not use, copy, reproduce, translate, broadcast, modify, license, transmit, distribute, exhibit, perform, publish or display any part, in any form, or by any means. Reverse engineering, disassembly, or decompilation of this software, unless required by law for interoperability, is prohibited.

The information contained herein is subject to change without notice and is not warranted to be error-free. If you find any errors, please report them to us in writing.

This software or hardware and documentation may provide access to or information on content, products and services from third parties. Oracle Corporation and its affiliates are not responsible for and expressly disclaim all warranties of any kind with respect to third-party content, products, and services. Oracle Corporation and its affiliates will not be responsible for any loss, costs, or damages incurred due to your access to or use of third-party content, products, or services.