

Developer's Guide to Oracle® Solaris 11.3 Security

ORACLE®

Part No: E54753
April 2020

Part No: E54753

Copyright © 2000, 2020, Oracle and/or its affiliates. All rights reserved.

This software and related documentation are provided under a license agreement containing restrictions on use and disclosure and are protected by intellectual property laws. Except as expressly permitted in your license agreement or allowed by law, you may not use, copy, reproduce, translate, broadcast, modify, license, transmit, distribute, exhibit, perform, publish, or display any part, in any form, or by any means. Reverse engineering, disassembly, or decompilation of this software, unless required by law for interoperability, is prohibited.

The information contained herein is subject to change without notice and is not warranted to be error-free. If you find any errors, please report them to us in writing.

If this is software or related documentation that is delivered to the U.S. Government or anyone licensing it on behalf of the U.S. Government, then the following notice is applicable:

U.S. GOVERNMENT END USERS: Oracle programs, including any operating system, integrated software, any programs installed on the hardware, and/or documentation, delivered to U.S. Government end users are "commercial computer software" pursuant to the applicable Federal Acquisition Regulation and agency-specific supplemental regulations. As such, use, duplication, disclosure, modification, and adaptation of the programs, including any operating system, integrated software, any programs installed on the hardware, and/or documentation, shall be subject to license terms and license restrictions applicable to the programs. No other rights are granted to the U.S. Government.

This software or hardware is developed for general use in a variety of information management applications. It is not developed or intended for use in any inherently dangerous applications, including applications that may create a risk of personal injury. If you use this software or hardware in dangerous applications, then you shall be responsible to take all appropriate fail-safe, backup, redundancy, and other measures to ensure its safe use. Oracle Corporation and its affiliates disclaim any liability for any damages caused by use of this software or hardware in dangerous applications.

Oracle and Java are registered trademarks of Oracle and/or its affiliates. Other names may be trademarks of their respective owners.

Intel and Intel Xeon are trademarks or registered trademarks of Intel Corporation. All SPARC trademarks are used under license and are trademarks or registered trademarks of SPARC International, Inc. AMD, Opteron, the AMD logo, and the AMD Opteron logo are trademarks or registered trademarks of Advanced Micro Devices. UNIX is a registered trademark of The Open Group.

This software or hardware and documentation may provide access to or information about content, products, and services from third parties. Oracle Corporation and its affiliates are not responsible for and expressly disclaim all warranties of any kind with respect to third-party content, products, and services unless otherwise set forth in an applicable agreement between you and Oracle. Oracle Corporation and its affiliates will not be responsible for any loss, costs, or damages incurred due to your access to or use of third-party content, products, or services, except as set forth in an applicable agreement between you and Oracle.

Access to Oracle Support

Oracle customers that have purchased support have access to electronic support through My Oracle Support. For information, visit <http://www.oracle.com/pls/topic/lookup?ctx=acc&id=info> or visit <http://www.oracle.com/pls/topic/lookup?ctx=acc&id=trs> if you are hearing impaired.

Référence: E54753

Copyright © 2000, 2020, Oracle et/ou ses affiliés. Tous droits réservés.

Ce logiciel et la documentation qui l'accompagne sont protégés par les lois sur la propriété intellectuelle. Ils sont concédés sous licence et soumis à des restrictions d'utilisation et de divulgation. Sauf stipulation expresse de votre contrat de licence ou de la loi, vous ne pouvez pas copier, reproduire, traduire, diffuser, modifier, accorder de licence, transmettre, distribuer, exposer, exécuter, publier ou afficher le logiciel, même partiellement, sous quelque forme et par quelque procédé que ce soit. Par ailleurs, il est interdit de procéder à toute ingénierie inverse du logiciel, de le désassembler ou de le décompiler, excepté à des fins d'interopérabilité avec des logiciels tiers ou tel que prescrit par la loi.

Les informations fournies dans ce document sont susceptibles de modification sans préavis. Par ailleurs, Oracle Corporation ne garantit pas qu'elles soient exemptes d'erreurs et vous invite, le cas échéant, à lui en faire part par écrit.

Si ce logiciel, ou la documentation qui l'accompagne, est livré sous licence au Gouvernement des Etats-Unis, ou à quiconque qui aurait souscrit la licence de ce logiciel pour le compte du Gouvernement des Etats-Unis, la notice suivante s'applique :

U.S. GOVERNMENT END USERS: Oracle programs, including any operating system, integrated software, any programs installed on the hardware, and/or documentation, delivered to U.S. Government end users are "commercial computer software" pursuant to the applicable Federal Acquisition Regulation and agency-specific supplemental regulations. As such, use, duplication, disclosure, modification, and adaptation of the programs, including any operating system, integrated software, any programs installed on the hardware, and/or documentation, shall be subject to license terms and license restrictions applicable to the programs. No other rights are granted to the U.S. Government.

Ce logiciel ou matériel a été développé pour un usage général dans le cadre d'applications de gestion des informations. Ce logiciel ou matériel n'est pas conçu ni n'est destiné à être utilisé dans des applications à risque, notamment dans des applications pouvant causer un risque de dommages corporels. Si vous utilisez ce logiciel ou ce matériel dans le cadre d'applications dangereuses, il est de votre responsabilité de prendre toutes les mesures de secours, de sauvegarde, de redondance et autres mesures nécessaires à son utilisation dans des conditions optimales de sécurité. Oracle Corporation et ses affiliés déclinent toute responsabilité quant aux dommages causés par l'utilisation de ce logiciel ou matériel pour des applications dangereuses.

Oracle et Java sont des marques déposées d'Oracle Corporation et/ou de ses affiliés. Tout autre nom mentionné peut correspondre à des marques appartenant à d'autres propriétaires qu'Oracle.

Intel et Intel Xeon sont des marques ou des marques déposées d'Intel Corporation. Toutes les marques SPARC sont utilisées sous licence et sont des marques ou des marques déposées de SPARC International, Inc. AMD, Opteron, le logo AMD et le logo AMD Opteron sont des marques ou des marques déposées d'Advanced Micro Devices. UNIX est une marque déposée de The Open Group.

Ce logiciel ou matériel et la documentation qui l'accompagne peuvent fournir des informations ou des liens donnant accès à des contenus, des produits et des services émanant de tiers. Oracle Corporation et ses affiliés déclinent toute responsabilité ou garantie expresse quant aux contenus, produits ou services émanant de tiers, sauf mention contraire stipulée dans un contrat entre vous et Oracle. En aucun cas, Oracle Corporation et ses affiliés ne sauraient être tenus pour responsables des pertes subies, des coûts occasionnés ou des dommages causés par l'accès à des contenus, produits ou services tiers, ou à leur utilisation, sauf mention contraire stipulée dans un contrat entre vous et Oracle.

Accès aux services de support Oracle

Les clients Oracle qui ont souscrit un contrat de support ont accès au support électronique via My Oracle Support. Pour plus d'informations, visitez le site <http://www.oracle.com/pls/topic/lookup?ctx=acc&id=info> ou le site <http://www.oracle.com/pls/topic/lookup?ctx=acc&id=trs> si vous êtes malentendant.

Contents

Using This Documentation	17
1 Oracle Solaris Security for Developers (Overview)	19
Overview of Oracle Solaris Security Features for Developers	19
System Security	19
Security Extensions Framework	21
Network Security Architecture	23
2 Developing Privileged Applications	25
Privileged Applications	25
About Privileges	26
How Administrators Assign Privileges	26
How Privileges Are Implemented	26
Compatibility Between the Superuser and Privilege Models	28
Privilege Categories	28
Programming with Privileges	30
Privilege Data Types	30
Privilege Interfaces	30
Privilege Coding Example	33
Guidelines for Developing Privileged Applications	36
About Authorizations	37
3 Writing PAM Applications and Services	41
Introduction to the PAM Framework	41
PAM Service Modules	42
PAM Library	43
PAM Authentication Process	44
Requirements for PAM Consumers	44

PAM Configuration	45
Writing Applications That Use PAM Services	46
A Simple PAM Consumer Example	46
Other Useful PAM Functions	51
Writing Conversation Functions	51
Writing Modules That Provide PAM Services	56
Requirements for PAM Service Providers	56
Sample PAM Provider Service Module	57
4 Writing Applications That Use GSS-API	61
Introduction to GSS-API	61
Application Portability With GSS-API	63
Security Services in GSS-API	63
Available Mechanisms in GSS-API	64
Remote Procedure Calls With GSS-API	64
Limitations of GSS-API	65
Language Bindings for GSS-API	65
Where to Get More Information on GSS-API	65
Important Elements of GSS-API	66
GSS-API Data Types	66
GSS-API Status Codes	74
GSS-API Tokens	75
Developing Applications That Use GSS-API	77
Generalized GSS-API Usage	78
Working With Credentials in GSS-API	78
Working With Contexts in GSS-API	80
Sending Protected Data in GSS-API	89
Cleaning Up a GSS-API Session	97
5 GSS-API Client Example	99
GSSAPI Client Example Overview	99
GSSAPI Client Example Structure	99
Running the GSSAPI Client Example	100
GSSAPI Client Example: main() Function	100
Opening a Connection With the Server	102
Establishing a Security Context With the Server	103
Translating a Service Name into GSS-API Format	104

Establishing a Security Context for GSS-API	105
Miscellaneous GSSAPI Context Operations on the Client Side	108
Wrapping and Sending a Message	109
Reading and Verifying a Signature Block From a GSS-API Client	112
Deleting the Security Context	113
6 GSS-API Server Example	115
GSSAPI Server Example Overview	115
GSSAPI Server Example Structure	115
Running the GSSAPI Server Example	116
GSSAPI Server Example: main() Function	116
Acquiring Credentials	119
Checking for inetd	122
Receiving Data From a Client	122
Accepting a Context	124
Unwrapping the Message	129
Signing and Returning the Message	129
Using the test_import_export_context() Function	130
Cleanup in the GSSAPI Server Example	131
7 Writing Applications That Use SASL	133
Introduction to Simple Authentication Security Layer (SASL)	133
SASL Library Basics	133
Steps in the SASL Cycle	139
SASL Example	149
SASL for Service Providers	152
SASL Plugin Overview	152
SASL Plugin Development Guidelines	158
8 Introduction to the Oracle Solaris Cryptographic Framework	161
Oracle Solaris Cryptography Terminology	161
Overview of the Cryptographic Framework	162
Components of the Cryptographic Framework	163
What Cryptography Developers Need to Know	165
Requirements for Developers of User-Level Consumers	165
Requirements for Developers of User-Level Providers	165

9 Writing User-Level Cryptographic Applications	167
Overview of the Cryptoki Library	167
PKCS #11 Function List	168
Functions for Using PKCS #11	168
Extended PKCS #11 Functions	174
User-Level Cryptographic Application Examples	175
Message Digest Example	175
Symmetric Encryption Example	179
Sign and Verify Example	183
Random Byte Generation Example	191
10 Introduction to the Oracle Solaris Key Management Framework	195
Oracle Solaris Key Management Framework Features	195
Oracle Solaris Key Management Framework Components	196
KMF Key Management Tool	196
KMF Policy Enforcement Mechanisms	197
KMF Application Programming Interfaces	198
Oracle Solaris Key Management Framework Example Application	199
KMF Headers and Libraries	199
KMF Basic Data Types	200
KMF Application Results Verification	200
Complete KMF Application Source Code	201
A Secure Coding Guidelines for Developers	209
B Sample C-Based GSS-API Programs	211
Client-Side Application	211
Server-Side Application	223
Miscellaneous GSS-API Sample Functions	234
C GSS-API Reference	243
GSS-API Functions	243
Functions From Previous Versions of GSS-API	245
GSS-API Status Codes	246
GSS-API Major Status Code Values	246
Displaying Status Codes	248

Status Code Macros	249
GSS-API Data Types and Values	249
Basic GSS-API Data Types	250
Name Types	251
Address Types for Channel Bindings	252
Implementation-Specific Features in GSS-API	253
Oracle Solaris-Specific Functions	253
Human-Readable Name Syntax	253
Implementations of Selected Data Types	254
Deletion of Contexts and Stored Data	254
Protection of Channel-Binding Information	254
Context Exportation and Interprocess Tokens	254
Types of Credentials Supported	255
Credential Expiration	255
Context Expiration	255
Wrap Size Limits and QOP Values	255
Use of <i>minor_status</i> Parameter	255
Kerberos v5 Status Codes	256
Messages Returned in Kerberos v5 for Status Code 1	256
Messages Returned in Kerberos v5 for Status Code 2	257
Messages Returned in Kerberos v5 for Status Code 3	258
Messages Returned in Kerberos v5 for Status Code 4	259
Messages Returned in Kerberos v5 for Status Code 5	260
Messages Returned in Kerberos v5 for Status Code 6	261
Messages Returned in Kerberos v5 for Status Code 7	262
D Specifying an OID	263
Files with OID Values	263
/etc/gss/mech File	263
/etc/gss/qop File	264
gss_str_to_oid() Function	265
Constructing Mechanism OIDs	265
createMechOid() Function	266
Specifying a Non-Default Mechanism	267
E Source Code for SASL Example	269

SASL Client Example	269
SASL Server Example	279
Common Code	289
F SASL Reference Tables	293
SASL Interface Summaries	293
G Security Considerations When Using C Functions	299
Glossary	309
Index	313

Figures

FIGURE 1	PAM Architecture	42
FIGURE 2	GSS-API Layer	62
FIGURE 3	RPCSEC_GSS and GSS-API	64
FIGURE 4	Internal Names and Mechanism Names	69
FIGURE 5	Comparing Names (Slow)	70
FIGURE 6	Comparing Names (Fast)	72
FIGURE 7	Exporting Contexts: Multithreaded Acceptor Example	88
FIGURE 8	<code>gss_get_mic()</code> versus <code>gss_wrap()</code>	90
FIGURE 9	Message Replay and Message Out-of-Sequence	93
FIGURE 10	Confirming MIC Data	95
FIGURE 11	Confirming Wrapped Data	96
FIGURE 12	SASL Architecture	135
FIGURE 13	SASL Life Cycle	140
FIGURE 14	SASL Session Initialization	143
FIGURE 15	SASL Authentication: Sending Client Data	145
FIGURE 16	SASL Authentication: Processing Server Data	147
FIGURE 17	Overview of the Oracle Solaris Cryptographic Framework	163
FIGURE 18	Major-Status Encoding	246

Tables

TABLE 1	Interfaces for Using Privileges	31
TABLE 2	Privilege Set Transition	35
TABLE 3	GSS-API Calling Errors	247
TABLE 4	GSS-API Routine Errors	247
TABLE 5	GSS-API Supplementary Information Codes	248
TABLE 6	Channel Binding Address Types	252
TABLE 7	Kerberos v5 Status Codes 1	256
TABLE 8	Kerberos v5 Status Codes 2	257
TABLE 9	Kerberos v5 Status Codes 3	258
TABLE 10	Kerberos v5 Status Codes 4	259
TABLE 11	Kerberos v5 Status Codes 5	260
TABLE 12	Kerberos v5 Status Codes 6	261
TABLE 13	Kerberos v5 Status Codes 7	262
TABLE 14	SASL Functions Common to Clients and Servers	293
TABLE 15	Basic SASL Client_only Functions	294
TABLE 16	Basic SASL Server Functions (Clients Optional)	294
TABLE 17	SASL Functions for Configuring Basic Services	294
TABLE 18	SASL Utility Functions	294
TABLE 19	SASL Property Functions	295
TABLE 20	Callback Data Types	295
TABLE 21	SASL Include Files	295
TABLE 22	SASL Return Codes: General	296
TABLE 23	SASL Return Codes: Client-Only	296
TABLE 24	SASL Return Codes: Server-Only	296
TABLE 25	SASL Return Codes – Password Operations	297
TABLE 26	Security Considerations When Using C Functions	299

Examples

EXAMPLE 1	Enabling ASLR in a Program	22
EXAMPLE 2	Managing Security Extensions in Objects With <code>elfdump</code> and <code>elfedit</code>	22
EXAMPLE 3	Superuser Privilege Bracketing Example	33
EXAMPLE 4	Least Privilege Bracketing Example	34
EXAMPLE 5	Checking for Authorizations	38
EXAMPLE 6	Sample PAM Consumer Application	48
EXAMPLE 7	PAM Conversation Function	52
EXAMPLE 8	Sample PAM Service Module	58
EXAMPLE 9	Using Strings in GSS-API	66
EXAMPLE 10	Using <code>gss_import_name()</code>	68
EXAMPLE 11	OIDs Structure	73
EXAMPLE 12	OID Set Structure	73
EXAMPLE 13	<code>gss-client</code> Example: <code>main()</code>	101
EXAMPLE 14	<code>connect_to_server()</code> Function	103
EXAMPLE 15	<code>client_establish_context()</code> – Translate Service Name	104
EXAMPLE 16	Loop for Establishing Contexts	106
EXAMPLE 17	<code>gss-client: call_server()</code> Establish Context	108
EXAMPLE 18	<code>gss-client</code> Example: <code>call_server()</code> – Wrap Message	109
EXAMPLE 19	<code>gss-client</code> Example – Read and Verify Signature Block	112
EXAMPLE 20	<code>gss-client</code> Example: <code>call_server()</code> – Delete Context	113
EXAMPLE 21	<code>gss-server</code> Example: <code>main()</code>	117
EXAMPLE 22	Sample Code for <code>server_acquire_creds()</code> Function	120
EXAMPLE 23	<code>sign_server()</code> Function	123
EXAMPLE 24	<code>server_establish_context()</code> Function	125
EXAMPLE 25	<code>test_import_export_context()</code> Example	130
EXAMPLE 26	Creating a Message Digest by Using PKCS #11 Functions	176
EXAMPLE 27	Creating an Encryption Key Object by Using PKCS #11 Functions	180
EXAMPLE 28	Signing and Verifying Text by Using PKCS #11 Functions	184

EXAMPLE 29	Generating Random Numbers Using PKCS #11 Functions	192
EXAMPLE 30	Complete Listing of <code>gss-client.c</code> Sample Program	211
EXAMPLE 31	Complete Code Listing for <code>gss-server.c</code> Sample Program	223
EXAMPLE 32	Code Listings for Miscellaneous GSS-API Functions	235
EXAMPLE 33	Displaying Status Codes with <code>gss_display_status()</code>	248
EXAMPLE 34	The <code>/etc/gss/mech</code> File	264
EXAMPLE 35	The <code>/etc/gss/qop</code> File	264
EXAMPLE 36	<code>createMechOid()</code> Function	267
EXAMPLE 37	<code>parse_oid()</code> Function	267

Using This Documentation

- **Overview** – This guide describes the public application programming interfaces (API) and service provider interfaces (SPI) for the security features in the Oracle Solaris operating environment. The term *service provider* refers to components that are plugged into a framework to provide security services, such as cryptographic algorithms and security protocols.
- **Audience** –
This guide is intended for C-language developers who write the following types of programs:
 - Privileged applications that can override system controls
 - Applications that use authentication and related security services
 - Applications that need to secure network communications
 - Applications that use cryptographic services
 - Libraries, shared objects, and plugins that provide or consume security services

Note - For Java-language equivalents to the Oracle Solaris features, see <https://www.oracle.com/technetwork/java/javase/tech/index-jsp-136007.html>.

- **Required knowledge** – Readers of this guide should be familiar with C programming. A basic knowledge of security mechanisms is helpful but not required. You do not need to have specialized knowledge about network programming to use this book.

Product Documentation Library

Documentation and resources for this product and related products are available at <http://www.oracle.com/pls/topic/lookup?ctx=E53394-01>.

Feedback

Provide feedback about this documentation at <http://www.oracle.com/goto/docfeedback>.

Oracle Solaris Security for Developers (Overview)

This guide documents the public application programming interfaces (APIs) and service provider interfaces (SPIs) for the security features in the Oracle Solaris Operating System (Oracle Solaris OS).

This chapter covers the following areas:

- [“Overview of Oracle Solaris Security Features for Developers” on page 19](#)
- [“System Security” on page 19](#)
- [“Network Security Architecture” on page 23](#)

Overview of Oracle Solaris Security Features for Developers

This guide covers the public APIs and public SPIs to security features in the Oracle Solaris operating system. For information about how these security features operate from the system administrator's viewpoint, review the guides on the *Securing the Oracle Solaris Operating System* shelf in the [Oracle Solaris 11.3 Information Library](#).

The Oracle Solaris OS provides a network security architecture that is based on standard industry interfaces. Through the use of standardized interfaces, applications that consume or provide cryptographic services should need no modification as security technologies evolve.

System Security

For system security, the Oracle Solaris OS provides many features, including features that developers can use.

For highly stringent system security, the Oracle Solaris OS provides the Trusted Extensions feature, which is outside of the scope of this book. The Trusted Extensions feature enables system administrators to specify the applications and files that a particular user can access. See the [Trusted Extensions Developer's Guide](#) and the [Trusted Extensions User's Guide](#) for more information.

Oracle Solaris provides the following public interfaces for security:

- **Process privileges** – Privileges provide an alternative to the standard, superuser-based UNIX model for granting access to privileged applications. The system administrator assigns users a set of process privileges that permit access to privileged applications. A user does not need to become superuser to use a privileged application.

Privileges enable system administrators to delegate limited permission to users to override system security instead of giving users complete root access. Accordingly, developers who create new privileged applications should test for specific privileges instead of checking for UID = 0. See [Chapter 2, “Developing Privileged Applications”](#).

- **Cryptographic Framework** – The Cryptographic Framework is the backbone of cryptographic services in Oracle Solaris. The framework provides standard Extended PKCS#11, v2.20 Amendment 3 Library, henceforth referred to as PKCS #11, which contains interfaces to accommodate consumers and providers of cryptographic services. The framework has two parts: the user Cryptographic Framework for user-level applications and the kernel Cryptographic Framework for kernel-level modules. Consumers that are connected to the framework need no special knowledge of the installed cryptographic mechanisms. Providers plug into the framework with no special code necessary for the different types of consumers.

The consumers of the Cryptographic Framework include security protocols, certain mechanisms, and applications that need to perform cryptography. The providers to the framework are cryptographic mechanisms as well as other mechanisms in hardware and software plugins. See [Chapter 8, “Introduction to the Oracle Solaris Cryptographic Framework”](#) for an overview of the Cryptographic Framework. See [Chapter 9, “Writing User-Level Cryptographic Applications”](#) to learn how to write user-level applications that consume services from the framework.

The library for the Cryptographic Framework is an implementation of the PKCS #11 specification. Both consumers and providers communicate with the user-level cryptographic framework through standard PKCS #11 calls.

- **Key management framework** – The key management framework helps the developers and system administrators to choose among several different keystore systems when designing systems that employ PKI technologies. For more information, see [Chapter 10, “Introduction to the Oracle Solaris Key Management Framework”](#).
- **Java API** – Java security technology includes a large set of APIs, tools, and implementations of commonly used security algorithms, mechanisms, and protocols. The Java security APIs span a wide range of areas, including cryptography, public key infrastructure, secure communication, authentication, and access control. Java security

technology provides the developer with a comprehensive security framework for writing applications, and also provides the user or administrator with a set of tools to securely manage applications. See <https://www.oracle.com/technetwork/java/javase/tech/index-jsp-136007.html>.

Security Extensions Framework

Security extensions in Oracle Solaris provide system-level and process-level security. These extensions reduce the chances of attackers finding known entry points, or planting exploitation code for later execution.

The following security extensions are available in Oracle Solaris:

- `aslr` – Address Space Layout Randomization (`aslr`) randomizes the starting address of key portions of the process address space such as stack, libraries, and brk-based heap. By default, binaries are explicitly tagged with the `aslr` extension which helps in requesting `aslr` extension.
- `nxheap` – Non-Executable Heap (`nxheap`) prevents pages allocated for the process heap from being executable. By default, this extension is enabled.
- `nxstack` – Non-Executable Stack (`nxstack`) prevents pages allocated for the process stack from being executable. Backward compatibility with legacy `/etc/system` `noexec_user_stack` and `noexec_user_stack_log` settings is maintained, although such controls are deprecated and `sxadm` should be used instead. By default, this extension is enabled.

Using the `sxadm` Command to Manage Security Extensions

You can use the `sxadm status` command to view the status of a security extension. For example:

```
$ sxadm status
EXTENSION      STATUS              CONFIGURATION
aslr           enabled (tagged-files)  default (default)
nxstack       enabled (all)         default (default)
nxheap        enabled (tagged-files)  default (default)
```

You can enable or disable the security extensions at the system level by using the `sxadm` utility, for example:

```
$ sxadm exec -s aslr=disable
```

Binaries that are explicitly tagged to disable the security extension take precedence over the system default behavior established by `sxadm` utility:

```
$ sxadm exec -s aslr=enable /usr/bin/bash
```

EXAMPLE 1 Enabling ASLR in a Program

The following example demonstrates the use of the `-z sx` option to create an executable with ASLR enabled. The following examples are also applicable to other security extensions.

```
$ cat hello.c
#include <stdio.h>
int
main(int argc, char **argv)
{
    (void) printf("Hello World!\n");
    return (0);
}
$ cc hello.c -z sx=aslr
```

To enable the security extensions at build time, use the `ld` command.

```
ld -z sx=extension={enable | disable}
```

EXAMPLE 2 Managing Security Extensions in Objects With `elfdump` and `elfedit`

ASLR tagging is provided by an entry in the object's dynamic section, which can be inspected with `elfdump(1)`.

```
$ elfdump -d a.out | grep ASLR
[28] SUNW_SX_AS LR 0x2 ENABLE
```

The `elfedit(1)` command can be used to add or modify the ASLR dynamic entry in an existing object.

```
$ cc hello.c
$ elfedit -e 'dyn:sunw_sx aslr enable' a.out
$ elfdump -d a.out | grep ASLR
[29] SUNW_SX_AS LR 0x2 ENABLE

$ elfedit -e 'dyn:sunw_sx aslr disable' a.out
$ elfdump -d a.out | grep ASLR
[29] SUNW_SX_AS LR 0x1 DISABLE
```

The ASLR requirements for a given process are established at process startup, and cannot be modified once the process has started. For this reason, the ASLR tagging is only meaningful for the primary executable object in the process.

The `pmap` utility can be used to examine the address mappings for a process. When used to observe the mappings for an executable which has ASLR enabled, the specific addresses used for the stack, library mappings, and the brk-based heap will differ for every invocation.

For more information, refer to:

- [ld\(1\)](#)
- [pmap\(1\)](#)
- [sxadm\(1M\)](#)
- “Using Application Data Integrity (ADI)” in *Oracle Solaris 11.3 Programming Interfaces Guide*
- “Protecting Against Malware With Security Extensions” in *Securing Systems and Attached Devices in Oracle Solaris 11.3*

Debugging When Using Security Extensions

Security extensions can be problematic during debugging. You can temporarily disable the security extension in one of the following ways:

- Temporarily disable a security extension system wide
- Use the `ld` or `elfedit` commands to tag the associated binary to disable the security extension
- Disable the security extension in a shell in which you want to carry out debugging

```
$ sxadm exec -i -s extension=disable /usr/bin/bash
```

`-i` passes the extension setting to the inheriting child process.

Network Security Architecture

The network security architecture works with standard industry interfaces, such as PAM, GSS-API, SASL, and the OASIS PKCS #11 open standard. Through the use of standardized protocols and interfaces, developers can write both consumers and providers that need no modification as security technologies evolve.

An application, library, or kernel module that uses security services is called a *consumer*. An application that provides security services to consumers is referred to as a *provider* and also as a *plugin*. The software that implements a cryptographic operation is called a *mechanism*.

A mechanism is not just an algorithm but includes the manner in which the algorithm is to be applied. For example, one mechanism might apply the AES algorithm to authentication. A different mechanism might apply an algorithm with block-by-block encryption.

The network security architecture eliminates the need for developers of consumers to write, maintain, and optimize cryptographic algorithms. Optimized cryptographic mechanisms are provided as part of the architecture.

The Oracle Solaris OS provides the following public interfaces for security:

- **PAM** – Pluggable authentication modules. PAM modules are mainly used for the initial authentication of a user to a system. The user can enter the system by GUI, command line, or some other means. In addition to authentication services, PAM provides services for managing accounts, sessions, and passwords. Applications such as `login` and `ftp` are typical consumers of PAM services. The PAM SPI is supplied services by security providers such as Kerberos v5. See [Chapter 3, “Writing PAM Applications and Services”](#).
- **GSS-API** – Generic security service application program interface. The GSS-API provides secure communication between peer applications. The GSS-API provides authentication, integrity, and confidentiality protection services as well. The Oracle Solaris implementation of the GSS-API works with Kerberos v5, SPNEGO, and Diffie-Hellman encryption. The GSS-API is primarily used to design or implement secure application protocols. GSS-API can provide services to other kinds of protocols, such as SASL. Through SASL, GSS-API provides services to LDAP.

GSS-API is typically used by two peer applications that are communicating over a network after the initial establishment of credentials has occurred. GSS-API is used by `login` applications, NFS, and `ftp`, among other applications.

See [Chapter 4, “Writing Applications That Use GSS-API”](#) for an introduction to GSS-API. [Chapter 5, “GSS-API Client Example”](#) and [Chapter 6, “GSS-API Server Example”](#) provides the source code descriptions of two typical GSS-API applications. [Appendix B, “Sample C-Based GSS-API Programs”](#) presents the code listings for the GSS-API examples. [Appendix C, “GSS-API Reference”](#) provides reference material for GSS-API. [Appendix D, “Specifying an OID”](#) demonstrates how to specify a mechanism other than the default mechanism.

- **SASL** – Simple authentication and security layer. SASL is used largely by protocols, for authentication, privacy, and data integrity. SASL is intended for higher-level network-based applications that use dynamic negotiation of security mechanisms to protect sessions. LDAP is one of the better-known consumers of SASL. SASL is similar to GSS-API. SASL is on a somewhat higher level than GSS-API. SASL consumes GSS-API services. See [Chapter 7, “Writing Applications That Use SASL”](#).

Developing Privileged Applications

This chapter describes how to develop privileged applications.

The chapter covers the following topics:

- [“Privileged Applications” on page 25](#)
- [“About Privileges” on page 26](#)
- [“Programming with Privileges” on page 30](#)
- [“About Authorizations” on page 37](#)

Privileged Applications

A *privileged application* is an application that can override system controls and check for specific user IDs (UIDs), group IDs (GIDs), authorizations, or privileges. These access control elements are assigned by system administrators. For a general discussion of how administrators use these access control elements, see [“Assigning Rights to Users” in *Securing Users and Processes in Oracle Solaris 11.3*](#).

The Oracle Solaris operating system provides developers with two elements that enable a finer-grained delegation of privileges:

- **Privileges** – A *privilege* is a discrete right that can be granted to an application. With a privilege, a process can perform an operation that would otherwise be prohibited by the Oracle Solaris OS. For example, processes cannot normally open data files without the proper file permission. The `file_dac_read` privilege provides a process with the ability to override the UNIX file permissions for reading a file. Privileges are enforced at the kernel level.
- **Authorizations** – An *authorization* is a permission for performing a class of actions that are otherwise prohibited by security policy. An authorization can be assigned to a role or user. Authorizations are enforced at the user level.

The difference between authorizations and privileges has to do with the level at which the policy of who can do what is enforced. Privileges are enforced at the kernel level. Without

the proper privilege, a process cannot perform specific operations in a privileged application. Authorizations enforce policy at the user application level. An authorization might be required for access to a privileged application or for specific operations within a privileged application.

About Privileges

A privilege is a discrete right that is granted to a process to perform an operation that would otherwise be prohibited by the Oracle Solaris operating system. Most programs do not use privileges, because a program typically operates within the bounds of the system security policy.

Privileges are assigned by an administrator. Privileges are enabled according to the design of the program. At login or when a profile shell is entered, the administrator's privilege assignments apply to any commands that are executed in the shell. When an application is run, privileges are turned on or turned off programmatically. If a new program is started by using the `exec(1)` command, that program can potentially use all of the parent process's inheritable privileges. However, that program cannot add any new privileges.

How Administrators Assign Privileges

System administrators are responsible for assigning privileges to commands. For more information about privilege assignment, see [“More About Privileges” in *Securing Users and Processes in Oracle Solaris 11.3*](#).

How Privileges Are Implemented

Every process has four sets of privileges that determine whether a process can use a particular privilege:

- Permitted privilege set
- Inheritable privilege set
- Limit privilege set
- Effective privilege set

Permitted Privilege Set

All privileges that a process can ever potentially use must be included in the permitted set. Conversely, any privilege that is never to be used should be excluded from the permitted set for that program.

When a process is started, that process inherits the permitted privilege set from the parent process. Typically at login or from a new profile shell, all privileges are included in the initial set of permitted privileges. The privileges in this set are specified by the administrator. Each child process can remove privileges from the permitted set, but the child cannot add other privileges to the permitted set. As a security precaution, you should remove those privileges from the permitted set that the program never uses. In this way, a program can be protected from using an incorrectly assigned or inherited privilege.

Privileges that are removed from the permitted set are automatically removed from the effective set.

Inheritable Privilege Set

At login or from a new profile shell, the inheritable set contains the privileges that have been specified by the administrator. These inheritable privileges can potentially be passed on to child processes after an `exec(1)` call. A process should remove any unnecessary privileges to prevent these privileges from passing on to a child process. Often the permitted and inheritable sets are the same. However, there can be cases where a privilege is taken out of the inheritable set, but that privilege remains in the permitted set.

Limit Privilege Set

The limit set enables a developer to control which privileges a process can exercise or pass on to child processes. A child process and the descendant processes can only obtain privileges that are in the limit set. When a `setuid(0)` function is executed, the limit set determines the privileges that the application is permitted to use. The limit set is enforced at `exec(1)` time. Removal of privileges from the limit set does not affect any other sets until the `exec(1)` is performed.

Effective Privilege Set

The privileges that a process can actually use are in the process's effective set. At the start of a program, the effective set is equal to the permitted set. Afterwards, the effective set is either a subset of or is equal to the permitted set.

A good practice is to reduce the effective set to the set of basic privileges. The basic privilege set, which contains the core privileges, is described in [“Privilege Categories” on page 28](#). Remove completely any privileges that are not needed in the program. Toggle off any basic privileges until that privilege is needed. For example, the `file_dac_read` privilege, enables all files to be read. A program can have multiple routines for reading files. The program turns off all privileges initially and turns on `file_dac_read`, for appropriate reading routines. The developer thus ensures that the program cannot exercise the `file_dac_read` privilege for the wrong reading routines. This practice is called *privilege bracketing*. Privilege bracketing is demonstrated in [“Privilege Coding Example” on page 33](#).

Compatibility Between the Superuser and Privilege Models

To accommodate legacy applications, the implementation of privileges works with both the superuser and privilege models. This accommodation is achieved through use of the `PRIV_AWARE` flag, which indicates that a program works with privileges. A process inherits `PRIV_AWARE` on a `fork(2)` or `exec(2)` from its parent.

Consider a child process that is not aware of privileges. The `PRIV_AWARE` flag for that process would be false. Any privileges that have been inherited from the parent process are available in the permitted and effective sets. If the child sets a `UID` to 0, the process's effective and permitted sets are restricted to those privileges in the limit set. The child process does not gain full superuser powers. Thus, the limit set of a privilege-aware process restricts the superuser privileges of any non-privilege-aware child processes. If the child process modifies any privilege set, then the `PRIV_AWARE` flag is set to true.

Privilege Categories

Privileges are logically grouped on the basis of the scope of the privilege, as follows:

- **Basic privileges** – The basic privileges are privileges granted to processes that were not privileged in previous Oracle Solaris releases. By default, each process and each user is assigned all basic privileges; however they can be taken away to further restrict a process.

- `PRIV_FILE_LINK_ANY` – Allows a process to create hard links to files that are owned by a UID other than the process's effective UID.
- `PRIV_PROC_EXEC` – Allows a process to call `execve()`.
- `PRIV_PROC_FORK` – Allows a process to call `fork()`, `fork1()`, or `vfork()`.
- `PRIV_PROC_SESSION` – Allows a process to send signals or trace processes outside its session.
- `PRIV_PROC_INFO` – Allows a process to examine the status of processes outside of those processes to which the inquiring process can send signals. Without this privilege, processes that cannot be seen in `/proc` cannot be examined.
- `PRIV_FILE_READ` – Allows a process to read objects in the filesystem.
- `PRIV_FILE_WRITE` – Allows a process to modify objects in the filesystem.
- `PRIV_NET_ACCESS` – Allows a process to open a TCP, UDP, SDP, or SCTP network endpoint.

Initially, the basic privileges should be assigned as a set rather than individually for a program. This approach ensures that any basic privileges that are released in an update to the Oracle Solaris OS will be included in the assignment. However, when computing the needed privilege set for a program, it is important to remove basic privileges that are not needed and add other privileges that will be needed by the program. For example, the `proc_exec` privilege should be turned off if the program is not intended to `exec(1)` sub-processes.

- File system privileges.
- System V Interprocess Communication (IPC) privileges.
- Network privileges.
- Process privileges.
- System privileges.

See the [privileges\(5\)](#) man page for a complete list of the Oracle Solaris privileges with descriptions.

Note - Oracle Solaris provides the zones facility, which lets an administrator set up isolated environments for running applications. See [zones\(5\)](#) for more information. Since a process in a zone is prevented from monitoring or interfering with other activity in the system outside of that zone, any privileges on that process are limited to the zone as well. However, if needed, the `PRIV_PROC_ZONE` privilege can be applied to processes in the global zone that need privileges to operate in non-global zones.

Programming with Privileges

This section discusses the interfaces for working with privileges. To use the privilege programming interfaces, you need the following header file.

```
#include <priv.h>
```

An example demonstrating how privilege interfaces are used in a privileged application is also provided.

Privilege Data Types

The major data types that are used by the privilege interfaces are:

- Privilege type – An individual privilege is represented by the `priv_t` type definition. You initialize a variable of type `priv_t` with a privilege ID string, as follows:

```
priv_t priv_id = PRIV_FILE_DAC_WRITE;
```
- Privilege set type – Privilege sets are represented by the `priv_set_t` data structure. Use one of the privilege manipulation functions shown in [Table 1, “Interfaces for Using Privileges,” on page 31](#) to initialize variables of type `priv_set_t`.
- Privilege operation type – The type of operation to be performed on a file or process privilege set is represented by the `priv_op_t` type definition. Not all operations are valid for every type of privilege set. Read the privilege set descriptions in [“Programming with Privileges” on page 30](#) for details.

Privilege operations can have the following values:

- `PRIV_ON` – Turn the privileges that have been asserted in the `priv_set_t` structure on in the specified file or process privilege set.
- `PRIV_OFF` – Turn the privileges asserted in the `priv_set_t` structure off in the specified file or process privilege set.
- `PRIV_SET` – Set the privileges in the specified file or process privilege set to the privileges asserted in the `priv_set_t` structure. If the structure is initialized to empty, `PRIV_SET` sets the privilege set to none.

Privilege Interfaces

The following table lists the interfaces for using privileges. Descriptions of some major privilege interfaces are provided after the table.

TABLE 1 Interfaces for Using Privileges

Purpose	Functions	Additional Comments
Getting and setting privilege sets	<code>setppriv(2)</code> , <code>getppriv(2)</code> , <code>priv_ineffect(3C)</code> , <code>priv_set(3C)</code>	<code>setppriv()</code> and <code>getppriv()</code> are system calls. <code>priv_ineffect()</code> and <code>priv_set()</code> are wrappers for convenience.
Identifying and translating privileges	<code>priv_str_to_set(3C)</code> , <code>priv_set_to_str(3C)</code> , <code>priv_getbyname(3C)</code> , <code>priv_getbynum(3C)</code> , <code>priv_getsetbyname(3C)</code> , <code>priv_getsetbynum(3C)</code>	These functions map the specified privilege or privilege set to a name or a number.
Manipulating privilege sets	<code>priv_allocset(3C)</code> , <code>priv_freerset(3C)</code> , <code>priv_emptyset(3C)</code> , <code>priv_fillset(3C)</code> , <code>priv_isemptyset(3C)</code> , <code>priv_isfullset(3C)</code> , <code>priv_isequalset(3C)</code> , <code>priv_issubset(3C)</code> , <code>priv_intersect(3C)</code> , <code>priv_union(3C)</code> , <code>priv_inverse(3C)</code> , <code>priv_addset(3C)</code> , <code>priv_copyset(3C)</code> , <code>priv_delset(3C)</code> , <code>priv_ismember(3C)</code> , <code>priv_basicset(3C)</code>	These functions are concerned with privilege memory allocation, testing, and various set operations.
Getting and setting process flags	<code>getpflags(2)</code> , <code>setpflags(2)</code>	The <code>PRIV_AWARE</code> process flag indicates whether the process understands privileges or runs under the superuser model. <code>PRIV_DEBUG</code> is used for privilege debugging.
Low-level credential manipulation	<code>ucred_get(3C)</code>	These routines are used for debugging, low-level system calls, and kernel calls.

setppriv() for Setting Privileges

The main function for setting privileges is `setppriv()`, which has the following syntax:

```
int setppriv(priv_op_t op, priv_ptype_t which, \
const priv_set_t *set);
```

op represents the privilege operation that is to be performed. The *op* parameter has one of three possible values:

- PRIV_ON – Adds the privileges that are specified by the *set* variable to the set type that is specified by *which*
- PRIV_OFF – Removes the privileges that are specified by the *set* variable from the set type that is specified by *which*
- PRIV_SET – Uses the privileges that are specified by the *set* variable to replace privileges in the set type that is specified by *which*

which specifies the type of privilege set to be changed, as follows:

- PRIV_PERMITTED
- PRIV_EFFECTIVE
- PRIV_INHERITABLE
- PRIV_LIMIT

set specifies the privileges to be used in the change operation.

In addition, a convenience function is provided: `priv_set()`.

priv_str_to_set() for Mapping Privileges

These functions are convenient for mapping privilege names with their numeric values. `priv_str_to_set()` is a typical function in this family. `priv_str_to_set()` has the following syntax:

```
priv_set_t *priv_str_to_set(const char *buf, const char *set, \
const char **endptr);
```

`priv_str_to_set()` takes a string of privilege names that are specified in *buf*.

`priv_str_to_set()` returns a set of privilege values that can be combined with one of the four privilege sets. ***endptr* can be used to debug parsing errors.

Note that the following keywords can be included in *buf*:

- "all" indicates all defined privileges. "all, !*priv_name*, ..." enables you to specify all privileges except the indicated privileges.

Note - Constructions that use "*priv_set*, "*!priv_name*, . . ." subtract the specified privilege from the specified set of privileges. Do not use "*!priv_name*, . . ." without first specifying a set because with no privilege set to subtract from, the construction subtracts the specified privileges from an empty set of privileges and effectively indicates no privileges.

- "none" indicates no privileges.
- "basic" indicates the set of privileges that are required to perform operations that are traditionally granted to all users on login to a standard UNIX operating system.

Privilege Coding Example

This section compares how privileges are bracketed using the superuser model and the least privilege model.

Privilege Bracketing in the Superuser Model

The following example demonstrates how privileged operations are bracketed in the superuser model.

EXAMPLE 3 Superuser Privilege Bracketing Example

```
/* Program start */
uid = getuid();
seteuid(uid);

/* Privilege bracketing */
seteuid(0);
/* Code requiring superuser capability */
...
/* End of code requiring superuser capability */
seteuid(uid);
...
/* Give up superuser ability permanently */
setreuid(uid,uid);
```

Privilege Bracketing in the Least Privilege Model

This example demonstrates how privileged operations are bracketed in the least privilege model. The example uses the following assumptions:

- The program is `setuid 0`.
- The permitted and effective sets are initially set to all privileges as a result of `setuid 0`.
- The inheritable set is initially set to the basic privileges.
- The limit set is initially set to all privileges.

An explanation of the example follows the code listing.

EXAMPLE 4 Least Privilege Bracketing Example

```
1 #include <priv.h>
2 /* Always use the basic set. The basic set might grow in future
3  * releases and potentially restrict actions that are currently
4  * unrestricted */
5 priv_set_t *temp = priv_str_to_set("basic", ",", NULL);

6 /* PRIV_FILE_DAC_READ is needed in this example */
7 (void) priv_addset(temp, PRIV_FILE_DAC_READ);

8 /* PRIV_PROC_EXEC is no longer needed after program starts */
9 (void) priv_delset(temp, PRIV_PROC_EXEC);

10 /* Compute the set of privileges that are never needed */
11 priv_inverse(temp);

12 /* Remove the set of unneeded privs from Permitted (and by
13  * implication from Effective) */
14 (void) setppriv(PRIV_OFF, PRIV_PERMITTED, temp);

15 /* Remove unneeded priv set from Limit to be safe */
16 (void) setppriv(PRIV_OFF, PRIV_LIMIT, temp);

17 /* Done with temp */
18 priv_freeset(temp);

19 /* Now get rid of the euid that brought us extra privs */
20 (void) seteuid(getuid());

21 /* Toggle PRIV_FILE_DAC_READ off while it is unneeded */
22 priv_set(PRIV_OFF, PRIV_EFFECTIVE, PRIV_FILE_DAC_READ, NULL);

23 /* Toggle PRIV_FILE_DAC_READ on when special privilege is needed*/
```

```

24  priv_set(PRIV_ON, PRIV_EFFECTIVE, PRIV_FILE_DAC_READ, NULL);

25  fd = open("/some/restricted/file", O_RDONLY);

26  /* Toggle PRIV_FILE_DAC_READ off after it has been used */
27  priv_set(PRIV_OFF, PRIV_EFFECTIVE, PRIV_FILE_DAC_READ, NULL);

28  /* Remove PRIV_FILE_DAC_READ when it is no longer needed */
29  priv_set(PRIV_OFF, PRIV_ALLSETS, PRIV_FILE_DAC_READ, NULL);

```

The program defines a variable that is named *temp*. The *temp* variable determines the set of privileges that are not needed by this program. Initially in line 5, *temp* is defined to contain the set of basic privileges. In line 7, the `file_dac_read` privilege is added to *temp*. The `proc_exec` privilege is necessary to `exec(1)` new processes, which is not permitted in this program. Therefore, `proc_exec` is removed from *temp* in line 9 so that the `exec(1)` command cannot execute new processes.

At this point, *temp* contains only those privileges that are needed by the program, that is, the basic set plus `file_dac_read` minus `proc_exec`. In line 11, the `priv_inverse()` function computes the inverse of *temp* and resets the value of *temp* to the inverse. The inverse is the result of subtracting the specified set, *temp* in this case, from the set of all possible privileges. As a result of line 11, *temp* now contains those privileges that are never needed by the program. In line 14, the unneeded privileges that are defined by *temp* are subtracted from the permitted set. This removal effectively removes the privileges from the effective set as well. In line 16, the unneeded privileges are removed from the limit set. In line 18, the *temp* variable is freed, since *temp* is no longer needed.

This program is aware of privileges. Accordingly, the program does not use `setuid` and can reset the effective UID to the user's real UID in line 20.

The `file_dac_read` privilege is turned off in line 22 through removal from the effective set. In a real program, other activities would take place before `file_dac_read` is needed. In this sample program, `file_dac_read` is needed for to read a file in line 25. Accordingly, `file_dac_read` is turned on in line 24. Immediately after the file is read, `file_dac_read` is again removed from the effective set. When all files have been read, `file_dac_read` is removed for good by turning off `file_dac_read` in all privilege sets.

The following table shows the transition of the privilege sets as the program progresses. The line numbers are indicated.

TABLE 2 Privilege Set Transition

Step	<i>temp</i> Set	Permitted Privilege Set	Effective Privilege Set	Limit Privilege Set
Initially	–	all	all	all

Step	<i>temp</i> Set	Permitted Privilege Set	Effective Privilege Set	Limit Privilege Set
Line 5 – <i>temp</i> is set to basic privileges	basic	all	all	all
Line 7 – <code>file_dac_read</code> is added to <i>temp</i> .	basic + <code>file_dac_read</code>	all	all	all
Line 9 – <code>proc_exec</code> is removed from <i>temp</i> .	basic + <code>file_dac_read</code> – <code>proc_exec</code>	all	all	all
Line 11 – <i>temp</i> is reset to the inverse.	all – (basic + <code>file_dac_read</code> – <code>proc_exec</code>)	all	all	all
Line 14 – The unneeded privileges are turned off in the permitted set.	all – (basic + <code>file_dac_read</code> – <code>proc_exec</code>)	basic + <code>file_dac_read</code> – <code>proc_exec</code>	basic + <code>file_dac_read</code> – <code>proc_exec</code>	all
Line 16 – The unneeded privileges are turned off in the limit set.	all – (basic + <code>file_dac_read</code> – <code>proc_exec</code>)	basic + <code>file_dac_read</code> – <code>proc_exec</code>	basic + <code>file_dac_read</code> – <code>proc_exec</code>	basic + <code>file_dac_read</code> – <code>proc_exec</code>
Line 18 – The <i>temp</i> file is freed.	–	basic + <code>file_dac_read</code> – <code>proc_exec</code>	basic + <code>file_dac_read</code> – <code>proc_exec</code>	basic + <code>file_dac_read</code> – <code>proc_exec</code>
Line 22 – Turn off <code>file_dac_read</code> until needed.	–	basic – <code>proc_exec</code>	basic – <code>proc_exec</code>	basic + <code>file_dac_read</code> – <code>proc_exec</code>
Line 24 – Turn on <code>file_dac_read</code> when needed.	–	basic + <code>file_dac_read</code> – <code>proc_exec</code>	basic + <code>file_dac_read</code> – <code>proc_exec</code>	basic + <code>file_dac_read</code> – <code>proc_exec</code>
Line 27 – Turn off <code>file_dac_read</code> after <code>read()</code> operation.	–	basic – <code>proc_exec</code>	basic – <code>proc_exec</code>	basic + <code>file_dac_read</code> – <code>proc_exec</code>
Line 29 – Remove <code>file_dac_read</code> from all sets when no longer needed.	–	basic – <code>proc_exec</code>	basic – <code>proc_exec</code>	basic – <code>proc_exec</code>

Guidelines for Developing Privileged Applications

This section provides the following suggestions for developing privileged applications:

- **Use an isolated system.** You should never debug privileged applications on a production system, as an incomplete privileged application can compromise security.
- **Set IDs properly.** The calling process needs the `proc_setid` privilege in its effective set to change its user ID, group ID, or supplemental group ID.

- **Use privilege bracketing.** When an application uses privilege, system security policy is being overridden. Privileged tasks should be bracketed and carefully controlled to ensure that sensitive information is not compromised. See “[Privilege Coding Example](#)” on page 33 for information about how to bracket privileges.
- **Start with the basic privileges.** The basic privileges are necessary for minimal operation. A privileged application should start with the basic set. The application should then subtract and add privileges appropriately.
A typical start-up scenario follows.
 1. The daemon starts up as root.
 2. The daemon turns on the basic privilege set.
 3. The daemon turns off any basic privileges that are unnecessary, for example, `PRIV_FILE_LINK_ANY`.
 4. The daemon adds any other privileges that are needed, for example, `PRIV_FILE_DAC_READ`.
 5. The daemon switches to the daemon UID.
- **Avoid shell escapes.** The new process in a shell escape can use any of the privileges in the parent process's inheritable set. An end user can therefore potentially violate trust through a shell escape. For example, some mail applications might interpret the `!` command line as a command and would execute that line. An end user could thus create a script to take advantage of any mail application privileges. The removal of unnecessary shell escapes is a good practice.

About Authorizations

Authorizations are stored in the `/etc/security/auth_attr` file. To create an application that uses authorizations, take the following steps:

1. Scan the entries in the `auth_attr` database using the `getent` command as follows :

```
$ getent auth_attr | sort | more
```

The `getent` command retrieves a list of authorizations in the `auth_attr` database and sorts similar named authorizations together. The authorizations are retrieved in the order in which they were configured. See the [getent\(1M\)](#) man page for information on using the `getent` command.

2. Check for the required authorization at the beginning of the program using the [chkauthattr\(3C\)](#) function.

The `chkauthattr()` function searches for the authorization in order in the following locations:

- `AUTHS_GRANTED` key in the `policy.conf(4)` database – `AUTHS_GRANTED` indicates authorizations that have been assigned by default.
- `PROFS_GRANTED` key in the `policy.conf(4)` database – `PROFS_GRANTED` indicates rights profiles that have been assigned by default. `chkauthattr()` checks these rights profiles for the specified authorization.
- The `user_attr(4)` database – This database stores security attributes that have been assigned to users.
- The `prof_attr(4)` database – This database stores rights profiles that have been assigned to users.

If `chkauthattr()` cannot find the right authorization in any of these places, then the user is denied access to the program. If the Stop profile is encountered by the `chkauthattr()` function, further authorizations and profiles including `AUTHS_GRANTED`, `PROFS_GRANTED`, and those found in the `/etc/security/policy.conf` are ignored. Hence the Stop profile can be used to override profiles that are listed using the `PROFS_GRANTED` and `AUTHS_GRANTED` key in the `/etc/security/policy.conf` file.

See [Chapter 3, “Assigning Rights in Oracle Solaris” in *Securing Users and Processes in Oracle Solaris 11.3*](#) for information about how to use the provided security attributes, add new ones, and assign them to users and processes.

Note - Users can add entries to the `auth_attr()`, `exec_attr()`, and `prof_attr()` databases. However Oracle Solaris authorizations are not stored in these databases.

EXAMPLE 5 Checking for Authorizations

The following code snippet demonstrates how the `chkauthattr()` function can be used to check a user's authorization. In this case, the program checks for the `solaris.job.admin` authorization. If the user has this authorization, the user is able to read or write to other users' files. Without the authorization, the user can operate on owned files only.

```
/* Define override privileges */
priv_set_t *override_privs = priv_allocset();

/* Clear privilege set before adding privileges. */
priv_set( PRIV_OFF, PRIV_EFFECTIVE, PRIV_FILE_DAC_READ,
          priv_FILE_DAC_WRITE, NULL);
```

```
priv_addset(override_privs, PRIV_FILE_DAC_READ);
priv_addset(override_privs, PRIV_FILE_DAC_WRITE);

if (!chkauthattr("solaris.jobs.admin", username)) {
    /* turn off privileges */
    setppriv(PRIV_OFF, PRIV_EFFECTIVE, override_privs);
}
/* Authorized users continue to run with privileges */
/* Other users can read or write to their own files only */
```

Writing PAM Applications and Services

Pluggable authentication modules (PAM) provide system entry applications with authentication and related security services. This chapter is intended for developers of system entry applications who wish to provide authentication, account management, session management, and password management through PAM modules. There is also information for designers of PAM service modules.

The following topics are discussed:

- [“Introduction to the PAM Framework” on page 41](#)
- [“PAM Configuration” on page 45](#)
- [“Writing Applications That Use PAM Services” on page 46](#)
- [“Writing Modules That Provide PAM Services” on page 56](#)

PAM was originally developed at Oracle. The PAM specification has since been submitted to X/Open, which is now the Open Group. The PAM specification is available in *X/Open Single Sign-On Service (XSSO) - Pluggable Authentication*, Open Group, UK ISBN 1-85912-144-6 June 1997. The Oracle Solaris implementation of PAM is described in the [pam\(3PAM\)](#), [libpam\(3LIB\)](#), and [pam_sm\(3PAM\)](#) man pages.

Introduction to the PAM Framework

The PAM framework consists of four parts:

- Applications that use PAM, also referred to as PAM consumers
- PAM framework, also referred to as the PAM library (see [libpam\(3LIB\)](#))
- PAM configuration, system-wide in `/etc/pam.d/` or `/etc/pam.conf` and on a per-user basis [pam_user_policy\(5\)](#)
- PAM service modules, also referred to as PAM service providers

The framework provides a uniform way for authentication-related activities to take place. This approach enables application developers to use PAM services without having to know

the semantics of the policy. Algorithms are centrally supplied. The algorithms can be modified independently of the individual applications. With PAM, administrators can tailor the authentication process to the needs of a particular system without having to change any applications. Administrators configure PAM through the per-service files in the `/etc/pam.d` directory. The `/etc/pam.conf` file contains legacy configuration.

The following figure illustrates the PAM architecture. Applications communicate with the PAM library through the PAM application programming interface (API). PAM modules communicate with the PAM library through the PAM service provider interface (SPI). Thus, the PAM library enables applications and modules to communicate with each other.

FIGURE 1 PAM Architecture

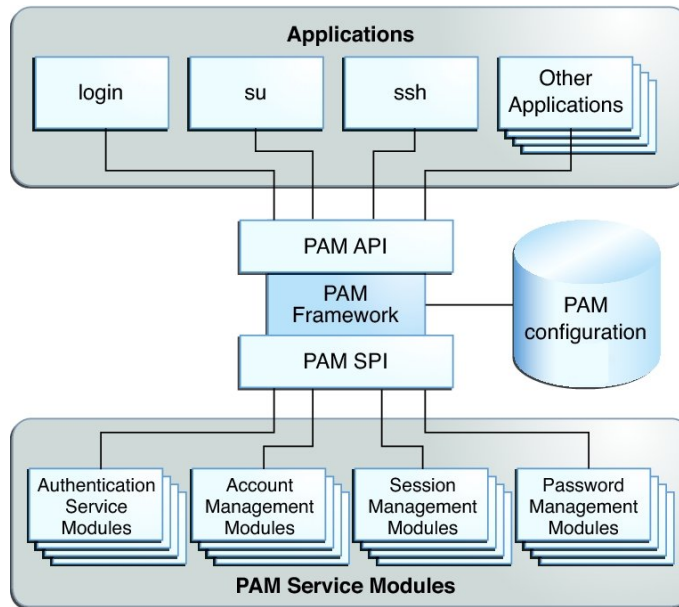

PAM Service Modules

A PAM service module is a shared library that provides authentication and other security services to system entry applications such as `login`, `su`, and `ssh`.

The four types of PAM services are:

- **Authentication service modules** (auth) – For granting users access to an account or service. Modules that provide this service authenticate users and set up user credentials.
- **Account management modules** (account) – For determining whether the current user's account is valid. Modules that provide this service can check password or account expiration and time-restricted access.
- **Session management modules** (session) – For setting up and terminating login sessions.
- **Password management modules** (password) – For enforcing password strength rules and performing authentication token updates.

A PAM module can implement one or more of these services. Because the use of simple modules with well-defined tasks increases configuration flexibility, PAM services should be implemented in separate modules. The services can then be 'stacked', that is, placed in the order of execution in the PAM configuration file. See [pam.conf\(4\)](#).

For example, the Oracle Solaris OS provides the [pam_authtok_check\(5\)](#) module for system administrators to configure the site's password policy. The [pam_authtok_check\(5\)](#) module checks proposed passwords for various strength criteria.

For a complete list of Oracle Solaris PAM modules, see *man pages section 5: Standards, Environments, and Macros*. The PAM modules have the prefix `pam_`.

PAM Library

The PAM library, [libpam\(3LIB\)](#), is the central element in the PAM architecture:

- `libpam` exports an API, [pam\(3PAM\)](#). Applications can call this API for authentication, account management, credential establishment, session management, and password changes.
- `libpam` looks for the PAM configuration in `/etc/pam.conf` before the per-service PAM policy files in `/etc/pam.d`. The PAM configuration specifies the PAM module requirements for each available service and is managed by a system administrator.
- `libpam` imports an SPI, [pam_sm\(3PAM\)](#), which is exported by the service modules.

PAM Authentication Process

As an example of how consumers use the PAM library for user authentication, consider how `login` authenticates a user:

1. The `login` application initiates a PAM session by calling `pam_start(3PAM)` and by specifying the `login` service.
2. The application calls `pam_authenticate(3PAM)`, which is part of the PAM API that is exported by the PAM library, `libpam(3LIB)`.
3. The PAM library searches for `login` entries in the PAM configuration corresponding to the service module type of authentication (`auth`).
4. For each module in PAM configuration that is configured for the `login` service, the PAM library calls `pam_sm_authenticate(3PAM)`. The `pam_sm_authenticate()` function is part of the PAM SPI. The control flag field in the PAM configuration files combined with the results of each call to `pam_sm_authenticate()` for the configured modules determines whether the user is allowed access to the system. This process is described in more detail in [“Configuring PAM” in *Managing Kerberos and Other Authentication Services in Oracle Solaris 11.3*](#).

In this way, the PAM library connects PAM applications with the PAM modules that have been configured by the system administrator.

Requirements for PAM Consumers

PAM consumers must be linked with the PAM library `libpam`. Before an application can use any service that is provided by the modules, the application must initialize its instance of the PAM library by calling `pam_start(3PAM)`. The call to `pam_start()` initializes a handle that must be passed to all subsequent PAM calls. When an application is finished with the PAM services, `pam_end()` is called to clean up any data that was used by the PAM library.

Communication between the PAM application and the PAM modules takes place through *items*. For example, the following items are useful for initialization:

- `PAM_AUSER` – Authenticated user name
- `PAM_USER` – Currently authenticated user
- `PAM_RUSER` – The untrusted remote user name
- `PAM_AUTHTOK` – Password
- `PAM_USER_PROMPT` – User name prompt
- `PAM_TTY` – Terminal through which the user communication takes place
- `PAM_RHOST` – Remote host through which user enters the system

- PAM_REPOSITORY – Any restrictions on the user account repository
- PAM_RESOURCE – Any controls on resources

For a complete list of available items, see [pam_set_item\(3PAM\)](#). Items can be set by the application through [pam_set_item\(3PAM\)](#). Values that have been set by the modules can be retrieved by the application through [pam_get_item\(3PAM\)](#). However, PAM_AUTHTOK and PAM_OLDAUTHTOK cannot be retrieved by the application. The PAM_SERVICE item cannot be set.

Note - PAM consumers must have unique PAM service names which are passed to [pam_start\(3PAM\)](#).

PAM Configuration

The PAM configuration, per-service policy files in `/etc/pam.d` or the `/etc/pam.conf` file, is used to configure PAM service modules for system services, such as `login`, `su`, and `cron`. The system administrator manages the PAM configuration. An incorrect order of entries in the per-service policy files in `/etc/pam.d` or `/etc/pam.conf` file can cause unforeseen side effects. For example, a badly configured per-service policy file in `/etc/pam.d` can lock out users so that single-user mode becomes necessary for repair.

PAM can also be configured via the per-service PAM policy files in the `/etc/pam.d` directory in addition to the `pam.conf` file.

The `/etc/pam.d` directory contains files named using the value of PAM_SERVICE. For example, `/etc/pam.d/ssh` is the file to read for the `ssh` service. The syntax of the `/etc/pam.d` files is identical to that of `/etc/pam.conf` except that the first column in the `/etc/pam.conf` file which is the service name, is omitted.

Configuring PAM with the `/etc/pam.d` files has following advantages:

- A mistake in a per-service PAM policy file only affects that service.
- Adding new PAM services is simple as it requires only creating a file in `/etc/pam.d`.
- Improved interoperability with cross-platform PAM applications since many other PAM implementations such as Linux-PAM and OpenPAM support `/etc/pam.d`.
- System administrators can also customize the security policy of their site by overlaying any vendor-supplied `/etc/pam.d` files.

For information about PAM configuration, see “[Configuring PAM](#)” in *Managing Kerberos and Other Authentication Services in Oracle Solaris 11.3*.

When configuring PAM, you need to consider the following aspects:

- The PAM configuration file syntax.
- The search order of the configured PAM services.
- The PAM stacking order.

For more information about PAM configuration files, see [“PAM Configuration Reference” in *Managing Kerberos and Other Authentication Services in Oracle Solaris 11.3*](#).

Writing Applications That Use PAM Services

Depending on the application PAM services can be compiled as either 32-bit or 64-bit binaries. Since PAM modules are loaded as shared objects via `dlopen`, they must be provided in both 32-bit and 64-bit versions in order to support use by either form of application. For more information, see the [`dlopen\(3C\)`](#) man page.

For more information about how to install both the 32-bit and 64-bit versions of the module so the PAM framework can load the appropriate version of the application, see [“How to Add a PAM Module” in *Managing Kerberos and Other Authentication Services in Oracle Solaris 11.3*](#).

A Simple PAM Consumer Example

The following PAM consumer application is provided as an example. The example is a basic terminal-lock application that validates a user trying to access a terminal.

The example goes through the following steps:

1. Initialize the PAM session.

PAM sessions are initiated by calling the [`pam_start\(3PAM\)`](#) function. A PAM consumer application must first establish a PAM session before calling any of the other PAM functions.

The `pam_start(3PAM)` function takes the following arguments:

- `plock` – Service name, that is, the name of the application. The service name is used by the PAM framework to determine which rules in the configuration file, `/etc/pam.conf` or, the `/etc/pam.d`, are applicable. The service name is generally used for logging and error-reporting.
- `pw->pw_name` – The username is the name of the user that the PAM framework acts on.
- `&conv` – The conversation function, `conv`, which provides a generic means for PAM to communicate with a user or application. Conversation functions are necessary

because the PAM modules have no way of knowing how communication is to be conducted. Communication can be by means of GUIs, the command line, a smart card reader, or other devices. For more information, see [“Writing Conversation Functions” on page 51](#).

- `&pamh` – The PAM handle, `pamh`, which is an opaque handle that is used by the PAM framework to store information about the current operation. This handle is returned by a successful call to `pam_start()`.

Note - An application that calls PAM interfaces must be sufficiently privileged to perform any needed operations such as authentication, password change, process credential manipulation, or audit state initialization. In this example, the application must be able to read `/etc/shadow` to verify the passwords for local users.

2. Authenticate the user.

The application calls `pam_authenticate(3PAM)` to authenticate the current user. Generally, the user is required to enter a password or other authentication token depending on the type of authentication service.

The PAM framework invokes the modules configured for the service name `plock` which corresponds to the service module type of authentication, `auth`, in `/etc/pam.conf`, or, in the case of Oracle Solaris 11.3, in `/etc/pam.d/plock`. If there are no `auth` entries for the `plock` service in either `/etc/pam.conf` or `/etc/pam.d/plock`, then `auth` entries for the other service are searched in `/etc/pam.conf` and finally in the `/etc/pam.d/other` file.

3. Check account validity.

The example uses the `pam_acct_mgmt(3PAM)` function to check the validity of the authenticated user's account. In this example, `pam_acct_mgmt()` checks for expiration of the password.

The `pam_acct_mgmt()` function also uses the `PAM_DISALLOW_NULL_AUTH Tok` flag. If `pam_acct_mgmt()` returns `PAM_NEW_AUTH Tok REQD`, then `pam_chauthtok(3PAM)` should be called to allow the authenticated user to change the password.

4. Force the user to change passwords if the system discovers that the password has expired.

The example uses a loop to call `pam_chauthtok()` until success is returned. The `pam_chauthtok()` function returns success if the user successfully changes his or her authentication information, which is usually the password. In this example, the loop continues until success is returned. More commonly, an application would set a maximum number of tries before terminating.

5. Call `pam_setcred(3PAM)`.

The `pam_setcred(3PAM)` function is used to establish, modify, or delete user credentials. `pam_setcred()` is typically called when a user has been authenticated. The call is made after the account has been validated, but before a session has been opened. The

`pam_setcred()` function is used with the `PAM_ESTABLISH_CRED` flag to establish a new user session. If the session is the renewal of an existing session, such as for `lockscreen`, `pam_setcred()` with the `PAM_REFRESH_CRED` flag should be called. If the session is changing the credentials, such as using `su` or assuming a role, then `pam_setcred()` with the `PAM_REINITIALIZE_CRED` flag should be called.

6. Close the PAM session.

The PAM session is closed by calling the `pam_end(3PAM)` function. `pam_end()` frees all PAM resources as well.

The following example shows the source code for the sample PAM consumer application.

EXAMPLE 6 Sample PAM Consumer Application

```
/*
 * Copyright (c) 2005, 2012, Oracle and/or its affiliates. All rights reserved.
 */

#include <sys/types.h>
#include <stdio.h>
#include <unistd.h>
#include <stdlib.h>
#include <strings.h>
#include <signal.h>
#include <pwd.h>
#include <errno.h>
#include <security/pam_appl.h>

extern int pam_tty_conv(int num_msg, struct pam_message **msg,
    struct pam_response **response, void *appdata_ptr);

/* Disable keyboard interrupts (Ctrl-C, Ctrl-Z, Ctrl-\) */
static void
disable_kbd_signals(void) {
    (void) signal(SIGINT, SIG_IGN);
    (void) signal(SIGSTP, SIG_IGN);
    (void) signal(SIGQUIT, SIG_IGN);
}

/* Terminate current user session, i.e., logout */
static void
logout() {
    pid_t pgroup = getppgrp();

    (void) signal(SIGTERM, SIG_IGN);
    (void) fprintf(stderr, "Sorry, your session can't be restored.\n");
}
```



```

        (void) fprintf(stderr, "Press return to terminate this session.\n");
        (void) getchar();
        (void) kill(-pgroup, SIGTERM);
        (void) sleep(2);
        (void) kill(-pgroup, SIGKILL);
        exit(-1);
    }

    int
    /*ARGSUSED*/
    main(int argc, char *argv) {
        struct pam_conv conv = {pam_tty_conv, NULL};
        pam_handle_t *pamh;
        struct passwd *pw;
        int err;

        disable_kbd_signals();
        if ((pw = getpwuid(getuid())) == NULL) {
            (void) fprintf(stderr, "plock: Can't get username: %s\n",
                strerror(errno));
            exit(1);
        }

        /* Initialize PAM framework */
        err = pam_start("plock", pw->pw_name, &conv, &pamh);
        if (err != PAM_SUCCESS) {
            (void) fprintf(stderr, "plock: pam_start failed: %s\n",
                pam_strerror(pamh, err));
            exit(1);
        }

        /* Authenticate user in order to unlock screen */
        do {
            (void) fprintf(stderr, "Terminal locked for %s. ", pw->pw_name);
            err = pam_authenticate(pamh, 0);
            if (err == PAM_USER_UNKNOWN) {
                logout();
            } else if (err != PAM_SUCCESS) {
                (void) fprintf(stderr, "Invalid password.\n");
            }
        } while (err != PAM_SUCCESS);

        /* Make sure account and password are still valid */
        switch (err = pam_acct_mgmt(pamh, 0)) {
            case PAM_SUCCESS:
                break;
            case PAM_USER_UNKNOWN:
            case PAM_ACCT_EXPIRED:

```

```

        /* User not allowed in anymore */
        logout();
        break;
    case PAM_NEW_AUTHTOK_REQD:
        /* The user's password has expired. Get a new one */
        do {
            err = pam_chauthtok(pamh, 0);
        } while (err == PAM_AUTHTOK_ERR);
        if (err != PAM_SUCCESS)
            logout();
        break;
    default:
        logout();
}
/* Establish the requested credentials */
if ((err = pam_setcred(pamh, PAM_ESTABLISH_CRED)) != PAM_SUCCESS)
    logout();

/* Open a session */
if ((err = pam_open_session(pamh, 0)) != PAM_SUCCESS)
    logout();

/* Close a session */
if ((err = pam_close_session(pamh, 0)) != PAM_SUCCESS)
    logout();

/* Delete the requested credentials */
if ((err = pam_setcred(pamh, PAM_DELETE_CRED)) != PAM_SUCCESS)
    logout();

if (pam_setcred(pamh, PAM_REFRESH_CRED) != PAM_SUCCESS) {
    logout();
}

(void) pam_end(pamh, 0);
return (0);
/*NOTREACHED*/
}

```

Other Useful PAM Functions

The preceding example, [Example 6, “Sample PAM Consumer Application,” on page 48](#), is a simple application that demonstrates only a few of the major PAM functions. This section describes some other PAM functions that can be useful.

- The `pam_open_session(3PAM)` function is called to open a new session after a user has been successfully authenticated.
- The `pam_getenvlist(3PAM)` function is called to establish a new environment. `pam_getenvlist()` returns a new environment to be merged with the existing environment.
- The `pam_eval(3PAM)` function loads and evaluates a PAM configuration stored in a file specified by the caller. This function is called by the `pam_user_policy(5)` PAM module.

Writing Conversation Functions

A PAM module or application can communicate with a user in a number of ways: command line, dialog box, and so on. As a result, the designer of a PAM consumer that communicates with users needs to write a *conversation function*. A conversation function passes messages between the user and module independently of the means of communication. A conversation function derives the message type from the `msg_style` parameter in the conversation function callback `pam_message` parameter. See [pam_start\(3PAM\)](#).

Developers should make no assumptions about how PAM is to communicate with users. Rather, the application should exchange messages with the user until the operation is complete. Applications should display the message strings for the conversation function without interpretation or modification. An individual message can contain multiple lines, control characters, or extra blank spaces. Note that service modules are responsible for localizing any strings sent to the conversation function.

A sample conversation function, `pam_tty_conv()`, is provided below. The `pam_tty_conv()` takes the following arguments:

- `num_msg` – The number of messages that are being passed to the function.
- `**mess` – A pointer to the buffer that holds the messages from the user.
- `**resp` – A pointer to the buffer that holds the responses to the user.
- `*my_data` – Pointer to the application data.

The sample function gets user input from `stdin`. The routine needs to allocate memory for the response buffer. A maximum, `PAM_MAX_NUM_MSG`, can be set to limit the number of messages. If the conversation function returns an error, the conversation function is responsible for clearing and freeing any memory that has been allocated for responses. In addition, the

conversation function must set the response pointer to NULL. Note that clearing memory should be accomplished using a zero fill approach. The caller of the conversation function is responsible for freeing any responses that have been returned to the caller. To conduct the conversation, the function loops through the messages from the user application. Valid messages are written to stdout, and any errors are written to stderr.

EXAMPLE 7 PAM Conversation Function

```
/*
 * Copyright (c) 2005, 2012, Oracle and/or its affiliates. All rights reserved.
 */

#pragma ident "@(#)pam_tty_conv.c 1.4 05/02/12 SMI"

#define __EXTENSIONS__
/* to expose flockfile and friends in stdio.h */
#include <errno.h>
#include <libgen.h>
#include <malloc.h>
#include <signal.h>
#include <stdio.h>
#include <stdlib.h>
#include <strings.h>
#include <stropts.h>
#include <unistd.h>
#include <termio.h>
#include <security/pam_appl.h>

static int ctl_c; /* was the conversation interrupted? */

/* ARGSUSED 1 */
static void
interrupt(int x) {
    ctl_c = 1;
}

/* getinput -- read user input from stdin abort on ^C
 * Entry noecho == TRUE, don't echo input.
 * Exit User's input.
 * If interrupted, send SIGINT to caller for processing.
 */
static char *
getinput(int noecho) {
    struct termio tty;
    unsigned short tty_flags;
    char input[PAM_MAX_RESP_SIZE];
```

```

int c;
int i = 0;
void (*sig)(int);

ctl_c = 0;
sig = signal(SIGINT, interrupt);
if (noecho) {
    (void) ioctl(fileno(stdin), TCGETA, &tty);
    tty_flags = tty.c_lflag;
    tty.c_lflag &= ~(ECHO | ECHOE | ECHOK | ECHONL);
    (void) ioctl(fileno(stdin), TCSETAF, &tty);
}

/* go to end, but don't overflow PAM_MAX_RESP_SIZE */
flockfile(stdin);
while (ctl_c == 0 &&
       (c = getchar_unlocked()) != '\n' &&
       c != '\r' &&
       c != EOF) {
    if (i < PAM_MAX_RESP_SIZE) {
        input[i++] = (char) c;
    }
}
funlockfile(stdin);
input[i] = '\0';
if (noecho) {
    tty.c_lflag = tty_flags;
    (void) ioctl(fileno(stdin), TCSETAW, &tty);
    (void) fputc('\n', stdout);
}
(void) signal(SIGINT, sig);
if (ctl_c == 1)
    (void) kill(getpid(), SIGINT);

return (strdup(input));
}

/* Service modules do not clean up responses if an error is returned.
 * Free responses here.
 */
static void
free_resp(int num_msg, struct pam_response *pr) {
    int i;
    struct pam_response *r = pr;

    if (pr == NULL)
        return;

```

```
    for (i = 0; i < num_msg; i++, r++) {

        if (r->resp) {
            /* clear before freeing -- may be a password */
            bzero(r->resp, strlen(r->resp));
            free(r->resp);
            r->resp = NULL;
        }
    }
    free(pr);
}

/* ARGSUSED */
int
pam_tty_conv(int num_msg, struct pam_message **mess,
             struct pam_response **resp, void *my_data) {
    struct pam_message *m = *mess;
    struct pam_response *r;
    int i;

    if (num_msg <= 0 || num_msg >= PAM_MAX_NUM_MSG) {
        (void) fprintf(stderr, "bad number of messages %d "
                       "<= 0 || >= %d\n",
                       num_msg, PAM_MAX_NUM_MSG);
        *resp = NULL;
        return (PAM_CONV_ERR);
    }
    if ((*resp = r = calloc(num_msg,
                           sizeof (struct pam_response))) == NULL)
        return (PAM_BUF_ERR);

    errno = 0; /* don't propogate possible EINTR */

    /* Loop through messages */
    for (i = 0; i < num_msg; i++) {
        int echo_off;

        /* bad message from service module */
        if (m->msg == NULL) {
            (void) fprintf(stderr, "message[%d]: %d/NULL\n",
                           i, m->msg_style);
            goto err;
        }

        /*
         * fix up final newline:
        */
    }
}
```

```

    * removed for prompts
    * added back for messages
    */
if (m->msg[strlen(m->msg)] == '\n')
    m->msg[strlen(m->msg)] = '\0';

r->resp = NULL;
r->resp_retcode = 0;
echo_off = 0;
switch (m->msg_style) {

    case PAM_PROMPT_ECHO_OFF:
        echo_off = 1;
        /*FALLTHROUGH*/

    case PAM_PROMPT_ECHO_ON:
        (void) fputs(m->msg, stdout);

        r->resp = getinput(echo_off);
        break;

    case PAM_ERROR_MSG:
        (void) fputs(m->msg, stderr);
        (void) fputc('\n', stderr);
        break;

    case PAM_TEXT_INFO:
        (void) fputs(m->msg, stdout);
        (void) fputc('\n', stdout);
        break;

    default:
        (void) fprintf(stderr, "message[%d]: unknown type "
            "%d/val=\"%s\"\n",
            i, m->msg_style, m->msg);
        /* error, service module won't clean up */
        goto err;
}
if (errno == EINTR)
    goto err;

/* next message/response */
m++;
r++;
}
return (PAM_SUCCESS);

```

```
err:
```

```
    free_resp(i, r);
    *resp = NULL;
    return (PAM_CONV_ERR);
}
```

Writing Modules That Provide PAM Services

Applications which call PAM services may be compiled as either 32-bit or 64-bit binaries. Since PAM modules are loaded as shared objects via `dlopen`, they must be provided in both 32-bit and 64-bit versions in order to support use by either form of application. See “[How to Add a PAM Module](#)” in *Managing Kerberos and Other Authentication Services in Oracle Solaris 11.3* for details on how to install both the 32-bit and 64-bit versions of the module so the PAM framework can load the appropriate version for the application.

Requirements for PAM Service Providers

PAM service modules use `pam_get_item(3PAM)` and `pam_set_item(3PAM)` to communicate with applications. To communicate with each other, service modules use `pam_get_data(3PAM)` and `pam_set_data(3PAM)`. If service modules from the same project need to exchange data, then a unique data name for that project should be established. The service modules can then share this data through the `pam_get_data()` and `pam_set_data()` functions.

Service modules must return one of three classes of PAM return code:

- `PAM_SUCCESS` if the module has made a positive decision that is part of the requested policy.
- `PAM_IGNORE` if the module does not make a policy decision.
- `PAM_error` if the module participates in the decision that results in a failure. The *error* can be either a generic error code or a code specific to the service module type. The error cannot be an error code for another service module type. See the `pam_authtok_get(5)` man page for `pam_sm_module-type` for the error codes.

If a service module performs multiple functions, these functions should be split up into separate modules. This approach gives system administrators finer-grained control for configuring policy.

Man pages should be provided for any new service modules. Man pages should include the following items:

- Arguments that the module accepts.
- All functions that the module implements.

- The effect of flags on the algorithm.
- Any required PAM items.
- Error returns that are specific to this module.

Service modules are required to honor the PAM_SILENT flag for preventing display of messages. The debug argument is recommended for logging debug information to `syslog`. Use `syslog(3C)` with LOG_AUTH and LOG_DEBUG for debug logging. Other messages should be sent to `syslog()` with LOG_AUTH and the appropriate priority. `openlog(3C)`, `closelog(3C)`, and `setlogmask(3C)` must not be used as these functions interfere with the applications settings.

Sample PAM Provider Service Module

A sample PAM service module follows. This example checks to see if the user is a member of a group that is permitted access to this service. The provider then grants access on success or logs an error message on failure.

The example goes through the following steps:

1. Parse the options passed to this module from the PAM configuration. See `pam.conf(4)`.

This module accepts the `nowarn` and `debug` options as well as a specific option group. With the `group` option, the module can be configured to allow access for a particular group other than the `root` group that is used by default. See the definition of `DEFAULT_GROUP` in the source code for the example. To limit access to only users who belong to group `staff`, an administrator would add the following entry to the account configuration of the PAM service:

```
account required pam_members_only.so.1 group=staff
```

2. Get the username, service name and hostname.

The username is obtained by calling `pam_get_user(3PAM)` which retrieves the current user name from the PAM handle. If the user name has not been set, access is denied. The service name and the host name are obtained by calling `pam_get_item(3PAM)`.

3. Validate the information to be worked on.

If the user name is not set, deny access. If the group to be worked on is not defined, deny access.

4. Verify that the current user is a member of the special group that allows access to this host and grant access.

In the event that the special group is defined but contains no members at all, `PAM_IGNORE` is returned to indicate that this module does not participate in any account validation process. The decision is left to other modules on the stack.

5. If the user is not a member of the special group, display a message to inform the user that access is denied.

Log a message to record this event.

The following example shows the source code for the sample PAM provider.

EXAMPLE 8 Sample PAM Service Module

```
/*
 * Copyright (c) 2005, 2012, Oracle and/or its affiliates. All rights reserved.
 */

#include <stdio.h>
#include <stdlib.h>
#include <grp.h>
#include <string.h>
#include <syslog.h>
#include <libintl.h>
#include <security/pam_appl.h>

/*
 * by default, only users who are a member of group "root" are allowed access
 */
#define DEFAULT_GROUP "root"

static char *NOMSG =
    "Sorry, you are not on the access list for this host - access denied.";

int
pam_sm_acct_mgmt(pam_handle_t * pamh, int flags, int argc, const char **argv) {
    char *user = NULL;
    char *host = NULL;
    char *service = NULL;
    const char *allowed_grp = DEFAULT_GROUP;
    char grp_buf[4096];
    struct group grp;
    struct pam_conv *conversation;
    struct pam_message message;
    struct pam_message *pmessage = &message;
    struct pam_response *res = NULL;
    int i;
    int nowarn = 0;
    int debug = 0;

    /* Set flags to display warnings if in debug mode. */
```

```

for (i = 0; i < argc; i++) {
    if (strcasecmp(argv[i], "nowarn") == 0)
        nowarn = 1;
    else if (strcasecmp(argv[i], "debug") == 0)
        debug = 1;
    else if (strncmp(argv[i], "group=", 6) == 0)
        allowed_grp = &argv[i][6];
}
if (flags & PAM_SILENT)
    nowarn = 1;

/* Get user name, service name, and host name. */
(void) pam_get_user(pamh, &user, NULL);
(void) pam_get_item(pamh, PAM_SERVICE, (void **) &service);
(void) pam_get_item(pamh, PAM_RHOST, (void **) &host);

/* Deny access if user is NULL. */
if (user == NULL) {
    syslog(LOG_AUTH | LOG_DEBUG,
        "%s: members_only: user not set", service);
    return (PAM_USER_UNKNOWN);
}

if (host == NULL)
    host = "unknown";

/*
 * Deny access if vuser group is required and user is not in vuser
 * group
 */
if (getgrnam_r(allowed_grp, &grp, grp_buf, sizeof (grp_buf)) == NULL) {
    syslog(LOG_NOTICE | LOG_AUTH,
        "%s: members_only: group \"%s\" not defined",
        service, allowed_grp);
    return (PAM_SYSTEM_ERR);
}

/* Ignore this module if group contains no members. */
if (grp.gr_mem[0] == 0) {
    if (debug)
        syslog(LOG_AUTH | LOG_DEBUG,
            "%s: members_only: group %s empty: "
            "all users allowed.", service, grp.gr_name);
    return (PAM_IGNORE);
}

/* Check to see if user is in group. If so, return SUCCESS. */
for (; grp.gr_mem[0]; grp.gr_mem++) {

```

```
    if (strcmp(grp.gr_mem[0], user) == 0) {
        if (debug)
            syslog(LOG_AUTH | LOG_DEBUG,
                "%s: user %s is member of group %s. "
                "Access allowed.",
                service, user, grp.gr_name);
        return (PAM_SUCCESS);
    }
}

/*
 * User is not a member of the group.
 * Set message style to error and specify denial message.
 */
message.msg_style = PAM_ERROR_MSG;
message.msg = gettext(NOMSG);

/* Use conversation function to display denial message to user. */
(void) pam_get_item(pamh, PAM_CONV, (void **) &conversation);
if (nowarn == 0 && conversation != NULL) {
    int err;
    err = conversation->conv(1, &message, &res,
        conversation->appdata_ptr);
    if (debug && err != PAM_SUCCESS)
        syslog(LOG_AUTH | LOG_DEBUG,
            "%s: members_only: conversation returned "
            "error %d (%s).", service, err,
            pam_strerror(pamh, err));

    /* free response (if any) */
    if (res != NULL) {
        if (res->resp)
            free(res->resp);
        free(res);
    }
}

/* Report denial to system log and return error to caller. */
syslog(LOG_NOTICE | LOG_AUTH, "%s: members_only: "
    "Connection for %s not allowed from %s", service, user, host);

return (PAM_PERM_DENIED);
}
```

◆◆◆ CHAPTER 4

Writing Applications That Use GSS-API

The Generic Security Service Application Programming Interface (GSS-API) provides a means for applications to protect data to be sent to peer applications. Typically, the connection is from a client on one system to a server on a different system.

This chapter provides information about the following subjects:

- [“Introduction to GSS-API” on page 61](#)
- [“Important Elements of GSS-API” on page 66](#)
- [“Developing Applications That Use GSS-API” on page 77](#)

Introduction to GSS-API

GSS-API enables programmers to write applications generically with respect to security. Developers do not have to tailor the security implementations to any particular platform, security mechanism, type of protection, or transport protocol. With GSS-API, a programmer can avoid the details of protecting network data. A program that uses GSS-API is more portable with regards to network security. This portability is the hallmark of the Generic Security Service API.

GSS-API is a framework that provides security services to callers in a generic fashion. The GSS-API framework is supported by a range of underlying mechanisms and technologies, such as Kerberos v5 or public key technologies, as shown in [Figure 2, “GSS-API Layer,” on page 62](#).

FIGURE 2 GSS-API Layer

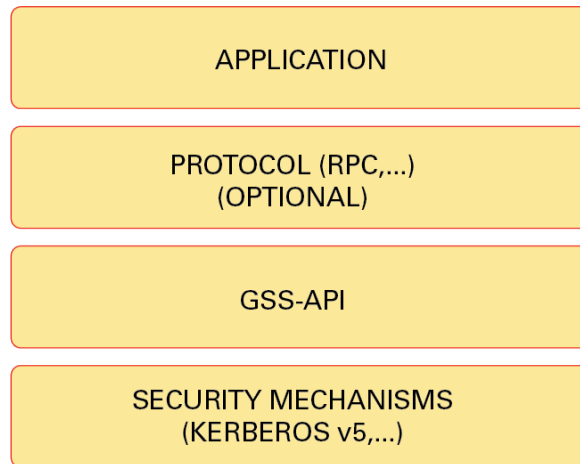

Broadly speaking, GSS-API does two main things:

1. GSS-API creates a security *context* in which data can be passed between applications. A context is a state of trust between two applications. Applications that share a context recognize each other and thus can permit data transfers while the context lasts.
2. GSS-API applies one or more types of protection, known as *security services*, to the data to be transmitted. Security services are explained in [“Security Services in GSS-API” on page 63](#).

In addition, GSS-API performs the following functions:

- Data conversion
- Error checking
- Delegation of user privileges
- Information display
- Identity comparison

GSS-API includes numerous support and convenience functions.

Application Portability With GSS-API

GSS-API provides several types of portability for applications:

- **Mechanism independence.** GSS-API provides a generic interface for security. By specifying a default security mechanism, an application does not need to know the mechanism to be applied nor any details about that mechanism.
- **Protocol independence.** GSS-API is independent of any communications protocol or protocol suite. For example, GSS-API can be used with applications that use sockets, RCP, or TCP/IP.
RPCSEC_GSS is an additional layer that smoothly integrates GSS-API with RPC. For more information, see [“Remote Procedure Calls With GSS-API” on page 64](#).
- **Platform independence.** GSS-API is independent of the type of operating system on which an application is running.
- **Quality of Protection independence.** Quality of Protection (QOP) refers to the type of algorithm for encrypting data or generating cryptographic tags. GSS-API allows a programmer to ignore QOP by using a default that is provided by GSS-API. On the other hand, an application can specify the QOP if necessary.

Security Services in GSS-API

GSS-API provides three types of security services:

- **Authentication** – The basic security offered by GSS-API is *authentication*. Authentication is the verification of an identity. If a user is authenticated, the system assumes that person is the one who is entitled to operate under that user name.
- **Integrity** – *Integrity* is the verification of the data's validity. Even if data comes from a valid user, the data itself could have become corrupted or compromised. Integrity ensures that a message is complete as intended, with nothing added and nothing missing. GSS-API provides for data to be accompanied by a cryptographic tag, known as a Message Integrity Code (MIC). The MIC proves that the data that you receive is the same as the data that the sender transmitted.
- **Confidentiality** – *Confidentiality* ensures that a third party who intercepted the message would have a difficult time reading the contents. Neither authentication nor integrity modify the data. If the data is somehow intercepted, others can read that data. GSS-API therefore allows data to be encrypted, provided that underlying mechanisms are available that support encryption. This encryption of data is known as confidentiality.

Available Mechanisms in GSS-API

The current implementation of GSS-API works with the following mechanisms: Kerberos v5™, Diffie-Hellman, and SPNEGO. For more information about the Kerberos implementation, see [Managing Kerberos and Other Authentication Services in Oracle Solaris 11.3](#) for more information. Kerberos v5 should be installed and running on any system on which GSS-API-aware programs are running.

Remote Procedure Calls With GSS-API

Programmers who use the RPC (Remote Procedure Call) protocol for networking applications can use RPCSEC_GSS to provide security. RPCSEC_GSS is a separate layer that sits on top of GSS-API. RPCSEC_GSS provides all the functionality of GSS-API in a way that is tailored to RPC. In fact, RPCSEC_GSS serves to hide many aspects of GSS-API from the programmer, making RPC security especially accessible and portable. For more information about RPCSEC_GSS, see [“Authentication Using RPCSEC_GSS” in *ONC+ RPC Developer’s Guide*](#).

The following diagram illustrates how the RPCSEC_GSS layer sits between the application and GSS-API.

FIGURE 3 RPCSEC_GSS and GSS-API

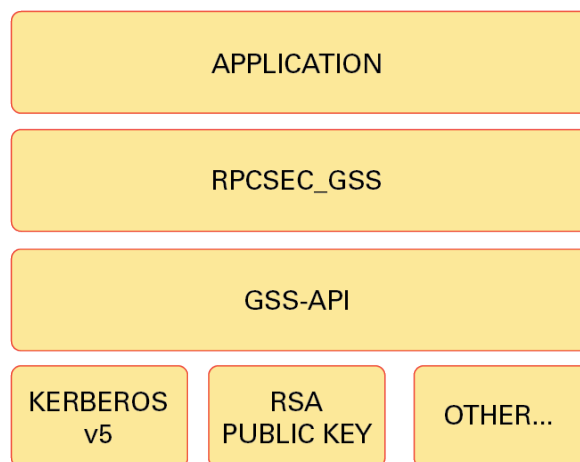

Limitations of GSS-API

Although GSS-API makes protecting data simple, GSS-API avoids some tasks that would not be consistent with GSS-API's generic nature. Accordingly, GSS-API does *not* perform the following activities:

- Provide security credentials for users or applications. Credentials must be provided by the underlying security mechanisms. GSS-API *does* allow applications to acquire credentials, either automatically or explicitly.
- Transfer data between applications. The application has the responsibility for handling the transfer of *all* data between peers, whether the data is security-related or plain data.
- Distinguish between different types of transmitted data. For example, GSS-API does not know whether a data packet is plain data or encrypted.
- Indicate status due to asynchronous errors.
- Protect by default information that has been sent between processes of a multiprocess program.
- Allocate string buffers to be passed to GSS-API functions. See “[Strings and Similar Data in GSS-API](#)” on page 66.
- Deallocate GSS-API data spaces. This memory must be explicitly deallocated with functions such as `gss_release_buffer()` and `gss_delete_name()`.

Language Bindings for GSS-API

This document currently covers only the C language bindings, that is, functions and data types, for GSS-API. A Java-bindings version of GSS-API is now available. The Java GSS-API contains the Java bindings for the Generic Security Services Application Program Interface (GSS-API), as defined in RFC 2853.

Where to Get More Information on GSS-API

These two documents provide further information about GSS-API:

- [Generic Security Service Application Program Interface](http://www.ietf.org/rfc/rfc2743.txt) document (<http://www.ietf.org/rfc/rfc2743.txt>) provides a conceptual overview of GSS-API.
- [Generic Security Service API Version 2: C-Bindings](http://www.ietf.org/rfc/rfc2744.txt) document (<http://www.ietf.org/rfc/rfc2744.txt>) discusses the specifics of the C-language-based GSS-API.

Important Elements of GSS-API

This section covers the following important GSS-API concepts: principals, GSS-API data types, status codes, and tokens.

- [“GSS-API Data Types” on page 66](#)
- [“GSS-API Status Codes” on page 74](#)
- [“GSS-API Tokens” on page 75](#)

GSS-API Data Types

The following sections explain the major GSS-API data types. For information about all GSS-API data types, see [“GSS-API Data Types and Values” on page 249](#).

GSS-API Integers

Because the size of an `int` can vary from platform to platform, GSS-API provides the following integer data type: `OM_uint32` which is a 32-bit unsigned integer.

Strings and Similar Data in GSS-API

Because GSS-API handles all data in internal formats, strings must be converted to a GSS-API format before being passed to GSS-API functions. GSS-API handles strings with the `gss_buffer_desc` structure:

```
typedef struct gss_buffer_desc_struct {
    size_t    length;
    void      *value;
} gss_buffer_desc *gss_buffer_t;
```

`gss_buffer_t` is a pointer to such a structure. Strings must be put into a `gss_buffer_desc` structure before being passed to functions that use them. In the following example, a generic GSS-API function applies protection to a message before sending that message.

EXAMPLE 9 Using Strings in GSS-API

```
char *message_string;
```

```

gss_buffer_desc input_msg_buffer;

input_msg_buffer.value = message_string;
input_msg_buffer.length = strlen(input_msg_buffer.value) + 1;

gss_generic_function(arg1, &input_msg_buffer, arg2...);

gss_release_buffer(input_msg_buffer);

```

Note that `input_msg_buffer` must be deallocated with `gss_release_buffer()` when you are finished with `input_msg_buffer`.

The `gss_buffer_desc` object is not just for character strings. For example, tokens are manipulated as `gss_buffer_desc` objects. See [“GSS-API Tokens” on page 75](#) for more information.

Names in GSS-API

A *name* refers to a principal. In network-security terminology, a *principal* is a user, a program, or a system. Principals can be either clients or servers.

Some examples of principals are:

- A user, such as `user@system`, who logs into another system
- A network service, such as `nfs@system`
- A system, such as `mysystem@example.com`, that runs an application

In GSS-API, names are stored as a `gss_name_t` object, which is opaque to the application. Names are converted from `gss_buffer_t` objects to the `gss_name_t` form by the `gss_import_name()` function. Every imported name has an associated *name type*, which indicates the format of the name. See [“GSS-API OIDs” on page 73](#) for more about name types. See [“Name Types” on page 251](#) for a list of valid name types.

`gss_import_name()` has the following syntax:

```

OM_uint32 gss_import_name (
    OM_uint32          *minor-status,
    const gss_buffer_t input-name-buffer,
    const gss_OID      input-name-type,
    gss_name_t         *output-name)

```

minor-status Status code returned by the underlying mechanism. See [“GSS-API Status Codes” on page 74](#).

<i>input-name-buffer</i>	The <code>gss_buffer_desc</code> structure containing the name to be imported. The application must allocate this structure explicitly. See “Strings and Similar Data in GSS-API” on page 66 as well as Example 10, “Using <code>gss_import_name()</code>,” on page 68 . This argument must be deallocated with <code>gss_release_buffer()</code> when the application is finished with the space.
<i>input-name-type</i>	A <code>gss_OID</code> that specifies the format of <i>input-name-buffer</i> . See “Name Types in GSS-API” on page 74 . Also, “Name Types” on page 251 contains a table of valid name types.
<i>output-name</i>	The <code>gss_name_t</code> structure to receive the name.

A minor modification of the generic example shown in [Example 9, “Using Strings in GSS-API,” on page 66](#) illustrates how `gss_import_name()` can be used. First, the regular string is inserted into a `gss_buffer_desc` structure. Then `gss_import_name()` places the string into a `gss_name_t` structure.

EXAMPLE 10 Using `gss_import_name()`

```
char *name_string;
gss_buffer_desc input_name_buffer;
gss_name_t      output_name_buffer;

input_name_buffer.value = name_string;
input_name_buffer.length = strlen(input_name_buffer.value) + 1;

gss_import_name(&minor_status, input_name_buffer,
               GSS_C_NT_HOSTBASED_SERVICE, &output_name);

gss_release_buffer(input_name_buffer);
```

An imported name can be put back into a `gss_buffer_t` object for display in human-readable form with `gss_display_name()`. However, `gss_display_name()` does not guarantee that the resulting string will be the same as the original due to the way the underlying mechanisms store names. GSS-API includes several other functions for manipulating names. See [“GSS-API Functions” on page 243](#).

A `gss_name_t` structure can contain several versions of a single name. One version is produced for each mechanism that is supported by GSS-API. That is, a `gss_name_t` structure for *user@company* might contain one version of that name as rendered by Kerberos v5 and another version that was given by a different mechanism. The function `gss_canonicalize_name()` takes as input an internal name and a mechanism. `gss_canonicalize_name()` yields a second internal name that contains a single version of the name that is specific to that mechanism.

Such a mechanism-specific name is called a *mechanism name* (MN). A mechanism name does not refer to the name of a mechanism, but to the name of a principal as produced by a given mechanism. This process is illustrated in the following figure.

FIGURE 4 Internal Names and Mechanism Names

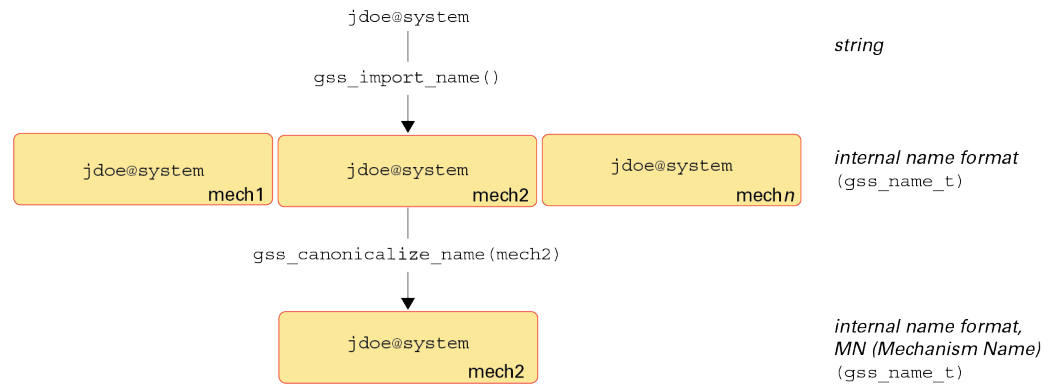

Comparing Names in GSS-API

Consider the case where a server has received a name from a client and needs to look up that name in an access control list. An *access control list*, or ACL, is a list of principals with particular access permissions.

One way to do the lookup would be as follows:

1. Import the client name into GSS-API internal format with `gss_import_name()`, if the name has not already been imported.
In some cases, the server will receive a name in internal format, so this step will not be necessary. For example, a server might look up the client's own name. During context initiation, the client's own name is passed in internal format.
2. Import each name in the ACL with `gss_import_name()`.
3. Compare each imported ACL name with the imported client's name, using `gss_compare_name()`.

This process is shown in [Figure 5, “Comparing Names \(Slow\),” on page 70](#). In this case, Step 1 is assumed to be needed.

FIGURE 5 Comparing Names (Slow)

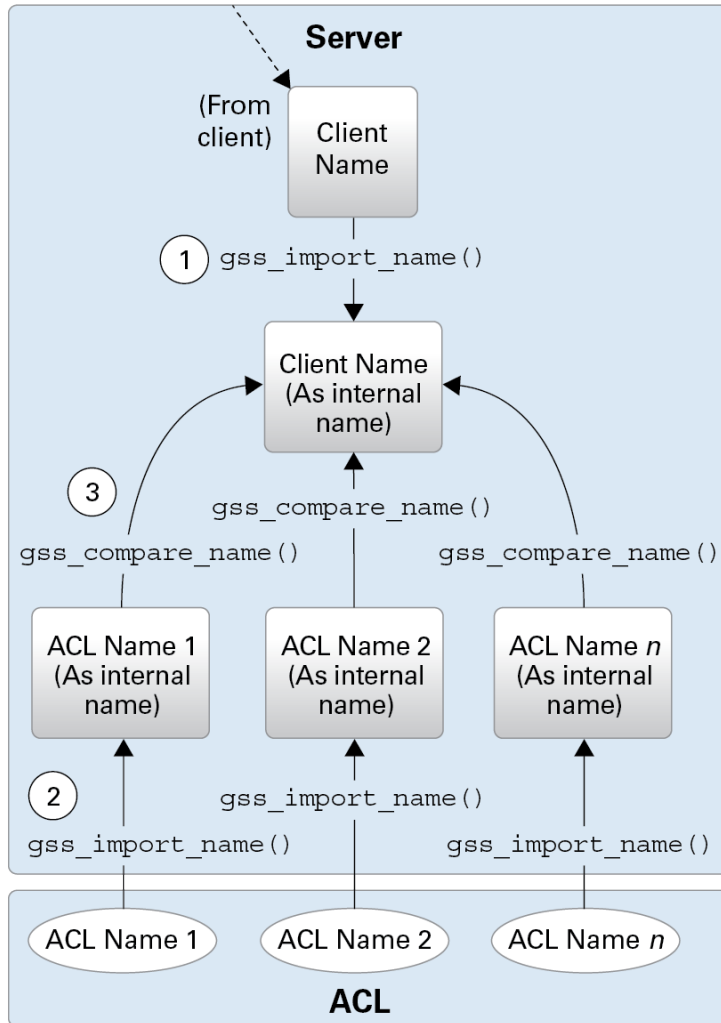

The previous approach of comparing names individually is acceptable when there are only a few names. When there are a large number of names, using the `gss_canonicalize_name()` function is more efficient.

This approach uses the following steps:

1. Import the client's name with `gss_import_name()`, if the name has not already been imported.
As with the previous method of comparing names, if the name is already in internal format, this step is unnecessary.
2. Use `gss_canonicalize_name()` to produce a mechanism name version of the client's name.
3. Use `gss_export_name()` to produce an exported name, which is the client's name as a contiguous string.
4. Compare the exported client's name with each name in the ACL by using `memcmp()`, which is a fast, low-overhead function.

This process is shown in [Figure 6, “Comparing Names \(Fast\),” on page 72](#). Again, assume that the server needs to import the name that is received from the client.

FIGURE 6 Comparing Names (Fast)

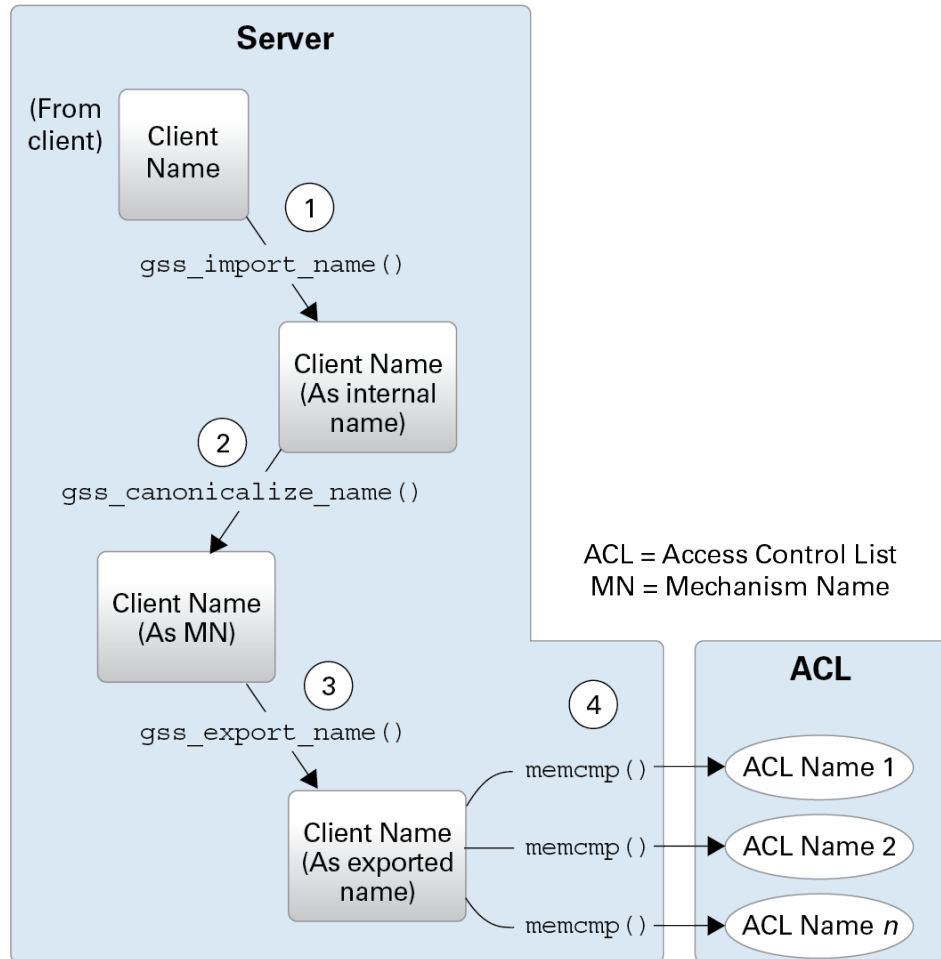

Because `gss_export_name()` expects a mechanism name (MN), you *must* run `gss_canonicalize_name()` on the client's name first.

See the `gss_export_name(3GSS)`, `gss_import_name(3GSS)`, and `gss_canonicalize_name(3GSS)` for more information.

GSS-API OIDs

Object identifiers (OIDs) are used to store the following kinds of data:

- Security mechanisms
- QOPs – Quality of Protection values
- Name types

OIDs are stored in GSS-API `gss_OID_desc` structure. GSS-API provides a pointer to the structure, `gss_OID`, as shown in the following example.

EXAMPLE 11 OIDs Structure

```
typedef struct gss_OID_desc_struct {
    OM_uint32  length;
    void       *elements;
} gss_OID_desc, *gss_OID;
```

Further, one or more OIDs might be contained in a `gss_OID_set_desc` structure.

EXAMPLE 12 OID Set Structure

```
typedef struct gss_OID_set_desc_struct {
    size_t  count;
    gss_OID elements;
} gss_OID_set_desc, *gss_OID_set;
```



Caution - Applications should not attempt to deallocate OIDs with `free()`.

Mechanisms and QOPs in GSS-API

Although GSS-API allows applications to choose underlying security mechanisms, applications should use the default mechanism that has been selected by GSS-API if possible. Similarly, although GSS-API lets an application specify a Quality of Protection level for protecting data, the default QOP should be used if possible. Acceptance of the default mechanism is indicated by passing the value `GSS_C_NULL_OID` to functions that expect a mechanism or QOP as an argument.



Caution - Specifying a security mechanism or QOP explicitly defeats the purpose of using GSS-API. Such a specific selection limits the portability of an application. Other implementations of GSS-API might not support that QOP or mechanism in the intended manner. Nonetheless, [Appendix D, “Specifying an OID”](#) briefly discusses how to find out which mechanisms and QOPs are available, and how to choose one.

Name Types in GSS-API

Besides QOPs and security mechanisms, OIDs are also used to indicate name types, which indicate the format for an associated name. For example, the function `gss_import_name()`, which converts the name of a principal from a string to a `gss_name_t` type, takes as one argument the format of the string to be converted. If the name type is, for example, `GSS_C_NT_HOSTBASED_SERVICE`, then the function knows that the name being input is of the form `service@host`. If the name type is `GSS_C_NT_EXPORT_NAME`, then the function expects a GSS-API exported name. Applications can find out which name types are available for a given mechanism with the `gss_inquire_names_for_mech()` function. A list of name types used by GSS-API is provided in [“Name Types” on page 251](#).

GSS-API Status Codes

All GSS-API functions return two types of codes that provide information about the function's success or failure. Both types of status codes are returned as `OM_uint32` values.

The two types of return codes are as follows:

- **Major status codes**

Major status codes indicate the following errors:

- Generic GSS-API routine errors, such as giving a routine an invalid mechanism
- Call errors that are specific to a particular GSS-API language binding, such as a function argument that cannot be read, cannot be written, or is malformed
- Both types of errors

Additionally, major status codes can provide supplementary information about a routine's status. For example, a code might indicate that an operation is not finished, or that a token has been sent out of order. If no errors occur, the routine returns a major status value of `GSS_S_COMPLETE`.

Major status codes are returned as follows:

```
OM_uint32 major_status ;    /* status returned by GSS-API */
```

```
major_status = gss_generic_function(arg1, arg2 ...);
```

Major status return codes can be processed like any other `OM_uint32`. For example, consider the following code.

```
OM_uint32 maj_stat;

maj_sta = gss_generic_function(arg1, arg2 ...);

if (maj_stat == GSS_CREDENTIALS_EXPIRED)
    <do something...>
```

Major status codes can be processed with the macros `GSS_ROUTINE_ERROR()`, `GSS_CALLING_ERROR()`, and `GSS_SUPPLEMENTARY_INFO()`. [“GSS-API Status Codes” on page 246](#) explains how to read major status codes and contains a list of GSS-API status codes.

■ Minor status codes

Minor status codes are returned by the underlying mechanism. These codes are not specifically documented in this manual.

Every GSS-API function has as a first argument an `OM_uint32` type for the minor code status. The minor status code is stored in the `OM_uint32` argument when the function returns to the calling function. Consider the following code.

```
OM_uint32 *minor_status ;    /* status returned by mech */

major_status = gss_generic_function(&minor_status, arg1, arg2 ...);
```

The `minor_status` parameter is always set by a GSS-API routine, even if a fatal major status code error is returned. Note that most other output parameters can remain unset. However, output parameters that are expected to return pointers to storage that has been allocated by the routine are set to `NULL`. `NULL` indicates that no storage was actually allocated. Any length field associated with such pointers, as in a `gss_buffer_desc` structure, are set to zero. In such cases, applications do not need to release these buffers.

GSS-API Tokens

The basic unit of "currency" in GSS-API is the *token*. Applications that use GSS-API communicate with each other by using tokens. Tokens are used for exchanging data and for making security arrangements. Tokens are declared as `gss_buffer_t` data types. Tokens are opaque to applications.

Two types of tokens are *context-level tokens* and *per-message tokens*. Context-level tokens are used primarily when a context is established, that is, initiated and accepted. Context-level tokens can also be passed afterward to manage a context.

Per-message tokens are used after a context has been established. Per-message tokens are used to provide protection services on data. For example, consider an application that wants to send a message to another application. That application might use GSS-API to generate a cryptographic identifier to go along with that message. The identifier would be stored in a token.

Per-message tokens can be considered with regard to messages as follows. A *message* is a piece of data that an application sends to a peer. For example, the `ls` command could be a message that is sent to an ftp server. A *per-message token* is an object generated by GSS-API for that message. A per-message token could be a cryptographic tag or the encrypted form of the message. Note that this last example is mildly inaccurate. An encrypted message is still a message and not a token. A token is *only* GSS-API-generated information. However, informally, *message* and *per-message* token are often used interchangeably.

An application is responsible for the following activities:

1. Sending and receiving tokens. The developer usually needs to write generalized read and write functions for performing these actions. The `send_token()` and `recv_token()` functions in [“Miscellaneous GSS-API Sample Functions” on page 234](#).
2. Distinguishing between types of tokens and manipulating the tokens accordingly.

Because tokens are opaque to applications, the application does not distinguish between one token and another. Without knowing a token's contents, an application must be able to distinguish the token's type to pass that token to an appropriate GSS-API function.

An application can distinguish token types through the following methods:

- By state. Through the control-flow of a program. For example, an application that is waiting to accept a context might assume that any received tokens are related to context establishment. Peers are expected to wait until the context is fully established before sending message tokens, that is, data. After the context is established, the application assumes that new tokens are message tokens. This approach to handling tokens is a fairly common way to handle tokens. The sample programs in this book use this method.
- By flags. For example, if an application has a function for sending tokens to peers, that application can include a flag to indicate the kind of token. Consider the following code:

```
gss_buffer_t token;      /* declare the token */
OM_uint32 token_flag    /* flag for describing the type of token */

    <get token from a GSS-API function>

token_flag = MIC_TOKEN; /* specify what kind of token it is */
```

```
send_a_token(&token, token_flag);
```

The receiving application would have a receiving function, for example, `get_a_token()`, that would check the `token_flag` argument.

- Through explicit tagging. Applications can use *meta-tokens*. A meta-token is a user-defined structure that contain tokens that have been received from GSS-API functions. A meta-token includes user-defined fields that signal how the tokens that are provided by GSS-API are to be used.

Interprocess Tokens in GSS-API

GSS-API permits a security context to be passed from one process to another in a multiprocess application. Typically, an application has accepted a client's context. The application then shares the context among that application's processes. See [“Exporting and Importing Contexts in GSS-API” on page 87](#) for information about multiprocess applications.

The `gss_export_context()` function creates an interprocess token. This token contains information that enables the context to be reconstituted by a second process. The application is responsible for passing the interprocess token from one process to the other. This situation is similar to the application's responsibility for passing tokens to other applications.

The interprocess token might contain keys or other sensitive information. Not all GSS-API implementations cryptographically protect interprocess tokens. Therefore, the application must protect interprocess tokens before an exchange takes place. This protection might involve encrypting the tokens with `gss_wrap()`, if encryption is available.

Note - Do not assume that interprocess tokens are transferable across different GSS-API implementations.

Developing Applications That Use GSS-API

This section shows how to implement secure data exchange using GSS-API. The section focuses on those functions that are most central to using GSS-API. For more information, see [Appendix C, “GSS-API Reference”](#), which contains a list of all GSS-API functions, status codes, and data types. To find out more about any GSS-API function, check the individual man page.

The examples in this manual follow a simple model. A client application sends data directly to a remote server. No mediation by transport protocol layers such as RPC occurs.

Generalized GSS-API Usage

The general steps for using GSS-API are as follows:

1. Each application, both sender and recipient, acquires credentials explicitly, unless credentials have been acquired automatically.
2. The sender initiates a security context. The recipient accepts the context.
3. The sender applies security protection to the data to be transmitted. The sender either encrypts the message or stamps the data with an identification tag. The sender then transmits the protected message.

Note - The sender can choose not to apply either security protection, in which case the message has only the default GSS-API security service, that is, authentication.

4. The recipient decrypts the message if needed and verifies the message if appropriate.
5. (Optional) The recipient returns an identification tag to the sender for confirmation.
6. Both applications destroy the shared security context. If necessary, the allocations can also deallocate any remaining GSS-API data.



Caution - The calling application is responsible for freeing all data space that has been allocated.

Applications that use GSS-API need to include the file `gssapi.h`.

Working With Credentials in GSS-API

A *credential* is a data structure that provides proof of an application's claim to a principal name. An application uses a credential to establish that application's global identity. Additionally, a credential may be used to confirm an entity's privileges.

GSS-API does not provide credentials. Credentials are created by the security mechanisms that underly GSS-API, before GSS-API functions are called. In many cases, a user receives credentials at login.

A given GSS-API credential is valid for a single principal. A single credential can contain multiple elements for that principal, each created by a different mechanism. A credential that is acquired on a system with multiple security mechanisms is valid if that credential is transferred to a system with a subset of those mechanisms. GSS-API accesses credentials through the

`gss_cred_id_t` structure. This structure is called a *credential handle*. Credentials are opaque to applications. Thus, the application does not need to know the specifics of a given credential.

Credentials come in three forms:

- `GSS_C_INITIATE` – Identifies applications that only initiate security contexts
- `GSS_C_ACCEPT` – Identifies applications that only accept security contexts
- `GSS_C_BOTH` – Identifies applications that can initiate or accept security contexts

Acquiring Credentials in GSS-API

Before a security context can be established, both the server and the client must acquire their respective credentials. A credential can be reused until that credential expires, after which the application must reacquire the credential. Credentials that are used by the client and credentials that are used by the server can have different lifetimes.

GSS-API-based applications can acquire credentials in two ways:

- By using the `gss_acquire_cred()` or `gss_add_cred()` function
- By specifying the value `GSS_C_NO_CREDENTIAL`, which indicates a default credential, when the context is established

In most cases, `gss_acquire_cred()` is called only by a context acceptor, that is, a server. A context initiator, that is, a client, typically receives credentials at login. A client, therefore, can usually specify the default credential. The server can also bypass `gss_acquire_cred()` and use that server's default credential instead.

A client's credential proves that client's identity to other processes. A server acquires a credential to enable that server to accept a security context. So when a client makes an `ftp` request to a server, that client might already have a credential from login. GSS-API automatically retrieves the credential when the client attempts to initiate a context. The server program, however, explicitly acquires credentials for the requested service (`ftp`).

If `gss_acquire_cred()` completes successfully, then `GSS_S_COMPLETE` is returned. If a valid credential cannot be returned, then `GSS_S_NO_CRED` is returned. See the `gss_acquire_cred(3GSS)` man page for other error codes. For an example, see [“Acquiring Credentials” on page 119](#).

`gss_add_cred()` is similar to `gss_acquire_cred()`. However, `gss_add_cred()` enables an application to use an existing credential to create a new handle or to add a new credential element. If `GSS_C_NO_CREDENTIAL` is specified as the existing credential, then `gss_add_cred()` creates a new credential according to the default behavior. See the `gss_add_cred(3GSS)` man page for more information.

Working With Contexts in GSS-API

The two most significant tasks for GSS-API in providing security are to create security contexts and to protect data. After an application acquires the necessary credentials, a security context must be established. To establish a context, one application, typically a client, initiates the context, and another application, usually a server, accepts the context. Multiple contexts between peers are allowed.

The communicating applications establish a joint security context by exchanging authentication tokens. The security context is a pair of GSS-API data structures that contain information to be shared between the two applications. This information describes the state of each application in terms of security. A security context is required for protection of data.

Initiating a Context in GSS-API

The `gss_init_sec_context()` function is used to start a security context between an application and a remote peer. If successful, this function returns a *context handle* for the context to be established and a context-level token to send to the acceptor.

Before calling `gss_init_sec_context()`, the client should perform the following tasks:

1. Acquire credentials, if necessary, with `gss_acquire_cred()`. Typically, the client receives credentials at login. `gss_acquire_cred()` can only retrieve initial credentials from the running operating system.
2. Import the name of the server into GSS-API internal format with `gss_import_name()`. See [“Names in GSS-API” on page 67](#) for more information about names and `gss_import_name()`.

When calling `gss_init_sec_context()`, a client typically passes the following argument values:

- `GSS_C_NO_CREDENTIAL` for the *cred_handle* argument, to indicate the default credential.
- `GSS_C_NULL_OID` for the *mech_type* argument, to indicate the default mechanism.
- `GSS_C_NO_CONTEXT` for the *context_handle* argument, to indicate an initial null context. Because `gss_init_sec_context()` is usually called in a loop, subsequent calls should pass the context handle that was returned by previous calls.
- `GSS_C_NO_BUFFER` for the *input_token* argument, to indicate an initially empty token. Alternatively, the application can pass a pointer to a `gss_buffer_desc` object whose length field has been set to zero.

- The name of the server, imported into internal GSS-API format with `gss_import_name()`.

Applications are not bound to use these default values. Additionally, a client can specify requirements for other security parameters with the *req_flags* argument. The full set of `gss_init_sec_context()` arguments is described below.

The context acceptor might require several handshakes to establish a context. That is, an acceptor can require the initiator to send more than one piece of context information before the context is fully established. Therefore, for portability, context initiation should always be done as part of a loop that checks whether the context has been fully established.

If the context is not complete, `gss_init_sec_context()` returns a major status code of `GSS_C_CONTINUE_NEEDED`. Therefore, a loop should use the return value from `gss_init_sec_context()` to test whether to continue the initiation loop.

The client passes context information to the server in the form of the *output token*, which is returned by `gss_init_sec_context()`. The client receives information back from the server as an *input token*. The input token can then be passed as an argument in subsequent calls of `gss_init_sec_context()`. If the received input token has a length of zero, however, then no more output tokens are required by the server.

Therefore, besides checking for the return status of `gss_init_sec_context()`, the loop should check the input token's length. If the length has a nonzero value, another token needs to be sent to the server. Before the loop begins, the input token's length should be initialized to zero. Either set the input token to `GSS_C_NO_BUFFER` or set the structure's length field to a value of zero.

The following pseudocode demonstrates an example of context establishment from the client side.

```

context = GSS_C_NO_CONTEXT
input token = GSS_C_NO_BUFFER

do

    call gss_init_sec_context(credential, context, name, input token,
                            output token, other args...)

    if (there's an output token to send to the acceptor)
        send the output token to the acceptor
        release the output token

    if (the context is not complete)
        receive an input token from the acceptor

    if (there's a GSS-API error)

```

delete the context

until the context is complete

A real loop would be more complete with more extensive error-checking. See [“Establishing a Security Context With the Server” on page 103](#) for a real example of such a context-initiation loop. Additionally, the `gss_init_sec_context(3GSS)` man page provides a less generic example.

In general, the parameter values returned when a context is not fully established are those values that would be returned when the context is complete. See the `gss_init_sec_context()` man page for more information.

If `gss_init_sec_context()` completes successfully, `GSS_S_COMPLETE` is returned. If a context-establishment token is required from the peer application, `GSS_S_CONTINUE_NEEDED` is returned. If errors occur, error codes are returned as shown in the `gss_init_sec_context(3GSS)` man page.

If context initiation fails, the client should disconnect from the server.

Accepting a Context in GSS-API

The other half of context establishment is context acceptance, which is done through the `gss_accept_sec_context()` function. In a typical scenario, a server accepts a context that has been initiated by a client with `gss_init_sec_context()`.

The main input to `gss_accept_sec_context()` is an input token from the initiator. The initiator returns a context handle as well as an output token to be returned to the initiator. Before `gss_accept_sec_context()` can be called, however, the server should acquire credentials for the service that was requested by the client. The server acquires these credentials with the `gss_acquire_cred()` function. Alternatively, the server can bypass explicit acquisition of credentials by specifying the default credential, that is, `GSS_C_NO_CREDENTIAL`, when the server calls `gss_accept_sec_context()`.

When calling `gss_accept_sec_context()`, the server can set the following arguments as shown:

- *cred_handle* – The credential handle returned by `gss_acquire_cred()`. Alternatively, `GSS_C_NO_CREDENTIAL` can be used to indicate the default credential.
- *context_handle* – `GSS_C_NO_CONTEXT` indicates an initial null context. Because `gss_init_sec_context()` is usually called in a loop, subsequent calls should pass the context handle that was returned by previous calls.

- *input_token* – The context token received from the client.

The full set of `gss_accept_sec_context()` arguments is described in the following paragraphs.

Security context establishment might require several handshakes. The initiator and acceptor often need to send more than one piece of context information before the context is fully established. Therefore, for portability, context acceptance should always be done as part of a loop that checks whether the context has been fully established. If the context is not yet established, `gss_accept_sec_context()` returns a major status code of `GSS_C_CONTINUE_NEEDED`. Therefore, a loop should use the value that was returned by `gss_accept_sec_context()` to test whether to continue the acceptance loop.

The context acceptor returns context information to the initiator in the form of the output token that was returned by `gss_accept_sec_context()`. Subsequently, the acceptor can receive additional information from the initiator as an input token. The input token is then passed as an argument to subsequent `gss_accept_sec_context()` calls. When `gss_accept_sec_context()` has no more tokens to send to the initiator, an output token with a length of zero is returned. Besides checking for the return status `gss_accept_sec_context()`, the loop should check the output token's length to see whether another token must be sent. Before the loop begins, the output token's length should be initialized to zero. Either set the output token to `GSS_C_NO_BUFFER`, or set the structure's length field to a value of zero.

The following pseudocode demonstrates an example of context establishment from the server side.

```

context = GSS_C_NO_CONTEXT
output token = GSS_C_NO_BUFFER

do

    receive an input token from the initiator

    call gss_accept_sec_context(context, cred handle, input token,
                               output token, other args...)

    if (there's an output token to send to the initiator)
        send the output token to the initiator
        release the output token

    if (there's a GSS-API error)
        delete the context

until the context is complete

```

A real loop would be more complete with more extensive error-checking. See [“Establishing a Security Context With the Server” on page 103](#) for a real example of such a context-acceptance loop. Additionally, the `gss_accept_sec_context()` man page provides an example.

Again, GSS-API does not send or receive tokens. Tokens must be handled by the application. Examples of token-transferring functions are found in [“Miscellaneous GSS-API Sample Functions” on page 234](#).

`gss_accept_sec_context()` returns `GSS_S_COMPLETE` if it completes successfully. If the context is not complete, the function returns `GSS_S_CONTINUE_NEEDED`. If errors occur, the function returns error codes. For more information, see the `gss_accept_sec_context(3GSS)` man page.

Using Other Context Services in GSS-API

The `gss_init_sec_context()` function enables an application to request additional data protection services beyond basic context establishment. These services are requested through the `req_flags` argument to `gss_init_sec_context()`.

Not all mechanisms offer all these services. The `ret_flags` argument for `gss_init_sec_context()` indicates which services are available in a given context. Similarly, the context acceptor examines the `ret_flags` value that is returned by `gss_accept_sec_context()` to determine the available services. The additional services are explained in the following sections.

Delegating a Credential in GSS-API

If permitted, a context initiator can request that the context acceptor act as a proxy. In such a case, the acceptor can initiate further contexts on behalf of the initiator.

Suppose someone on System A wants to `rlogin` to System B, and then `rlogin` from System B to System C. Depending on the mechanism, the delegated credential identifies B either as A or B as proxy for A.

If delegation is permitted, `ret_flags` can be set to `GSS_C_DELEG_FLAG`. The acceptor receives a delegated credential as the `delegated_cred_handle` argument of `gss_accept_sec_context()`. Delegating a credential is not the same as exporting a context. See [“Exporting and Importing Contexts in GSS-API” on page 87](#). One difference is that an application can delegate that application's credentials multiple times simultaneously, while a context can only be held by one process at a time.

Performing Mutual Authentication Between Peers in GSS-API

A user who transfers files to an `ftp` site typically does not need proof of the site's identity. On the other hand, a user who is required to provide a credit card number to an application would

want definite proof of the receiver's identity. In such a case, *mutual authentication* is required. Both the context initiator and the acceptor must prove their identities.

A context initiator can request mutual authentication by setting the `gss_init_sec_context()` *req_flags* argument to the value `GSS_C_MUTUAL_FLAG`. If mutual authentication has been authorized, the function indicates authorization by setting the *ret_flags* argument to this value. If mutual authentication is requested but not available, the initiating application is responsible for responding accordingly. GSS-API does not automatically terminate a context when mutual authentication is requested but unavailable. Also, some mechanisms always perform mutual authentication even without a specific request.

Performing Anonymous Authentication in GSS-API

In normal use of GSS-API, the initiator's identity is made available to the acceptor as a part of context establishment. However, a context initiator can request that its identity not be revealed to the context acceptor.

For example, consider an application that provides unrestricted access to a medical database. A client of such a service might want to authenticate the service. This approach would establish trust in any information that is retrieved from the database. The client might not want to expose its identity due to privacy concerns, for example.

To request anonymity, set the *req_flags* argument of `gss_init_sec_context()` to `GSS_C_ANON_FLAG`. To verify whether anonymity is available, check the *ret_flags* argument to `gss_init_sec_context()` or `gss_accept_sec_context()` to see whether `GSS_C_ANON_FLAG` is returned.

When anonymity is in effect, calling `gss_display_name()` on a client name that was returned by `gss_accept_sec_context()` or `gss_inquire_context()` produces a generic anonymous name.

Note - An application has the responsibility to take appropriate action if anonymity is requested but not permitted. GSS-API does not terminate a context in such a case.

Using Channel Bindings in GSS-API

For many applications, basic context establishment is sufficient to assure proper authentication of a context initiator. In cases where additional security is desired, GSS-API offers the use

of *channel bindings*. Channel bindings are tags that identify the particular data channel that is used. Specifically, channel bindings identify the origin and endpoint, that is, the initiator and acceptor of the context. Because the tags are specific to the originator and recipient applications, such tags offer more proof of a valid identity.

Channel bindings are pointed to by the `gss_channel_bindings_t` data type, which is a pointer to a `gss_channel_bindings_struct` structure as shown below.

```
typedef struct gss_channel_bindings_struct {
    OM_uint32      initiator_addrtype;
    gss_buffer_desc initiator_address;
    OM_uint32      acceptor_addrtype;
    gss_buffer_desc acceptor_address;
    gss_buffer_desc application_data;
} *gss_channel_bindings_t;
```

The first two fields are the address of the initiator and an address type that identifies the format in which the initiator's address is being sent. For example, *initiator_addrtype* might be sent to `GSS_C_AF_INET` to indicate that *initiator_address* is in the form of an Internet address, that is, an IP address. Similarly, the third and fourth fields indicate the address and address type of the acceptor. The final field, *application_data*, can be used by the application as needed. Set *application_data* to `GSS_C_NO_BUFFER` if *application_data* is not going to be used. If an application does not specify an address, that application should set the address type field to `GSS_C_AF_NULLADDR`. The “[Address Types for Channel Bindings](#)” on page 252 section has a list of valid address type values.

The address types indicate address families rather than specific addressing formats. For address families that contain several alternative address forms, the *initiator_address* and *acceptor_address* fields must contain sufficient information to determine which form is used. When not otherwise specified, addresses should be specified in network byte-order, that is, native byte-ordering for the address family.

To establish a context that uses channel bindings, the *input_chan_bindings* argument for `gss_init_sec_context()` should point to an allocated channel bindings structure. The structure's fields are concatenated into an octet string, and a MIC is derived. This MIC is then bound to the output token. The application then sends the token to the context acceptor. After receiving the token, the acceptor calls `gss_accept_sec_context()`. See “[Accepting a Context in GSS-API](#)” on page 82 for more information. `gss_accept_sec_context()` calculates a MIC for the received channel bindings. `gss_accept_sec_context()` then returns `GSS_C_BAD_BINDINGS` if the MIC does not match.

Because `gss_accept_sec_context()` returns the transmitted channel bindings, an acceptor can use these values to perform security checking. For example, the acceptor could check the value of *application_data* against code words that are kept in a secure database.

Note - An underlying mechanism might not provide confidentiality for channel binding information. Therefore, an application should not include sensitive information as part of channel bindings unless confidentiality is ensured. To test for confidentiality, an application can check the *ret_flags* argument of `gss_init_sec_context()` or `gss_accept_sec_context()`. The values `GSS_C_CONF_FLAG` and `GSS_C_PROT_READY_FLAG` indicate confidentiality. See [“Initiating a Context in GSS-API” on page 80](#) or [“Accepting a Context in GSS-API” on page 82](#) for information about *ret_flags*.

Individual mechanisms can impose additional constraints on the addresses and address types that appear in channel bindings. For example, a mechanism might verify that the *initiator_address* field of the channel bindings to be returned to `gss_init_sec_context()`. Portable applications should therefore provide the correct information for the address fields. If the correct information cannot be determined, then `GSS_C_AF_NULLADDR` should be specified as the address types.

Exporting and Importing Contexts in GSS-API

GSS-API provides the means for exporting and importing contexts. This ability enables a multiprocess application, usually the context acceptor, to transfer a context from one process to another. For example, an acceptor might have one process that listens for context initiators and another that uses the data that is sent in the context. The [“Using the `test_import_export_context\(\)` Function” on page 130](#) section shows how a context can be saved and restored with these functions.

The function `gss_export_sec_context()` creates an interprocess token that contains information about the exported context. See [“Interprocess Tokens in GSS-API” on page 77](#) for more information. The buffer to receive the token should be set to `GSS_C_NO_BUFFER` before `gss_export_sec_context()` is called.

The application then passes the token on to the other process. The new process accepts the token and passes that token to `gss_import_sec_context()`. The same functions that are used to pass tokens between applications can often be used to pass tokens between processes as well.

Only one instantiation of a security process can exist at a time. `gss_export_sec_context()` deactivates the exported context and sets the context handle to `GSS_C_NO_CONTEXT`. `gss_export_sec_context()` also deallocates any process-wide resources that are associated with that context. If the context exportation cannot be completed, `gss_export_sec_context()` leaves the existing security context unchanged and does not return an interprocess token.

Not all mechanisms permit contexts to be exported. An application can determine whether a context can be exported by checking the *ret_flags* argument to `gss_accept_sec_context()` or `gss_init_sec_context()`. If this flag is set to `GSS_C_TRANS_FLAG`, then the context can be

exported. (See “Accepting a Context in GSS-API” on page 82 and “Initiating a Context in GSS-API” on page 80.)

Figure 7, “Exporting Contexts: Multithreaded Acceptor Example,” on page 88 shows how a multiprocess acceptor might use context exporting to multitask. In this case, Process 1 receives and processes tokens. This step separates the context-level tokens from the data tokens and passes the tokens on to Process 2. Process 2 deals with data in an application-specific way. In this illustration, the clients have already obtained export tokens from `gss_init_sec_context()`. The clients pass the tokens to a user-defined function, `send_a_token()`, which indicates whether the token to be transmitted is a context-level token or a message token. `send_a_token()` transmits the tokens to the server. Although not shown here, `send_a_token()` would presumably be used to pass tokens between threads as well.

FIGURE 7 Exporting Contexts: Multithreaded Acceptor Example

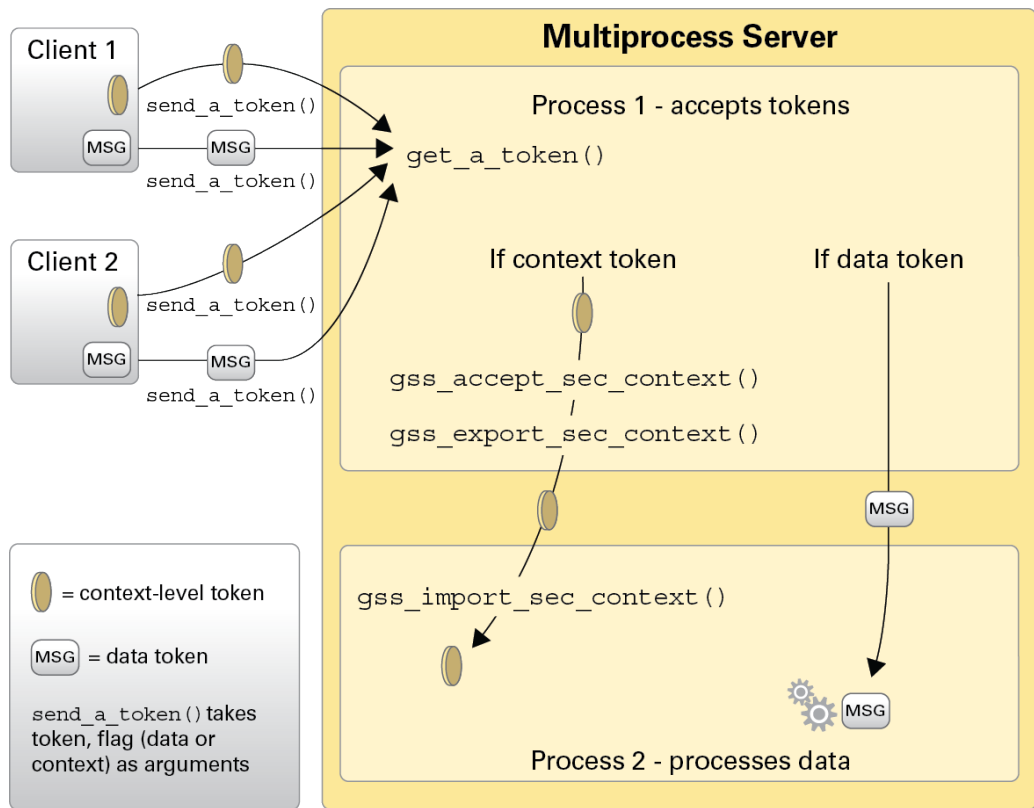

Obtaining Context Information in GSS-API

GSS-API provides a function, `gss_inquire_context(3GSS)`, that obtains information about a given security context. Note that the context does not need to be complete.

Given a context handle, `gss_inquire_context()` provides the following information about context:

- Name of the context initiator.
- Name of the context acceptor.
- Number of seconds for which the context is valid.
- Security mechanism to be used with the context.
- Several context-parameter flags. These flags are the same as the *ret_flags* argument of the `gss_accept_sec_context(3GSS)` function. The flags cover delegation, mutual authentication, and so on. See [“Accepting a Context in GSS-API” on page 82](#).
- A flag that indicates whether the inquiring application is the context initiator.
- A flag that indicates whether the context is fully established.

Sending Protected Data in GSS-API

After a context has been established between two peers, a message can be protected before that message is sent.

Establishing a context only uses the most basic GSS-API protection: *authentication*. Depending on the underlying security mechanisms, GSS-API provides two other levels of protection:

- **Integrity** – A message integrity code (MIC) for the message is generated by the `gss_get_mic()` function. The recipient checks the MIC to ensure that the received message is the same as the message that was sent.
- **Confidentiality** – In addition to using a MIC, the message is encrypted. The GSS-API function `gss_wrap()` performs the encryption.

The difference between `gss_get_mic()` and `gss_wrap()` is illustrated in the following diagram. With `gss_get_mic()`, the receiver gets a tag that indicates the message is intact. With `gss_wrap()`, the receiver gets an encrypted message and a tag.

FIGURE 8 `gss_get_mic()` versus `gss_wrap()`

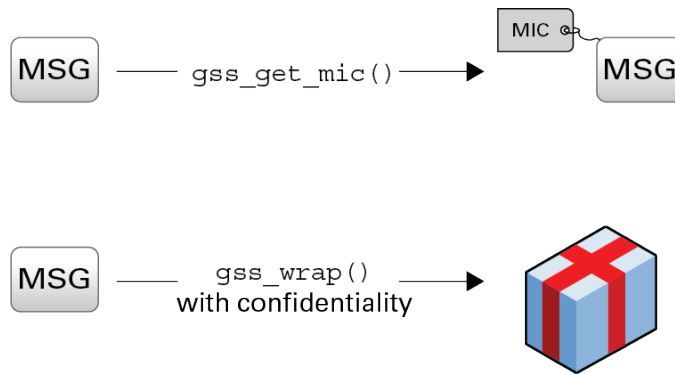

MIC = Message Integrity Code
 MSG = Message

The function to be used depends on the situation. Because `gss_wrap()` includes the integrity service, many programs use `gss_wrap()`. A program can test for the availability of the confidentiality service. The program can then call `gss_wrap()` with or without confidentiality depending on the availability. An example is [“Wrapping and Sending a Message” on page 109](#). However, because messages that use `gss_get_mic()` do not need to be unwrapped, fewer CPU cycles are used than with `gss_wrap()`. Thus a program that does not need confidentiality might protect messages with `gss_get_mic()`.

Tagging Messages With `gss_get_mic()`

Programs can use `gss_get_mic()` to add a cryptographic MIC to a message. The recipient can check the MIC for a message by calling `gss_verify_mic()`.

In contrast to `gss_wrap()`, `gss_get_mic()` produces separate output for the message and the MIC. This separation means that a sender application must arrange to send both the message and the accompanying MIC. More significantly, the recipient must be able to distinguish between the message and the MIC.

The following approaches ensure the proper processing of message and MIC:

- Through program control, that is, state. A recipient application might know to call the receiving function twice, once to get a message and a second time to get the message's MIC.
- Through flags. The sender and receiver can flag the kind of token that is included.
- Through user-defined token structures that include both the message and the MIC.

GSS_S_COMPLETE is returned if `gss_get_mic()` completes successfully. If the specified QOP is not valid, GSS_S_BAD_QOP is returned. For more information, see `gss_get_mic(3GSS)`.

Wrapping Messages With `gss_wrap()`

Messages can be wrapped by the `gss_wrap()` function. Like `gss_get_mic()`, `gss_wrap()` provides a MIC. `gss_wrap()` also encrypts a given message if confidentiality is requested and permitted by the underlying mechanism. The message receiver unwraps the message with `gss_unwrap()`.

Unlike `gss_get_mic()`, `gss_wrap()` wraps the message and the MIC together in the outgoing message. The function that transmits the bundle need be called only once. On the other end, `gss_unwrap()` extracts the message. The MIC is not visible to the application.

`gss_wrap()` returns GSS_S_COMPLETE if the message was successfully wrapped. If the requested QOP is not valid, GSS_S_BAD_QOP is returned. For an example of `gss_wrap()`, see [“Wrapping and Sending a Message” on page 109](#).

Handling Wrap Size Issues in GSS-API

Wrapping a message with `gss_wrap()` increases the amount of data to be sent. Because the protected message packet needs to fit through a given transportation protocol, GSS-API provides the function `gss_wrap_size_limit()`. `gss_wrap_size_limit()` calculates the maximum size of a message that can be wrapped without becoming too large for the protocol. The application can break up messages that exceed this size before calling `gss_wrap()`. Always check the wrap-size limit before actually wrapping the message.

The amount of the size increase depends on two factors:

- Which QOP algorithm is used for making the transformation
- Whether confidentiality is invoked

The default QOP can vary from one implementation of GSS-API to another. Thus, a wrapped message can vary in size even if the QOP default is specified. This possibility is illustrated in the following figure.

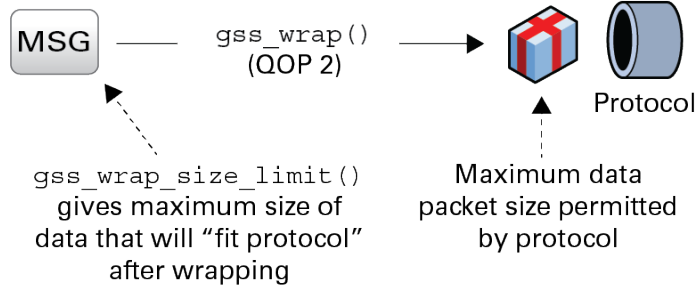
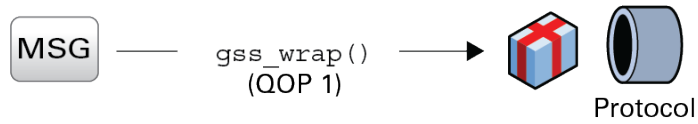

QOP = Quality of Protection
(protection algorithm)

Regardless of whether confidentiality is applied, `gss_wrap()` still increases the size of a message. `gss_wrap()` embeds a MIC into the transmitted message. However, encrypting the message can further increase the size. The following figure shows this process.

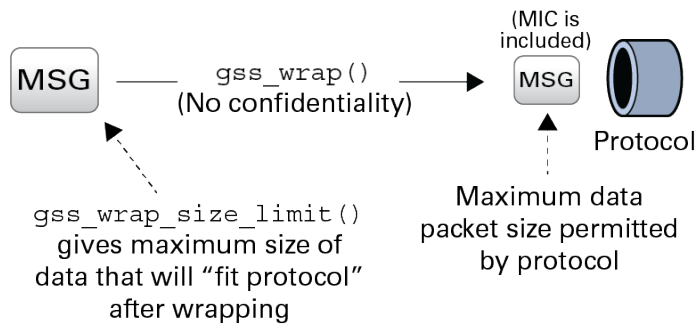
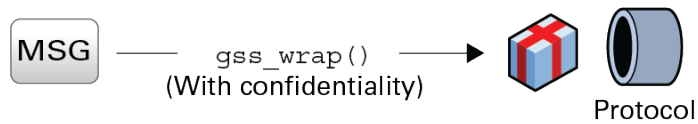

GSS_S_COMPLETE is returned if `gss_wrap_size_limit()` completes successfully. If the specified QOP is not valid, GSS_S_BAD_QOP is returned. “[Wrapping and Sending a Message](#)” on page 109 includes an example of how `gss_wrap_size_limit()` can be used to return the maximum original message size.

Successful completion of this call does not necessarily guarantee that `gss_wrap()` can protect a message of length *max-input-size* bytes. This ability depends on the availability of system resources at the time that `gss_wrap()` is called. For more information, see the `gss_wrap_size_limit(3GSS)` man page.

Detecting Sequence Problems in GSS-API

As a context initiator transmits sequential data packets to the acceptor, some mechanisms allow the context acceptor to check for proper sequencing. These checks include whether the packets arrive in the right order, and with no unwanted duplication of packets. See following figure. An acceptor checks for these two conditions during the verification of a packet and the unwrapping of a packet. See “[Unwrapping the Message](#)” on page 129 for more information.

FIGURE 9 Message Replay and Message Out-of-Sequence

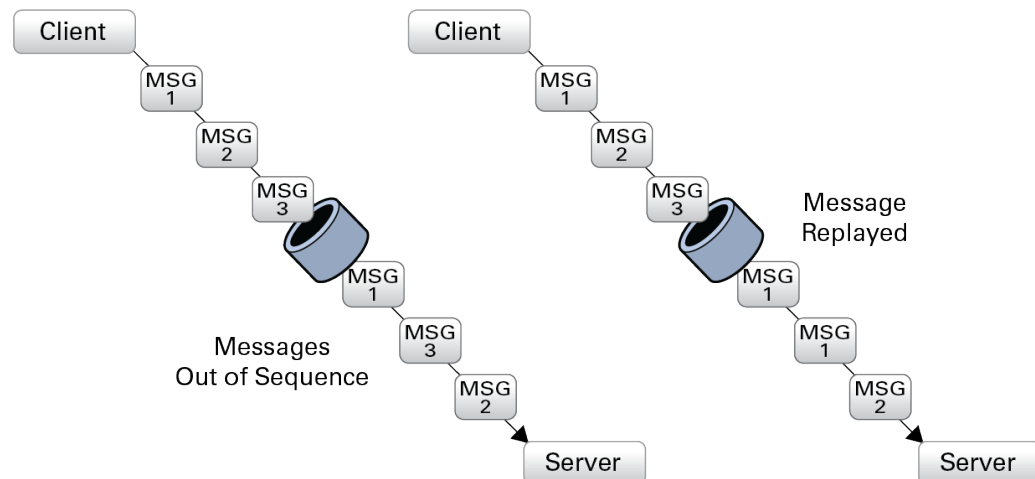

With `gss_init_sec_context()`, an initiator can check the sequence by applying logical OR to the *req_flags* argument with either GSS_C_REPLAY_FLAG or GSS_C_SEQUENCE_FLAG.

Confirming Message Transmission in GSS-API

After the recipient has unwrapped or verified the transmitted message, a confirmation can be returned to the sender. This means sending back a MIC for that message. Consider the case of a message that was not wrapped by the sender but only tagged with a MIC with `gss_get_mic()`.

The process, illustrated in [Figure 10, “Confirming MIC Data,” on page 95](#), is as follows:

1. The initiator tags the message with `gss_get_mic()`.
2. The initiator sends the message and MIC to the acceptor.
3. The acceptor verifies the message with `gss_verify_mic()`.
4. The acceptor sends the MIC back to the initiator.
5. The initiator verifies the received MIC against the original message with `gss_verify_mic()`.

FIGURE 10 Confirming MIC Data

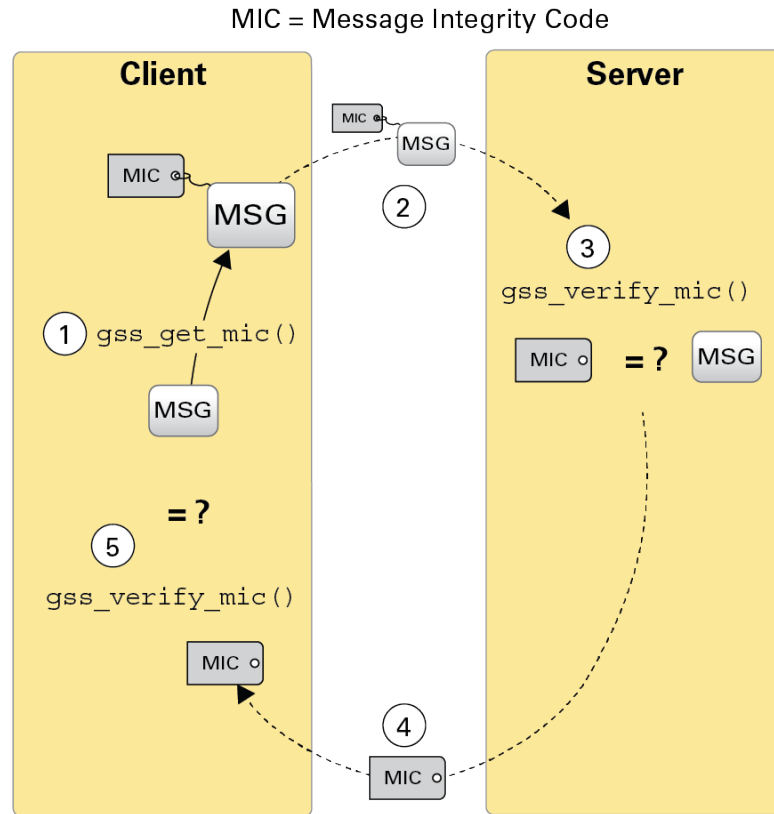

In the case of wrapped data, the `gss_unwrap()` function never produces a separate MIC, so the recipient must generate it from the received and unwrapped message.

The process, illustrated in [Figure 11, “Confirming Wrapped Data,”](#) on page 96, is as follows:

1. The initiator wraps the message with `gss_wrap()`.
2. The initiator sends the wrapped message.
3. The acceptor unwraps the message with `gss_unwrap()`.
4. The acceptor calls `gss_get_mic()` to produce a MIC for the unwrapped message.
5. The acceptor sends the derived MIC to the initiator.

6. The initiator compares the received MIC against the original message with `gss_verify_mic()`.

Applications should deallocate any data space that has been allocated for GSS-API data. The relevant functions are `gss_release_buffer(3GSS)`, `gss_release_cred(3GSS)`, `gss_release_name(3GSS)`, and `gss_release_oid_set(3GSS)`.

FIGURE 11 Confirming Wrapped Data

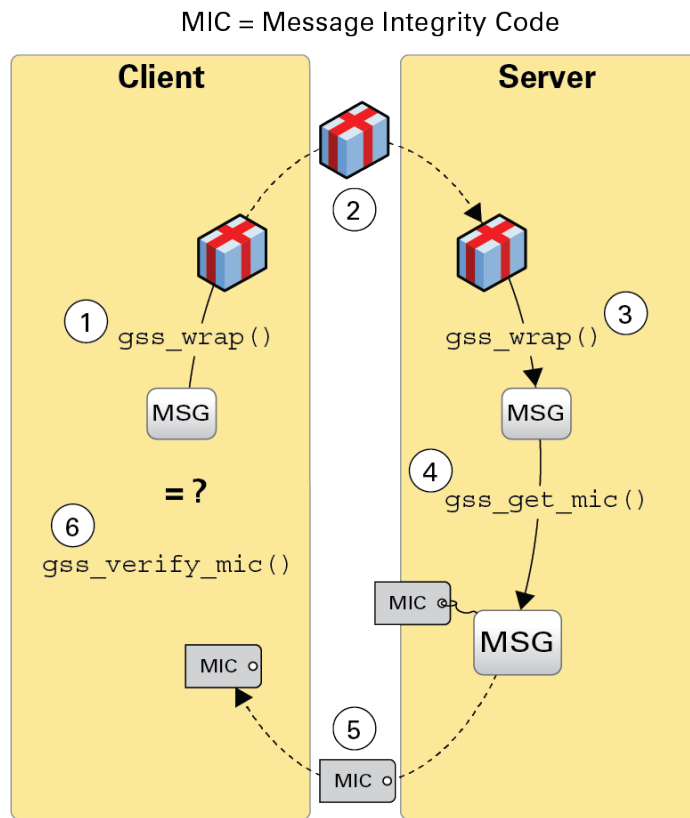

Cleaning Up a GSS-API Session

Finally, all messages have been sent and received, and the initiator and acceptor applications have finished. At this point, both applications should call `gss_delete_sec_context()` to destroy the shared context. `gss_delete_sec_context()` deletes local data structures that are associated with the context.

For good measure, applications should be sure to deallocate any data space that has been allocated for GSS-API data. The functions that do this are `gss_release_buffer()`, `gss_release_cred()`, `gss_release_name()`, and `gss_release_oid_set()`.

GSS-API Client Example

This chapter presents a walk-through of a typical GSS-API client application.

The following topics are covered:

- “GSSAPI Client Example Overview” on page 99
- “GSSAPI Client Example: `main()` Function” on page 100
- “Opening a Connection With the Server” on page 102
- “Establishing a Security Context With the Server” on page 103
- “Miscellaneous GSSAPI Context Operations on the Client Side” on page 108
- “Wrapping and Sending a Message” on page 109
- “Reading and Verifying a Signature Block From a GSS-API Client” on page 112
- “Deleting the Security Context” on page 113

GSSAPI Client Example Overview

The sample client-side program `gss-client` creates a security context with a server, establishes security parameters, and sends the *message* string to the server. The program uses a simple TCP-based sockets connection to make the connection.

The following sections provide a step-by-step description of how `gss-client` works. Because `gss-client` is a sample program that has been designed to show off GSSAPI functionality, only relevant parts of the program are discussed in detail.

GSSAPI Client Example Structure

The `gss-client` application performs the following steps:

1. Parses the command line.
2. Creates an object ID (OID) for a mechanism, if a mechanism is specified. Otherwise, the default mechanism is used, which is most commonly the case.

3. Creates a connection to the server.
4. Establishes a security context.
5. Wraps and sends the message.
6. Verifies that the message has been “signed” correctly by the server.
7. Deletes the security context.

Running the GSSAPI Client Example

The `gss-client` example takes this form on the command line:

```
gss-client [-port port] [-d] [-mech mech] host service-name [-f] msg
```

- `port` – The port number for making the connection to the remote system that is specified by `host`.
- `-d` flag – Causes security credentials to be delegated to the server. Specifically, the `deleg-flag` variable is set to the GSS-API value `GSS_C_DELEG_FLAG`. Otherwise, `deleg-flag` is set to zero.
- `mech` – The name of the security mechanism, such as Kerberos v5 to be used. If no mechanism is specified, the GSS-API uses a default mechanism.
- `host` – The name of the server.
- `service-name` – The name of the network service requested by the client. Some typical examples are the `ftp` and `login` services.
- `msg` – The string to send to the server as protected data. If the `-f` option is specified, then `msg` is the name of a file from which to read the string.

A typical command line for client application program might look like the following example:

```
$ gss-client -port 8080 -d -mech kerberos_v5 erebos.eng nfs "ls"
```

The following example does not specify a mechanism, port, or delegation:

```
% gss-client erebos.eng nfs "ls"
```

GSSAPI Client Example: `main()` Function

As with all C programs, the outer shell of the program is contained in the entry-point function, `main()`. `main()` performs four functions:

- Parses command-line arguments and assigns the arguments to variables.

- Calls `parse_oid()` to create a GSS-API OID, object identifier, if a mechanism other than the default is to be used. The object identifier comes from the name of the security mechanism, provided that a mechanism name has been supplied.
- Calls `call_server()`, which does the actual work of creating a context and sending data.
- Releases the storage space for the OID if necessary, after the data is sent.

The source code for the `main()` routine is shown in the following example.

EXAMPLE 13 gss-client Example: main()

```
int main(argc, argv)
    int argc;
    char **argv;
{
    char *msg;
    char service_name[128];
    char hostname[128];
    char *mechanism = 0;
    u_short port = 4444;
    int use_file = 0;
    OM_uint32 deleg_flag = 0, min_stat;

    display_file = stdout;

    /* Parse command-line arguments. */

    argc--; argv++;
    while (argc) {
        if (strcmp(*argv, "-port") == 0) {
            argc--; argv++;
            if (!argc) usage();
            port = atoi(*argv);
        } else if (strcmp(*argv, "-mech") == 0) {
            argc--; argv++;
            if (!argc) usage();
            mechanism = *argv;
        } else if (strcmp(*argv, "-d") == 0) {
            deleg_flag = GSS_C_DELEG_FLAG;
        } else if (strcmp(*argv, "-f") == 0) {
            use_file = 1;
        } else
            break;
        argc--; argv++;
    }
    if (argc != 3)
        usage();
}
```

```
if (argc > 1) {
    strcpy(hostname, argv[0]);
} else if (gethostname(hostname, sizeof(hostname)) == -1) {
    perror("gethostname");
    exit(1);
}

if (argc > 2) {
    strcpy(service_name, argv[1]);
    strcat(service_name, "@");
    strcat(service_name, hostname);
}

msg = argv[2];

/* Create GSSAPI object ID. */
if (mechanism)
    parse_oid(mechanism, &g_mechOid);

/* Call server to create context and send data. */
if (call_server(hostname, port, g_mechOid, service_name,
    deleg_flag, msg, use_file) < 0)
    exit(1);

/* Release storage space for OID, if still allocated */
if (g_mechOid != GSS_C_NULL_OID)
    (void) gss_release_oid(&min_stat, &gmechOid);

return 0;
}
```

Opening a Connection With the Server

The `call_server()` function uses the following code to make the connection with the server:

```
if ((s = connect_to_server(host, port)) < 0)
    return -1;
```

`s` is a file descriptor, the `int` that is initially returned by a call to `socket()`.

`connect_to_server()` is a simple function outside GSS-API that uses sockets to create a connection. The source code for `connect_to_server()` is shown in the following example.

EXAMPLE 14 connect_to_server() Function

```

int connect_to_server(host, port)
    char *host;
    u_short port;
{
    struct sockaddr_in saddr;
    struct hostent *hp;
    int s;

    if ((hp = gethostbyname(host)) == NULL) {
        fprintf(stderr, "Unknown host: %s\n", host);
        return -1;
    }

    saddr.sin_family = hp->h_addrtype;
    memcpy((char *)&saddr.sin_addr, hp->h_addr, sizeof(saddr.sin_addr));
    saddr.sin_port = htons(port);

    if ((s = socket(AF_INET, SOCK_STREAM, 0)) < 0) {
        perror("creating socket");
        return -1;
    }
    if (connect(s, (struct sockaddr *)&saddr, sizeof(saddr)) < 0) {
        perror("connecting to server");
        (void) close(s);
        return -1;
    }

    return s;
}

```

Establishing a Security Context With the Server

After the connection is made, `call_server()` uses the function `client_establish_context()` to create the security context, as follows:

```

if (client_establish_context(s, service-name, deleg-flag, oid, &context,
                            &ret-flags) < 0) {
    (void) close(s);
    return -1;
}

```

- `s` is a file descriptor that represents the connection that is established by `connect_to_server()`.

- *service-name* is the requested network service.
- *deleg-flag* specifies whether the server can act as a proxy for the client.
- *oid* is the mechanism.
- *context* is the context to be created.
- *ret-flags* is an `int` that specifies any flags to be returned by the GSS-API function `gss_init_sec_context()`.

The `client_establish_context()` performs the following tasks:

- Translates the service name into internal GSSAPI format
- Performs a loop of token exchanges between the client and the server until the security context is complete

Translating a Service Name into GSS-API Format

The first task that `client_establish_context()` performs is to translate the service name string to internal GSS-API format by using `gss_import_name()`.

EXAMPLE 15 `client_establish_context()` – Translate Service Name

```
/*
 * Import the name into target_name. Use send_tok to save
 * local variable space.
 */

send_tok.value = service_name;
send_tok.length = strlen(service_name) + 1;
maj_stat = gss_import_name(&min_stat, &send_tok,
                          (gss_OID) GSS_C_NT_HOSTBASED_SERVICE, &target_name);
if (maj_stat != GSS_S_COMPLETE) {
    display_status("parsing name", maj_stat, min_stat);
    return -1;
}
```

`gss_import_name()` takes the name of the service, which is stored in an opaque GSS_API buffer `send_tok`, and converts the string to the GSS_API internal name `target_name`. `send_tok` is used to save space instead of declaring a new `gss_buffer_desc`. The third argument is a `gss_OID` type that indicates the `send_tok` name format. This example uses `GSS_C_NT_HOSTBASED_SERVICE`, which means a service of the format `service@host`. See [“Name Types” on page 251](#) for other possible values for this argument.

Establishing a Security Context for GSS-API

Once the service has been translated to GSS-API internal format, the context can be established. To maximize portability, establishing context should always be performed as a loop.

Before entering the loop, `client_establish_context()` initializes the context and the `token_ptr` parameter. There is a choice in the use of `token_ptr`. `token_ptr` can point either to `send_tok`, the token to be sent to the server, or to `recv_tok`, the token that is sent back by the server.

Inside the loop, two items are checked:

- The status that is returned by `gss_init_sec_context()`
The return status catches any errors that might require the loop to be aborted. `gss_init_sec_context()` returns `GSS_S_CONTINUE_NEEDED` if and only if the server has another token to send.
- The size of token to be sent to the server, which is generated by `gss_init_sec_context()`.
A token size of zero indicates that no more information exists that can be sent to the server and that the loop can be exited. The token size is determined from `token_ptr`.

The following pseudocode describes the loop:

```
do
  gss_init_sec_context()
  if no context was created
    exit with error;
  if the status is neither "complete" nor "in process"
    release the service namespace and exit with error;
  if there is a token to send to the server, that is, the size is nonzero
    send the token;
    if sending the token fails,
      release the token and service namespaces. Exit with error;
      release the namespace for the token that was just sent;
  if the context is not completely set up
    receive a token from the server;
while the context is not complete
```

The loop starts with a call to `gss_init_sec_context()`, which takes the following arguments:

- The status code to be set by the underlying mechanism.
- The credential handle. The example uses `GSS_C_NO_CREDENTIAL` to act as a default principal.
- `gss-context`, which represents the context handle to be created.
- `target-name` of the service, as a `GSS_API` internal name.
- `oid`, the ID for the mechanism.

- Request flags. In this case, the client requests that the server authenticate itself, that message-duplication be turned on, and that the server act as a proxy if requested.
- No time limit for the context.
- No request for channel bindings.
- `token_ptr`, which points to the token to be received from the server.
- The mechanism actually used by the server. The mechanism is set to `NULL` here because the application does not use this value.
- `&send_tok`, which is the token that `gss_init_sec_context()` creates to send to the server.
- Return flags. Set to `NULL` because they are ignored in this example.

Note - The client does not need to acquire credentials before initiating a context. On the client side, credential management is handled transparently by the GSS-API. That is, the GSS-API *knows* how to get credentials that are created by this mechanism for this principal. As a result, the application can pass `gss_init_sec_context()` a default credential. On the server side, however, a server application must explicitly acquire credentials for a service before accepting a context. See [“Acquiring Credentials” on page 119](#).

After checking that a context or part of one exists and that `gss_init_sec_context()` is returning valid status, `connect_to_server()` checks that `gss_init_sec_context()` has provided a token to send to the server. If no token is present, the server has signalled that no other tokens are needed. If a token has been provided, then that token must be sent to the server. If sending the token fails, the namespaces for the token and service cannot be determined, and `connect_to_server()` exits. The following algorithm checks for the presence of a token by looking at the length:

```
if (send_tok_length != 0) {
    if (send_token(s, &send_tok) < 0) {
        (void) gss_release_buffer(&min_stat, &send_tok);
        (void) gss_release_name(&min_stat, &target_name);
        return -1;
    }
}
```

`send_token()` is not a GSS-API function and needs to be written by the user. The `send_token()` function writes a token to the file descriptor. `send_token()` returns 0 on success and -1 on failure. GSS-API does not send or receive tokens itself. The calling applications are responsible for sending and receiving any tokens that have been created by GSS-API.

The source code for the context establishment loop is provided below.

EXAMPLE 16 Loop for Establishing Contexts

```
/*
```

```

* Perform the context establishment loop.
*
* On each pass through the loop, token_ptr points to the token
* to send to the server (or GSS_C_NO_BUFFER on the first pass).
* Every generated token is stored in send_tok which is then
* transmitted to the server; every received token is stored in
* rcv_tok, which token_ptr is then set to, to be processed by
* the next call to gss_init_sec_context.
*
* GSS-API guarantees that send_tok's length will be non-zero
* if and only if the server is expecting another token from us,
* and that gss_init_sec_context returns GSS_S_CONTINUE_NEEDED if
* and only if the server has another token to send us.
*/

token_ptr = GSS_C_NO_BUFFER;
*gss_context = GSS_C_NO_CONTEXT;
123456789012345678901234567890123456789012345678901234567890123456

do {
    maj_stat =
        gss_init_sec_context(&min_stat, GSS_C_NO_CREDENTIAL,
            gss_context, target_name, oid,
            GSS_C_MUTUAL_FLAG | GSS_C_REPLAY_FLAG | deleg_flag,
            0, NULL, /* no channel bindings */
            token_ptr, NULL, /* ignore mech type */
            &send_tok, ret_flags, NULL); /* ignore time_rec */
    if (gss_context == NULL){
        printf("Cannot create context\n");
        return GSS_S_NO_CONTEXT;
    }
    if (token_ptr != GSS_C_NO_BUFFER)
        (void) gss_release_buffer(&min_stat, &rcv_tok);
    if (maj_stat!=GSS_S_COMPLETE && maj_stat!=GSS_S_CONTINUE_NEEDED) {
        display_status("initializing context", maj_stat, min_stat);
        (void) gss_release_name(&min_stat, &target_name);
        return -1;
    }

    if (send_tok.length != 0){
        fprintf(stdout, "Sending init_sec_context token (size=%ld)...",
            send_tok.length);
        if (send_token(s, &send_tok) < 0) {
            (void) gss_release_buffer(&min_stat, &send_tok);
            (void) gss_release_name(&min_stat, &target_name);
            return -1;
        }
    }
}

```

```
(void) gss_release_buffer(&min_stat, &send_tok);

if (maj_stat == GSS_S_CONTINUE_NEEDED) {
    fprintf(stdout, "continue needed...");
    if (recv_token(s, &recv_tok) < 0) {
        (void) gss_release_name(&min_stat, &target_name);
        return -1;
    }
    token_ptr = &recv_tok;
}
printf("\n");
} while (maj_stat == GSS_S_CONTINUE_NEEDED);
```

For more information about how `send_token()` and `recv_token()` work, see [“Miscellaneous GSS-API Sample Functions” on page 234](#).

Miscellaneous GSSAPI Context Operations on the Client Side

As a sample program, `gss-client` performs some functions for demonstration purposes. The following source code is not essential for the basic task, but is provided to demonstrate these other operations:

- Saving and restoring the context
- Displaying context flags
- Obtaining the context status

The source code for these operations is shown in the following example.

EXAMPLE 17 `gss-client: call_server()` Establish Context

```
/* Save and then restore the context */
maj_stat = gss_export_sec_context(&min_stat,
                                &context,
                                &context_token);

if (maj_stat != GSS_S_COMPLETE) {
    display_status("exporting context", maj_stat, min_stat);
    return -1;
}

maj_stat = gss_import_sec_context(&min_stat,
                                &context_token,
                                &context);

if (maj_stat != GSS_S_COMPLETE) {
```

```

        display_status("importing context", maj_stat, min_stat);
        return -1;
    }
    (void) gss_release_buffer(&min_stat, &context_token);

    /* display the flags */
    display_ctx_flags(ret_flags);

    /* Get context information */
    maj_stat = gss_inquire_context(&min_stat, context,
                                   &src_name, &targ_name, &lifetime,
                                   &mechanism, &context_flags,
                                   &is_local,
                                   &is_open);
    if (maj_stat != GSS_S_COMPLETE) {
        display_status("inquiring context", maj_stat, min_stat);
        return -1;
    }

    if (maj_stat == GSS_S_CONTEXT_EXPIRED) {
        printf(" context expired\n");
        display_status("Context is expired", maj_stat, min_stat);
        return -1;
    }
}

```

Wrapping and Sending a Message

The `gss-client` application needs to wrap, that is, encrypt the data before the data can be sent. The application goes through the following steps to wrap the message:

- Determines the wrap size limit. This process ensures that the wrapped message can be accommodated by the protocol.
- Obtains the source and destination names. Translates the names from object identifiers to strings.
- Gets the list of mechanism names. Translates the names from object identifiers to strings.
- Inserts the message into a buffer and wraps the message.
- Sends the message to the server.

The following source code wraps a message.

EXAMPLE 18 `gss-client` Example: `call_server()` – Wrap Message

```
/* Test gss_wrap_size_limit */
```

```
maj_stat = gss_wrap_size_limit(&min_stat, context, conf_req_flag,
    GSS_C_QOP_DEFAULT, req_output_size, &max_input_size);
if (maj_stat != GSS_S_COMPLETE) {
    display_status("wrap_size_limit call", maj_stat, min_stat);
} else
    fprintf(stderr, "gss_wrap_size_limit returned "
        "max input size = %d \n"
        "for req_output_size = %d with Integrity only\n",
        max_input_size, req_output_size, conf_req_flag);

conf_req_flag = 1;
maj_stat = gss_wrap_size_limit(&min_stat, context, conf_req_flag,
    GSS_C_QOP_DEFAULT, req_output_size, &max_input_size);
if (maj_stat != GSS_S_COMPLETE) {
    display_status("wrap_size_limit call", maj_stat, min_stat);
} else
    fprintf(stderr, "gss_wrap_size_limit returned "
        " max input size = %d \n" "for req_output_size = %d with "
        "Integrity & Privacy \n", max_input_size, req_output_size );

maj_stat = gss_display_name(&min_stat, src_name, &sname, &name_type);
if (maj_stat != GSS_S_COMPLETE) {
    display_status("displaying source name", maj_stat, min_stat);
    return -1;
}

maj_stat = gss_display_name(&min_stat, targ_name, &tname,
    (gss_OID *) NULL);
if (maj_stat != GSS_S_COMPLETE) {
    display_status("displaying target name", maj_stat, min_stat);
    return -1;
}
fprintf(stderr, "\\\"%.*s\\\" to \\\"%.*s\\\", lifetime %u, flags %x, %s, %s\n",
    (int) sname.length, (char *) sname.value, (int) tname.length,
    (char *) tname.value, lifetime, context_flags,
    (is_local) ? "locally initiated" : "remotely initiated",
    (is_open) ? "open" : "closed");

(void) gss_release_name(&min_stat, &src_name);
(void) gss_release_name(&min_stat, &targ_name);
(void) gss_release_buffer(&min_stat, &sname);
(void) gss_release_buffer(&min_stat, &tname);

maj_stat = gss_oid_to_str(&min_stat, name_type, &oid_name);
if (maj_stat != GSS_S_COMPLETE) {
    display_status("converting oid->string", maj_stat, min_stat);
    return -1;
}
}
```

```

fprintf(stderr, "Name type of source name is %.*s.\n", (int) oid_name.length,
        (char *) oid_name.value);
(void) gss_release_buffer(&min_stat, &oid_name);

/* Now get the names supported by the mechanism */
maj_stat = gss_inquire_names_for_mech(&min_stat, mechanism, &mech_names);
if (maj_stat != GSS_S_COMPLETE) {
    display_status("inquiring mech names", maj_stat, min_stat);
    return -1;
}

maj_stat = gss_oid_to_str(&min_stat, mechanism, &oid_name);
if (maj_stat != GSS_S_COMPLETE) {
    display_status("converting oid->string", maj_stat, min_stat);
    return -1;
}
mechStr = (char *)__gss_oid_to_mech(mechanism);
fprintf(stderr, "Mechanism %.*s (%s) supports %d names\n", (int) oid_name.length,
        (char *) oid_name.value, (mechStr == NULL ? "NULL" : mechStr),
        mech_names->count);
(void) gss_release_buffer(&min_stat, &oid_name);

for (i=0; i < mech_names->count; i++) {
    maj_stat = gss_oid_to_str(&min_stat, &mech_names->elements[i], &oid_name);
    if (maj_stat != GSS_S_COMPLETE) {
        display_status("converting oid->string", maj_stat, min_stat);
        return -1;
    }
    fprintf(stderr, "  %d: %.*s\n", i, (int) oid_name.length, (
        char *) oid_name.value);

    (void) gss_release_buffer(&min_stat, &oid_name);
}
(void) gss_release_oid_set(&min_stat, &mech_names);

if (use_file) {
    read_file(msg, &in_buf);
} else {
    /* Wrap the message */
    in_buf.value = msg;
    in_buf.length = strlen(msg) + 1;
}

if (ret_flag & GSS_C_CONF_FLAG) {
    state = 1;
} else {
    state = 0;
}

```

```
maj_stat = gss_wrap(&min_stat, context, 1, GSS_C_QOP_DEFAULT, &in_buf,
    &state, &out_buf);
if (maj_stat != GSS_S_COMPLETE) {
    display_status("wrapping message", maj_stat, min_stat);
    (void) close(s);
    (void) gss_delete_sec_context(&min_stat, &context, GSS_C_NO_BUFFER);
    return -1;
} else if (! state) {
    fprintf(stderr, "Warning! Message not encrypted.\n");
}

/* Send to server */
if (send_token(s, &out_buf) < 0) {
    (void) close(s);
    (void) gss_delete_sec_context(&min_stat, &context, GSS_C_NO_BUFFER);
    return -1;
}
(void) gss_release_buffer(&min_stat, &out_buf);
```

Reading and Verifying a Signature Block From a GSS-API Client

The `gss-client` program can now test the validity of the message that was sent. The server returns the MIC for the message that was sent. The message can be retrieved with the `recv_token()`.

The `gss_verify_mic()` function is then used to verify the message's *signature*, that is, the MIC. `gss_verify_mic()` compares the MIC that was received with the original, unwrapped message. The received MIC comes from the server's token, which is stored in `out_buf`. The MIC from the unwrapped version of the message is held in `in_buf`. If the two MICs match, the message is verified. The client then releases the buffer for the received token, `out_buf`.

The process of reading and verifying a signature block is demonstrated in the following source code.

EXAMPLE 19 gss-client Example – Read and Verify Signature Block

```
/* Read signature block into out_buf */
if (recv_token(s, &out_buf) < 0) {
    (void) close(s);
    (void) gss_delete_sec_context(&min_stat, &context, GSS_C_NO_BUFFER);
    return -1;
}
```



```

/* Verify signature block */
    maj_stat = gss_(&min_stat, context, &in_buf,
                   &out_buf, &qop_state);
    if (maj_stat != GSS_S_COMPLETE) {
        display_status("verifying signature", maj_stat, min_stat);
        (void) close(s);
        (void) gss_delete_sec_context(&min_stat, &context, GSS_C_NO_BUFFER);
        return -1;
    }
    (void) gss_release_buffer(&min_stat, &out_buf);

    if (use_file)
        free(in_buf.value);

    printf("Signature verified.\n");

```

Deleting the Security Context

The `call_server()` function finishes by deleting the context and returning to the `main()` function.

EXAMPLE 20 gss-client Example: `call_server()` – Delete Context

```

/* Delete context */
    maj_stat = gss_delete_sec_context(&min_stat, &context, &out_buf);
    if (maj_stat != GSS_S_COMPLETE) {
        display_status("deleting context", maj_stat, min_stat);
        (void) close(s);
        (void) gss_delete_sec_context(&min_stat, &context, GSS_C_NO_BUFFER);
        return -1;
    }

    (void) gss_release_buffer(&min_stat, &out_buf);
    (void) close(s);
    return 0;

```

GSS-API Server Example

This chapter presents a walk-through of the source code for the `gss-server` sample program. The following topics are covered:

- “GSSAPI Server Example Overview” on page 115
- “GSSAPI Server Example: `main()` Function” on page 116
- “Acquiring Credentials” on page 119
- “Checking for `inetd`” on page 122
- “Receiving Data From a Client” on page 122
- “Cleanup in the GSSAPI Server Example” on page 131

GSSAPI Server Example Overview

The sample server-side program `gss-server` works in conjunction with `gss-client`, which is described in the previous chapter. The basic purpose of `gss-server` is to receive, sign, and return the wrapped message from `gssapi-client`.

The following sections provide a step-by-step description of how `gss-server` works. Because `gss-server` is a sample program for demonstrating GSSAPI functionality, only relevant parts of the program are discussed in detail.

GSSAPI Server Example Structure

The `gss-structure` application performs the following steps:

1. Parses the command line.
2. If a mechanism is specified, translates the mechanism name to internal format.

3. Acquires credentials for the caller.
4. Checks to see whether the user has specified using the `inetd` daemon for connecting.
5. Makes a connection with the client.
6. Receives the data from the client.
7. Signs and returns the data.
8. Releases namespaces and exits.

Running the GSSAPI Server Example

`gss-server` takes this form on the command line:

```
gss-server [-port port] [-verbose] [-inetd] [-once] [-logfile file] \  
          [-mech mechanism] service-name
```

- `port` is the port number to listen on. If no port is specified, the program uses port 4444 as the default.
- `-verbose` causes messages to be displayed as `gss-server` runs.
- `-inetd` indicates that the program should use the `inetd` daemon to listen to a port. `-inetd` uses `stdin` and `stdout` to connect to the client.
- `-once` indicates a single-instance connection only.
- `mechanism` is the name of a security mechanism to use, such as Kerberos v5. If no mechanism is specified, the GSS-API uses a default mechanism.
- `service-name` is the name of the network service that is requested by the client, such as `ftp` or the `login` service.

A typical command line might look like the following example:

```
$ gss-server -port 8080 -once -mech kerberos_v5 erebos.eng nfs "hello"
```

GSSAPI Server Example: `main()` Function

The `gss-server main()` function performs the following tasks:

- Parses command-line arguments and assigns the arguments to variables
- Acquires the credentials for the service corresponding to the mechanism
- Calls the `sign_server()` function, which performs the work involved with signing and returning the message

- Releases the credentials that have been acquired
- Releases the mechanism OID namespace
- Closes the connection if the connection is still open

EXAMPLE 21 gss-server Example: main()

```

int
main(argc, argv)
    int argc;
    char **argv;
{
    char *service_name;
    gss_cred_id_t server_creds;
    OM_uint32 min_stat;
    u_short port = 4444;
    int s;
    int once = 0;
    int do_inetd = 0;

    log = stdout;
    display_file = stdout;

    /* Parse command-line arguments. */
    argc--; argv++;
    while (argc) {
        if (strcmp(*argv, "-port") == 0) {
            argc--; argv++;
            if (!argc) usage();
            port = atoi(*argv);
        } else if (strcmp(*argv, "-verbose") == 0) {
            verbose = 1;
        } else if (strcmp(*argv, "-once") == 0) {
            once = 1;
        } else if (strcmp(*argv, "-inetd") == 0) {
            do_inetd = 1;
        } else if (strcmp(*argv, "-logfile") == 0) {
            argc--; argv++;
            if (!argc) usage();
            log = fopen(*argv, "a");
            display_file = log;
            if (!log) {
                perror(*argv);
                exit(1);
            }
        } else
            break;
        argc--; argv++;
    }
}

```

```
    }
    if (argc != 1)
        usage();

    if ((*argv)[0] == '-')
        usage();

    service_name = *argv;

    /* Acquire service credentials. */
    if (server_acquire_creds(service_name, &server_creds) < 0)
        return -1;

    if (do_inetd) {
        close(1);
        close(2);
        /* Sign and return message. */
        sign_server(0, server_creds);
        close(0);
    } else {
        int stmp;

        if ((stmp = create_socket(port)) >= 0) {
            do {
                /* Accept a TCP connection */
                if ((s = accept(stmp, NULL, 0)) < 0) {
                    perror("accepting connection");
                    continue;
                }
                /* This return value is not checked, because there is
                 not really anything to do if it fails. */
                sign_server(s, server_creds);
                close(s);
            } while (!once);

            close(stmp);
        }
    }

    /* Close down and clean up. */
    (void) gss_release_cred(&min_stat, &server_creds);

    /*NOTREACHED*/
    (void) close(s);
    return 0;
}
```

Acquiring Credentials

Credentials are created by the underlying mechanisms rather than by the client application, server application, or GSS-API. A client program often has credentials that are obtained at login. A server always needs to acquire credentials explicitly.

The `gss-server` program has a function, `server_acquire_creds()`, to get the credentials for the service to be provided. The `server_acquire_creds()` function takes as input the name of the service and the security mechanism to be used. The `server_acquire_creds()` function then returns the credentials for the service. The `server_acquire_creds()` function uses the GSS-API function `gss_acquire_cred()` to get the credentials for the service that the server provides.

Before `server_acquire_creds()` accesses `gss_acquire_cred()`, `server_acquire_creds()` must complete the following two tasks:

1. Checking for a list of mechanisms and reducing the list to a single mechanism for the purpose of getting a credential.

If a single credential can be shared by multiple mechanisms, the `gss_acquire_cred()` function returns credentials for all those mechanisms. Therefore, `gss_acquire_cred()` takes as input a *set* of mechanisms. (See [“Working With Credentials in GSS-API” on page 78](#).) In most cases, however, including this one, a single credential might not work for multiple mechanisms. In the `gss-server` program, either a single mechanism is specified on the command line or else the default mechanism is used. Therefore, the first task is to make sure that the set of mechanisms that was passed to `gss_acquire_cred()` contains a single mechanism, default or otherwise, as follows:

```
if (mechOid != GSS_C_NULL_OID) {
    desiredMechs = &mechOidSet;
    mechOidSet.count = 1;
    mechOidSet.elements = mechOid;
} else
    desiredMechs = GSS_C_NULL_OID_SET;
```

`GSS_C_NULL_OID_SET` indicates that the default mechanism should be used.

2. Translating the service name into GSS-API format.

Because `gss_acquire_cred()` takes the service name in the form of a `gss_name_t` structure, the name of the service must be imported into that format. The `gss_import_name()` function performs this translation. Because this function, like all GSS-API functions, requires arguments to be GSS-API types, the service name has to be copied to a GSS-API buffer first, as follows:

```
name_buf.value = service_name;
name_buf.length = strlen(name_buf.value) + 1;
```

```
maj_stat = gss_import_name(&min_stat, &name_buf,
                          (gss_OID) GSS_C_NT_HOSTBASED_SERVICE, &server_name);
if (maj_stat != GSS_S_COMPLETE) {
    display_status("importing name", maj_stat, min_stat);
    if (mechOid != GSS_C_NO_OID)
        gss_release_oid(&min_stat, &mechOid);
    return -1;
}
```

Note again the use of the nonstandard function `gss_release_oid()`.

The input is the service name as a string in `name_buf`. The output is the pointer to a `gss_name_t` structure, `server_name`. The third argument, `GSS_C_NT_HOSTBASED_SERVICE`, is the name type for the string in `name_buf`. In this case, the name type indicates that the string should be interpreted as a service of the format `service@host`.

After these tasks have been performed, the server program can call `gss_acquire_cred()`:

```
maj_stat = gss_acquire_cred(&min_stat, server_name, 0,
                          desiredMechs, GSS_C_ACCEPT,
                          server_creds, NULL, NULL);
```

- `min_stat` is the error code returned by the function.
- `server_name` is the name of the server.
- 0 indicates that the program does not need to know the maximum lifetime of the credential.
- `desiredMechs` is the set of mechanisms for which this credential applies.
- `GSS_C_ACCEPT` means that the credential can be used only to accept security contexts.
- `server_creds` is the credential handle to be returned by the function.
- `NULL, NULL` indicates that the program does not need to know either the specific mechanism being employed or the amount of time that the credential will be valid.

The following source code illustrates the `server_acquire_creds()` function.

EXAMPLE 22 Sample Code for `server_acquire_creds()` Function

```
/*
 * Function: server_acquire_creds
 *
 * Purpose: imports a service name and acquires credentials for it
 *
 * Arguments:
 *
 *     service_name    (r) the ASCII service name
 *     mechType        (r) the mechanism type to use
 *     server_creds    (w) the GSS-API service credentials
```



```

*
* Returns: 0 on success, -1 on failure
*
* Effects:
*
* The service name is imported with gss_import_name, and service
* credentials are acquired with gss_acquire_cred. If either operation
* fails, an error message is displayed and -1 is returned; otherwise,
* 0 is returned.
*/
int server_acquire_creds(service_name, mechOid, server_creds)
    char *service_name;
    gss_OID mechOid;
    gss_cred_id_t *server_creds;
{
    gss_buffer_desc name_buf;
    gss_name_t server_name;
    OM_uint32 maj_stat, min_stat;
    gss_OID_set_desc mechOidSet;
    gss_OID_set desiredMechs = GSS_C_NULL_OID_SET;

    if (mechOid != GSS_C_NULL_OID) {
        desiredMechs = &mechOidSet;
        mechOidSet.count = 1;
        mechOidSet.elements = mechOid;
    } else
        desiredMechs = GSS_C_NULL_OID_SET;

    name_buf.value = service_name;
    name_buf.length = strlen(name_buf.value) + 1;
    maj_stat = gss_import_name(&min_stat, &name_buf,
        (gss_OID) GSS_C_NT_HOSTBASED_SERVICE, &server_name);
    if (maj_stat != GSS_S_COMPLETE) {
        display_status("importing name", maj_stat, min_stat);
        if (mechOid != GSS_C_NO_OID)
            gss_release_oid(&min_stat, &mechOid);
        return -1;
    }

    maj_stat = gss_acquire_cred(&min_stat, server_name, 0,
        desiredMechs, GSS_C_ACCEPT,
        server_creds, NULL, NULL);

    if (maj_stat != GSS_S_COMPLETE) {
        display_status("acquiring credentials", maj_stat, min_stat);
        return -1;
    }
}

```

```
        (void) gss_release_name(&min_stat, &server_name);  
  
        return 0;  
    }  
}
```

Checking for inetd

Having acquired credentials for the service, `gss-server` checks to see whether the user has specified `inetd`. The main function checks for `inetd` as follows:

```
if (do_inetd) {  
    close(1);  
    close(2);  
}
```

If the user has specified to use `inetd`, then the program closes the standard output and standard error. `gss-server` then calls `sign_server()` on the standard input, which `inetd` uses to pass connections. Otherwise, `gss-server` creates a socket, accepts the connection for that socket with the TCP function `accept()`, and calls `sign_server()` on the file descriptor that is returned by `accept()`.

If `inetd` is not used, the program creates connections and contexts until the program is terminated. However, if the user has specified the `-once` option, the loop terminates after the first connection.

Receiving Data From a Client

After checking for `inetd`, the `gss-server` program then calls `sign_server()`, which does the main work of the program. `sign_server()` first establishes the context by calling `server_establish_context()`.

`sign_server()` performs the following tasks:

- Accepts the context
- Unwraps the data
- Signs the data
- Returns the data

These tasks are described in the subsequent sections. The following source code illustrates the `sign_server()` function.

EXAMPLE 23 sign_server() Function

```

int sign_server(s, server_creds)
    int s;
    gss_cred_id_t server_creds;
{
    gss_buffer_desc client_name, xmit_buf, msg_buf;
    gss_ctx_id_t context;
    OM_uint32 maj_stat, min_stat;
    int i, conf_state, ret_flags;
    char *cp;

    /* Establish a context with the client */
    if (server_establish_context(s, server_creds, &context,
        &client_name, &ret_flags) < 0)
return(-1);

    printf("Accepted connection: \"%.*s\"\n",
        (int) client_name.length, (char *) client_name.value);
    (void) gss_release_buffer(&min_stat, &client_name);

    for (i=0; i < 3; i++)
        if (test_import_export_context(&context))
            return -1;

    /* Receive the sealed message token */
    if (recv_token(s, &xmit_buf) < 0)
return(-1);

    if (verbose && log) {
fprintf(log, "Sealed message token:\n");
print_token(&xmit_buf);
    }

    maj_stat = gss_unwrap(&min_stat, context, &xmit_buf, &msg_buf,
        &conf_state, (gss_qop_t *) NULL);
    if (maj_stat != GSS_S_COMPLETE) {
display_status("unsealing message", maj_stat, min_stat);
return(-1);
    } else if (! conf_state) {
fprintf(stderr, "Warning! Message not encrypted.\n");
    }

    (void) gss_release_buffer(&min_stat, &xmit_buf);

    fprintf(log, "Received message: ");
    cp = msg_buf.value;
    if ((isprint(cp[0]) || isspace(cp[0])) &&

```

```
(isprint(cp[1]) || isspace(cp[1])) {
fprintf(log, "\%.*s\n", msg_buf.length, msg_buf.value);
} else {
printf("\n");
print_token(&msg_buf);
}

/* Produce a signature block for the message */
maj_stat = gss_get_mic(&min_stat, context, GSS_C_QOP_DEFAULT,
&msg_buf, &xmit_buf);
if (maj_stat != GSS_S_COMPLETE) {
display_status("signing message", maj_stat, min_stat);
return(-1);
}

(void) gss_release_buffer(&min_stat, &msg_buf);

/* Send the signature block to the client */
if (send_token(s, &xmit_buf) < 0)
return(-1);

(void) gss_release_buffer(&min_stat, &xmit_buf);

/* Delete context */
maj_stat = gss_delete_sec_context(&min_stat, &context, NULL);
if (maj_stat != GSS_S_COMPLETE) {
display_status("deleting context", maj_stat, min_stat);
return(-1);
}

fflush(log);

return(0);
}
```

Accepting a Context

Establishing a context typically involves a series of token exchanges between the client and the server. Both context acceptance and context initialization should be performed in loops to maintain program portability. The loop for accepting a context is very similar to the loop for establishing a context, although in reverse. Compare with [“Establishing a Security Context With the Server” on page 103](#).

The following source code illustrates the `server_establish_context()` function.

EXAMPLE 24 server_establish_context() Function

```

/*
 * Function: server_establish_context
 *
 * Purpose: establishes a GSS-API context as a specified service with
 * an incoming client, and returns the context handle and associated
 * client name
 *
 * Arguments:
 *
 *     s           (r) an established TCP connection to the client
 *     service_creds (r) server credentials, from gss_acquire_cred
 *     context      (w) the established GSS-API context
 *     client_name  (w) the client's ASCII name
 *
 * Returns: 0 on success, -1 on failure
 *
 * Effects:
 *
 * Any valid client request is accepted. If a context is established,
 * its handle is returned in context and the client name is returned
 * in client_name and 0 is returned. If unsuccessful, an error
 * message is displayed and -1 is returned.
 */
int server_establish_context(s, server_creds, context, client_name, ret_flags)
    int s;
    gss_cred_id_t server_creds;
    gss_ctx_id_t *context;
    gss_buffer_t client_name;
    OM_uint32 *ret_flags;
{
    gss_buffer_desc send_tok, rcv_tok;
    gss_name_t client;
    gss_OID doid;
    OM_uint32 maj_stat, min_stat, acc_sec_min_stat;
    gss_buffer_desc oid_name;

    *context = GSS_C_NO_CONTEXT;

    do {
        if (rcv_token(s, &rcv_tok) < 0)
            return -1;

        if (verbose && log) {
            fprintf(log, "Received token (size=%d): \n", rcv_tok.length);
            print_token(&rcv_tok);
        }
    }

```

```
maj_stat =
    gss_accept_sec_context(&acc_sec_min_stat,
                          context,
                          server_creds,
                          &recv_tok,
                          GSS_C_NO_CHANNEL_BINDINGS,
                          &client,
                          &doid,
                          &send_tok,
                          ret_flags,
                          NULL, /* ignore time_rec */
                          NULL); /* ignore del_cred_handle */

(void) gss_release_buffer(&min_stat, &recv_tok);

if (send_tok.length != 0) {
    if (verbose && log) {
        fprintf(log,
                "Sending accept_sec_context token (size=%d):\n",
                send_tok.length);
        print_token(&send_tok);
    }
    if (send_token(s, &send_tok) < 0) {
        fprintf(log, "failure sending token\n");
        return -1;
    }

    (void) gss_release_buffer(&min_stat, &send_tok);
}
if (maj_stat!=GSS_S_COMPLETE && maj_stat!=GSS_S_CONTINUE_NEEDED) {
    display_status("accepting context", maj_stat,
                  acc_sec_min_stat);
    if (*context == GSS_C_NO_CONTEXT)
        gss_delete_sec_context(&min_stat, context,
                               GSS_C_NO_BUFFER);

    return -1;
}

if (verbose && log) {
    if (maj_stat == GSS_S_CONTINUE_NEEDED)
        fprintf(log, "continue needed...\n");
    else
        fprintf(log, "\n");
    fflush(log);
}
} while (maj_stat == GSS_S_CONTINUE_NEEDED);
```

```

/* display the flags */
display_ctx_flags(*ret_flags);

if (verbose && log) {
    maj_stat = gss_oid_to_str(&min_stat, doid, &oid_name);
    if (maj_stat != GSS_S_COMPLETE) {
        display_status("converting oid->string", maj_stat, min_stat);
        return -1;
    }
    fprintf(log, "Accepted connection using mechanism OID %.*s.\n",
            (int) oid_name.length, (char *) oid_name.value);
    (void) gss_release_buffer(&min_stat, &oid_name);
}

maj_stat = gss_display_name(&min_stat, client, client_name, &doid);
if (maj_stat != GSS_S_COMPLETE) {
    display_status("displaying name", maj_stat, min_stat);
    return -1;
}
maj_stat = gss_release_name(&min_stat, &client);
if (maj_stat != GSS_S_COMPLETE) {
    display_status("releasing name", maj_stat, min_stat);
    return -1;
}
return 0;
}

```

The `sign_server()` function uses the following source code to call `server_establish_context()` to accept the context.

```

/* Establish a context with the client */
if (server_establish_context(s, server_creds, &context,
    &client_name, &ret_flags) < 0)
return(-1);

```

The `server_establish_context()` function first looks for a token that the client sends as part of the context initialization process. Because, GSS-API does not send or receive tokens itself, programs must have their own routines for performing these tasks. The server uses `recv_token()` for receiving the token:

```

do {
    if (recv_token(s, &recv_tok) < 0)
        return -1;
}

```

Next, `server_establish_context()` calls the GSS-API function `gss_accept_sec_context()`:

```

maj_stat = gss_accept_sec_context(&min_stat,
                                context,

```

```
server_creds,  
&rcv_tok,  
GSS_C_NO_CHANNEL_BINDINGS,  
&client,  
&doid,  
&send_tok,  
ret_flags,  
NULL, /* ignore time_rec */  
NULL); /* ignore del_cred_handle */
```

- *min_stat* is the error status returned by the underlying mechanism.
- *context* is the context being established.
- *server_creds* is the credential for the service to be provided (see [“Acquiring Credentials” on page 119](#)).
- *rcv_tok* is the token received from the client by `rcv_token()`.
- `GSS_C_NO_CHANNEL_BINDINGS` is a flag indicating not to use channel bindings (see [“Using Channel Bindings in GSS-API” on page 85](#)).
- *client* is the ASCII name of the client.
- *oid* is the mechanism (in OID format).
- *send_tok* is the token to send to the client.
- *ret_flags* are various flags indicating whether the context supports a given option, such as message-sequence-detection.
- The two NULL arguments indicate that the program does not need to know the length of time that the context will be valid, or whether the server can act as a client's proxy.

The acceptance loop continues, barring any errors, as long as `gss_accept_sec_context()` sets *maj_stat* to `GSS_S_CONTINUE_NEEDED`. If *maj_stat* is not equal to that value or to `GSS_S_COMPLETE`, a problem exists and the loop exits.

`gss_accept_sec_context()` returns a positive value for the length of *send_tok* whether a token exists to send back to the client. The next step is to see a token exists to be sent, and, if so, to send the token:

```
if (send_tok.length != 0) {  
    . . .  
    if (send_token(s, &send_tok) < 0) {  
        fprintf(log, "failure sending token\n");  
        return -1;  
    }  
  
    (void) gss_release_buffer(&min_stat, &send_tok);  
}
```

Unwrapping the Message

After accepting the context, the `sign_server()` receives the message that has been sent by the client. Because the GSS-API does not provide a function for receiving tokens, the program uses the `recv_token()` function:

```
if (recv_token(s, &xmit_buf) < 0)
    return(-1);
```

Because the message might be encrypted, the program uses the GSS-API function `gss_unwrap()` for unwrapping:

```
maj_stat = gss_unwrap(&min_stat, context, &xmit_buf, &msg_buf,
                    &conf_state, (gss_qop_t *) NULL);
if (maj_stat != GSS_S_COMPLETE) {
    display_status("unwrapping message", maj_stat, min_stat);
    return(-1);
} else if (! conf_state) {
    fprintf(stderr, "Warning! Message not encrypted.\n");
}

(void) gss_release_buffer(&min_stat, &xmit_buf);
```

`gss_unwrap()` takes the message that `recv_token()` has placed in `xmit_buf`, translates the message, and puts the result in `msg_buf`. Two arguments to `gss_unwrap()` are noteworthy. `conf_state` is a flag to indicate whether confidentiality, that is, encryption, has been applied to this message. The final NULL indicates that the program does not need to know that the QOP that was used to protect the message.

Signing and Returning the Message

At this point, the `sign_server()` function needs to sign the message. Signing a message entails returning the message's Message Integrity Code or MIC to the client. Returning the message proves that the message was sent and was unwrapped successfully. To obtain the MIC, `sign_server()` uses the function `gss_get_mic()`:

```
maj_stat = gss_get_mic(&min_stat, context, GSS_C_QOP_DEFAULT,
                    &msg_buf, &xmit_buf);
```

`gss_get_mic()` looks at the message in `msg_buf`, produces the MIC, and stores the MIC in `xmit_buf`. The server then sends the MIC back to the client with `send_token()`. The client

verifies the MIC with `gss_verify_mic()`. See [“Reading and Verifying a Signature Block From a GSS-API Client” on page 112](#).

Finally, `sign_server()` performs some cleanup. `sign_server()` releases the GSS-API buffers `msg_buf` and `xmit_buf` with `gss_release_buffer()`. Then `sign_server()` destroys the context with `gss_delete_sec_context()`.

Using the `test_import_export_context()` Function

GSS-API allows you to export and import contexts. These activities enable you to share a context between different processes in a multiprocess program. `sign_server()` contains a proof-of-concept function, `test_import_export_context()`, that illustrates how exporting and importing contexts works. `test_import_export_context()` does not pass a context between processes. Instead, `test_import_export_context()` displays the amount of time to export and then import a context. Although an artificial function, `test_import_export_context()` does indicate how to use the GSS-API importing and exporting functions. `test_import_export_context()` also shows how to use timestamps with regard to manipulating contexts.

The source code for `test_import_export_context()` is shown in the following example.

EXAMPLE 25 `test_import_export_context()` Example

```
int test_import_export_context(context)
    gss_ctx_id_t *context;
{
    OM_uint32      min_stat, maj_stat;
    gss_buffer_desc context_token, copied_token;
    struct timeval tm1, tm2;

    /*
     * Attempt to save and then restore the context.
     */
    gettimeofday(&tm1, (struct timezone *)0);
    maj_stat = gss_export_sec_context(&min_stat, context, &context_token);
    if (maj_stat != GSS_S_COMPLETE) {
        display_status("exporting context", maj_stat, min_stat);
        return 1;
    }
    gettimeofday(&tm2, (struct timezone *)0);
    if (verbose && log)
        fprintf(log, "Exported context: %d bytes, %.74f seconds\n",
```

```

        context_token.length, timeval_subtract(&tm2, &tm1));
copied_token.length = context_token.length;
copied_token.value = malloc(context_token.length);
if (copied_token.value == 0) {
    fprintf(log, "Couldn't allocate memory to copy context token.\n");
    return 1;
}
memcpy(copied_token.value, context_token.value, copied_token.length);
maj_stat = gss_import_sec_context(&min_stat, &copied_token, context);
if (maj_stat != GSS_S_COMPLETE) {
    display_status("importing context", maj_stat, min_stat);
    return 1;
}
free(copied_token.value);
gettimeofday(&tm1, (struct timezone *)0);
if (verbose && log)
    fprintf(log, "Importing context: %7.4f seconds\n",
            timeval_subtract(&tm1, &tm2));
(void) gss_release_buffer(&min_stat, &context_token);
return 0;
}

```

Cleanup in the GSSAPI Server Example

Back in the `main()` function, the application deletes the service credential with `gss_release_cred()`. If an OID for the mechanism has been specified, the program deletes the OID with `gss_release_oid()` and exits.

```
(void) gss_release_cred(&min_stat, &server_creds);
```

Writing Applications That Use SASL

SASL (Simple Authentication and Security Layer) is a security framework. SASL, pronounced "sassel", provides authentication services and optionally integrity and confidentiality services to connection-based protocols.

This chapter covers the following topics:

- [“Introduction to Simple Authentication Security Layer \(SASL\)” on page 133](#)
- [“SASL Example” on page 149](#)
- [“SASL for Service Providers” on page 152](#)

Introduction to Simple Authentication Security Layer (SASL)

SASL provides developers of applications and shared libraries with mechanisms for authentication, data integrity-checking, and encryption. SASL enables the developer to code to a generic API. This approach avoids dependencies on specific mechanisms. SASL is particularly appropriate for applications that use the IMAP, SMTP, ACAP, and LDAP protocols, as these protocols all support SASL. SASL is described in RFC 2222.

SASL Library Basics

The SASL library is called `libsasl`. `libsasl` is a framework that allows properly written SASL consumer applications to use any SASL plugins that are available on the system. The term *plugin* refers to objects that provide services for SASL. Plugins are external to `libsasl`. SASL plugins can be used for authentication and security, canonicalization of names, and lookup of auxiliary properties, such as passwords. Cryptographic algorithms are stored in plugins rather than in `libsasl`.

`libsasl` provides an application programming interface (API) for consumer applications and libraries. A service provider interface (SPI) is provided for plugins to supply services to `libsasl`. `libsasl` is not aware of the network or the protocol. Accordingly, the application must take responsibility for sending and receiving data between the client and server.

SASL uses two important identifiers for users. The *authentication ID* (`authid`) is the user ID for authenticating the user. The authentication ID grants the user access to a system. The *authorization ID* (`userid`) is used to check whether the user is allowed to use a particular option.

The SASL client application and SASL server application negotiate a common SASL mechanism and security level. Typically, the SASL server application sends its list of acceptable authentication mechanisms to the client. The SASL client application can then decide which authentication mechanism best satisfies its requirements. After this point, the authentication takes place using the agreed-upon authentication mechanism as a series of client-server exchanges of the SASL supplied authentication data. This exchange continues until the authentication successfully completes, fails, or is aborted by the client or the server.

In the process of authentication, the SASL authentication mechanism can negotiate a security layer. If a security layer is selected, that layer must be used for the duration of the SASL session.

SASL Architecture

The following figure shows the basic SASL architecture.

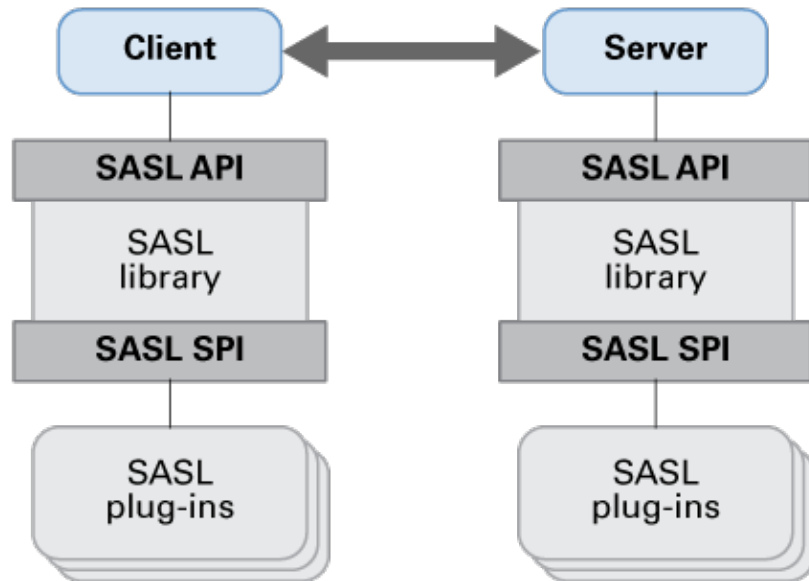
FIGURE 12 SASL Architecture

Client and server applications make calls to their local copies of `libsasl` through the SASL API. `libsasl` communicates with the SASL mechanisms through the SASL service provider interface (SPI).

Security Mechanisms

Security mechanism plugins provide security services to `libsasl`. Some typical functions that are provided by security mechanisms follow:

- Authentication on the client side
- Authentication on the server side

- Integrity, that is, checking that transmitted data is intact
- Confidentiality, that is, encrypting and decrypting transmitted data

SASL Security Strength Factor

SSF, the security strength factor, indicates the strength of the SASL protection. If the mechanism supports a security layer, the client and server negotiate the *SSF*. The value of the *SSF* is based on the security properties that were specified before the SASL negotiation. If a non-zero *SSF* is negotiated, both client and server need to use the mechanism's security layer when the authentication has completed.

SSF is represented by an integer with one of the following values:

- 0 – No protection.
- 1 – Integrity checking only.
- >1 – Supports authentication, integrity and confidentiality. The number represents the encryption key length.

The confidentiality and integrity operations are performed by the security mechanism. `libsasl` coordinates these requests.

Note - In the negotiation, the SASL client selects the mechanism with the maximum *SSF*. However, the actual SASL mechanism that is chosen might subsequently negotiate a lower *SSF*.

Communication in SASL

Applications communicate with `libsasl` through the `libsasl` API. `libsasl` can request additional information by means of callbacks that are registered by the application. Applications do not call plugins directly, only through `libsasl`. Plugins generally call the `libsasl` framework's plugins, which then call the application's callbacks. SASL plugins can also call the application directly, although the application does not know whether the call came from a plugin or from `libsasl`.

Callbacks are useful in multiple areas, as follows.

- `libsasl` can use callbacks to get information that is needed to complete authentication.
- `libsasl` consumer applications can use callbacks to change search paths for plugins and configuration data, to verify files, and to change various default behaviors.
- Servers can use callbacks to change authorization policies, to supply different password verification methods, and to get password change information.

- Clients and servers can use callbacks to specify the language for error messages.

Applications register two sorts of callbacks: global and session. Additionally, `libsasl` defines a number of callback identifiers that are used to register for different sorts of callbacks. If a given type of callback is not registered, `libsasl` takes default action.

Session callbacks override global callbacks. If a session callback is specified for a given ID, the global callback is not called for that session. Some callbacks must be global, because these callbacks occur outside of sessions.

The following scenarios require global callbacks:

- Determination of search paths for plugins to load
- Verification of plugins
- Location of configuration data
- The logging of error messages
- Other global configuration of `libsasl` or its plugins

A SASL callback can be registered with a NULL callback function for a given SASL callback ID. The NULL callback function indicates that the client is equipped to supply the needed data. All SASL callback IDs start with the prefix `SASL_CB_`.

SASL provides the following callbacks for use by either a client or a server:

`SASL_CB_GETOPT`

Gets a SASL option. Options modify the behavior of `libsasl(3LIB)` and related plugins. Can be used by either a client or a server.

`SASL_CB_LOG`

Sets the logging function for `libsasl` and its plugins. The default behavior is to use `syslog`.

`SASL_CB_GETPATH`

Gets the colon-separated list of SASL plugin search paths.

The default SASL plugin search paths depend on the architecture as follows:

- 32-bit SPARC architecture: `/usr/lib/sasl`
- 32-bit x86 architecture: `/usr/lib/sasl`
- 64-bit SPARC architecture: `/usr/lib/sasl/sparcv9`
- x64 architecture: `/usr/lib/sasl/amd64`

`SASL_CB_GETCONF`

Gets the path to the SASL server's configuration directory. The default is `/etc/sasl`.

SASL_CB_LANGUAGE

Specifies a comma-separated list of RFC 1766 language codes in order of preference, for client and server error messages and for client prompts. The default is `i-default`.

SASL_CB_VERIFYFILE

Verifies the configuration file and plugin files.

SASL provides the following callbacks for use by clients only:

SASL_CB_USER

Gets the client user name. The user name is the same as the authorization ID. The `LOGNAME` environment variable is the default.

SASL_CB_AUTHNAME

Gets the client authentication name.

SASL_CB_PASS

Gets a client passphrase-based secret.

SASL_CB_ECHOPROMPT

Gets the result for a given challenge prompt. The input from the client can be echoed.

SASL_CB_NOECHOPROMPT

Gets the result for a given challenge prompt. The input from the client should not be echoed.

SASL_CB_GETREALM

Sets the realm to be used for authentication.

SASL provides the following callbacks for use by servers only:

SASL_CB_PROXY_POLICY

Checks that an authenticated user is authorized to act on behalf of the specified user. If this callback is not registered, then the authenticated user and the user to be authorized must be the same. If these IDs are not the same, then the authentication fails. Use the server application to take care of nonstandard authorization policies.

SASL_CB_SERVER_USERDB_CHECKPASS

Verifies a plain text password against the caller-supplied user database.

SASL_CB_SERVER_USERDB_SETPASS

Stores a plain text password in the user database

SASL_CB_CANON_USER

Calls an application-supplied user canonicalization function.

When the SASL library is first initialized, the server and client declare any necessary global callbacks. The global callbacks are available prior to and during the SASL sessions. Prior to initialization, callbacks perform such tasks as loading plugins, logging data, and reading configuration files. At the start of a SASL session, additional callbacks can be declared. Such callbacks can override global callbacks if necessary.

SASL Connection Contexts

libsasl uses a SASL connection *context* to maintain the state of each SASL session for both SASL clients and SASL servers. Each context can be used for only one authentication and security session at a time.

The maintained state includes the following information:

- Connection information, such as service, naming and address information, and protocol flags
- Callbacks specific to the connection
- Security properties for negotiating the SASL SSF
- State of the authentication along with security layer information

Steps in the SASL Cycle

The following diagram shows steps in the SASL life cycle. The client actions are shown on the left of the diagram and the server actions on the right side. The arrows in the middle show interactions between the client and server over an external connection.

FIGURE 13 SASL Life Cycle

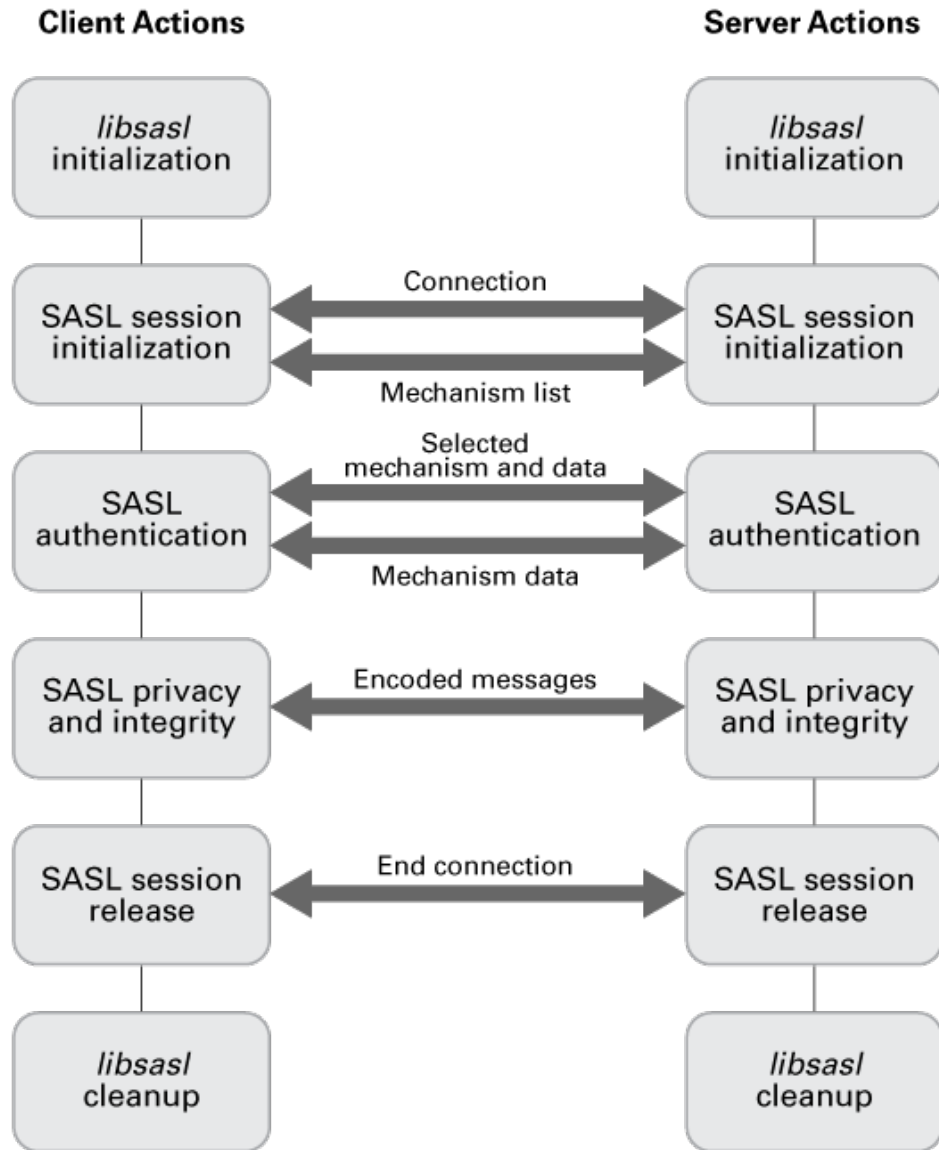

The sections that follow illustrate the steps in the life cycle.

libsasl Initialization

The client calls `sasl_client_init()` to initialize `libsasl` for the client's use. The server calls `sasl_server_init()` to initialize `libsasl` for server use.

When `sasl_client_init()` is run, the SASL client, the client's mechanisms and the client's canonicalization plugin are loaded. Similarly, when `sasl_server_init()` is called, the SASL server, the server's mechanisms, the server's canonicalization plugin, and the server's `auxprop` plugin are loaded. After `sasl_client_init()` has been called, additional client plug-ins can be added by using `sasl_client_add_plugin()` and `sasl_canonuser_add_plugin()`. On the server side, after `sasl_server_init()` has been called, additional server plug-ins can be added through `sasl_server_add_plugin()`, `sasl_canonuser_add_plugin()`, and `sasl_auxprop_add_plugin()`.

SASL mechanisms are provided in the Oracle Solaris software in the following directories according to the architecture:

- 32-bit SPARC architecture: `/usr/lib/sasl`
- 32-bit x86 architecture: `/usr/lib/sasl`
- 64-bit SPARC architecture: `/usr/lib/sasl/sparcv9`
- x64 architecture: `/usr/lib/sasl/amd64`

The `SASL_CB_GETPATH` callback can be used to override the default location.

At this point, any required global callbacks are set. SASL clients and servers might include the following callbacks:

- `SASL_CB_GETOPT`
- `SASL_CB_LOG`
- `SASL_CB_GETPATH`
- `SASL_CB_VERIFYFILE`

A SASL server might additionally include the `SASL_CB_GETCONF` callback.

SASL Session Initialization

The server and client use establish the connection through the protocol. To use SASL for authentication, the server and client create SASL connection contexts by using `sasl_server_new()` and `sasl_client_new()` respectively. The SASL client and server can

use `sasl_setprop()` to set properties that impose security restrictions on mechanisms. This approach enables a SASL consumer application to decide the minimum SSF, the maximum SSF, and the security properties for the specified SASL connection context.

```
#define SASL_SEC_NOPLAINTEXT      0x0001
#define SASL_SEC_NOACTIVE        0x0002
#define SASL_SEC_NODICTIONARY    0x0004
#define SASL_SEC_FORWARD_SECRECY 0x0008
#define SASL_SEC_NOANONYMOUS    0x0010
#define SASL_SEC_PASS_CREDENTIALS 0x0020
#define SASL_SEC_MUTUAL_AUTH     0x0040
```

Note - Authentication and a security layer can be provided by the client-server protocol or by some other mechanism that is external to `libsasl`. In such a case, `sasl_setprop()` can be used to set the external authentication ID or the external SSF. For example, consider the case in which the protocol uses SSL with client authentication to the server. In this case, the external authentication identity can be the client's subject name. The external SSF can be the key size.

For the server, `libsasl` determines the available SASL mechanisms according to the security properties and the external SSF. The client obtains the available SASL mechanisms from the SASL server through the protocol.

For a SASL server to create a SASL connection context, the server should call `sasl_server_new()`. An existing SASL connection context that is no longer in use can be reused. However, the following parameters might need to be reset:

```
#define SASL_DEFUSERREALM 3 /* default realm passed to server_new or set with
    setprop */
#define SASL_IPLOCALPORT 8 /* iplocalport string passed to server_new */
#define SASL_IPREMOTEPORT 9 /* ipremoteport string passed to server_new */
#define SASL_SERVICE 12 /* service passed to sasl*_new */
#define SASL_SERVERFQDN 13 /* serverFQDN passed to sasl*_new */
```

You can modify any of the parameters to `sasl_client_new()` and `sasl_server_new()` except the callbacks and protocol flags.

The server and client can also establish security policy and set connection specific parameters by using `sasl_setprop()` to specify the following properties:

```
#define SASL_SSF_EXTERNAL 100 /* external SSF active (sasl_ssf_t *) */
#define SASL_SEC_PROPS 101 /* sasl_security_properties_t */
#define SASL_AUTH_EXTERNAL 102 /* external authentication ID (const char *)
    */
```

- `SASL_SSF_EXTERNAL` – For setting the strength factor, that is, the number of bits in the key
- `SASL_SEC_PROPS` – For defining security policy
- `SASL_AUTH_EXTERNAL` – The external authentication ID

The server can call `sasl_listmech()` to get a list of the available SASL mechanisms that satisfy the security policy. The client can generally get the list of available mechanisms from the server in a protocol-dependent way.

The initialization of a SASL session is illustrated in the following diagram. In this diagram and subsequent diagrams, data checks after transmission over the protocol have been omitted for the sake of simplicity.

FIGURE 14 SASL Session Initialization

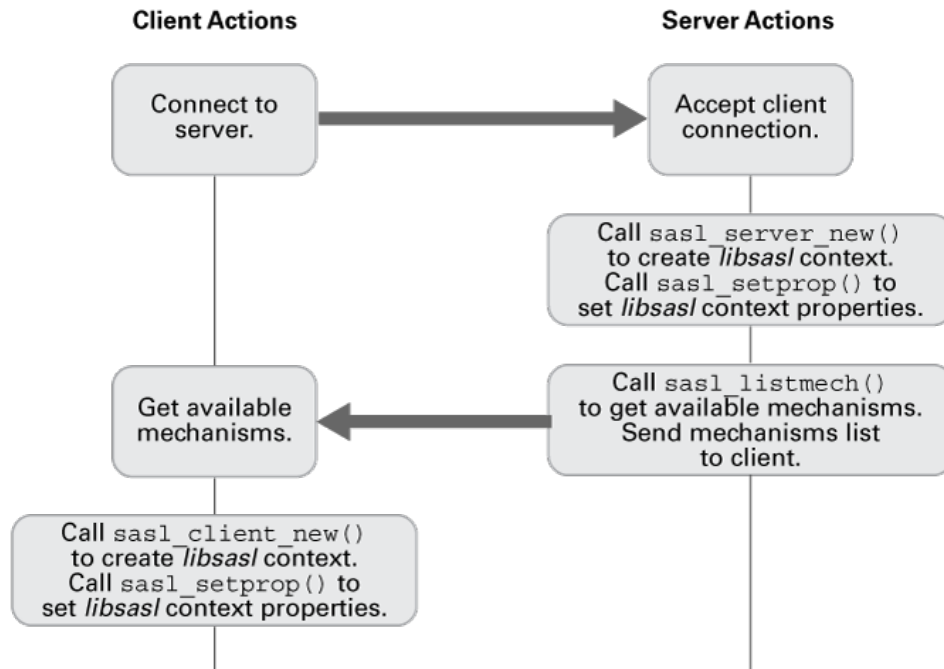

SASL Authentication

Authentication takes a variable number of client and server steps depending on the security mechanism that is used. The SASL client calls `sasl_client_start()` with a list of security

mechanisms to use. This list typically comes from the server. `libsasl` selects the best mechanism to use for this SASL session, according to the available mechanisms and the client's security policy. The client's security policy controls which mechanisms are permitted. The selected mechanism is returned by `sasl_client_start()`. Sometimes the security mechanism for the client sometimes needs additional information for authentication. For registered callbacks, `libsasl` calls the specified callback unless the callback function is `NULL`. If the callback function is `NULL`, `libsasl` returns `SASL_INTERACT` and a request for needed information. If `SASL_INTERACT` is returned, then `sasl_client_start()` should be called with the requested information.

If `sasl_client_start()` returns `SASL_CONTINUE` or `SASL_OK`, the client should send the selected mechanism with any resulting authentication data to the server. If any other value is returned, an error has occurred. For example, no mechanism might be available.

The server receives the mechanism that has been selected by the client, along with any authentication data. The server then calls `sasl_server_start()` to initialize the mechanism data for this session. `sasl_server_start()` also processes any authentication data. If `sasl_server_start()` returns `SASL_CONTINUE` or `SASL_OK`, the server sends authentication data. If `sasl_server_start()` returns any other value, an error has occurred such as an unacceptable mechanism or an authentication failure. The authentication must be aborted. The SASL context should be either freed or reused.

This part of the authentication process is illustrated in the following diagram.

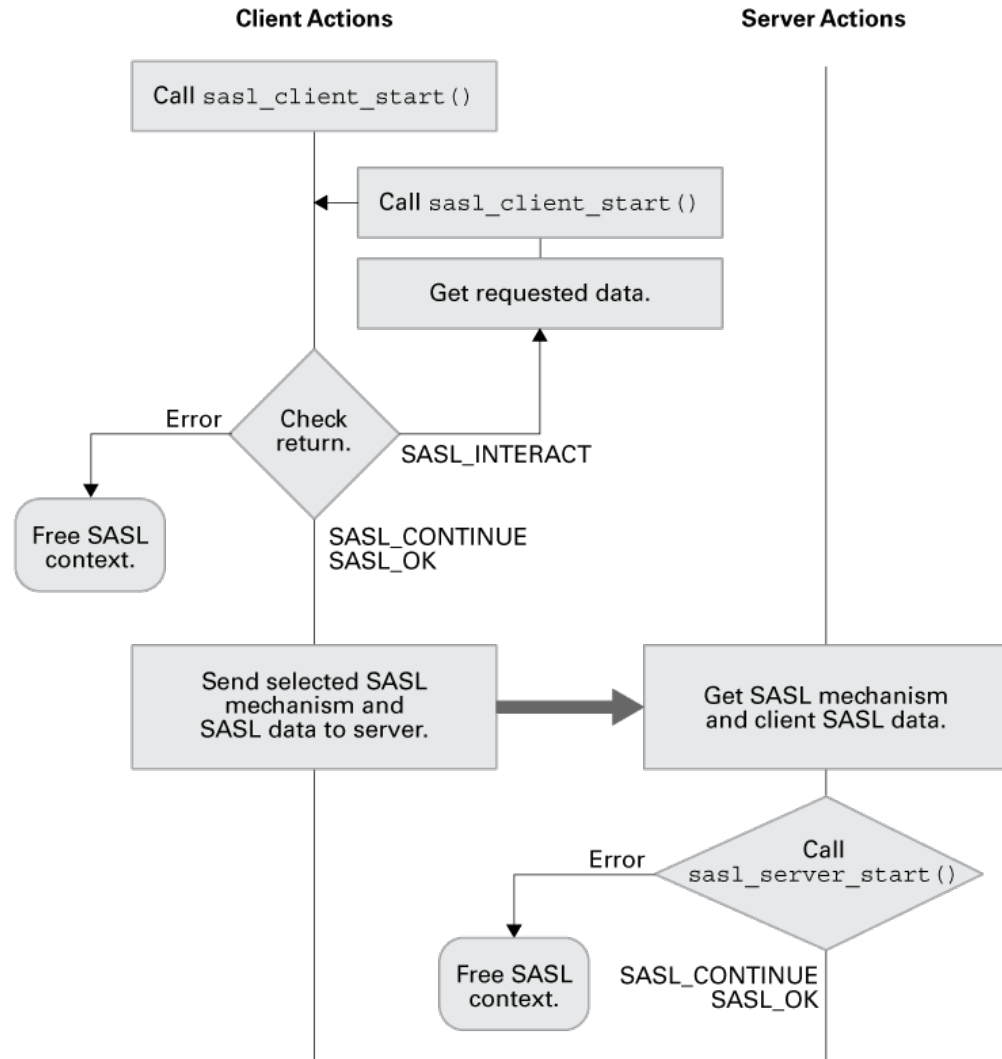
FIGURE 15 SASL Authentication: Sending Client Data

If the server call to `sasl_server_start()` returns `SASL_CONTINUE`, the server continues to communicate with the client to get all the necessary authentication information. The number of subsequent steps depends on the mechanism. If needed, the client calls `sasl_client_step()` to

process the authentication data from the server and to generate a reply. Similarly, the server can call `sasl_server_step()` to process the authentication from the client and to generate a reply in turn. This exchange continues until the authentication is complete or until an error has occurred. `SASL_OK` is returned to indicate that the authentication has successfully completed for the client or server. The SASL mechanism might still have additional data to send to the other side so the other side can complete authentication. When authentication has been achieved on both sides, the server and client can inquire about each other's properties.

The following diagram shows the interactions between the server and client to transfer the additional authentication data.

FIGURE 16 SASL Authentication: Processing Server Data

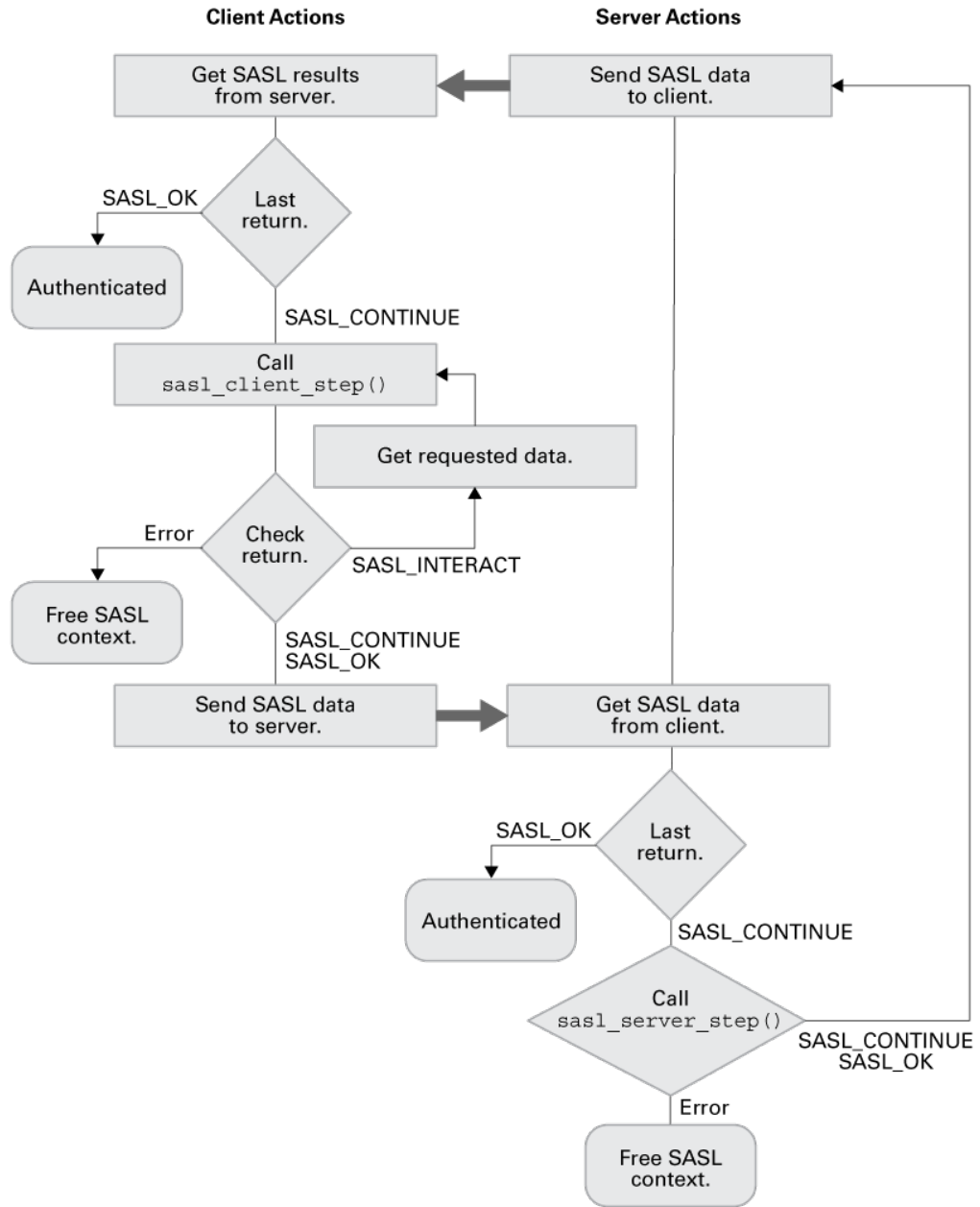

SASL Confidentiality and Integrity

To check for a security layer, use the [`sasl_getprop\(3SASL\)`](#) function to see if the security strength factor (SSF) has a value that is greater than 0. If a security layer has been negotiated, the client and server must use the resulting SSF after successful authentication. Data is exchanged between the client and server in a similar fashion to authentication. `sasl_encode()` is applied to data before the data is sent by the protocol to the client or server. On the receiving end, data is decoded by `sasl_decode()`. If a security layer has not been negotiated, the SASL connection context is not needed. The context can then be disposed of or reused.

Releasing SASL Sessions

A SASL connection context should only be freed when the session is not to be reused. `sasl_dispose()` frees the SASL connection context and all associated resources and mechanisms. The SASL connection contexts must be disposed before calling `sasl_done()`. `sasl_done()` is not responsible for releasing context resources for the SASL connection. See [“`libsasl Cleanup`” on page 148](#).

When a SASL session is freed, the associated mechanisms are informed that all state can be freed. A SASL session should only be freed when the session is not to be reused. Otherwise, the SASL state can be reused by another session. Both the client and server use `sasl_dispose()` to free the SASL connection context.

libsasl Cleanup

This step releases all the resources in the SASL library and the plugins. The client and server call `sasl_done()` to release `libsasl()` resources and to unload all the SASL plugins. `sasl_done()` does not release SASL connection contexts. Note that if an application is both a SASL client and a SASL server, `sasl_done()` releases both the SASL client and SASL server resources. You cannot release the resources for just the client or the server.



Caution - Libraries should not call `sasl_done()`. Applications should exercise caution when calling `sasl_done()` to avoid interference with any libraries that might be using `libsasl`.

SASL Example

This section demonstrates a typical SASL session between a client application and server application. The example goes through these steps:

1. The client application initializes `libsasl`.
The client application sets the following global callbacks:
 - `SASL_CB_GETREALM`
 - `SASL_CB_USER`
 - `SASL_CB_AUTHNAME`
 - `SASL_CB_PASS`
 - `SASL_CB_GETPATH`
 - `SASL_CB_LIST_END`
2. The server application initializes `libsasl`.
The server application sets the following global callbacks:
 - `SASL_CB_LOG`
 - `SASL_CB_LIST_END`
3. The client creates a SASL connection context, sets the security properties, and requests the list of available mechanisms from the server.
4. The server creates a SASL connection context, sets the security properties, gets a list of suitable SASL mechanisms, and sends the list to client.
5. The client receives the list of available mechanisms, chooses a mechanism, and sends the mechanism choice to the server together with any authentication data.
6. The client and server then exchange SASL data until the authentication and security layer negotiation is complete.
7. With the authentication complete, the client and server determine whether a security layer was negotiated. The client encodes a test message. The message is then sent to the server. The server also determines the user name of the authenticated user and the user's realm.
8. The server receives, decodes, and prints the encoded message.
9. The client calls `sasl_dispose()` to release the client's SASL connection context. The client then calls `sasl_done()` to release the `libsasl` resources.
10. The server calls `sasl_dispose()` to release the client connection context.

The dialogue between the client and the server follows. Each call to `libsasl` is displayed as the call is made. Each transfer of data is indicated by the sender and receiver. The data is displayed in encoded form preceded by the source: C: for the client and S: for server. The source code for both applications is provided in the [Appendix E, “Source Code for SASL Example”](#).

Client

```
% doc-sample-client
*** Calling sasl_client_init() to initialize libsasl for client use ***
*** Calling sasl_client_new() to create client SASL connection context ***
*** Calling sasl_setprop() to set sasl context security properties ***
Waiting for mechanism list from server...
```

Server

```
% doc-sample-server digest-md5
*** Calling sasl_server_init() to initialize libsasl for server use ***
*** Calling sasl_server_new() to create server SASL connection context ***
*** Calling sasl_setprop() to set sasl context security properties ***
Forcing use of mechanism digest-md5
Sending list of 1 mechanism(s)
S: ZGlnZXN0LW1kNQ==
```

Client

```
S: ZGlnZXN0LW1kNQ==
received 10 byte message
got 'digest-md5'
Choosing best mechanism from: digest-md5
*** Calling sasl_client_start() ***
Using mechanism DIGEST-MD5
Sending initial response...
C: RElHRVNULU1ENQ==
Waiting for server reply...
```

Server

```
C: RElHRVNULU1ENQ==
got 'DIGEST-MD5'
*** Calling sasl_server_start() ***
Sending response...
S: bm9uY2U9IklicGxhRHJZNE4Z1gyVm5lQzl5MTZOYWxUOVcvanUrcmp5YmRqaHM\
sbT0iam0xMTQxNDIiLHFvcD0iYXV0aCxdXRoLWludCxdXRoLWNvbmYiLGNpcGhlcj0ic\
QwLHJjNC01NixyYzQiLGIheGJlZj0yMDQ4LGN0YXJzZXQ9dXRmLTgsYWxnb3JpdGhtPW1k\
XNz
Waiting for client reply...
```

Client

```
S: bm9uY2U9IklicGxhRHJZNE4Z1gyVm5lQzl5MTZOYWxUOVcvanUrcmp5YmRqaHM\
sbT0iam0xMTQxNDIiLHFvcD0iYXV0aCxdXRoLWludCxdXRoLWNvbmYiLGNpcGhlcj0ic\
QwLHJjNC01NixyYzQiLGIheGJlZj0yMDQ4LGN0YXJzZXQ9dXRmLTgsYWxnb3JpdGhtPW1k\
XNz
received 171 byte message
got 'nonce="IbpladrY4N4szhgX2VneC9y16NalT9W/ju+rjybdjhs=", \
realm="jm114142", qop="auth,auth-int,auth-conf", cipher="rc4-40,rc4-56,\
```

```
rc4",maxbuf=2048,charset=utf-8,algorithm=md5-sess'
*** Calling sasl_client_step() ***
Please enter your authorization name : zzzz
Please enter your authentication name : zzzz
Please enter your password : zz
*** Calling sasl_client_step() ***
Sending response...
C: dXNlcm5hbWU9Inp6enoilHJLYWxtPSJqbTExNDE0MiIsbm9uY2U9IklicGxhRHJZNE4\
yVm5lQzL5MTZOYwXU0VcvanUrcmp5YmRqaHM9Iixjbm9uY2U9InlqZ2hMvmhjRFJMa0Fob\
tDS0p2WVUxMUM4V1NycjJVWm5IR2VkcLk9IixuYz0wMDAwMDAwMSxxb3A9YXV0aC1jb25m\
Ghlcj0icmM0IixtYXhidwY9MjA0OCxkaWdlc3QtdXJpPSJyY2lkLyIsZmVzcG9uc2U9OTY\
ODI1MmRmNzY4YTJjYzYyYzZmYyYk0ZWm=
Waiting for server reply...
```

Server

```
C: dXNlcm5hbWU9Inp6enoilHJLYWxtPSJqbTExNDE0MiIsbm9uY2U9IklicGxhRHJZNE4\
yVm5lQzL5MTZOYwXU0VcvanUrcmp5YmRqaHM9Iixjbm9uY2U9InlqZ2hMvmhjRFJMa0Fob\
tDS0p2WVUxMUM4V1NycjJVWm5IR2VkcLk9IixuYz0wMDAwMDAwMSxxb3A9YXV0aC1jb25m\
Ghlcj0icmM0IixtYXhidwY9MjA0OCxkaWdlc3QtdXJpPSJyY2lkLyIsZmVzcG9uc2U9OTY\
ODI1MmRmNzY4YTJjYzYyYzZmYyYk0ZWm=
got 'username="zzzz", realm="jm114142", \
nonce="IbplaDrY4N4szhgX2VneC9y16NaLT9W/ju+rjybdjhs=", \
cnonce="yjghLVhcDRLkAhoirwKCKJvYU11C8WSrr2UZnHGedrY=", \
nc=00000001,qop=auth-conf,cipher="rc4",maxbuf=2048,digest-uri="rcmd/", \
response=966e978252df768a2cc91b2cd32a94ec'
*** Calling sasl_server_step() ***
Sending response...
S: cnNwYXV0aD0yYjEzMzRjYzU4NTE4MTEwOwM30TdhMjUwYjkwMzk3OQ==
Waiting for client reply...
```

Client

```
S: cnNwYXV0aD0yYjEzMzRjYzU4NTE4MTEwOwM30TdhMjUwYjkwMzk3OQ==
received 40 byte message
got 'rspauth=2b1334cc585181109c797a250b903979'
*** Calling sasl_client_step() ***
C:
Negotiation complete
*** Calling sasl_getprop() ***
Username: zzzz
SSF: 128
Waiting for encoded message...
```

Server

```
Waiting for client reply...
C: got '' *** Calling sasl_server_step() ***
Negotiation complete
*** Calling sasl_getprop() to get username, realm, ssf ***
```

```
Username: zzzz
Realm: 22c38
SSF: 128
*** Calling sasl_encode() *** sending encrypted message 'srv message 1'
S: AAAAHvArjnAvDFuMBqAAxkqdumzJB6VD1oajiwABAAAAAA==
```

Client

```
S: AAAAHvArjnAvDFuMBqAAxkqdumzJB6VD1oajiwABAAAAAA==
received 34 byte message
got ''
*** Calling sasl_decode() ***
received decoded message 'srv message 1'
*** Calling sasl_encode() ***
sending encrypted message 'client message 1'
C: AAAAIRdkTEMY0n9X4NXkxPc30TFvAZUnLbZANqzn6gABAAAAAA==
*** Calling sasl_dispose() to release client SASL connection context ***
*** Calling sasl_done() to release libsasl resources ***
```

Server

```
Waiting for encrypted message...
C: AAAAIRdkTEMY0n9X4NXkxPc30TFvAZUnLbZANqzn6gABAAAAAA==
got ''
*** Calling sasl_decode() ***
received decoded message 'client message 1'
*** Calling sasl_dispose() to release client SASL connection context ***
```

SASL for Service Providers

This section describes how to create plugins for providing mechanisms and other services to SASL applications.

Note - Due to export regulations, the Oracle Solaris SASL SPI does not support a security layer for non- Oracle Solaris client/server mechanism plugins. As a result, non- Oracle Solaris client/server mechanism plugins cannot offer integrity or privacy services. Oracle Solaris client/server mechanism plugins do not have this restriction.

SASL Plugin Overview

The SASL service provider interface (SPI) enables communication between plugins and the `libsasl` library. SASL plugins are typically implemented as shared libraries. A single shared

library can one or more SASL plugins of different types. Plugins that are in shared libraries are opened dynamically by `libsasl` through the `dlopen(3C)` function.

Plugins can also be statically bound to an application that calls `libsasl`. These kinds of plugins are loaded through either the `sasl_client_add_plugin()` function or the `sasl_server_add_plugin()` function, depending on whether the application is a client or server.

A SASL plugin in the Oracle Solaris OS has the following requirements:

- A plugin in a shared library must be in a valid executable object file, preferably with the `.so` file extension.
- The plugin must be in a location that can be verified. The `SASL_CB_VERIFYFILE` callback is used to verify plugins.
- The plugin must contain the proper entry points.
- The version of the plugin for the SASL client must match the version of the corresponding plugin for the SASL server.
- The plugin needs to be able to be initialized successfully.
- The binary type of the plugin must match the binary type for `libsasl`.

SASL plugins fall into four categories:

- Client mechanism plugin
- Server mechanism plugin
- Canonicalization plugin
- Auxprop plugin

The `sasl_client_init()` function causes SASL clients to load any available client plugins. The `sasl_server_init()` function causes SASL servers to load the server, canonicalization, and auxprop plugins. All plugins are unloaded when `sasl_done()` is called.

To locate plugins, `libsasl` uses either the `SASL_CB_GETPATH` callback function or the default path. `SASL_CB_GETPATH` returns a colon-separated list of directories to be searched for plugins. If the SASL consumer specifies a `SASL_CB_GETPATH` callback, then `libsasl` uses the returned path for searching. Otherwise, the SASL consumer can use the default path that corresponds to the binary type.

The following list shows the default path and binary type correspondence:

- 64-bit SPARC architecture: `/usr/lib/sasl/sparcv9`
- x64 architecture: `/usr/lib/sasl/amd64`
- 32-bit SPARC architecture: `/usr/lib/sasl`
- 32-bit x86 architecture: `/usr/lib/sasl`

As part of the loading process, `libsasl` calls the latest, supported version of the plugin. The plugin returns the version and a structure that describes the plugin. If the version checks out, `libsasl` loads the plugin. The current version number is `SASL_UTILS_VERSION`.

After a plugin has been initialized, subsequent communication between the plugin and `libsasl` takes place through structures that have to be established. Plugins use the `sasl_utils_t` structure to call `libsasl`.

The `libsasl` library uses entry points in the following structures to communicate with plugins:

- `sasl_out_params_t`
- `sasl_client_params_t`
- `sasl_server_params_t`
- `sasl_client_plug_t`
- `sasl_server_plug_t`
- `sasl_canonuser_plug_t`
- `sasl_auxprop_plug_t`

The source code for these structures can be found in the SASL header files. The structures are described in the following section.

Important Structures for SASL Plugins

Communication between `libsasl` and plugins is accomplished through the following structures:

- `sasl_utils_t` – The `sasl_utils_t` structure contains a number of utility functions, along with the three contexts.

This structure contains a number of utility functions that serve as a convenience for plugin writers. Many of the functions are pointers to public interfaces in `libsasl`. Plug-ins do not need to call `libsasl` directly, unless for some reason the plugin needs to be a SASL consumer.

`libsasl` creates three contexts for `sasl_utils_t`:

- `sasl_conn_t *conn`
- `sasl_rand_t *rpool`
- `void *getopt_context`

In some cases, such as loading plugins, the `conn` variable in `sasl_utils_t` is not actually associated with a connection. In other cases, `conn` is the SASL consumer's SASL

connection context. The `rpool` variable is used for random number generation functions. `getopt_context` is the context that should be used with the `getopt()` function.

See [`sasl_getopt_t\(3SASL\)`](#), [`sasl_log_t\(3SASL\)`](#), and [`sasl_getcallback_t\(3SASL\)`](#).

- `sasl_out_params_t` – `libsasl` creates the `sasl_out_params_t` structure and passes the structure to `mech_step()` in the client or server. This structure communicates the following information to `libsasl`: authentication status, the `authid`, the `authzid`, `maxbuf`, the negotiated `ssf`, and information for encoding and decoding data.
- `sasl_client_params_t` – The `sasl_client_params_t` structure is used by `libsasl` to pass the client state to a SASL client mechanism. The client mechanism's `mech_new()`, `mech_step()`, and `mech_idle()` entry points are used to send this state data. The `canon_user_client()` entry point also requires client state to be passed along.
- `sasl_server_params_t` – The `sasl_server_params_t` structure performs a similar function to `sasl_client_params_t` on the server side.

Client Plugins

Client plugins are used to manage the client-side of a SASL negotiation. Client plugins are usually packaged with the corresponding server plugins. A client plugin contains one or more client-side SASL mechanisms. Each SASL client mechanism supports authentication, and optionally integrity and confidentiality.

Each SASL client mechanism provides information about that mechanism's capabilities:

- Maximum SSF
- Maximum security flags
- Plugin features
- Callbacks and prompt IDs for using the plugin

Client plugins must export `sasl_client_plug_init()`. `libsasl` calls `sasl_client_plug_init()` to initialize the plugin for the client. The plugin returns a `sasl_client_plug_t` structure.

The `sasl_client_plug_t` provides the following entry points for `libsasl` to call the mechanism:

- `mech_new()` – The client starts a connection by calling `sasl_client_start()`, which uses `mech_new()`. `mech_new()` performs initialization that is specific to the mechanism. If necessary, a connection context is allocated.
- `mech_step()` – `mech_step()` can be called by `sasl_client_start()` and `sasl_client_step()`. `mech_step()` performs authentication on the client side after

`mech_new()` has been called. `mech_step()` returns `SASL_OK` if authentication is successful. `SASL_CONTINUE` is returned if more data is required. A SASL error code is returned if authentication fails. If an error occurs, then `seterror()` is called. If the authentication is successful, `mech_step()` must return the `sasl_out_params_t` structure with the relevant security layer information and callbacks. The `canon_user()` function is part of this structure. `canon_user()` must be called when the client receives the authentication and authorization IDs.

- `mech_dispose()` – `mech_dispose()` is called when the context can be safely closed. `mech_dispose()` is called by `sasl_dispose()`.
- `mech_free()` – `mech_free()` is called when `libsasl` shuts down. Any remaining global state for the plugin is freed by `mech_free()`.

Server Plugins

Server plugins are used to manage the server-side of a SASL negotiation. Server plugins are usually packaged with the corresponding client plugins. A server plugin contains one or more server-side SASL mechanisms. Each SASL server mechanism supports authentication, and optionally integrity and confidentiality.

Each SASL server mechanism provides information about that mechanism's capabilities:

- Maximum SSF
- Maximum security flags
- Plugin features
- Callbacks and prompt IDs for using the plugin

Server plugins must export `sasl_server_plug_init()`. `libsasl` calls `sasl_server_plug_init()` to initialize the plugin for the server. The plugin returns a `sasl_server_plug_t` structure.

The `sasl_server_plug_t` structure provides the following entry points for `libsasl` to call the mechanism:

- `mech_new()` – The server starts a connection by calling `sasl_server_start()`, which uses `mech_new()`. `mech_new()` performs initialization that is specific to the mechanism. If necessary, `mech_new()` allocates a connection context.
- `mech_step()` – `mech_step()` can be called by `sasl_server_start()` and `sasl_server_step()`. `mech_step()` performs authentication on the server-side after `mech_new()` has been called. `mech_step()` returns `SASL_OK` if authentication is successful. `SASL_CONTINUE` is returned if more data is required. A SASL error code is returned if authentication fails. If an error occurs, then `seterror()` is called. If the authentication is

successful, `mech_step()` must return the `sasl_out_params_t` structure with the relevant security layer information and callbacks. The `canon_user()` function is part of this structure. `canon_user()` must be called when the server receives the authentication and authorization IDs. Calling the `canon_user()` function causes `propctx` to be filled in. Any required auxiliary property requests should be performed before the authentication is canonicalized. Authorization ID lookups are performed after the authentication is canonicalized.

The `mech_step()` function must fill any related `sasl_out_params_t` fields before `SASL_OK` is returned. These fields perform the following functions:

- `doneflag` – Indicates a complete exchange
- `maxoutbuf` – Indicates maximum output size for a security layer
- `mech_ssf` – Supplied SSF for the security layer
- `encode()` – Called by `sasl_encode()`, `sasl_encodev()`, and `sasl_decode()`
- `decode()` – Called by `sasl_encode()`, `sasl_encodev()`, and `sasl_decode()`
- `encode_context()` – Called by `sasl_encode()`, `sasl_encodev()`, and `sasl_decode()`
- `decode_context()` – Called by `sasl_encode()`, `sasl_encodev()`, and `sasl_decode()`
- `mech_dispose()` – `mech_dispose()` is called when the context can be safely closed. `mech_dispose()` is called by `sasl_dispose()`.
- `mech_free()` – `mech_free()` is called when `libsasl` shuts down. Any remaining global state for the plugin is freed by `mech_free()`.
- `setpass()` sets a user's password. `setpass()` enables a mechanism to have an internal password.
- `mech_avail()` is called by `sasl_listmech()` to check if a mechanism is available for a given user. `mech_avail()` can create a new context and thus avoid a call to `mech_new()`. Use this method to create a context as long as performance is not affected.

User Canonicalization Plugins

A canonicalization plugin provides support for alternate canonicalization of authentication and authorization names for both the client and server-side. The `sasl_canonuser_plug_init()` is used to load canonicalization plugins.

A canonicalization plugin has the following requirements:

- The canonicalized name must be copied to the output buffers.
- The same input buffer can be used as an output buffer.
- A canonicalization plugin must function in cases where only authentication IDs or authorization IDs exist.

User canonicalization plugins must export a `sasl_canonuser_init()` function. The `sasl_canonuser_init()` function must return `sasl_canonuser_plug_t` to establish the necessary entry points. User canonicalization plugins must implement at least one of the `canon_user_client()` or `canon_user_server()` members of the `sasl_canonuser_plug_t` structure.

Auxiliary Property (auxprop) Plugins

Auxprop plugins provide support for the lookup of auxiliary properties for both `authid` and `authzid` for a SASL server. For example, an application might want to look up the user password for an internal authentication. The `sasl_auxprop_plug_init()` function is used to initialize auxprop plugins and returns the `sasl_auxprop_plug_t` structure.

To implement an auxprop plugin successfully, the `auxprop_lookup` member of the `sasl_auxprop_plug_t` structure must be implemented. The `auxprop_lookup()` function is called after canonicalization of the user name, with the canonicalized user name. The plugin can then do any lookups that are needed for the requested auxiliary properties.

Note - Oracle Corporation does not currently provide auxprop plugins.

SASL Plugin Development Guidelines

This section provides some additional pointers for developing SASL plugins.

Error Reporting in SASL Plugins

Good error reporting can help in tracking down authentication problems and in other debugging. Developers of plugins are encouraged to use the `sasl_seterror()` callback in the `sasl_utils_t` structure to supply detailed error information for a given connection.

Memory Allocation in SASL Plugins

The general rule for allocating memory in SASL is to free any memory that you have allocated when that memory is no longer needed. Following this rule improves performance and portability, and prevents memory leaks.

Setting the SASL Negotiation Sequence

A plugin mechanism can set the order in which a client and server conduct a SASL conversation through the following flags:

- `SASL_FEAT_WANT_CLIENT_FIRST` – The client side begins the interchange.
- `SASL_FEAT_WANT_SERVER_LAST` – The server sends the final data to the client.

If neither flag is set, the mechanism plugin sets the order internally. In this case, the mechanism must check both the client and server for data that needs to be sent. Note that the situation where the client sends first is only possible when the protocol permits an initial response.

The case in which the server sends last requires that the plugin set `*serverout` when the step function returns `SASL_OK`. Those mechanisms that never have the server send last must set `*serverout` to `NULL`. Those mechanisms that always have the server send last need to point `*serverout` to the success data.

Introduction to the Oracle Solaris Cryptographic Framework

The Cryptographic Framework is an architecture that enables applications in the Oracle Solaris operating system to use or provide cryptographic services. All interactions with the framework are based on the RSA Security Inc. PKCS#11 Cryptographic Token Interface (Cryptoki). PKCS#11 is a product by RSA Laboratories, the research arm of RSA Security Inc.

This chapter presents the following topics on the Cryptographic Framework:

- [“Overview of the Cryptographic Framework” on page 162](#)
- [“Components of the Cryptographic Framework” on page 163](#)
- [“What Cryptography Developers Need to Know” on page 165](#)

Oracle Solaris Cryptography Terminology

An application, library, or kernel module that obtains cryptographic services is called a *consumer*. An application that provides cryptographic services to consumers through the framework is referred to as a *provider* and also as a *plugin*. The software that implements a cryptographic operation is called a *mechanism*. A mechanism is not just the algorithm but includes the way in which the algorithm is to be applied. For example, the DES algorithm when applied to authentication is considered a separate mechanism. DES when applied to block by block encryption would be a different mechanism.

A *token* is the abstraction of a device that can perform cryptography. In addition, tokens can store information for use in cryptographic operations. A single token can support one or more mechanisms. Tokens can represent hardware, as in an accelerator board. Tokens that represent pure software are referred to as *soft tokens*. A token can be *plugged* into a *slot*, which continues the physical metaphor. A slot is the connecting point for applications that use cryptographic services.

In addition to specific slots for providers, the Oracle Solaris implementation provides a special slot called the *metaslot*. The metaslot is a component of the Oracle Solaris Cryptographic Framework library (`libpkcs11.so`). The metaslot serves as a single virtual slot with the combined capabilities of all tokens and slots that have been installed in the framework. Effectively, the metaslot enables an application to transparently connect with any available cryptographic service through a single slot. When an application requests a cryptographic service, the metaslot points to the most appropriate slot, which simplifies the process of selecting a slot. In some cases, a different slot might be required, in which case the application must perform a separate search explicitly. The metaslot is automatically enabled and can only be disabled through explicit action by the system administrator.

A *session* is a connection between an application that use cryptographic services and a token. The PKCS #11 standard uses two kinds of objects: token objects and session objects. *Session objects* are ephemeral, that is, objects that last only for the duration of a session. Objects that persist beyond the length of a session are referred to as *token objects*.

The default location for token objects is `$HOME/.sunw/pkcs11_softtoken`. Alternatively, token objects can be stored in `$SOFTTOKEN_DIR/pkcs11_softtoken`. Private token objects are protected by personal identification numbers (PIN). To create or change a token object requires that the user be authenticated, unless the user is accessing a private token object.

Overview of the Cryptographic Framework

The Cryptographic Framework is the portion of the Oracle Solaris OS that provides cryptographic services from Oracle Corporation and from third-party suppliers. The framework provides various services:

- Message encryption and message digest
- Message authentication codes (MACs)
- Digital signing
- Application programmer interfaces (APIs) for accessing cryptographic services
- Service provider interfaces (SPIs) for providing cryptographic services
- An administration command for managing cryptographic resources

[Figure 17, “Overview of the Oracle Solaris Cryptographic Framework,” on page 163](#) provides an overview of the cryptographic framework. The light gray shading in the figure indicates the user-level portion of the Cryptographic Framework. The dark gray shading represents the kernel-level portion of the framework.

FIGURE 17 Overview of the Oracle Solaris Cryptographic Framework

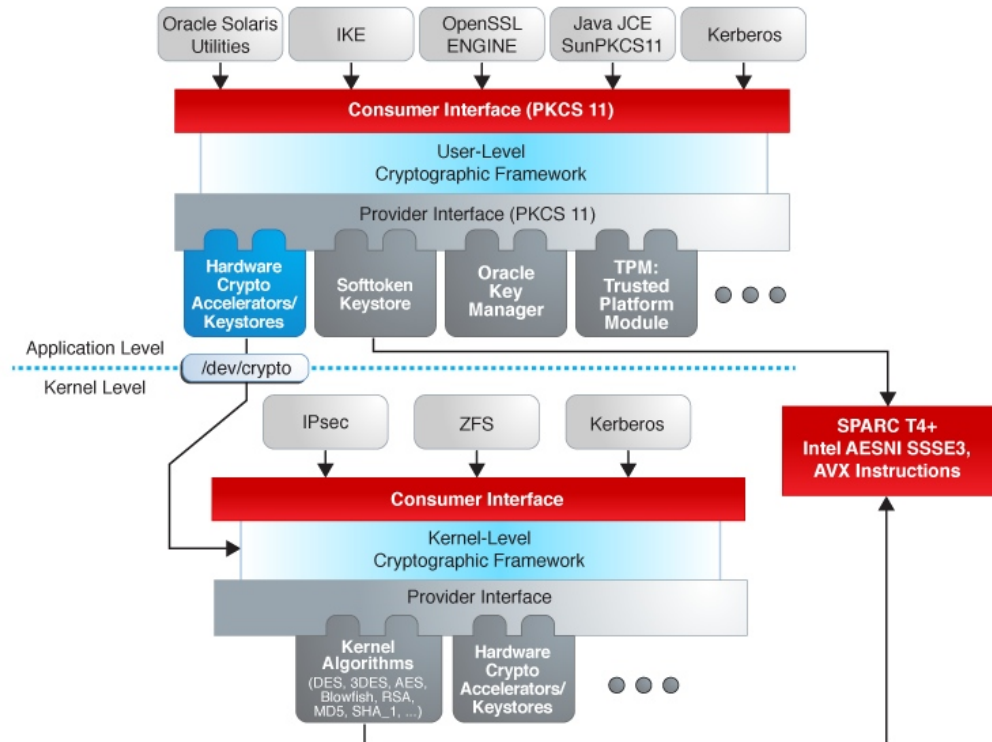

Components of the Cryptographic Framework

The components of the Cryptographic Framework are the following:

- `libpkcs11.so` – The framework provides access through the RSA Security Inc. PKCS #11 Cryptographic Token Interface (Cryptoki). Applications need to link to the `libpkcs11.so` library, which implements the RSA PKCS #11 of the standard.
- **Pluggable interface** – The pluggable interface is the service provider interface (SPI) for PKCS #11 cryptographic services that are provided by Oracle Corporation and third-party developers. Providers are user-level libraries. Providers are implemented through encryption services that are available from either hardware or software.

- `pkcs11_softtoken.so` – A private shared object that contains user-level cryptographic mechanisms that are provided by Oracle Corporation. The `pkcs11_softtoken(5)` library implements the RSA PKCS #11 v2.11 of the standard.
- `pkcs11_kernel.so` – The private shared object used to access kernel-level cryptographic mechanisms. `pkcs11_kernel(5)` implements the RSA PKCS#11 v2.11 specification. `pkcs11_kernel.so` offers a PKCS#11 user interface for cryptographic services that are plugged into the kernel's service provider interface.
- `/dev/crypto` **pseudo device driver** – The private pseudo device driver for using kernel-level cryptographic mechanisms. This information is provided to avoid inadvertent deletion of the pseudo device driver.
- **Scheduler / load balancer** – The kernel software that is responsible for coordinating use, load balancing, and dispatching of the cryptographic service requests.
- **Kernel programmer interface** – The interface for kernel-level consumers of cryptographic services. The IPsec protocol and the Kerberos GSS mechanism are typical cryptographic consumers.

Note - This interface is only available through a special contract with Oracle Corporation. Send email to solaris-crypto-req_ww@oracle.com for more information.

- **Oracle HW and SW cryptographic providers** – Kernel-level cryptographic services that are provided by Oracle Corporation. HW refers to hardware cryptographic services such as accelerator boards. SW refers to kernel modules that provide cryptographic services, such as an implementation of a cryptographic algorithm.
- **Kernel cryptographic framework daemon** – The private daemon that is responsible for managing system resources for cryptographic operations. The daemon is also responsible for verifying cryptographic providers.
- **Module verification library** – A private library used to verify the integrity and authenticity of all binaries that the Oracle Solaris Cryptographic Framework is importing.
- `elfsign` – A utility that can verify the signature of binaries, that is, elf objects, that plug into the Cryptographic Framework.
- `/dev/cryptoadm` **pseudo device driver** – The private pseudo device driver used by `cryptoadm(1M)` for administering kernel-level cryptographic mechanisms. This information is provided to avoid inadvertent deletion of the pseudo device driver.
- `cryptoadm` – A user-level command for administrators to manage cryptographic services. A typical `cryptoadm` task is listing cryptographic providers and their capabilities. Disabling and enabling cryptographic mechanisms according to security policy is also performed with `cryptoadm`.

What Cryptography Developers Need to Know

This section describes the requirements to develop the four types of applications that can plug into the Cryptographic Framework.

Requirements for Developers of User-Level Consumers

To develop a user-level consumer, do all of the following:

- Include `<security/cryptoki.h>`.
- Make all calls through the PKCS #11 interfaces only.
- Link with `libpkcs11.so`.
- Libraries should not call the `C_Finalize()` function.

See [Chapter 9, “Writing User-Level Cryptographic Applications”](#) for more information.

Requirements for Developers of User-Level Providers

To develop a user-level provider, a developer needs to keep the following items in mind:

- Design the provider to stand alone. Although the provider shared object need not be a full-fledged library to which applications link, all necessary symbols must exist in the provider. Assume that the provider is to be opened by `dlopen(3C)` in `RTLD_LAZY` mode.
- Create a PKCS #11 Cryptoki implementation in a shared object. This shared object should include necessary symbols rather than depend on consumer applications.
- It is highly recommended though not required to provide a `_fini()` routine for data cleanup. This method is required to avoid collisions between `C_Finalize()` calls when an application or shared library loads `libpkcs11` and other provider libraries concurrently.
- Package the shared object according to Oracle conventions.

For more information about how to use the Oracle Solaris Image Packaging System (IPS) feature to package software to install and update on Oracle Solaris 11 system, see [Packaging and Delivering Software With the Image Packaging System in Oracle Solaris 11.3](#).

Writing User-Level Cryptographic Applications

This chapter explains how to develop user-level applications and providers that use the PKCS #11 functions for cryptography.

The following topics are covered:

- “PKCS #11 Function List” on page 168
- “Functions for Using PKCS #11” on page 168
- “Message Digest Example” on page 175
- “Symmetric Encryption Example” on page 179
- “Sign and Verify Example” on page 183
- “Random Byte Generation Example” on page 191

For more information about the Cryptographic Framework, refer to [Chapter 8, “Introduction to the Oracle Solaris Cryptographic Framework”](#).

Overview of the Cryptoki Library

User-level applications in the Cryptographic Framework access PKCS #11 functions through the `cryptoki` library, which is provided in the `libpkcs11.so` module. The `pkcs11_softtoken.so` module is a PKCS #11 Soft Token implementation that is provided by Oracle Corporation to supply cryptographic mechanisms. The soft token plugin is the default source of mechanisms. Cryptographic mechanisms can also be supplied through third-party plugins.

This section lists the PKCS #11 functions and return values that are supported by the soft token. Return codes vary depending on the providers that are plugged into the framework. The section also describes some common functions. For a complete description of all the elements in the `cryptoki` library, refer to [libpkcs11\(3LIB\)](#).

Ensure that direct bindings are used for all providers. See [ld\(1\)](#) and the [Oracle Solaris 11.3 Linkers and Libraries Guide](#) for more information.

PKCS #11 Function List

The following list shows the categories of PKCS #11 functions that are supported by `pkcs11_softtoken.so` in the Cryptographic Framework with the associated functions:

- **General purpose** – `C_Initialize()`, `C_Finalize()`, `C_GetInfo()`, `C_GetFunctionList()`
- **Session management** – `C_OpenSession()`, `C_CloseSession()`, `C_GetSessionInfo()`, `C_CloseAllSessions()`, `C_Login()`, `C_Logout()`
- **Slot and token management** – `C_GetSlotList()`, `C_GetSlotInfo()`, `C_GetMechanismList()`, `C_GetMechanismInfo()`, `C_SetPIN()`
- **Encryption and decryption** – `C_EncryptInit()`, `C_Encrypt()`, `C_EncryptUpdate()`, `C_EncryptFinal()`, `C_DecryptInit()`, `C_Decrypt()`, `C_DecryptUpdate()`, `C_DecryptFinal()`
- **Message digesting** – `C_DigestInit()`, `C_Digest()`, `C_DigestKey()`, `C_DigestUpdate()`, `C_DigestFinal()`
- **Signing and applying MAC** – `C_Sign()`, `C_SignInit()`, `C_SignUpdate()`, `C_SignFinal()`, `C_SignRecoverInit()`, `C_SignRecover()`
- **Signature verification** – `C_Verify()`, `C_VerifyInit()`, `C_VerifyUpdate()`, `C_VerifyFinal()`, `C_VerifyRecoverInit()`, `C_VerifyRecover()`
- **Dual-purpose cryptographic functions** – `C_DigestEncryptUpdate()`, `C_DecryptDigestUpdate()`, `C_SignEncryptUpdate()`, `C_DecryptVerifyUpdate()`
- **Random number generation** – `C_SeedRandom()`, `C_GenerateRandom()`
- **Object management** – `C_CreateObject()`, `C_DestroyObject()`, `C_CopyObject()`, `C_FindObjects()`, `C_FindObjectsInit()`, `C_FindObjectsFinal()`, `C_GetAttributeValue()`, `C_SetAttributeValue()`
- **Key management** – `C_GenerateKey()`, `C_GenerateKeyPair()`, `C_DeriveKey()`

Functions for Using PKCS #11

This section provides descriptions of the following functions for using PKCS #11:

- [“PKCS #11 Functions: `C_Initialize\(\)`” on page 169](#)
- [“PKCS #11 Functions: `C_GetInfo\(\)`” on page 169](#)
- [“PKCS #11 Functions: `C_GetSlotList\(\)`” on page 170](#)
- [“PKCS #11 Functions: `C_GetTokenInfo\(\)`” on page 170](#)
- [“PKCS #11 Functions: `C_OpenSession\(\)`” on page 171](#)
- [“PKCS #11 Functions: `C_GetMechanismList\(\)`” on page 172](#)

Note - All the PKCS #11 functions are available from `libpkcs11.so` library. You do not have to use the `C_GetFunctionList()` function to get the list of functions available.

PKCS #11 Functions: `C_Initialize()`

`C_Initialize()` initializes the PKCS #11 library. `C_Initialize()` uses the following syntax:

```
C_Initialize(CK_VOID_PTR pInitArgs);
```

`pInitArgs` is either the null value `NULL_PTR` or else a pointer to a `CK_C_INITIALIZE_ARGS` structure. With `NULL_PTR`, the library uses the Oracle Solaris mutexes as locking primitives to arbitrate the access to internal shared structures between multiple threads. Note that the Cryptographic Framework does not accept mutexes. Because this implementation of the `cryptoki` library handles multithreading safely and efficiently, using `NULL_PTR` is recommended. An application can also use `pInitArgs` to set flags such as `CKF_LIBRARY_CANT_CREATE_OS_THREADS`. `C_Finalize()` signals that the application is through with the PKCS #11 library.

Note - `C_Finalize()` should never be called by libraries. By convention, applications are responsible for calling `C_Finalize()` to close out a session.

In addition to `CKR_FUNCTION_FAILED`, `CKR_GENERAL_ERROR`, `CKR_HOST_MEMORY`, and `CKR_OK`, `C_Initialize()` uses the following return values:

- `CKR_ARGUMENTS_BAD`
- `CKR_CANT_LOCK`
- `CKR_CRYPTOKI_ALREADY_INITIALIZED` (not fatal)

PKCS #11 Functions: `C_GetInfo()`

`C_GetInfo()` uses manufacturer and version information about the `cryptoki` library.

`C_GetInfo()` uses the following syntax:

```
C_GetInfo(CK_INFO_PTR pInfo);
```

`C_GetInfo()` returns the following values:

- `cryptokiVersion = 2, 11`
- `manufacturerID = Oracle Corporation.`

In addition to `CKR_FUNCTION_FAILED`, `CKR_GENERAL_ERROR`, `CKR_HOST_MEMORY`, and `CKR_OK`, `C_GetInfo()` gets the following return values:

- `CKR_ARGUMENTS_BAD`
- `CKR_CRYPTOKI_NOT_INITIALIZED`

PKCS #11 Functions: `C_GetSlotList()`

`C_GetSlotList()` uses a list of available slots. If no additional cryptographic providers have been installed other than `pkcs11_softtoken.so`, then `C_GetSlotList()` returns the default slot only. `C_GetSlotList()` uses the following syntax:

```
C_GetSlotList(CK_BBOOL tokenPresent, CK_SLOT_ID_PTR pSlotList,  
CK_ULONG_PTR pulCount);
```

When set to `TRUE`, `tokenPresent` limits the search to those slots whose tokens are present.

When `pSlotList` is set to `NULL_PTR`, `C_GetSlotList()` returns the number of slots only. `pulCount` is a pointer to the location to receive the slot count.

When `pSlotList` points to the buffer to receive the slots, `*pulCount` is set to the maximum expected number of `CK_SLOT_ID` elements. On return, `*pulCount` is set to the actual number of `CK_SLOT_ID` elements.

Typically, PKCS #11 applications call `C_GetSlotList()` twice. The first time, `C_GetSlotList()` is called to get the number of slots for memory allocation. The second time, `C_GetSlotList()` is called to retrieve the slots.

Note - The order of the slots is not guaranteed and can vary with each load of the PKCS #11 library.

In addition to `CKR_FUNCTION_FAILED`, `CKR_GENERAL_ERROR`, `CKR_HOST_MEMORY`, and `CKR_OK`, `C_GetSlotList()` gets the following return values:

- `CKR_ARGUMENTS_BAD`
- `CKR_BUFFER_TOO_SMALL`
- `CKR_CRYPTOKI_NOT_INITIALIZED`

PKCS #11 Functions: `C_GetTokenInfo()`

`C_GetTokenInfo()` gets information about a specific token. `C_GetTokenInfo()` uses the following syntax:

```
C_GetTokenInfo(CK_SLOT_ID slotID, CK_TOKEN_INFO_PTR pInfo);
```

slotID identifies the slot for the token. slotID has to be a valid ID that was returned by C_GetSlotList(). pInfo is a pointer to the location to receive the token information.

If pkcs11_softtoken.so is the only installed provider, then C_GetTokenInfo() returns the following fields and values:

- label – Sun Software PKCS#11 softtoken.
- flags – CKF_DUAL_CRYPT_OPERATIONS, CKF_TOKEN_INITIALIZED, CKF_RNG, CKF_USER_PIN_INITIALIZED, and CKF_LOGIN_REQUIRED, which are set to 1.
- ulMaxSessionCount – Set to CK_EFFECTIVELY_INFINITE.
- ulMaxRwSessionCount – Set to CK_EFFECTIVELY_INFINITE.
- ulMaxPinLen – Set to 256.
- ulMinPinLen – Set to 1.
- ulTotalPublicMemory set to CK_UNAVAILABLE_INFORMATION.
- ulFreePublicMemory set to CK_UNAVAILABLE_INFORMATION.
- ulTotalPrivateMemory set to CK_UNAVAILABLE_INFORMATION.
- ulFreePrivateMemory set to CK_UNAVAILABLE_INFORMATION.

In addition to CKR_FUNCTION_FAILED, CKR_GENERAL_ERROR, CKR_HOST_MEMORY, and CKR_OK, C_GetSlotList() gets the following return values:

- CKR_ARGUMENTS_BAD
- CKR_BUFFER_TOO_SMALL
- CKR_CRYPTOKI_NOT_INITIALIZED
- CKR_SLOT_ID_INVALID

The following return values are relevant for plugins with hardware tokens:

- CKR_DEVICE_ERROR
- CKR_DEVICE_MEMORY
- CKR_DEVICE_REMOVED
- CKR_TOKEN_NOT_PRESENT
- CKR_TOKEN_NOT_RECOGNIZED

PKCS #11 Functions: C_OpenSession()

C_OpenSession() enables an application to start a cryptographic session with a specific token in a specific slot. C_OpenSession() uses the following syntax:

```
C_OpenSession(CK_SLOT_ID slotID, CK_FLAGS flags, CK_VOID_PTR pApplication,
```

```
CK_NOTIFY Notify, CK_SESSION_HANDLE_PTR phSession);
```

slotID identifies the slot. *flags* indicates whether the session is read-write or read-only. *pApplication* is a pointer that is defined by the application for use in callbacks. *Notify* holds the address of an optional callback function. *phSession* is a pointer to the location of the session handle.

In addition to `CKR_FUNCTION_FAILED`, `CKR_GENERAL_ERROR`, `CKR_HOST_MEMORY`, and `CKR_OK`, `C_OpenSession()` gets the following return values:

- `CKR_ARGUMENTS_BAD`
- `CKR_CRYPTOKI_NOT_INITIALIZED`
- `CKR_SLOT_ID_INVALID`
- `CKR_TOKEN_WRITE_PROTECTED` (occurs with write-protected tokens)

The following return values are relevant for plugins with hardware tokens:

- `CKR_DEVICE_ERROR`
- `CKR_DEVICE_MEMORY`
- `CKR_DEVICE_REMOVED`
- `CKR_SESSION_COUNT`
- `CKR_SESSION_PARALLEL_NOT_SUPPORTED`
- `CKR_SESSION_READ_WRITE_SO_EXISTS`
- `CKR_TOKEN_NOT_PRESENT`
- `CKR_TOKEN_NOT_RECOGNIZED`

PKCS #11 Functions: `C_GetMechanismList()`

`C_GetMechanismList()` gets a list of mechanism types that are supported by the specified token. `C_GetMechanismList()` uses the following syntax:

```
C_GetMechanismList(CK_SLOT_ID slotID, CK_MECHANISM_TYPE_PTR pMechanismList,
CK_ULONG_PTR pulCount);
```

slotID identifies the slot for the token. *pulCount* is a pointer to the location to receive the number of mechanisms. When *pMechanismList* is set to `NULL_PTR`, the number of mechanisms is returned in **pulCount*. Otherwise, **pulCount* must be set to the size of the list and *pMechanismList* points to the buffer to hold the list.

When PKCS #11 Soft Token is plugged in, `C_GetMechanismList()` returns the following list of supported mechanisms:

- `CKM_AES_CBC`
- `CKM_AES_CBC_PAD`

- CKM_AES_ECB
- CKM_AES_KEY_GEN
- CKM_DES_CBC
- CKM_DES_CBC_PAD
- CKM_DES_ECB
- CKM_DES_KEY_GEN
- CKM_DES_MAC
- CKM_DES_MAC_GENERAL
- CKM_DES3_CBC
- CKM_DES3_CBC_PAD
- CKM_DES3_ECB
- CKM_DES3_KEY_GEN
- CKM_DH_PKCS_DERIVE
- CKM_DH_PKCS_KEY_PAIR_GEN
- CKM_DSA
- CKM_DSA_KEY_PAIR_GEN
- CKM_DSA_SHA_1
- CKM_MD5
- CKM_MD5_KEY_DERIVATION
- CKM_MD5_RSA_PKCS
- CKM_MD5_HMAC
- CKM_MD5_HMAC_GENERAL
- CKM_PBE_SHA1_RC4_128
- CKM_PKCS5_PBKD2
- CKM_RC4
- CKM_RC4_KEY_GEN
- CKM_RSA_PKCS
- CKM_RSA_X_509
- CKM_RSA_PKCS_KEY_PAIR_GEN
- CKM_SHA_1
- CKM_SHA_1_HMAC_GENERAL
- CKM_SHA_1_HMAC
- CKM_SHA_1_KEY_DERIVATION
- CKM_SHA_1_RSA_PKCS
- CKM_SSL3_KEY_AND_MAC_DERIVE

- CKM_SSL3_MASTER_KEY_DERIVE
- CKM_SSL3_MASTER_KEY_DERIVE_DH
- CKM_SSL3_MD5_MAC
- CKM_SSL3_PRE_MASTER_KEY_GEN
- CKM_SSL3_SHA1_MAC
- CKM_TLS_KEY_AND_MAC_DERIVE
- CKM_TLS_MASTER_KEY_DERIVE
- CKM_TLS_MASTER_KEY_DERIVE_DH
- CKM_TLS_PRE_MASTER_KEY_GEN

In addition to CKR_FUNCTION_FAILED, CKR_GENERAL_ERROR, CKR_HOST_MEMORY, and CKR_OK, C_GetSlotList() uses the following return values:

- CKR_ARGUMENTS_BAD
- CKR_BUFFER_TOO_SMALL
- CKR_CRYPTOKI_NOT_INITIALIZED
- CKR_SLOT_ID_INVALID

The following return values are relevant for plugins with hardware tokens:

- CKR_DEVICE_ERROR
- CKR_DEVICE_MEMORY
- CKR_DEVICE_REMOVED
- CKR_TOKEN_NOT_PRESENT
- CKR_TOKEN_NOT_RECOGNIZED

Extended PKCS #11 Functions

In addition to the standard PKCS #11 functions, two convenience functions are supplied with the Cryptographic Framework:

- [“Extended PKCS #11 Functions: SUNW_C_GetMechSession\(\)” on page 174](#)
- [“Extended PKCS #11 Functions: SUNW_C_KeyToObject” on page 175](#)

Extended PKCS #11 Functions: SUNW_C_GetMechSession()

SUNW_C_GetMechSession() is a convenience function that initializes the Cryptographic Framework. The function then starts a session with the specified mechanism.

SUNW_C_GetMechSession() uses the following syntax:

```
SUNW_C_GetMechSession(CK_MECHANISM_TYPE mech, C\  
K_SESSION_HANDLE_PTR hSession)
```

The `mech` parameter is used to specify the mechanism to be used. `hSession` is a pointer to the session location.

Internally, `SUNW_C_GetMechSession()` calls `C_Initialize()` to initialize the `cryptoki` library. `SUNW_C_GetMechSession()` next calls `C_GetSlotList()` and `C_GetMechanismInfo()` to search through the available slots for a token with the specified mechanism. When the mechanism is found, `SUNW_C_GetMechSession()` calls `C_OpenSession()` to open a session.

The `SUNW_C_GetMechSession()` only needs to be called once. However, calling `SUNW_C_GetMechSession()` multiple times does not cause any problems.

Extended PKCS #11 Functions: SUNW_C_KeyToObject

`SUNW_C_KeyToObject()` creates a secret key object. The calling program must specify the mechanism to be used and raw key data. Internally, `SUNW_C_KeyToObject()` determines the type of key for the specified mechanism. A generic key object is created through `C_CreateObject()`. `SUNW_C_KeyToObject()` next calls `C_GetSessionInfo()` and `C_GetMechanismInfo()` to get the slot and mechanism. `C_SetAttributeValue()` then sets the attribute flag for the key object according to the type of mechanism.

User-Level Cryptographic Application Examples

This section includes the following examples:

- [“Message Digest Example” on page 175](#)
- [“Symmetric Encryption Example” on page 179](#)
- [“Sign and Verify Example” on page 183](#)
- [“Random Byte Generation Example” on page 191](#)

Message Digest Example

This example uses PKCS #11 functions to create a digest from an input file. The example performs the following steps:

1. Specifies the digest mechanism.

In this example, the `CKM_SHA256` digest mechanism is used.

2. Finds a slot that is capable of the specified digest algorithm.

This example uses the Oracle Solaris convenience function `SUNW_C_GetMechSession()`. `SUNW_C_GetMechSession()` opens the `cryptoki` library, which holds all the PKCS #11 functions that are used in the Cryptographic Framework. `SUNW_C_GetMechSession()` then finds the slot with the desired mechanism. The session is then started. Effectively, this convenience function replaces the `C_Initialize()` call, the `C_OpenSession()` call, and any code needed to find a slot that supports the specified mechanism.

3. Obtains cryptoki information.

This part is not actually needed to create the message digest, but is included to demonstrate use of the `C_GetInfo()` function. This example gets the manufacturer ID. The other information options retrieve version and library data.

4. Conducts a digest operation with the slot.

The message digest is created in this task through these steps:

- a. Opening the input file.
- b. Initializing the digest operation by calling `C_DigestInit()`.
- c. Processing the data a piece at a time with `C_DigestUpdate()`.
- d. Ending the digest process by using `C_DigestFinal()` to get the complete digest.

5. Ends the session.

The program uses `C_CloseSession()` to close the session and `C_Finalize()` to close the library.

The source code for the message digest example is shown in the following example.

EXAMPLE 26 Creating a Message Digest by Using PKCS #11 Functions

```
#include <stdio.h>
#include <fcntl.h>
#include <errno.h>
#include <sys/types.h>
#include <security/cryptoki.h>
#include <security/pkcs11.h>

#define BUFFERSIZ 8192
#define MAXDIGEST 64

/* Calculate the digest of a user supplied file. */
void
main(int argc, char **argv)
{
    CK_BYTE digest[MAXDIGEST];
    CK_INFO info;
```



```
CK_MECHANISM mechanism;
CK_SESSION_HANDLE hSession;
CK_SESSION_INFO Info;
CK_ULONG ulDataLen = BUFFERSIZ;
CK_ULONG ulDigestLen = MAXDIGEST;
CK_RV rv;
CK_SLOT_ID SlotID;

int i, bytes_read = 0;
char inbuf[BUFFERSIZ];
FILE *fs;
int error = 0;

/* Specify the CKM_SHA256 digest mechanism as the target */
mechanism.mechanism = CKM_SHA256;
mechanism.pParameter = NULL_PTR;
mechanism.ulParameterLen = 0;

/* Use SUNW convenience function to initialize the cryptoki
 * library, and open a session with a slot that supports
 * the mechanism we plan on using. */
rv = SUNW_C_GetMechSession(mechanism.mechanism, &hSession);
if (rv != CKR_OK) {
    fprintf(stderr, "SUNW_C_GetMechSession: rv = 0x%.8X\n", rv);
    exit(1);
}

/* Get cryptoki information, the manufacturer ID */
rv = C_GetInfo(&info);
if (rv != CKR_OK) {
    fprintf(stderr, "WARNING: C_GetInfo: rv = 0x%.8X\n", rv);
}
fprintf(stdout, "Manufacturer ID = %s\n", info.manufacturerID);

/* Open the input file */
if ((fs = fopen(argv[1], "r")) == NULL) {
    perror("fopen");
    fprintf(stderr, "\n\tusage: %s filename>\n", argv[0]);
    error = 1;
    goto exit_session;
}

/* Initialize the digest session */
if ((rv = C_DigestInit(hSession, &mechanism)) != CKR_OK) {
    fprintf(stderr, "C_DigestInit: rv = 0x%.8X\n", rv);
    error = 1;
    goto exit_digest;
}
```

```
/* Read in the data and create digest of this portion */
while (!feof(fs) && (ulDataLen = fread(inbuf, 1, BUFFERSIZ, fs)) > 0) {
    if ((rv = C_DigestUpdate(hSession, (CK_BYTE_PTR)inbuf,
        ulDataLen)) != CKR_OK) {
        fprintf(stderr, "C_DigestUpdate: rv = 0x%.8X\n", rv);
        error = 1;
        goto exit_digest;
    }
    bytes_read += ulDataLen;
}
fprintf(stdout, "%d bytes read and digested!!!\n\n", bytes_read);

/* Get complete digest */
ulDigestLen = sizeof (digest);
if ((rv = C_DigestFinal(hSession, (CK_BYTE_PTR)digest,
    &ulDigestLen)) != CKR_OK) {
    fprintf(stderr, "C_DigestFinal: rv = 0x%.8X\n", rv);
    error = 1;
    goto exit_digest;
}

/* Print the results */
fprintf(stdout, "The value of the digest is: ");
for (i = 0; i < ulDigestLen; i++) {
    fprintf(stdout, "%.2x", digest[i]);
}
fprintf(stdout, "\nDone!!!\n");

exit_digest:
    fclose(fs);

exit_session:
    (void) C_CloseSession(hSession);

exit_program:
    (void) C_Finalize(NULL_PTR);

    exit(error);
}
```

Symmetric Encryption Example

Example 27, “Creating an Encryption Key Object by Using PKCS #11 Functions,” on page 180 creates a key object for encryption with the DES algorithm in CBC mode. This source code performs the following steps:

1. Declares key materials.
Defines DES and initialization vector. The initialization vector is declared statically for demonstration purposes only. Initialization vectors should always be defined dynamically and never reused.
2. Defines a key object.
For this task, you have to set up a template for the key.
3. Finds a slot that is capable of the specified encryption mechanism.
This example uses the Oracle Solaris convenience function `SUNW_C_GetMechSession()`. `SUNW_C_GetMechSession()` opens the `cryptoki` library, which holds all the PKCS #11 functions that are used in the Cryptographic Framework. `SUNW_C_GetMechSession()` then finds the slot with the desired mechanism. The session is then started. Effectively, this convenience function replaces the `C_Initialize()` call, the `C_OpenSession()` call, and any code needed to find a slot that supports the specified mechanism.
4. Conducts an encryption operation in the slot.
The encryption is performed in this task through these steps:
 - a. Opening the input file.
 - b. Creating an object handle for the key.
 - c. Setting the encryption mechanism to `CKM_DES_CBC_PAD` by using the mechanism structure.
 - d. Initializing the encryption operation by calling `C_EncryptInit()`.
 - e. Processing the data a piece at a time with `C_EncryptUpdate()`.
 - f. Ending the encryption process by using `C_EncryptFinal()` to get the last portion of the encrypted data.
5. Conducts a decryption operation in the slot.
The decryption is performed in this task through these steps. The decryption is provided for testing purposes only.
 - a. Initializes the decryption operation by calling `C_DecryptInit()`.
 - b. Processes the entire string with `C_Decrypt()`.
6. Ends the session.
The program uses `C_CloseSession()` to close the session and `C_Finalize()` to close the library.

The source code for the symmetric encryption example is shown in the following example.

EXAMPLE 27 Creating an Encryption Key Object by Using PKCS #11 Functions

```
#include <stdio.h>
#include <fcntl.h>
#include <errno.h>
#include <sys/types.h>
#include <security/cryptoki.h>
#include <security/pkcs11.h>

#define BUFFERSIZ 8192

/* Declare values for the key materials. DO NOT declare initialization
 * vectors statically like this in real life!! */
uchar_t des_key[] = { 0x01, 0x23, 0x45, 0x67, 0x89, 0xab, 0xcd, 0xef};
uchar_t des_cbc_iv[] = { 0x12, 0x34, 0x56, 0x78, 0x90, 0xab, 0xcd, 0xef};

/* Key template related definitions. */
static CK_BBOOL truevalue = TRUE;
static CK_BBOOL falsevalue = FALSE;
static CK_OBJECT_CLASS class = CKO_SECRET_KEY;
static CK_KEY_TYPE keyType = CKK_DES;

/* Example encrypts and decrypts a file provided by the user. */
void
main(int argc, char **argv)
{
    CK_RV rv;
    CK_MECHANISM mechanism;
    CK_OBJECT_HANDLE hKey;
    CK_SESSION_HANDLE hSession;
    CK_ULONG ciphertext_len = 64, lastpart_len = 64;
    long ciphertext_space = BUFFERSIZ;
    CK_ULONG decrypttext_len;
    CK_ULONG total_encrypted = 0;
    CK_ULONG ulDataLen = BUFFERSIZ;

    int i, bytes_read = 0;
    int error = 0;
    char inbuf[BUFFERSIZ];
    FILE *fs;
    uchar_t ciphertext[BUFFERSIZ], *pciphertext, decrypttext[BUFFERSIZ];

    /* Set the key object */
    CK_ATTRIBUTE template[] = {
```

```

{CKA_CLASS, &class, sizeof (class) },
{CKA_KEY_TYPE, &keyType, sizeof (keyType) },
{CKA_TOKEN, &>falsevalue, sizeof (falsevalue) },
{CKA_ENCRYPT, &>truevalue, sizeof (truevalue) },
{CKA_VALUE, &des_key, sizeof (des_key) }
};

/* Set the encryption mechanism to CKM_DES_CBC_PAD */
mechanism.mechanism = CKM_DES_CBC_PAD;
mechanism.pParameter = des_cbc_iv;
mechanism.ulParameterLen = 8;

/* Use SUNW convenience function to initialize the cryptoki
 * library, and open a session with a slot that supports
 * the mechanism we plan on using. */
rv = SUNW_C_GetMechSession(mechanism.mechanism, &hSession);

if (rv != CKR_OK) {
    fprintf(stderr, "SUNW_C_GetMechSession: rv = 0x%.8X\n", rv);
    exit(1);
}

/* Open the input file */
if ((fs = fopen(argv[1], "r")) == NULL) {
    perror("fopen");
    fprintf(stderr, "\n\tusage: %s filename>\n", argv[0]);
    error = 1;
    goto exit_session;
}

/* Create an object handle for the key */
rv = C_CreateObject(hSession, template,
    sizeof (template) / sizeof (CK_ATTRIBUTE),
    &hKey);

if (rv != CKR_OK) {
    fprintf(stderr, "C_CreateObject: rv = 0x%.8X\n", rv);
    error = 1;
    goto exit_session;
}

/* Initialize the encryption operation in the session */
rv = C_EncryptInit(hSession, &mechanism, hKey);

if (rv != CKR_OK) {
    fprintf(stderr, "C_EncryptInit: rv = 0x%.8X\n", rv);
    error = 1;
}

```

```
    goto exit_session;
}

/* Read in the data and encrypt this portion */
pciphertext = &ciphertext[0];
while (!feof(fs) && (ciphertext_space > 0) &&
      (ulDatalen = fread(inbuf, 1, ciphertext_space, fs) > 0) {
    ciphertext_len = ciphertext_space;

    /* C_EncryptUpdate is only being sent one byte at a
     * time, so we are not checking for CKR_BUFFER_TOO_SMALL.
     * Also, we are checking to make sure we do not go
     * over the allotted buffer size. A more robust program
     * could incorporate realloc to enlarge the buffer
     * dynamically. */
    rv = C_EncryptUpdate(hSession, (CK_BYTE_PTR)inbuf, ulDatalen,
                        pciphertext, &ciphertext_len);
    if (rv != CKR_OK) {
        fprintf(stderr, "C_EncryptUpdate: rv = 0x%.8X\n", rv);
        error = 1;
        goto exit_encrypt;
    }
    pciphertext += ciphertext_len;
    total_encrypted += ciphertext_len;
    ciphertext_space -= ciphertext_len;
    bytes_read += ulDatalen;
}

if (!feof(fs) || (ciphertext_space < 0)) {
    fprintf(stderr, "Insufficient space for encrypting the file\n");
    error = 1;
    goto exit_encrypt;
}

/* Get the last portion of the encrypted data */
lastpart_len = ciphertext_space;
rv = C_EncryptFinal(hSession, pciphertext, &lastpart_len);
if (rv != CKR_OK) {
    fprintf(stderr, "C_EncryptFinal: rv = 0x%.8X\n", rv);
    error = 1;
    goto exit_encrypt;
}
total_encrypted += lastpart_len;

fprintf(stdout, "%d bytes read and encrypted. Size of the "
          "ciphertext: %d!\n\n", bytes_read, total_encrypted);

/* Print the encryption results */
```

```

fprintf(stdout, "The value of the encryption is:\n");
for (i = 0; i < ciphertext_len; i++) {
    if (ciphertext[i] < 16)
        fprintf(stdout, "0%x", ciphertext[i]);
    else
        fprintf(stdout, "%2x", ciphertext[i]);
}

/* Initialize the decryption operation in the session */
rv = C_DecryptInit(hSession, &mechanism, hKey);

/* Decrypt the entire ciphertext string */
decrypttext_len = sizeof (decrypttext);
rv = C_Decrypt(hSession, (CK_BYTE_PTR)ciphertext, total_encrypted,
               decrypttext, &decrypttext_len);

if (rv != CKR_OK) {
    fprintf(stderr, "C_Decrypt: rv = 0x%.8X\n", rv);
    error = 1;
    goto exit_encrypt;
}

fprintf(stdout, "\n\n%d bytes decrypted!!!\n\n", decrypttext_len);

/* Print the decryption results */
fprintf(stdout, "The value of the decryption is:\n%s", decrypttext);

fprintf(stdout, "\nDone!!!\n");

exit_encrypt:
    fclose(fs);

exit_session:
    (void) C_CloseSession(hSession);

exit_program:
    (void) C_Finalize(NULL_PTR);
    exit(error);
}

```

Sign and Verify Example

The example in this section generates an RSA key pair. The key pair is used to sign and verify a simple string. The example goes through the following steps:

1. Defines a key object.

2. Sets the public key template.
3. Sets the private key template.
4. Creates a sample message.
5. Specifies the `genmech` mechanism, which generates the key pair.
6. Specifies the `smech` mechanism, which signs the key pair.
7. Initializes the `cryptoki` library.
8. Finds a slot with mechanisms for signing, verifying, and key pair generation.

The task uses a function that is called `getMySlot()`, which performs the following steps:

- a. Calling the function `C_GetSlotList()` to get a list of the available slots.
`C_GetSlotList()` is called twice, as the PKCS #11 convention suggests. `C_GetSlotList()` is called the first time to get the number of slots for memory allocation. `C_GetSlotList()` is called the second time to retrieve the slots.

- b. Finding a slot that can supply the desired mechanisms.

For each slot, the function calls `GetMechanismInfo()` to find mechanisms for signing and for key pair generation. If the mechanisms are not supported by the slot, `GetMechanismInfo()` returns an error. If `GetMechanismInfo()` returns successfully, then the mechanism flags are checked to make sure the mechanisms can perform the needed operations.

9. Opens the session by calling `C_OpenSession()`.
10. Generates the key pair by using `C_GenerateKeyPair()`.
11. Displays the public key with `C_GetAttributeValue()` – For demonstration purposes only.
12. Signing is started with `C_SignInit()` and completed with `C_Sign()`.
13. Verification is started with `C_VerifyInit()` and completed with `C_Verify()`.
14. Closes the session.

The program uses `C_CloseSession()` to close the session and `C_Finalize()` to close the library.

The source code for the sign-and-verify example follows.

EXAMPLE 28 Signing and Verifying Text by Using PKCS #11 Functions

```
#include <stdio.h>
#include <fcntl.h>
#include <errno.h>
#include <strings.h>
#include <sys/types.h>
#include <security/cryptoki.h>
#include <security/pkcs11.h>
```



```

#define BUFFERSIZ 8192

/* Define key template */
static CK_BBOOL truevalue = TRUE;
static CK_BBOOL falsevalue = FALSE;
static CK_ULONG modulusbits = 1024;
static CK_BYTE public_exponent[] = {0x01, 0x00, 0x01};

boolean_t GetMySlot(CK_MECHANISM_TYPE sv_mech, CK_MECHANISM_TYPE kpgen_mech,
    CK_SLOT_ID_PTR pslot);

/* Example signs and verifies a simple string, using a public/private
 * key pair. */
void
main(int argc, char *argv[])
{
    CK_RV    rv;
    CK_MECHANISM genmech, smech;
    CK_SESSION_HANDLE hSession;
    CK_SESSION_INFO sessInfo;
    CK_SLOT_ID slotID;
    int error, i = 0;

    CK_OBJECT_HANDLE privatekey, publickey;

    /* Set public key. */
    CK_ATTRIBUTE publickey_template[] = {
        {CKA_VERIFY, &>truevalue, sizeof (truevalue)},
        {CKA_MODULUS_BITS, &modulusbits, sizeof (modulusbits)},
        {CKA_PUBLIC_EXPONENT, &public_exponent,
         sizeof (public_exponent)}
    };

    /* Set private key. */
    CK_ATTRIBUTE privatekey_template[] = {
        {CKA_SIGN, &>truevalue, sizeof (truevalue)},
        {CKA_TOKEN, &>falsevalue, sizeof (falsevalue)},
        {CKA_SENSITIVE, &>truevalue, sizeof (truevalue)},
        {CKA_EXTRACTABLE, &>truevalue, sizeof (truevalue)}
    };

    /* Create sample message. */
    CK_ATTRIBUTE getattributes[] = {
        {CKA_MODULUS_BITS, NULL_PTR, 0},
        {CKA_MODULUS, NULL_PTR, 0},
        {CKA_PUBLIC_EXPONENT, NULL_PTR, 0}
    };

```

```
CK_ULONG messagelen, slen, template_size;

boolean_t found_slot = B_FALSE;
uchar_t *message = (uchar_t *)"Simple message for signing & verifying.";
uchar_t *modulus, *pub_exponent;
char sign[BUFFERSIZ];
slen = BUFFERSIZ;

messagelen = strlen((char *)message);

/* Set up mechanism for generating key pair */
genmech.mechanism = CKM_RSA_PKCS_KEY_PAIR_GEN;
genmech.pParameter = NULL_PTR;
genmech.ulParameterLen = 0;

/* Set up the signing mechanism */
smech.mechanism = CKM_RSA_PKCS;
smech.pParameter = NULL_PTR;
smech.ulParameterLen = 0;

/* Initialize the CRYPTOKI library */
rv = C_Initialize(NULL_PTR);

if (rv != CKR_OK) {
    fprintf(stderr, "C_Initialize: Error = 0x%.8X\n", rv);
    exit(1);
}

found_slot = GetMySlot(smech.mechanism, genmech.mechanism, &slotID);

if (!found_slot) {
    fprintf(stderr, "No usable slot was found.\n");
    goto exit_program;
}

fprintf(stdout, "selected slot: %d\n", slotID);

/* Open a session on the slot found */
rv = C_OpenSession(slotID, CKF_SERIAL_SESSION, NULL_PTR, NULL_PTR,
    &hSession);

if (rv != CKR_OK) {
    fprintf(stderr, "C_OpenSession: rv = 0x%.8X\n", rv);
    error = 1;
    goto exit_program;
}

fprintf(stdout, "Generating keypair....\n");
```

```
/* Generate Key pair for signing/verifying */
rv = C_GenerateKeyPair(hSession, &genmech, publickey_template,
    (sizeof (publickey_template) / sizeof (CK_ATTRIBUTE)),
    privatekey_template,
    (sizeof (privatekey_template) / sizeof (CK_ATTRIBUTE)),
    &publickey, &privatekey);

if (rv != CKR_OK) {
    fprintf(stderr, "C_GenerateKeyPair: rv = 0x%.8X\n", rv);
    error = 1;
    goto exit_session;
}

/* Display the publickey. */
template_size = sizeof (getattributes) / sizeof (CK_ATTRIBUTE);

rv = C_GetAttributeValue(hSession, publickey, getattributes,
    template_size);

if (rv != CKR_OK) {
    /* not fatal, we can still sign/verify if this failed */
    fprintf(stderr, "C_GetAttributeValue: rv = 0x%.8X\n", rv);
    error = 1;
} else {
    /* Allocate memory to hold the data we want */
    for (i = 0; i < template_size; i++) {
        getattributes[i].pValue =
            malloc (getattributes[i].ulValueLen *
                sizeof(CK_VOID_PTR));
        if (getattributes[i].pValue == NULL) {
            int j;
            for (j = 0; j < i; j++)
                free(getattributes[j].pValue);
            goto sign_cont;
        }
    }
}

/* Call again to get actual attributes */
rv = C_GetAttributeValue(hSession, publickey, getattributes,
    template_size);

if (rv != CKR_OK) {
    /* not fatal, we can still sign/verify if failed */
    fprintf(stderr,
        "C_GetAttributeValue: rv = 0x%.8X\n", rv);
    error = 1;
} else {
```

```
/* Display public key values */
fprintf(stdout, "Public Key data:\n\tModulus bits: "
        "%d\n",
        *((CK_ULONG_PTR)(getattributes[0].pValue)));

fprintf(stdout, "\tModulus: ");
modulus = (uchar_t *)getattributes[1].pValue;
for (i = 0; i < getattributes[1].ulValueLen; i++) {
    fprintf(stdout, "%.2x", modulus[i]);
}

fprintf(stdout, "\n\tPublic Exponent: ");
pub_exponent = (uchar_t *)getattributes[2].pValue;
for (i = 0; i < getattributes[2].ulValueLen; i++) {
    fprintf(stdout, "%.2x", pub_exponent[i]);
}
fprintf(stdout, "\n");
}
}

sign_cont:
rv = C_SignInit(hSession, &smech, privatekey);

if (rv != CKR_OK) {
    fprintf(stderr, "C_SignInit: rv = 0x%.8X\n", rv);
    error = 1;
    goto exit_session;
}

rv = C_Sign(hSession, (CK_BYTE_PTR)message, messagelen,
           (CK_BYTE_PTR)sign, &slen);

if (rv != CKR_OK) {
    fprintf(stderr, "C_Sign: rv = 0x%.8X\n", rv);
    error = 1;
    goto exit_session;
}

fprintf(stdout, "Message was successfully signed with private key!\n");

rv = C_VerifyInit(hSession, &smech, publickey);

if (rv != CKR_OK) {
    fprintf(stderr, "C_VerifyInit: rv = 0x%.8X\n", rv);
    error = 1;
    goto exit_session;
}
```

```

rv = C_Verify(hSession, (CK_BYTE_PTR)message, messagelen,
             (CK_BYTE_PTR)sign, slen);

if (rv != CKR_OK) {
    fprintf(stderr, "C_Verify: rv = 0x%.8X\n", rv);
    error = 1;
    goto exit_session;
}

fprintf(stdout, "Message was successfully verified with public key!\n");

exit_session:
(void) C_CloseSession(hSession);

exit_program:
(void) C_Finalize(NULL_PTR);

for (i = 0; i < template_size; i++) {
    if (getattributes[i].pValue != NULL)
        free(getattributes[i].pValue);
}

exit(error);
}

/* Find a slot capable of:
 * . signing and verifying with sv_mech
 * . generating a key pair with kpgen_mech
 * Returns B_TRUE when successful. */
boolean_t GetMySlot(CK_MECHANISM_TYPE sv_mech, CK_MECHANISM_TYPE kpgen_mech,
                  CK_SLOT_ID_PTR pSlotID)
{
    CK_SLOT_ID_PTR pSlotList = NULL_PTR;
    CK_SLOT_ID SlotID;
    CK_ULONG ulSlotCount = 0;
    CK_MECHANISM_INFO mech_info;
    int i;
    boolean_t returnval = B_FALSE;

    CK_RV rv;

    /* Get slot list for memory allocation */
    rv = C_GetSlotList(0, NULL_PTR, &ulSlotCount);

    if ((rv == CKR_OK) && (ulSlotCount > 0)) {
        fprintf(stdout, "slotCount = %d\n", ulSlotCount);
        pSlotList = malloc(ulSlotCount * sizeof (CK_SLOT_ID));
    }
}

```

```
if (pSlotList == NULL) {
    fprintf(stderr, "System error: unable to allocate "
        "memory\n");
    return (returnval);
}

/* Get the slot list for processing */
rv = C_GetSlotList(0, pSlotList, &ulSlotCount);
if (rv != CKR_OK) {
    fprintf(stderr, "GetSlotList failed: unable to get "
        "slot count.\n");
    goto cleanup;
}
} else {
    fprintf(stderr, "GetSlotList failed: unable to get slot "
        "list.\n");
    return (returnval);
}

/* Find a slot capable of specified mechanism */
for (i = 0; i < ulSlotCount; i++) {
    SlotID = pSlotList[i];

    /* Check if this slot is capable of signing and
     * verifying with sv_mech. */
    rv = C_GetMechanismInfo(SlotID, sv_mech, &mech_info);

    if (rv != CKR_OK) {
        continue;
    }

    if (!(mech_info.flags & CKF_SIGN &&
        mech_info.flags & CKF_VERIFY)) {
        continue;
    }

    /* Check if the slot is capable of key pair generation
     * with kpgen_mech. */
    rv = C_GetMechanismInfo(SlotID, kpgen_mech, &mech_info);

    if (rv != CKR_OK) {
        continue;
    }

    if (!(mech_info.flags & CKF_GENERATE_KEY_PAIR)) {
        continue;
    }
}
```

```

/* If we get this far, this slot supports our mechanisms. */
returnval = B_TRUE;
*pSlotID = SlotID;
break;

}

cleanup:
if (pSlotList)
    free(pSlotList);

return (returnval);

}

```

Random Byte Generation Example

[Example 29, “Generating Random Numbers Using PKCS #11 Functions,” on page 192](#) demonstrates how to find a slot with a mechanism that can generate random bytes. The example performs the following steps:

1. Initializes the cryptoki library.
2. Calls `GetRandSlot()` to find a slot with a mechanism that can generate random bytes.

The task of finding a slot performs the following steps:

 - a. Calling the function `C_GetSlotList()` to get a list of the available slots.

`C_GetSlotList()` is called twice, as the PKCS #11 convention suggests. `C_GetSlotList()` is called the first time to get the number of slots for memory allocation. `C_GetSlotList()` is called the second time to retrieve the slots.
 - b. Finding a slot that can generate random bytes.

For each slot, the function obtains the token information by using `GetTokenInfo()` and checks for a match with the `CKF_RNG` flag set. When a slot that has the `CKF_RNG` flag set is found, the `GetRandSlot()` function returns.
3. Opens the session by using `C_OpenSession()`.
4. Generates random bytes by using `C_GenerateRandom()`.
5. Ends the session.

The program uses `C_CloseSession()` to close the session and `C_Finalize()` to close the library.

The source code for the random number generation sample is shown in the following example.

EXAMPLE 29 Generating Random Numbers Using PKCS #11 Functions

```
#include <stdio.h>
#include <fcntl.h>
#include <errno.h>
#include <sys/types.h>
#include <security/cryptoki.h>
#include <security/pkcs11.h>

#define RANDSIZE 64

boolean_t GetRandSlot(CK_SLOT_ID_PTR pslot);

/* Example generates random bytes. */
void
main(int argc, char **argv)
{
    CK_RV    rv;
    CK_MECHANISM mech;
    CK_SESSION_HANDLE hSession;
    CK_SESSION_INFO sessInfo;
    CK_SLOT_ID slotID;
    CK_BYTE  randBytes[RANDSIZE];

    boolean_t found_slot = B_FALSE;
    int error;
    int i;

    /* Initialize the CRYPTOKI library */
    rv = C_Initialize(NULL_PTR);

    if (rv != CKR_OK) {
        fprintf(stderr, "C_Initialize: Error = 0x%.8X\n", rv);
        exit(1);
    }

    found_slot = GetRandSlot(&slotID);

    if (!found_slot) {
        goto exit_program;
    }

    /* Open a session on the slot found */
    rv = C_OpenSession(slotID, CKF_SERIAL_SESSION, NULL_PTR, NULL_PTR,
        &hSession);

    if (rv != CKR_OK) {
        fprintf(stderr, "C_OpenSession: rv = 0x%.8X\n", rv);
    }
}
```



```

    error = 1;
    goto exit_program;
}

/* Generate random bytes */
rv = C_GenerateRandom(hSession, randBytes, RANDSIZE);

if (rv != CKR_OK) {
    fprintf(stderr, "C_GenerateRandom: rv = 0x%.8x\n", rv);
    error = 1;
    goto exit_session;
}

fprintf(stdout, "Random value: ");
for (i = 0; i < RANDSIZE; i++) {
    fprintf(stdout, "%.2x", randBytes[i]);
}

exit_session:
(void) C_CloseSession(hSession);

exit_program:
(void) C_Finalize(NULL_PTR);
exit(error);
}

boolean_t
GetRandSlot(CK_SLOT_ID_PTR pslot)
{
    CK_SLOT_ID_PTR pSlotList;
    CK_SLOT_ID SlotID;
    CK_TOKEN_INFO tokenInfo;
    CK_ULONG ulSlotCount;
    CK_MECHANISM_TYPE_PTR pMechTypeList = NULL_PTR;
    CK_ULONG ulMechTypecount;
    boolean_t result = B_FALSE;
    int i = 0;

    CK_RV rv;

    /* Get slot list for memory allocation */
    rv = C_GetSlotList(0, NULL_PTR, &ulSlotCount);

    if ((rv == CKR_OK) && (ulSlotCount > 0)) {
        fprintf(stdout, "slotCount = %d\n", (int)ulSlotCount);
        pSlotList = malloc(ulSlotCount * sizeof (CK_SLOT_ID));
    }
}

```

```
    if (pSlotList == NULL) {
        fprintf(stderr,
            "System error: unable to allocate memory\n");
        return (result);
    }

    /* Get the slot list for processing */
    rv = C_GetSlotList(0, pSlotList, &ulSlotCount);
    if (rv != CKR_OK) {
        fprintf(stderr, "GetSlotList failed: unable to get "
            "slot list.\n");
        free(pSlotList);
        return (result);
    }
} else {
    fprintf(stderr, "GetSlotList failed: unable to get slot"
        " count.\n");
    return (result);
}

/* Find a slot capable of doing random number generation */
for (i = 0; i < ulSlotCount; i++) {
    SlotID = pSlotList[i];

    rv = C_GetTokenInfo(SlotID, &tokenInfo);

    if (rv != CKR_OK) {
        /* Check the next slot */
        continue;
    }

    if (tokenInfo.flags & CKF_RNG) {
        /* Found a random number generator */
        *pslot = SlotID;
        fprintf(stdout, "Slot # %d supports random number "
            "generation!\n", SlotID);
        result = B_TRUE;
        break;
    }
}

if (pSlotList)
    free(pSlotList);

return (result);
}
```

Introduction to the Oracle Solaris Key Management Framework

The Oracle Solaris Key Management Framework (KMF) provides a unified set of interfaces for managing Public Key Infrastructure (PKI) objects in Oracle Solaris. These interfaces include both programming interfaces and administrative tools.

This chapter discusses the following topics:

- [“Oracle Solaris Key Management Framework Features” on page 195](#)
- [“Oracle Solaris Key Management Framework Components” on page 196](#)
- [“Oracle Solaris Key Management Framework Example Application” on page 199](#)

Oracle Solaris Key Management Framework Features

Developers and system administrators can choose among several different *keystore* systems when designing systems that employ PKI technologies. A keystore is a storage system for PKI objects. The primary choices for Oracle Solaris users are NSS, OpenSSL, and PKCS#11. Each of these keystore systems presents different programming interfaces and administrative tools. None of these keystore systems includes any PKI policy enforcement system.

KMF provides generic interfaces that manipulate keys and certificates in all of these keystores.

- A generic API layer enables the developer to specify which type of keystore to use. KMF also provides plugin modules for each of these three keystore systems so that you can write new applications to use any of these keystores. Applications written to KMF are not bound to one keystore system.
- A management utility enables the administrator to manage PKI objects in all three of these keystores. You do not need to use a different utility for each keystore.

KMF also provides a system-wide policy database that KMF applications can use, regardless of which type of keystore is being used. The administrator can create policy definitions in a global

database. KMF applications can choose which policy to assert, and then all subsequent KMF operations behave according to the limitations of that policy. Policy definitions include rules for how to perform validations, requirements for key usage and extended key usage, trust anchor definitions, Online Certificate Status Protocol (OCSP) parameters, and Certificate Revocation List (CRL) DB parameters such as location.

Oracle Solaris KMF includes the following features:

- Programming interfaces for developing PKI aware applications. These interfaces are keystore independent. The interface does not bind the application to a particular keystore system such as NSS, OpenSSL, or PKCS#11.
- An administrative utility, `pktool`, for managing PKI objects.
- A PKI policy database and enforcement system for PKI aware applications. The enforcement system is keystore independent and can be applied system-wide. KMF provides the `kmfcfg` utility for policy management.
- A plugin interface to extend KMF for legacy and proprietary systems. Plugins can be managed by using `kmfcfg` utility.

KMF consumers include any project that uses certificates, such as authentication services and smart card authentication with X.509 certificates.

Oracle Solaris Key Management Framework Components

This section describes the following KMF components:

- The `pktool(1)` key management tool
- The KMF policy database
- The `kmfcfg(1)` policy definition and plugin configuration utility
- KMF data types defined in `kmftypes.h` and programming interfaces defined in `kmfapi.h` and `libkmf(3LIB)`

KMF Key Management Tool

The following `pktool` subcommands specifically support KMF:

<code>delete</code>	Delete objects in the keystore.
<code>download</code>	Download a CRL or certificate file from an external source.

<code>export</code>	Export objects from the keystore to a file.
<code>gencert</code>	Create a self-signed X.509v3 certificate.
<code>genscr</code>	Create a PKCS#10 Certificate Signing Request (CSR) file.
<code>genkey</code>	Create a symmetric key in the keystore.
<code>genkeypair</code>	Create an asymmetric keypair.
<code>help</code>	Displays a help message.
<code>import</code>	Import objects from an external source.
<code>inittoken</code>	Initialize a PKCS#11 token.
<code>list</code>	List a summary of objects in the keystore.
<code>setpin</code>	Change user authentication passphrase for keystore access.
<code>signcsr</code>	Sign a PKCS#10 CSR.
<code>tokens</code>	List all visible PKCS#11 tokens.

KMF Policy Enforcement Mechanisms

KMF policy is a hierarchical tree of policies. A default policy is defined when the system is installed. The default policy applies unless the application asserts a different policy.

Policy parameters control the use of X.509 certificates by an application. KMF policy applies to all certificates and is not restricted to any particular keystore.

Use the `kmfcfg(1)` utility to manage the KMF policy database and configure plugins. You can use `kmfcfg` to list, create, modify, delete, import, and export policy definitions in the system default database file `/etc/security/kmfpolicy.xml` or in a user-defined database file. Note that you cannot modify the default policy in the system KMF policy database. For plugin configuration, you can use `kmfcfg` to display plugin information, install or uninstall a KMF plugin, and modify the plugin option.

The following list shows some of the KMF policy attributes. See the `kmfcfg` man page for a complete list and descriptions of these policy attributes.

- Policy Name. Applications reference this name.

- Ignore Date. Ignore the validity periods defined in the certificates when evaluating their validity.
- Ignore Unknown EKU. Ignore any unrecognized EKU values in the Extended Key Usage extension.
- Validation Method. Examples include OCSP and CRL.
- Key Usage Values. This attribute is a comma separated list of key usage values that are required by the policy being defined. These bits must be set in order to use the certificate.
- Extended Key Usage Values. This attribute is a comma separated list of Extended Key Usage OIDs that are required by the policy being defined. These OIDs must be present in order to use the certificate.

See the `kmfpolicy.h` file for definitions of policy data types.

The following plugin libraries are provided in Oracle Solaris KMF:

- PKCS#11 keystore plugin: `kmf_pkcs11`
- OpenSSL keystore plugin: `kmf_openssl`
- NSS keystore plugin: `kmf_nss`

KMF Application Programming Interfaces

The Oracle Solaris KMF provides abstract APIs for PKI operations. Applications written to KMF can access multiple keystores such as files (OpenSSL), NSS, and PKCS11 tokens and multiple validation modules such as OCSP and CRL checking. The KMF API can be extended by third parties for proprietary and legacy implementations.

The KMF APIs are provided in the Key Management Framework Library, `libkmf(3LIB)`. These APIs enable your application to create and manage public key objects such as public/private keypairs, certificates, CSRs, certificate validation, CRLs, and OCSP response processing.

- Keys, certificate, and CSR operations: create and delete, store and retrieve, search, import and export
- Common cryptographic operations: sign and verify, encrypt and decrypt using certificates as keys
- Access complex PKI objects: set and get X.509 attributes and extensions, and extract data in human-readable formats

The KMF APIs are defined in the `kmfapi.h` file, and structures and types are defined in the `kmftypes.h` file. The `kmfapi.h` file lists the functions in the following groups:

- Setup operations
- Key operations

- Certificate operations
- Cryptographic operations with key or certificate
- CRL operations
- CSR operations
- Get certificate operations
- Set certificate operations
- PK12 operations
- OCSP operations
- Policy operations
- Error handling
- Memory cleanup operations
- APIs for PKCS#11 tokens
- Attribute management operations

Oracle Solaris Key Management Framework Example Application

The `pktool` application is an excellent example of how to use the KMF APIs.

This section shows a simple application that uses KMF. This section describes the basic steps that an application needs to take in order to perform some KMF operations. This example assumes that you have experience in C programming and a basic understanding of public key technologies and standards. This example goes through the steps of initializing KMF for use and then creates a self-signed X.509v3 certificate and associated RSA key pair. This example also shows how to use the KMF-enhanced `pktool` command to verify that the application was successful.

KMF Headers and Libraries

To give the program access to the KMF function prototypes and type definitions, include the `kmfapi.h` file.

```
#include <stdio.h>
#include <kmfapi.h>
```

Be sure to include the KMF library in the link step.

```
$ cc -o kmftest kmftest.c -lkmf
```

KMF Basic Data Types

See the `kmftypes.h` file for definitions of structures and types. This example uses variables of the following KMF types.

<code>KMF_HANDLE_T</code>	Session handle for KMF calls
<code>KMF_RETURN</code>	Return code for all KMF calls
<code>KMF_KEY_HANDLE</code>	Handle to a KMF key
<code>KMF_CREDENTIAL</code>	KMF credential
<code>KMF_ATTRIBUTE</code>	Make sure this is big enough
<code>KMF_KEYSTORE_TYPE</code>	Keystore type, such as <code>KMF_KEYSTORE_PK11TOKEN</code>
<code>KMF_KEY_ALG</code>	Key type, such as <code>KMF_RSA</code>
<code>KMF_X509_CERTIFICATE</code>	Data record that gets signed
<code>KMF_X509_NAME</code>	Distinguished name record
<code>KMF_DATA</code>	Final certificate data record
<code>KMF_BIGINT</code>	Variable length integer

KMF Application Results Verification

The user can verify that the program successfully created the certificate and keypair by using the `pktool(1M)` utility.

```
$ pktool list objtype=both
Enter pin for Sun Software PKCS#11 softtoken :
Found 1 certificates.
1. (X.509 certificate)
   Label: admin@example.com
   ID:
09:ac:7f:1a:01:f7:fc:a9:1a:cd:fd:8f:d4:92:4c:25:bf:b1:97:fe
   Subject: C=US, ST=CA, L=Menlo Park, O=Foobar Inc., OU=Foobar
IT Office, CN=admin@example.com
   Issuer: C=US, ST=CA, L=Menlo Park, O=Foobar Inc., OU=Foobar IT
```



```
Office, CN=admin@example.com
Serial: 0x452BF693
X509v3 Subject Alternative Name:
email:admin@example.com
```

```
Found 1 keys.
Key #1 - RSA private key: admin@example.com
```

Complete KMF Application Source Code

See the [libkmf\(3LIB\)](#) man page for definitions of KMF APIs.

This application performs the following steps:

1. Before any KMF functions can be called, the application must first use `kmf_initialize()` to initialize a handle for a KMF session. This handle is used as the first argument to most KMF function calls. It is an opaque data type and is used to hold internal state and context information for that session.
2. This example application uses the PKCS#11 keystore. Use `kmf_configure_keystore()` to define a token to use for future operations.
3. The first step to create a certificate or a PKCS#10 CSR is to generate a keypair. Use `kmf_create_keypair()` to create both the public and private keys needed and store the private key in the specified keystore. The function returns handles to the application so that the caller can reference the public and private key objects in future operations if necessary.
4. Once a keypair is established, use `kmf_set_cert_pubkey()` and `kmf_set_cert_version()` to populate the template record that is used to generate the final certificate. KMF provides different APIs for setting the various fields of an X.509v3 certificate, including extensions. Use `kmf_hexstr_to_bytes()`, `kmf_set_cert_serial()`, `kmf_set_cert_validity()`, and `kmf_set_cert_sig_alg()` to set the serial number. The serial number is a `KMF_BIGINT` record. Use `kmf_dn_parser()`, `kmf_set_cert_subject()`, and `kmf_set_cert_issuer()` to create a `KMF_X509_NAME` structure.
5. Because this is a self-signed certificate creation exercise, this application signs the certificate template created above with the private key that goes with the public key in the certificate itself. This `kmf_sign_cert()` operation results in a `KMF_DATA` record that contains the ASN.1 encoded X.509v3 certificate data.
6. Now that the certificate is signed and in its final format, it can be stored in any of the keystores. Use `kmf_store_cert()` to store the certificate in the PKCS#11 token defined at the beginning of this application. The certificate could also be stored in NSS or an OpenSSL file at this point.
7. Memory allocated to data structures generated by KMF should be cleaned up when the data structure is no longer needed. KMF provides convenience APIs for properly deallocating memory associated with these objects. The proper cleanup of memory is strongly

encouraged in order to conserve resources. Cleanup interfaces include `kmf_free_data()`, `kmf_free_dn()`, and `kmf_finalize()`.

Below is the complete source code for this example application, including all of the data types and helper functions. When you compile, be sure to include the KMF library.

```
/*
 * KMF Example code for generating a self-signed X.509 certificate.
 * This is completely unsupported and is just to be used as an example.
 *
 * Compile:
 * $ cc -o keytest keytest.c -lkmf
 *
 * Run:
 * $ ./keytest
 *
 * Once complete, the results can be verified using the pktool(1) command:
 *
 * $ pktool list
 * This should show an RSA public key labeled "keytest" and a cert labeled "keytest".
 *
 * The objects created by this program can be deleted from the keystore
 * using pktool(1) also:
 *
 * $ pktool delete label=keytest
 */
#include <stdio.h>
#include <strings.h>
#include <fcntl.h>
#include <sys/types.h>
#include <sys/stat.h>
#include <tzfile.h>

#include <kmfapi.h>

int
main(int argc, char *argv[])
{
    KMF_HANDLE_T      kmfhandle;
    KMF_RETURN        ret;
    char              opt, *str = NULL;
    extern char       *optarg;
    KMF_KEY_HANDLE    prikey, pubkey;
    KMF_CREDENTIAL    cred;
    KMF_ATTRIBUTE     attrlist[16]; /* this needs to be big enough */
    KMF_KEYSTORE_TYPE kstype;
    KMF_KEY_ALG       keytype;
```

```

KMF_KEY_HANDLE      prik, pubk;
KMF_X509_CERTIFICATE certstruct;
KMF_X509_NAME       certsubject, certissuer;
KMF_DATA            rawcert;
KMF_BIGINT          serno;
char                *token = "Sun Software PKCS#11 softtoken";
char                *keylabel = "keytest";
boolean_t           readonly = B_FALSE;
uint32_t            keylen = 1024;
uint32_t            ltime = SECSPERDAY * DAYSPERNYEAR; /* seconds in a
                                                         year (see tzfile.h) */
char                prompt[1024];
int                 numattrs;

(void) memset(&certstruct, 0, sizeof (certstruct));
(void) memset(&rawcert, 0, sizeof (rawcert));
(void) memset(&certissuer, 0, sizeof (certissuer));
(void) memset(&certsubject, 0, sizeof (certsubject));

/*
 * Initialize a KMF handle for use in future calls.
 */
ret = kmf_initialize(&kmfhandle, NULL, NULL);
if (ret != KMF_OK) {
    printf("kmf_initialize failed: 0x%0x\n", ret);
    exit(1);
}

/* We want to use the PKCS11 keystore */
kstype = KMF_KEYSTORE_PK11TOKEN;
numattrs = 0;
kmf_set_attr_at_index(attrlist, numattrs, KMF_KEYSTORE_TYPE_ATTR,
    &kstype, sizeof (kstype));
numattrs++;

/* Indicate which PKCS11 token will be used */
kmf_set_attr_at_index(attrlist, numattrs, KMF_TOKEN_LABEL_ATTR,
    token, strlen(token));
numattrs++;

kmf_set_attr_at_index(attrlist, numattrs, KMF_READONLY_ATTR,
    &readonly, sizeof (readonly));
numattrs++;

ret = kmf_configure_keystore(kmfhandle, numattrs, attrlist);
if (ret != KMF_OK)
    exit (ret);

```

```
/* Reset the attribute count for a new command */
numattrs = 0;

/*
 * Get the PIN to access the token.
 */
(void) snprintf(prompt, sizeof (prompt), "Enter PIN for %s:", token);
cred.cred = getpassphrase(prompt);
if (cred.cred != NULL) {
    cred.credlen = strlen(cred.cred);
    kmf_set_attr_at_index(attrlist, numattrs, KMF_CREDENTIAL_ATTR,
        &cred, sizeof (cred));
    numattrs++;
}

kmf_set_attr_at_index(attrlist, numattrs, KMF_KEYSTORE_TYPE_ATTR,
    &kstype, sizeof (kstype));
numattrs++;

keytype = KMF_RSA;
keylen = 1024;
keylabel = "keytest";

kmf_set_attr_at_index(attrlist, numattrs, KMF_KEYALG_ATTR,
    &keytype, sizeof (keytype));
numattrs++;

kmf_set_attr_at_index(attrlist, numattrs, KMF_KEYLENGTH_ATTR,
    &keylen, sizeof (keylen));
numattrs++;

kmf_set_attr_at_index(attrlist, numattrs, KMF_KEYLABEL_ATTR,
    keylabel, strlen(keylabel));
numattrs++;

kmf_set_attr_at_index(attrlist, numattrs, KMF_CREDENTIAL_ATTR,
    &cred, sizeof (cred));
numattrs++;

/*
 * Set the handles so they can be used later.
 */
kmf_set_attr_at_index(attrlist, numattrs, KMF_PRIVKEY_HANDLE_ATTR,
    &prik, sizeof (prik));
numattrs++;

kmf_set_attr_at_index(attrlist, numattrs, KMF_PUBKEY_HANDLE_ATTR,
    &pubk, sizeof (pubk));
```

```
numattrs++;

ret = kmf_create_keypair(kmfhandle, numattrs, attrlist);
if (ret != KMF_OK) {
    printf("kmf_create_keypair error: 0x%02x\n", ret);
    goto cleanup;
}

/*
 * Now the keys have been created, generate an X.509 certificate
 * by populating the template and signing it.
 */
if ((ret = kmf_set_cert_pubkey(kmfhandle, &pubk, &certstruct)) {
    printf("kmf_set_cert_pubkey error: 0x%02x\n", ret);
    goto cleanup;
}

/* Version "2" is for an x509.v3 certificate */
if ((ret = kmf_set_cert_version(&certstruct, 2)) {
    printf("kmf_set_cert_version error: 0x%02x\n", ret);
    goto cleanup;
}

/*
 * Set up the serial number, it must be a KMF_BIGINT record.
 */
if ((ret = kmf_hexstr_to_bytes((uchar_t *)"0x010203", &serno.val, \
    &serno.len)) {
    printf("kmf_hexstr_to_bytes error: 0x%02x\n", ret);
    goto cleanup;
}

if ((ret = kmf_set_cert_serial(&certstruct, &serno)) {
    printf("kmf_set_cert_serial error: 0x%02x\n", ret);
    goto cleanup;
}

if ((ret = kmf_set_cert_validity(&certstruct, NULL, ltime)) {
    printf("kmf_set_cert_validity error: 0x%02x\n", ret);
    goto cleanup;
}

if ((ret = kmf_set_cert_sig_alg(&certstruct, KMF_ALGID_SHA1WithRSA)) {
    printf("kmf_set_cert_sig_alg error: 0x%02x\n", ret);
    goto cleanup;
}

/*
```

```
    * Create a KMF_X509_NAME struct by parsing a distinguished name.
    */
    if ((ret = kmf_dn_parser("cn=testcert", &certsubject)) {
        printf("kmf_dn_parser error: 0x%02x\n", ret);
        goto cleanup;
    }

    if ((ret = kmf_dn_parser("cn=testcert", &certissuer)) {
        printf("kmf_dn_parser error: 0x%02x\n", ret);
        goto cleanup;
    }

    if ((ret = kmf_set_cert_subject(&certstruct, &certsubject)) {
        printf("kmf_set_cert_sig_alg error: 0x%02x\n", ret);
        goto cleanup;
    }

    if ((ret = kmf_set_cert_issuer(&certstruct, &certissuer)) {
        printf("kmf_set_cert_sig_alg error: 0x%02x\n", ret);
        goto cleanup;
    }

    /*
     * Now we have the certstruct setup with the minimal amount needed
     * to generate a self-signed cert. Put together the attributes to
     * call kmf_sign_cert.
     */
    numattrs = 0;
    kmf_set_attr_at_index(attrlist, numattrs, KMF_KEYSTORE_TYPE_ATTR,
        &kstype, sizeof (kstype));
    numattrs++;

    kmf_set_attr_at_index(attrlist, numattrs, KMF_KEY_HANDLE_ATTR,
        &prik, sizeof (KMF_KEY_HANDLE_ATTR));
    numattrs++;

    /* The X509 template structure to be signed goes here. */
    kmf_set_attr_at_index(attrlist, numattrs, KMF_X509_CERTIFICATE_ATTR,
        &certstruct, sizeof (KMF_X509_CERTIFICATE));
    numattrs++;

    /*
     * Set the output buffer for the signed cert.
     * This will be a block of raw ASN.1 data.
     */
    kmf_set_attr_at_index(attrlist, numattrs, KMF_CERT_DATA_ATTR,
        &rawcert, sizeof (KMF_DATA));
    numattrs++;
```

```
    if ((ret = kmf_sign_cert(kmfhandle, numattrs, attrlist)) {
        printf("kmf_sign_cert error: 0x%02x\n", ret);
        goto cleanup;
    }

    /*
     * Now we have the certificate and we want to store it in the
     * keystore (which is the PKCS11 token in this example).
     */
    numattrs = 0;
    kmf_set_attr_at_index(attrlist, numattrs, KMF_KEystore_TYPE_ATTR,
        &kstype, sizeof (kstype));
    numattrs++;
    kmf_set_attr_at_index(attrlist, numattrs, KMF_CERT_DATA_ATTR,
        &rawcert, sizeof (KMF_DATA));
    numattrs++;

    /* Use the same label as the public key */
    kmf_set_attr_at_index(attrlist, numattrs, KMF_CERT_LABEL_ATTR,
        keylabel, strlen(keylabel));
    numattrs++;

    if ((ret = kmf_store_cert(kmfhandle, numattrs, attrlist)) {
        printf("kmf_store_cert error: 0x%02x\n", ret);
        goto cleanup;
    }

cleanup:
    kmf_free_data(&rawcert);
    kmf_free_dn(&certissuer);
    kmf_free_dn(&certsubject);
    kmf_finalize(kmfhandle);

    return (ret);
}
```

◆◆◆ A P P E N D I X A

Secure Coding Guidelines for Developers

Developers who write applications for the Oracle Solaris operating system need to follow secure coding guidelines. Guidelines exist for secure coding in general, language-specific coding, and Oracle Solaris-specific coding and tools.

The following web sites track coding vulnerabilities and promote secure coding practices:

- [Common Weakness Enumeration](#)
- [National Vulnerability Database Version 2.2](#)
- [CERT Secure Coding Standards](#)

The CERT web site contains computer language references for secure coding practices. These references might include sections about the POSIX APIs, which are part of the API set of Oracle Solaris.

- C – [CERT C Secure Coding Standard](#)
Additional guidelines for secure use of the standard C library functions in Oracle Solaris is available at [Appendix G, “Security Considerations When Using C Functions”](#)
- C++ – [CERT C++ Secure Coding Standard](#)
- Java – [CERT Oracle Secure Coding Standard for Java](#) and [Secure Coding Guidelines for Java SE](#)
- Perl – [CERT Perl Secure Coding Standard](#)

Oracle Solaris provides specific APIs which can be used to write more secure code and to take advantage of the security and cryptographic features of the Oracle Solaris operating system and Oracle Sun hardware systems. Additionally, the suite of documents for Oracle Solaris Studio include discussions of using the tools securely.

The following guides from Oracle Solaris address secure coding:

- [Oracle Solaris 11.3 Linkers and Libraries Guide](#)
- [Oracle Solaris 11.3 DTrace \(Dynamic Tracing\) Guide](#)
- [Resource Management and Oracle Solaris Zones Developer’s Guide](#)
- [Studio 12.3 Security Guide](#)

◆◆◆ APPENDIX B

Sample C-Based GSS-API Programs

This appendix shows the source code for two sample applications that use GSS-API to make a safe network connection. The first application is a typical client. The second application demonstrates how a server works in GSS-API. The two programs display benchmarks in the course of being run. A user can thus view GSS-API in action. Additionally, certain miscellaneous functions are provided for use by the client and server applications.

This chapter covers the following topics:

- “Client-Side Application” on page 211
- “Server-Side Application” on page 223
- “Miscellaneous GSS-API Sample Functions” on page 234

These programs are examined in detail in the [Chapter 5, “GSS-API Client Example”](#) and [Chapter 6, “GSS-API Server Example”](#).

Client-Side Application

The source code for the client-side program, `gss_client`, is provided in the following example.

EXAMPLE 30 Complete Listing of `gss-client.c` Sample Program

```
/*
 * Copyright 1994 by OpenVision Technologies, Inc.
 *
 * Permission to use, copy, modify, distribute, and sell this software
 * and its documentation for any purpose is hereby granted without fee,
 * provided that the above copyright notice appears in all copies and
 * that both that copyright notice and this permission notice appear in
 * supporting documentation, and that the name of OpenVision not be used
 * in advertising or publicity pertaining to distribution of the software
 * without specific, written prior permission. OpenVision makes no
 * representations about the suitability of this software for any
```

```
* purpose. It is provided "as is" without express or implied warranty.
*
* OPENVISION DISCLAIMS ALL WARRANTIES WITH REGARD TO THIS SOFTWARE,
* INCLUDING ALL IMPLIED WARRANTIES OF MERCHANTABILITY AND FITNESS, IN NO
* EVENT SHALL OPENVISION BE LIABLE FOR ANY SPECIAL, INDIRECT OR
* CONSEQUENTIAL DAMAGES OR ANY DAMAGES WHATSOEVER RESULTING FROM LOSS OF
* USE, DATA OR PROFITS, WHETHER IN AN ACTION OF CONTRACT, NEGLIGENCE OR
* OTHER TORTIOUS ACTION, ARISING OUT OF OR IN CONNECTION WITH THE USE OR
* PERFORMANCE OF THIS SOFTWARE.
*/

#if !defined(lint) && !defined(__CODECENTER__)
static char *rcsid = \
"$Header: /cvs/krbdev/krb5/src/appl/gss-sample/gss-client.c,\
v 1.16 1998/10/30 02:52:03 marc Exp $";
#endif

#include <stdio.h>
#include <unistd.h>
#include <stdlib.h>
#include <string.h>
#include <ctype.h>
#include <sys/types.h>
#include <sys/socket.h>
#include <netinet/in.h>
#include <netdb.h>
#include <errno.h>
#include <sys/stat.h>
#include <fcntl.h>

#include <gssapi/gssapi.h>
#include <gssapi/gssapi_ext.h>
#include <gss-misc.h>

void usage()
{
    fprintf(stderr, "Usage: gss-client [-port port] [-d] host service \
msg\n");
    exit(1);
}

/*
 * Function: connect_to_server
 *
 * Purpose: Opens a TCP connection to the name host and port.
 *
 * Arguments:
 *
 */
```

```

*     host          (r) the target host name
*     port          (r) the target port, in host byte order
*
* Returns: the established socket file descriptor, or -1 on failure
*
* Effects:
*
* The host name is resolved with gethostbyname(), and the socket is
* opened and connected. If an error occurs, an error message is
* displayed and -1 is returned.
*/
int connect_to_server(host, port)
    char *host;
    u_short port;
{
    struct sockaddr_in saddr;
    struct hostent *hp;
    int s;

    if ((hp = gethostbyname(host)) == NULL) {
        fprintf(stderr, "Unknown host: %s\n", host);
        return -1;
    }

    saddr.sin_family = hp->h_addrtype;
    memcpy((char *)&saddr.sin_addr, hp->h_addr, sizeof(saddr.sin_addr));
    saddr.sin_port = htons(port);

    if ((s = socket(AF_INET, SOCK_STREAM, 0)) < 0) {
        perror("creating socket");
        return -1;
    }
    if (connect(s, (struct sockaddr *)&saddr, sizeof(saddr)) < 0) {
        perror("connecting to server");
        (void) close(s);
        return -1;
    }
    return s;
}

/*
* Function: client_establish_context
*
* Purpose: establishes a GSS-API context with a specified service and
* returns the context handle
*
* Arguments:
*

```

```
*      s          (r) an established TCP connection to the service
*      service_name (r) the ASCII service name of the service
*      context      (w) the established GSS-API context
*      ret_flags    (w) the returned flags from init_sec_context
*
* Returns: 0 on success, -1 on failure
*
* Effects:
*
* service_name is imported as a GSS-API name and a GSS-API context is
* established with the corresponding service; the service should be
* listening on the TCP connection s. The default GSS-API mechanism
* is used, and mutual authentication and replay detection are
* requested.
*
* If successful, the context handle is returned in context. If
* unsuccessful, the GSS-API error messages are displayed on stderr
* and -1 is returned.
*/
int client_establish_context(s, service_name, deleg_flag, oid,
                             gss_context, ret_flags)
{
    int s;
    char *service_name;
    gss_OID oid;
    OM_uint32 deleg_flag;
    gss_ctx_id_t *gss_context;
    OM_uint32 *ret_flags;

    gss_buffer_desc send_tok, rcv_tok, *token_ptr;
    gss_name_t target_name;
    OM_uint32 maj_stat, min_stat, init_sec_min_stat;

    /*
     * Import the name into target_name. Use send_tok to save
     * local variable space.
     */
    send_tok.value = service_name;
    send_tok.length = strlen(service_name) + 1;
    maj_stat = gss_import_name(&min_stat, &send_tok,
                              (gss_OID) GSS_C_NT_HOSTBASED_SERVICE, &target_name);
    if (maj_stat != GSS_S_COMPLETE) {
        display_status("parsing name", maj_stat, min_stat);
        return -1;
    }

    /*
     * Perform the context-establishment loop.
     */
}
```

```

* On each pass through the loop, token_ptr points to the token
* to send to the server (or GSS_C_NO_BUFFER on the first pass).
* Every generated token is stored in send_tok which is then
* transmitted to the server; every received token is stored in
* recv_tok, which token_ptr is then set to, to be processed by
* the next call to gss_init_sec_context.
*
* GSS-API guarantees that send_tok's length will be non-zero
* if and only if the server is expecting another token from us,
* and that gss_init_sec_context returns GSS_S_CONTINUE_NEEDED if
* and only if the server has another token to send us.
*/

token_ptr = GSS_C_NO_BUFFER;
*gss_context = GSS_C_NO_CONTEXT;

do {
    maj_stat =
        gss_init_sec_context(&init_sec_min_stat,
                            GSS_C_NO_CREDENTIAL,
                            gss_context,
                            target_name,
                            oid,
                            GSS_C_MUTUAL_FLAG | GSS_C_REPLAY_FLAG |
                                deleg_flag,
                            0,
                            NULL, /* no channel bindings */
                            token_ptr,
                            NULL, /* ignore mech type */
                            &send_tok,
                            ret_flags,
                            NULL); /* ignore time_rec */

    if (token_ptr != GSS_C_NO_BUFFER)
        (void) gss_release_buffer(&min_stat, &recv_tok);

    if (send_tok.length != 0) {
        printf("Sending init_sec_context token (size=%d)...",
              send_tok.length);
        if (send_token(s, &send_tok) < 0) {
            (void) gss_release_buffer(&min_stat, &send_tok);
            (void) gss_release_name(&min_stat, &target_name);
            return -1;
        }
    }
}
(void) gss_release_buffer(&min_stat, &send_tok);

if (maj_stat!=GSS_S_COMPLETE && maj_stat!=GSS_S_CONTINUE_NEEDED) {

```

```
        display_status("initializing context", maj_stat,
                      init_sec_min_stat);
        (void) gss_release_name(&min_stat, &target_name);
        if (*gss_context == GSS_C_NO_CONTEXT)
            gss_delete_sec_context(&min_stat, gss_context,
                                   GSS_C_NO_BUFFER);
        return -1;
    }

    if (maj_stat == GSS_S_CONTINUE_NEEDED) {
        printf("continue needed...");
        if (recv_token(s, &recv_tok) < 0) {
            (void) gss_release_name(&min_stat, &target_name);
            return -1;
        }
        token_ptr = &recv_tok;
    }
    printf("\n");
} while (maj_stat == GSS_S_CONTINUE_NEEDED);

(void) gss_release_name(&min_stat, &target_name);
return 0;
}

void read_file(file_name, in_buf)
    char          *file_name;
    gss_buffer_t   in_buf;
{
    int fd, bytes_in, count;
    struct stat stat_buf;

    if ((fd = open(file_name, O_RDONLY, 0)) < 0) {
        perror("open");
        fprintf(stderr, "Couldn't open file %s\n", file_name);
        exit(1);
    }
    if (fstat(fd, &stat_buf) < 0) {
        perror("fstat");
        exit(1);
    }
    in_buf->length = stat_buf.st_size;

    if (in_buf->length == 0) {
        in_buf->value = NULL;
        return;
    }

    if ((in_buf->value = malloc(in_buf->length)) == 0) {
```



```

        fprintf(stderr, \
            "Couldn't allocate %d byte buffer for reading file\n",
            in_buf->length);
        exit(1);
    }

    /* this code used to check for incomplete reads, but you can't get
       an incomplete read on any file for which fstat() is meaningful */

    count = read(fd, in_buf->value, in_buf->length);
    if (count < 0) {
        perror("read");
        exit(1);
    }
    if (count < in_buf->length)
        fprintf(stderr, "Warning, only read in %d bytes, expected %d\n",
            count, in_buf->length);
}

/*
 * Function: call_server
 *
 * Purpose: Call the "sign" service.
 *
 * Arguments:
 *
 *     host          (r) the host providing the service
 *     port          (r) the port to connect to on host
 *     service_name  (r) the GSS-API service name to authenticate to
 *     msg           (r) the message to have "signed"
 *
 * Returns: 0 on success, -1 on failure
 *
 * Effects:
 *
 * call_server opens a TCP connection to <host:port> and establishes a
 * GSS-API context with service_name over the connection. It then
 * seals msg in a GSS-API token with gss_seal, sends it to the server,
 * reads back a GSS-API signature block for msg from the server, and
 * verifies it with gss_verify. -1 is returned if any step fails,
 * otherwise 0 is returned. */
int call_server(host, port, oid, service_name, deleg_flag, msg, use_file)
    char *host;
    u_short port;
    gss_OID oid;
    char *service_name;
    OM_uint32 deleg_flag;
    char *msg;

```

```
    int use_file;
{
    gss_ctx_id_t context;
    gss_buffer_desc in_buf, out_buf;
    int s, state;
    OM_uint32 ret_flags;
    OM_uint32 maj_stat, min_stat;
    gss_name_t      src_name, targ_name;
    gss_buffer_desc sname, tname;
    OM_uint32      lifetime;
    gss_OID        mechanism, name_type;
    int            is_local;
    OM_uint32      context_flags;
    int            is_open;
    gss_qop_t      qop_state;
    gss_OID_set    mech_names;
    gss_buffer_desc oid_name;
    size_t         i;

    /* Open connection */
    if ((s = connect_to_server(host, port)) < 0)
        return -1;

    /* Establish context */
    if (client_establish_context(s, service_name, deleg_flag, oid,
        &context, &ret_flags) < 0) {
        (void) close(s);
        return -1;
    }

    /* display the flags */
    display_ctx_flags(ret_flags);

    /* Get context information */
    maj_stat = gss_inquire_context(&min_stat, context,
        &src_name, &targ_name, &lifetime,
        &mechanism, &context_flags,
        &is_local,
        &is_open);
    if (maj_stat != GSS_S_COMPLETE) {
        display_status("inquiring context", maj_stat, min_stat);
        return -1;
    }

    maj_stat = gss_display_name(&min_stat, src_name, &sname,
        &name_type);
    if (maj_stat != GSS_S_COMPLETE) {
        display_status("displaying source name", maj_stat, min_stat);
    }
}
```

```

        return -1;
    }
    maj_stat = gss_display_name(&min_stat, targ_name, &tname,
                              (gss_OID *) NULL);
    if (maj_stat != GSS_S_COMPLETE) {
        display_status("displaying target name", maj_stat, min_stat);
        return -1;
    }
    fprintf(stderr, "\"%.*s\" to \"%.*s\", lifetime %d, flags %x, %s,
                  %s\n", (int) sname.length, (char *) sname.value,
                      (int) tname.length, (char *) tname.value, lifetime,
                      context_flags,
                      (is_local) ? "locally initiated" : "remotely initiated",
                      (is_open) ? "open" : "closed");

    (void) gss_release_name(&min_stat, &src_name);
    (void) gss_release_name(&min_stat, &targ_name);
    (void) gss_release_buffer(&min_stat, &sname);
    (void) gss_release_buffer(&min_stat, &tname);

    maj_stat = gss_oid_to_str(&min_stat,
                              name_type,
                              &oid_name);
    if (maj_stat != GSS_S_COMPLETE) {
        display_status("converting oid->string", maj_stat, min_stat);
        return -1;
    }
    fprintf(stderr, "Name type of source name is %.*s.\n",
            (int) oid_name.length, (char *) oid_name.value);
    (void) gss_release_buffer(&min_stat, &oid_name);

    /* Now get the names supported by the mechanism */
    maj_stat = gss_inquire_names_for_mech(&min_stat,
                                          mechanism,
                                          &mech_names);
    if (maj_stat != GSS_S_COMPLETE) {
        display_status("inquiring mech names", maj_stat, min_stat);
        return -1;
    }

    maj_stat = gss_oid_to_str(&min_stat,
                              mechanism,
                              &oid_name);
    if (maj_stat != GSS_S_COMPLETE) {
        display_status("converting oid->string", maj_stat, min_stat);
        return -1;
    }
    fprintf(stderr, "Mechanism %.*s supports %d names\n",

```

```
        (int) oid_name.length, (char *) oid_name.value,
        mech_names->count);
(void) gss_release_buffer(&min_stat, &oid_name);

for (i=0; i<mech_names->count; i++) {
    maj_stat = gss_oid_to_str(&min_stat,
                            &mech_names->elements[i],
                            &oid_name);
    if (maj_stat != GSS_S_COMPLETE) {
        display_status("converting oid->string", maj_stat, min_stat);
        return -1;
    }
    fprintf(stderr, "  %d: %.*s\n", i,
            (int) oid_name.length, (char *) oid_name.value);

    (void) gss_release_buffer(&min_stat, &oid_name);
}
(void) gss_release_oid_set(&min_stat, &mech_names);

if (use_file) {
    read_file(msg, &in_buf);
} else {
    /* Seal the message */
    in_buf.value = msg;
    in_buf.length = strlen(msg);
}

maj_stat = gss_wrap(&min_stat, context, 1, GSS_C_QOP_DEFAULT,
                  &in_buf, &state, &out_buf);
if (maj_stat != GSS_S_COMPLETE) {
    display_status("sealing message", maj_stat, min_stat);
    (void) close(s);
    (void) gss_delete_sec_context(&min_stat, &context,
                                GSS_C_NO_BUFFER);
    return -1;
} else if (! state) {
    fprintf(stderr, "Warning! Message not encrypted.\n");
}

/* Send to server */
if (send_token(s, &out_buf) < 0) {
    (void) close(s);
    (void) gss_delete_sec_context(&min_stat, &context, GSS_C_NO_BUFFER);
    return -1;
}
(void) gss_release_buffer(&min_stat, &out_buf);

/* Read signature block into out_buf */
```

```

if (recv_token(s, &out_buf) < 0) {
    (void) close(s);
    (void) gss_delete_sec_context(&min_stat, &context, GSS_C_NO_BUFFER);
    return -1;
}

/* Verify signature block */
maj_stat = gss_verify_mic(&min_stat, context, &in_buf,
                        &out_buf, &qop_state);
if (maj_stat != GSS_S_COMPLETE) {
    display_status("verifying signature", maj_stat, min_stat);
    (void) close(s);
    (void) gss_delete_sec_context(&min_stat, &context, GSS_C_NO_BUFFER);
    return -1;
}
(void) gss_release_buffer(&min_stat, &out_buf);

if (use_file)
    free(in_buf.value);

printf("Signature verified.\n");

/* Delete context */
maj_stat = gss_delete_sec_context(&min_stat, &context, &out_buf);
if (maj_stat != GSS_S_COMPLETE) {
    display_status("deleting context", maj_stat, min_stat);
    (void) close(s);
    (void) gss_delete_sec_context(&min_stat, &context, GSS_C_NO_BUFFER);
    return -1;
}

(void) gss_release_buffer(&min_stat, &out_buf);
(void) close(s);
return 0;
}

static void parse_oid(char *mechanism, gss_OID *oid)
{
    char      *mechstr = 0, *cp;
    gss_buffer_desc tok;
    OM_uint32 maj_stat, min_stat;

    if (isdigit(mechanism[0])) {
        mechstr = malloc(strlen(mechanism)+5);
        if (!mechstr) {
            printf("Couldn't allocate mechanism scratch!\n");
            return;
        }
    }

```

```
        sprintf(mechstr, "{ %s }", mechanism);
        for (cp = mechstr; *cp; cp++)
            if (*cp == '.')
                *cp = ' ';
        tok.value = mechstr;
    } else
        tok.value = mechanism;
    tok.length = strlen(tok.value);
    maj_stat = gss_str_to_oid(&min_stat, &tok, oid);
    if (maj_stat != GSS_S_COMPLETE) {
        display_status("str_to_oid", maj_stat, min_stat);
        return;
    }
    if (mechstr)
        free(mechstr);
}

int main(argc, argv)
    int argc;
    char **argv;
{
    char *service_name, *server_host, *msg;
    char *mechanism = 0;
    u_short port = 4444;
    int use_file = 0;
    OM_uint32 deleg_flag = 0, min_stat;
    gss_OID oid = GSS_C_NULL_OID;

    display_file = stdout;

    /* Parse arguments. */
    argc--; argv++;
    while (argc) {
        if (strcmp(*argv, "-port") == 0) {
            argc--; argv++;
            if (!argc) usage();
            port = atoi(*argv);
        } else if (strcmp(*argv, "-mech") == 0) {
            argc--; argv++;
            if (!argc) usage();
            mechanism = *argv;
        } else if (strcmp(*argv, "-d") == 0) {
            deleg_flag = GSS_C_DELEG_FLAG;
        } else if (strcmp(*argv, "-f") == 0) {
            use_file = 1;
        } else
            break;
        argc--; argv++;
    }
}
```

```

    }
    if (argc != 3)
        usage();

    server_host = *argv++;
    service_name = *argv++;
    msg = *argv++;

    if (mechanism)
        parse_oid(mechanism, &oid);

    if (call_server(server_host, port, oid, service_name,
                    deleg_flag, msg, use_file) < 0)
        exit(1);

    if (oid != GSS_C_NULL_OID)
        (void) gss_release_oid(&min_stat, &oid);

    return 0;
}

```

Server-Side Application

The source code for the server-side program, `gss_server`, is provided in the following example.

EXAMPLE 31 Complete Code Listing for `gss-server.c` Sample Program

```

/*
 * Copyright 1994 by OpenVision Technologies, Inc.
 *
 * Permission to use, copy, modify, distribute, and sell this software
 * and its documentation for any purpose is hereby granted without fee,
 * provided that the above copyright notice appears in all copies and
 * that both that copyright notice and this permission notice appear in
 * supporting documentation, and that the name of OpenVision not be used
 * in advertising or publicity pertaining to distribution of the software
 * without specific, written prior permission. OpenVision makes no
 * representations about the suitability of this software for any
 * purpose. It is provided "as is" without express or implied warranty.
 *
 * OPENVISION DISCLAIMS ALL WARRANTIES WITH REGARD TO THIS SOFTWARE,
 * INCLUDING ALL IMPLIED WARRANTIES OF MERCHANTABILITY AND FITNESS, IN NO
 * EVENT SHALL OPENVISION BE LIABLE FOR ANY SPECIAL, INDIRECT OR
 * CONSEQUENTIAL DAMAGES OR ANY DAMAGES WHATSOEVER RESULTING FROM LOSS OF

```

```
* USE, DATA OR PROFITS, WHETHER IN AN ACTION OF CONTRACT, NEGLIGENCE OR
* OTHER TORTIOUS ACTION, ARISING OUT OF OR IN CONNECTION WITH THE USE OR
* PERFORMANCE OF THIS SOFTWARE.
*/

#if !defined(lint) && !defined(__CODECENTER__)
static char *rcsid = \
"$Header: /cvs/krbdev/krb5/src/appl/gss-sample/gss-server.c, \
  v 1.21 1998/12/22 \
04:10:08 tytso Exp $";
#endif

#include <stdio.h>
#include <sys/types.h>
#include <sys/socket.h>
#include <sys/time.h>
#include <netinet/in.h>
#include <unistd.h>
#include <stdlib.h>
#include <ctype.h>

#include <gssapi/gssapi.h>
#include <gssapi/gssapi_ext.h>
#include <gss-misc.h>

#include <string.h>

void usage()
{
    fprintf(stderr, "Usage: gss-server [-port port] [-verbose]\n");
    fprintf(stderr, "      [-inetd] [-logfile file] [service_name]\n");
    exit(1);
}

FILE *log;

int verbose = 0;

/*
 * Function: server_acquire_creds
 *
 * Purpose: imports a service name and acquires credentials for it
 *
 * Arguments:
 *
 *     service_name    (r) the ASCII service name
 *     server_creds    (w) the GSS-API service credentials
 *
 */
```



```

* Returns: 0 on success, -1 on failure
*
* Effects:
*
* The service name is imported with gss_import_name, and service
* credentials are acquired with gss_acquire_cred. If either operation
* fails, an error message is displayed and -1 is returned; otherwise,
* 0 is returned.
*/
int server_acquire_creds(service_name, server_creds)
    char *service_name;
    gss_cred_id_t *server_creds;
{
    gss_buffer_desc name_buf;
    gss_name_t server_name;
    OM_uint32 maj_stat, min_stat;

    name_buf.value = service_name;
    name_buf.length = strlen(name_buf.value) + 1;
    maj_stat = gss_import_name(&min_stat, &name_buf,
        (gss_OID) GSS_C_NT_HOSTBASED_SERVICE, &server_name);
    if (maj_stat != GSS_S_COMPLETE) {
        display_status("importing name", maj_stat, min_stat);
        return -1;
    }

    maj_stat = gss_acquire_cred(&min_stat, server_name, 0,
        GSS_C_NULL_OID_SET, GSS_C_ACCEPT,
        server_creds, NULL, NULL);
    if (maj_stat != GSS_S_COMPLETE) {
        display_status("acquiring credentials", maj_stat, min_stat);
        return -1;
    }

    (void) gss_release_name(&min_stat, &server_name);

    return 0;
}

/*
* Function: server_establish_context
*
* Purpose: establishes a GSS-API context as a specified service with
* an incoming client, and returns the context handle and associated
* client name
*
* Arguments:
*

```

```
*      s          (r) an established TCP connection to the client
*      service_creds (r) server credentials, from gss_acquire_cred
*      context      (w) the established GSS-API context
*      client_name  (w) the client's ASCII name
*
* Returns: 0 on success, -1 on failure
*
* Effects:
*
* Any valid client request is accepted. If a context is established,
* its handle is returned in context and the client name is returned
* in client_name and 0 is returned. If unsuccessful, an error
* message is displayed and -1 is returned.
*/
int server_establish_context(s, server_creds, context, client_name, \
    ret_flags)

    int s;
    gss_cred_id_t server_creds;
    gss_ctx_id_t *context;
    gss_buffer_t client_name;
    OM_uint32 *ret_flags;
{
    gss_buffer_desc send_tok, recv_tok;
    gss_name_t client;
    gss_OID doid;
    OM_uint32 maj_stat, min_stat, acc_sec_min_stat;
    gss_buffer_desc oid_name;

    *context = GSS_C_NO_CONTEXT;

    do {
        if (recv_token(s, &recv_tok) < 0)
            return -1;

        if (verbose && log) {
            fprintf(log, "Received token (size=%d): \n", recv_tok.length);
            print_token(&recv_tok);
        }

        maj_stat =
            gss_accept_sec_context(&acc_sec_min_stat,
                                  context,
                                  server_creds,
                                  &recv_tok,
                                  GSS_C_NO_CHANNEL_BINDINGS,
                                  &client,
                                  &doid,
```

```

        &send_tok,
        ret_flags,
        NULL, /* ignore time_rec */
        NULL); /* ignore del_cred_handle */

(void) gss_release_buffer(&min_stat, &recv_tok);

if (send_tok.length != 0) {
    if (verbose && log) {
        fprintf(log,
            "Sending accept_sec_context token (size=%d):\n",
            send_tok.length);
        print_token(&send_tok);
    }
    if (send_token(s, &send_tok) < 0) {
        fprintf(log, "failure sending token\n");
        return -1;
    }

    (void) gss_release_buffer(&min_stat, &send_tok);
}
if (maj_stat!=GSS_S_COMPLETE && maj_stat!=GSS_S_CONTINUE_NEEDED) {
    display_status("accepting context", maj_stat,
        acc_sec_min_stat);
    if (*context == GSS_C_NO_CONTEXT)
        gss_delete_sec_context(&min_stat, context,
            GSS_C_NO_BUFFER);

    return -1;
}

if (verbose && log) {
    if (maj_stat == GSS_S_CONTINUE_NEEDED)
        fprintf(log, "continue needed...\n");
    else
        fprintf(log, "\n");
    fflush(log);
}
} while (maj_stat == GSS_S_CONTINUE_NEEDED);

/* display the flags */
display_ctx_flags(*ret_flags);

if (verbose && log) {
    maj_stat = gss_oid_to_str(&min_stat, doid, &oid_name);
    if (maj_stat != GSS_S_COMPLETE) {
        display_status("converting oid->string", maj_stat, min_stat);
        return -1;
    }
}

```

```
        fprintf(log, "Accepted connection using mechanism OID %.*s.\n",
                (int) oid_name.length, (char *) oid_name.value);
        (void) gss_release_buffer(&min_stat, &oid_name);
    }

    maj_stat = gss_display_name(&min_stat, client, client_name, &doid);
    if (maj_stat != GSS_S_COMPLETE) {
        display_status("displaying name", maj_stat, min_stat);
        return -1;
    }
    maj_stat = gss_release_name(&min_stat, &client);
    if (maj_stat != GSS_S_COMPLETE) {
        display_status("releasing name", maj_stat, min_stat);
        return -1;
    }
    return 0;
}

/*
 * Function: create_socket
 *
 * Purpose: Opens a listening TCP socket.
 *
 * Arguments:
 *
 *     port          (r) the port number on which to listen
 *
 * Returns: the listening socket file descriptor, or -1 on failure
 *
 * Effects:
 *
 * A listening socket on the specified port is created and returned.
 * On error, an error message is displayed and -1 is returned.
 */
int create_socket(port)
    u_short port;
{
    struct sockaddr_in saddr;
    int s;
    int on = 1;

    saddr.sin_family = AF_INET;
    saddr.sin_port = htons(port);
    saddr.sin_addr.s_addr = INADDR_ANY;

    if ((s = socket(AF_INET, SOCK_STREAM, 0)) < 0) {
        perror("creating socket");
        return -1;
    }
}
```

```

    }
    /* Let the socket be reused right away */
    (void) setsockopt(s, SOL_SOCKET, SO_REUSEADDR, (char *)&on,
        sizeof(on));
    if (bind(s, (struct sockaddr *) &saddr, sizeof(saddr)) < 0) {
        perror("binding socket");
        (void) close(s);
        return -1;
    }
    if (listen(s, 5) < 0) {
        perror("listening on socket");
        (void) close(s);
        return -1;
    }
    return s;
}

static float timeval_subtract(tv1, tv2)
    struct timeval *tv1, *tv2;
{
    return ((tv1->tv_sec - tv2->tv_sec) +
        ((float) (tv1->tv_usec - tv2->tv_usec)) / 1000000);
}

/*
 * Yes, yes, this isn't the best place for doing this test.
 * DO NOT REMOVE THIS UNTIL A BETTER TEST HAS BEEN WRITTEN, THOUGH.
 *                                     -TYT
 */
int test_import_export_context(context)
    gss_ctx_id_t *context;
{
    OM_uint32      min_stat, maj_stat;
    gss_buffer_desc context_token, copied_token;
    struct timeval tm1, tm2;

    /*
     * Attempt to save and then restore the context.
     */
    gettimeofday(&tm1, (struct timezone *)0);
    maj_stat = gss_export_sec_context(&min_stat, context, \
        &context_token);
    if (maj_stat != GSS_S_COMPLETE) {
        display_status("exporting context", maj_stat, min_stat);
        return 1;
    }
    gettimeofday(&tm2, (struct timezone *)0);
    if (verbose && log)

```

```
        fprintf(log, "Exported context: %d bytes, %7.4f seconds\n",
                context_token.length, timeval_subtract(&tm2, &tm1));
copied_token.length = context_token.length;
copied_token.value = malloc(context_token.length);
if (copied_token.value == 0) {
    fprintf(log, "Couldn't allocate memory to copy context \
token.\n");
    return 1;
}
memcpy(copied_token.value, context_token.value, \
        copied_token.length);
maj_stat = gss_import_sec_context(&min_stat, &copied_token, \
        context);
if (maj_stat != GSS_S_COMPLETE) {
    display_status("importing context", maj_stat, min_stat);
    return 1;
}
free(copied_token.value);
gettimeofday(&tm1, (struct timezone *)0);
if (verbose && log)
    fprintf(log, "Importing context: %7.4f seconds\n",
            timeval_subtract(&tm1, &tm2));
(void) gss_release_buffer(&min_stat, &context_token);
return 0;
}

/*
 * Function: sign_server
 *
 * Purpose: Performs the "sign" service.
 *
 * Arguments:
 *
 *     s                (r) a TCP socket on which a connection has been
 *                      accept()ed
 *     service_name     (r) the ASCII name of the GSS-API service to
 *                      establish a context as
 *
 * Returns: -1 on error
 *
 * Effects:
 *
 * sign_server establishes a context, and performs a single sign request.
 *
 * A sign request is a single GSS-API sealed token. The token is
 * unsealed and a signature block, produced with gss_sign, is returned
 * to the sender. The context is then destroyed and the connection
 * closed.
 */
```

```

*
* If any error occurs, -1 is returned.
*/
int sign_server(s, server_creds)
    int s;
    gss_cred_id_t server_creds;
{
    gss_buffer_desc client_name, xmit_buf, msg_buf;
    gss_ctx_id_t context;
    OM_uint32 maj_stat, min_stat;
    int i, conf_state, ret_flags;
    char      *cp;

    /* Establish a context with the client */
    if (server_establish_context(s, server_creds, &context,
                                &client_name, &ret_flags) < 0)
        return(-1);

    printf("Accepted connection: \".*s\"\n",
           (int) client_name.length, (char *) client_name.value);
    (void) gss_release_buffer(&min_stat, &client_name);

    for (i=0; i < 3; i++)
        if (test_import_export_context(&context))
            return -1;

    /* Receive the sealed message token */
    if (recv_token(s, &xmit_buf) < 0)
        return(-1);

    if (verbose && log) {
        fprintf(log, "Sealed message token:\n");
        print_token(&xmit_buf);
    }

    maj_stat = gss_unwrap(&min_stat, context, &xmit_buf, &msg_buf,
                          &conf_state, (gss_qop_t *) NULL);
    if (maj_stat != GSS_S_COMPLETE) {
        display_status("unsealing message", maj_stat, min_stat);
        return(-1);
    } else if (! conf_state) {
        fprintf(stderr, "Warning! Message not encrypted.\n");
    }

    (void) gss_release_buffer(&min_stat, &xmit_buf);

    fprintf(log, "Received message: ");
    cp = msg_buf.value;

```

```
    if ((isprint(cp[0]) || isspace(cp[0])) &&
        (isprint(cp[1]) || isspace(cp[1]))) {
        fprintf(log, "\"%.*s\"\n", msg_buf.length, msg_buf.value);
    } else {
        printf("\n");
        print_token(&msg_buf);
    }

    /* Produce a signature block for the message */
    maj_stat = gss_get_mic(&min_stat, context, GSS_C_QOP_DEFAULT,
                        &msg_buf, &xmit_buf);
    if (maj_stat != GSS_S_COMPLETE) {
        display_status("signing message", maj_stat, min_stat);
        return(-1);
    }

    (void) gss_release_buffer(&min_stat, &msg_buf);

    /* Send the signature block to the client */
    if (send_token(s, &xmit_buf) < 0)
        return(-1);

    (void) gss_release_buffer(&min_stat, &xmit_buf);

    /* Delete context */
    maj_stat = gss_delete_sec_context(&min_stat, &context, NULL);
    if (maj_stat != GSS_S_COMPLETE) {
        display_status("deleting context", maj_stat, min_stat);
        return(-1);
    }

    fflush(log);

    return(0);
}

int
main(argc, argv)
    int argc;
    char **argv;
{
    char *service_name;
    gss_cred_id_t server_creds;
    OM_uint32 min_stat;
    u_short port = 4444;
    int s;
    int once = 0;
    int do_inetd = 0;
```



```
log = stdout;
display_file = stdout;
argc--; argv++;
while (argc) {
    if (strcmp(*argv, "-port") == 0) {
        argc--; argv++;
        if (!argc) usage();
        port = atoi(*argv);
    } else if (strcmp(*argv, "-verbose") == 0) {
        verbose = 1;
    } else if (strcmp(*argv, "-once") == 0) {
        once = 1;
    } else if (strcmp(*argv, "-inetd") == 0) {
        do_inetd = 1;
    } else if (strcmp(*argv, "-logfile") == 0) {
        argc--; argv++;
        if (!argc) usage();
        log = fopen(*argv, "a");
        display_file = log;
        if (!log) {
            perror(*argv);
            exit(1);
        }
    } else
        break;
    argc--; argv++;
}
if (argc != 1)
    usage();

if ((*argv)[0] == '-')
    usage();

service_name = *argv;

if (server_acquire_creds(service_name, &server_creds) < 0)
    return -1;

if (do_inetd) {
    close(1);
    close(2);

    sign_server(0, server_creds);
    close(0);
} else {
    int stmp;
```

```
    if ((stmp = create_socket(port)) >= 0) {
        do {
            /* Accept a TCP connection */
            if ((s = accept(stmp, NULL, 0)) < 0) {
                perror("accepting connection");
                continue;
            }
            /* this return value is not checked, because there's
               not really anything to do if it fails */
            sign_server(s, server_creds);
            close(s);
        } while (!once);

        close(stmp);
    }
}

(void) gss_release_cred(&min_stat, &server_creds);

/*NOTREACHED*/
(void) close(s);
return 0;
}
```

Miscellaneous GSS-API Sample Functions

To make the client and server programs work as shown, a number of other functions are required. These functions are used to display values. The functions are not otherwise needed. The functions in this category are as follows:

- `send_token()` – Transfers tokens and messages to a recipient
- `recv_token()` – Accepts tokens and messages from a sender
- `display_status()` – Shows the status returned by the last GSS-API function called
- `write_all()` – Writes a buffer to a file
- `read_all()` – Reads a file into a buffer
- `display_ctx_flags()` – Shows in a readable form information about the current context, such as whether confidentiality or mutual authentication is allowed
- `print_token()` – Prints out a token's value

The code for these functions is shown in the following example.

EXAMPLE 32 Code Listings for Miscellaneous GSS-API Functions

```

/*
 * Copyright 1994 by OpenVision Technologies, Inc.
 *
 * Permission to use, copy, modify, distribute, and sell this software
 * and its documentation for any purpose is hereby granted without fee,
 * provided that the above copyright notice appears in all copies and
 * that both that copyright notice and this permission notice appear in
 * supporting documentation, and that the name of OpenVision not be used
 * in advertising or publicity pertaining to distribution of the software
 * without specific, written prior permission. OpenVision makes no
 * representations about the suitability of this software for any
 * purpose. It is provided "as is" without express or implied warranty.
 *
 * OPENVISION DISCLAIMS ALL WARRANTIES WITH REGARD TO THIS SOFTWARE,
 * INCLUDING ALL IMPLIED WARRANTIES OF MERCHANTABILITY AND FITNESS, IN NO
 * EVENT SHALL OPENVISION BE LIABLE FOR ANY SPECIAL, INDIRECT OR
 * CONSEQUENTIAL DAMAGES OR ANY DAMAGES WHATSOEVER RESULTING FROM LOSS OF
 * USE, DATA OR PROFITS, WHETHER IN AN ACTION OF CONTRACT, NEGLIGENCE OR
 * OTHER TORTIOUS ACTION, ARISING OUT OF OR IN CONNECTION WITH THE USE OR
 * PERFORMANCE OF THIS SOFTWARE.
 */

#if !defined(lint) && !defined(__CODECENTER__)
static char *rcsid = "$Header: /cvs/krbdev/krb5/src/appl/gss-sample/\
gss-misc.c, v 1.15 1996/07/22 20:21:20 marc Exp $";
#endif

#include <stdio.h>
#include <sys/types.h>
#include <netinet/in.h>
#include <errno.h>
#include <unistd.h>
#include <string.h>

#include <gssapi/gssapi.h>
#include <gssapi/gssapi_ext.h>
#include <gss-misc.h>

#include <stdlib.h>

FILE *display_file;

static void display_status_1
    (char *m, OM_uint32 code, int type);

static int write_all(int fildes, char *buf, unsigned int nbyte)

```

```
{
    int ret;
    char *ptr;

    for (ptr = buf; nbyte; ptr += ret, nbyte -= ret) {
        ret = write(fildes, ptr, nbyte);
        if (ret < 0) {
            if (errno == EINTR)
                continue;
            return(ret);
        } else if (ret == 0) {
            return(ptr-buf);
        }
    }

    return(ptr-buf);
}

static int read_all(int fildes, char *buf, unsigned int nbyte)
{
    int ret;
    char *ptr;

    for (ptr = buf; nbyte; ptr += ret, nbyte -= ret) {
        ret = read(fildes, ptr, nbyte);
        if (ret < 0) {
            if (errno == EINTR)
                continue;
            return(ret);
        } else if (ret == 0) {
            return(ptr-buf);
        }
    }

    return(ptr-buf);
}

/*
 * Function: send_token
 *
 * Purpose: Writes a token to a file descriptor.
 *
 * Arguments:
 *
 *     s          (r) an open file descriptor
 *     tok        (r) the token to write
 *
 * Returns: 0 on success, -1 on failure

```

```

*
* Effects:
*
* send_token writes the token length (as a network long) and then the
* token data to the file descriptor s. It returns 0 on success, and
* -1 if an error occurs or if it could not write all the data.
*/
int send_token(s, tok)
    int s;
    gss_buffer_t tok;
{
    int len, ret;

    len = htonl(tok->length);

    ret = write_all(s, (char *) &len, 4);
    if (ret < 0) {
        perror("sending token length");
        return -1;
    } else if (ret != 4) {
        if (display_file)
            fprintf(display_file,
                    "sending token length: %d of %d bytes written\n",
                    ret, 4);
        return -1;
    }

    ret = write_all(s, tok->value, tok->length);
    if (ret < 0) {
        perror("sending token data");
        return -1;
    } else if (ret != tok->length) {
        if (display_file)
            fprintf(display_file,
                    "sending token data: %d of %d bytes written\n",
                    ret, tok->length);
        return -1;
    }

    return 0;
}

/*
* Function: rcv_token
*
* Purpose: Reads a token from a file descriptor.
*
* Arguments:

```

```
*
*      s          (r) an open file descriptor
*      tok        (w) the read token
*
* Returns: 0 on success, -1 on failure
*
* Effects:
*
* recv_token reads the token length (as a network long), allocates
* memory to hold the data, and then reads the token data from the
* file descriptor s. It blocks to read the length and data, if
* necessary. On a successful return, the token should be freed with
* gss_release_buffer. It returns 0 on success, and -1 if an error
* occurs or if it could not read all the data.
*/
int recv_token(s, tok)
    int s;
    gss_buffer_t tok;
{
    int ret;

    ret = read_all(s, (char *) &tok->length, 4);
    if (ret < 0) {
        perror("reading token length");
        return -1;
    } else if (ret != 4) {
        if (display_file)
            fprintf(display_file,
                    "reading token length: %d of %d bytes read\n",
                    ret, 4);
        return -1;
    }

    tok->length = ntohl(tok->length);
    tok->value = (char *) malloc(tok->length);
    if (tok->value == NULL) {
        if (display_file)
            fprintf(display_file,
                    "Out of memory allocating token data\n");
        return -1;
    }

    ret = read_all(s, (char *) tok->value, tok->length);
    if (ret < 0) {
        perror("reading token data");
        free(tok->value);
        return -1;
    } else if (ret != tok->length) {
```

```

        fprintf(stderr, "sending token data: %d of %d bytes written\n",
                ret, tok->length);
        free(tok->value);
        return -1;
    }

    return 0;
}

static void display_status_1(m, code, type)
    char *m;
    OM_uint32 code;
    int type;
{
    OM_uint32 maj_stat, min_stat;
    gss_buffer_desc msg;
    OM_uint32 msg_ctx;

    msg_ctx = 0;
    while (1) {
        maj_stat = gss_display_status(&min_stat, code,
                                    type, GSS_C_NULL_OID,
                                    &msg_ctx, &msg);

        if (display_file)
            fprintf(display_file, "GSS-API error %s: %s\n", m,
                    (char *)msg.value);
        (void) gss_release_buffer(&min_stat, &msg);

        if (!msg_ctx)
            break;
    }
}

/*
 * Function: display_status
 *
 * Purpose: displays GSS-API messages
 *
 * Arguments:
 *
 *     msg          a string to be displayed with the message
 *     maj_stat     the GSS-API major status code
 *     min_stat     the GSS-API minor status code
 *
 * Effects:
 *
 * The GSS-API messages associated with maj_stat and min_stat are
 * displayed on stderr, each preceded by "GSS-API error <msg>: " and

```

```
    * followed by a newline.
    */
void display_status(msg, maj_stat, min_stat)
    char *msg;
    OM_uint32 maj_stat;
    OM_uint32 min_stat;
{
    display_status_1(msg, maj_stat, GSS_C_GSS_CODE);
    display_status_1(msg, min_stat, GSS_C_MECH_CODE);
}

/*
 * Function: display_ctx_flags
 *
 * Purpose: displays the flags returned by context initiation in
 *          a human-readable form
 *
 * Arguments:
 *
 *          int          ret_flags
 *
 * Effects:
 *
 * Strings corresponding to the context flags are printed on
 * stdout, preceded by "context flag: " and followed by a newline
 */
void display_ctx_flags(flags)
    OM_uint32 flags;
{
    if (flags & GSS_C_DELEG_FLAG)
        fprintf(display_file, "context flag: GSS_C_DELEG_FLAG\n");
    if (flags & GSS_C_MUTUAL_FLAG)
        fprintf(display_file, "context flag: GSS_C_MUTUAL_FLAG\n");
    if (flags & GSS_C_REPLAY_FLAG)
        fprintf(display_file, "context flag: GSS_C_REPLAY_FLAG\n");
    if (flags & GSS_C_SEQUENCE_FLAG)
        fprintf(display_file, "context flag: GSS_C_SEQUENCE_FLAG\n");
    if (flags & GSS_C_CONF_FLAG )
        fprintf(display_file, "context flag: GSS_C_CONF_FLAG \n");
    if (flags & GSS_C_INTEG_FLAG )
        fprintf(display_file, "context flag: GSS_C_INTEG_FLAG \n");
}

void print_token(tok)
    gss_buffer_t tok;
{
    int i;
```



```
    unsigned char *p = tok->value;

    if (!display_file)
        return;
    for (i=0; i < tok->length; i++, p++) {
        fprintf(display_file, "%02x ", *p);
        if ((i % 16) == 15) {
            fprintf(display_file, "\n");
        }
    }
    fprintf(display_file, "\n");
    fflush(display_file);
}
```

GSS-API Reference

This appendix includes the following sections:

- [“GSS-API Functions” on page 243](#) provides a table of GSS-API functions.
- [“GSS-API Status Codes” on page 246](#) discusses status codes returned by GSS-API functions, and provides a list of those status codes.
- [“GSS-API Data Types and Values” on page 249](#) discusses the various data types used by GSS-API.
- [“Implementation-Specific Features in GSS-API” on page 253](#) covers features that are unique to the Oracle Solaris implementation of GSS-API.
- [“Kerberos v5 Status Codes” on page 256](#) lists the status codes that can be returned by the Kerberos v5 mechanism.

Additional GSS-API definitions can be found in the file `gssapi.h`.

GSS-API Functions

The Oracle Solaris software implements the GSS-API functions. For more information on each function, see its man page. See also [“Functions From Previous Versions of GSS-API” on page 245](#).

<code>gss_acquire_cred()</code>	Assume a global identity by obtaining a GSS-API credential handle for preexisting credentials
<code>gss_add_cred()</code>	Construct credentials incrementally
<code>gss_inquire_cred()</code>	Obtain information about a credential
<code>gss_inquire_cred_by_mech()</code>	Obtain per-mechanism information about a credential
<code>gss_release_cred()</code>	Discard a credential handle

<code>gss_init_sec_context()</code>	Initiate a security context with a peer application
<code>gss_accept_sec_context()</code>	Accept a security context initiated by a peer application
<code>gss_delete_sec_context()</code>	Discard a security context
<code>gss_process_context_token()</code>	Process a token on a security context from a peer application
<code>gss_context_time()</code>	Determine how long a context is to remain valid
<code>gss_inquire_context()</code>	Obtain information about a security context
<code>gss_wrap_size_limit()</code>	Determine token-size limit for <code>gss_wrap()</code> on a context
<code>gss_export_sec_context()</code>	Transfer a security context to another process
<code>gss_import_sec_context()</code>	Import a transferred context
<code>gss_get_mic()</code>	Calculate a cryptographic message integrity code (MIC) for a message
<code>gss_verify_mic()</code>	Check a MIC against a message to verify integrity of a received message
<code>gss_wrap()</code>	Attach a MIC to a message, and optionally encrypt the message content
<code>gss_unwrap()</code>	Verify a message with attached MIC. Decrypt message content if necessary
<code>gss_import_name()</code>	Convert a contiguous string name to an internal-form name
<code>gss_display_name()</code>	Convert internal-form name to text
<code>gss_compare_name()</code>	Compare two internal-form names
<code>gss_release_name()</code>	Discard an internal-form name
<code>gss_inquire_names_for_mech()</code>	List the name types supported by the specified mechanism
<code>gss_inquire_mechs_for_name()</code>	List mechanisms that support the specified name type
<code>gss_canonicalize_name()</code>	Convert an internal name to a mechanism name (MN)

<code>gss_export_name()</code>	Convert an MN to export form
<code>gss_duplicate_name()</code>	Create a copy of an internal name
<code>gss_add_oid_set_member()</code>	Add an object identifier to a set
<code>gss_display_status()</code>	Convert a GSS-API status code to text
<code>gss_indicate_mechs()</code>	Determine available underlying authentication mechanisms
<code>gss_release_buffer()</code>	Discard a buffer
<code>gss_release_oid_set()</code>	Discard a set of object identifiers
<code>gss_create_empty_oid_set()</code>	Create a set with no object identifiers
<code>gss_test_oid_set_member()</code>	Determine whether an object identifier is a member of a set

Functions From Previous Versions of GSS-API

This section explains functions that were included in previous versions of the GSS-API.

Functions for Manipulating OIDs

The Oracle Solaris implementation of GSS-API provides the following functions for convenience and for backward compatibility. However, these functions might not be supported by other implementations of GSS-API.

- `gss_delete_oid()`
- `gss_oid_to_str()`
- `gss_str_to_oid()`

Although a mechanism's name can be converted from a string to an OID, programmers should use the default GSS-API mechanism if at all possible.

Renamed Functions

The following functions have been supplanted by newer functions. In each case, the new function is the functional equivalent of the older function. Although the old functions are

supported, developers should replace these functions with the newer functions whenever possible.

- `gss_sign()` has been replaced with `gss_get_mic()`.
- `gss_verify()` has been replaced with `gss_verify_mic()`.
- `gss_seal()` has been replaced with `gss_wrap()`.
- `gss_unseal()` has been replaced with `gss_unwrap()`.

GSS-API Status Codes

Major status codes are encoded in the `OM_uint32` as shown in the following figure.

FIGURE 18 Major-Status Encoding

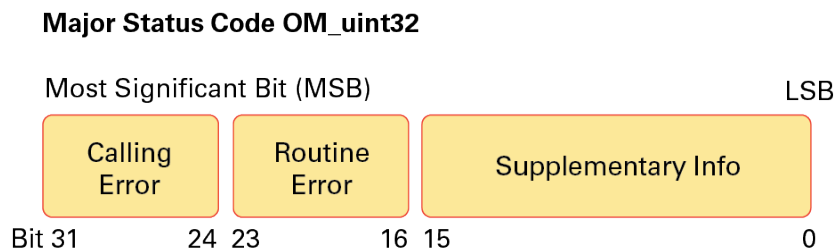

If a GSS-API routine returns a GSS status code whose upper 16 bits contain a nonzero value, the call has failed. If the calling error field is nonzero, the application's call of the routine was erroneous. The *calling errors* are listed in [Table 3, “GSS-API Calling Errors,” on page 247](#). If the routine error field is nonzero, the routine failed because of a *routine-specific error*, as listed in [Table 4, “GSS-API Routine Errors,” on page 247](#). The bits in the supplementary information field of the status code can be set whether the upper 16 bits indicate a failure or a success. The meaning of individual bits is listed in [Table 5, “GSS-API Supplementary Information Codes,” on page 248](#).

GSS-API Major Status Code Values

The following tables list the calling errors that are returned by GSS-API. These errors are specific to a particular language-binding, which is C in this case.

TABLE 3 GSS-API Calling Errors

Error	Value in Field	Meaning
GSS_S_CALL_INACCESSIBLE_READ	1	An input parameter that is required could not be read
GSS_S_CALL_INACCESSIBLE_WRITE	2	A required output parameter could not be written
GSS_S_CALL_BAD_STRUCTURE	3	A parameter was malformed

The following table lists the GSS-API routine errors, generic errors that are returned by GSS-API functions.

TABLE 4 GSS-API Routine Errors

Error	Value in Field	Meaning
GSS_S_BAD_MECH	1	An unsupported mechanism was requested.
GSS_S_BAD_NAME	2	An invalid name was supplied.
GSS_S_BAD_NAME_TYPE	3	A supplied name was of an unsupported type.
GSS_S_BAD_BINDINGS	4	Incorrect channel bindings were supplied.
GSS_S_BAD_STATUS	5	An invalid status code was supplied.
GSS_S_BAD_MIC, GSS_S_BAD_SIG	6	A token had an invalid MIC.
GSS_S_NO_CRED	7	The credentials were unavailable, inaccessible, or not supplied.
GSS_S_NO_CONTEXT	8	No context has been established.
GSS_S_DEFECTIVE_TOKEN	9	A token was invalid.
GSS_S_DEFECTIVE_CREDENTIAL	10	A credential was invalid.
GSS_S_CREDENTIALS_EXPIRED	11	The referenced credentials have expired.
GSS_S_CONTEXT_EXPIRED	12	The context has expired.
GSS_S_FAILURE	13	Miscellaneous failure. The underlying mechanism detected an error for which no specific GSS-API status code is defined. The mechanism-specific status code, that is, the minor-status code, provides more details about the error.
GSS_S_BAD_QOP	14	The quality of protection that was requested could not be provided.
GSS_S_UNAUTHORIZED	15	The operation is forbidden by local security policy.
GSS_S_UNAVAILABLE	16	The operation or option is unavailable.
GSS_S_DUPLICATE_ELEMENT	17	The requested credential element already exists.
GSS_S_NAME_NOT_MN	18	The provided name was not a mechanism name (MN).

The name GSS_S_COMPLETE, which is a zero value, indicates an absence of any API errors or supplementary information bits.

The following table lists the supplementary information values returned by GSS-API functions.

TABLE 5 GSS-API Supplementary Information Codes

Code	Bit Number	Meaning
GSS_S_CONTINUE_NEEDED	0 (LSB)	Returned only by <code>gss_init_sec_context()</code> or <code>gss_accept_sec_context()</code> . The routine must be called again to complete its function.
GSS_S_DUPLICATE_TOKEN	1	The token was a duplicate of an earlier token.
GSS_S_OLD_TOKEN	2	The token's validity period has expired.
GSS_S_UNSEQ_TOKEN	3	A later token has already been processed.
GSS_S_GAP_TOKEN	4	An expected per-message token was not received.

For more on status codes, see [“GSS-API Status Codes” on page 74](#).

Displaying Status Codes

The function `gss_display_status()` translates GSS-API status codes into text format. This format allows the codes to be displayed to a user or put in a text log. `gss_display_status()` only displays one status code at a time, and some functions can return multiple status conditions. Accordingly, `gss_display_status()` should be called as part of a loop. When `gss_display_status()` indicates a non-zero status code, another status code is available for the function to fetch.

EXAMPLE 33 Displaying Status Codes with `gss_display_status()`

```
OM_uint32 message_context;
OM_uint32 status_code;
OM_uint32 maj_status;
OM_uint32 min_status;
gss_buffer_desc status_string;

...

message_context = 0;

do {

    maj_status = gss_display_status(
        &min_status,
```



```

        status_code,
        GSS_C_GSS_CODE,
        GSS_C_NO_OID,
        &message_context,
        &status_string);

    fprintf(stderr, "%.*s\n", \
            (int)status_string.length, \
            (char *)status_string.value);

    gss_release_buffer(&min_status, &status_string,);
} while (message_context != 0);

```

Status Code Macros

The macros, `GSS_CALLING_ERROR()`, `GSS_ROUTINE_ERROR()` and `GSS_SUPPLEMENTARY_INFO()`, take a GSS status code. These macros remove all information except for the relevant field. For example, the `GSS_ROUTINE_ERROR()` can be applied to a status code to remove the calling errors and supplementary information fields. This operation leaves the routine errors field only. The values delivered by these macros can be directly compared with a `GSS_S_XXX` symbol of the appropriate type. The macro `GSS_ERROR()` returns a non-zero value if a status code indicates a calling or routine error, and a zero value otherwise. All macros that are defined by GSS-API evaluate the arguments exactly once.

GSS-API Data Types and Values

This section describes various types of GSS-API data types and values. Some data types, such as `gss_cred_id_t` or `gss_name_t`, are opaque to the user. These data types do not need to be discussed. This section explains the following topics:

- [“Basic GSS-API Data Types” on page 250](#) - Shows the definitions of the `OM_uint32`, `gss_buffer_desc`, `gss_OID_desc`, `gss_OID_set_desc_struct`, and `gss_channel_bindings_struct` data types.
- [“Name Types” on page 251](#) – Shows the various name formats recognized by the GSS-API for specifying names.
- [“Address Types for Channel Bindings” on page 252](#) – Shows the various values that can be used as the `initiator_addrtype` and `acceptor_addrtype` fields of the `gss_channel_bindings_t` structure.

Basic GSS-API Data Types

This section describes data types that are used by GSS-API.

OM_uint32 Data Type

The OM_uint32 is a platform-independent 32-bit unsigned integer.

gss_buffer_desc Data Type

The definition of the gss_buffer_desc with the gss_buffer_t pointer takes the following form:

```
typedef struct gss_buffer_desc_struct {
    size_t length;
    void *value;
} gss_buffer_desc, *gss_buffer_t;
```

gss_OID_desc Data Type

The definition of the gss_OID_desc with the gss_OID pointer takes the following form:

```
typedef struct gss_OID_desc_struct {
    OM_uint32 length;
    void*elements;
} gss_OID_desc, *gss_OID;
```

gss_OID_set_desc Data Type

The definition of the gss_OID_set_desc with the gss_OID_set pointer takes the following form:

```
typedef struct gss_OID_set_desc_struct {
    size_t count;
    gss_OID elements;
```

```
} gss_OID_set_desc, *gss_OID_set;
```

gss_channel_bindings_struct Data Type

The definition of the `gss_channel_bindings_struct` structure and the `gss_channel_bindings_t` pointer has the following form:

```
typedef struct gss_channel_bindings_struct {
    OM_uint32 initiator_addrtype;
    gss_buffer_desc initiator_address;
    OM_uint32 acceptor_addrtype;
    gss_buffer_desc acceptor_address;
    gss_buffer_desc application_data;
} *gss_channel_bindings_t;
```

Name Types

A name type indicates the format of the associated name. See [“Names in GSS-API” on page 67](#) and [“GSS-API OIDs” on page 73](#) for more on names and name types. The GSS-API supports the `gss_OID` name types in the following table.

GSS_C_NO_NAME

The symbolic name `GSS_C_NO_NAME` is recommended as a parameter value to indicate that no value is supplied in the transfer of names.

GSS_C_NO_OID

This value corresponds to a null input value instead of an actual object identifier. Where specified, the value indicates interpretation of an associated name that is based on a mechanism-specific default printable syntax.

GSS_C_NT_ANONYMOUS

A means to identify anonymous names. This value can be compared with to determine in a mechanism-independent fashion whether a name refers to an anonymous principal.

GSS_C_NT_EXPORT_NAME

A name that has been exported with the `gss_export_name()` function.

GSS_C_NT_HOSTBASED_SERVICE

Used to represent services that are associated with the host. This name form is constructed using two elements, service and hostname, as follows: *service@hostname*.

GSS_C_NT_MACHINE_UID_NAME

Used to indicate a numeric user identifier corresponding to a user on a local system. The interpretation of this value is OS-specific. The `gss_import_name()` function resolves this UID into a user name, which is then treated as the User Name Form.

GSS_C_NT_STRING_STRING_UID_NAME

Used to indicate a string of digits that represents the numeric user identifier of a user on a local system. The interpretation of this value is OS-specific. This name type is similar to the Machine UID Form, except that the buffer contains a string that represents the user ID.

GSS_C_NT_USER_NAME

A named user on a local system. The interpretation of this value is OS-specific. The value takes the form: *username*.

Address Types for Channel Bindings

The following table shows the possible values for the *initiator_addrtype* and *acceptor_addrtype* fields of the `gss_channel_bindings_struct` structure. These fields indicate the format that a name can take, for example, ARPAnet IMP address or AppleTalk address. Channel bindings are discussed in [“Using Channel Bindings in GSS-API” on page 85](#).

TABLE 6 Channel Binding Address Types

Field	Value (Decimal)	Address Type
GSS_C_AF_UNSPEC	0	Unspecified address type
GSS_C_AF_LOCAL	1	Host-local
GSS_C_AF_INET	2	Internet address type, for example, IP
GSS_C_AF_IMPLINK	3	ARPAnet IMP
GSS_C_AF_PUP	4	pup protocols, for example, BSP
GSS_C_AF_CHAOS	5	MIT CHAOS protocol
GSS_C_AF_NS	6	XEROX NS
GSS_C_AF_NBS	7	nbs
GSS_C_AF_ECMA	8	ECMA
GSS_C_AF_DATAKIT	9	Datakit protocols
GSS_C_AF_CCITT	10	CCITT
GSS_C_AF_SNA	11	IBM SNA
GSS_C_AF_DECnet	12	DECnet
GSS_C_AF_DLI	13	Direct data link interface
GSS_C_AF_LAT	14	LAT

Field	Value (Decimal)	Address Type
GSS_C_AF_HYLINK	15	NSC Hyperchannel
GSS_C_AF_APPLETALK	16	AppleTalk
GSS_C_AF_BSC	17	BISYNC
GSS_C_AF_DSS	18	Distributed system services
GSS_C_AF_OSI	19	OSI TP4
GSS_C_AF_X25	21	X.25
GSS_C_AF_NULLADDR	255	No address specified

Implementation-Specific Features in GSS-API

Some aspects of the GSS-API can differ between implementations of the API. In most cases, differences in implementations have only minimal effect on programs. In all cases, developers can maximize portability by not relying on any behavior that is specific to a given implementation, including the Oracle Solaris implementation.

Oracle Solaris-Specific Functions

The Oracle Solaris implementation does not have customized GSS-API functions.

Human-Readable Name Syntax

Implementations of GSS-API can differ in the printable syntax that corresponds to names. For portability, applications should not compare names that use human-readable, that is, printable, forms. Instead, such applications should use `gss_compare_name()` to determine whether an internal-format name matches any other name.

The Oracle Solaris implementation of `gss_display_name()` displays names as follows. If the *input_name* argument denotes a user principal, the `gss_display_name()` returns `user_principal@realm` as the *output_name_buffer* and the `gss_OID` value as the *output_name_type*. If Kerberos v5 is the underlying mechanism, `gss_OID` is `1.2.840.11354.1.2.2`.

If `gss_display_name()` receives a name that was created by `gss_import_name()` with the `GSS_C_NO_OID` name type, `gss_display_name()` returns `GSS_C_NO_OID` in the *output_name_type* parameter.

Format of Anonymous Names

The `gss_display_name()` function outputs the string '<anonymous>' to indicate an anonymous GSS-API principal. The name type OID associated with this name is `GSS_C_NT_ANONYMOUS`. No other valid printable names supported by the Oracle Solaris implementation should be surrounded by angle brackets (<>).

Implementations of Selected Data Types

The following data types have been implemented as pointers, although some implementations might specify these types as arithmetic types: `gss_cred_t`, `gss_ctx_id_t`, and `gss_name_t`.

Deletion of Contexts and Stored Data

When context establishment fails, the Oracle Solaris implementation does not automatically delete partially built contexts. Applications should therefore handle this event by deleting the contexts with `gss_delete_sec_context()`.

The Oracle Solaris implementation automatically releases stored data, such as internal names, through memory management. However, applications should still call appropriate functions, such as `gss_release_name()`, when data elements are no longer needed.

Protection of Channel-Binding Information

Support for channel bindings varies by mechanism. Both the Diffie-Hellman mechanism and the Kerberos v5 mechanism support channel bindings.

Developers should assume that channel bindings data do not have confidentiality protection. Although the Kerberos v5 mechanism provides this protection, confidentiality for channel-bindings data is not available with the Diffie-Hellman mechanism.

Context Exportation and Interprocess Tokens

The Oracle Solaris implementation detects and rejects attempted multiple imports of the same context.

Types of Credentials Supported

The Oracle Solaris implementation of the GSS-API supports the acquisition of `GSS_C_INITIATE`, `GSS_C_ACCEPT`, and `GSS_C_BOTH` credentials through `gss_acquire_cred()`.

Credential Expiration

The Oracle Solaris implementation of the GSS-API supports credential expiration. Therefore, programmers can use parameters that relate to credential lifetime in functions such as `gss_acquire_cred()` and `gss_add_cred()`.

Context Expiration

The Oracle Solaris implementation of the GSS-API supports context expiration. Therefore, programmers can use parameters that relate to context lifetime in functions such as `gss_init_sec_context()` and `gss_inquire_context()`.

Wrap Size Limits and QOP Values

The Oracle Solaris implementation of the GSS-API, as opposed to any underlying mechanism, does not impose a maximum size for messages to be processed by `gss_wrap()`. Applications can determine the maximum message size with `gss_wrap_size_limit()`.

The Oracle Solaris implementation of the GSS-API detects invalid QOP values when `gss_wrap_size_limit()` is called.

Use of *minor_status* Parameter

In the Oracle Solaris implementation of the GSS-API, functions return only mechanism-specific information in the *minor_status* parameter. Other implementations might include implementation-specific return values as part of the returned minor-status code.

Kerberos v5 Status Codes

Each GSS-API function returns two status codes: a *major status code* and a *minor status code*. Major status codes relate to the behavior of GSS-API. For example, if an application attempts to transmit a message after a security context has expired, GSS-API returns a major status code of GSS_S_CONTEXT_EXPIRED. Major status codes are listed in [“GSS-API Status Codes” on page 246](#).

Minor status codes are returned by the underlying security mechanisms supported by a given implementation of GSS-API. Every GSS-API function takes as the first argument a *minor_status* or *minor_stat* parameter. An application can examine this parameter when the function returns, successfully or not, to see the status that is returned by the underlying mechanism.

The following tables list the status messages that can be returned by Kerberos v5 in the *minor_status* argument. For more on GSS-API status codes, see [“GSS-API Status Codes” on page 74](#).

Messages Returned in Kerberos v5 for Status Code 1

The following table lists the minor status messages that are returned in Kerberos v5 for status code 1.

TABLE 7 Kerberos v5 Status Codes 1

Minor Status	Value	Meaning
KRB5KDC_ERR_NONE	-1765328384L	No error
KRB5KDC_ERR_NAME_EXP	-1765328383L	Client's entry in database has expired
KRB5KDC_ERR_SERVICE_EXP	-1765328382L	Server's entry in database has expired
KRB5KDC_ERR_BAD_PVNO	-1765328381L	Requested protocol version not supported
KRB5KDC_ERR_C_OLD_MAST_KVNO	-1765328380L	Client's key is encrypted in an old master key
KRB5KDC_ERR_S_OLD_MAST_KVNO	-1765328379L	Server's key is encrypted in an old master key
KRB5KDC_ERR_C_PRINCIPAL_UNKNOWN	-1765328378L	Client not found in Kerberos database
KRB5KDC_ERR_S_PRINCIPAL_UNKNOWN	-1765328377L	Server not found in Kerberos database
KRB5KDC_ERR_PRINCIPAL_NOT_UNIQUE	-1765328376L	Principal has multiple entries in Kerberos database
KRB5KDC_ERR_NULL_KEY	-1765328375L	Client or server has a null key

Minor Status	Value	Meaning
KRB5KDC_ERR_CANNOT_POSTDATE	-1765328374L	Ticket is ineligible for postdating
KRB5KDC_ERR_NEVER_VALID	-1765328373L	Requested effective lifetime is negative or too short
KRB5KDC_ERR_POLICY	-1765328372L	KDC policy rejects request
KRB5KDC_ERR_BADOPTION	-1765328371L	KDC can't fulfill requested option
KRB5KDC_ERR_ETYPE_NOSUPP	-1765328370L	KDC has no support for encryption type
KRB5KDC_ERR_SUMTYPE_NOSUPP	-1765328369L	KDC has no support for checksum type
KRB5KDC_ERR_PADATA_TYPE_NOSUPP	-1765328368L	KDC has no support for padata type
KRB5KDC_ERR_TRTYPE_NOSUPP	-1765328367L	KDC has no support for transited type
KRB5KDC_ERR_CLIENT_REVOKED	-1765328366L	Client's credentials have been revoked
KRB5KDC_ERR_SERVICE_REVOKED	-1765328365L	Credentials for server have been revoked

Messages Returned in Kerberos v5 for Status Code 2

The following table lists the minor status messages that are returned in Kerberos v5 for status code 2.

TABLE 8 Kerberos v5 Status Codes 2

Minor Status	Value	Meaning
KRB5KDC_ERR_TGT_REVOKED	-1765328364L	TGT has been revoked
KRB5KDC_ERR_CLIENT_NOTYET	-1765328363L	Client not yet valid, try again later
KRB5KDC_ERR_SERVICE_NOTYET	-1765328362L	Server not yet valid, try again later
KRB5KDC_ERR_KEY_EXP	-1765328361L	Password has expired
KRB5KDC_ERR_PREAUTH_FAILED	-1765328360L	Preauthentication failed
KRB5KDC_ERR_PREAUTH_REQUIRED	-1765328359L	Additional preauthentication required
KRB5KDC_ERR_SERVER_NOMATCH	-1765328358L	Requested server and ticket don't match
KRB5PLACEHOLD_27 through KRB5PLACEHOLD_30	-1765328357L through -1765328354L	KRB5 error codes 27 through 30 (reserved)
KRB5KRB_AP_ERR_BAD_INTEGRITY	-1765328353L	Decrypt integrity check failed
KRB5KRB_AP_ERR_TKT_EXPIRED	-1765328352L	Ticket expired
KRB5KRB_AP_ERR_TKT_NYV	-1765328351L	Ticket not yet valid
KRB5KRB_AP_ERR_REPEAT	-1765328350L	Request is a replay
KRB5KRB_AP_ERR_NOT_US	-1765328349L	The ticket isn't for us
KRB5KRB_AP_ERR_BADMATCH	-1765328348L	Ticket/authenticator do not match
KRB5KRB_AP_ERR_SKEW	-1765328347L	Clock skew too great

Minor Status	Value	Meaning
KRB5KRB_AP_ERR_BADADDR	-1765328346L	Incorrect net address
KRB5KRB_AP_ERR_BADVERSION	-1765328345L	Protocol version mismatch
KRB5KRB_AP_ERR_MSG_TYPE	-1765328344L	Invalid message type
KRB5KRB_AP_ERR_MODIFIED	-1765328343L	Message stream modified
KRB5KRB_AP_ERR_BADORDER	-1765328342L	Message out of order
KRB5KRB_AP_ERR_ILL_CR_TKT	-1765328341L	Illegal cross-realm ticket
KRB5KRB_AP_ERR_BADKEYVER	-1765328340L	Key version is not available

Messages Returned in Kerberos v5 for Status Code 3

The following table lists the minor status messages that are returned in Kerberos v5 for status code 3.

TABLE 9 Kerberos v5 Status Codes 3

Minor Status	Value	Meaning
KRB5KRB_AP_ERR_NOKEY	-1765328339L	Service key not available
KRB5KRB_AP_ERR_MUT_FAIL	-1765328338L	Mutual authentication failed
KRB5KRB_AP_ERR_BADDIRECTION	-1765328337L	Incorrect message direction
KRB5KRB_AP_ERR_METHOD	-1765328336L	Alternative authentication method required
KRB5KRB_AP_ERR_BADSEQ	-1765328335L	Incorrect sequence number in message
KRB5KRB_AP_ERR_INAPP_CKSUM	-1765328334L	Inappropriate type of checksum in message
KRB5PLACEHOLD_51 <i>through</i> KRB5PLACEHOLD_59	-1765328333L <i>through</i> -1765328325L	KRB5 error codes 51 <i>through</i> 59 (reserved)
KRB5KRB_ERR_GENERIC	-1765328324L	Generic error
KRB5KRB_ERR_FIELD_TOOLONG	-1765328323L	Field is too long for this implementation
KRB5PLACEHOLD_62 <i>through</i> KRB5PLACEHOLD_127	-1765328322L <i>through</i> -1765328257L	KRB5 error codes 62 <i>through</i> 127 (reserved)
<i>value not returned</i>	-1765328256L	<i>For internal use only</i>
KRB5_LIBOS_BADLOCKFLAG	-1765328255L	Invalid flag for file lock mode
KRB5_LIBOS_CANTREADPWD	-1765328254L	Cannot read password
KRB5_LIBOS_BADPDMATCH	-1765328253L	Password mismatch
KRB5_LIBOS_PWDINTR	-1765328252L	Password read interrupted
KRB5_PARSE_ILLCHAR	-1765328251L	Illegal character in component name
KRB5_PARSE_MALFORMED	-1765328250L	Malformed representation of principal

Minor Status	Value	Meaning
KRB5_CONFIG_CANTOPEN	-1765328249L	Can't open/find Kerberos /etc/krb5/krb5 configuration file
KRB5_CONFIG_BADFORMAT	-1765328248L	Improper format of Kerberos /etc/krb5/krb5 configuration file
KRB5_CONFIG_NOTENUFSPACE	-1765328247L	Insufficient space to return complete information
KRB5_BADMSGTYPE	-1765328246L	Invalid message type has been specified for encoding
KRB5_CC_BADNAME	-1765328245L	Credential cache name malformed

Messages Returned in Kerberos v5 for Status Code 4

The following table lists the minor status messages that are returned in Kerberos v5 for status code 4.

TABLE 10 Kerberos v5 Status Codes 4

Minor Status	Value	Meaning
KRB5_CC_UNKNOWN_TYPE	-1765328244L	Unknown credential cache type
KRB5_CC_NOTFOUND	-1765328243L	No matching credential has been found
KRB5_CC_END	-1765328242L	End of credential cache reached
KRB5_NO_TKT_SUPPLIED	-1765328241L	Request did not supply a ticket
KRB5KRB_AP_WRONG_PRINC	-1765328240L	Wrong principal in request
KRB5KRB_AP_ERR_TKT_INVALID	-1765328239L	Ticket has invalid flag set
KRB5_PRINC_NOMATCH	-1765328238L	Requested principal and ticket don't match
KRB5_KDCREP_MODIFIED	-1765328237L	KDC reply did not match expectations
KRB5_KDCREP_SKEW	-1765328236L	Clock skew too great in KDC reply
KRB5_IN_TKT_REALM_MISMATCH	-1765328235L	Client/server realm mismatch in initial ticket request
KRB5_PROG_ETYPE_NOSUPP	-1765328234L	Program lacks support for encryption type
KRB5_PROG_KEYTYPE_NOSUPP	-1765328233L	Program lacks support for key type
KRB5_WRONG_ETYPE	-1765328232L	Requested encryption type not used in message
KRB5_PROG_SUMTYPE_NOSUPP	-1765328231L	Program lacks support for checksum type
KRB5_REALM_UNKNOWN	-1765328230L	Cannot find KDC for requested realm
KRB5_SERVICE_UNKNOWN	-1765328229L	Kerberos service unknown
KRB5_KDC_UNREACH	-1765328228L	Cannot contact any KDC for requested realm
KRB5_NO_LOCALNAME	-1765328227L	No local name found for principal name

Minor Status	Value	Meaning
KRB5_MUTUAL_FAILED	-1765328226L	Mutual authentication failed
KRB5_RC_TYPE_EXISTS	-1765328225L	Replay cache type is already registered
KRB5_RC_MALLOC	-1765328224L	No more memory to allocate in replay cache code
KRB5_RC_TYPE_NOTFOUND	-1765328223L	Replay cache type is unknown

Messages Returned in Kerberos v5 for Status Code 5

The following table lists the minor status messages that are returned in Kerberos v5 for status code 5.

TABLE 11 Kerberos v5 Status Codes 5

Minor Status	Value	Meaning
KRB5_RC_UNKNOWN	-1765328222L	Generic unknown RC error
KRB5_RC_REPLAY	-1765328221L	Message is a replay
KRB5_RC_IO	-1765328220L	Replay I/O operation failed
KRB5_RC_NOIO	-1765328219L	Replay cache type does not support non-volatile storage
KRB5_RC_PARSE	-1765328218L	Replay cache name parse and format error
KRB5_RC_IO_EOF	-1765328217L	End-of-file on replay cache I/O
KRB5_RC_IO_MALLOC	-1765328216L	No more memory to allocate in replay cache I/O code
KRB5_RC_IO_PERM	-1765328215L	Permission denied in replay cache code
KRB5_RC_IO_IO	-1765328214L	I/O error in replay cache i/o code
KRB5_RC_IO_UNKNOWN	-1765328213L	Generic unknown RC/IO error
KRB5_RC_IO_SPACE	-1765328212L	Insufficient system space to store replay information
KRB5_TRANS_CANTOPEN	-1765328211L	Can't open/find realm translation file
KRB5_TRANS_BADFORMAT	-1765328210L	Improper format of realm translation file
KRB5_LNAME_CANTOPEN	-1765328209L	Can't open or find lname translation database
KRB5_LNAME_NOTRANS	-1765328208L	No translation is available for requested principal
KRB5_LNAME_BADFORMAT	-1765328207L	Improper format of translation database entry
KRB5_CRYPTO_INTERNAL	-1765328206L	Cryptosystem internal error
KRB5_KT_BADNAME	-1765328205L	Key table name malformed
KRB5_KT_UNKNOWN_TYPE	-1765328204L	Unknown Key table type
KRB5_KT_NOTFOUND	-1765328203L	Key table entry not found
KRB5_KT_END	-1765328202L	End of key table reached
KRB5_KT_NOWRITE	-1765328201L	Cannot write to specified key table

Messages Returned in Kerberos v5 for Status Code 6

The following table lists the minor status messages that are returned in Kerberos v5 for status code 6.

TABLE 12 Kerberos v5 Status Codes 6

Minor Status	Value	Meaning
KRB5_KT_IOERR	-1765328200L	Error writing to key table
KRB5_NO_TKT_IN_RLM	-1765328199L	Cannot find ticket for requested realm
KRB5DES_BAD_KEYPAR	-1765328198L	DES key has bad parity
KRB5DES_WEAK_KEY	-1765328197L	DES key is a weak key
KRB5_BAD_ENCTYPE	-1765328196L	Bad encryption type
KRB5_BAD_KEYSIZE	-1765328195L	Key size is incompatible with encryption type
KRB5_BAD_MSIZ	-1765328194L	Message size is incompatible with encryption type
KRB5_CC_TYPE_EXISTS	-1765328193L	Credentials cache type is already registered
KRB5_KT_TYPE_EXISTS	-1765328192L	Key table type is already registered
KRB5_CC_IO	-1765328191L	Credentials cache I/O operation failed
KRB5_FCC_PERM	-1765328190L	Credentials cache file permissions incorrect
KRB5_FCC_NOFILE	-1765328189L	No credentials cache file found
KRB5_FCC_INTERNAL	-1765328188L	Internal file credentials cache error
KRB5_CC_WRITE	-1765328187L	Error writing to credentials cache file
KRB5_CC_NOMEM	-1765328186L	No more memory to allocate in credentials cache code
KRB5_CC_FORMAT	-1765328185L	Bad format in credentials cache
KRB5_INVALID_FLAGS	-1765328184L	Invalid KDC option combination, which is an internal library error
KRB5_NO_2ND_TKT	-1765328183L	Request missing second ticket
KRB5_NOCREDS_SUPPLIED	-1765328182L	No credentials supplied to library routine
KRB5_SENDAUTH_BADAUTHVERS	-1765328181L	Bad sendauth version was sent
KRB5_SENDAUTH_BADAPPLVERS	-1765328180L	Bad application version was sent by sendauth
KRB5_SENDAUTH_BADRESPONSE	-1765328179L	Bad response during sendauth exchange
KRB5_SENDAUTH_REJECTED	-1765328178L	Server rejected authentication during sendauth exchange

Messages Returned in Kerberos v5 for Status Code 7

The following table lists the minor status messages that are returned in Kerberos v5 for status code 7.

TABLE 13 Kerberos v5 Status Codes 7

Minor Status	Value	Meaning
KRB5_PREAUTH_BAD_TYPE	-1765328177L	Unsupported preauthentication type
KRB5_PREAUTH_NO_KEY	-1765328176L	Required preauthentication key not supplied
KRB5_PREAUTH_FAILED	-1765328175L	Generic preauthentication failure
KRB5_RCACHE_BADVNO	-1765328174L	Unsupported format version number for replay cache
KRB5_CCACHE_BADVNO	-1765328173L	Unsupported credentials cache format version number
KRB5_KEYTAB_BADVNO	-1765328172L	Unsupported version number for key table format
KRB5_PROG_ATYPE_NOSUPP	-1765328171L	Program lacks support for address type
KRB5_RC_REQUIRED	-1765328170L	Message replay detection requires rcache parameter
KRB5_ERR_BAD_HOSTNAME	-1765328169L	Host name cannot be canonicalized
KRB5_ERR_HOST_REALM_UNKNOWN	-1765328168L	Cannot determine realm for host
KRB5_SNAME_UNSUPP_NAME_TYPE	-1765328167L	Conversion to service principal is undefined for name type
KRB5KRB_AP_ERR_V4_REPLY	-1765328166L	Initial Ticket response appears to be Version 4 error
KRB5_REALM_CANT_RESOLVE	-1765328165L	Cannot resolve KDC for requested realm
KRB5_TKT_NOT_FORWARDABLE	-1765328164L	The requesting ticket cannot get forwardable tickets
KRB5_FWD_BAD_PRINCIPAL	-1765328163L	Bad principal name while trying to forward credentials
KRB5_GET_IN_TKT_LOOP	-1765328162L	Looping detected inside krb5_get_in_tkt
KRB5_CONFIG_NODEFREALM	-1765328161L	Configuration file /etc/krb5/krb5.conf does not specify default realm
KRB5_SAM_UNSUPPORTED	-1765328160L	Bad SAM flags in obtain_sam_padata
KRB5_KT_NAME_TOOLONG	-1765328159L	Keytab name too long
KRB5_KT_KVNONOTFOUND	-1765328158L	Key version number for principal in key table is incorrect
KRB5_CONF_NOT_CONFIGURED	-1765328157L	Kerberos /etc/krb5/krb5.conf configuration file not configured
ERROR_TABLE_BASE_krb5	-1765328384L	default

Specifying an OID

You should use the default QOP and mechanism provided by the GSS-API if at all possible. See [“GSS-API OIDs” on page 73](#). However, you might have your own reasons for specifying OIDs. This appendix describes how to specify OIDs.

The following topics are covered.

- [“Files with OID Values” on page 263](#)
- [“Constructing Mechanism OIDs” on page 265](#)
- [“Specifying a Non-Default Mechanism” on page 267](#)

Files with OID Values

For convenience, the GSS-API does allow mechanisms and QOPs to be displayed in human-readable form. On Oracle Solaris systems, two files, `/etc/gss/mech` and `/etc/gss/qop`, contain information about available mechanisms and available QOPs. If you do not have access to these files, then you must provide the string literals from some other source. The published Internet standard for that mechanism or QOP should serve that purpose.

`/etc/gss/mech` File

The `/etc/gss/mech` file lists the mechanisms that are available. `/etc/gss/mech` contains the names in both the numerical format and the alphabetic form. `/etc/gss/mech` presents the information in this format:

- Mechanism name, in ASCII
- Mechanism's OID
- Shared library for implementing the services that are provided by this mechanism
- Optionally, the kernel module for implementing the service

A sample `/etc/gss/mech` might look like [Example 34](#), “The `/etc/gss/mech` File,” on page 264.

EXAMPLE 34 The `/etc/gss/mech` File

```
#
# Copyright (c) 2005, 2015, Oracle and/or its affiliates. All rights reserved.
#
#ident "@(#)mech 1.12 03/10/20 SMI"
#
# This file contains the GSS-API based security mechanism names,
# the associated object identifiers (OID) and a shared library that
# implements the services for the mechanisms under GSS-API.
#
# Mechanism Name Object Identifier Shared Library Kernel Module
[Options]
#
kerberos_v5 1.2.840.113554.1.2.2 mech_krb5.so kmech_krb5
spnego 1.3.6.1.5.5.2 mech_spnego.so.1 [msinterop]
diffie_hellman_640_0 1.3.6.4.1.42.2.26.2.4 dh640-0.so.1
diffie_hellman_1024_0 1.3.6.4.1.42.2.26.2.5 dh1024-0.so.1
```

`/etc/gss/qop` File

The `/etc/gss/qop` file stores, for all mechanisms installed, all the QOPs supported by each mechanism, both as an ASCII string and as the corresponding 32-bit integer. A sample `/etc/gss/qop` might look like the following example.

EXAMPLE 35 The `/etc/gss/qop` File

```
#
# Copyright (c) 2000,2012
#
# by Oracle and/or its affiliates. All rights reserved. .
# All rights reserved.
#
#ident "@(#)qop 1.3 00/11/09 SMI"
#
# This file contains information about the GSS-API based quality of
# protection (QOP), its string name and its value (32-bit integer).
#
# QOP string QOP Value Mechanism Name
#
```

GSS_KRB5_INTEG_C_QOP_DES_MD5	0	kerberos_v5
GSS_KRB5_CONF_C_QOP_DES	0	kerberos_v5

gss_str_to_oid() Function

For backward compatibility with earlier versions of the GSS-API, this implementation of the GSS-API supports the function `gss_str_to_oid()`. `gss_str_to_oid()` converts a string that represents a mechanism or QOP to an OID. The string can be either as a number or a word.



Caution - `gss_str_to_oid()`, `gss_oid_to_str()`, and `gss_release_oid()` are not supported by some implementations of the GSS-API to discourage the use of explicit, non-default mechanisms and QOPs.

The mechanism string can be hard-coded in the application or come from user input. However, not all implementations of the GSS-API support `gss_str_to_oid()`, so applications should not rely on this function.

The number that represents a mechanism can have two different formats. The first format, { 1 2 3 4 }, is officially mandated by the GSS-API specifications. The second format, 1.2.3.4, is more widely used but is not an official standard format. `gss_str_to_oid()` expects the mechanism number in the first format, so you must convert the string if the string is in the second format before calling `gss_str_to_oid()`. An example of `gss_str_to_oid()` is shown in [Example 36, “createMechOid\(\) Function,” on page 267](#). If the mechanism is not a valid one, `gss_str_to_oid()` returns `GSS_S_BAD_MECH`.

Because `gss_str_to_oid()` allocates GSS-API data space, the `gss_release_oid()` function exists is provided to remove the allocated OID when you are finished. Like `gss_str_to_oid()`, `gss_release_oid()` is not a generally supported function and should not be relied upon in programs that aspire to universal portability.

Constructing Mechanism OIDs

Because `gss_str_to_oid()` cannot always be used, there are alternative techniques for finding and selecting mechanisms. One way is to construct a mechanism OID manually and then compare that mechanism to a set of available mechanisms. Another way is to get the set of available mechanisms and choose one from the set.

The `gss_OID` type has the following form:

```
typedef struct gss_OID_desc struct {
    OM_uint32 length;
    void      *elements;
} gss_OID_desc, *gss_OID;
```

where the *elements* field of this structure points to the first byte of an octet string containing the ASN.1 BER encoding of the value portion of the normal BER TLV encoding of the `gss_OID`. The *length* field contains the number of bytes in this value. For example, the `gss_OID` value that corresponds to the DASS X.509 authentication mechanism has a *length* field of 7 and an *elements* field that points to the following octal values: 53, 14, 2, 207, 163, 7, 5.

One way to construct a mechanism OID is to declare a `gss_OID` and then initialize the elements manually to represent a given mechanism. As above, the input for the *elements* values can be hard-coded, obtained from a table, or entered by a user. This method is somewhat more painstaking than using `gss_str_to_oid()` but achieves the same effect.

This constructed `gss_OID` can then be compared against a set of available mechanisms that have been returned by the functions `gss_indicate_mechs()` or `gss_inquire_mechs_for_name()`. The application can check for the constructed mechanism OID in this set of available mechanisms by using the `gss_test_oid_set_member()` function. If `gss_test_oid_set_member()` does not return an error, then the constructed OID can be used as the mechanism for GSS-API transactions.

As an alternative to constructing a preset OID, the application can use `gss_indicate_mechs()` or `gss_inquire_mechs_for_name()` to get the `gss_OID_set` of available mechanisms. A `gss_OID_set` has the following form:

```
typedef struct gss_OID_set_desc_struct {
    OM_uint32 length;
    void      *elements;
} gss_OID_set_desc, *gss_OID_set;
```

where each of the elements is a `gss_OID` that represents a mechanism. The application can then parse each mechanism and display the numerical representation. A user can use this display to choose the mechanism. The application then sets the mechanism to the appropriate member of the `gss_OID_set`. The application can also compare the desired mechanisms against a list of preferred mechanisms.

createMechOid() Function

This function is shown for the sake of completeness. Normally, you should use the default mechanism, which is specified by `GSS_C_NULL_OID`.

EXAMPLE 36 createMechOid() Function

```

gss_OID createMechOid(const char *mechStr)
{
    gss_buffer_desc mechDesc;
    gss_OID mechOid;
    OM_uint32 minor;

    if (mechStr == NULL)
        return (GSS_C_NULL_OID);

    mechDesc.length = strlen(mechStr);
    mechDesc.value = (void *) mechStr;

    if (gss_str_to_oid(&minor, &mechDesc, &mechOid) !
        = GSS_S_COMPLETE) {
        fprintf(stderr, "Invalid mechanism oid specified <%s>",
                mechStr);
        return (GSS_C_NULL_OID);
    }

    return (mechOid);
}

```

Specifying a Non-Default Mechanism

parse_oid() converts the name of a security mechanism on the command line to a compatible OID.

EXAMPLE 37 parse_oid() Function

```

static void parse_oid(char *mechanism, gss_OID *oid)
{
    char      *mechstr = 0, *cp;
    gss_buffer_desc tok;
    OM_uint32 maj_stat, min_stat;

    if (isdigit(mechanism[0])) {
        mechstr = malloc(strlen(mechanism)+5);
        if (!mechstr) {
            printf("Couldn't allocate mechanism scratch!\n");
            return;
        }
        sprintf(mechstr, "{ %s }", mechanism);
    }
}

```

```
        for (cp = mechstr; *cp; cp++)
            if (*cp == '.')
                *cp = ' ';
        tok.value = mechstr;
    } else
        tok.value = mechanism;
    tok.length = strlen(tok.value);
    maj_stat = gss_str_to_oid(&min_stat, &tok, oid);
    if (maj_stat != GSS_S_COMPLETE) {
        display_status("str_to_oid", maj_stat, min_stat);
        return;
    }
    if (mechstr)
        free(mechstr);
}
```

◆◆◆ APPENDIX E

Source Code for SASL Example

This appendix contains the source code for the example in “[SASL Example](#)” on page 149. The appendix includes the following topics:

- “[SASL Client Example](#)” on page 269
- “[SASL Server Example](#)” on page 279
- “[Common Code](#)” on page 289

SASL Client Example

The following code listing is for the sample client in “[SASL Example](#)” on page 149.

```
#pragma ident "@(#)client.c 1.4 03/04/07 SMI"
/* $Id: client.c,v 1.3 2002/09/03 15:11:59 rjs3 Exp $ */
/*
 * Copyright (c) 2001 Carnegie Mellon University. All rights reserved.
 *
 * Redistribution and use in source and binary forms, with or without
 * modification, are permitted provided that the following conditions
 * are met:
 *
 * 1. Redistributions of source code must retain the above copyright
 *    notice, this list of conditions and the following disclaimer.
 *
 * 2. Redistributions in binary form must reproduce the above copyright
 *    notice, this list of conditions and the following disclaimer in
 *    the documentation and/or other materials provided with the
 *    distribution.
 *
 * 3. The name "Carnegie Mellon University" must not be used to
 *    endorse or promote products derived from this software without
 *    prior written permission. For permission or any other legal
 *    details, please contact
 *       Office of Technology Transfer
```

```
*      Carnegie Mellon University
*      5000 Forbes Avenue
*      Pittsburgh, PA 15213-3890
*      (412) 268-4387, fax: (412) 268-7395
*      tech-transfer@andrew.cmu.edu
*
* 4. Redistributions of any form whatsoever must retain the following
*   acknowledgment:
*   "This product includes software developed by Computing Services
*    at Carnegie Mellon University (http://www.cmu.edu/computing/)."
*
* CARNEGIE MELLON UNIVERSITY DISCLAIMS ALL WARRANTIES WITH REGARD TO
* THIS SOFTWARE, INCLUDING ALL IMPLIED WARRANTIES OF MERCHANTABILITY
* AND FITNESS, IN NO EVENT SHALL CARNEGIE MELLON UNIVERSITY BE LIABLE
* FOR ANY SPECIAL, INDIRECT OR CONSEQUENTIAL DAMAGES OR ANY DAMAGES
* WHATSOEVER RESULTING FROM LOSS OF USE, DATA OR PROFITS, WHETHER IN
* AN ACTION OF CONTRACT, NEGLIGENCE OR OTHER TORTIOUS ACTION, ARISING
* OUT OF OR IN CONNECTION WITH THE USE OR PERFORMANCE OF THIS SOFTWARE.
*/

#include <config.h>

#include <stdio.h>
#include <stdlib.h>
#include <stdarg.h>
#include <ctype.h>
#include <errno.h>
#include <string.h>

#ifdef HAVE_UNISTD_H
#include <unistd.h>
#endif

#include <sys/socket.h>
#include <netinet/in.h>
#include <arpa/inet.h>
#include <netdb.h>
#ifdef _SUN_SDK_
#include <sysexits.h>
#endif /* _SUN_SDK_ */

#include <assert.h>

#include <sasl.h>

#include "common.h"

/* remove \r\n at end of the line */
```

```
static void chop(char *s)
{
    char *p;

    assert(s);
    p = s + strlen(s) - 1;
    if (p[0] == '\n') {
        *p-- = '\0';
    }
    if (p >= s && p[0] == '\r') {
        *p-- = '\0';
    }
}

static int getrealm(void *context __attribute__((unused)),
    int id,
    const char **availrealms,
    const char **result)
{
    static char buf[1024];

    /* Double-check the ID */
    if (id != SASL_CB_GETREALM) return SASL_BADPARAM;
    if (!result) return SASL_BADPARAM;

    printf("please choose a realm (available:");
    while (*availrealms) {
        printf(" %s", *availrealms);
        availrealms++;
    }
    printf("): ");

    fgets(buf, sizeof buf, stdin);
    chop(buf);
    *result = buf;

    return SASL_OK;
}

static int simple(void *context __attribute__((unused)),
    int id,
    const char **result,
    unsigned *len)
{
    static char buf[1024];

    /* Double-check the connection */
    if (! result)
```

```
return SASL_BADPARAM;

    switch (id) {
        case SASL_CB_USER:
printf("please enter an authorization id: ");
break;
        case SASL_CB_AUTHNAME:
printf("please enter an authentication id: ");
break;
        default:
return SASL_BADPARAM;
    }

    fgets(buf, sizeof buf, stdin);
    chop(buf);
    *result = buf;
    if (len) *len = strlen(buf);

    return SASL_OK;
}

#ifdef HAVE_GETPASSPHRASE
static char *
getpassphrase(const char *prompt)
{
    return getpass(prompt);
}
#endif /* ! HAVE_GETPASSPHRASE */

static int
getsecret(sasl_conn_t *conn,
          void *context __attribute__((unused)),
          int id,
          sasl_secret_t **psecret)
{
    char *password;
    size_t len;
    static sasl_secret_t *x;

    /* paranoia check */
    if (! conn || ! psecret || id != SASL_CB_PASS)
return SASL_BADPARAM;

    password = getpassphrase("Password: ");
    if (! password)
return SASL_FAIL;

    len = strlen(password);
```



```
x = (sasl_secret_t *) realloc(x, sizeof(sasl_secret_t) + len);

    if (!x) {
        memset(password, 0, len);
        return SASL_NOMEM;
    }

    x->len = len;
#ifdef _SUN_SDK_
    strcpy((char *)x->data, password);
#else
    strcpy(x->data, password);
#endif /* _SUN_SDK_ */
    memset(password, 0, len);

    *psecret = x;
    return SASL_OK;
}

static int getpath(void * context __attribute__((unused)),
    const char **path)
{
    *path = getenv("SASL_PATH");

    if (*path == NULL)
        *path = PLUGINDIR;

    return SASL_OK;
}

/* callbacks we support */
static sasl_callback_t callbacks[] = {
    {
        SASL_CB_GETREALM, &getrealm, NULL
    }, {
        SASL_CB_USER, &simple, NULL
    }, {
        SASL_CB_AUTHNAME, &simple, NULL
    }, {
        SASL_CB_PASS, &getsecret, NULL
    }, {
        SASL_CB_GETPATH, &getpath, NULL
    }, {
        SASL_CB_LIST_END, NULL, NULL
    }
};
```

```
int getconn(const char *host, const char *port)
{
    struct addrinfo hints, *ai, *r;
    int err, sock = -1;

    memset(&hints, 0, sizeof(hints));
    hints.ai_family = PF_UNSPEC;
    hints.ai_socktype = SOCK_STREAM;

    if ((err = getaddrinfo(host, port, &hints, &ai)) != 0) {
        fprintf(stderr, "getaddrinfo: %s\n", gai_strerror(err));
        exit(EX_UNAVAILABLE);
    }

    for (r = ai; r; r = r->ai_next) {
        sock = socket(r->ai_family, r->ai_socktype, r->ai_protocol);
        if (sock < 0)
            continue;
        if (connect(sock, r->ai_addr, r->ai_addrlen) >= 0)
            break;
        close(sock);
        sock = -1;
    }

    freeaddrinfo(ai);
    if (sock < 0) {
        perror("connect");
        exit(EX_UNAVAILABLE);
    }

    return sock;
}

char *mech;

int mysasl_negotiate(FILE *in, FILE *out, sasl_conn_t *conn)
{
    char buf[8192];
    const char *data;
    const char *chosenmech;
#ifdef _SUN_SDK_
    unsigned len;
#else
    int len;
#endif /* _SUN_SDK_ */
    int r, c;

    /* get the capability list */
}
```

```
dprintf(0, "receiving capability list... ");
len = recv_string(in, buf, sizeof buf);
dprintf(0, "%s\n", buf);

if (mech) {
/* make sure that 'mech' appears in 'buf' */
if (!strstr(buf, mech)) {
    printf("server doesn't offer mandatory mech '%s'\n", mech);
    return -1;
}
} else {
mech = buf;
}

r = sasl_client_start(conn, mech, NULL, &data, &len, &chosenmech);
if (r != SASL_OK && r != SASL_CONTINUE) {
saslerr(r, "starting SASL negotiation");
printf("\n%s\n", sasl_errdetail(conn));
return -1;
}

dprintf(1, "using mechanism %s\n", chosenmech);

/* we send up to 3 strings;
the mechanism chosen, the presence of initial response,
and optionally the initial response */
send_string(out, chosenmech, strlen(chosenmech));
if(data) {
send_string(out, "Y", 1);
send_string(out, data, len);
} else {
send_string(out, "N", 1);
}

for (;;) {
dprintf(2, "waiting for server reply...\n");

c = fgetc(in);
switch (c) {
case 'O':
    goto done_ok;

case 'N':
    goto done_no;

case 'C': /* continue authentication */
    break;
}
```

```
default:
    printf("bad protocol from server (%c %x)\n", c, c);
    return -1;
}
len = recv_string(in, buf, sizeof buf);

r = sasl_client_step(conn, buf, len, NULL, &data, &len);
if (r != SASL_OK && r != SASL_CONTINUE) {
    saslerr(r, "performing SASL negotiation");
    printf("\n%s\n", sasl_errdetail(conn));
    return -1;
}

if (data) {
    dprintf(2, "sending response length %d...\n", len);
    send_string(out, data, len);
} else {
    dprintf(2, "sending null response...\n");
    send_string(out, "", 0);
}
}

done_ok:
    printf("successful authentication\n");
    return 0;

done_no:
    printf("authentication failed\n");
    return -1;
}

#ifdef _SUN_SDK_
void usage(const char *s)
#else
void usage(void)
#endif /* _SUN_SDK_ */
{
#ifdef _SUN_SDK_
    fprintf(stderr, "usage: %s [-p port] [-s service] [-m mech] host\n", s);
#else
    fprintf(stderr, "usage: client [-p port] [-s service] \
        [-m mech] host\n");
#endif /* _SUN_SDK_ */
    exit(EX_USAGE);
}

int main(int argc, char *argv[])
{
```

```
int c;
char *host = "localhost";
char *port = "12345";
char localaddr[NI_MAXHOST + NI_MAXSERV],
remoteaddr[NI_MAXHOST + NI_MAXSERV];
char *service = "rcmd";
char hbuf[NI_MAXHOST], pbuf[NI_MAXSERV];
int r;
sasl_conn_t *conn;
FILE *in, *out;
int fd;
int salen;
struct sockaddr_storage local_ip, remote_ip;

while ((c = getopt(argc, argv, "p:s:m:")) != EOF) {
switch(c) {
case 'p':
port = optarg;
break;

case 's':
service = optarg;
break;

case 'm':
mech = optarg;
break;

default:
#ifdef _SUN_SDK_
usage(argv[0]);
#else
usage();
#endif /* _SUN_SDK_ */
break;
}
}

if (optind > argc - 1) {
#ifdef _SUN_SDK_
usage(argv[0]);
#else
usage();
#endif /* _SUN_SDK_ */
if (optind == argc - 1) {
host = argv[optind];
}
}
```

```
/* initialize the sasl library */
r = sasl_client_init(callbacks);
if (r != SASL_OK) saslfail(r, "initializing libsasl");

/* connect to remote server */
fd = getconn(host, port);

/* set ip addresses */
salen = sizeof(local_ip);
if (getsockname(fd, (struct sockaddr *)&local_ip, &salen) < 0) {
perror("getsockname");
}

getnameinfo((struct sockaddr *)&local_ip, salen,
hbuf, sizeof(hbuf), pbuf, sizeof(pbuf),
#ifdef _SUN_SDK /* SOLARIS doesn't support NI_WITHSCOPEID */
NI_NUMERICHOST | NI_NUMERICSERV);
#else
NI_NUMERICHOST | NI_WITHSCOPEID | NI_NUMERICSERV);
#endif
snprintf(localaddr, sizeof(localaddr), "%s;%s", hbuf, pbuf);

salen = sizeof(remote_ip);
if (getpeername(fd, (struct sockaddr *)&remote_ip, &salen) < 0) {
perror("getpeername");
}

getnameinfo((struct sockaddr *)&remote_ip, salen,
hbuf, sizeof(hbuf), pbuf, sizeof(pbuf),
#ifdef _SUN_SDK /* SOLARIS doesn't support NI_WITHSCOPEID */
NI_NUMERICHOST | NI_NUMERICSERV);
#else
NI_NUMERICHOST | NI_WITHSCOPEID | NI_NUMERICSERV);
#endif
snprintf(remoteaddr, sizeof(remoteaddr), "%s;%s", hbuf, pbuf);

/* client new connection */
r = sasl_client_new(service, host, localaddr, remoteaddr, NULL,
0, &conn);
if (r != SASL_OK) saslfail(r, "allocating connection state");

/* set external properties here
sasl_setprop(conn, SASL_SSF_EXTERNAL, &extprops); */

/* set required security properties here
sasl_setprop(conn, SASL_SEC_PROPS, &secprops); */
```

```

    in = fdopen(fd, "r");
    out = fdopen(fd, "w");

    r = mysasl_negotiate(in, out, conn);
    if (r == SASL_OK) {
/* send/receive data */

    }

    printf("closing connection\n");
    fclose(in);
    fclose(out);
    close(fd);
    sasl_dispose(&conn);

    sasl_done();

    return 0;
}

```

SASL Server Example

The following code listing is for the sample server in [“SASL Example” on page 149](#).

```

#pragma ident "@(#)server.c 1.3 03/04/07 SMI"
/* $Id: server.c,v 1.4 2002/10/07 05:04:05 rjs3 Exp $ */
/*
 * Copyright (c) 2001 Carnegie Mellon University. All rights reserved.
 *
 * Redistribution and use in source and binary forms, with or without
 * modification, are permitted provided that the following conditions
 * are met:
 *
 * 1. Redistributions of source code must retain the above copyright
 * notice, this list of conditions and the following disclaimer.
 *
 * 2. Redistributions in binary form must reproduce the above copyright
 * notice, this list of conditions and the following disclaimer in
 * the documentation and/or other materials provided with the
 * distribution.
 *
 * 3. The name "Carnegie Mellon University" must not be used to
 * endorse or promote products derived from this software without
 * prior written permission. For permission or any other legal

```

```
* details, please contact
* Office of Technology Transfer
* Carnegie Mellon University
* 5000 Forbes Avenue
* Pittsburgh, PA 15213-3890
* (412) 268-4387, fax: (412) 268-7395
* tech-transfer@andrew.cmu.edu
*
* 4. Redistributions of any form whatsoever must retain the following
* acknowledgment:
* "This product includes software developed by Computing Services
* at Carnegie Mellon University (http://www.cmu.edu/computing/)."
*
* CARNEGIE MELLON UNIVERSITY DISCLAIMS ALL WARRANTIES WITH REGARD TO
* THIS SOFTWARE, INCLUDING ALL IMPLIED WARRANTIES OF MERCHANTABILITY
* AND FITNESS, IN NO EVENT SHALL CARNEGIE MELLON UNIVERSITY BE LIABLE
* FOR ANY SPECIAL, INDIRECT OR CONSEQUENTIAL DAMAGES OR ANY DAMAGES
* WHATSOEVER RESULTING FROM LOSS OF USE, DATA OR PROFITS, WHETHER IN
* AN ACTION OF CONTRACT, NEGLIGENCE OR OTHER TORTIOUS ACTION, ARISING
* OUT OF OR IN CONNECTION WITH THE USE OR PERFORMANCE OF THIS SOFTWARE.
*/

#include <config.h>

#include <stdio.h>
#include <stdlib.h>
#include <stdarg.h>
#include <ctype.h>
#include <errno.h>
#include <string.h>

#ifdef HAVE_UNISTD_H
#include <unistd.h>
#endif

#include <sys/socket.h>
#include <netinet/in.h>
#include <arpa/inet.h>
#include <netdb.h>
#ifdef _SUN_SDK_
#include <sysexits.h>
#endif /* _SUN_SDK_ */

#include <sasl.h>

#include "common.h"

#if !defined(IPV6_BINDV6ONLY) && defined(IN6P_IPV6_V6ONLY)
```



```
#define IPV6_BINDV6ONLY IN6P_BINDV6ONLY
#endif
#if !defined(IPV6_V6ONLY) && defined(IPV6_BINDV6ONLY)
#define IPV6_V6ONLY IPV6_BINDV6ONLY
#endif
#ifndef IPV6_BINDV6ONLY
#undef IPV6_V6ONLY
#endif

static int getpath(void * context __attribute__((unused)),
                  const char **path)
{
    *path = getenv("SASL_PATH");

    if (*path == NULL)
        *path = PLUGINDIR;

    return SASL_OK;
}

/* callbacks we support */
static sasl_callback_t callbacks[] = {
    {
        SASL_CB_GETPATH, &getpath, NULL
    }, {
        SASL_CB_LIST_END, NULL, NULL
    }
};

/* create a socket listening on port 'port' */
/* if af is PF_UNSPEC more than one socket might be returned */
/* the returned list is dynamically allocated, so caller needs to free it */
int *listensock(const char *port, const int af)
{
    struct addrinfo hints, *ai, *r;
    int err, maxs, *sock, *socks;
    const int on = 1;

    memset(&hints, 0, sizeof(hints));
    hints.ai_flags = AI_PASSIVE;
    hints.ai_family = af;
    hints.ai_socktype = SOCK_STREAM;
    err = getaddrinfo(NULL, port, &hints, &ai);
    if (err) {
        fprintf(stderr, "%s\n", gai_strerror(err));
        exit(EX_USAGE);
    }
}
```

```
/* Count max number of sockets we can open */
for (maxs = 0, r = ai; r; r = r->ai_next, maxs++)
;
socks = malloc((maxs + 1) * sizeof(int));
if (!socks) {
fprintf(stderr, "couldn't allocate memory for sockets\n");
freeaddrinfo(ai);
exit(EX_OSERR);
}

socks[0] = 0; /* num of sockets counter at start of array */
sock = socks + 1;
for (r = ai; r; r = r->ai_next) {
fprintf(stderr, "trying %d, %d, %d\n", r->ai_family, r->ai_socktype,
r->ai_protocol);
*sock = socket(r->ai_family, r->ai_socktype, r->ai_protocol);
if (*sock < 0) {
perror("socket");
continue;
}
if (setsockopt(*sock, SOL_SOCKET, SO_REUSEADDR,
(void *) &on, sizeof(on)) < 0) {
perror("setsockopt(SO_REUSEADDR)");
close(*sock);
continue;
}
#ifdef IPV6_V6ONLY && !(defined(__FreeBSD__) && __FreeBSD__ < 3)
if (r->ai_family == AF_INET6) {
if (setsockopt(*sock, IPPROTO_IPV6, IPV6_BINDV6ONLY,
(void *) &on, sizeof(on)) < 0) {
perror("setsockopt (IPV6_BINDV6ONLY)");
close(*sock);
continue;
}
}
#endif
if (bind(*sock, r->ai_addr, r->ai_addrlen) < 0) {
perror("bind");
close(*sock);
continue;
}

if (listen(*sock, 5) < 0) {
perror("listen");
close(*sock);
continue;
}
}
```

```
socks[0]++;
sock++;
}

freeaddrinfo(ai);

if (socks[0] == 0) {
    fprintf(stderr, "Couldn't bind to any socket\n");
    free(socks);
    exit(EX_OSERR);
}

return socks;
}

#ifdef _SUN_SDK_
void usage(const char *s)
#else
void usage(void)
#endif /* _SUN_SDK_ */
{
#ifdef _SUN_SDK_
    fprintf(stderr, "usage: %s [-p port] [-s service] [-m mech]\n", s);
#else
    fprintf(stderr, "usage: server [-p port] [-s service] [-m mech]\n");
#endif /* _SUN_SDK_ */
    exit(EX_USAGE);
}

/* Globals are used here, but local variables are preferred */
char *mech;

/* do the sasl negotiation; return -1 if it fails */
int mysasl_negotiate(FILE *in, FILE *out, sasl_conn_t *conn)
{
    char buf[8192];
    char chosenmech[128];
    const char *data;
#ifdef _SUN_SDK_
    unsigned len;
#else
    int len;
#endif /* _SUN_SDK_ */
    int r = SASL_FAIL;
    const char *userid;

    /* generate the capability list */
    if (mech) {
```

```
dprintf(2, "forcing use of mechanism %s\n", mech);
data = strdup(mech);
    } else {
int count;

dprintf(1, "generating client mechanism list... ");
r = sasl_listmech(conn, NULL, NULL, " ", NULL,
    &data, &len, &count);
if (r != SASL_OK) saslfail(r, "generating mechanism list");
dprintf(1, "%d mechanisms\n", count);
    }

    /* send capability list to client */
    send_string(out, data, len);

dprintf(1, "waiting for client mechanism...\n");
len = recv_string(in, chosenmech, sizeof chosenmech);
if (len <= 0) {
printf("client didn't choose mechanism\n");
fputc('N', out); /* send NO to client */
fflush(out);
return -1;
    }

    if (mech && strcasecmp(mech, chosenmech)) {
printf("client didn't choose mandatory mechanism\n");
fputc('N', out); /* send NO to client */
fflush(out);
return -1;
    }

    len = recv_string(in, buf, sizeof(buf));
    if(len != 1) {
saslerr(r, "didn't receive first-send parameter correctly");
fputc('N', out);
fflush(out);
return -1;
    }

    if(buf[0] == 'Y') {
        /* receive initial response (if any) */
        len = recv_string(in, buf, sizeof(buf));

        /* start libsasl negotiation */
        r = sasl_server_start(conn, chosenmech, buf, len,
            &data, &len);
    } else {
r = sasl_server_start(conn, chosenmech, NULL, 0,
```

```
        &data, &len);
    }

    if (r != SASL_OK && r != SASL_CONTINUE) {
        saslerr(r, "starting SASL negotiation");
        fputc('N', out); /* send NO to client */
        fflush(out);
        return -1;
    }

    while (r == SASL_CONTINUE) {
        if (data) {
            dprintf(2, "sending response length %d...\n", len);
            fputc('C', out); /* send CONTINUE to client */
            send_string(out, data, len);
        } else {
            dprintf(2, "sending null response...\n");
            fputc('C', out); /* send CONTINUE to client */
            send_string(out, "", 0);
        }
    }

    dprintf(1, "waiting for client reply...\n");
    len = recv_string(in, buf, sizeof buf);
    if (len < 0) {
        printf("client disconnected\n");
        return -1;
    }

    r = sasl_server_step(conn, buf, len, &data, &len);
    if (r != SASL_OK && r != SASL_CONTINUE) {
        saslerr(r, "performing SASL negotiation");
        fputc('N', out); /* send NO to client */
        fflush(out);
        return -1;
    }

    if (r != SASL_OK) {
        saslerr(r, "incorrect authentication");
        fputc('N', out); /* send NO to client */
        fflush(out);
        return -1;
    }

    fputc('O', out); /* send OK to client */
    fflush(out);
    dprintf(1, "negotiation complete\n");
```

```
        r = sasl_getprop(conn, SASL_USERNAME, (const void **) &userid);
        printf("successful authentication '%s'\n", userid);

        return 0;
    }

int main(int argc, char *argv[])
{
    int c;
    char *port = "12345";
    char *service = "rcmd";
    int *l, maxfd=0;
    int r, i;
    sasl_conn_t *conn;

    while ((c = getopt(argc, argv, "p:s:m:")) != EOF) {
    switch(c) {
    case 'p':
        port = optarg;
        break;

    case 's':
        service = optarg;
        break;

    case 'm':
        mech = optarg;
        break;

    default:
#ifdef _SUN_SDK_
        usage(argv[0]);
    #else
        usage();
    #endif /* _SUN_SDK_ */
        break;
    }
    }

    /* initialize the sasl library */
    r = sasl_server_init(callbacks, "sample");
    if (r != SASL_OK) saslfail(r, "initializing libsasl");

    /* get a listening socket */
    if ((l = listensock(port, PF_UNSPEC)) == NULL) {
    saslfail(SASL_FAIL, "allocating listensock");
    }
}
```

```

    for (i = 1; i <= l[0]; i++) {
        if (l[i] > maxfd)
            maxfd = l[i];
    }

    for (;;) {
char localaddr[NI_MAXHOST | NI_MAXSERV],
        remoteaddr[NI_MAXHOST | NI_MAXSERV];
char myhostname[1024+1];
char hbuf[NI_MAXHOST], pbuf[NI_MAXSERV];
struct sockaddr_storage local_ip, remote_ip;
int salen;
int nfds, fd = -1;
FILE *in, *out;
fd_set readfds;

FD_ZERO(&readfds);
for (i = 1; i <= l[0]; i++)
    FD_SET(l[i], &readfds);

nfds = select(maxfd + 1, &readfds, 0, 0, 0);
if (nfds <= 0) {
    if (nfds < 0 && errno != EINTR)
        perror("select");
    continue;
}

    for (i = 1; i <= l[0]; i++)
        if (FD_ISSET(l[i], &readfds)) {
            fd = accept(l[i], NULL, NULL);
            break;
        }

if (fd < 0) {
    if (errno != EINTR)
        perror("accept");
    continue;
}

printf("accepted new connection\n");

/* set ip addresses */
salen = sizeof(local_ip);
if (getsockname(fd, (struct sockaddr *)&local_ip, &salen) < 0) {
    perror("getsockname");
}
getnameinfo((struct sockaddr *)&local_ip, salen,
            hbuf, sizeof(hbuf), pbuf, sizeof(pbuf),

```

```
#ifdef _SUN_SDK_ /* SOLARIS doesn't support NI_WITHSCOPEID */
    NI_NUMERICHOST | NI_NUMERICSERV);
#else
    NI_NUMERICHOST | NI_WITHSCOPEID | NI_NUMERICSERV);
#endif
snprintf(localaddr, sizeof(localaddr), "%s;%s", hbuf, pbuf);

salen = sizeof(remote_ip);
if (getpeername(fd, (struct sockaddr *)&remote_ip, &salen) < 0) {
    perror("getpeername");
}

getnameinfo((struct sockaddr *)&remote_ip, salen,
    hbuf, sizeof(hbuf), pbuf, sizeof(pbuf),
#ifdef _SUN_SDK_ /* SOLARIS doesn't support NI_WITHSCOPEID */
    NI_NUMERICHOST | NI_NUMERICSERV);
#else
    NI_NUMERICHOST | NI_WITHSCOPEID | NI_NUMERICSERV);
#endif
snprintf(remoteaddr, sizeof(remoteaddr), "%s;%s", hbuf, pbuf);

r = gethostname(myhostname, sizeof(myhostname)-1);
if(r == -1) saslfail(r, "getting hostname");

r = sasl_server_new(service, myhostname, NULL, localaddr, remoteaddr,
    NULL, 0, &conn);
if (r != SASL_OK) saslfail(r, "allocating connection state");

/* set external properties here
    sasl_setprop(conn, SASL_SSF_EXTERNAL, &extprops); */

/* set required security properties here
    sasl_setprop(conn, SASL_SEC_PROPS, &secprops); */

in = fdopen(fd, "r");
out = fdopen(fd, "w");

r = mysasl_negotiate(in, out, conn);
if (r == SASL_OK) {
    /* send/receive data */
}

printf("closing connection\n");
fclose(in);
fclose(out);
close(fd);
```



```
    sasl_dispose(&conn);
  }

  sasl_done();
}
```

Common Code

The following code sample includes listings for miscellaneous SASL functions.

```
#pragma ident "@(#)common.c 1.1 03/03/28 SMI"
/* $Id: common.c,v 1.3 2002/09/03 15:11:59 rjs3 Exp $ */
/*
 * Copyright (c) 2001 Carnegie Mellon University. All rights reserved.
 *
 * Redistribution and use in source and binary forms, with or without
 * modification, are permitted provided that the following conditions
 * are met:
 *
 * 1. Redistributions of source code must retain the above copyright
 * notice, this list of conditions and the following disclaimer.
 *
 * 2. Redistributions in binary form must reproduce the above copyright
 * notice, this list of conditions and the following disclaimer in
 * the documentation and/or other materials provided with the
 * distribution.
 *
 * 3. The name "Carnegie Mellon University" must not be used to
 * endorse or promote products derived from this software without
 * prior written permission. For permission or any other legal
 * details, please contact
 * Office of Technology Transfer
 * Carnegie Mellon University
 * 5000 Forbes Avenue
 * Pittsburgh, PA 15213-3890
 * (412) 268-4387, fax: (412) 268-7395
 * tech-transfer@andrew.cmu.edu
 *
 * 4. Redistributions of any form whatsoever must retain the following
 * acknowledgment:
 * "This product includes software developed by Computing Services
 * at Carnegie Mellon University (http://www.cmu.edu/computing/)."
 *
 * CARNEGIE MELLON UNIVERSITY DISCLAIMS ALL WARRANTIES WITH REGARD TO
 * THIS SOFTWARE, INCLUDING ALL IMPLIED WARRANTIES OF MERCHANTABILITY
```

```
* AND FITNESS, IN NO EVENT SHALL CARNEGIE MELLON UNIVERSITY BE LIABLE
* FOR ANY SPECIAL, INDIRECT OR CONSEQUENTIAL DAMAGES OR ANY DAMAGES
* WHATSOEVER RESULTING FROM LOSS OF USE, DATA OR PROFITS, WHETHER IN
* AN ACTION OF CONTRACT, NEGLIGENCE OR OTHER TORTIOUS ACTION, ARISING
* OUT OF OR IN CONNECTION WITH THE USE OR PERFORMANCE OF THIS SOFTWARE.
*/

#include <config.h>

#include <stdio.h>
#include <ctype.h>
#include <stdarg.h>
#ifdef _SUN_SDK_
#include <sysexit.h>
#endif /* _SUN_SDK_ */

#include <sas.h>

/* send/recv library for IMAP4 style literals.

   really not important; just one way of doing length coded strings */

int send_string(FILE *f, const char *s, int l)
{
    int al;

    al = fprintf(f, "%d\r\n", l);
    fwrite(s, 1, l, f);
    fflush(f);

    printf("send: %d\n", l);
    while (l--) {
        if (isprint((unsigned char) *s)) {
            printf("%c", *s);
        } else {
            printf("[%X]", (unsigned char) *s);
        }
        s++;
    }
    printf("\n");

    return al;
}

int recv_string(FILE *f, char *buf, int buflen)
{
    int c;
    int len, l;
```

```
char *s;

c = fgetc(f);
if (c != '{') return -1;

/* read length */
len = 0;
c = fgetc(f);
while (isdigit(c)) {
len = len * 10 + (c - '0');
c = fgetc(f);
}
if (c != '}') return -1;
c = fgetc(f);
if (c != '\r') return -1;
c = fgetc(f);
if (c != '\n') return -1;

/* read string */
if (buflen <= len) {
fread(buf, buflen - 1, 1, f);
buf[buflen - 1] = '\0';
/* discard oversized string */
len -= buflen - 1;
while (len--) (void)fgetc(f);

len = buflen - 1;
} else {
fread(buf, len, 1, f);
buf[len] = '\0';
}

l = len;
s = buf;
printf("recv: {%d}\n", len);
while (l--) {
if (isprint((unsigned char) *s)) {
printf("%c", *s);
} else {
printf("[%X]", (unsigned char) *s);
}
s++;
}
printf("\n");

return len;
}
```

```
int debuglevel = 0;

int dprintf(int lvl, const char *fmt, ...)
{
    va_list ap;
    int ret = 0;

    if (debuglevel >= lvl) {
        va_start(ap, fmt);
        ret = vfprintf(stdout, fmt, ap);
        va_end(ap);
    }

    return ret;
}

void saslerr(int why, const char *what)
{
    fprintf(stderr, "%s: %s", what, sasl_errstring(why, NULL, NULL));
}

void saslfail(int why, const char *what)
{
    saslerr(why, what);
    exit(EX_TEMPFAIL);
}
```

◆◆◆ **F** APPENDIX

SASL Reference Tables

This appendix provides reference information for SASL, which is an acronym for simple authentication and security layer.

SASL Interface Summaries

The following tables provide brief descriptions of some SASL interfaces.

TABLE 14 SASL Functions Common to Clients and Servers

Function	Description
<code>sasl_version</code>	Get version information for the SASL library.
<code>sasl_done</code>	Release all SASL global state.
<code>sasl_dispose</code>	Dispose of <code>sasl_conn_t</code> when connection is done.
<code>sasl_getprop</code>	Get property, for example, user name, security layer info.
<code>sasl_setprop</code>	Set a SASL property.
<code>sasl_errdetail</code>	Generate string from last error on connection.
<code>sasl_errstring</code>	Translate SASL error code to a string.
<code>sasl_encode</code>	Encode data to send using security layer.
<code>sasl_encodev</code>	Encode a block of data for transmission through the security layer. Uses <code>iovec</code> * as the input parameter.
<code>sasl_listmech</code>	Create list of available mechanisms.
<code>sasl_global_listmech</code>	Return an array of all possible mechanisms. Note that this interface is obsolete.
<code>sasl_seterror</code>	Set the error string to be returned by <code>sasl_errdetail()</code> .
<code>sasl_idle</code>	Configure <code>sasl</code> to perform calculations during an idle period or during a network round trip.
<code>sasl_decode</code>	Decode data received using security layer.

TABLE 15 Basic SASL Client_only Functions

Function	Description
sasl_client_init	Called once initially to load and initialize client plugins.
sasl_client_new	Initialize client connection. Sets up the <code>sasl_conn_t</code> context.
sasl_client_start	Select mechanism for connection.
sasl_client_step	Perform one authentication step.

TABLE 16 Basic SASL Server Functions (Clients Optional)

Function	Description
sasl_server_init	Called once initially to load and initialize server plugins.
sasl_server_new	Initialize server connection. Sets up the <code>sasl_conn_t</code> context.
sasl_server_start	Begin an authentication exchange.
sasl_server_step	Perform one authentication exchange step.
sasl_checkpass	Check a plain text passphrase.
sasl_checkapop	Check an APOP challenge/response. Uses a pseudo APOP mechanism, which is similar to a CRAM-MD5 mechanism. Optional. Note that this interface is obsolete.
sasl_user_exists	Check whether user exists.
sasl_setpass	Change a password. Optionally, add a user entry.
sasl_auxprop_request	Request auxiliary properties.
sasl_auxprop_getctx	Get auxiliary property context for connection.

TABLE 17 SASL Functions for Configuring Basic Services

Function	Description
sasl_set_alloc	Assign memory allocation functions. Note that this interface is obsolete.
sasl_set_mutex	Assign mutex functions. Note that this interface is obsolete.
sasl_client_add_plugin	Add a client plugin.
sasl_server_add_plugin	Add a server plugin.
sasl_canonuser_add_plugin	Add a user canonicalization plugin.
sasl_auxprop_add_plugin	Add an auxiliary property plugin.

TABLE 18 SASL Utility Functions

Function	Description
sasl_decode64	Use base64 to decode.
sasl_encode64	Use base64 to encode.
sasl_utf8verify	Verify that a string is valid UTF-8.
sasl_erasebuffer	Erase a security-sensitive buffer or password. Implementation might use recovery-resistant erase logic.

TABLE 19 SASL Property Functions

Function	Description
prop_clear()	Clear values and optionally requests from property context
prop_dispose()	Dispose of a property context
prop_dup()	Create new propctx which duplicates the contents of an existing propctx
prop_erase()	Erase the value of a property
prop_format()	Format the requested property names into a string
prop_get()	Return array of the propval structure from the context
prop_getnames()	Fill in an array of struct propval, given a list of property names
prop_new()	Create a property context
prop_request()	Add property names to a request
prop_set()	Add a property value to the context
prop_setvals()	Set the values for a property
sasl_auxprop_getctx()	Get auxiliary property context for connection
sasl_auxprop_request()	Request auxiliary properties

TABLE 20 Callback Data Types

Callback	Description
sasl_getopt_t	Get an option value. Used by both clients and servers.
sasl_log_t	Log message handler. Used by both clients and servers.
sasl_getpath_t	Get path to search for mechanisms. Used by both clients and servers.
sasl_verifyfile_t	Verify files for use by SASL. Used by both clients and servers.
sasl_canon_user_t	User name canonicalization function. Used by both clients and servers.
sasl_getsimple_t	Get user and language list. Used by clients only.
sasl_getsecret_t	Get authentication secret. Used by clients only.
sasl_chalprompt_t	Display challenge and prompt for response. Used by clients only.
sasl_getrealm_t	Get the authentication realm. Used by clients only.
sasl_authorize_t	Authorize policy callback. Used by servers only.
sasl_server_userdb_checkpass_t	Verify plain text password. Used by servers only.
sasl_server_userdb_setpass_t	Set plain text password. Used by servers only.

TABLE 21 SASL Include Files

Include File	Comments
sasl/saslplug.h	
sasl/sasl.h	Needed for developing plugins
sasl/saslutil.h	

Include File	Comments
sasl/prop.h	

TABLE 22 SASL Return Codes: General

Return Code	Description
SASL_BADMAC	Integrity check failed
SASL_BADVERS	Mismatch between versions of a mechanism
SASL_BADPARAM	Invalid parameter supplied
SASL_BADPROT	Bad protocol, cancel operation
SASL_BUFOVER	Overflowed buffer
SASL_CONTINUE	Another step is needed in authentication
SASL_FAIL	Generic failure
SASL_NOMECH	Mechanism not supported
SASL_NOMEM	Insufficient memory to complete operation
SASL_NOTDONE	Cannot request information until later in exchange
SASL_NOTINIT	SASL library not initialized
SASL_OK	Successful result
SASL_TRYAGAIN	Transient failure, for example, a weak key

TABLE 23 SASL Return Codes: Client-Only

Function	Description
SASL_BADSERV	Server failed mutual authentication step
SASL_INTERACT	Needs user interaction
SASL_WRONGMECH	Mechanism does not support requested feature

TABLE 24 SASL Return Codes: Server-Only

Function	Description
SASL_BADAUTH	Authentication failure
SASL_BADVERS	Version mismatch with plugin
SASL_DISABLED	Account disabled
SASL_ENCRYPT	Encryption needed to use mechanism
SASL_EXPIRED	Passphrase expired and needs to be reset
SASL_NOAUTHZ	Authorization failure
SASL_NOUSER	User not found
SASL_NOVERIFY	User exists, but without verifier
SASL_TOOWEAK	Mechanism too weak for this user
SASL_TRANS	One-time use of a plain text password enables requested mechanism for user

Function	Description
SASL_UNAVAIL	Remote authentication server unavailable

TABLE 25 SASL Return Codes – Password Operations

Function	Description
SASL_NOCHANGE	Requested change not needed
SASL_NOUSERPASS	User-supplied passwords not permitted
SASL_PWLOCK	Passphrase locked
SASL_WEAKPASS	Passphrase too weak for security policy

Security Considerations When Using C Functions

The necessary security considerations when using C library functions are outlined in the following table. Each function is classified into one of the following categories:

- UNRESTRICTED Default for all the functions.
- USE WITH CAUTION Requires special care to use securely.
- AVOID Avoid using these functions.
- UNSAFE Do not use these functions.

TABLE 26 Security Considerations When Using C Functions

Function	Format	Category	Comments	Alternative
access()	int access(const char *path, in mode)	AVOID	The information this function provides is outdated by the time you receive it. Using the access() function followed by the open() function causes a race condition that cannot be solved.	Open the file with the permissions of the intended user.
bcopy()	void bcopy(const void *s1, void *s2, size_t n) void *memcpy(void *s1, const void *s2, size_t n)	USE WITH CAUTION	Should not be used for copying strings, even though the length is known. Instead, use the strncpy() function.	NA
catopen()	nl_catd catopen(const char *name, int oflag)	USE WITH CAUTION	Libraries and programs should not call the catopen() function on user-supplied pathnames. User-supplied message catalogues can be leveraged to break privileged code easily.	NA
cftime()	int cftime(char *s, char *format, const time_t *clock)	UNSAFE	These functions do not check for bounds on the output buffer and might import the userdata through the CFTIME environment variable.	strftime(buf, sizeof (buf), fmt, &tm)

Function	Format	Category	Comments	Alternative
	int ascftime(char *s, const char *format, const struct tm *timeptr)			
chdir()	int chdir(const char *path)	USE WITH CAUTION	Prone to pathname race conditions. Do not use in multithreaded programs.	To avoid the race condition, use the fchdir() function after the directory has been opened and the properties have been checked using the fstat() function). Oracle Solaris 11 has added the POSIX 2008 *at() versions of the system calls that operate on files such as openat(), linkat(), mkdirat(), mkfifoat(), readlinkat(), and symlinkat(). These calls take the file descriptor of a directory as the first argument to use as the working directory for relative paths. These methods avoid the race condition when one thread calls chdir() while another is calling open(), unlink() and the like.
chmod()	int chmod(const char *path, mode_t mode) int fchmodat(int fd, const char *path, mode_t mode, int flag) int chown(const char *path, uid_t owner, gid_t group) int lchown(const char *path, uid_t owner, gid_t group)	AVOID	These functions operate on pathnames and are prone to race conditions. Normally, programs need not call chown() or chmod(), but honor the current UID (switch back to it before opening files) and umask. Note that chmod() always follows symbolic links.	If the attributes of a file must be changed, open the file safely and use the fchown() or the fchmod() functions on the resulting file descriptor.
chroot()	int chroot(const char *path)	USE WITH CAUTION	After the chroot() function is called, the environment in which it is called offers little protection. Programs can easily escape. Do not run privileged programs in such an environment and that you change the directory to a point below the new root after the chroot() function.	Run in a non-global zone.

Function	Format	Category	Comments	Alternative
copylist()	<pre>char *copylist(const char *filenm, off_t *szptr) DBM *dbm_open(const char *file, int open_flags, mode_t file_mode) int dbm_init(char *file)</pre>	USE WITH CAUTION	Used to open files and should only be used to open pathnames known to be safe.	NA
dlopen()	<pre>void *dlopen(const char *pathname, int mode)</pre>	USE WITH CAUTION	Parameters passed to the dlopen() function should only be unqualified pathnames which are then found using the runtime linker's path, or full pathnames not in any way derived from user input (including from argv [0]). There is no way to safely open a user-supplied shared object. The object's _init() function is executed before dlopen() returns.	NA
drand48()	<pre>double drand48(void) double erand48(unsigned short xi[3]) long lrand48(void)long mrand48(void) long jrand48(unsigned short xi[3]) long nrand48(unsigned short xi[3]) void srand48(long seedval) int rand(void) int rand_r(unsigned int *seed) void srand(unsigned int seed) long random(void)</pre>	AVOID	To generate random numbers for security or cryptography, use the getrandom() function, which is available starting with Oracle Solaris 11.3, or /dev/urandom, which is available starting with Solaris 9.	NA
dup()	<pre>int dup(int fildes) int dup2(int fildes, int fildes2)</pre>	USE WITH CAUTION	Both the dup() and the dup2() functions return file descriptors with the FD_CLOEXEC cleared and therefore they might leak when a program calls exec(). Older code	fcntl(fildes, F_DUPFD_CLOEXEC, 0)

Function	Format	Category	Comments	Alternative
			made <code>fcntl()</code> calls shortly after these functions returned to set that flag. But in multithreaded code (including programs that only run one thread themselves but may be linked with libraries that run additional threads), that leaves a window open for a race with another thread. The <code>F_DUPFD_CLOEXEC</code> and <code>F_DUP2FD_CLOEXE</code> calls to <code>fcntl</code> (available in Oracle Solaris 11 and later releases) combine the duplication and flag setting into an atomic operation so there is no race.	<code>fcntl(fildev, F_DUP2FD_CLOEXEC, fildev2)</code>
<code>execl()</code>	<pre>int execl(const char *path, const char *arg0, ..., const char *argn, NULL) int execv(const char *path, char *const argv []) int execve(const char *path, char *const argv [], char *const envp[])</pre>	USE WITH CAUTION	Make sure that the environment is sanitized and non-essential file descriptors are closed before executing a new program.	NA
<code>execvp()</code>	<pre>int execvp(const char *file, const char *argv []) int execlp(const char *file, const char *arg0, ..., const char *argn, NULL)</pre>	AVOID	Too dangerous to use in libraries or privileged commands and daemons because they find the executable by searching the directories in the <code>PATH</code> environment variable, which is under the complete control of the user. They should be avoided for most other programs.	Use the <code>execl()</code> , <code>execv()</code> , or <code>execve()</code> functions.
<code>fattach()</code>	<pre>int fattach(int filedes, const char *path)</pre>	USE WITH CAUTION	Check the file descriptor after the <code>open()</code> function (using <code>fstat()</code>), and not the pathname before the <code>open()</code> function.	NA
<code>fchmod()</code>	<pre>int fchmod(int filedes, mode_t mode) int fchown(int filedes, uid_t owner, gid_t group)</pre>	UNRESTRICTED	Preferred alternative to <code>chmod()</code> and <code>chown()</code> functions.	NA
<code>fdopen()</code>	<pre>FILE *fdopen(int filedes, const char *mode)</pre>	UNRESTRICTED	Alternative for <code>fopen()</code>	NA

Function	Format	Category	Comments	Alternative
fopen()	FILE *fopen(const char *path, const char *mode) FILE *freopen(const char *path, const char *mode, FILE *stream)	USE WITH CAUTION	It is not possible to safely create files by using fopen(). However, once a pathname is verified to exist, that is, after calling the mkstemp() function, it can be used to open those pathnames. In other cases, a safe invocation of open() followed by fdopen() should be used.	Use open() followed by fdopen(). For example: FILE *fp; int fd; fd = open(path, O_CREAT O_EXCL O_WRONLY, 0600); if (fd < 0){ } fp = fdopen(fd, "w");
fstat()	int fstat(int fildes, struct stat *buf)	UNRESTRICTED	Useful to check whether the file that is opened is the file you expected to open.	NA
ftw()	int ftw(const char *path, int (*fn)(), int depth) int nftw(const char *path, int (*fn)(), int depth, int flags)	USE WITH CAUTION	Follows symbolic links and crosses mount points.	Use nftw with the appropriate flags set (a combination of FTW_PHYS and FTW_MOUNT).
getenv()	char *getenv(const char *name)	USE WITH CAUTION	The environment is completely user-specified. If possible, avoid the use of getenv() in libraries. Strings returned by getenv() can be up to NCARGS bytes long (currently 1MB for 32-bit environments). Pathnames derived from environment variables should not be trusted. They should not be used as input for any of the *open() functions (including catopen() and dlopen()).	NA
getlogin()	char *getlogin(void)	AVOID	The value returned by getlogin() is not reliable. It is only a hint for the user name.	NA
getpass()	char *getpass(const char *prompt)	AVOID	Only the first 8 bytes of input are used. Avoid using it in new code.	Use the getpassphrase() function.
gets()	char *gets(char *s)	UNSAFE	This function does not check for bounds when storing the input. This function cannot be used securely.	Use fgets(buf, sizeof (buf), stdin) OR getline(buf, bufsz, stdin). The getline(buf, bufsz, stdin) function is new in Oracle Solaris 11.
kvm_open()	kvm_t *kvm_open (char *namelist, char *corefile, char *swapfile, int flag, char *errstr)	AVOID	Write a proper kstat or other interface if you need information from the kernel. If you accept a user-specified namelist argument, make sure you revoke privileges before using it. Otherwise, a specifically constructed	NA

Function	Format	Category	Comments	Alternative
	int nlist(const char *filename, struct nlist *nl)		namelist can be used to read random parts of the kernel, revealing possibly sensitive data.	
lstat()	int lstat(const char *path, struct stat *buf) int stat(const char *path, struct stat *buf) int fstatat(int fildes, const char *path, struct stat *buf, int flag)	USE WITH CAUTION	Do not use these functions to check for the existence or absence of a file. The lstat(), stat(), or fstatat() functions followed by open() have an inherent race condition.	If the purpose is to create the file that does not exist, use open(file, O_CREAT O_EXCL, mode) If the purpose is to read the file, open it for reading. If the purpose is to make sure the file attributes are correct before reading from it, use fd = open(file, O_RDONLY); fstat(fd, &statbuf); If the pathname can't be trusted, add O_NONBLOCK to the open flags. This prevents the application from hanging upon opening a device.
mkdir()	int mkdir(const char *path, mode_t mode) int mkdirat(int fd, const char *path, mode_t mode) int mknod(const char *path, mode_t mode, dev_t dev) int mknodat(int fd, const char *path, mode_t mode, dev_t dev)	USE WITH CAUTION	Be careful about the path used. These functions will not follow symbolic links for the last component and hence they are relatively safe.	NA
mkstemp()	int mkstemp(char *template)	UNRESTRICTED	Safe temporary file creation function.	NA
mktemp()	char *mktemp(char *template)	AVOID	Generates a temporary filename but the use of the generated pathname is not guaranteed safe because there is a race condition between the checks in mktemp() and the subsequent call to open() by the application.	Use mkstemp() to create a file and mkdtemp() to create a directory.

Function	Format	Category	Comments	Alternative
open()	<pre>int open(const char *path, int oflag, /* mode_t mode */...) int creat(const char *path, mode_t mode)</pre>	USE WITH CAUTION	<p>When opening for reading from a privileged program, make sure that you open the file as a user by dropping privileges or setting the effective UID to the real UID. Under no circumstances should programs implement their own access control based on file ownership and modes. Similarly, when creating files, do not open and then use <code>chown()</code> on the file.</p> <p>When opening for writing, the program can be tricked into opening the wrong file by following symbolic or hard links. To avoid this problem, either use the <code>O_NOFOLLOW</code> and <code>O_NOLINKS</code> flags, or use <code>O_CREAT O_EXCL</code> to ensure that a new file is created instead of opening an existing file.</p> <p>When opening a file, consider whether the file descriptor should be kept open across an <code>exec()</code> call. In Oracle Solaris 11, you can specify <code>O_CLOEXEC</code> in the open flags to atomically mark the file descriptor to be closed by <code>exec</code> system calls. In older releases, you must use the <code>fcntl()</code> function with the <code>FD_CLOEXEC</code> flag, which allows a race condition in multithreaded programs, if another thread forks and execute between the <code>open()</code> and <code>fcntl()</code> calls.</p>	NA
popen()	<pre>FILE *popen(const char *command, const char *mode) int p2open(const char *cmd, FILE *fp[2]) int system(const char *string)</pre>	AVOID	<p>These three library calls always involve the shell which involves <code>PATH</code>, <code>IFS</code>, other environment variables and interpretation of special characters. Refer <i>CERT C Coding Recommendation ENV04-C</i> for more details.</p>	Use <code>posix_spawn()</code> to execute other programs, with <code>waitpid()</code> or <code>pipe()</code> as necessary.
printf()	<pre>int printf(const char *format, ...) int vprintf(const char *format, va_list ap) int fprintf(FILE *stream, const char *format, ...)</pre>	USE WITH CAUTION	<p>At risk from user-specified format strings. If the format string comes from a message catalog, verify your <code>NLSPATH</code> manipulations and <code>catopen()</code> or <code>catget()</code> uses. The C library tries to be safe by ignoring <code>NLSPATH</code> settings for set-uid and set-gid applications.</p>	The <code>snprintf()</code> and <code>vsprintf()</code> functions return the number of characters that would have been written to the buffer if it were large enough. You cannot use this value in constructs like, <code>p += snprintf(p, lenp, "...")</code> because <code>p</code>

Function	Format	Category	Comments	Alternative
	<pre>int vfprintf(FILE *stream, const char *format, va_list ap) int snprintf(char *s, size_t n, const char *format, ...) int vsnprintf(char *s, size_t n, const char *format, va_list ap) int wprintf(const wchar_t *format, ...) int vwprintf(const wchar_t format, va_list arg) int fwprintf(FILE *stream, const wchar_t *format, ...) int vfwprintf(FILE *stream, const wchar_t *format, va_list arg) int swprintf(wchar_t *s, size_t n, const wchar_t *format, ...) int vswprintf(wchar_t *s, size_t n, const wchar_t *format, va_list arg) int asprintf(char **ret, const char *format, ...)</pre>			might point beyond p+lenp afterwards.
scanf()	<pre>int scanf(const char *format, ...) int vscanf(const char *format, va_list arg) int fscanf(FILE *stream, const char *format, ...) int vfscanf(FILE *stream, const char *format, va_list arg)</pre>	USE WITH CAUTION	When scanning strings, make sure the format specified includes maximum buffer lengths. Use scanf("%10s", p) to limit scanf() to read 10 characters at most. Note that the corresponding buffer must be at least eleven bytes to allow space for the terminating NULL character.	NA

Function	Format	Category	Comments	Alternative
	<pre>int sscanf(const char *s, const char *format, ...)</pre> <pre>int vsscanf(const char *s, const char *format, va_list arg)</pre>			
printf()	<pre>int printf(char *s, const char *fmt, ...)</pre> <pre>int vsprintf(char *s, const char *fmt, va_list ap)</pre>	AVOID	Typically cause buffer overflow. If you must use these functions, make sure that the fmt argument cannot be user-controlled and that you can trust the parameters not to overflow the destination buffer.	Use snprintf(), vsnprintf() or asprintf(). The asprintf() function is new in Oracle Solaris 11.
strcat()	<pre>char *strcat(char *s1, const char *s2)</pre> <pre>char *strcpy(char *s1, const char *s2)</pre>	AVOID	It is not possible to limit these functions to a maximum buffer size. However, you can calculate the amount of space required before calling strcat or strcpy. Use of these functions always forces reviewers to follow the logic, and prevent automated scanning of source code for vulnerabilities.	<pre>strlcat(dst, src, dstsize)</pre> <pre>strncpy(dst, src, dstsize)</pre>
strncpy()	<pre>char *strncpy(char *output, const char *input)</pre> <pre>char *strcadd(char *output, const char *input)</pre> <pre>char *streadd(char *output, const char *input)</pre> <pre>char *strecpy(char *output, const char *input, const char *exceptions)</pre> <pre>char *strtrns(const char *string, const char *old, const char *new, char *result)</pre>	USE WITH CAUTION	Similar problems as with strcpy(). See the strcpy and strncpy man pages for proper use.	NA
strlcpy()	<pre>size_t strlcpy(char *dst, const char *src, size_t dstsize)</pre> <pre>size_t strlcat(char *dst, const char *src, size_t dstsize)</pre>	UNRESTRICTED	Preferred alternative to the strcpy() and the strcat() functions. Available in Solaris 8 and later. Should be used with constant and not computed size arguments to facilitate code review.	NA

Function	Format	Category	Comments	Alternative
strncat()	char *strncat(char *s1, const char *s2, size_t n) char *strncpy(char *s1, const char *s2, size_t n)	USE WITH CAUTION	The strncpy() function is not guaranteed to null-terminate the destination buffer. The strncat() function is hard to use as it requires the proper size of the destination buffer to be calculated. The fact that the strncpy() function does not null- terminate on insufficient space, together with the side effect that it will add NULL bytes if there is space left, makes it a useful function for updating structures that reside on disk. For example, the wtmpx files, are often generated with write (fd, w, sizeof (*w));	strncpy(dst, src, dstsize) strlcat(dst, src, dstsize)
syslog()	void syslog(int priority, const char *message, ...) void vsyslog(int priority, const char *message, va_list ap)	USE WITH CAUTION	At risk from user-specified format strings. Verify your NLSPAT manipulations and catopen() or catget() uses.	NA
tempnam()	char *tempnam(const char *dir, const char *pfx) char *tmpnam(char *s) char *tmpnam_r(char *s)	AVOID	These functions are not suitable for generating unpredictable filenames. There is a race condition between the generation of the filename and its use, for example, open().	mkstem()
tmpfile()	FILE *tmpfile(void)	USE WITH CAUTION	Uses mkstemp(), so it is safe to use. However, because this function changes the umask, it is not multithread safe.	NA
truncate()	int truncate(const char *path, off_t length)	AVOID	This function is prone to pathname race conditions.	Use fttruncate() after a safe open().
umask()	mode_t umask(mode_t cmask)	USE WITH CAUTION	Should not be used in libraries or applications; the user's umask should be used. Also it is not multithread safe.	NA
utmpname()	int utmpname(const char *file) int utmpxname (const char *file)	AVOID	Use the default utmp and utmpx files.	NA
wordexp()	int wordexp(const char *restrict words, wordexp_t *restrict pwordexp, int flags)	USE WITH CAUTION	wordexp() passes the input string to a shell for expansion. Input provided by untrusted sources may attempt to use shell injection attacks to run additional commands.	If only wildcard expansion is required, use the glob() function.

Glossary

authorization	In Kerberos, the process of determining whether a principal can use a service, which objects the principal is allowed to access, and the type of access allowed for each.
consumer	An application, library, or kernel module that uses system services.
context	A state of trust between two applications. When a context has successfully been established between two peers, the context acceptor is aware that the context initiator is who it claims to be, and can verify and decrypt messages sent to it. If the context includes mutual authentication, then the initiator knows the acceptor's identity is valid and can also verify and decrypt messages from the acceptor.
credential	An information package that identifies a principal and a principal's identification. A credential specifies who the principal is and, often, what privileges the principal has. Credentials are produced by security mechanisms.
CRL	Certificate Revocation List.
exported name	A mechanism name that has been converted from the GSS-API internal-name format to the GSS-API Exported Name format by <code>gss_export_name()</code> . An exported name can be compared with names that are in non-GSS-API string format with <code>memcmp()</code> . See also mechanism name (MN) , name .
GSS-API	The Generic Security Service Application Programming Interface. A network layer providing support for various modular security services. GSS-API provides for security authentication, integrity, and confidentiality services, and allows maximum portability of applications with regard to security.
keystore	A storage system for PKI objects. The following examples are popular keystores: <ul style="list-style-type: none">■ OpenSSL stores keys and certificates on disk in files (PEM, DER, or PKCS#12 format).■ NSS is a private database that stores objects. NSS also supports PKCS#11 tokens.■ PKCS#11 storage depends on the token selected: Local files use Oracle Solaris softtoken. Smart cards, for example, use hardware tokens.

mechanism name (MN)	A special instance of a GSS-API internal-format name. A normal internal-format GSS-API name can contain several instances of a name, each in the format of an underlying mechanism. A mechanism name, however, is unique to a particular mechanism. Mechanism names are generated by <code>gss_canonicalize_name()</code> .
message	Data in the form of a <code>gss_buffer_t</code> object that is sent from one GSS-API-based application to a peer. An example of a message is "ls" sent to a remote ftp server. A message can contain more than just the user-provided data. For example, <code>gss_wrap()</code> takes an unwrapped message and produces a wrapped one to be sent. The wrapped message includes both the original message and an accompanying MIC. GSS-API-generated information that does not include a message is a <i>token</i> . See token .
message integrity code (MIC)	A cryptographic tag that is attached to transmitted data to ensure the data's validity. The recipient of the data generates another MIC and compares this MIC to the one that was sent. If the MICs are equal, the message is valid. Some MICs, such as those generated by <code>gss_get_mic()</code> , are visible to the application, while others, such as those generated by <code>gss_wrap()</code> or <code>gss_init_sec_context()</code> , are not.
message-level token	See token .
MIC	See message integrity code (MIC) .
MN	See mechanism name (MN) .
name	The name of a principal, such as <code>user@system</code> . Names in the GSS-API are handled through the <code>gss_name_t</code> structure, which is opaque to applications. See also exported name , mechanism name (MN) , name type .
name type	The particular form in which a name is given. Name types are stored as <code>gss_OID</code> types and are used to indicate the format used for a name. For example, the name <code>user@system</code> would have a name type of <code>GSS_C_NT_HOSTBASED_SERVICE</code> . See also exported name , mechanism name (MN) , name .
opaque	Applies to a piece of data whose value or format is not normally visible to functions that use it. For example, the <code>input_token</code> parameter to <code>gss_init_sec_context()</code> is opaque to the application, but significant to the GSS-API. Similarly, the <code>input_message</code> parameter to <code>gss_wrap()</code> is opaque to the GSS-API but important to the application doing the wrapping.
Quality of Protection (QOP)	A parameter used to select the cryptographic algorithms to be used in conjunction with the integrity or confidentiality service. With integrity, the QOP specifies the algorithm for producing a message integrity code (MIC). With confidentiality, the QOP specifies the algorithm for both the MIC and message encryption.

token

A data packet in the form of a GSS-API `gss_buffer_t` structure. Tokens are produced by GSS-API functions for transfer to peer applications.

Tokens come in two types. *Context-level tokens* contain information used to establish or manage a security context. For example, `gss_init_sec_context()` bundles a context initiator's credential handle, the target system's name, flags for various requested services, and possibly other items into a token to be sent to the context acceptor.

Message tokens (also known as *per-message tokens* or *message-level tokens*) contain information generated by a GSS-API function from messages to be sent to a peer application. For example, `gss_get_mic()` produces an identifying cryptographic tag for a given message and stores it in a token to be sent to a peer with the message. Technically, a token is considered to be separate from a message, which is why `gss_wrap()` is said to produce an *output_message* and not an *output_token*.

See also [message](#).

Index

A

- access control lists
 - use in GSS-API, 69
- account management
 - PAM service module, 42
- ACL *See* access control list
- acquiring context information, 89
- anonymous authentication, 85
- aslr security extension, 21
- authentication
 - GSS-API, 63
 - anonymous, 85
 - mutual, 84
 - PAM process for, 44
 - PAM service module, 42
 - SASL, 143
- authid
 - auxprop plugins, 158
 - SASL, 134
- authorizations
 - code example, 38
 - defined, 25
 - use in application development, 37
- authzid
 - auxprop plugins, 158
- auxiliary properties *See* auxprop plugins
- auxprop plugins, 158

C

- C_CloseSession() function
 - digest message example, 176
 - message signing example, 184

- random byte generation example, 191
- C_Decrypt() function, 179
- C_DecryptInit() function, 179
- C_EncryptFinal() function, 179
- C_EncryptInit() function, 179
- C_EncryptUpdate() function, 179
- C_Finalize() function
 - digest message example, 176
 - message signing example, 184
- C_GenerateKeyPair() function, 184
- C_GenerateRandom() function, 191
- C_GetAttributeValue() function, 184
- C_GetInfo() function, 169, 176
- C_GetMechanismList() function, 172
- C_GetSlotList() function, 170
 - message signing example, 184
 - random byte generation example, 191
- C_Initialize() function, 169
- C_OpenSession() function, 171
 - random byte generation example, 191
- C_SignInit() function, 184
- C_Verify() function, 184
- C_VerifyInit() function, 184
- callbacks
 - SASL, 136
 - SASL_CB_AUTHNAME, 138
 - SASL_CB_CANON_USER, 139
 - SASL_CB_ECHOPROMPT, 138
 - SASL_CB_GETCONF, 137
 - SASL_CB_GETOPT, 137
 - SASL_CB_GETPATH, 137
 - SASL_CB_GETREALM, 138

- SASL_CB_LANGUAGE, 138
- SASL_CB_LOG, 137
- SASL_CB_NOECHOPROMPT, 138
- SASL_CB_PASS, 138
- SASL_CB_PROXY_POLICY, 138
- SASL_CB_SERVER_USERDB_CHECKPASS, 138
- SASL_CB_SERVER_USERDB_SETPASS, 138
- SASL_CB_USER, 138
- SASL_CB_VERIFYFILE, 138
- canonicalization
 - SASL, 157
- Certificate Revocation List (CRL), 195
- Certificate Signing Request (CSR), 196
- channel bindings
 - GSS-API, 85, 252
- client plugins
 - SASL, 155, 158
- client_establish_context() function
 - GSS-API client example, 103
- confidentiality
 - GSS-API, 63, 89
- connect_to_server() function
 - GSS-API client example, 102, 106
- connection contexts
 - SASL, 139
- consumers
 - Cryptographic Framework, 161
 - defined, 23
- context-level tokens
 - GSS-API, 76
- contexts
 - GSS-API
 - acceptance, 82
 - acceptance example, 124
 - deletion, 97
 - establishing, 80
 - establishing example, 105
 - exporting, 87
 - getting acquisition information, 89
 - gss-client example, 113
 - import and export, 87, 130
 - introduction, 62
 - other context services, 84
 - releasing, 131
 - initiation in GSS-API, 80
 - createMechOid() function, 266
 - credentials
 - delegation, 84
 - GSS-API, 78, 255
 - acquisition, 119
 - GSS-API default, 79
 - CRL (Certificate Revocation List), 195
 - crypto pseudo device driver, 164
 - cryptoadm pseudo device driver, 164
 - cryptoadm utility, 164
 - cryptographic checksum (MIC), 90
 - Cryptographic Framework
 - architecture, 162
 - crypto pseudo device driver, 164
 - cryptoadm pseudo device driver, 164
 - cryptoadm utility, 164
 - cryptographic providers, 164
 - cryptoki library, 167
 - design requirements
 - user-level consumers, 165
 - user-level providers, 165
 - elfsign utility, 164
 - examples
 - message digest, 175
 - random byte generation, 191
 - signing and verifying messages, 183
 - symmetric encryption, 179
 - introduction, 161
 - kernel programmer interface, 164
 - libpkcs11.so, 163
 - modules verification library, 164
 - pkcs11_kernel.so, 164
 - pkcs11_softtoken.so, 164
 - pluggable interface, 163
 - role in Oracle Solaris, 20
 - scheduler / load balancer, 164, 164
 - cryptographic providers
 - Cryptographic Framework, 164
 - cryptoki library
 - overview, 167
 - CSR (Certificate Signing Request), 196

D

- data encryption
 - GSS-API, 91
- data protection
 - GSS-API, 89
- data types
 - GSS-API, 66, 249
 - integers, 66
 - names, 67
 - strings, 66
 - privileges, 30
- debugging
 - security extensions and, 23
- default credentials
 - GSS-API, 79
- delegation
 - credentials, 84
- design requirements
 - Cryptographic Framework
 - user-level consumers, 165
 - user-level providers, 165
- digesting messages
 - Cryptographic Framework, 175

E

- effective privilege set
 - defined, 28
- elfdump command, 22
- elfedit command, 22
- elfsign command
 - Cryptographic Framework, 164
- encryption
 - GSS-API, 89
 - wrapping messages with `gss_wrap()`, 91
- error codes
 - GSS-API, 246
- examples
 - checking for authorizations, 38
 - Cryptographic Framework
 - message digest, 175
 - random byte generation, 191
 - signing and verifying messages, 183

- symmetric encryption, 179
- GSS-API client application
 - description, 99
 - source code, 211
- GSS-API miscellaneous functions
 - source code, 234
- GSS-API server application
 - description, 115
 - source code, 223
- miscellaneous SASL functions, 289
- PAM consumer application, 46
- PAM conversation function, 51
- PAM service provider, 57
- privilege bracketing, 34
- SASL client application, 269
- SASL server application, 279
- exporting GSS-API contexts, 87

F

- functions *See* specific function name
 - GSS-API, 243

G

- General Security Standard Application Programming Interface *See* GSS-API
- GetMechanismInfo() function, 184
- GetRandSlot() function, 191
- GetTokenInfo() function, 191
- GSS-API
 - acquiring credentials, 119
 - anonymous authentication, 85
 - anonymous name format, 254
 - channel bindings, 85, 252
 - communication layers, 61
 - comparing names in, 69
 - confidentiality, 89
 - constructing OIDs, 265
 - context establishment example, 105
 - contexts
 - acceptance example, 124
 - deallocation, 97

- expiration, 255
- `createMechOid()` function, 266
- credentials, 78
 - expiration, 255
- data types, 66, 249
- detecting out-of-sequence problems, 93
- developing applications, 77
- displaying status codes, 248
- encryption, 89, 91
- exporting contexts, 87, 254
- files containing OID values, 263
- functions, 243
- generalized steps, 78
- `gss-client` example
 - context deletion, 113
 - contexts, 108
 - sending messages, 109
 - signature blocks, 112
- `gss-server` example
 - signing messages, 129
 - unwrapping messages, 129
- `gss_str_to_oid()` function, 265
- include files, 78
- integrity, 89
- interprocess tokens, 254
- introduction, 61
- Kerberos v5 status codes, 256
- language bindings, 65
- limitations, 65
- `mech` file, 263
- message transmission, 94
- MICs, 89
- minor-status codes, 255
- miscellaneous sample functions
 - source code, 234
- mutual authentication, 84
- name types, 74, 251
- OIDs, 73
- other context services, 84
- outside references, 65
- portability, 63
- protecting channel-binding information, 254
- QOP, 63, 264
- readable name syntax, 253
- releasing contexts, 131
- releasing stored data, 254
- remote procedure calls, 64
- replaced functions, 245
- role in Oracle Solaris OS, 24
- sample client application
 - description, 99
 - source code, 211
- sample server application
 - description, 115
 - source code, 223
- specifying non-default mechanisms, 267
- specifying OIDs, 263
- status code macros, 249
- status codes, 74, 246, 246
- supported credentials, 255
- tokens, 75
 - context-level, 76
 - interprocess, 77
 - per-message, 76
- translation into GSS-API format, 104
- wrap-size limits, 255
- `gss-client` example
 - context deletion, 113
 - obtaining context status, 108
 - restoring contexts, 108
 - saving contexts, 108
 - sending messages, 109
 - signature blocks, 112
- `gss-client` sample application, 99
- `gss-server` example
 - signing messages, 129
 - unwrapping messages, 129
- `gss-server` sample application, 115
- `gss_accept_sec_context()` function, 82, 244
 - GSS-API server example, 128
- `gss_acquire_cred()` function, 79, 243
 - GSS-API server example, 119
- `gss_add_cred()` function, 79, 243
- `gss_add_oid_set_member()` function, 245
- `gss_buffer_desc` structure, 66, 250
- `gss_buffer_t` pointer, 66

- GSS_C_ACCEPT credential, 79
 - GSS_C_BOTH credential, 79
 - GSS_C_INITIATE credential, 79
 - GSS_CALLING_ERROR macro, 75, 249
 - gss_canonicalize_name() function, 68, 244
 - gss_channel_bindings_structure structure, 251
 - gss_channel_bindings_t data type, 86
 - gss_compare_name() function, 69, 71, 244
 - gss_context_time() function, 244
 - gss_create_empty_oid_set() function, 245
 - gss_delete_oid() function, 245
 - gss_delete_sec_context() function, 97, 244
 - releasing contexts, 254
 - gss_display_name() function, 68, 244
 - gss_display_status() function, 245, 248
 - gss_duplicate_name() function, 245
 - gss_export_context() function, 77
 - gss_export_name() function, 245
 - gss_export_sec_context() function, 87, 244
 - gss_get_mic() function, 89, 90, 244
 - comparison with gss_wrap() function, 89
 - GSS-API server example, 129
 - gss_import_name() function, 67, 244
 - GSS-API client example, 104
 - GSS-API server example, 119
 - gss_import_sec_context() function, 87, 244
 - gss_indicate_mechs() function, 245
 - gss_init_sec_context() function, 80, 84, 244
 - GSS-API client example, 105
 - use in anonymous authentication, 85
 - use in mutual authentication, 84
 - gss_inquire_context function, 89, 244
 - gss_inquire_cred() function, 243
 - gss_inquire_cred_by_mech() function, 243
 - gss_inquire_mechs_for_name() function, 244
 - gss_inquire_names_for_mech() function, 244
 - gss_OID pointer, 73
 - gss_OID_desc structure, 250
 - gss_OID_set pointer, 73
 - gss_OID_set_desc structure, 73, 250
 - gss_oid_to_str() function, 245
 - gss_process_context_token() function, 244
 - gss_release_buffer() function, 97, 245
 - gss_release_cred() function, 97, 243
 - GSS-API server example, 131
 - gss_release_name() function, 97, 244
 - releasing stored data, 254
 - gss_release_oid() function
 - GSS-API client example, 101
 - GSS-API server example, 119
 - gss_release_oid_set() function, 97, 245
 - GSS_ROUTINE_ERROR macro, 75, 249
 - gss_seal() function, 246
 - gss_sign() function, 246
 - gss_str_to_oid() function, 245, 265
 - GSS_SUPPLEMENTARY_INFO macro, 75, 249
 - gss_test_oid_set_member() function, 245
 - gss_unseal() function, 246
 - gss_unwrap() function, 244
 - GSS-API server example, 129
 - gss_verify() function, 246
 - gss_verify_mic() function, 244
 - gss_wrap() function, 89, 91, 244
 - comparison with gss_get_mic() function, 89
 - wrapping messages, 91
 - gss_wrap_size_limit() function, 91, 244
 - gssapi.h file, 78
 - guidelines for privileged applications, 36
- H**
- header files
 - GSS-API, 78
- I**
- importing GSS-API contexts, 87
 - inetd
 - checking for in gss-client() example, 122
 - inheritable privilege set
 - defined, 27
 - integers
 - GSS-API, 66

integrity
 GSS-API, 63, 89
interprocess tokens
 GSS-API, 77
IPC privileges, 29

J

Java API, 20

K

Kerberos v5
 GSS-API, 64
key management, 20
Key Management Framework (KMF), 195
keypair, 198
keystore, 195
KMF (Key Management Framework), 195
kmfcfg(1) configuration utility, 197

L

language bindings
 GSS-API, 65
libpam, 43
libpkcs11.so library
 Cryptographic Framework, 163
libsasl
 initialization, 141
 use of API, 136
libsasl library, 133
limit privilege set
 defined, 27

M

macros
 GSS-API
 GSS_CALLING_ERROR, 75
 GSS_ROUTINE_ERROR, 75
 GSS_SUPPLEMENTARY_INFO, 75

major status codes
 GSS-API, 74
 descriptions, 246
major-status codes
 GSS-API
 encoding, 246
mech file, 263
Mechanism Name (MN), 69
mechanisms
 Cryptographic Framework, 161
 defined, 23
 GSS-API, 64
 printable formats, 265
 SASL, 135
 specifying GSS-API, 74
memcmp function, 71
message digesting
 Cryptographic Framework, 175
Message Integrity Code *See* MICs
messages, 76
 See also data
 encrypting with `gss_wrap()`, 91
 GSS-API, 76
 out-of-sequence problems, 93
 sending, 109
 signing, 129
 transmission confirmation, 94
 unwrapping, 129
 tagging with MICs, 90
 wrapping in GSS-API, 91
metaslot
 Cryptographic Framework, 162
MICs
 defined, 89
 GSS-API
 tagging messages, 90
 message transmission confirmation, 94
minor status codes
 GSS-API, 75
MN *See* Mechanism Name
mutual authentication
 GSS-API, 84

N

name types

GSS-API, 251

names

comparing in GSS-API, 69

GSS-API, 67

types in GSS-API, 74

network security

overview, 23

nxheap security extension, 21

nxstack security extension, 21

O

Object Identifiers *See* OIDs

OCSP (Online Certificate Status Protocol), 195

OIDs

constructing, 265

deallocation of, 73

GSS-API, 73

sets, 73

specifying, 73, 263

types of data stored as, 73

Online Certificate Status Protocol (OCSP), 195

Oracle Solaris Cryptographic Framework *See*

Cryptographic Framework

Oracle Solaris Enterprise Authentication Mechanism

See SEAM

out-of-sequence problems

GSS-API, 93

P

PAM, 41

authentication process, 44

consumer application example, 46

framework, 41

items, 44

library, 43

requirements for PAM consumers, 44

role in Oracle Solaris OS, 24

service modules, 42

service provider example, 57

service provider requirements, 56

writing conversation functions, 51

pam.conf file *See* PAM configuration file

pam_end() function, 44

pam_getenvlist() function, 51

pam_open_session() function, 51

pam_set_item() function, 45

pam_setcred() function, 47

pam_start() function, 44

parse_oid() function, 267

GSS-API client example, 101

per-message tokens

GSS-API, 76

permitted privilege set

defined, 27

PKCS #11

C_GetInfo() function, 169

C_GetMechanismList() function, 172

C_GetSlotList() function, 170

C_GetTokenInfo() function, 170

C_Initialize() function, 169

C_OpenSession() function, 171

function list, 168

pkcs11_softtoken.so module, 167

SUNW_C_GetMechSession() function, 174, 175

pkcs11_kernel.so library

Cryptographic Framework, 164

pkcs11_softtoken.so library

Cryptographic Framework, 164

PKI (Public Key Infrastructure), 195

pktool(1) key management tool, 196

pluggable authentication module *See* PAM

pluggable interface

Cryptographic Framework, 163

plugins

Cryptographic Framework, 161

SASL, 152

principals

GSS-API, 67

PRIV_FILE_LINK_ANY, 29

PRIV_OFF flag, 30

PRIV_ON flag, 30

- PRIV_PROC_EXEC privilege, 29
- PRIV_PROC_FORK privilege, 29
- PRIV_PROC_INFO privilege, 29
- PRIV_PROC_SESSION privilege, 29
- PRIV_SET flag, 30
- priv_set_t structure, 30
- priv_str_to_set() function
 - synopsis, 32
- priv_t type, 30
- privilege sets
 - defined, 26
- privileged applications
 - defined, 25
- privileges
 - assignment, 26
 - bracketing in the least privilege model, 34
 - bracketing in the superuser model, 33
 - categories, 28
 - IPC, 29
 - process, 29
 - system, 29
 - System V IPC, 29
 - code example, 34
 - compatibility with superuser, 28
 - data types, 30
 - defined, 25
 - interfaces, 30
 - introduction, 19
 - operation flags, 30
 - overview, 26
 - priv_str_to_set() function, 32
 - privilege ID data type, 30
 - required header file, 30
 - setppriv() function, 31
 - use in application development, 36
- process privileges, 29 *See* privileges
- protecting data
 - GSS-API, 89
- providers
 - Cryptographic Framework, 161, 164
 - defined, 23
- Public Key Infrastructure (PKI), 195

Q

- qop file, 264
- QOPs, 63
 - role in wrap size, 91
 - specifying, 74, 263
 - storage in OIDs, 73
- Quality of Protection *See* QOP

R

- random byte generation
 - Cryptographic Framework
 - example, 191
- remote procedure calls
 - GSS-API, 64
- return codes
 - GSS-API, 74
- RPCSEC_GSS, 64

S

- SASL
 - architecture, 134
 - authentication, 143
 - authid, 134
 - auxprop plugins, 158
 - callbacks
 - SASL_CB_AUTHNAME, 138
 - SASL_CB_CANON_USER, 139
 - SASL_CB_ECHOPROMPT, 138
 - SASL_CB_GETCONF, 137
 - SASL_CB_GETOPT, 137
 - SASL_CB_GETPATH, 137
 - SASL_CB_GETREALM, 138
 - SASL_CB_LANGUAGE, 138
 - SASL_CB_LOG, 137
 - SASL_CB_NOECHOPROMPT, 138
 - SASL_CB_PASS, 138
 - SASL_CB_PROXY_POLICY, 138
 - SASL_CB_SERVER_USERDB_CHECKPASS, 138
 - SASL_CB_SERVER_USERDB_SETPASS, 138
 - SASL_CB_USER, 138

- SASL_CB_VERIFYFILE, 138
- canonicalization, 157
- client sample application, 269
- confidentiality, 148
- connection contexts, 139
- functions, 293
- integrity, 148
- library, 133
- libsasl API, 136
- libsasl initialization, 141
- life cycle, 139
- mechanisms, 135
- overview, 133
- plugin design, 158
 - client plugins, 155
 - overview, 152
 - server plugins, 156
 - structures, 154
- reference tables, 293
- releasing resources, 148
- releasing sessions, 148
- role in Oracle Solaris OS, 24
- sample functions, 289
- sample output, 149
- server sample application, 279
- session initialization, 141
- setting SSF, 141
- SPI, 152
- SSF, 136
- userid, 134
- sasl_canonuser_plug_nit() function, 157
- SASL_CB_AUTHNAME callback, 138
- SASL_CB_CANON_USER callback, 139
- SASL_CB_ECHOPROMPT callback, 138
- SASL_CB_GETCONF callback, 137
- SASL_CB_GETOPT callback, 137
- SASL_CB_GETPATH callback, 137
- SASL_CB_GETREALM callback, 138
- SASL_CB_LANGUAGE callback, 138
- SASL_CB_LOG callback, 137
- SASL_CB_NOECHOPROMPT callback, 138
- SASL_CB_PASS callback, 138
- SASL_CB_PROXY_POLICY callback, 138
- SASL_CB_SERVER_USERDB_CHECKPASS callback, 138
- SASL_CB_SERVER_USERDB_SETPASS callback, 138
- SASL_CB_USER callback, 138
- SASL_CB_VERIFYFILE callback, 138
- sasl_client_add_plugin() function, 152
- sasl_client_init() function, 141, 153
- sasl_client_new() function
 - SASL life cycle, 141
- sasl_client_start() function
 - SASL life cycle, 143
- SASL_CONTINUE flag, 143
- sasl_decode() function, 148
- sasl_dispose() function, 148, 148
- sasl_done() function, 148, 148
- sasl_encode() function, 148
- sasl_getprop() function
 - checking SSF, 148
- SASL_INTERACT flag, 143
- SASL_OK flag, 143
- sasl_server_add_plugin() function, 152
- sasl_server_init() function, 141, 153
- sasl_server_new() function
 - SASL life cycle, 141
- sasl_server_start() function
 - SASL life cycle, 143
- SEAM
 - GSS-API, 64
- security context *See* contexts
- security extensions
 - kernel, 21
- security mechanisms *See* GSS-API
- security policy
 - privileged application guidelines, 36
- security strength factor *See* SSF
- send_token() function
 - GSS-API client example, 106
- sequence problems
 - GSS-API, 93
- server plugins
 - SASL, 156
- server_acquire_creds() function

- GSS-API server example, 119
- server_establish_context() function
 - GSS-API server example, 124
- service provider interface *See* SPI
- session management
 - PAM service module, 42
- session objects
 - Cryptographic Framework, 162
- setppriv() function
 - synopsis, 31
- shell escapes
 - and privileges, 37
- sign_server() function
 - GSS-API client example, 116
 - GSS-API server example, 122
- signature blocks
 - GSS-API
 - gss-client example, 112
- signing messages
 - GSS-API, 129
- signing messages example
 - Cryptographic Framework, 183
- Simple Authentication and Security Layer *See* SASL
- slots
 - Cryptographic Framework, 161
- soft tokens
 - Cryptographic Framework, 161
- specifying a QOP, 263
- specifying mechanisms in GSS-API, 263
- specifying OIDs, 263
- SPI
 - Cryptographic Framework
 - user level, 163
- SSF
 - defined, 136
 - setting, 141, 143
- status codes
 - GSS-API, 74, 246
 - major, 74
 - minor, 75
- strings
 - GSS-API, 66
- SUNW_C_GetMechSession() function, 174, 175

- digest message example, 176
- symmetric encryption example, 179
- sxadm command, 21
- symmetric encryption
 - Cryptographic Framework
 - example, 179
- system privileges, 29
- System V IPC privileges, 29

T

- test_import_export_context() function
 - GSS-API server example, 130
- token objects
 - Cryptographic Framework, 162
- tokens
 - Cryptographic Framework, 161
 - distinguishing GSS-API types, 76
 - GSS-API, 75
 - context-level, 76
 - interprocess, 77
 - per-message, 76

U

- userid
 - SASL, 134

V

- verifying messages example
 - Cryptographic Framework
 - example, 183

W

- wrapping messages
 - GSS-API, 91